

Title 12 WAC

AERONAUTICS COMMISSION

Chapters

- 12-04** **General organization and public disclosure.**
- 12-08** **Practice and procedure.**
- 12-10** **Guidelines interpreting and implementing
 the State Environmental Policy Act.**
- 12-18** **Pilot registration.**
- 12-19** **Aircraft--Indicia of registration.**
- 12-20** **Commercial airports.**
- 12-24** **Obstruction marking and lighting.**
- 12-40** **State airport rules.**

066 (Order 102), filed 12/17/85. Statutory Authority: RCW 47.68.210.
12-16-050 Display of indicia of registration. [Regulation 5 (part), filed 7/20/61.] Repealed by 86-01-066 (Order 102), filed 12/17/85. Statutory Authority: RCW 47.68.210.

Chapter 12-28

SPRAYING AND DUSTING BY AIRCRAFT

- 12-28-001 Promulgation. [Regulation 2, Promulgation, filed 7/20/61.] Repealed by 83-01-039 (Order 75), filed 12/13/82. Statutory Authority: RCW 47.01.101(5) and 47.68.210.
- 12-28-010 General. [Regulation 2, Sec. I, filed 7/20/61.] Repealed by 83-01-039 (Order 75), filed 12/13/82. Statutory Authority: RCW 47.01.101(5) and 47.68.210.
- 12-28-020 Pilots and operation of aircraft. [Regulation 2, Sec. II, filed 7/20/61.] Repealed by 83-01-039 (Order 75), filed 12/13/82. Statutory Authority: RCW 47.01.101(5) and 47.68.210.
- 12-28-030 Restrictions as to chemical application. [Regulation 2, Sec. III, filed 7/20/61.] Repealed by 83-01-039 (Order 75), filed 12/13/82. Statutory Authority: RCW 47.01.101(5) and 47.68.210.
- 12-28-040 Violations and penalties. [Regulation 2, Sec. IV, filed 7/20/61.] Repealed by 83-01-039 (Order 75), filed 12/13/82. Statutory Authority: RCW 47.01.101(5) and 47.68.210.
- 12-28-050 Persons excepted from rules. [Regulation 2, Sec. V, filed 7/20/61.] Repealed by 83-01-039 (Order 75), filed 12/13/82. Statutory Authority: RCW 47.01.101(5) and 47.68.210.
- 12-28-060 Severability. [Regulation 2, filed 7/20/61.] Repealed by 83-01-039 (Order 75), filed 12/13/82. Statutory Authority: RCW 47.01.101(5) and 47.68.210.

Chapter 12-32

OPERATING RULES FOR SPECIFIC AREAS

- 12-32-001 Lake Washington and Lake Washington Ship Canal—Promulgation. [Regulation 1, Promulgation, filed 7/20/61.] Repealed by 83-01-039 (Order 75), filed 12/13/82. Statutory Authority: RCW 47.01.101(5) and 47.68.210.
- 12-32-010 Lake Washington and Lake Washington Ship Canal—Flight and operation rules. [Regulation 1, Flight Rules, filed 7/20/61.] Repealed by 83-01-039 (Order 75), filed 12/13/82. Statutory Authority: RCW 47.01.101(5) and 47.68.210.

Chapter 12-36

SPECIFICATIONS FOR DOWNED AIRCRAFT RESCUE TRANSMITTERS

- 12-36-001 Promulgation. [Order 69-1, § 12-36-001, filed 11/14/69, effective 1/1/70.] Repealed by 83-01-039 (Order 75), filed 12/13/82. Statutory Authority: RCW 47.01.101(5) and 47.68.210.
- 12-36-010 Operation. [Order 69-1, § 12-36-010, filed 11/14/69, effective 1/1/70.] Repealed by 83-01-039 (Order 75), filed 12/13/82. Statutory Authority: RCW 47.01.101(5) and 47.68.210.
- 12-36-020 Device quality. [Order 70-3, § 12-36-020, filed 8/17/70; Order 69-1, § 12-36-020, filed 11/14/69, effective 1/1/70.] Repealed by 83-01-039 (Order

DISPOSITION OF CHAPTERS FORMERLY CODIFIED IN THIS TITLE

Chapter 12-12

USE OF AIRSPACE WITHOUT PILOTS

- 12-12-001 Promulgation. [Regulation 4 (part), Promulgation, filed 2/17/64; Regulation 4 (part), filed 7/20/61.] Repealed by 83-01-039 (Order 75), filed 12/13/82. Statutory Authority: RCW 47.01.101(5) and 47.68.210.
- 12-12-010 Permits required. [Regulation 4 (part), filed 2/17/64; Regulation 4 (part), filed 7/20/61.] Repealed by 83-01-039 (Order 75), filed 12/13/82. Statutory Authority: RCW 47.01.101(5) and 47.68.210.
- 12-12-020 Exceptions. [Regulation 4 (part), filed 2/17/64; Regulation 4 (part), filed 7/20/61.] Repealed by 83-01-039 (Order 75), filed 12/13/82. Statutory Authority: RCW 47.01.101(5) and 47.68.210.
- 12-12-030 Construction of order. [Regulation 4 (part), filed 2/17/64; Regulation 4 (part), filed 7/20/61.] Repealed by 83-01-039 (Order 75), filed 12/13/82. Statutory Authority: RCW 47.01.101(5) and 47.68.210.
- 12-12-040 Adoption of rules and regulations of Washington state fire marshal relating to model and experimental rocketry. [Regulation 4 (addendum), filed 2/17/64.] Repealed by 83-01-039 (Order 75), filed 12/13/82. Statutory Authority: RCW 47.01.101(5) and 47.68.210.
- 12-12-101 Promulgation. [Regulation 7, Promulgation, filed 7/20/61.] Repealed by 83-01-039 (Order 75), filed 12/13/82. Statutory Authority: RCW 47.01.101(5) and 47.68.210.
- 12-12-110 Where permits required. [Regulation 7 (part), filed 7/20/61.] Repealed by 83-01-039 (Order 75), filed 12/13/82. Statutory Authority: RCW 47.01.101(5) and 47.68.210.
- 12-12-150 Voluntary parachuting. [Regulation 8, filed 4/4/62.] Repealed by 83-01-039 (Order 75), filed 12/13/82. Statutory Authority: RCW 47.01.101(5) and 47.68.210.

Chapter 12-16

REGISTRATION AND INDICIA OF REGISTRATION

- 12-16-001 Promulgation. [Regulation 6, Promulgation, filed 7/20/61.] Repealed by 86-01-066 (Order 102), filed 12/17/85. Statutory Authority: RCW 47.68.210.
- 12-16-002 Promulgation. [Regulation 5, Promulgation, filed 7/20/61.] Repealed by 86-01-066 (Order 102), filed 12/17/85. Statutory Authority: RCW 47.68.210.
- 12-16-030 Notifying commission of sale or conveyance. [Regulation 6, filed 7/20/61.] Repealed by 86-01-

- 75), filed 12/13/82. Statutory Authority: RCW 47.01.101(5) and 47.68.210.
- 12-36-030 Transmission capabilities. [Order 69-1, § 12-36-030, filed 11/14/69, effective 1/1/70.] Repealed by 83-01-039 (Order 75), filed 12/13/82. Statutory Authority: RCW 47.01.101(5) and 47.68.210.
- 12-36-040 Dual frequency requirement. [Order 69-1, § 12-36-040, filed 11/14/69, effective 1/1/70.] Repealed by 83-01-039 (Order 75), filed 12/13/82. Statutory Authority: RCW 47.01.101(5) and 47.68.210.

Chapter 12-04 WAC
GENERAL ORGANIZATION AND PUBLIC
DISCLOSURE

WAC	
12-04-010	Purpose.
12-04-020	Definitions.
12-04-030	Public records available.
12-04-040	Membership, officers, quorum, director, administrative offices, function.
12-04-050	Meetings.
12-04-060	Public records officer.
12-04-070	Office hours.
12-04-080	Requests for public records.
12-04-090	Copying.
12-04-100	Exemptions.
12-04-110	Review of denials of public records requests.
12-04-120	Protection of public records.
12-04-130	Records index.
12-04-140	Communications.
12-04-150	Adoption of form.

WAC 12-04-010 Purpose. The purpose of this chapter shall be to ensure compliance by the aeronautics commission with the provisions of chapter 1, Laws of 1973 (Initiative 276) [chapter 42.17 RCW], Disclosure—Campaign finances—Lobbying—Records; and in particular with RCW 42.17.250 through 42.17.320, dealing with public records.

[Order 76-1, § 12-04-010, filed 4/29/76.]

WAC 12-04-020 Definitions. (1) "Public record" includes any writing containing information relating to the conduct of governmental or the performance of any governmental or proprietary function prepared, owned, used or retained by any state or local agency regardless of physical form or characteristics.

(2) "Writing" means handwriting, typewriting, printing, photostating, photographing, and every other means of recording any form of communication or representation, including letters, words, pictures, sounds; or symbols, or combination thereof, and all papers, maps, magnetic or paper tapes, photographic films and prints, magnetic or punched cards, discs, drums and other documents.

(3) The aeronautics commission is the commission appointed by the governor pursuant to section 1, chapter 252, Laws of 1945, as amended by section 1, chapter 68, Laws of 1967 [chapter 14.04 RCW]. The aeronautics commission shall hereinafter be referred to as the commission. Where appropriate, the term commission also refers to the staff and employees of the commission.

[Order 76-1, § 12-04-020, filed 4/29/76.]

WAC 12-04-030 Public records available. All public records of the commission, as defined in WAC 12-04-020, are deemed to be available for public inspection and copying pursuant to these rules, except as otherwise provided by RCW 42.17.310 and these rules.

[Order 76-1, § 12-04-030, filed 4/29/76.]

WAC 12-04-040 Membership, officers, quorum, director, administrative offices, function. (1) **Members.** The aeronautics commission shall consist of one member from each congressional district, who shall be appointed by the governor, by and with the advice and consent of the senate. The successors of the members initially appointed shall be appointed for terms of five years except that any person appointed to fill a vacancy occurring prior to the expiration of any term shall be appointed only for the remainder of such term. Each member shall serve until the appointment and qualification of his successor. No more than a simple majority of the members shall be appointed from the same political party. All members of the commission shall be citizens and bona fide residents of the state. No more than three members shall have any direct or indirect financial or pecuniary interest in civil aviation.

(2) **Officers, quorum.** The commission shall annually elect from among its members a chairman, vice-chairman and secretary. Four members shall constitute a quorum, and no action shall be taken by less than a majority of the commission.

(3) **Director.** A director of aeronautics shall be appointed by the commission and shall serve at the pleasure of the commission. He shall be appointed with due regard to his fitness, by aeronautical education and by knowledge of and recent practical experience in aeronautics, for the efficient dispatch of the powers and duties duly invested in and imposed upon him. He shall devote his entire time to the duties of his office and perform such services as the commission shall authorize and direct, and not be actively engaged or employed in any other business, vocation, or employment nor shall he have any pecuniary interest in or any stock in or bonds of any civil aeronautics enterprise.

He shall be the executive officer of the commission and under its supervision shall administer the provisions of the Aeronautics Commission Act, chapter 14.04 RCW, and the rules, regulations and orders established thereunder and all other laws of the state relative to aeronautics. He shall attend, but not vote at, all meetings of the commission. He shall be in charge of the offices of the commission and responsible to the commission for the preparation of reports and the collection and dissemination of data and other public information relating to aeronautics. At the direction of the commission, he shall, together with the chairman of the commission, execute all contracts entered into by the commission.

The director shall appoint, in accordance with chapter 41.06 RCW subject to the approval of the commission such experts, field and office assistants, clerks, and other employees as may be required and authorized for the

proper discharge of the functions of the commission and for whose services funds have been appropriated.

The commission may, by written order filed in its office, delegate to the director any of the powers or duties vested in or imposed upon it by the Aeronautics Commission Act, chapter 14.04 RCW. Such delegated powers and duties may be exercised by the director in the name of the commission.

(4) **Administrative offices.** The administrative offices of the commission and its staff shall be located at 8600 Perimeter Road, Boeing Field, Seattle, Washington 98108. The commission has no established field organization and all available records relating to commission functions shall be at the foregoing address.

(5) **Function.** The commission shall have general supervision over aeronautics within this state. It is empowered and directed to encourage, foster, and assist in the development of aeronautics in this state and to encourage the establishment of airports and air navigation facilities. It shall cooperate with and assist the federal government, the municipalities of this state, and other persons in the development of aeronautics, and shall seek to coordinate the aeronautical activities of these bodies and persons. Municipalities are authorized to cooperate with the commission in the development of aeronautics and aeronautical facilities in this state.

[Order 76-1, § 12-04-040, filed 4/29/76.]

WAC 12-04-050 Meetings. (1) **Regular meetings.** Pursuant to section 7, chapter 250, Laws of 1971 ex. sess. and RCW 42.30.070, regular meetings of the aeronautics commission shall be held on the second Friday of each calendar month. Said meetings will begin with informal discussions at 8:00 a.m., followed by the formal meeting commencing at 9:30 a.m. Said meetings shall be at the specific location as determined by the commission and such specific location for any particular meeting may be obtained by contacting the commission's administrative office.

(2) **Special meetings.**

(a) A special meeting may be called at any time by the chairman or by a majority of the members. Said meeting shall be called by delivering personally or by mail written notice to each member of the commission; and to each local newspaper of general circulation and to each local radio or television station which has on file with the commission a written request to be notified of such special meeting or of all special meetings. Such notice must be delivered personally or by mail at least twenty-four hours before the time of such meeting as specified in the notice. The call and notice shall specify the time and place of the special meeting and the business to be transacted. Final disposition shall not be taken on any other matter at such meetings by the commission. Such written notice may be dispensed with as to any member who at or prior to the time the meeting convenes files with the commission a written waiver of notice. Such waiver may be given by telegram. Such written notice may also be dispensed with as to any member who is actually present at the meeting at the time it convenes. The notices provided in this section

may be dispensed with in the event a special meeting is called to deal with an emergency involving injury or damage to persons or property or the likelihood of such injury or damage, when time requirements of such notice would make notice impractical and increase the likelihood of such injury or damage.

(b) If the business to be transacted at the special meeting requires urgent and immediate action so that it would be impractical for the commissioners to gather at one location, the special meeting may be held by telephone conference: *Provided*, That the notice requirements of section 8, chapter 250, Laws of 1971 ex. sess. and RCW 42.30.080 must be complied with: *And provided*, That the quorum and majority requirements of WAC 12-04-040(2) apply: *And further provided*, That all participating members must be able to hear all discussion and deliberation and be heard by all other participating members: *And further provided*, That such meeting shall be open and public and all persons shall be permitted to attend any such meeting pursuant to the provisions of chapter 250, Laws of 1971 ex. sess. [chapter 42.30 RCW], by coming to the administrative office of the commission where speakers will be provided which shall transmit all discussion and deliberation.

[Order 76-1, § 12-04-050, filed 4/29/76.]

WAC 12-04-060 Public records officer. The commission's public records shall be in charge of the public records officer designated by the commission. The person so designated shall be located in the administrative office of the commission. The public records officer shall be responsible for the following: The implementation of the commission's rules and regulations regarding release of public records, coordinating the staff of the commission in this regard, and generally insuring compliance by the staff with the public records disclosure requirements of chapter 1, Laws of 1973 [chapter 42.17 RCW].

[Order 76-1, § 12-04-060, filed 4/29/76.]

WAC 12-04-070 Office hours. Public records shall be available for inspection and copying during the customary office hours of the commission. For the purposes of this chapter, the customary office hours shall be from 9:00 a.m. to noon and from 1:00 p.m. to 4:00 p.m., Monday through Friday, excluding legal holidays.

[Order 76-1, § 12-04-070, filed 4/29/76.]

WAC 12-04-080 Requests for public records. In accordance with requirements of chapter 1, Laws of 1973 [chapter 42.17 RCW] that agencies prevent unreasonable invasions of privacy, protect public records from damage or disorganization, and prevent excessive interference with essential functions of the agency, public records may be inspected or copied or copies of such records may be obtained, by members of the public, upon compliance with the following procedures:

(1) A request shall be made in writing upon a form prescribed by the commission which shall be available at its administrative office. The form shall be presented to

the public records officer; or to any member of the commission's staff, if the public records officer is not available, at the administrative office of the commission during customary office hours. The request shall include the following information:

- (a) The name of the person requesting the record;
- (b) The time of day and calendar date on which the request was made;
- (c) The nature of the request;
- (d) If the matter requested is referenced within the current index maintained by the records officer, a reference to the requested record as it is described in such current index;
- (e) If the requested matter is not identifiable by reference to the commission's current index, an appropriate description of the record requested.

(2) In all cases in which a member of the public is making a request, it shall be the obligation of the public records officer or staff member to whom the request is made, to assist the member of the public in appropriately identifying the public record requested.

[Order 76-1, § 12-04-080, filed 4/29/76.]

WAC 12-04-090 Copying. No fee shall be charged for the inspection of public records. The commission shall charge a fee of ten cents per page of copy for providing copies of public records and for use of the commission's copy equipment. This charge is the amount necessary to reimburse the commission for its actual costs incident to such copying.

[Order 76-1, § 12-04-090, filed 4/29/76.]

WAC 12-04-100 Exemptions. (1) The commission reserves the right to determine that a public record requested in accordance with the procedures outlined in WAC 12-04-080 is exempt under the provisions of RCW 42.17.310.

(2) In addition, pursuant to RCW 42.17.260, the commission reserves the right to delete identifying details when it makes available or publishes any public record, in any cases when there is reason to believe that disclosure of such details would be an invasion of personal privacy protected by chapter 42.17 RCW. The public records officer will fully justify such deletion in writing.

(3) All denials of requests for public records must be accompanied by a written statement specifying the reason for the denial, including a statement of the specific exemption authorizing the withholding of the record and a brief explanation of how the exemption applies to the record withheld.

[Order 76-1, § 12-04-100, filed 4/29/76.]

WAC 12-04-110 Review of denials of public records requests. (1) Any person who objects to the denial of a request for a public record may petition for prompt review of such decision by tendering a written request for review. The written request shall specifically refer to the written statement by the public records officer or other

staff member which constituted or accompanied the denial.

(2) Immediately after receiving a written request for review of a decision denying a public record, the public records officer or other staff member denying the request shall refer it to the chairman of the commission. The chairman shall immediately consider the matter and either affirm or reverse such denial or call a special meeting of the commission as soon as legally possible to review the denial. In any case, the request shall be returned with a final decision, within two business days following the original denial.

(3) Administrative remedies shall not be considered exhausted until the commission has returned the petition with a decision or until the close of the second business day following denial of inspection, whichever occurs first.

(4) With regard to review of denial of requests hereunder, the provisions of WAC 12-04-040(2) regarding quorum shall be inapplicable.

[Order 76-1, § 12-04-110, filed 4/29/76.]

WAC 12-04-120 Protection of public records. The public records officer shall, to the extent practical, insure that records requested are not removed from the premises nor portions thereof removed by members of the public.

[Order 76-1, § 12-04-120, filed 4/29/76.]

WAC 12-04-130 Records index. (1) The commission has available to all persons a current index which provides identifying information as to those of the following records applicable to the commission and issued, adopted or promulgated since June 30, 1972:

(a) Final opinions, including concurring and dissenting opinions, as well as orders, made in the adjudication of cases;

(b) Those statements of policy and interpretations of policy, statute and the constitution which have been adopted by the agency;

(c) Administrative staff manuals and instructions to staff that affect a member of the public;

(d) Planning policies and goals, and interim and final planning decisions;

(e) Factual staff reports and studies, factual consultant's reports and studies, scientific reports and studies, and any other factual information derived from tests, studies, reports or surveys, whether conducted by public employees or others; and

(f) Correspondence, and materials referred to therein, by and with the agency relating to any regulatory, supervisory or enforcement responsibilities of the agency, whereby the agency determines, or opines upon, or is asked to determine or opine upon, the rights of the state, the public, a subdivision of state government, or of any private party.

(2) The current index promulgated by the commission shall be available to all persons under the same rules and on the same conditions as are applied to public records available for inspection.

[Order 76-1, § 12-04-130, filed 4/29/76.]

WAC 12-04-140 Communications. All communications with the commission including but not limited to the submission of materials pertaining to its operations and/or the administration or enforcement of chapter 1, Laws of 1973 [chapter 42.17 RCW] and these rules; requests for copies of the commission's decisions and other matters, shall be addressed as follows: c/o Public Records Officer, Aeronautics Commission, 8600 Perimeter Road, Boeing Field, Seattle, Washington 98108.

[Order 76-1, § 12-04-140, filed 4/29/76.]

WAC 12-04-150 Adoption of form. The aeronautics commission hereby adopts use by all persons requesting inspection and/or copies of records the form set out below, entitled "Request for public records."

We have received your request for copies of our public records. Please complete the form on the right and return it with the amount required. We will forward the requested copies to you as soon as we receive this form.

Thank you.

Return to:

Aeronautics Commission
8600 Perimeter Road
Boeing Field
Seattle, Washington 98108

AERONAUTICS COMMISSION

REQUEST FOR PUBLIC RECORDS

Date ----- Time -----

Name -----

Address -----

Description of Records (see index):

I certify that the information obtained through this request for public records will not be used for commercial purposes.

Signature

Number of copies -----

Number of pages -----

Per page charge \$-----

Total charge \$-----

[Order 76-1, § 12-04-150, filed 4/29/76.]

**Chapter 12-08 WAC
PRACTICE AND PROCEDURE**

WAC

- 12-08-010 Uniform procedural rules.
- 12-08-020 Contested case hearing.
- 12-08-030 Hearings before hearing officer.
- 12-08-040 Proposed orders by hearing officers and appeal.

WAC 12-08-010 Uniform procedural rules. The Washington state aeronautics commission, hereinafter designated the commission, adopts as its rules of practice those uniform procedural rules promulgated by the code reviser, now codified in the Washington Administrative Code, WAC 1-08-005 through 1-08-590 as now or hereafter amended, subject to the additional rules contained herein as WAC 12-08-020 through 12-08-040 and such other additional rules that the commission may add from time to time. The commission reserves the right to make whatever determination is fair and equitable should any question, not covered by its rules, come before the commission, said determination to be in accordance with the spirit and intent of the law (chapter 165, Laws of 1947 [chapter 14.04 RCW]).

[Order 76-1, § 12-08-010, filed 4/29/76.]

WAC 12-08-020 Contested case hearing. The commission shall hold formal hearings, conducted as contested cases under the Administrative Procedure Act, chapter 34.04 RCW, where required by the provisions of chapter 14.04 RCW.

[Order 76-1, § 12-08-020, filed 4/29/76.]

WAC 12-08-030 Hearings before hearing officer. When directed by the commission, any hearing conducted pursuant to chapter 14.04 RCW shall be heard by a hearing officer appointed by the commission. Contested case hearings shall be conducted in accordance with the uniform rules of procedure under WAC 12-08-010 as otherwise modified by this chapter.

[Order 76-1, § 12-08-030, filed 4/29/76.]

WAC 12-08-040 Proposed orders by hearing officers and appeal. (1) General. WAC 12-08-030 shall apply in any proceeding under chapter 14.04 RCW which has been the subject of a contested case hearing and which is the subject of decision by the commission, except when:

- (a) There is no objection to a request, made on the record, by a party or the hearing officer for omission of the hearing officer's proposed order; or
- (b) the decision is not adverse to any party to the proceeding other than to the commission.

(2) Preparation and service of proposed order. In proceedings covered by (1) the officer conducting the hearing, or, when required, such other officer as shall be designated by the commission, shall prepare a proposed order including findings of fact and conclusions of law and the same shall be served upon all parties of record.

(3) Briefs to hearing officer. At the conclusion of the hearing, the hearing officer may provide for the submission of briefs and fix the time to be allotted therefor.

(4) Exceptions—Who may file. Any party of record may file exceptions to the hearing officer's proposed order.

(5) Exceptions—Time for filing. Exceptions to hearing officer's proposed order must be filed in triplicate with the director the commission and one copy must be served upon all other parties of record or their attorneys within ten days of the date of service of said proposed order. Proof of service must be made in accordance with WAC 1-08-120.

(6) Exceptions—Contents. Exceptions to hearing officer's proposed orders shall be specific and must be stated and numbered separately. Exceptions to findings of fact must be supported by reference to that page or part of the record or, in the alternative, by a statement of the evidence relied upon to support the exception, and shall be accompanied by a recommended finding of fact. Exceptions to conclusions of law must be supported by reference to the appropriate statute, and/or to the applicable rule and regulation involved and shall be accompanied by a corrected conclusion of law. When exceptions are taken to statements in the summary portion of the proposed order, there shall be included a statement showing the legal or factual justification for such exceptions, together with a statement showing how the alleged defect in the summary affects the findings of fact or conclusions of law, or the ultimate order.

(7) Replies—Who may file. Any party of record may file replies to exceptions.

(8) Replies—Time for filing. Replies to exceptions must be filed in triplicate with the director the commission. One copy shall be served on all other parties of record or their attorney of record within ten days of the date of the service of the exceptions. Proof of service must be made in accordance with WAC 1-08-120.

(9) Replies—Contents. Replies to exceptions shall be specific and must be stated and numbered separately and must be supported by a reference to that page or part of the record, or in the alternative a statement of the evidence, relied upon to support the reply.

(10) Time for filing—Variance. The hearing officer or the commission may in his or its discretion, upon notice to the parties, reduce or extend the time for filing exceptions and replies.

(11) Briefs or written arguments. Briefs or written arguments shall accompany exceptions and replies.

(12) Oral argument. The commission may in its discretion hear oral argument at a time and place to be designated by it upon notice to all affected parties. Upon the failure of any party requesting and receiving permission to present oral argument to make such argument to the commission in support of its written objections, the commission may on its own motion consider the case submitted on the briefs or written arguments, unless such party shall have requested and have been granted a continuance in advance.

(13) Final decision. After reviewing the exceptions, replies, briefs, oral arguments, if any, and the record or

such portions thereof as may be cited by the parties, or on its own motion if no exceptions are filed, a majority of the commission may affirm or modify the hearing officer's proposed order by an appropriate order. The statutory time for review proceedings shall not commence until the date of the commission's final decision and order.

[Order 76-1, § 12-08-040, filed 4/29/76.]

Chapter 12-10 WAC GUIDELINES INTERPRETING AND IMPLEMENTING THE STATE ENVIRONMENTAL POLICY ACT

WAC	
12-10-010	Authority.
12-10-020	Substitution of commission.
12-10-025	Scope and coverage of this chapter.
12-10-030	Purpose.
12-10-035	Effect of SEPA.
12-10-040	Definitions.
12-10-050	Use of the environmental checklist form.
12-10-055	Timing of the EIS process.
12-10-060	Scope of a proposal and its impacts for the purposes of lead agency determination, threshold determination, and EIS preparation.
12-10-100	Summary of information which may be required of a private applicant.
12-10-160	No presumption of significance for nonexempt actions.
12-10-170	Categorical exemptions.
12-10-180	Exemption for emergency actions.
12-10-190	Use and effect of categorical exemptions.
12-10-200	Lead agency—Responsibilities.
12-10-203	Determination of lead agency—Procedures.
12-10-205	Lead agency designation—Governmental proposals.
12-10-210	Lead agency designation—Proposals involving both private and public construction activity.
12-10-215	Lead agency designation—Private projects for which there is only one agency with jurisdiction.
12-10-230	Lead agency designation—Specific proposals.
12-10-240	Agreements as to lead agency status.
12-10-245	Agreements between agencies as to division of lead agency duties.
12-10-260	Dispute as to lead agency determination—Resolution by CEP.
12-10-270	Assumption of lead agency status by another agency with jurisdiction.
12-10-300	Threshold determination requirement.
12-10-305	Recommended timing for threshold determination.
12-10-310	Threshold determination procedures—Environmental checklist.
12-10-320	Threshold determination procedures—Initial review of environmental checklist.
12-10-330	Threshold determination procedures—Information in addition to checklist.
12-10-340	Threshold determination procedures—Negative declarations.
12-10-345	Assumption of lead agency status by another agency with jurisdiction over a proposal—Prerequisites, effect and form of notice.
12-10-350	Affirmative threshold determination.
12-10-355	Form of declaration of significance/nonsignificance.
12-10-360	Threshold determination criteria—Application of environmental checklist.
12-10-365	Environmental checklist.
12-10-370	Withdrawal of affirmative threshold determination.
12-10-375	Withdrawal of negative threshold determination.
12-10-390	Effect of threshold determination by lead agency.
12-10-400	Duty to begin preparation of a draft EIS.
12-10-405	Purpose and function of a draft EIS.

12-10-410	Predraft consultation procedures.
12-10-420	Preparation of EIS by persons outside the lead agency.
12-10-425	Organization and style of a draft EIS.
12-10-440	Contents of a draft EIS.
12-10-442	Special considerations regarding contents of an EIS on a nonproject action.
12-10-444	List of elements of the environment.
12-10-450	Public awareness of availability of draft EIS.
12-10-455	Circulation of the draft EIS—Review period.
12-10-460	Specific agencies to which draft EIS shall be sent.
12-10-465	Agencies possessing environmental expertise.
12-10-470	Cost to the public for reproduction of environmental documents.
12-10-480	Public hearing on a proposal—When required.
12-10-485	Notice of public hearing on environmental impact of the proposal.
12-10-490	Public hearing on the proposal—Use of environmental documents.
12-10-495	Preparation of amended or new draft EIS.
12-10-500	Responsibilities of consulted agencies—Local agencies.
12-10-510	Responsibilities of consulted agencies—State agencies with jurisdiction.
12-10-520	Responsibilities of consulted agencies—State agencies with environmental expertise.
12-10-530	Responsibilities of consulted agencies—When predraft consultation has occurred.
12-10-535	Cost of performance of consulted agency responsibilities.
12-10-540	Limitations on responses to consultation.
12-10-545	Effect of no written comment.
12-10-550	Preparation of the final EIS—Time period allowed.
12-10-570	Preparation of the final EIS—Contents—When no critical comments received on the draft EIS.
12-10-580	Preparation of the final EIS—Contents—When critical comments received on the draft EIS.
12-10-600	Circulation of the final EIS.
12-10-650	Effect of an adequate final EIS prepared pursuant to NEPA.
12-10-652	Supplementation by a lead agency of an inadequate final NEPA EIS.
12-10-660	Use of previously prepared EIS for a different proposed action.
12-10-690	Use of lead agency's EIS by other acting agencies for the same proposal.
12-10-695	Draft and final supplements to a revised EIS.
12-10-700	No action for seven days after publication of the final EIS.
12-10-710	EIS combined with existing planning and review processes.
12-10-800	SEPA public information center.
12-10-810	Responsibility of agencies—Amendments to this chapter.
12-10-820	Responsibility of agencies—Procedures when consulted agency.
12-10-830	Application of agency guidelines to ongoing actions.
12-10-840	Fees to cover the costs of SEPA compliance.
12-10-900	Severability.

WAC 12-10-010 Authority. This chapter is promulgated pursuant to the authority granted in RCW 43.21C.110.

[Order 77-1, § 12-10-010, filed 8/22/77.]

WAC 12-10-020 Substitution of commission. Wherever reference is made in this chapter to 'state and/or local agencies' or 'agency,' such language shall be deemed to refer to the commission, unless a contrary intent is clearly shown. Notwithstanding the foregoing, references in WAC 12-10-170 (4)(b) and (d) shall continue to refer generally to agencies other than the commission.

(1990 Ed.)

[Order 77-1, § 12-10-020, filed 8/22/77.]

WAC 12-10-025 Scope and coverage of this chapter. (1) It is the intent of the council on environmental policy (CEP) that compliance with the guidelines of this chapter, and agency guidelines consistent therewith, shall constitute complete procedural compliance with SEPA for any "action" as defined in WAC 12-10-040(2).

(2) The guidelines of this chapter do not address the issue of the substantive effect that the enactment of SEPA has upon agency decision making.

(3) The guidelines of this chapter contain no sections relating to the notice/statute of limitations provisions of RCW 43.21C.080, 43.21C.085 and 43.21C.087. Persons and agencies wishing to utilize these provisions shall follow the statutory language and any applicable regulations of the department of ecology.

[Order 77-1, § 12-10-025, filed 8/22/77.]

WAC 12-10-030 Purpose. (1) The purpose of this chapter is to implement the statewide guidelines (chapter 12-10 WAC) established by the council on environmental policy as they apply to actions of the commission.

(2) In order to carry out the policy set forth in this chapter, it is the continuing responsibility of the commission to use all practicable means, consistent with other essential considerations of state policy, to improve and coordinate plans, functions, programs, and resources to the end that the state and its citizens may:

(a) Fulfill the responsibilities of each generation as trustee of the environment for succeeding generations;

(b) Assure for all people of Washington safe, healthful, productive, and esthetically and culturally pleasing surroundings;

(c) Attain the widest range of beneficial uses of the environment without degradation, risk to health or safety, or other undesirable and unintended consequences;

(d) Preserve important historic, cultural, and natural aspects of our national heritage;

(e) Maintain, wherever possible, an environment which supports diversity and variety of individual choice;

(f) Achieve a balance between population and resource use which will permit high standards of living and a wide sharing of life's amenities; and

(g) Enhance the quality of renewable resources and approach the maximum attainable recycling of depletable resources.

(3) The commission recognizes that each person has a fundamental and inalienable right to a healthful environment and that each person has a responsibility to contribute to the preservation and enhancement of the environment.

[Order 77-1, § 12-10-030, filed 8/22/77.]

WAC 12-10-035 Effect of SEPA. The State Environmental Policy Act provides additional standards for agency decision making for all activities which may have an impact on the environment. The processes of the

[Title 12 WAC—p 7]

State Environmental Policy Act, including but not limited to detailed statement requirements, are aimed at making more informed decisions, and toward projects with greater public and environmental acceptability. The process should foster mutual communication, understanding and cooperation among applicants, governmental agencies and citizens. All reasonable alternatives and mitigative/compensatory measures should be explored.

[Order 77-1, § 12-10-035, filed 8/22/77.]

WAC 12-10-040 Definitions. The following words and terms have the following meanings for the purposes of this chapter, unless the context indicates otherwise:

(1) **Acting agency.** Acting agency means an agency with jurisdiction which has received an application for a license, or which is the initiator of a proposed action.

(2) **Action.** Action means an activity potentially subject to the environmental impact statement requirements of RCW 43.21C.030 (2)(c) and (d). (See the provisions of WAC 12-10-170, 12-10-175 and 12-10-180 for activities that are exempted from the threshold determination and environmental impact statement requirements of SEPA and these guidelines, due to CEP's determination that such activities are minor, not "major," actions, even though such activities are within one of the subcategories below.) All actions fall within one of the following subcategories:

(a) Governmental licensing.

(b) Governmental action of a project nature. This includes and is limited to:

(i) The decision by an agency to undertake any activity which will directly modify the physical environment, whether such activity will be undertaken directly by the agency or through contract with another, and

(ii) The decision to purchase, sell, lease, transfer or exchange natural resources, including publicly owned land, whether or not it directly modifies the environment.

(c) Governmental action of a nonproject nature. This includes and is limited to:

(i) The adoption or amendment of legislation, ordinances, rules or regulations which contain standards controlling use or modification of the physical environment;

(ii) The adoption or amendment of comprehensive land use plans or zoning ordinances;

(iii) The adoption of any policy, plan or program which will govern the development of a series of functionally related major actions, but not including any policy, plan or program for which approval must be obtained from any federal agency prior to implementation;

(iv) Creation of, or annexations to, any city, town or district;

(v) Adoptions or approvals of utility, transportation and solid waste disposal rates;

(vi) Capital budgets; and

(vii) Road, street and highway plans.

(3) **Agencies with expertise.** Agencies with expertise means those agencies to which a draft environmental impact statement shall be sent pursuant to WAC 12-10-465, unless they are also agencies with jurisdiction.

(4) **Agencies with jurisdiction.** Agencies with jurisdiction means those agencies from which a nonexempt license is required for a proposal or any part thereof, or which will act upon an application for a grant or loan for a proposal, or agencies which are proposing or initiating any governmental action of a project or nonproject nature. The term does not include those agencies authorized to adopt rules or standards of general applicability which govern the proposal in question, when no license or approval is required for specific proposals; nor does the term include agencies, involved in approving grants or loans, which serve only as conduits between the primary administering agency and the recipient of the grant or loan. Federal agencies with jurisdiction are instrumentalities of the federal government from which a license is required, or which will receive an application for a grant or loan for a proposal.

(5) **Agency or agencies.** Agency or agencies mean all state agencies and local agencies as defined in this section. The term does not include any agency or division of the federal government. Whenever a specific agency has been named in these guidelines and the functions of that agency have been transferred to another agency, then the term shall mean such successor agency.

(6) **CEP.** CEP means the council on environmental policy.

(7) **Consulted agency.** Consulted agency means any agency with jurisdiction or with expertise which is consulted, or from which information is requested by a lead agency during the threshold determination, predraft consultation, or consultation on a draft environmental impact statement.

(8) **County/city.** County/city means a county, city or town. For the purposes of this chapter, duties and powers are assigned to a county, city or town as a unit, with the delegation of responsibilities among the various departments of a county, city or town being left to the legislative or charter authority of the individual counties, cities or towns.

(9) **Declaration of nonsignificance.** Declaration of nonsignificance means the written decision by the responsible official of the lead agency that a proposal will not have a significant adverse environmental impact and that therefore no environmental impact statement is required. A form substantially consistent with that in WAC 12-10-355 shall be used for this declaration.

(10) **Declaration of significance.** Declaration of significance means the written decision by the responsible official of the lead agency that a proposal will or could have a significant adverse environmental impact and that therefore an environmental impact statement is required. A form substantially consistent with that in WAC 12-10-355 shall be used for this declaration.

(11) **Draft EIS.** Draft EIS means an environmental impact statement prepared prior to the final detailed statement.

(12) **EIS.** EIS means the detailed statement required by RCW 43.21C.030 (2)(c). It may refer to either a draft or final environmental impact statement, or both, depending upon context.

(13) Environment. Environment means, and is limited to, those areas listed in WAC 12-10-444.

(14) Environmental checklist. Environmental checklist means the form contained in WAC 12-10-365.

(15) Environmental document. Environmental document means every written public document prepared or utilized as a result of the requirements of this chapter.

(16) Environmentally sensitive area. Environmentally sensitive area means an area designated and mapped by a county/city pursuant to WAC 12-10-177, and within which certain categorical exemptions do not apply.

(17) Final EIS. Final EIS means an environmental impact statement prepared to reflect comments to the draft EIS. It may consist of a new document, or of the draft EIS together with supplementary material prepared pursuant to WAC 12-10-570, 12-10-580 or 12-10-695.

(18) Lands covered by water. Lands covered by water means lands underlying the water areas of the state, including salt waters, tidal waters, estuarine waters, natural water courses, lakes, ponds, artificially impounded waters, marshes and swamps. Certain categorical exemptions do not apply to lands covered by water.

(19) Lead agency. Lead agency means the agency designated by the provisions of WAC 12-10-200 through 12-10-270 or 12-10-345, which is responsible for making the threshold determination and preparing or supervising preparation of the draft and final environmental impact statements.

(20) License. License means any form of written permission given to any person, organization or agency to engage in any activity, as required by law or agency rule. A license thus includes the whole or part of any agency permit, certificate, approval, registration, charter, or plat approvals or rezones to facilitate a particular project; a license required solely for revenue purposes is not included.

(21) Licensing. Licensing means the agency process in granting, renewing or modifying a license.

(22) List of elements of the environment. List of elements of the environment means the list contained in WAC 12-10-444 which must be attached to every environmental impact statement.

(23) Local agency. Local agency means any political subdivision, regional governmental unit, district, municipal or public corporation including cities, towns and counties. The term does not include the departments of a city or county.

(24) Major action. Major action means any "action" as defined in this section which is not exempted by WAC 12-10-170, 12-10-175 and 12-10-180.

(25) Nonproject EIS. Nonproject EIS means an environmental impact statement prepared for a proposal for any governmental action of a nonproject nature as defined under "action" in this section.

(26) Physical environment. Physical environment means and is limited to those elements of the environment listed under "physical environment" in WAC 12-10-444(2).

(27) Private applicant. Private applicant means any person or entity, other than an agency as defined in this section, applying for a license from an agency.

(28) Private project. Private project means any proposal for which the primary initiator or sponsor is an individual or entity other than an "agency" as defined in this section.

(29) Proposal. Proposal means a specific request to undertake any activity submitted to, and which is seriously considered by, an agency or a decision maker within an agency, as well as any action or activity which may result from approval of any such request. Further definition of the scope of a proposal for the purposes of lead agency determination, the threshold determination, and impact statement preparation is contained in WAC 12-10-060.

(30) Responsible official. Responsible official means that officer or officers, committee, department or section of the lead agency designated by the lead agency's guidelines to undertake its responsibilities as lead agency. The director shall be the responsible official of the commission.

(31) SEPA. SEPA means the State Environmental Policy Act of 1971, chapter 43.21C RCW, as amended.

(32) State agency. State agency means any state board, commission or department except those in the legislative or judicial branches. The term includes the office of the governor and the various divisions thereof, state universities, colleges and community colleges.

(33) Threshold determination. Threshold determination means the decision by a lead agency whether or not an environmental impact statement is required for a proposal.

[Order 77-1, § 12-10-040, filed 8/22/77.]

WAC 12-10-050 Use of the environmental checklist form. A form is provided in WAC 12-10-365 for an environmental checklist to be initially completed by an action proponent, whether public or private, either alone or together with the lead agency, usually in conjunction with a license application. This form must be used in the threshold determination; it will also be helpful in making the lead agency designation and in predraft consultation. However, where there is an agreement between the proponent of a nonexempt action (whether a private applicant or an agency which is not the lead agency) and the lead agency that an EIS is required, the completion of the environmental checklist is unnecessary. Where the action proponent and the lead agency are the same entity, and a decision to prepare an EIS has been made, then no checklist is required.

[Order 77-1, § 12-10-050, filed 8/22/77.]

WAC 12-10-055 Timing of the EIS process. (1) The primary purpose of the EIS process is to provide environmental information to governmental decision makers to be considered prior to making their decision. The process should thus be completed before the decisions of an agency commit it to a particular course of action. The actual decision to proceed with many actions may involve a series of individual approvals or decisions.

The threshold determination and the EIS, if required, should ideally be completed at the beginning of this process. In many cases, however, preliminary decisions must be made upon a proposal before the proposal is sufficiently definite to permit meaningful environmental analysis. The commission shall identify in each matter coming before it for action the time at which the EIS process shall be completed. The lead agency should require completion of the threshold determination and EIS, if required, at the earliest point in the planning and decision-making process when the principal features of a proposal and its impacts upon the environment can be reliably identified.

(2) At a minimum, the threshold determination and any required EIS shall be completed prior to undertaking any proposed major action.

(3) When a proposed major action is a proposal for either a governmental action of a project nature or a governmental action of a nonproject nature, and the proponent of the major action is also the lead agency, then the maximum time limits contained in these guidelines for the threshold determination and EIS process need not apply to the proposal.

[Order 77-1, § 12-10-055, filed 8/22/77.]

WAC 12-10-060 Scope of a proposal and its impacts for the purposes of lead agency determination, threshold determination, and EIS preparation. (1) The proposal considered by an acting agency during the lead agency determination procedure, and by the lead agency during the threshold determination and EIS preparation, shall be the total proposal including its direct and indirect impacts. Whenever the word "proposal" or the term "proposed action" is used in this chapter, the discussion in subsection (2) hereof is applicable. In considering the environmental impacts of a proposal during the threshold determination and EIS preparation, the discussion in subsection (3) hereof is applicable.

(2) The total proposal is the proposed action, together with all proposed activity which is functionally related to it. Future activities are functionally related to the present proposal if:

(a) The future activity is an expansion of the present proposal, facilitates operation of the present proposal or is necessary thereto; or

(b) The present proposal facilitates or is a necessary prerequisite to future activities.

The scope of the proposal is not limited by the jurisdiction of the lead agency. The fact that future impacts of a proposal will require future governmental approvals shall not be a bar to their present consideration, so long as the plans for those future elements are sufficiently specific to allow some evaluation of their potential environmental impacts. Acting agencies and lead agencies should be alert to the possibility that a proposal may involve other agencies with jurisdiction which may not be taking any action until sometime in the future. (For example, in a proposal for a plat approval, another agency with jurisdiction may be the appropriate sewer district, even though installation of sewers may not occur until several years later.)

[Title 12 WAC—p 10]

(3) The impacts of a proposal include its direct impacts as well as its reasonably anticipated indirect impacts. Indirect impacts are those which result from any activity which is induced by a proposal. These include, but are not limited to, consideration of impacts resulting from growth induced by the proposal, or the likelihood that the present action will serve as a precedent for future actions. (For example, adoption of a zoning ordinance will encourage or tend to cause particular types of projects.) Contemporaneous or subsequent development of a similar nature, however, need not be considered in the threshold determination unless there will be some causal connection between such development and one or more of the governmental decisions necessary for the proposal in question.

(4) Proposals involving extensive future actions may be divided, at the option of the lead agency, into segments with an EIS prepared for each segment. In such event, the earlier EIS shall describe the later segments of the proposal and note that future environmental analysis will be required for these future segments. The segmentation allowed by this subsection shall not be applied at the threshold determination to determine that any segment of a more extensive significant proposal is insignificant; nor shall segmentation be applied so as to require significant duplication of analysis contained in an earlier EIS.

(5) For proposed projects, such as highways, streets, pipelines or utility lines or systems where the proposed action is related to a large existing or planned network, the lead agency may at its option treat the present proposal as the total proposal, or select only some of the future elements for present consideration in the threshold determination and EIS. These categorizations shall be logical with relation to the design of the total system or network itself, and shall not be made merely to divide a larger system into exempted fragments.

[Order 77-1, § 12-10-060, filed 8/22/77.]

WAC 12-10-100 Summary of information which may be required of a private applicant. (1) There are three areas of these guidelines where an agency is allowed to require information from a private applicant. These are:

- (a) Environmental checklist;
- (b) Threshold determination; and,
- (c) Draft and final EIS.

The responsible official may determine that any information supplied by a private applicant is insufficient and require further information, if in the judgment of the responsible official the information initially supplied was not reasonably adequate to fulfill the purpose for which it was required. An applicant may choose to voluntarily submit, at any time, information beyond that which may be required under these guidelines.

(2) **Environmental checklist.** A private applicant is required to complete an environmental checklist as set forth in WAC 12-10-365 either concurrently with or after filing the application. Explanations for each "yes" and "maybe" answer indicated thereon are required.

Agencies may not require a complete assessment or "mini-EIS" at this stage. (See WAC 12-10-310.)

(3) **Threshold determination.** The lead agency shall make an initial review of a completed checklist without requiring more information from a private applicant. If, and only if, the lead agency determines as a result of its initial review that the information available to it is not reasonably sufficient to determine the environmental impacts of the proposal, the lead agency may require further information from the applicant, including explanation of "no" answers on the checklist. This information shall be limited to those elements on the environmental checklist for which, as determined by the lead agency, information accessible to the lead agency is not reasonably sufficient to evaluate the environmental impacts of the proposal. Field investigations or research by the applicant reasonably related to determining the environmental impacts of the proposal may be required. (See WAC 12-10-330.)

(4) **Draft and final EIS preparation.** If the guidelines of the lead agency so provide, an EIS may be prepared by the applicant under the direction of the responsible official. (See WAC 12-10-420.) Alternatively, the responsible official may require a private applicant to provide data and information which is not in the possession of the lead agency relevant to any or all areas to be covered by an EIS. A private applicant shall not be required to provide information which is the subject of a predraft consultation request until the consulted agency has responded, or the forty-five days allowed for response by the consulted agency has expired, whichever is earlier.

[Order 77-1, § 12-10-100, filed 8/22/77.]

WAC 12-10-160 No presumption of significance for nonexempt actions. No presumption as to the significance of the impacts upon the environment shall be given to any proposed action merely because it was not exempted.

[Order 77-1, § 12-10-160, filed 8/22/77.]

WAC 12-10-170 Categorical exemptions. Governmental activities or approvals of activities of the types listed herein are not major actions, and proposals for such activities are exempted from the threshold determination and EIS requirements of SEPA and these guidelines:

(1) **Minor new construction.** The following types of construction shall be exempt except when undertaken wholly or in part on lands covered by water; the exemptions provided by this subsection apply to all governmental licenses required to undertake the construction in question, except rezones or any license governing emissions to the air or water:

(a) The construction of any residential structure of four dwelling units or less.

(b) The construction of a barn, loafing shed, farm equipment storage building, produce storage or packing structure, or similar agricultural structure, covering less than 10,000 square feet and to be used only by the

property owner or his or her agent in the conduct of farming the property. This exemption shall not apply to feedlots.

(c) The construction of an office, school, commercial, recreational, service or storage building with less than 4,000 square feet of floor area, and with associated parking facilities designed for twenty automobiles or less.

(d) The construction or designation of bus stops, loading zones, shelters, access facilities and pull-out lanes for taxicabs, transit and school vehicles.

(e) The construction and/or installation of commercial on-premise signs, and public signs and signals.

(f) The construction or installation of minor road and street improvements such as pavement marking, freeway surveillance and control systems, railroad protective devices (not including grade separated crossings), grooving, glare screen, safety barriers, energy attenuators, highway landscaping (including the application of Washington state department of agriculture approved herbicides by licensed personnel for right-of-way weed control), temporary traffic controls and detours, correction of substandard curves and intersections within existing rights-of-way, channelization and elimination of sight restrictions at intersections, street lighting, guard-rail and barricade installation, installation of catch basins and culverts, and reconstruction of existing road bed (existing curb to curb in urban locations), including minor widening of shoulders, addition of bicycle lanes, paths and facilities, and pedestrian walks and paths, but not including additional automobile lanes.

(g) The installation of hydrological measuring devices, regardless of whether or not on lands covered by water.

(h) The installation of any property, boundary or survey marker, other than fences, regardless of whether or not on lands covered by water.

(i) The construction of a parking lot designed for twenty automobiles or less.

(j) Any landfill or excavation of 500 cubic yards or less throughout the total lifetime of the fill or excavation; and any fill or excavation classified as a Class I, II, III and IV forest practice under chapter 200, Laws of 1975 ex. sess., or regulations promulgated thereunder, except those forest practices designated by the forest practices board as being subject to SEPA evaluation.

(k) The repair, maintenance or minor alteration of existing private or public structures, facilities or equipment, including utilities, involving no material expansions or changes in use beyond that previously existing.

(l) Grading, excavating, filling, septic tank installation, and landscaping necessary for any building or facility exempted by this subsection, as well as fencing and the construction of small structures and minor facilities accessory thereto.

(m) Additions or modifications to or replacement of any building or facility exempted by this subsection when such addition, modification or replacement will not change the character of the building or facility in a way which would remove it from an exempt class.

(n) The demolition of any structure or facility, the construction of which would be exempted by this subsection, except for structures or facilities with recognized historical significance.

(2) **Water rights.** The following appropriations of water shall be exempt, the exemption covering not only the permit to appropriate water, but also any hydraulics permit, shoreline permit or building permit required for a normal diversion or intake structure, well and pump-house reasonably necessary to accomplish the exempted appropriation, and including any activities relating to construction of a distribution system solely for any exempted appropriation:

(a) Appropriations of fifty cubic feet per second or less of surface water for irrigation purposes, when done without a government subsidy.

(b) Appropriations of one cubic foot per second or less of surface water, or of ten cubic feet per second or less of ground water, for any purpose.

(3) **Judicial activity.** The following shall be exempt:

(a) All adjudicatory actions of the judicial branch.

(b) Any quasi-judicial action of any agency if such action consists of the review of a prior administrative or legislative decision. Decisions resulting from contested cases or other hearing processes conducted prior to the first decision on a proposal, or upon any application for a rezone, conditional use permit or other similar permit not otherwise exempted by this chapter, are not exempted by this subsection.

(4) **Enforcement and inspections.** The following enforcement and inspection activities shall be exempt:

(a) All actions, including administrative orders and penalties, undertaken to enforce a statute, regulation, ordinance, resolution or prior decision. No license shall be considered exempt by virtue of this subsection; nor shall the adoption of any ordinance, regulation or resolution be considered exempt by virtue of this subsection.

(b) All inspections conducted by an agency of either private or public property for any purpose.

(c) Fire department, police patrol and traffic law enforcement except where such involves any physical construction activity.

(d) Any action undertaken by an agency to abate a nuisance or to abate, remove or otherwise cure any hazard to public health or safety: *Provided*, That no open burning shall be exempted under this subsection, nor shall the application of any pesticide or chemical. No license shall be considered exempt by virtue of this subsection; nor shall the adoption of any ordinance, regulation or resolution be considered exempt by virtue of this subsection.

(e) Any suspension or revocation of a license for any purpose.

(5) **Business and other regulatory licenses.** The following business and other regulatory licenses are exempt:

(a) All licenses to undertake an occupation, trade or profession.

(b) All licenses required under electrical, fire, plumbing, heating and safety codes, but not including building permits.

(c) Licenses to operate amusement devices and entertainment carnivals, circuses and other traveling shows, dances, music machines and theaters, including approval of use of public facilities for temporary civic celebrations, but not including licenses required for permanent construction of any of the above.

(d) Licenses for solicitation or door to door sales, private security and detective services, and taxicabs and other vehicles for hire: *Provided*, That regulation of common carriers by the utilities and transportation commission shall not be considered exempt under this subsection.

(e) Licenses for close-out sales.

(f) Licenses for food or drink services, sales and distribution.

(g) Licenses for the sale or display of fireworks.

(h) Animal control licenses.

(i) The renewal or reissuance of a license regulating any present activity or structure that was either exempted under this chapter, or the subject of a declaration of nonsignificance or an EIS, so long as no material changes have occurred since the determination of exemption, or completion of the prior declaration or EIS.

(6) **Activities of the legislature.** All actions of the state legislature are hereby exempted: *Provided*, That this subsection shall not be construed to exempt the proposing of legislation by any agency.

(7) **Activities of agencies.** The following administrative, fiscal and personnel activities of agencies shall be exempt:

(a) The procurement and distribution of general supplies, equipment and services previously authorized, or necessitated by previously approved functions or programs.

(b) The assessment and collection of taxes.

(c) The adoption of all budgets and agency requests for appropriation: *Provided*, That if such adoption includes a final agency decision to undertake a major action, that portion of the budget is not exempted by this subsection.

(d) The borrowing of funds, issuance of bonds, or applying for a grant and related financing agreements and approvals.

(e) The review and payment of vouchers and claims.

(f) The establishment and collection of liens and service billings.

(g) All personnel actions, including hiring, terminations, appointments, promotions, allocations of positions, and expansions or reductions in force.

(h) All agency organization, reorganization, internal operational planning or coordination of plans or functions.

(i) Adoptions or approvals of utility, transportation and solid waste disposal rates.

(8) **Review and comment actions.** Any activity where one agency reviews or comments upon the actions of another agency or another department within an agency shall be exempt.

(9) **Purchase or sale of real property.** The following real property transactions by an agency shall be exempt:

(a) The purchase or acquisition of any right to real property by an agency.

(b) The sale, transfer or exchange of any publicly owned real property by an agency to or with a private individual or governmental entity, but only if the property is not subject to an authorized public use.

(c) The lease of real property by an agency to a private individual or entity, or to an agency or federal agency, only when the use of the property for the term of the lease will remain essentially the same as the existing use, or when the use under the lease is otherwise exempted by this chapter.

(10) **Minor land use decisions.** The following land use decisions shall be exempt:

(a) Except upon lands covered by water, the approval of short plats or short subdivisions pursuant to the procedures required by RCW 58.17.060, but not including further short subdivision or short platting within a plat or subdivision previously exempted under this subsection.

(b) Granting of variances based on special circumstances, not including economic hardship, applicable to the subject property, such as size, slope, topography, location or surroundings and not resulting in any change in land use or density.

(c) Classification of land for current use taxation pursuant to chapter 84.34 RCW, and classification and grading of forest land under chapter 84.33 RCW.

(11) **Procedural actions.** The proposal or adoption of legislation, rules, regulations, resolutions or ordinances, or of any plan or program relating solely to governmental procedures, and containing no substantive standards respecting use or modification of the environment shall be exempt.

(12) **Acceptance of filings.** The acceptance by an agency of any document or thing required or authorized by law to be filed with the agency and for which the agency has no discretionary power to refuse acceptance shall be exempt. No license shall be considered exempt by virtue of this subsection.

(13) **Variances under Clean Air Act.** The granting of variances pursuant to RCW 70.94.181 extending applicable air pollution control requirements for one year or less shall be exempt.

(14) **Burning permits.** The issuance, revocation or suspension of permits for open burning shall be exempt. The adoption of plans, programs, objectives or regulations by any agency incorporating general standards respecting the issuance of burning permits shall not be exempt.

(15) **Water quality certifications.** The granting or denial of water quality certifications pursuant to the Federal Water Pollution Control Act Amendments of 1972 (33 U.S.C. § 1341) shall be exempt.

(16) **Financial assistance grants.** The approval of grants or loans by one agency to another shall be exempt, although an agency may at its option require compliance with SEPA prior to making a grant or loan for design or construction of a project.

(17) **Information collection and research.** Proposals for basic data collection, research, resource evaluation and

the conceptual planning of proposed actions shall be exempt. These may be for strictly information-gathering purposes, or as part of a study leading to a proposal which has not yet been approved, adopted or funded. This exemption does not include any agency action which commits the agency to proceed with the proposal.

(18) **Utilities.** The utility-related actions listed below shall be exempt: *Provided*, That installation, construction or alteration on lands covered by water shall not be exempt for actions listed below. The exemption includes installation and construction, relocation when required by other governmental bodies, together with repair, replacement, maintenance, operation or alteration by an agency or private entity which does not change the action from an exempt class.

(a) All communications lines, including cable TV, but not including microwave towers or relay stations.

(b) All storm water, water and sewer facilities, lines, equipment, hookups or appurtenances including, utilizing or related to lines eight inches or less in diameter.

(c) All electric facilities, lines, equipment or appurtenances, not including substations, with an associated voltage of 55,000 volts or less; and the overbuilding of existing distribution lines (55,000 volts or less) with transmission lines (more than 55,000 volts); and the undergrounding of all electric facilities, lines, equipment or appurtenances.

(d) All natural gas distribution (as opposed to transmission) lines and necessary appurtenant facilities and hookups.

(e) All developments within the confines of any existing electric substation, reservoir, pump station or well: *Provided*, That additional appropriations of water are not exempted by this subsection.

(f) Periodic use of chemical or mechanical means to maintain a utility or highway right-of-way in its design condition: *Provided*, That chemicals used are approved by the Washington state department of agriculture and applied by licensed personnel.

(g) All grants of franchises by agencies to utilities.

(h) All disposals of rights-of-way by utilities.

(i) All grants of rights-of-way by agencies to utilities for use for distribution (as opposed to transmission) purposes.

(19) **Natural resources management.** In addition to the other exemptions contained in this section, the following natural resources management activities shall be exempt:

(a) All Class I, II, III and IV forest practices as defined by chapter 200, Laws of 1975 ex. sess., or regulations promulgated thereunder, except those forest practices designated by the forest practices board as being subject to SEPA evaluation.

(b) Issuance of new grazing leases covering a section of land or less; and issuance of all grazing leases for land which had been subject to a grazing lease within the previous ten years.

(c) Licenses or approvals to remove firewood.

(d) Issuance of agricultural leases covering one hundred sixty contiguous acres or less.

(e) Issuance of leases for Christmas tree harvesting or brush picking.

- (f) Issuance of leases for school sites.
- (g) Issuance of leases for, and placement of, mooring buoys designed to serve pleasure craft.
- (h) Development of recreational sites not specifically designed for all-terrain vehicles and not including more than twelve campsites.
- (i) Periodic use of chemical or mechanical means to maintain public park and recreational land: *Provided*, That chemicals used are approved by the Washington state department of agriculture and applied by licensed personnel.

(j) Issuance of rights-of-way, easements and use permits to use existing public roads in nonresidential areas.

(20) **Local improvement districts.** The formation of local improvement districts, unless such formation constitutes a final agency decision to undertake construction of a structure or facility not exempted under WAC 463-46-170 and 463-46-180.

(21) **Nonactions.** Proposals for activities which are not "actions" as defined in WAC 463-46-040(2) are not subject to the threshold determination and EIS requirements of this chapter.

[Order 77-1, § 12-10-170, filed 8/22/77.]

WAC 12-10-180 Exemption for emergency actions. Actions which must be undertaken immediately, or within a time too short to allow full compliance with this chapter, to avoid an imminent threat to public health or safety, to prevent an imminent danger to public or private property, or to prevent an imminent threat of serious environmental degradation, shall be exempt from the procedural requirements of this chapter. Agencies may in their guidelines specify emergency actions which satisfy the general requirements of this section.

[Order 77-1, § 12-10-180, filed 8/22/77.]

WAC 12-10-190 Use and effect of categorical exemptions. (1) Those activities excluded from the definition of "action" in WAC 12-10-040(2), or categorically exempted by WAC 12-10-170, 12-10-175, and 12-10-180, are exempt from the threshold determination (including completion of the environmental checklist) and EIS requirements of these guidelines and RCW 43.21C-.030 (2)(c) and (d). No exemption is allowed for the sole reason that actions are considered to be of a "ministerial" nature or of an environmentally regulatory or beneficial nature.

(2) If a proposal includes a series of actions, physically or functionally related to each other, some of which are categorically exempt and some of which are not, the proposal is not exempt.

(3) For proposals in (2) above, exempt activities or actions may be undertaken prior to the threshold determination, subject to the timing considerations in WAC 12-10-055. For each such proposal a lead agency shall be determined, and a threshold determination shall be made prior to any major action with respect to the proposal, and prior to any decision by the lead agency irreversibly committing itself to adopt or approve the proposal.

[Title 12 WAC—p 14]

(4) If the proposal includes a series of exempt actions which are physically or functionally related to each other, but which together may have a significant environmental impact, the proposal is not exempt.

[Order 77-1, § 12-10-190, filed 8/22/77.]

WAC 12-10-200 Lead agency—Responsibilities. The lead agency shall be the only agency responsible for complying with the threshold determination procedures of WAC 12-10-300 through 12-10-390; and the lead agency shall be responsible for the supervision, or actual preparation, of draft EISs pursuant to WAC 12-10-400 through 12-10-495, including the circulation of such statements, and the conduct of any public hearings required by this chapter. The lead agency shall also prepare or supervise preparation of any required final EIS pursuant to WAC 12-10-550 through 12-10-695.

[Order 77-1, § 12-10-200, filed 8/22/77.]

WAC 12-10-203 Determination of lead agency—Procedures. (1) The first agency receiving or initiating a proposal for a major action, or for any part of a proposal when the total proposal involves a major action, shall determine the lead agency for that proposal. To ensure that the lead agency is determined early, agencies shall determine the lead agency for all proposals for a major action they receive, unless the lead agency has been previously determined or the agency receiving the proposal is aware that another agency is in the process of determining the lead agency. The lead agency shall be determined by using the criteria in WAC 12-10-205 through 12-10-245.

(2) If the acting agency determines that another agency is the lead agency, it shall mail to such lead agency a copy of the application it received, together with its determination of lead agency and explanation thereof. If the agency receiving this determination agrees that it is the lead agency, it shall so notify the other agencies with jurisdiction. If it does not agree, and the dispute cannot be resolved by agreement, the agencies shall immediately petition CEP for a lead agency determination pursuant to WAC 12-10-260.

(3) If the acting agency determines that it is the lead agency, it shall immediately mail a copy of its determination and explanation thereof to all other agencies with jurisdiction over the proposal. The acting agency shall then proceed, as the lead agency, to the threshold determination procedure of WAC 12-10-300 through 12-10-390. If another agency with jurisdiction objects to the lead agency determination, and the dispute cannot be resolved by agreement, the agencies shall immediately petition CEP for a lead agency determination pursuant to WAC 12-10-260.

(4) Any agency receiving a lead agency determination to which it objects shall either resolve the dispute, withdraw its objection, or petition to CEP for a lead agency determination within fifteen days of receiving the determination.

(5) To make the lead agency determination, an acting agency must determine to the best of its ability the other agencies with jurisdiction over the proposal. This can be

done by requesting the information from a private applicant, or through consultation with the information centers established pursuant to RCW 90.62.120, within the Environmental Coordination Procedures Act of 1973 (ECPA).

[Order 77-1, § 12-10-203, filed 8/22/77.]

WAC 12-10-205 Lead agency designation—Governmental proposals. The lead agency for all proposals initiated by an agency shall be the agency making the proposal. In the event that two or more agencies share in the implementation of a proposal, the agencies shall by agreement determine which agency will assume the status of lead agency. For the purposes of this section, a proposal by an agency does not include proposals to license private activity.

[Order 77-1, § 12-10-205, filed 8/22/77.]

WAC 12-10-210 Lead agency designation—Proposals involving both private and public construction activity. When the total proposal will involve both private and public construction activity, it shall be characterized as either a private or a public project for the purposes of lead agency designation, depending upon whether the primary sponsor or initiator of the project is an agency or from the private sector. Any project in which agency and private interests are too intertwined to make this characterization shall be considered a public project. The lead agency for all public projects shall be determined pursuant to WAC 12-10-205.

[Order 77-1, § 12-10-210, filed 8/22/77.]

WAC 12-10-215 Lead agency designation—Private projects for which there is only one agency with jurisdiction. For proposed private projects for which there is only one agency with jurisdiction, the lead agency shall be the agency with jurisdiction.

[Order 77-1, § 12-10-215, filed 8/22/77.]

WAC 12-10-230 Lead agency designation—Specific proposals. Notwithstanding the lead agency designation criteria contained in WAC 12-10-205 through 12-10-225, the lead agency for proposals within the areas listed below shall be as follows:

(1) For all governmental actions relating to thermal power plants for which certification is required under chapter 80.50 RCW, the lead agency shall be the thermal power plant site evaluation council: *Provided*, That for any public project requiring such certification and for which the study authorized by RCW 80.50.175 will not be made, the lead agency shall be the agency initiating the project.

(2) For all private projects relating to the utilization of geothermal resources subject to chapter 79.76 RCW, the lead agency shall be the department of natural resources.

(3) For all private projects requiring a license or other approval from the oil and gas conservation committee pursuant to chapter 78.52 RCW, the lead agency shall

be the department of natural resources, except that for projects subject to RCW 78.52.125, the EIS shall be prepared in accordance with that section.

(4) For all private activity requiring a license or approval under the Forest Practices Act of 1974, chapter 76.04 RCW, the lead agency shall be the department of natural resources: *Provided*, That for any proposal which will require a license from a county/city acting under the powers enumerated in RCW 76.09.240, the lead agency shall be the county/city requiring the license.

(5) For all private projects requiring a license or lease to use or affect state lands, the lead agency shall be the state agency managing the lands in question: *Provided*, That this subsection shall not apply to the sale or lease of state-owned tidelands, harbor areas or beds of navigable waters, when such sale or lease is incidental to a larger project for which one or more licenses from other state or local agencies is required.

(6) For all proposals which are being processed under the Environmental Coordination Procedures Act of 1973 (ECPA), chapter 90.62 RCW, the lead agency shall be determined by the department of ecology; except that when county/city licenses are applied for prior to filing the ECPA application, a lead agency shall be determined pursuant to the standards of these guidelines prior to granting such county/city licenses.

(7) For private projects which require the issuance of a National Pollutant Discharge Elimination System (NPDES) permit under section 402 of the Federal Water Pollution Control Act (33 U.S.C. section 1251, *et seq.*) for a pulp or paper mill or oil refinery, the lead agency shall be the department of ecology.

(8) For proposals to construct a pipeline greater than six inches in diameter and fifty miles in length, used for the transportation of crude petroleum or petroleum fuels or oil or derivatives thereof, or for the transportation of synthetic or natural gas under pressure, the lead agency shall be the department of ecology.

(9) For proposals that will result in an impoundment of water with a water surface in excess of forty acres, the lead agency shall be the department of ecology.

(10) For proposals to construct facilities on a single site designed for, or capable of, storing a total of one million or more gallons of any liquid fuel, the lead agency shall be the department of ecology.

(11) For proposals to construct any new oil refinery, or an expansion of an existing refinery that shall increase capacity by ten thousand barrels per day or more, the lead agency shall be the department of ecology.

(12) For proposals to construct any new metallic mineral processing plant, or to expand any such existing plant by ten percent or more of design capacity, the lead agency shall be the department of ecology.

[Order 77-1, § 12-10-230, filed 8/22/77.]

WAC 12-10-240 Agreements as to lead agency status. Nothing herein shall prohibit an agency from assuming the role of lead agency as a result of an agreement among all agencies with jurisdiction.

[Order 77-1, § 12-10-240, filed 8/22/77.]

WAC 12-10-245 Agreements between agencies as to division of lead agency duties. Two or more agencies may by agreement share or divide the responsibilities of lead agency through any arrangement agreed upon. In such event, however, the agencies involved shall designate one of them as the nominal lead agency, which shall be responsible for complying with the duties of the lead agency under these guidelines. Other agencies with jurisdiction shall be notified of the agreement and determination of the nominal lead agency.

[Order 77-1, § 12-10-245, filed 8/22/77.]

WAC 12-10-260 Dispute as to lead agency determination—Resolution by CEP. (1) In the event that the agencies with jurisdiction are unable to determine which agency is the lead agency under these guidelines, any agency with jurisdiction may petition CEP for such determination. Such petition shall clearly describe the proposal in question, and include a list of all licenses and approvals required for the proposal. Any such petition shall be filed with CEP within fifteen days after receipt by the petitioning agency of the determination to which it objects. Copies of the petition shall be mailed to any private applicant involved, as well as to all other agencies with jurisdiction over the proposal. The applicant and agencies with jurisdiction may file with CEP a written response to the petition within ten days of the date of the initial filing.

(2) Within fifteen days of receipt of a petition, CEP shall make a written determination of the lead agency, which shall be mailed to the applicant and all agencies with jurisdiction. CEP shall make its determination in accordance with these guidelines; or in the event the guidelines do not control, the lead agency shall be the agency whose action, license, or licenses will have the greatest effect on the environment.

[Order 77-1, § 12-10-260, filed 8/22/77.]

WAC 12-10-270 Assumption of lead agency status by another agency with jurisdiction. When there has been an assumption of lead agency status by another agency with jurisdiction over a proposal, pursuant to WAC 12-10-345, the lead agency responsibilities regarding threshold determination procedures (WAC 12-10-300 through 12-10-390) transfer to the new lead agency.

[Order 77-1, § 12-10-270, filed 8/22/77.]

WAC 12-10-300 Threshold determination requirement. (1) Except as provided in subsection (2) hereof, a threshold determination shall be made for every proposal for a major action. The responsible official designated by the lead agency shall be responsible for making the threshold determination. Only the lead agency shall make a threshold determination, except when lead agency duties are shared or assumed pursuant to WAC 12-10-245 and 12-10-345, respectively.

(2) The threshold determination requirement of completion of an environmental checklist may be omitted, unless predraft consultation occurs, when:

(a) Both the responsible official and the sponsor (public or private) of a proposal agree that an EIS is required, or

(b) The sponsor of the proposal and the lead agency are the same entity and decides that an EIS is required.

(3) When the provisions of subsection (2) above have been utilized, compliance with requirements for use of the environmental checklist contained in WAC 12-10-305 through 12-10-390 may be disregarded.

[Order 77-1, § 12-10-300, filed 8/22/77.]

WAC 12-10-305 Recommended timing for threshold determination. In most cases the time required to complete a threshold determination should not exceed fifteen days. The initial review of a completed environmental checklist can usually be completed in a matter of hours. If further information is required to make the threshold determination, the time required will vary, depending upon the nature of the proposal and the information required. When a threshold determination is expected to require more than fifteen days to complete and a private applicant requests notification of the date when a threshold determination will be made, the lead agency shall transmit to the private applicant a written statement as to the expected date of decision.

[Order 77-1, § 12-10-305, filed 8/22/77.]

WAC 12-10-310 Threshold determination procedures—Environmental checklist. (1) An environmental checklist substantially in the form provided in WAC 12-10-365 shall be completed for any proposed major action before making the threshold determination. The proposal's proponent shall complete the checklist either alone or together with the lead agency. Explanations of every "yes" and "maybe" answer on the checklist shall be provided, and persons completing the checklist may provide explanations of "no" answers. Persons filling out an environmental checklist may make reference to studies or reports which are available to the agency to which the checklist is being submitted.

(2) An environmental checklist may be required by an acting agency receiving an application for a major action, or (if one has not been previously completed) shall be required by the lead agency prior to making the threshold determination.

(3) No environmental checklist or threshold determination is required for proposals that are exempted by WAC 12-10-170, 12-10-175 and 12-10-180.

[Order 77-1, § 12-10-310, filed 8/22/77.]

WAC 12-10-320 Threshold determination procedures—Initial review of environmental checklist. (1) The lead agency shall conduct an initial review of the environmental checklist for the proposal together with any supporting documentation. This initial review shall be made without requiring further information from the applicant. In making this initial review, the lead agency shall independently evaluate each item on the checklist and indicate thereon the results of this evaluation.

(2) After completing the initial review of the environmental checklist, the lead agency shall apply the criteria of WAC 12-10-060 and 12-10-360 to the checklist as evaluated by the lead agency. This process will lead to one of three determinations:

(a) The proposal will not have a significant adverse impact upon the quality of the environment; in which case, the lead agency shall initiate the negative threshold determination procedures of WAC 12-10-340; or,

(b) The proposal will have a significant adverse impact upon the quality of the environment; in which case the lead agency shall initiate the EIS preparation procedures of WAC 12-10-350 and 12-10-400 through 12-10-695; or,

(c) There is not sufficient information available to the lead agency to enable it to reasonably make a determination of the environmental significance of the proposal; in which case the lead agency shall implement one or more of the information gathering mechanisms in WAC 12-10-330.

[Order 77-1, § 12-10-320, filed 8/22/77.]

WAC 12-10-330 Threshold determination procedures--Information in addition to checklist. (1) The threshold determination by the lead agency must be based upon information reasonably sufficient to determine the environmental impact of a proposal. In the event that the lead agency determines the information available to it is not reasonably sufficient to make this determination, one or more of the following may be initiated:

(a) The applicant may be required to furnish further information. This additional information shall be limited to those categories on the environmental checklist. An applicant may be required to provide explanations of any "no" answers to questions on the checklist.

(b) The lead agency may initiate further studies, including physical investigations on the subject property, directed toward providing additional information on the environmental impacts of the proposal.

(c) The lead agency may consult with other agencies with jurisdiction over the proposal, requesting substantive information as to potential environmental impacts of the proposal which lie within the area of expertise of the particular agency so consulted. Agencies so consulted shall respond in accordance with the requirements of WAC 12-10-500 through 12-10-540.

(2) When, during the course of collecting further information on a proposal, the lead agency obtains information reasonably sufficient to assess the adverse environmental impacts of the proposal, it shall immediately make the threshold determination utilizing the criteria of WAC 12-10-360 and 12-10-365. In the event that the further investigations authorized by this section do not provide information reasonably sufficient to assess any potential adverse environmental impacts of the proposal, an EIS shall be prepared.

[Order 77-1, § 12-10-330, filed 8/22/77.]

WAC 12-10-340 Threshold determination procedures--Negative declarations. (1) In the event the lead

agency determines a proposal will not have a significant adverse impact on the quality of the environment, it shall prepare a proposed or final declaration of nonsignificance, as appropriate, substantially in the form provided in WAC 12-10-355.

(2) The lead agency shall prepare a final declaration of nonsignificance for all proposals except for those listed in subsection (3) below.

(3) A lead agency making a threshold determination of nonsignificance for any of the following proposals shall prepare a proposed declaration of nonsignificance, and comply with the requirements of subsection (4) through (6) below prior to taking any further action on the proposal:

(a) Proposals for which there is another agency with jurisdiction.

(b) Proposals involving demolition of any structure or facility not exempted by WAC 12-10-170 (1)(n) or 12-10-180.

(c) Proposals involving issuance of clearing or grading permits not exempted by WAC 12-10-170, 12-10-175 or 12-10-180.

(4) The lead agency shall list all proposed declarations of nonsignificance in the "Proposed declaration of nonsignificance register" at its SEPA public information center. All such declarations shall be attached to the environmental checklist as evaluated by the lead agency and transmitted to any other agencies with jurisdiction and to the SEPA public information center of the lead agency.

(5) Any person or agency may submit written comments on the proposed declaration of nonsignificance to the lead agency within fifteen days from the date of its listing in the register. The lead agency shall take no further action on the proposal which is the subject of the proposed declaration of nonsignificance for fifteen days from the date of its listing in the register. If comments are received, the lead agency shall reconsider its proposed declaration in light thereof; however, the lead agency is not required to modify its proposed declaration of nonsignificance to reflect the comments received thereon.

(6) After the fifteen day time period has elapsed, and after considering any comments, the lead agency shall either adopt its proposed declaration as a "Final declaration of nonsignificance," or determine that the proposal is significant, or utilize the additional information gathering mechanisms of WAC 12-10-330(1).

(7) Issuance of proposed and final declarations of nonsignificance completes the procedural requirements of these guidelines unless another agency with jurisdiction assumes lead agency duties and responsibilities pursuant to WAC 12-10-345.

[Order 77-1, § 12-10-340, filed 8/22/77.]

WAC 12-10-345 Assumption of lead agency status by another agency with jurisdiction over a proposal--Prerequisites, effect and form of notice. (1) Notwithstanding the lead agency determination criteria of WAC

12-10-200 through 12-10-260, an agency with jurisdiction over a proposal, upon review of a proposed declaration of nonsignificance, may transmit to the initial lead agency a completed "Notice of assumption of lead agency status." Such form of notice shall be substantially similar to that described in subsection (4) below. Assumption of lead agency status, if it is to occur, shall take place within fifteen days of the listing of the proposal in the "Proposed declaration of nonsignificance register" as provided for in WAC 12-10-340.

(2) An agency with jurisdiction over a proposal, prior to transmittal of the notice described in subsection (4) below and an attached declaration of significance, shall make a finding that an EIS is required for the proposal. This finding shall be based only upon information contained in the environmental checklist attached to the proposed declaration of nonsignificance transmitted by the lead agency and any other information possessed by the agency with jurisdiction relative to the matters contained in the environmental checklist.

(3) As a result of the transmittal of a completed form of the notice contained in subsection (4) below and attached declaration of significance, the consulted agency with jurisdiction shall become the "new" lead agency and shall begin preparation of a draft EIS. In addition, all other responsibilities and authority of a lead agency under this chapter shall be transferred to the new lead agency.

(4) The form of "Notice of assumption of lead agency status" is as follows:

FORM OF NOTICE OF ASSUMPTION OF LEAD AGENCY STATUS

Description of Proposal -----
Proponent -----
Location of Proposal -----
Initial Lead Agency -----
New Lead Agency -----

This proposal was determined by the initial lead agency to have no significant adverse impact upon the environment, according to the proposed declaration of nonsignificance dated ----- A review of the information relative to the environmental checklist has been made by the new lead agency and in its opinion an EIS is required for the proposal. Consequently, notice is hereby given that the former consulted agency with jurisdiction assumes the responsibility of lead agency status from the initial lead agency, including, but not limited to, the duty to prepare a draft and final EIS on the proposal.

Responsible Official -----
Position/Title -----
Address/Phone -----
Date ----- Signature -----

(5) A completed form of notice, together with a declaration of significance, shall be transmitted to the initial lead agency, any other agencies with jurisdiction and the

proponent of the proposal. A copy of the notice shall be retained in the new lead agency's SEPA public information center.

(6) Agencies with jurisdiction may still comment critically upon a proposed declaration of nonsignificance without assuming lead agency status. No agency shall be deemed to have assumed lead agency status pursuant to this section unless a notice substantially in the form of subsection (4) hereof is completed and transmitted by that agency. The decision of any agency with jurisdiction to not assume lead agency status pursuant to this section shall create no new legal obligation upon that agency.

[Order 77-1, § 12-10-345, filed 8/22/77.]

WAC 12-10-350 Affirmative threshold determination. (1) In the event the lead agency determines that the proposal will have a significant adverse effect upon the quality of the environment, it shall prepare a declaration of significance using the form in WAC 12-10-355 which shall be retained in the files of the lead agency. The lead agency shall then list the proposal in the "EIS in preparation register" maintained at the SEPA public information center of the lead agency, and then begin the EIS preparation procedures of WAC 12-10-400 through 12-10-695.

(2) After the additional information gathering mechanisms of WAC 12-10-330 have been utilized, and when there exists a reasonable belief by the lead agency that the proposal could have a significant adverse impact, the procedure contained in subsection (1) above shall also be followed.

[Order 77-1, § 12-10-350, filed 8/22/77.]

WAC 12-10-355 Form of declaration of significance/nonsignificance. (1) A declaration substantially in the form set forth in subsection (2) of this section shall be used for all declarations of significance and proposed and final declarations of nonsignificance. This form shall be attached to the environmental checklist together with any other information obtained pursuant to WAC 12-10-330, and maintained in the files of the lead agency. The form without the attachments shall also be retained in the SEPA public information center of the lead agency for one year after issuance.

(2) The form is as follows:

FORM FOR (PROPOSED/FINAL) DECLARATION OF (SIGNIFICANCE/NONSIGNIFICANCE)

Description of Proposal -----
Proponent -----
Location of Proposal -----
Lead Agency -----

This proposal has been determined to (have/not have) a significant adverse impact upon the environment. An EIS (is/is not) required under RCW 43.21C.030 (2)(c). This decision was made after review by the lead agency of a completed environmental checklist and other information on file with the lead agency.

Responsible Official -----
Position/Title -----
Date ----- Signature -----

(3) If the form is for a declaration of environmental significance, the lead agency may add to the information contained in subsection (2) of this section a listing of those environmental impacts which led to the declaration, together with a brief explanation of what measures, if any, could be taken to prevent or mitigate the environmental impacts of the proposal to such an extent that the lead agency would withdraw its declaration and issue a [proposed/final] declaration of nonsignificance.

[Order 77-1, § 12-10-355, filed 8/22/77.]

WAC 12-10-360 Threshold determination criteria-- Application of environmental checklist. (1) The lead agency shall apply the questions in the environmental checklist to the total proposal, including its indirect effects (see WAC 12-10-060), to determine whether the proposal will result in a significant adverse impact upon the quality of the environment. The threshold decision shall be based solely upon this process. The questions contained in the environmental checklist are exclusive, and factors not listed therein shall not be considered in the threshold determination.

(2) The questions in the environmental checklist are not weighted. It is probable there will be affirmative answers to several of these questions while the proposal would still not necessarily have a significant adverse impact; however, a single affirmative answer could indicate a significant adverse impact, depending upon the nature of the impact and location of the proposal. The nature of the existing environment is an important factor. The same project may have a significant adverse impact in one location, but not in another location. The absolute quantitative effects of the proposal are also important, and may result in a significant adverse impact regardless of the nature of the existing environment. The lead agency shall also be alert to the possibility that several marginal impacts when taken together will result in a significant adverse environmental impact. For some proposals, it may be impossible to forecast the environmental impacts with precision, often because some variables cannot be predicted. If, after the lead agency has utilized the additional information gathering mechanisms of WAC 12-10-330, the impacts of the proposal are still in doubt, and there exists a reasonable belief by the lead agency that the proposal could have a significant adverse impact, an EIS is required.

(3) It should also be remembered that proposals designed to improve the environment (such as sewage treatment plants or pollution control requirements) may also have adverse environmental impacts. The question at the threshold determination level is not whether the beneficial aspects of a proposal outweigh its adverse impacts, but rather if the proposal involves any significant adverse impacts upon the quality of the environment. If it does, an EIS is required. No test of balance shall be applied at the threshold determination level.

(4) Additional research or field investigations by either the lead agency or by the private applicant is required when the information available to the lead agency is not sufficient for it to make a determination of the potential adverse environmental impacts (see WAC 12-10-330). It is expected, however, that many proposals can be evaluated entirely through an office review (see WAC 12-10-320) of the environmental checklist, and that for other proposals, the majority of the questions in the environmental checklist may be answered in the same manner.

[Order 77-1, § 12-10-360, filed 8/22/77.]

WAC 12-10-365 Environmental checklist. (1) The form in subsection (2) hereof is the environmental checklist. Agencies may at their option revise the format of this form; however, the language of the questions shall not be changed. The questions appearing in the environmental checklist are exclusive, and considerations which do not appear in it or in WAC 12-10-360 shall not be used in making a threshold determination. This checklist does not supersede or void application forms required under any other federal or state statute or local ordinance, but rather is supplementary thereto.

(2) Environmental checklist form:

ENVIRONMENTAL CHECKLIST

Introduction: The State Environmental Policy Act of 1971, chapter 43.21C RCW, requires all state and local governmental agencies to consider environmental values both for their own actions and when licensing private proposals. The act also requires that an EIS be prepared for all major actions significantly affecting the quality of the environment. The purpose of this checklist is to help the agencies involved determine whether or not a proposal is such a major action.

Please answer the following questions as completely as you can with the information presently available to you. Where explanations of your answers are required, or where you believe an explanation would be helpful to government decision makers, include your explanation in the space provided, or use additional pages if necessary. You should include references to any reports or studies of which you are aware and which are relevant to the answers you provide. Complete answers to these questions now will help all agencies involved with your proposal to undertake the required environmental review without unnecessary delay.

The following questions apply to your total proposal, not just to the license for which you are currently applying or the proposal for which approval is sought. Your answers should include the impacts which will be caused by your proposal when it is completed, even though completion may not occur until sometime in the future. This will allow all of the agencies which will be involved to complete their environmental review now, without duplicating paperwork in the future.

Note: This is a standard form being used by all state and local agencies in the state of Washington for various types of proposals. Many of

the questions may not apply to your proposal. If a question does not apply, just answer it "no" and continue on to the next question.

ENVIRONMENTAL CHECKLIST FORM

I. BACKGROUND

- 1. Name of Proponent -----
- 2. Address and Phone Number of Proponent:

- 3. Date Checklist Submitted -----
- 4. Agency Requiring Checklist -----
- 5. Name of Proposal, if applicable:

- 6. Nature and Brief Description of the Proposal (including but not limited to its size, general design elements, and other factors that will give an accurate understanding of its scope and nature):

- 7. Location of Proposal (describe the physical setting of the proposal, as well as the extent of the land area affected by any environmental impacts, including any other information needed to give an accurate understanding of the environmental setting of the proposal):

- 8. Estimated Date for Completion of the Proposal:

- 9. List of all Permits, Licenses or Government Approvals Required for the Proposal (federal, state and local—including rezones):

- 10. Do you have any plans for future additions, expansion, or further activity related to or connected with this proposal? If yes, explain:

- 11. Do you know of any plans by others which may affect the property covered by your proposal? If yes, explain:

- 12. Attach any other application form that has been completed regarding the proposal; if none has been completed, but is expected to be filed at some future date, describe the nature of such application form:

II. ENVIRONMENTAL IMPACTS

(Explanations of all "yes" and "maybe" answers are required)

Yes Maybe No

- (1) **Earth.** Will the proposal result in:
 - (a) Unstable earth conditions or in changes in geologic substructures? --- --- ---
 - (b) Disruptions, displacements, compaction or overcovering of the soil? --- --- ---
 - (c) Change in topography or ground surface relief features? --- --- ---
 - (d) The destruction, covering or modification of any unique geologic or physical features? --- --- ---
 - (e) Any increase in wind or water erosion of soils, either on or off the site? --- --- ---
 - (f) Changes in deposition or erosion of beach sands, or changes in siltation, deposition or erosion which may modify the channel of a river or stream or the bed of the ocean or any bay, inlet or lake? --- --- ---

Explanation: -----

- (2) **Air.** Will the proposal result in:
 - (a) Air emissions or deterioration of ambient air quality? --- --- ---
 - (b) The creation of objectionable odors? --- --- ---
 - (c) Alteration of air movement, moisture or temperature, or any change in climate, either locally or regionally? --- --- ---

Explanation: -----

	Yes	Maybe	No
(3) Water. Will the proposal result in:			
(a) Changes in currents, or the course or direction of water movements, in either marine or fresh waters?	---	---	---
(b) Changes in absorption rates, drainage patterns, or the rate and amount of surface water runoff?	---	---	---
(c) Alterations to the course or flow of flood waters?	---	---	---
(d) Change in the amount of surface water in any water body?	---	---	---
(e) Discharge into surface waters, or in any alteration of surface water quality, including but not limited to temperature, dissolved oxygen or turbidity?	---	---	---
(f) Alteration of the direction or rate of flow of ground waters?	---	---	---
(g) Change in the quantity of ground waters, either through direct additions or withdrawals, or through interception of an aquifer by cuts or excavations?	---	---	---
(h) Deterioration in ground water quality, either through direct injection, or through the seepage of leachate, phosphates, detergents, waterborne virus or bacteria, or other substances into the ground waters?	---	---	---
(i) Reduction in the amount of water otherwise available for public water supplies?	---	---	---
Explanation: ----- -----			

	Yes	Maybe	No
(4) Flora. Will the proposal result in:			
(a) Change in the diversity of species, or numbers of any species of flora (including trees, shrubs, grass, crops, microflora and aquatic plants)?	---	---	---
(b) Reduction of the numbers of any unique, rare or endangered species of flora?	---	---	---
(c) Introduction of new species of flora into an area, or in a barrier to the normal replenishment of existing species?	---	---	---
(d) Reduction in acreage of any agricultural crop?	---	---	---
Explanation: ----- -----			
(5) Fauna. Will the proposal result in:			
(a) Changes in the diversity of species, or numbers of any species of fauna (birds, land animals including reptiles, fish and shellfish, benthic organisms, insects or microfauna)?	---	---	---
(b) Reduction of the numbers of any unique, rare or endangered species of fauna?	---	---	---
(c) Introduction of new species of fauna into an area, or result in a barrier to the migration or movement of fauna?	---	---	---
(d) Deterioration to existing fish or wildlife habitat?	---	---	---
Explanation: ----- -----			
(6) Noise. Will the proposal increase existing noise levels?	---	---	---
Explanation: ----- -----			

- | | Yes | Maybe | No |
|--|-----|-------|-----|
| (7) Light and Glare. Will the proposal produce new light or glare? | --- | --- | --- |
| Explanation: -----
----- | | | |
| (8) Land Use. Will the proposal result in the alteration of the present or planned land use of an area? | --- | --- | --- |
| Explanation: -----
----- | | | |
| (9) Natural Resources. Will the proposal result in: | | | |
| (a) Increase in the rate of use of any natural resources? | --- | --- | --- |
| (b) Depletion of any nonrenewable natural resource? | --- | --- | --- |
| Explanation: -----
----- | | | |
| (10) Risk of Upset. Does the proposal involve a risk of an explosion or the release of hazardous substances (including, but not limited to, oil, pesticides, chemicals or radiation) in the event of an accident or upset conditions? | --- | --- | --- |
| Explanation: -----
----- | | | |
| (11) Population. Will the proposal alter the location, distribution, density, or growth rate of the human population of an area? | --- | --- | --- |
| Explanation: -----
----- | | | |

- | | Yes | Maybe | No |
|---|-----|-------|-----|
| (12) Housing. Will the proposal affect existing housing, or create a demand for additional housing? | --- | --- | --- |
| Explanation: -----
----- | | | |
| (13) Transportation/Circulation. Will the proposal result in: | | | |
| (a) Generation of additional vehicular movement? | --- | --- | --- |
| (b) Effects on existing parking facilities, or demand for new parking? | --- | --- | --- |
| (c) Impact upon existing transportation systems? | --- | --- | --- |
| (d) Alterations to present patterns of circulation or movement of people and/or goods? | --- | --- | --- |
| (e) Alterations to waterborne, rail or air traffic? | --- | --- | --- |
| (f) Increase in traffic hazards to motor vehicles, bicyclists or pedestrians? | --- | --- | --- |
| Explanation: -----
----- | | | |
| (14) Public Services. Will the proposal have an effect upon, or result in a need for new or altered governmental services in any of the following areas: | | | |
| (a) Fire protection? | --- | --- | --- |
| (b) Police protection? | --- | --- | --- |
| (c) Schools? | --- | --- | --- |
| (d) Parks or other recreational facilities? | --- | --- | --- |
| (e) Maintenance of public facilities, including roads? | --- | --- | --- |
| (f) Other governmental services? | --- | --- | --- |
| Explanation: -----
----- | | | |

Yes Maybe No

Yes Maybe No

- (15) **Energy.** Will the proposal result in:
 - (a) Use of substantial amounts of fuel or energy? --- --- ---
 - (b) Demand upon existing sources of energy, or require the development of new sources of energy? --- --- ---

Explanation: -----

- (16) **Utilities.** Will the proposal result in a need for new systems, or alterations to the following utilities:
 - (a) Power or natural gas? --- --- ---
 - (b) Communications systems? --- --- ---
 - (c) Water? --- --- ---
 - (d) Sewer or septic tanks? --- --- ---
 - (e) Storm water drainage? --- --- ---
 - (f) Solid waste and disposal? --- --- ---

Explanation: -----

- (17) **Human Health.** Will the proposal result in the creation of any health hazard or potential health hazard (excluding mental health)? --- --- ---

Explanation: -----

- (18) **Aesthetics.** Will the proposal result in the obstruction of any scenic vista or view open to the public, or will the proposal result in the creation of an aesthetically offensive site open to public view? --- --- ---

Explanation: -----

- (19) **Recreation.** Will the proposal result in an impact upon the quality or quantity of existing recreational opportunities? --- --- ---

Explanation: -----

- (20) **Archeological/Historical.** Will the proposal result in an alteration of a significant archeological or historical site, structure, object or building? --- --- ---

Explanation: -----

III. SIGNATURE

I, the undersigned, state that to the best of my knowledge the above information is true and complete. It is understood that the lead agency may withdraw any declaration of nonsignificance that it might issue in reliance upon this checklist should there be any willful misrepresentation or willful lack of full disclosure on my part.

Proponent: -----

[Order 77-1, § 12-10-365, filed 8/22/77.]

WAC 12-10-370 Withdrawal of affirmative threshold determination. If at any time after the entry of a declaration of significance, the proponent modifies the proposal so that, in the judgment of the lead agency, all significant adverse environmental impacts resulting therefrom are eliminated, the declaration of significance shall be withdrawn and a declaration of nonsignificance entered instead. The lead agency shall also revise the registers at its SEPA public information center accordingly. If the proponent of a proposal is a private applicant, the proposal shall not be considered modified until all license applications for the proposal are revised to reflect the modification.

[Order 77-1, § 12-10-370, filed 8/22/77.]

WAC 12-10-375 Withdrawal of negative threshold determination. (1) Except after a nonexempt license has been issued for a private project, the lead agency may withdraw any proposed or final declaration of nonsignificance when new information becomes available to it indicating that the proposal may have significant adverse environmental impacts.

(2) The lead agency may withdraw any proposed or final declaration of nonsignificance at any time when:

- (a) The proposal has been modified after the threshold determination, and such modification may cause the proposed action to have significant adverse environmental impacts, or

(b) The negative threshold determination was procured by misrepresentation or lack of full disclosure by the proponent of the proposal.

(3) Whenever a negative threshold determination is withdrawn pursuant to this section, the lead agency shall immediately reevaluate the proposal and make a revised threshold determination pursuant to WAC 12-10-300 through 12-10-360.

(4) Whenever a final declaration of nonsignificance has been withdrawn for one of the reasons in subsection (2) hereof, and the lead agency upon reevaluation determines that the proposal will have significant adverse environmental impacts, agencies with jurisdiction shall initiate procedures to suspend, modify or revoke, as appropriate, any nonexempt licenses issued for the proposal until compliance with the procedures of these guidelines is met.

[Order 77-1, § 12-10-375, filed 8/22/77.]

WAC 12-10-390 Effect of threshold determination by lead agency. (1) Except as provided in subsection (2) below, a threshold determination by the lead agency is binding upon all agencies, and no agency shall repeat the threshold determination procedures for substantially the same proposal. This section shall not be construed to permit or prohibit judicial review of a threshold determination by a court, or quasi-judicial review of a threshold determination by an agency during an administrative hearing.

(2) An agency with jurisdiction over a proposal, upon receipt of a proposed declaration of nonsignificance from the lead agency, may complete and transmit a notice of assumption of lead agency status after meeting the requirements of WAC 12-10-345. As a result of compliance with WAC 12-10-345, the agency with jurisdiction has in effect reversed the decision of the initial lead agency regarding environmental insignificance and as the new lead agency, will be required to prepare a draft EIS and exercise the other responsibilities of a lead agency under these guidelines.

[Order 77-1, § 12-10-390, filed 8/22/77.]

WAC 12-10-400 Duty to begin preparation of a draft EIS. After compliance with WAC 12-10-350, relating to preparation of a declaration of significance and the listing of the proposal in the "EIS in preparation register," the lead agency shall prepare the draft and final EIS in compliance with WAC 12-10-410 through 12-10-695.

[Order 77-1, § 12-10-400, filed 8/22/77.]

WAC 12-10-405 Purpose and function of a draft EIS. (1) The principal purpose of the draft EIS document is to transmit information concerning a proposed governmental action and the alternatives to that action to public officials, project sponsors, and interested citizens. While the contents of a draft EIS may span a wide spectrum of issues, the focus of the document is upon the following:

(a) The assessment of the adverse impacts upon the environment which may result from the proposed action or its alternatives, and

(b) An analysis of measures which may be taken to mitigate or eliminate those adverse impacts.

(2) Another principal function to be served by the draft EIS process is to facilitate the transmittal to the lead agency from other governmental agencies and interested citizens substantive information concerning the adverse impacts upon the environment discussed inadequately or erroneously in the draft EIS. The draft EIS process also provides an opportunity for reviewers of the document to bring to the attention of the lead agency any issue of potential environmental concern which should be explored by the lead agency prior to the issuance of a final EIS.

[Order 77-1, § 12-10-405, filed 8/22/77.]

WAC 12-10-410 Predraft consultation procedures.

(1) Predraft consultation is consultation by the lead agency with another agency with jurisdiction or expertise prior to completion of the draft EIS. Predraft consultation with another agency on proposals for private projects shall only be initiated by the lead agency when requested by a private applicant participating in the preparation of the draft EIS. Predraft consultation with another agency on public proposals may be initiated at the option of the lead agency.

(2) Predraft consultation is commenced when the lead agency sends to the consulted agency a packet of the following material related to the proposal:

(a) Any application for licenses for the proposal in the possession of the lead agency.

(b) A copy of the environmental checklist required by WAC 12-10-310, as reviewed pursuant to WAC 12-10-320.

(c) Any information in addition to the checklist resulting from application of WAC 12-10-330.

(d) Any other information deemed relevant to the proposal by the lead agency such as:

(i) Prior EISs;

(ii) Portions of applicable plans or ordinances; or,

(iii) Prior scientific studies applicable to the site.

(3) Agencies so consulted will have forty-five days from receipt of the packet to respond in writing to the lead agency. The required contents of the consulted agency response are governed by WAC 12-10-500 through 12-10-540.

(4) The lead agency shall incorporate the relevant information received from other agencies during the predraft consultation stage into the draft EIS, by either summarizing the major findings which are contained in each of the consulted agency's responses or utilizing all of the data received. In the event the lead agency disagrees with any conclusion expressed in the information received from the consulted agency, the conclusion shall be set forth together with the position of the lead agency. The information required by this subsection may be placed wherever in the draft EIS the lead agency deems most appropriate. There is no requirement that

either the draft or final EIS include responses to pre-draft consultation in a separate "response" section.

[Order 77-1, § 12-10-410, filed 8/22/77.]

WAC 12-10-420 Preparation of EIS by persons outside the lead agency. (1) Preparation of the EIS is the responsibility of the lead agency, by or under the direction of its responsible official. No matter who participates in the preparation of the EIS, it is nevertheless the EIS of the responsible official of the lead agency. The responsible official, prior to distributing the draft EIS, shall be satisfied that it complies with the provisions of these guidelines and the guidelines of the lead agency.

(2) An EIS may be prepared by a private applicant or agent thereof, or by an outside consultant retained by either a private applicant or the lead agency. In such case, the responsible official within the lead agency shall assure that the EIS is prepared in a responsible manner and with appropriate methodology. The responsible official shall direct the areas of research and examination to be undertaken, as well as the organization of the resulting document.

(3) If a person other than the lead agency is preparing the EIS, the responsible official will coordinate any pre-draft consultation procedures so that the individual preparing the EIS immediately receives all substantive information submitted by consulted agencies. The responsible official shall also attempt to obtain any information needed by the person preparing the EIS which is on file with another agency or federal agency. The responsible official shall allow any private party preparing an EIS access to all public records of the lead agency which are relevant to the subject matter of the EIS, pursuant to chapter 42.17 RCW (Public Disclosure and Public Records Law; Initiative 276, 1973).

(4) Private applicants shall be encouraged to participate in the preparation of the EIS; however, the final authority over content shall be that of the responsible official. The commission may not require more information of a private applicant than allowed by this chapter, but may authorize a lesser degree of participation by a private applicant than allowed herein: *Provided*, That nothing herein shall be construed to prohibit an agency from charging any fee of an applicant which the agency is otherwise authorized to charge (see WAC 12-10-840).

(5) No private applicant shall be required to participate in the preparation of an EIS except when consistent with the guidelines of the lead agency. A private applicant may, however, volunteer to provide any information or effort desired, so long as the contents and organization of the resulting EIS are supervised and approved by the responsible official as required by this section.

(6) The provisions of this section apply to both the draft and final EIS.

[Order 77-1, § 12-10-420, filed 8/22/77.]

WAC 12-10-425 Organization and style of a draft EIS. (1) The required contents of a draft EIS for proposals of both a project and nonproject nature are set forth in WAC 12-10-440. The contents of a draft EIS

prepared pursuant to that section shall be organized as set forth in subsections (2) and (3) of this section.

(2) Each draft EIS shall begin with an introduction, table of contents, distribution list, summary, and a description of the proposed action. The information contained in each section shall conform to the applicable requirements set forth in WAC 12-10-440 (1) through (6). Organization variation is not permitted for these portions of the draft EIS.

(3) The organization and style of the remaining content of the EIS may be varied, at the option of the lead agency, from the format set forth in WAC 12-10-440 (7) through (14): *Provided*, That all of the subject matters required by WAC 12-10-440 shall be contained somewhere within the draft EIS.

(4) The lead agency that prepares a draft EIS should keep in mind that the purpose of a draft EIS is to aid decision makers in considering the significant environmental impacts of their decisions. This purpose is not served by EISs which are excessively detailed and overly technical. Clarity and conciseness of presentation are of crucial importance in ensuring that EISs prepared under these guidelines are considered and actually utilized in decision-making processes.

[Order 77-1, § 12-10-425, filed 8/22/77.]

WAC 12-10-440 Contents of a draft EIS. (1) The following subsections set forth the required contents of a draft EIS: *Provided*, That where an agency is preparing a draft EIS in order to satisfy the requirements of NEPA, as well as SEPA, and the regulations of the applicable federal agency require items in addition to that set forth below, then the contents of the draft EIS may be expanded as necessary to meet the requirements of that federal agency.

(2) **Introduction.** The following information shall be succinctly set forth at the beginning of the draft EIS:

(a) Action sponsor, and a brief (one or two sentence) description of the nature of the proposal and its location (street address, or nearest crossroads or cross-streets).

(b) Lead agency, responsible official, and the name and address of a contact person to whom comments, information and questions may be sent.

(c) Authors and principal contributors to the draft EIS and the nature or subject area of their contribution.

(d) List of all licenses which the proposal is known to require.

(e) Location of EIS background data.

(f) Cost to the public for a copy of the EIS pursuant to chapter 42.17 RCW.

(g) Date of issue of the draft EIS.

(h) Dates by which consulted agency and public comments must be received to be incorporated into the final EIS.

(3) **Table of contents.**

(4) **Distribution list.** The draft EIS shall include a list of the names of all agencies, federal agencies, organizations and persons to whom the draft EIS will be sent upon publication (see WAC 12-10-460).

(5) **Summary of the contents of the draft EIS.** Each draft EIS shall contain a summary of its contents as an

aid to the agency decision makers. The lead agency is to bear in mind that agencies other than the lead agency may be utilizing the EIS as an aid in decision making. Therefore, care should be taken to ensure that the scope of the summary and the EIS is sufficiently broad to be useful to those other agencies being requested to license or approve a proposal. The summary shall contain only a short restatement of the main points discussed in the EIS for each of the various subject areas. In the event impacts cannot be predicted with certainty, the reason for uncertainty together with the more likely possibilities should be concisely stated. In most cases it is expected that the summary will run two to five pages, but it shall not be more than ten pages. The summary shall include a brief description of the following:

(a) The proposal, including the purpose or objectives which are sought to be achieved by the sponsor.

(b) The direct and indirect impacts upon the environment which may result from the proposal.

(c) The alternatives considered, together with any variation in impacts which may result from each alternative.

(d) Measures which may be effectuated by the applicant, lead agency, or other agency with jurisdiction to mitigate or eliminate adverse impacts which may result from the proposal.

(e) Any remaining adverse impacts which cannot or will not be mitigated.

(6) **Description of the proposal.** The draft EIS shall include a description of the total proposal, including, but not limited to, the following:

(a) The name of the proposal and sponsors.

(b) The location of the project, or area affected by a nonproject action, including an address, if any, and a legal description: *Provided*, That where the legal description is by metes and bounds, or is excessively lengthy, a map, in lieu of a legal description, shall be included which enables a lay person to precisely understand the location of the proposal.

(c) Reference to the file numbers, if known, of any other agencies involved so the proposal's location may be identified with precision by the consulted agency.

(d) If the proposal involves phased construction over a period of time, the timing of each construction phase should be identified; and if it is anticipated that later phases of the proposal will require future environmental analyses, these should be identified.

(e) A description of the major physical and engineering aspects of the proposal. This description should be tailored to the environmental impacts later discussed, with those physical aspects of the proposal causing the greater impacts being given the more detailed description. Inclusion of detailed engineering drawings and technical data should normally be avoided. Material of this nature should be retained in agency files and supplied to consulted agencies upon request.

(f) A brief description of existing comprehensive land use plans and zoning regulations applicable to the proposal, and how the proposal is consistent and inconsistent with them.

(g) Within the general guidelines of this subsection, the lead agency has discretion to determine the content and level of detail appropriate to adequately describe the proposal.

(7) **Existing environmental conditions.** This section shall include the following:

(a) A general assessment of the existing environment, covering those areas of the environment listed in WAC 12-10-444.

(i) The level of detail used in presenting the existing environment should be proportionate to the impacts the proposal will have if approved.

(ii) Areas of the environment which are not relevant to the identified impacts need only be mentioned generally, or not at all.

(iii) Inventories of the species of flora and fauna present on the site should be avoided; rather, emphasis should be placed upon those species and habitats which may be significantly affected.

(iv) This subsection shall be brief, nontechnical, and easily understandable by lay persons, and provide the necessary background for understanding the proposal's impacts.

(b) Specific reference shall be made to those inventories and data studies which provided the informational source for part or all of the contents of this subsection.

(8) **The impact of the proposal on the environment.** The following items shall be included in this subsection:

(a) The known impacts resulting from the proposal within any element of the environment listed in WAC 12-10-444, the effects of which are either known to be, or which may be significant (whether beneficial or adverse), shall be discussed in detail; impacts which are potential, but not certain to occur, shall be discussed within reason.

(b) Elements of the environment which will not be significantly affected shall be marked "N/A" (not applicable) as set forth in WAC 12-10-444(1).

(c) Direct and indirect impacts of the total proposal, as described in subsection (8)(a) above shall be examined and discussed (for example, cumulative and growth-inducing impacts).

(d) The possibility that effects upon different elements of the environment will interrelate to form significant impacts shall be considered.

(9) **The relationship between local short-term uses of man's environment and maintenance and enhancement of long-term productivity.** The following items shall be included in this subsection:

(a) An identification of the extent to which the proposal involves trade-offs between short-term gains at the expense of long-term environmental losses.

(i) The phrases "short-term" and "long-term" do not refer to any fixed time periods, but rather are to be viewed in terms of the significant environmental impacts of the proposal.

(ii) Impacts which will narrow the range and degree of beneficial uses of the environment or pose long-term risks to human health shall be given special attention.

(b) A discussion of the benefits and disadvantages of reserving for some future time the implementation of the

proposal, as opposed to possible approval of the proposal at this time.

(i) The agency perspective should be that each generation is, in effect, a trustee of the environment for succeeding generations.

(ii) Particular attention should be given to the possibility of foreclosing future options or alternatives by implementation of the proposal.

(10) **Irreversible or irretrievable commitments of resources.** The following items shall be included in this subsection:

(a) An identification of all substantial quantities of natural resources, including sources of energy and non-renewable materials, which will be committed by the proposal on a permanent or long-term basis. Commitment of natural resources also includes the lost opportunities to make other uses of the resources in question.

(b) This subsection may be integrated with subsection (9) above in order to more usefully present the information required by both sections.

(11) **Adverse environmental impacts which may be mitigated.** The following items shall be included in this subsection:

(a) A description of reasonable alterations to the proposal which may result in avoiding, mitigating or reducing the risk of occurrence of any adverse impacts upon the environment.

(b) Energy conservation measures, including more efficient utilization of conventional techniques (e.g., insulation) as well as newer methods.

(c) Each alternative discussed in (a) and (b) above shall be evaluated in terms of its effect upon the environment, its technical feasibility, and its economic practicability.

(12) **Alternatives to the proposal.** This subsection shall include the following items:

(a) A description and objective evaluation of any reasonable alternative action which could feasibly attain the objective of the proposal.

(i) Reasonable alternatives shall include any action which might approximate the proposal's objective, but at a lower environmental cost or decreased level of environmental degradation.

(ii) Reasonable alternatives may be those which are capable of being effected by either the lead agency or other agency having jurisdiction.

(b) The "no-action" alternative shall be evaluated and compared to the other alternatives.

(c) The adverse environmental effects of each alternative shall be identified.

(d) The analysis of alternatives should be sufficiently detailed to permit a comparative evaluation of each alternative and the proposal as described in subsection (6) of this section.

(e) In those instances where the proposal is for a private project on a specific site, the alternatives considered shall be limited to the "no-action" alternative plus other reasonable alternative means of achieving the objective of the proposal on the same site or other sites owned or controlled by the same proponent (which may include only alterations for mitigation under subsection (11) of

this section). This limitation shall not apply when the project proponent is applying for a rezone or contract rezone.

(f) Subsection (12) may be integrated with subsection (11) of this section in order to more usefully present the information required by both subsections.

(g) The use of the term "reasonable" is intended to limit both the number and range of alternatives that shall be described and evaluated in this subsection, as well as the amount or level of detail which the EIS shall employ for each alternative that is discussed and evaluated.

(13) **Unavoidable adverse impacts.** This subsection shall include the following items:

(a) A listing of those impacts included in subsection (8) of this section which are adverse but cannot, or will not, be mitigated or avoided by modifications to the project.

(b) For any impact discussed in subsection (8) of this section which is determined to be nonadverse, the rationale for such determination shall be clearly stated.

(c) (Optional) A discussion of the relationship between the costs of the unavoidable adverse environmental impacts and the expected beneficial environmental impacts which will result from the implementation of the proposed action.

(14) **Other issues.** A draft EIS may contain a section labeled "other issues" within which those other problems and issues not pertaining to any element listed in WAC 12-10-444, but which are relevant to the proposal, shall be identified. The section shall be limited to a brief identification of such problems or issues. The lead agency may adopt guidelines that delineate the problems or issues identified under this subsection. (See WAC 12-10-446.)

[Order 77-1, § 12-10-440, filed 8/22/77.]

WAC 12-10-442 Special considerations regarding contents of an EIS on a nonproject action. (1) The requirements of WAC 12-10-440 apply to the contents of a draft EIS on a proposal for a nonproject action. Lead agencies, however, have greater flexibility in their approach to achieving compliance with the requirements of WAC 12-10-440 in writing and EIS for nonproject actions, because normally less specific details are known about the proposal and any implementing projects, as well as the anticipated impacts on the environment.

(2) The lead agency should be alert to the fact that it is in the development and review of proposals for nonproject actions where the range of alternatives is typically more broad than that of a proposal for a project action (which is often narrowed to a specific location and design). The proposal should be described in a manner which encourages consideration of a number of alternative methods of accomplishing its objective. For example, an objective of an agency's proposal should be stated as "the facilitation of the movement of people from point A to point B" rather than "the widening of an urban arterial in order to accommodate additional privately-owned passenger vehicles."

[Order 77-1, § 12-10-442, filed 8/22/77.]

WAC 12-10-444 List of elements of the environment. (1) Every EIS shall have appended to it a list of the elements of the environment in subsection (2), (3) and (4) of this section. The lead agency shall place "N/A" ("not applicable") next to an item when the proposal, including its indirect impacts, will not significantly affect the area (or subarea) of the environment in question. Items marked "N/A" need not be mentioned in the body of the EIS. Subsections (2) and (3) of this section correspond in subject matter to the questions contained in the environmental checklist used for threshold determination, and the questions in the checklist may be used to interpret this outline listing.

(2) ELEMENTS OF THE PHYSICAL ENVIRONMENT.

(a) Earth.

- (i) Geology.
- (ii) Soils.
- (iii) Topography.
- (iv) Unique physical features.
- (v) Erosion.
- (vi) Accretion/avulsion.

(b) Air.

- (i) Air quality.
- (ii) Odor.
- (iii) Climate.

(c) Water.

- (i) Surface water movement.
- (ii) Runoff/absorption.
- (iii) Floods.
- (iv) Surface water quantity.
- (v) Surface water quality.
- (vi) Ground water movement.
- (vii) Ground water quantity.
- (viii) Ground water quality.
- (ix) Public water supplies.

(d) Flora.

- (i) Numbers or diversity of species.
- (ii) Unique species.
- (iii) Barriers and/or corridors.
- (iv) Agricultural crops.

(e) Fauna.

- (i) Numbers or diversity of species.
- (ii) Unique species.
- (iii) Barriers and/or corridors.
- (iv) Fish or wildlife habitat.

(f) Noise.

(g) Light and glare.

(h) Land use.

(i) Natural resources.

- (i) Rate of use.
- (ii) Nonrenewable resources.

(j) Risk of explosion or hazardous emissions.

(3) ELEMENTS OF THE HUMAN ENVIRONMENT

(a) Population.

(b) Housing.

(c) Transportation/circulation.

- (i) Vehicular transportation generated.
- (ii) Parking facilities.
- (iii) Transportation systems.

- (iv) Movement/circulation of people or goods.
- (v) Waterborne, rail and air traffic.
- (vi) Traffic hazards.

(d) Public services.

- (i) Fire.
- (ii) Police.
- (iii) Schools.
- (iv) Parks or other recreational facilities.
- (v) Maintenance.
- (vi) Other governmental services.

(e) Energy.

- (i) Amount required.
- (ii) Source/availability.

(f) Utilities.

- (i) Energy.
- (ii) Communications.
- (iii) Water.
- (iv) Sewer.
- (v) Storm water.
- (vi) Solid waste.

(g) Human health (including mental health).

(h) Aesthetics.

(i) Recreation.

(j) Archaeological/historical.

(4) The following additional element shall be covered in all EISs, either by being discussed or marked "N/A," but shall not be considered part of the environment for other purposes:

(a) Additional population characteristics.

- (i) Distribution by age, sex and ethnic characteristics of the residents in the geographical area affected by the environmental impacts of the proposal.

[Order 77-1, § 12-10-444, filed 8/22/77.]

WAC 12-10-450 Public awareness of availability of draft EIS. (1) Upon publication of the draft EIS, the responsible official shall list the proposal in the lead agency's "EIS available register" maintained at the agency's SEPA public information center.

(2) The lead agency is encouraged, but not required, to use any reasonable method calculated to inform the public of the availability of the draft EIS and of the procedures for requesting a public hearing. Examples of such methods are publication of notice in a newspaper of general circulation in the county, city or general geographic area where the proposal is located; notifying private groups that are known to be interested in a certain proposal; contacting news media personnel and encouraging news coverage; and, placing notices in appropriate regional, neighborhood or ethnic periodicals.

[Order 77-1, § 12-10-450, filed 8/22/77.]

WAC 12-10-455 Circulation of the draft EIS--Review period. (1) A consulted agency shall have a maximum of thirty-five days from the date of listing of the proposal in the "EIS available register" in which to

review the draft and forward its comments and information with respect thereto to the lead agency. If a consulted agency with jurisdiction requires additional time to develop and complete new data on the proposal, a fifteen day extension may be granted by the lead agency. Extensions may not be granted for any other purpose.

(2) There shall be allowed a period of thirty-five days from the date of the listing of the proposal in the "EIS available register" for the public to forward to the lead agency any comments upon or substantive information related to the proposal and the draft EIS.

[Order 77-1, § 12-10-455, filed 8/22/77.]

WAC 12-10-460 Specific agencies to which draft EIS shall be sent. (1) A copy of each draft EIS shall be mailed no later than the day that it is listed in the "EIS available register" to the following:

- (a) The department of ecology.
- (b) Each federal agency having jurisdiction by law over a proposed action.
- (c) Each agency having jurisdiction by law over, or environmental expertise pertaining to a proposed action, as defined by WAC 12-10-040 and 12-10-465 (required by RCW 43.21C.030 (2)(d)).
- (d) Each city/county in which adverse environmental effects identified in the draft EIS may occur if the proposed action is implemented. (This subsection does not apply to draft EISs for nonproject actions.)
- (e) Each local agency or political subdivision which will be required to furnish additional public services as a result of implementation of the proposed action.
- (f) The applicable regional planning commission, regional clearinghouse, statewide clearinghouse, or area-wide council of government which has been designated to review and coordinate local governmental planning under the A-95 review process and other federal regulations and programs (see RCW 36.64.080, 35.63.070 and 36.70.070).
- (g) The lead agency's SEPA public information center.
- (h) (Optional) Any person, organization or governmental agency that has expressed an interest in the proposal, is known by the lead agency to have an interest in the type of proposal being considered, or receives governmental documents (e.g., local and regional libraries) may be sent a copy of the draft EIS.

(2) An agency that receives a copy of the draft EIS does not become a "consulted agency" under these guidelines due to that factor alone. (See WAC 12-10-040, 12-10-465, 12-10-510 and 12-10-520 for those provisions that define a consulted agency.)

[Order 77-1, § 12-10-460, filed 8/22/77.]

WAC 12-10-465 Agencies possessing environmental expertise. The following agencies shall be regarded as possessing special expertise relating to those categories of the environment under which they are listed:

(1) Air quality.

- (a) Department of ecology.
 - (b) Department of natural resources (only for burning in forest areas).
 - (c) Department of social and health services.
 - (d) Regional air pollution control authority or agency.
- (2) Water resources and water quality.**
- (a) Department of game.
 - (b) Department of ecology.
 - (c) Department of natural resources (state-owned tidelands, harbor areas or beds of navigable waters).
 - (d) Department of social and health services (public water supplies, sewer systems, shellfish habitats).
 - (e) Department of fisheries.
 - (f) Oceanographic commission (marine waters).
- (3) Fish and wildlife.**
- (a) Department of game.
 - (b) Department of fisheries.
 - (c) Oceanographic commission (marine waters).
- (4) Solid waste.**
- (a) Department of ecology.
 - (b) Department of fisheries (dredge spoils).
 - (c) Department of social and health services.
- (5) Noise.**
- (a) Department of ecology.
 - (b) Department of social and health services.
- (6) Hazardous substances (including radiation).**
- (a) Department of ecology.
 - (b) Department of social and health services.
 - (c) Department of agriculture (foods or pesticides).
 - (d) Department of fisheries (introduction into waters).
 - (e) Oceanographic commission (introduction into marine waters).
- (7) Natural resources development.**
- (a) Department of commerce and economic development.
 - (b) Department of ecology.
 - (c) Department of natural resources.
 - (d) Department of fisheries.
 - (e) Department of game.
 - (f) Oceanographic commission (related to marine waters).
- (8) Energy production, transmission and consumption.**
- (a) Department of commerce and economic development (office of nuclear energy development—nuclear).
 - (b) Department of ecology.
 - (c) Department of natural resources (geothermal, coal, uranium).
 - (d) State energy office.
 - (e) Thermal power plant site evaluation council (thermal power plants).
 - (f) Utilities and transportation commission.
- (9) Land use and management.**
- (a) Department of commerce and economic development.
 - (b) Department of ecology.

- (c) Department of fisheries (affecting surface or marine waters).
- (d) Department of natural resources (tidelands or state-owned or -managed lands).
- (e) Office of community development.
- (10) **Transportation.**
 - (a) Department of highways.
 - (b) Utilities and transportation commission.
 - (c) Oceanographic commission (water borne).
- (11) **Recreation.**
 - (a) Department of commerce and economic development.
 - (b) Department of game.
 - (c) Department of fisheries.
 - (d) Parks and recreation commission.
 - (e) Department of natural resources.
- (12) **Archaeological/historical.**
 - (a) Parks and recreation commission.
 - (b) Washington State University at Pullman (Washington archaeological research council).

[Order 77-1, § 12-10-465, filed 8/22/77.]

WAC 12-10-470 Cost to the public for reproduction of environmental documents. The lead agency shall make available a copy of any environmental document, in the manner provided by chapter 42.17 RCW, charging only those costs allowed therein and mailing costs: *Provided*, That no charge shall be levied for circulation of documents to other agencies which is required by these guidelines.

[Order 77-1, § 12-10-470, filed 8/22/77.]

WAC 12-10-480 Public hearing on a proposal--When required. (1) If a public hearing on the proposal is held pursuant to some other requirement of law, such hearing shall be open to consideration of the environmental impact of the proposal, together with any available environmental document.

(2) In all other cases a public hearing on the environmental impact of a proposal shall be held whenever one or more of the following situations occur:

(a) The lead agency determines, in its sole discretion, that a public hearing would assist the lead agency in meeting its responsibility to implement the purposes and goals of SEPA and these guidelines; or,

(b) When fifty or more persons residing within the jurisdiction of the lead agency, or who would be adversely affected by the environmental impact of the proposal, make written request to the lead agency within thirty-five days of the listing of the proposal in the "EIS available register"; or,

(c) When two or more agencies with jurisdiction over a proposal make written request to the lead agency within thirty-five days of the listing of the proposal in the "EIS available register."

(3) Whenever a public hearing is held under subsection (2) of this section, it shall occur no later than fifty-one days from the listing of the proposal in the "EIS available register" and no earlier than fifteen days from such date of listing.

[Title 12 WAC--p 30]

[Order 77-1, § 12-10-480, filed 8/22/77.]

WAC 12-10-485 Notice of public hearing on environmental impact of the proposal. (1) Notice of all public hearings to be held pursuant to WAC 12-10-480(2) shall be published in a newspaper of general circulation in the area where the project will be implemented. For nonproject actions the notice shall be published in the general area where the lead agency has its principal office. The notice shall be published no later than five days preceding the hearing. For nonproject proposals having regional or statewide applicability, copies of the notice shall be transmitted to the Olympia bureaus of the Associated Press and United Press International.

(2) A notation of the hearing date and location shall be entered in the "EIS available register" maintained at the lead agency's SEPA public information center.

[Order 77-1, § 12-10-485, filed 8/22/77.]

WAC 12-10-490 Public hearing on the proposal--Use of environmental documents. Whenever a public hearing is held on the environmental impact of a proposal, it shall be open to discussion of all environmental documents and any written comments which have been received by the lead agency prior to the hearing. A copy of the draft EIS shall be made available for public inspection at the public hearing.

[Order 77-1, § 12-10-490, filed 8/22/77.]

WAC 12-10-495 Preparation of amended or new draft EIS. (1) A lead agency shall prepare an amended or new draft EIS whenever it determines:

(a) That substantial changes have been made in the proposal, or significant new information concerning anticipated environmental impacts has become available subsequent to circulation of the initial draft EIS, and

(b) That circulation of a new draft EIS is necessary to provide further input and review on the proposal.

(2) In such event, the lead agency shall follow the provisions of WAC 12-10-450 through 12-10-490 for the amended or new draft EIS.

[Order 77-1, § 12-10-495, filed 8/22/77.]

WAC 12-10-500 Responsibilities of consulted agencies--Local agencies. Each local agency, when responding to a consultation request prior to a threshold determination, participating in predraft consultation, or reviewing a draft EIS, shall provide to the lead agency that substantive data, information, test results and other material which it possesses relevant to its area of jurisdiction, to the services it will provide, or to the impacts upon it associated with the proposal. Field investigations are not required of local consulted agencies. Local agencies are not required to transmit information which has been previously transmitted to the lead agency, or which is already reflected in the draft EIS.

[Order 77-1, § 12-10-500, filed 8/22/77.]

WAC 12-10-510 Responsibilities of consulted agencies--State agencies with jurisdiction. Each state agency

with jurisdiction, when responding to a consultation request prior to a threshold determination, participating in predraft consultation, or reviewing a draft EIS, shall immediately begin the research and, if necessary, field investigations which it would normally conduct in conjunction with whatever license it requires for a proposal; or, in the event no license is involved the agency with jurisdiction shall investigate the impacts of the activity it will undertake which gives it jurisdiction over a portion of the proposal. The end result of these investigations should be that each agency with jurisdiction will be able to transmit to the lead agency substantive information on those environmental impacts of the proposal which are within the scope of the license or activity of the agency with jurisdiction. An agency with jurisdiction, in its response to the lead agency, should also indicate which of the impacts it has discovered may be mitigated or avoided and how this might be accomplished, and describe those areas of environmental risks which remain after it has conducted the investigations that may have been required.

[Order 77-1, § 12-10-510, filed 8/22/77.]

WAC 12-10-520 Responsibilities of consulted agencies--State agencies with environmental expertise. (1) Each state agency participating in predraft consultation, or reviewing a draft EIS, lacking jurisdiction, but possessing environmental expertise pertaining to the impacts associated with a proposal (see WAC 12-10-465), when requested by the lead agency, shall provide to the lead agency that substantive data, information, test results or other material relevant to the proposal which the consulted agency then possesses relating to its area of special expertise.

(2) The consulted agency may at its option investigate, develop and transmit whatever additional information is necessary for the lead agency to meet its responsibilities under WAC 12-10-440 or 12-10-442.

[Order 77-1, § 12-10-520, filed 8/22/77.]

WAC 12-10-530 Responsibilities of consulted agencies--When predraft consultation has occurred. When a consulted agency has engaged in the predraft consultation procedures set forth in WAC 12-10-410, the scope and depth of its required review and comment upon the draft EIS is limited to those appropriate and relevant matters which were not contained in its previous response (such as when significant new information becomes available which was not available to the consulted agency during the predraft consultation stage).

[Order 77-1, § 12-10-530, filed 8/22/77.]

WAC 12-10-535 Cost of performance of consulted agency responsibilities. A consulted agency shall not charge the lead agency for any costs incurred in complying with WAC 12-10-500 through 12-10-540, including, but not limited to, such functions as providing relevant data to the lead agency and the reproduction of various documents that are transmitted to the lead agency. This section shall not prohibit a consulted

agency from charging those costs allowed by chapter 42.17 RCW, for the reproduction of any environmental document when the request for a copy of the document is from an agency other than the lead agency, or from an individual or private organization.

[Order 77-1, § 12-10-535, filed 8/22/77.]

WAC 12-10-540 Limitations on responses to consultation. In those instances where part or all of the relevant data possessed by any consulted agency is either voluminous in nature, extremely bulky or otherwise incapable of ready transmittal to the lead agency, or consists of a report or document published by another agency, or represents a standard text or other work obtainable at a public library, such data or information may be clearly identified or cited by the consulted agency in its comments to the lead agency and the data itself need not be transmitted. When the consulted agency identifies relevant data, files or other material pursuant to this section, it shall describe briefly the nature of such information and clearly indicate its relevance to the environmental analysis of the proposed action in question. If the details of the proposal supplied with the consultation request are not sufficient to allow a complete response, the consulted agency shall be required to transmit only that information it is capable of developing from the material sent to it with the consultation request.

[Order 77-1, § 12-10-540, filed 8/22/77.]

WAC 12-10-545 Effect of no written comment. If a consulted agency does not respond with written comments within thirty-five days of the date of listing of the draft EIS in the "EIS available register," or fails to respond within the fifteen-day extension period which may have been granted by the lead agency, the lead agency may assume that the consulted agency has no information relating to the potential impact of the proposal upon the subject area of the consulted agency's jurisdiction or special expertise. Any consulted agency which fails to submit substantive information to the lead agency in response to a draft EIS is thereafter barred from alleging any defects in the lead agency's compliance with WAC 12-10-400 through 12-10-495, or with the contents of the final EIS.

[Order 77-1, § 12-10-545, filed 8/22/77.]

WAC 12-10-550 Preparation of the final EIS--Time period allowed. The lead agency shall prepare a final EIS within seventy-five days of the listing of the proposal in the "EIS available register." The lead agency may extend the time period whenever the proposal is unusually large in scope, or the environmental impact associated with the proposal is unusually complex.

[Order 77-1, § 12-10-550, filed 8/22/77.]

WAC 12-10-570 Preparation of the final EIS--Contents--When no critical comments received on the draft EIS. (1) If the lead agency does not receive any

comments critical of the scope or content of the draft EIS, the lead agency may prepare a statement to the effect that no critical comments were received and circulate that statement in the manner prescribed in WAC 12-10-600.

(2) The statement prepared and circulated pursuant to subsection (1) above, together with the draft EIS (which is not recirculated with the statement), shall constitute the "final EIS" for the proposal: *Provided*, That when the draft EIS was not circulated to the office of the governor or the ecological commission, then the draft EIS shall be attached only to the statement sent to these agencies.

[Order 77-1, § 12-10-570, filed 8/22/77.]

WAC 12-10-580 Preparation of the final EIS—Contents—When critical comments received on the draft EIS. (1) When the lead agency receives any comments critical of the scope or content of the draft EIS, whether made in writing or made orally at any public hearing on the environmental impact of the proposal, it shall comply with either subsection (2) or (3) below.

(2) The lead agency may determine that no changes are required in either the draft EIS or the proposal, despite the critical comments that were received during the commenting period. The lead agency must prepare a document containing a general response to the comments that were received, the text or summary of written comments, and a summary of the oral comments made by the public at any hearing held on the proposal or its environmental impacts. The lead agency shall then circulate the document in the manner prescribed in WAC 12-10-600: *Provided*, That when the draft EIS was not circulated to the office of the governor or the ecological commission, then the draft EIS shall be attached only to the statement sent to these agencies.

(3) The lead agency may determine that it is necessary and appropriate to rewrite the contents of the draft EIS in order to respond to critical comments received during the commenting period. In such instances, the lead agency shall circulate the rewritten EIS in the manner specified in WAC 12-10-600. The lead agency shall ensure that the rewritten EIS evidences an affirmative response by the lead agency to the critical comments, or alternatively, contains a summary of those critical comments with which it does not agree.

(4) A document prepared and circulated pursuant to subsection (2) or (3) above shall constitute the "final EIS" for the proposal.

[Order 77-1, § 12-10-580, filed 8/22/77.]

WAC 12-10-600 Circulation of the final EIS. The final EIS shall be circulated to the department of ecology, office of the governor or the governor's designee, the ecological commission, the lead agency's SEPA public information center, agencies with jurisdiction, and federal agencies with jurisdiction which received the draft EIS. It shall be made available to the public in the same manner and cost as the draft EIS.

[Order 77-1, § 12-10-600, filed 8/22/77.]

WAC 12-10-650 Effect of an adequate final EIS prepared pursuant to NEPA. (1) The requirements of this chapter relating to the preparation of an EIS shall not apply when an adequate final EIS has been prepared pursuant to the National Environmental Policy Act of 1969 (NEPA), in which event such EIS may be utilized in lieu of a final EIS separately prepared under SEPA.

(2) The final EIS of a federal agency shall be adequate unless:

(a) A court rules that it is inadequate; or,

(b) The administrator of the United States Environmental Protection Agency issues a written comment pursuant to the Federal Clean Air Act, 42 U.S.C. § 1857, which determines it to be inadequate; or,

(c) The environmental elements of WAC 12-10-444, when applied locally, are not adequately treated in it.

(3) If, after review thereof, the lead agency determines that the federal EIS is adequate, it shall be listed in the "EIS available register" in the SEPA public information center.

(4) A public hearing on the sole issue of the adequacy of the content of a federal EIS shall be held if, within thirty-five days of its listing in the register, at least fifty persons who reside within the jurisdiction of the lead agency, or are adversely affected by the environmental impact of the proposal, make written request therefor. The lead agency shall reconsider its determination of adequacy in view of comments received at any such public hearing.

[Order 77-1, § 12-10-650, filed 8/22/77.]

WAC 12-10-652 Supplementation by a lead agency of an inadequate final NEPA EIS. When a final EIS prepared pursuant to NEPA is inadequate under the criteria set forth in WAC 12-10-650(2), then the lead agency shall either:

(1) Prepare a draft EIS independent of the final NEPA EIS or

(2) Modify or supplement the final NEPA EIS as necessary to prepare an adequate draft EIS.

[Order 77-1, § 12-10-652, filed 8/22/77.]

WAC 12-10-660 Use of previously prepared EIS for a different proposed action. (1) An agency may adopt and utilize a previously prepared EIS, or portion thereof, to satisfy certain of the EIS requirements applicable to a different proposed action, as set forth in (2) and (3) below. In such event, two requirements shall be met:

(a) The previous EIS or portion thereof, together with any supplement to it, shall meet the requirements of these guidelines applicable to an EIS for the new proposed action, and

(b) A previous EIS shall not be used without an explanatory supplement where any intervening change in conditions would make the previous EIS misleading when applied to the new proposed action.

(2) When the new proposed action will have an impact on the environment that was not adequately analyzed in the previously prepared EIS, the lead agency shall prepare a draft supplemental EIS and comply with the provisions of WAC 12-10-400 through 12-10-695.

The contents of the draft and final supplemental EIS shall be limited to those impacts of the proposed action which were not adequately analyzed in the earlier EIS.

(3) When the new proposed action will not have an impact on the environment that is substantially different than the impacts of the earlier proposed action, the lead agency may prepare a written statement setting forth its determination under this subsection and list the proposal in the "EIS available register." The lead agency shall not be required to prepare a new or supplemental draft or final EIS on the new proposed action when this subsection is determined to apply. The provisions of WAC 12-10-480 through 12-10-490, relating to a public hearing on the environmental impact of a proposal shall apply, however, to proposed actions determined to be under the provisions of this subsection.

[Order 77-1, § 12-10-660, filed 8/22/77.]

WAC 12-10-690 Use of lead agency's EIS by other acting agencies for the same proposal. (1) When an agency is considering an action which is identified as part of a proposal covered by a final EIS of a lead agency, and the agency now considering the action was consulted as an agency with jurisdiction during the consultation process on the previous EIS because of the action it is now considering, such agency must utilize the previous EIS unchanged when it is considering its present action except under the conditions of subsection (2) hereof.

(2) An agency with jurisdiction shall review and consider supplementing an EIS prepared by the lead agency only if:

(a) The proposal has been significantly modified since the lead agency prepared the EIS; or,

(b) The action now being considered was identified in the lead agency's EIS as one which would require further environmental evaluation; or,

(c) The level of design or planning for the proposal has become more detailed, revealing inadequately analyzed impacts; or,

(d) Technical data has become available which indicates the presence of a significant adverse environmental impact.

In such cases, the acting agency shall prepare a supplement to the lead agency's EIS if, and only if, it determines that significant adverse environmental impacts have been inadequately analyzed in the lead agency's EIS.

(3) If an agency is not listed as a licensing agency in the draft EIS pursuant to WAC 12-10-440 (2)(d) and did not receive a copy of the draft EIS, such agency shall not be limited by the contents of the earlier EIS in preparing its statement.

[Order 77-1, § 12-10-690, filed 8/22/77.]

WAC 12-10-695 Draft and final supplements to a revised EIS. (1) In any case where the lead agency is preparing a supplement to an earlier EIS or to an EIS prepared pursuant to NEPA, it shall prepare a draft supplemental EIS and comply with WAC 12-10-450.

(1990 Ed.)

Copies of both the prior and supplemental EIS shall be maintained at the SEPA public information center, and copies of the prior EIS, as well as the supplement, shall be transmitted to the consulted agencies which had not previously received it.

(2) Upon preparation of the draft supplemental EIS, the lead agency shall comply with WAC 12-10-550 through 12-10-580 and the final supplemental EIS, together with the earlier EIS, shall be regarded as a final EIS for all purposes of these guidelines.

[Order 77-1, § 12-10-695, filed 8/22/77.]

WAC 12-10-700 No action for seven days after publication of the final EIS. No agency shall take any major action (as defined in WAC 12-10-040(24)) on a proposal for which an EIS has been required, prior to seven days from the publication of the final EIS and its listing in the "EIS available register" maintained at the agency's SEPA public information center.

[Order 77-1, § 12-10-700, filed 8/22/77.]

WAC 12-10-710 EIS combined with existing planning and review processes. The EIS process shall be combined with the existing planning, review and project approval processes being used by each agency with jurisdiction by law over a proposal. When required to be prepared, the EIS, the declaration of nonsignificance, or the previously circulated EIS being utilized pursuant to WAC 12-10-660, shall accompany a proposal through the existing review processes.

[Order 77-1, § 12-10-710, filed 8/22/77.]

WAC 12-10-800 SEPA public information center. (1) The SEPA public information center for the commission shall be located at its offices at King County International Airport, 8600 Perimeter Road, Seattle, Washington 98108.

(2) The following documents shall be maintained at the commission's SEPA public information center:

(a) Copies of all declarations of nonsignificance filed by the commission, for a period of one year.

(b) Copies of all EISs prepared by the commission, for a period of three years. Draft EISs which have been superseded by a final EIS need not be maintained at the center.

(3) In addition, the commission shall maintain the following registers at its information center, each register including for each proposal its location, a brief (one sentence or phrase) description of the nature of the proposal, the date first listed on the register, and a contact person or office from which further information may be obtained:

(a) A "proposed declaration on nonsignificance register" which shall contain a listing of all current proposed declarations of nonsignificance.

(b) An "EIS in preparation register" which shall contain a listing of all proposals for which the commission is currently preparing an EIS, and the date by which the EIS is expected to be available.

[Title 12 WAC—p 33]

(c) An "EIS available register" which shall contain a listing of all draft and final EISs prepared by the commission during the previous six months, including thereon the date by which comments must be received on draft EISs, and the date for any public hearing scheduled for the proposal.

(4) Each of the registers required by subsection (3) hereof shall be kept current and maintained at the information center for public inspection. In addition, the registers, or updates thereof containing new entries added since the last mailing, shall be mailed once every two weeks to those organizations and individuals who make written request therefor, unless no new proposals are placed on the register, in which event a copy of the register or update shall be mailed when a new proposal is added. The commission may charge a periodic fee for the service of mailing the registers or updates, which shall be reasonably related to the costs of reproduction and mailing.

(5) The documents required to be maintained at the information center shall be available for public inspection, and copies thereof shall be provided upon written request. The commission may charge for copies in the manner provided by chapter 42.17 RCW, and for the cost of mailing.

[Order 77-1, § 12-10-800, filed 8/22/77.]

WAC 12-10-810 Responsibility of agencies--Amendments to this chapter. In the event that CEP or its successor agency adopts amendments to this chapter, state and local agencies shall adopt amendments of their own guidelines within one hundred twenty days and one hundred eighty days, respectively, to bring their guidelines into conformance with this chapter as amended.

[Order 77-1, § 12-10-810, filed 8/22/77.]

WAC 12-10-820 Responsibility of agencies--Procedures when consulted agency. The commission shall develop internal procedures for providing responses to consultation requests from other agencies pertaining to threshold investigations, predraft consultation, or draft EISs. Such procedures shall ensure that the agency will be able to comply with the requirements of WAC 12-10-500 through 12-10-540. Insofar as these procedures be integrated within existing procedures of investigating license applications when the consulted agency is also an acting agency.

[Order 77-1, § 12-10-820, filed 8/22/77.]

WAC 12-10-830 Application of agency guidelines to ongoing actions. (1) Agency guidelines shall apply to any proposed action when initiated subsequent to the effective date of the guidelines of the lead agency or the agency proposing the action.

(2) For proposals made prior to the effective date of the guidelines of the lead agency or the agency proposing the action, agency guidelines shall apply to those elements of SEPA compliance remaining to be undertaken subsequent to the effective date of such guidelines.

[Title 12 WAC—p 34]

Agency guidelines adopted pursuant to RCW 43.21C-.120 and the requirements of this chapter shall not be applied to invalidate or require modification of any threshold determination, EIS or other element of SEPA compliance undertaken or completed prior to the effective date of the guidelines of the lead agency or agency proposing the action.

[Order 77-1, § 12-10-830, filed 8/22/77.]

WAC 12-10-840 Fees to cover the costs of SEPA compliance. Except for the reproduction and mailing costs specifically allowed by this chapter, and the provisions of WAC 12-10-535, these guidelines neither authorize nor prohibit the imposition of fees to cover the costs of SEPA compliance.

[Order 77-1, § 12-10-840, filed 8/22/77.]

WAC 12-10-900 Severability. If any provision of this chapter or its application to any person or circumstance is held invalid, the remainder of this chapter, or the application of the provision to other persons or circumstances, shall not be affected.

[Order 77-1, § 12-10-900, filed 8/22/77.]

Chapter 12-18 WAC PILOT REGISTRATION

WAC

12-18-001	Promulgation.
12-18-010	Pilot registration required.
12-18-020	Fees.
12-18-030	Possession of registration.
12-18-040	Seminars and clinics.
12-18-050	Unlicensed pilots.

WAC 12-18-001 Promulgation. Whereas, it is necessary for the purpose of protecting and insuring the general public interest, and developing and promoting aeronautics in this state to efficiently enforce the laws of the state of Washington relating to the registration of pilots; and

It is essential to the enforcement of such laws that regulations relating to their enforcement be promulgated:

It is hereby ordered under authority of RCW 47.68-.210 and by virtue of the regulatory powers vested in the Washington state transportation commission for and on behalf of the state of Washington that the following sections be implemented.

[Statutory Authority: RCW 47.68.233 and 47.68.236. 83-01-038 (Order 74), § 12-18-001, filed 12/13/82.]

WAC 12-18-010 Pilot registration required. A pilot who is a resident of this state or who regularly operates in this state shall register with the division of aeronautics prior to January 31st each year. A new resident shall register with the division of aeronautics within sixty days of becoming a resident pilot. This section shall not apply to those persons exempted by RCW 47.68.233. Student pilots shall register not later than the date of their first solo flight.

[Statutory Authority: RCW 47.68.233 and 47.68.236. 83-01-038 (Order 74), § 12-18-010, filed 12/13/82.]

WAC 12-18-020 Fees. A fee of \$3.00 per year shall be paid for each pilot registration prior to December 31, 1982. A fee of \$5.00 per year shall be paid for each pilot registration after December 31, 1982, without regard to the actual date of registration. Pilot registration fees will be deposited into the search and rescue, safety and education fund created under RCW 47.68.236.

[Statutory Authority: RCW 47.68.233 and 47.68.236. 83-01-038 (Order 74), § 12-18-020, filed 12/13/82.]

WAC 12-18-030 Possession of registration. A pilot who is required to register under this chapter shall carry such registration at all times while exercising the privileges of an airmans certificate issued by the Federal Aviation Administration, and shall present such registration when requested to any law enforcement officer, division of aeronautics personnel or any other person on reasonable demand.

[Statutory Authority: RCW 47.68.233 and 47.68.236. 83-01-038 (Order 74), § 12-18-030, filed 12/13/82.]

WAC 12-18-040 Seminars and clinics. The division of aeronautics may require all persons required by this chapter to register as pilots to show proof of registration as a prerequisite to attendance at any seminar or clinic sponsored or conducted by the division of aeronautics and funded by pilot registration fees.

Pilots participating in division of aeronautics flight instructor refresher clinics will be required to show proof of registration prior to receiving credit for the course.

[Statutory Authority: RCW 47.68.233 and 47.68.236. 83-01-038 (Order 74), § 12-18-040, filed 12/13/82.]

WAC 12-18-050 Unlicensed pilots. Pilots who do not possess a valid Federal Aviation Administration airmans certificate and who operate aircraft for which such certificate is not required are nevertheless required to register with the division of aeronautics.

[Statutory Authority: RCW 47.68.233 and 47.68.236. 83-01-038 (Order 74), § 12-18-050, filed 12/13/82.]

Chapter 12-19 WAC

AIRCRAFT--INDICIA OF REGISTRATION

WAC

12-19-010 Display of indicia of registration.

WAC 12-19-010 Display of indicia of registration.

(1) That every aircraft registered with the Washington state department of transportation shall prominently display an insignia or decal, to be provided by the Washington state department of transportation on the tail or fuselage of such aircraft, just above N number, or on the right rear window panel, as evidence of registration;

(2) That no aircraft which is not lawfully registered shall display such insignia or evidence of registration, or any other mark, number, decal or insignia which might

(1990 Ed.)

be reasonably believed to be evidence of state registration; and

(3) That failure to display such insignia shall be prima facie evidence that such aircraft is not registered.

[Statutory Authority: RCW 47.68.250. 88-01-089 (Order 112), § 12-19-010, filed 12/22/87.]

Chapter 12-20 WAC

COMMERCIAL AIRPORTS

WAC

12-20-050 Regulations for the prevention and control of fires and fire hazards of airports and heliports.

DISPOSITION OF SECTIONS FORMERLY CODIFIED IN THIS CHAPTER

12-20-010 through 12-20-040. [Regulation 3, filed 7/20/61.] Superseded by Regulation 3, filed 11/26/65.

WAC 12-20-050 Regulations for the prevention and control of fires and fire hazards of airports and heliports.

Reviser's note: On November 26, 1965, the Washington aeronautics commission filed with the code reviser's office the May 1962 edition of the N.F.P.A. Suggestions for Aircraft Rescue and Fire Fighting Services at Airports and Heliports #403, as Regulation No. 3 of their department to supersede previous regulation No. 3 which was codified as WAC 12-20-010 through 12-20-040.

By authority of RCW 34.04.050(3) the aforementioned pamphlet has been omitted from this code, but copies may be obtained from the Washington Aeronautics Commission office at the Civil Defense Building, Martin Way, Olympia, Washington.

Chapter 12-24 WAC

OBSTRUCTION MARKING AND LIGHTING

WAC

12-24-002 Foreword.
12-24-005 Introduction.

MARKING

12-24-025 General.
12-24-030 Marking of vehicles.
12-24-035 Marking of natural and manmade obstructions.
12-24-040 Flags.
12-24-045 Colors.
12-24-050 Marking overhead lines.

LIGHTING

12-24-105 General.
12-24-110 Special day lighting.
12-24-115 Temporary warning lights.
12-24-120 Operation of obstruction lighting.
12-24-125 Inspection of obstruction lighting.
12-24-130 Notification of light failure.
12-24-135 Color of lighting.
12-24-140 Light distribution.
12-24-145 Rated lamp voltage.
12-24-150 Flashing of lights.
12-24-155 Intensity of lighting.
12-24-160 Interference with railway signals.
12-24-165 Obstruction lighting by nonstandard lights.
12-24-170 Obstruction lighting equipment—Specifications and drawings.
12-24-175 Obstruction lighting standards—Towers, poles, and similar obstructions.
12-24-180 Obstruction lighting standards—Trees.
12-24-185 Obstruction lighting standards—Transmission lines.
12-24-190 Obstruction lighting standards—Smokestacks and similar obstructions.

12-24-195	Obstruction lighting standards—Prominent buildings and similar extensive obstructions.
12-24-200	Obstruction lighting standards—Bridges.
12-24-205	Obstruction lighting standards—Water towers, grain elevators, gas holders and similar obstructions.
12-24-210	Obstruction lighting standards—Group of structural hazards.
12-24-215	Obstruction lighting standards—Hazard areas.
APPENDIX	
12-24-350	Appendix rules—General.
12-24-360	Appendix rules—Criteria for determining obstructions to air navigation.
12-24-370	Appendix rules—Operation of moored balloons.
12-24-380	Appendix rules—Illustrations.

WAC 12-24-002 Foreword. (1) The purpose of this publication is to provide state, municipal governments, private industry and interested persons with important information and guidance in connection with the marking and lighting of natural and manmade objects which are, or may become, hazards to the safe operation of aircraft.

(2) Included in the text are the state standards prescribed for the marking and lighting of obstruction to air navigation.

(3) In the appendix (WAC 12-24-350 – 12-24-380) will be found the texts of laws and regulations regarding existing or proposed objects which may present hazards to aircraft operations, and also important information to provide guidance in complying with these texts of laws and regulations.

[Obstruction marking and lighting standards, foreword, filed 9/13/61.]

WAC 12-24-005 Introduction. (1) The Washington state aeronautics commission has the statutory responsibility of promoting safety in aeronautics and enforcing safety rules, regulations and standards. In the light of this responsibility, the Washington state aeronautics commission is vitally concerned with any object which may be a hazard to the safe operation of aircraft and the enforcement of state obstruction and marking law. Consequently, it has a primary responsibility in the determination of whether an existing or proposed object is, or will become, such a hazard.

(2) In order to provide uniform criteria to determine whether an object is, or will be, an obstruction to air navigation, the Washington state aeronautics commission has issued state standards for determining obstructions to air navigation. Natural or manmade objects or portions thereof, both temporary and permanent, which have been determined, through the application of these standards, to be obstructions and all manmade objects, or portions thereof, greater than 150 feet in over-all height above ground, or water if so situated, should be marked and/or lighted in accordance with the applicable standards hereinafter described, unless aeronautical study indicates that the absence of such marking and/or lighting will not impair safety in air navigation. Existing nonstandard obstruction marking and lighting installations should be replaced or modified so as to conform with these standards as soon as practicable.

(3) The standards for marking and lighting obstructions prescribed in this publication are designed to provide the most effective means of indicating the presence of obstructions to pilots. In many instances the obstruction may be so located in reference to other objects or the contour of the ground, that the specific standard need be applied to its upper part only. Similarly, the obstruction may be so removed from the general flow of air traffic or may be so conspicuous by its shape, size or color that obstruction marking would serve no useful purpose and would be unnecessary. Furthermore, the obstruction may present such a hazard that lighting should be provided similar to that for an obstruction of a greater height. Portions of obstructions that are shielded by surrounding objects need not be marked or lighted, but the surrounding objects should be marked and lighted.

(4) Because of the many influencing elements, the Washington state aeronautics commission may modify the obstruction marking and lighting standards hereinafter described when aeronautical study has indicated that a change or modification is necessary to provide adequate protection for aeronautics.

[O.M.&L. standards, introduction, filed 9/13/61.]

MARKING

WAC 12-24-025 General. (1) The purpose of marking an obstruction which presents a hazard to aeronautics is to warn airmen during the hours of daylight of the presence of such an obstruction. To accomplish this objective, it may be necessary to color such an obstruction so that it will be visible from aircraft at any normal angle of approach, or to indicate the general definition and location of the obstruction by use of suitable markers or flags.

(2) When the upper part of only a portion of a structure or similar extensive obstruction projects above an obstruction determining surface, as described in state standards, that portion only need be obstruction marked and the point or edge of it highest in relation to the obstruction determining surface should be regarded as the "top of the obstruction." In certain cases, however, such as when the obstruction determining surface concerned is an approach or transition surface (i.e., sloping) this point or edge highest in relation to the obstruction determining surface may not be the highest point or edge above a horizontal plane passing through the base of the object. In such cases, those portions of the object, the upper parts of which are higher above a horizontal plane passing through the base of the object than the upper part considered as the "top of the obstruction," should also be obstruction marked.

[O.M.&L. standards (part), filed 9/13/61.]

WAC 12-24-030 Marking of vehicles. Vehicles customarily used on landing areas should be marked in accordance with the provisions of F.A.A. technical

standard order TSO-N4, Army-Navy-Civil uniform requirements for the marking of vehicles used on landing areas.

[O.M.&L. standards (part), filed 9/13/61.]

WAC 12-24-035 Marking of natural and manmade obstructions. (1) Use of markers. Markers should be used to mark obstructions when it has been determined that it is impracticable to mark such obstructions by use of surface colors, or it has been determined that markers should be used to provide protection for aeronautics in addition to that provided by the application of aviation surface orange and white colors.

(2) General application. Markers used to mark obstructions should be displayed on or adjacent to the obstruction in conspicuous positions so as to retain the general definition of the obstruction. The size of such marker shall be a visible surface from all directions not less than that of a 36 inch sphere the length of which shall not exceed twice its median width: *Provided, however,* That the commission may approve a nonconforming marker.

(3) Shape. The shape of such markers should be distinctive to the extent necessary to insure that they are not mistaken for markers employed to convey other information, and they should be such that the hazard presented by the obstruction they mark is not increased.

[O.M.&L. standards (part), filed 9/13/61.]

WAC 12-24-040 Flags. (1) Flags may be used to mark obstructions when it has been determined that marking such obstructions by coloring or by markers is technically impracticable.

(2) The flags should be displayed around or on top of the obstruction or around its highest edge and should not increase the hazard presented by the obstruction they mark. When flags are used to mark extensive obstructions or groups of closely spaced obstructions, they should be displayed at approximately 50 foot intervals.

(3) The flags should be rectangular in shape and have stiffeners to keep them from drooping in calm or light wind. The flag stakes should be of such strength and height that they will support the flags free of the ground, vegetation, or nearby surfaces.

(4) The flags should be in accordance with one of the following patterns:

(a) Solid color aviation surface orange not less than two feet on a side.

(b) Two triangular sections, one of aviation surface orange and the other of aviation surface white, combined to form a rectangle not less than two feet on a side.

(c) A checkerboard pattern of aviation surface orange and aviation surface white squares, each one foot plus or minus 10 percent on a side, combined to form a rectangle not less than three feet on a side.

[O.M.&L. standards (part), filed 9/13/61.]

WAC 12-24-045 Colors. (1) Maximum visibility of obstructions by contrast in colors can best be obtained by the use of aviation surface orange and white. Paints

and enamels of these colors have been developed for use by government agencies and private industry in marking obstructions to air navigation. In marking, either the aviation surface orange paint or enamel may be used as preferred.

(2) The painted surfaces of obstructions should be cleaned or repainted as often as necessary to maintain good visibility.

(3) If the smooth surface of the paint on the ladders, decks, and walkways of certain types of steel towers and similar structures presents a potential danger to maintenance personnel, such surfaces need not be painted. However, the omission of paint should be restricted to actual surfaces the painting of which will present a hazard to maintenance personnel, and care should be taken that the over-all marking effect of the painting is not reduced.

(4) Solid. Obstructions the projection of which on any vertical plane has both dimensions less than 5 feet should be colored aviation surface orange.

(5) Bands.

(a) Towers, poles, smokestacks and similar obstructions, as well as buildings of certain shape and dimensions, having essentially unbroken surfaces the projection of which on any vertical plane is 5 feet or more in one dimension and is less than 15 feet in the other dimension, and any skeleton or smokestack type obstruction having both dimensions 5 feet or more, should be colored to show alternate bands of aviation surface orange and white.

(b) The bands should be perpendicular to the major axis of the obstruction with the band at each end colored aviation surface orange. The widths of the bands should be equal and the width of each band should be approximately one-seventh of the length of the major axis of the obstruction, provided that each band shall have a width of not more than 40 feet nor less 1 1/2 feet. If it is technically impracticable to color the roof of a building to show alternate bands of aviation surface orange and white, such roof may be colored aviation surface orange.

(6) Checkerboard pattern.

(a) Water towers, grain elevators, gas holders, and similar obstructions, as well as buildings of certain shape and dimensions, having essentially unbroken surfaces the projection of which on any vertical plane is 15 feet or more in both dimensions, should have their top and vertical surfaces colored to show a checkerboard pattern of alternate rectangles of aviation surface orange and white. If it is technically impracticable to color the roof of a building to show alternate rectangles of aviation surface orange and white, such roof may be colored aviation surface orange.

(b) The sides of the rectangles should measure not less than 5 feet nor more than 20 feet. The rectangles at the corners of surfaces should be colored aviation surface orange.

(c) If a part of a water tower, gas holder, building, or similar obstruction consists of a skeleton type construction, that portion of the obstruction should be colored with alternate bands of aviation surface orange and

white as specified for towers, poles, smokestacks and similar obstructions. In this case, if the portion of the obstruction, which is to be colored to show a checkerboard pattern of alternate rectangles of aviation surface orange and white, has any surfaces the projection of which on any vertical plane is less than 15 feet in either dimension, the alternate rectangles of aviation surface orange and white may have dimensions of less than 5 feet on a side, provided their dimensions remain as close as is practicable to the minimum 5 feet specified for coloring by the checkerboard pattern.

(7) If the size and shape of water towers, grain elevators, gas holders and similar obstructions come within the dimensions set forth under the specification for coloring by bands; or if their type of construction does not permit coloring by the checkerboard pattern as hereinbefore described, then such obstructions should be colored by bands as specified for towers, poles, smokestacks and similar obstructions. Where this method of coloring is employed, the top aviation surface orange band should be continued from the vertical surface so as to cover the entire top of the obstruction.

(8) If a part, or all, of certain obstructions such as water towers and gas holders of spherical shape does not permit the exact application of the checkerboard pattern of coloring, then the shape of the alternate rectangles of aviation surface orange and white covering the spherical shape may be modified to fit the particular shape of the structural surface, provided the dimensions of these modified rectangles remain to the extent practicable within the dimensional limits set forth in the specifications for coloring by the checkerboard pattern.

(9) If certain obstructions such as gas holders and grain elevators are of such large size that the application of the checkerboard pattern of coloring to the complete outer surface of the structure would be impracticable, the application of the checkerboard pattern of coloring may be limited to the upper one-third of the structure, provided aeronautical study indicates that the modified marking will provide adequate protection for air navigation.

[O.M.&L. standards (part), filed 9/13/61.]

WAC 12-24-050 Marking overhead lines. Overhead lines and cables required to be marked under the provisions of RCW 14.04.340 - 14.04.360, shall be marked by placing a marker as described in WAC 12-24-035(2) at least every 150 feet on, or within 30 feet of such lines or cables. See "marking of lines and cables or similar obstructions" (WAC 12-24-380(12)).

Such markers shall be colored international orange equivalent to federal specifications TT-P-59 or TT-E-489.

[O.M.&L. standards (part), filed 9/13/61.]

LIGHTING

WAC 12-24-105 General. (1) The purpose of lighting an obstruction which presents a hazard to air commerce is to warn airmen during the hours of darkness

and during periods of limited daytime light intensity of the presence of such an obstruction. To accomplish this objective, it is necessary to provide adequate lighting on the obstruction in a manner which assures visibility of such lighting from aircraft at any normal angle of approach. In determining the proper amount of obstruction lighting to adequately mark an obstruction, the mean elevation of the top of the building in closely built-up areas may be used as the equivalent of the ground level.

(2) The top light, or lights, displayed on an obstruction should be installed so as to mark the points or edges of the obstruction highest in relation to an obstruction determining surface, except that when no obstruction determining surface is involved, such top light, or lights, should be installed on the points or edges of the obstruction highest in relation to the ground, or water if so situated. If two or more edges of an extended obstruction located near a landing area are of the same height, the edge nearest the landing area should be lighted.

(3) When the upper part of only a portion of a building or similar extensive object projects above an obstruction determining surface, that portion only need be obstruction lighted and the point or edge of it highest in relation to the obstruction determining surface should be regarded as the "top of the obstruction." In certain cases, however, such as when the obstruction determining surface concerned is an approach or transition surface (i.e., sloping) this point or edge highest in relation to the obstruction determining surface may not be the highest above a horizontal plane passing through the base of the object. In such cases, additional obstruction lights should be placed on the highest part of the object as well as on the point or edge highest in relation to the obstruction determining surface.

(4) If a light, or lights, which is installed on an obstruction is shielded in any direction by an adjacent object, additional lights should be mounted on that object in such a way as to retain the general definition of the obstruction, the shielded light, or lights, being omitted if it does not contribute to the definition of the obstruction.

(5) Obstruction lights and hazard beacons should be operated at all times when the center of the sun's disc is 6° or more below the horizon and during periods of restricted visibility. They may also be operated at such other times as considered desirable. For the purpose of this standard, the term "sunset to sunrise" shall be generally regarded as that period when the center of the sun's disc is 6° or more below the horizon.

[O.M.&L. standards (part), filed 9/13/61.]

WAC 12-24-110 Special day lighting. The display of flashing or steady burning lights on an obstruction during daylight hours, for the purpose of warning airmen of the presence of such an obstruction, may be prescribed under certain conditions. The foregoing day lighting is intended to provide protection in addition to that provided by the applicable marking standard hereinbefore described.

[O.M.&L. standards (part), filed 9/13/61.]

WAC 12-24-115 Temporary warning lights. When an obstruction to air navigation is presented during construction of a structure at least two lights, each light consisting of a lamp of at least 100 watts enclosed in an aviation red obstruction light globe, should be installed at the uppermost point of the structure. In addition, as the height of the structure exceeds each level at which permanent obstruction lights will be required, two similar lights should be installed at each such level. These temporary warning lights should be displayed nightly from sunset to sunrise until the permanent obstruction lights have been installed and placed in operation, and should be positioned so as to insure unobstructed visibility of at least one of the lights at each level from aircraft at any normal angle of approach. It will be permissible, in the event it is more practicable, to install and operate the permanent obstruction lighting fixtures at each required level, in lieu of the above temporary warning lights, as each such level is exceeded in height during construction.

[O.M.&L. standards (part), filed 9/13/61.]

WAC 12-24-120 Operation of obstruction lighting.

(1) The operation of obstruction lighting installed on obstructions of an over-all height greater than 150 feet above ground, or water if so situated, should be controlled by a light sensitive control device adjusted so that the lights will be turned on at a north sky light intensity level of about 35 foot-candles and turned off at a north sky light intensity level of about 58 foot-candles, or should be continuous.

(2) Under normal conditions, where no special means of controlling obstruction lighting has been recommended, either a light sensitive control device or an astronomical dial clock and time switch may be used to control the obstruction lighting in lieu of manual control.

[O.M.&L. standards (part), filed 9/13/61.]

WAC 12-24-125 Inspection of obstruction lighting.

Obstruction lighting should be visually observed at least once each 24 hours, or checked by observing an automatic and properly maintained indicator designed to register any failure of such lights, to insure that all such lights are functioning properly as required. In the event the obstruction lighting is not readily accessible for the above observation at least once each 24 hours, an automatic alarm system designed to detect any failure of such lights may be installed to replace the normally required visual inspection. The commission will not object to excluding the side or intermediate obstruction lights on an obstruction from the alarm circuit, provided the signaling device will indicate malfunctioning of all flashing and rotating beacons regardless of their position on the obstruction, and of all top lights; and that all obstruction lights mounted on the obstruction are visually inspected at least once every two weeks, with all lamps being replaced at regular intervals after being lighted the equivalent of not more than 75 percent of their normal life expectancy.

[O.M.&L. standards (part), filed 9/13/61.]

(1990 Ed.)

WAC 12-24-130 Notification of light failure. (1)

Any observed or otherwise known extinguishment of improper functioning of a marker light, regardless of its position on a manmade obstruction, which will last more than 30 minutes and any observed or otherwise known extinguishment or improper functioning of a steady burning obstruction light, installed at the top or near top of any natural or manmade obstruction, which will last more than 30 minutes should be immediately reported. Such reports should be made by telephone or telegraph to the nearest airways communications station or office of Washington state aeronautics commission and should set forth the condition of the light, or lights, the circumstance which caused the failure and the probable date that normal operation will be resumed. Further notification by telephone or telegraph should be given immediately upon resumption of normal operation by the light, or lights.

(2) Any extinguishment or improper functioning of a steady burning side or intermediate light, or lights, installed on a natural or manmade obstruction should be corrected as soon as possible, but notification of such extinguishment or improper functioning is not necessary.

[O.M.&L. standards (part), filed 9/13/61.]

WAC 12-24-135 Color of lighting. The signal emitted by hazard beacons and obstruction lights shall be aviation red in color.

[O.M.&L. standards (part), filed 9/13/61.]

WAC 12-24-140 Light distribution. The vertical and horizontal light distribution of the fixed obstruction lights should meet the requirements specified in the pertinent specifications listed in this publication. The vertical light distribution of the flashing and rotating hazard beacons should be such that the time-intensity integral of the flashes at angles between one degree and three degrees above the horizontal is not less than the candle-seconds values specified hereinbefore under "intensity of lighting," and the time-intensity integral at angles between three degrees and fifteen degrees above the horizontal is not less than the product of these candle-seconds values multiplied by nine over the square of the numerical value in degrees of the angle above the horizontal.

[O.M.&L. standards (part), filed 9/13/61.]

WAC 12-24-145 Rated lamp voltage. In order to provide satisfactory output by obstruction lights, the rated voltage of the lamp used should, in each case, correspond to or be within 3 percent higher than the average voltage across the lamp during the normal hours of operation.

[O.M.&L. standards (part), filed 9/13/61.]

WAC 12-24-150 Flashing of lights. If the flashing mechanism in obstruction lighting circuits is installed so as to make it necessary for the lights to flash, the simultaneous flashing of all lights will be permissible.

[O.M.&L. standards (part), filed 9/13/61.]

WAC 12-24-155 Intensity of lighting. The intensity of fixed obstruction lights should be not less than ten candles of aviation red light.

[O.M.&L. standards (part), filed 9/13/61.]

WAC 12-24-160 Interference with railway signals. Where obstruction lighting is installed on obstructions which are located along or near railroad rights of way and thereby constitutes a potential hazard to the safe operation of railway trains, extreme care should be taken to prevent any possibility of these obstructions lights being mistaken by locomotive engineers for railway signal lights. Shielding of the obstruction lights from the view of the locomotive engineers, if practicable, should be considered; the fixed lights on the obstruction may be made to flash; or the lights at the lower levels of the obstruction may be extinguished if their extinguishment does not materially increase the hazard to air navigation caused by the presence of the obstruction.

[O.M.&L. standards (part), filed 9/13/61.]

WAC 12-24-165 Obstruction lighting by nonstandard lights. Obstruction lighting installations may utilize incandescent lamps other than those specified under the recommended lamp equipment, gaseous tubes such as neon tubes, or any method other than the conventional incandescent lamps, provided such lighting installations offer equal or greater light intensity in all angles of azimuth and elevation than that specified for standard obstruction light assemblies, afford equal or greater dependability of operation, and possess the color characteristics prescribed in the following specifications.

[O.M.&L. standards (part), filed 9/13/61.]

WAC 12-24-170 Obstruction lighting equipment--Specifications and drawings. The lighting equipment, paint and aviation colors referred to in the standards set forth in this publication should conform with the applicable provisions of the following specifications and their related drawings:

- (1) Double and single obstruction lights.
 - (a) Military specification MIL-L-7830.
 - (b) F.A.A. specification L-810 specification for obstruction light.
- (2) Covers for aeronautical lights.
 - (a) Military specification MIL-C-7989 covers; light-transmitting (for aeronautical lights).
- (3) Aviation colors.
 - (a) Air Force-Navy aeronautical specification AN-C-56 colors; aeronautical lights and lighting equipment.
 - (b) Federal specification TT-C-595 color guide; ready mixed paint.
 - (i) Orange no. 1205 (aviation surface orange).
- (4) Aviation surface paint.
 - (a) Federal specification TT-P-59 aviation surface orange paint (international orange).
 - (b) Federal specification TT-E-489 aviation surface orange enamel (international orange).
 - (c) Federal specification TT-P-102 outside white paint.

[Title 12 WAC--p 40]

- (5) Air Force-Navy aeronautical standard drawings.
 - (a) AN2541 Globe--marker lamp.
 - (b) AN2547 Fitting assembly--marker lamp.
- (6) Disconnecting obstruction light.
 - (a) Air Force-Navy aeronautical specification AN-L-31 lamp assembly--disconnecting obstruction marker.
- (7) Recommended lamp equipment.

Multiple circuits

Watts	Base	Lamp	Fila-ment	L.C.L. inches	Type
100	Med. screw	A-21 clear	C-9	2 7/16	Traffic signal
100	Med. pfc.	A-21 clear	CC-2V	2 3/4	Obstruction
100	Sc. term.	PAR-56, clear	C-6	Airway beacon
*111	Med. sc.	A-21 clear	C-9	2 7/16	Obstruction
500	Mog. pfc.	PS-40 clear	C-7A.	5 11/16	Code beacon
500	Med. bip.	T-20 clear	C-13B	3	Airway beacon
**620	Mog. pfc.	PS-40 clear	C-7A	5 11/16	Code beacon
1000	Mog.bip.	T-20 clear	C-13	4	Airway beacon
1500	Mog.bip.	T-24 clear(32v)	C-5	4	Airway beacon

Series circuit

Lumens	Base	Lamp	Fila-ment	L.C.L. inches	Type
1020	Med. pfc.	A-21 clear	C-8	2 3/4	Obstruction

* Has same lumen output as 100-watt but designed for 3000 hours life.

** Has same lumen output as 500-watt but designed for 3000 hours life.

Note: Copies of military specifications and air force-navy aeronautical specifications or drawings can be obtained by contacting Commanding General, Air Material Command, Wright Field, Dayton, Ohio, or the Bureau of Aeronautics, Department of the Navy, Washington 25, D.C. Copies of F.A.A. specifications and information concerning air force-navy aeronautical specifications and federal specifications can be obtained from the Office of Federal Airways, F.A.A. Washington 25, D.C.

[O.M.&L. standards (part), filed 9/13/61.]

WAC 12-24-175 Obstruction lighting standards--Towers, poles, and similar obstructions. Towers, poles and similar obstructions should be lighted in accordance with the following specifications:

(1) **Specification "A-1."** When the particular obstruction is not more than 150 feet in over-all height above ground, or water if so situated.

(a) There should be installed at the top of the obstruction at least two lights, each light consisting of a lamp of at least 100 watts enclosed in aviation red obstruction light globes. These lights should burn simultaneously and should be positioned so as to insure unobstructed visibility of at least one of the lights from aircraft at any normal angle of approach.

(2) **Specification "A-2."** When the particular obstruction is more than 150 feet but not more than 300 feet in over-all height above ground, or water if so situated.

(a) There should be installed at the top of the obstruction a flashing 300 mm electric code beacon equipped with two lamps and aviation red color filters. The two lamps of the beacon should burn simultaneously and each lamp should be at least 500 watts. Where a rod

or other construction of not more than 20 feet in height and incapable of supporting this beacon is mounted on top of the obstruction and it is determined that this additional construction does not permit unobstructed visibility of the code beacon from aircraft at any normal angle of approach, there should be installed two such beacons positioned so as to insure unobstructed visibility of at least one of the beacons at any normal angle of approach.

(b) At the approximate mid point of the over-all height of the obstruction, there should be installed at least two lights, each light consisting of a lamp of at least 100 watts, enclosed in aviation red obstruction light globes. Each light should be placed on diagonally or diametrically opposite positions of the obstruction and mounted so as to insure unobstructed visibility of at least one light from aircraft at any normal angle of approach.

(c) In case of a triangular or rectangular shaped tower, the lights at the mid level should be mounted so as to insure unobstructed visibility of at least one light from aircraft at any normal angle of approach, or a light should be installed on each corner of the tower at this level.

(3) **Specification "A-3."** When the particular obstruction is more than 300 feet but not more than 450 feet in over-all height above ground, or water if so situated.

(a) There should be installed at the top of the obstruction a flashing 300 mm electric code beacon equipped with two lamps and aviation red color filters. The two lamps of the beacon should burn simultaneously and each should be at least 500 watts. Where a rod or other construction of not more than 20 feet in height and incapable of supporting this beacon is mounted on top of the obstruction and it is determined that this additional construction does not permit unobstructed visibility of the code beacon from aircraft at any normal angle of approach, there should be installed two such beacons positioned so as to insure unobstructed visibility of at least one of the beacons from aircraft at any normal angle of approach.

(b) On levels at approximately two-thirds and one-third or the over-all height of the obstruction, there should be installed at least two lights, each light consisting of a lamp of at least 100 watts, enclosed in aviation red obstruction light globes. Each light should be placed on diagonally or diametrically opposite positions of the obstruction and mounted so as to insure unobstructed visibility of at least one light at each level from aircraft at any normal angle of approach.

(c) In case of a triangular or rectangular shaped tower, the lights at the two-thirds and one-third levels should be mounted so as to insure unobstructed visibility of at least one light on each level from aircraft at any normal angle of approach, or a light should be installed on each corner of the obstruction at each level.

(4) **Specification "A-4."** When the particular obstruction is more than 450 feet but not more than 600 feet in over-all height above ground, or water if so situated.

(a) There should be installed at the top of the obstruction a flashing 300 mm electric code beacon equipped with two lamps and aviation red color filters. The two lamps of the beacon should burn simultaneously and each should be at least 500 watts. Where a rod or other construction of not more than 20 feet in height and incapable of supporting this beacon is mounted on top of the obstruction and it is determined that this additional construction does not permit unobstructed visibility of the code beacon from aircraft at any normal angle of approach, there should be installed two such beacons positioned so as to insure unobstructed visibility of at least one of the beacons from aircraft at any normal angle of approach.

(b) At approximately one-half of the over-all height of the obstruction, a similar flashing 300 mm electric code beacon should be installed in such a position within the obstruction proper that the structural members will not impair visibility of this beacon from aircraft at any normal angle of approach. In the event this beacon cannot be installed in a manner to insure unobstructed visibility of it from aircraft at any normal angle of approach, there should be installed two such beacons. Each beacon should be mounted on the outside of diagonally opposite corners or opposite sides of the obstruction at the prescribed height.

(c) On levels of approximately three-fourths and one-fourth of the over-all height of the obstruction one or more lights, each light consisting of a lamp of at least 100 watts, enclosed in aviation red obstruction light globes, should be installed on each outside corner of the obstruction at each level.

(5) **Specification "A-5."** When the particular obstruction is more than 600 feet but not more than 750 feet in over-all height above ground, or water if so situated.

(a) There should be installed at the top of the obstruction a flashing 300 mm electric code beacon equipped with two lamps and aviation red color filters. The two lamps of the beacon should burn simultaneously and each should be at least 500 watts. Where a rod or other construction of not more than 20 feet in height and incapable of supporting this beacon is mounted on top of the obstruction and it is determined that this additional construction does not permit unobstructed visibility of the code beacon from aircraft at any normal angle of approach, there should be installed two such beacons positioned so as to insure unobstructed visibility of at least one of the beacons from aircraft at any normal angle of approach.

(b) At approximately two-fifths of the over-all height of the obstruction, a similar flashing 300 mm electric code beacon should be installed in such a position within the obstruction proper that the structural members will not impair visibility of this beacon from aircraft at any normal angle of approach. In the event this code beacon cannot be installed in a manner to insure unobstructed visibility from aircraft at any normal angle of approach, there should be installed two such beacons at this level.

Each beacon should be mounted on the outside of diagonally opposite corners or opposite sides of the obstruction at the prescribed height.

(c) On levels at approximately four-fifths, three-fifths and one-fifth of the over-all height of the obstruction one or more lights, each light consisting of a lamp of at least 100 watts, enclosed in aviation red obstruction light globes should be installed on each outside corner of the obstruction at each level.

(6) **Specification "A-6."** When the particular obstruction is more than 750 feet but not more than 900 feet in over-all height above ground, or water if so situated.

(a) There should be installed at the top of the obstruction a flashing 300 mm electric code beacon equipped with two lamps and aviation red color filters. The two lamps of the beacon should burn simultaneously and each should be at least 500 watts.

(b) Where a rod or other construction of not more than 20 feet in height and incapable of supporting this beacon is mounted on top of the obstruction and it is determined that this additional construction does not permit unobstructed visibility of the code beacon from aircraft at any normal angle of approach, there should be installed two such beacons positioned so as to insure unobstructed visibility of at least one of the beacons from aircraft at any normal angle of approach.

(c) At approximately two-thirds and at approximately one-third of the over-all height of the obstruction, a similar flashing 300 mm electric code beacon should be installed in such a position within the obstruction proper that the structural members will not impair visibility of this beacon from aircraft at any normal angle of approach. In the event these electric code beacons cannot be installed in a manner to insure unobstructed visibility from aircraft at any normal angle of approach, there should be installed two such beacons at each level. Each beacon should be mounted on the outside of diagonally opposite corners or opposite sides of the obstruction at the prescribed heights.

(d) On levels at approximately five-sixths, one-half and one-sixth of the over-all height of the obstruction one or more lights, each light consisting of a lamp of at least 100 watts, enclosed in aviation red obstruction light globes should be installed on each outside corner of the obstruction at each level.

(7) **Specification "A-7."** When the particular obstruction is more than 900 feet but not more than 1050 feet in over-all height above ground, or water if so situated.

(a) There should be installed at the top of the obstruction a flashing 300 mm electric code beacon equipped with two lamps and aviation red color filters. The two lamps of the beacon should burn simultaneously and each should be at least 500 watts. Where a rod or other construction of not more than 20 feet in height and incapable of supporting this beacon is mounted on top of the obstruction and it is determined that this additional construction does not permit unobstructed visibility of the code beacon from aircraft at any normal angle of approach, there should be installed two such

beacons positioned so as to insure unobstructed visibility of at least one of the beacons from aircraft at any normal angle of approach.

(b) At approximately four-sevenths, and at approximately two-sevenths of the over-all height of the obstruction, a similar flashing 300 mm electric code beacon should be installed in such a position within the obstruction proper that the structural members will not impair visibility of this beacon from aircraft at any normal angle of approach. In the event these electric code beacons cannot be installed in a manner to insure unobstructed visibility from aircraft at any normal angle of approach, there should be installed two such beacons at each level. Each beacon should be mounted on the outside of diagonally opposite corners or opposite sides of the obstruction at the prescribed heights.

(c) On levels at approximately six-sevenths, five-sevenths, three-sevenths and one-seventh of the over-all height of the obstruction one or more lights consisting of a lamp of at least 100 watts, enclosed in aviation red obstruction light globes should be installed on each outside corner of the obstruction at each level.

(8) **Specification "A-8."** When the particular obstruction is more than 1050 feet but not more than 1200 feet in over-all height above ground, or water if so situated.

(a) There should be installed at the top of the obstruction a flashing 300 mm electric code beacon equipped with two lamps and aviation red color filters. The two lamps of the beacon should burn simultaneously and each should be at least 500 watts. Where a rod or other construction of not more than 20 feet in height and incapable of supporting this beacon is mounted on top of the obstruction and it is determined that this additional construction does not permit unobstructed visibility of the code beacon from aircraft at any normal angle of approach, there should be installed two such beacons positioned so as to insure unobstructed visibility of at least one of the beacons from aircraft at any normal angle of approach.

(b) At approximately three-fourths, one-half and one-fourth of the over-all height of the obstruction, a similar flashing 300 mm electric code beacon should be installed in such a position within the obstruction proper that the structural members will not impair visibility of this beacon from aircraft at any normal angle of approach. In the event these electric code beacons cannot be installed in a manner to insure unobstructed visibility from aircraft at any normal angle of approach, there should be installed two such beacons at each level. Each beacon should be mounted on the outside of diagonally opposite corners or opposite sides of the obstruction at the prescribed heights.

(c) On levels at approximately seven-eighths, five-eighths, three-eighths and one-eighth of the over-all height of the obstruction one or more lights, each light consisting of a lamp of at least 100 watts, enclosed in aviation red obstruction light globes should be installed on each outside corner of the obstruction at each level.

(9) **Specification "A-9."** When the particular obstruction is more than 1200 feet but not more than 1350

feet in over-all height above ground, or water if so situated.

(a) There should be installed at the top of the obstruction a flashing 300 mm electric code beacon equipped with two lamps and aviation red color filters. The two lamps of the beacon should burn simultaneously and each should be at least 500 watts. Where a rod or other construction of not more than 20 feet in height and incapable of supporting this beacon is mounted on top of the obstruction and it is determined that this additional construction does not permit unobstructed visibility of the code beacon from aircraft at any normal angle of approach, there should be installed two such beacons positioned so as to insure unobstructed visibility of at least one of the beacons from aircraft at any normal angle of approach.

(b) At approximately two-thirds, four-ninths and two-ninths of the over-all height of the obstruction, a similar flashing 300 mm electric code beacon should be installed in such a position within the obstruction proper that the structural members will not impair visibility of this beacon from aircraft at any normal angle of approach. In the event these electric code beacons cannot be installed in a manner to insure unobstructed visibility from aircraft at any normal angle of approach, there should be installed two such beacons at each level. Each beacon should be mounted on the outside of diagonally opposite corners or opposite sides of the obstruction at the prescribed heights.

(c) On levels at approximately eight-ninths, seven-ninths, five-ninths, one-third and one-ninth of the over-all height of the obstruction one or more lights, each light consisting of a lamp of at least 100 watts, enclosed in aviation red obstruction light globes should be installed on each outside corner of the obstruction at each level.

(10) **Specification "A-10."** When the particular obstruction is more than 1350 feet but not more than 1500 feet in over-all height above ground, or water if so situated.

(a) There should be installed at the top of the obstruction a flashing 300 mm electric code beacon equipped with two lamps and aviation red color filters. The two lamps of the beacon should burn simultaneously and each should be at least 500 watts. Where a rod or other construction of not more than 20 feet in height and incapable of supporting this beacon is mounted on top of the obstruction and it is determined that this additional construction does not permit unobstructed visibility of the code beacon from aircraft at any angle of approach, there should be installed two such beacons positioned so as to insure unobstructed visibility of at least one of the beacons from aircraft at any normal angle of approach.

(b) At approximately four-fifths, three-fifths, two-fifths and one-fifth of the over-all height of the obstruction, a similar flashing 300 mm electric code beacon should be installed in such a position within the obstruction proper that the structural members will not impair visibility of this beacon from aircraft at any normal angle of approach. In the event these electric code

beacons cannot be installed in a manner to insure unobstructed visibility from aircraft at any normal angle of approach, there should be installed two such beacons at each level. Each beacon should be mounted on the outside of diagonally opposite corners or opposite sides of the obstruction at the prescribed heights.

(c) On levels at approximately nine-tenths, seven-tenths, one-half, three-tenths and one-tenth of the over-all height of the obstruction one or more lights, each light consisting of a lamp of at least 100 watts, enclosed in aviation red obstruction light globes should be installed on each outside corner of the obstruction at each level.

(11) **Specification "A-11."** Towers and similar obstructions which are more than 1500 feet in over-all heights above ground, or water if so situated, will be given special aeronautical study to determine the proper manner in which to obstruction light them to provide adequate protection for air commerce.

[O.M.&L. standards (part), filed 9/13/61.]

WAC 12-24-180 Obstruction lighting standards--Trees. A line of trees, with the individual trees located less than 150 feet apart, or a tree covered area should be lighted as an extensive obstruction in the manner set forth in the "E" specifications for prominent buildings and similar extensive obstructions, with the obstruction lights mounted on poles or towers, of a height slightly greater than the height of the outstanding trees. Individual trees and widely spaced trees should be lighted in accordance with the following specifications:

(1) **Specification "B-1."** Poles of a height slightly greater than the height of the outstanding tree(s) should be installed adjacent to the tree(s) and lighted in accordance with the specifications hereinbefore prescribed for individual towers, poles and similar obstructions of a corresponding over-all height above ground, or water if so situated.

[O.M.&L. standards (part), filed 9/13/61.]

WAC 12-24-185 Obstruction lighting standards--Transmission lines. The catenary of a transmission line or similar obstructions, should be lighted in accordance with the following specifications:

(1) **Specification "C-1."**

(a) The towers, poles, or similar structures supporting such a line should be lighted in accordance with the specifications hereinbefore prescribed for individual towers, poles, or similar obstructions of a corresponding over-all height above ground, or water if so situated.

(b) In each case where a transmission line within 15,000 feet of a landing area is required to be lighted in accordance with the provisions of RCW 14.04.340 - 14.04.350, one or more lights, each light consisting of a lamp of at least 100 watts enclosed in an aviation red obstruction light globe, should be displayed for each 150 feet or fraction thereof, of the over-all length of the overhead line. These lights should be equally spaced along the entire length of the overhead transmission line at points not more than 150 feet apart and each light

should be placed not below the level of the highest wire at the point marked.

(c) When a transmission line more than 15,000 feet from a landing area is required to be lighted in accordance with the provisions of RCW 14.04.340 – 14.04.350, the distance between the obstruction lights displayed on such wires may be increased to not less than 600 feet.

[O.M.&L. standards (part), filed 9/13/61.]

WAC 12-24-190 Obstruction lighting standards--Smokestacks and similar obstructions. Smokestacks and similar obstructions should be lighted in accordance with the following specifications:

(1) In order to avoid the obscuring effect of the deposits generally in evidence from this type of structure, the top lights should be installed from 5 to 10 feet below the highest point of the structure. It is important that these lights be readily accessible to enable cleaning when necessary and to facilitate lamp replacements.

(2) Smokestacks and similar obstructions may be floodlighted by fixed searchlight projectors installed at three or more equidistant points around the base of each such obstruction if the search light projectors will provide an average illumination of at least 15 candles at the top one-third of the obstruction.

(3) **Specification "D-1."** When the particular obstruction is not more than 150 feet in over-all height above ground, or water if so situated.

(a) There should be installed at a near top level of the obstruction three or more lights, each light consisting of a lamp of at least 100 watts, enclosed in aviation red obstruction light globes. These lights should be placed at regular intervals on the horizontal plane in a manner to insure unobstructed visibility of at least two of the lights from aircraft at any normal angle of approach.

(4) **Specification "D-2."** When the particular obstruction is more than 150 feet but not more than 300 feet in over-all height above ground, or water if so situated.

(a) There should be installed at a near top level of the obstruction two or more flashing 300 mm electric code beacons, each beacon equipped with two lamps and aviation red color filters. The two lamps of each beacon should burn simultaneously and each should be at least 500 watts. The beacons should be placed at regular intervals on the horizontal plane in a manner to insure unobstructed visibility of at least one beacon from aircraft at any normal angle of approach.

(b) At approximately the mid point of the over-all height of the obstruction, there should be installed at least two lights, each light consisting of a lamp of at least 100 watts, enclosed in aviation red obstruction light globes. These lights should be placed at regular intervals on the horizontal plane in a manner to insure unobstructed visibility of at least one light from aircraft at any normal angle of approach.

(5) **Specification "D-3."** When the particular obstruction is more than 300 feet but not more than 450 feet in over-all height above ground, or water if so situated.

(a) There should be installed at a near top level of the obstruction two or more flashing 300 mm electric code beacons, each beacon equipped with two lamps and aviation red color filters. The two lamps of each beacon should burn simultaneously and each should be at least 500 watts. The beacons should be placed at regular intervals on the horizontal plane in a manner to insure unobstructed visibility of at least one beacon from aircraft at any normal angle of approach.

(b) On levels at approximately two-thirds and one-third of the over-all height of the obstruction, there should be installed on each level at least two lights, each light consisting of a lamp of at least 100 watts, enclosed in aviation red obstruction light globes. These lights should be placed at regular intervals on the horizontal plane in a manner to insure unobstructed visibility of at least one light from aircraft on any normal angle of approach.

(6) **Specification "D-4."** When the particular obstruction is more than 450 feet but not more than 600 feet in over-all height above ground, or water if so situated.

(a) There should be installed at a near top level of the obstruction two or more flashing 300 mm electric code beacons, each beacon equipped with two lamps and aviation red color filters. The two lamps of each beacon should burn simultaneously and each should be at least 500 watts. The beacons should be placed at regular intervals on the horizontal plane in a manner to insure unobstructed visibility of at least one beacon from aircraft at any normal angle of approach.

(b) At approximately one-half of the over-all height of the structure, two or more similar flashing 300 mm electric code beacons should be installed at regular intervals on the horizontal plane in a manner to insure unobstructed visibility of at least one beacon from aircraft at any normal angle of approach.

(c) On levels of approximately three-fourths and one-fourth of the over-all height of the structure, there should be installed on each level at least three lights, each light consisting of a lamp of at least 100 watts, enclosed in aviation red obstruction light globes. These lights should be placed at regular intervals on the horizontal plane in a manner to insure unobstructed visibility of at least two lights on each level from aircraft at any normal angle of approach.

(7) **Specification "D-5."** When the particular obstruction is more than 600 feet but not more than 750 feet in over-all height above ground, or water if so situated.

(a) There should be installed at a near top level of the obstruction two or more flashing 300 mm electric code beacons, each beacon equipped with two lamps and aviation red color filters. The two lamps of each beacon should burn simultaneously and should be at least 500 watts. The beacons should be placed at regular intervals on the horizontal plane in a manner to insure unobstructed visibility of at least one beacon from aircraft at any normal angle of approach.

(b) At approximately two-fifths of the over-all height of the obstruction, two or more similar flashing 300 mm

electric code beacons should be installed at regular intervals on the horizontal plane in a manner to insure unobstructed visibility of at least one beacon from aircraft at any normal angle of approach.

(c) On levels of approximately four-fifths, three-fifths and one-fifth of the over-all height of the obstruction, there should be installed on each level at least three lights, each light consisting of a lamp of at least 100 watts, enclosed in aviation red obstruction light globes. These lights should be placed at regular intervals on the horizontal plane in a manner to insure unobstructed visibility of at least two lights on each level from aircraft at any normal angle of approach.

(8) **Specification "D-6."** When the particular obstruction is more than 750 feet but not more than 900 feet in over-all height above ground, or water if so situated.

(a) There should be installed at a near top level of the obstruction two or more flashing 300 mm electric code beacons, each beacon equipped with two lamps and aviation red color filters. The two lamps of each beacon should burn simultaneously and each should be at least 500 watts. The beacons should be placed at regular intervals on the horizontal plane in a manner to insure unobstructed visibility of at least one beacon from aircraft at any normal angle of approach.

(b) At approximately two-thirds and at approximately one-third of the over-all height of the obstruction two or more similar flashing 300 mm electric code beacons should be installed at regular intervals on the horizontal plane in a manner to insure unobstructed visibility of at least one beacon from aircraft at any normal angle of approach.

(c) On levels of at approximately five-sixths, one-half and one-sixth of the over-all height of the obstruction, there should be installed at least three lights, each light consisting of a lamp of at least 100 watts, enclosed in aviation red obstruction light globes. These lights should be placed at regular intervals on the horizontal plane in a manner to insure unobstructed visibility of at least two lights on each level from aircraft at any normal angle of approach.

(9) **Specification "D-7."** Smokestacks and similar obstructions which are more than 900 feet in over-all height above ground, or water if so situated, will be given special aeronautical study to determine the proper manner in which to obstruction light them to provide adequate protection for air commerce.

[O.M.&L. standards (part), filed 9/13/61.]

WAC 12-24-195 Obstruction lighting standards—Prominent buildings and similar extensive obstructions.

(1) Prominent buildings and similar extensive obstructions should be lighted in accordance with the following specifications. In the event the individual objects of a group of obstructions are approximately the same over-all height above ground, or water if so situated, and are located not more than 150 feet apart, the group of obstructions may be considered an extensive obstruction and so lighted.

(2) **Specification "E-1."** When the particular obstruction is not more than 150 feet in over-all height above ground, or water if so situated.

(a) If the obstruction is not more than 150 feet in either horizontal dimension, there should be installed at approximately the highest point or edge at each end of the major axis of the obstruction at least one light, consisting of a lamp of at least 100 watts, enclosed in an aviation red obstruction light globe. These lights should be positioned so as to insure unobstructed visibility of them from aircraft at any normal angle of approach, and to indicate the general extent of the obstruction; or, if the shape of the obstruction is such as to make this manner of lighting impracticable, there may be installed two such lights at the approximate center of the highest point or edge of the obstruction. Both lights should burn simultaneously and be so positioned as to insure unobstructed visibility of at least one of the lights from aircraft at any normal angle of approach.

(b) If the obstruction is more than 150 feet in one horizontal dimension, but not more than 150 feet in the other, there should be installed at least one light, consisting of a lamp of at least 100 watts enclosed in an aviation red obstruction light globe, for each 150 feet, or fraction thereof, or the over-all length of the major axis of the obstruction. At least one of these top lights should be installed on the highest point or edge of each end of the obstruction, with the additional lights as required spaced at approximately equal intervals not exceeding 150 feet, on the highest points or edge between the end lights in a manner to indicate the extent of the obstruction and to insure unobstructed visibility of the lights from aircraft at any normal angle of approach. If there are two or more edges of the same height on such an obstruction located near a landing area, the edge nearest the landing area should be lighted.

(c) If the obstruction is more than 150 feet in both horizontal dimensions, there should be installed at least one light, consisting of a lamp of at least 100 watts enclosed in an aviation red obstruction light globe, on the highest point of each corner of the obstruction. In addition, there should be installed at least one similar light for each 150 feet, or fraction thereof, [if] the distance between the corner lights exceeds 150 feet. These additional lights should be installed at approximately equal intervals, at the highest points along the outer edges of the obstruction, between the corner lights in a manner to indicate the general extent and definition of the obstruction and to insure unobstructed visibility of the lights from aircraft at any normal angle of approach.

(d) In the event there are one or more points within the outer edges of the obstruction, the uppermost parts of which are higher than the highest level of the lights hereinbefore prescribed, at least one similar light should be displayed from the top of each such point.

(2) **Specification "E-2."** When the particular obstruction is more than 150 feet in over-all height above ground, or water if so situated.

(a) Top lights should be installed on the obstruction in the manner set forth in the applicable provisions of Specification "E-1."

(b) In addition to the required top lights, intermediate lights, each consisting of a lamp of at least 100 watts enclosed in an aviation red obstruction light globe, should be provided for each 150 feet, or fraction thereof, [if] the obstruction exceeds 150 feet in over-all height above ground, or water if so situated. The position of these intermediate lights on the vertical plane should be at as close to equidistant levels between the top lights and the ground level as the particular shape and type of obstruction will permit. One such light should be installed at each outside corner of the obstruction at each level and also one such light should be installed at equal intervals on the horizontal plane on each outer surface at each level between adjacent corner lights, for each 150 feet, or fraction thereof, [if] the over-all horizontal distance between such adjacent corner lights exceeds 150 feet.

Note: In lieu of installing the obstruction lights on the obstructions, a pole or poles of a height slightly greater than the over-all height of the obstruction may be installed thereto and lighted in accordance with the specifications hereinbefore prescribed for individual towers, poles, or similar obstructions of a corresponding over-all height. It is important that those towers, poles, or similar structures be installed in such a manner as to indicate the general definition and extent of the obstruction.

(3) In the event early or special warning is considered necessary to provide adequate protection for aircraft, the top lights on each obstruction as required under Specifications "E-1" and "E-2" should be replaced with one or more flashing 300 mm electric code beacons, each beacon equipped with two lamps and aviation red color filters. The two lamps of each beacon should burn simultaneously and each should be at least 500 watts.

(4) Where obstructions are extensive as in the case of a line of trees or hills, and the use of the fixed obstruction lights would be impracticable or inadequate, flashing or rotating hazard beacons may be used as an alternate to the fixed obstruction lights. Such beacons should be located on the highest points or edges of the extended obstruction at intervals not exceeding 3,000 feet, provided at least three beacons are placed on any one side or edge of the extensive obstruction to indicate a line of lights.

[O.M.&L. standards (part), filed 9/13/61.]

WAC 12-24-200 Obstruction lighting standards--Bridges. The superstructure of a bridge should be lighted in accordance with the following specifications.

(1) Where the bridge structure is over navigable water, approval of the lighting installation must be obtained from the commandant of the United States Coast Guard to avoid interference with marine navigation.

(2) **Specification "F-1."** When the bridge superstructure is not more than 150 feet in over-all length.

(a) There should be installed at the approximate center of the highest point of the superstructure at least two lights, each light consisting of a lamp of at least 100 watts, enclosed in aviation red obstruction light globes. The two lights should burn simultaneously and should be positioned so as to insure unobstructed visibility of at least one of the lights from aircraft at any normal angle of approach.

(3) **Specification "F-2."** When the bridge superstructure is more than 150 feet in over-all length.

(a) There should be installed for each 150 feet, or fraction thereof, of the over-all length of the bridge superstructure one or more lights, each light consisting of a lamp of at least 100 watts, enclosed in aviation red obstruction light globes. These lights should be installed on the highest points of the superstructure at approximately equal intervals not exceeding 150 feet in a manner to indicate the general definition and extent of the obstruction, and to insure unobstructed visibility of the lights from aircraft at any normal angle of approach. The distance between these top lights may be increased to a distance not exceeding 600 feet when the particular bridge is located more than 15,000 feet from the reference point of any landing area.

(b) Where the bridge superstructure exceeds 150 feet in over-all length and the use of the above described obstruction lights would be impracticable or inadequate, flashing or rotating hazard beacons should be used as an alternate to the fixed obstruction lights. Such beacons should be located on the highest points or edge of the bridge superstructure at intervals not exceeding 3,000 feet, provided at least three beacons are installed to indicate the extent of the obstruction. The flashing or rotating beacons should conform to the provisions of the pertinent specifications as hereinbefore indicated under "obstruction lighting equipment."

[O.M.&L. standards (part), filed 9/13/61.]

WAC 12-24-205 Obstruction lighting standards--Water towers, grain elevators, gas holders and similar obstructions. Water towers, grain elevators, gas holders and similar obstructions should be lighted in accordance with the following specifications:

(1) **Specification "G-1."** When the particular obstruction is not more than 150 feet in over-all height above ground, or water if so situated.

(a) There should be installed at the top of the obstruction at least two lights, each light consisting of a lamp of at least 100 watts, enclosed in aviation red obstruction light globes. These lights should burn simultaneously and should be positioned so as to insure unobstructed visibility of at least one of the lights from aircraft at any normal angle of approach.

(2) **Specification "G-2."** When the particular obstruction is more than 150 feet but not more than 300 feet in over-all height above ground, or water if so situated.

(a) There should be installed at the top of the obstruction a flashing 300 mm electric code beacon equipped with two lamps and aviation red color filters. The two lamps of the beacon should burn simultaneously and each should be at least 500 watts. The beacon should be positioned so as to insure unobstructed visibility of it from aircraft at any normal angle of approach.

(b) At the approximate midpoint of the over-all height of the obstruction, there should be installed three or more lights, each light consisting of a lamp of at least 100 watts, enclosed in aviation red obstruction light globes. The position of these intermediate lights on the

vertical plane should be as close to an equidistant level between the top beacon and the ground level as the particular shape and type of construction of the obstruction will permit. These lights should be placed at regular intervals on the horizontal plane in a manner to insure unobstructed visibility of at least two of the lights from aircraft at any normal angle of approach.

(3) **Specification "G-3."** When the particular obstruction is more than 300 feet but not more than 450 feet in over-all height above ground, or water if so situated.

(a) There should be installed at the top of the obstruction a flashing 300 mm electric code beacon equipped with two lamps and aviation red color filters. The two lamps of the beacon should burn simultaneously and each should be at least 500 watts. The beacon should be positioned so as to insure unobstructed visibility of it from aircraft at any normal angle of approach.

(b) At approximately two-thirds and one-third of the over-all height of the obstruction there should be installed three or more lights, each light consisting of a lamp of at least 100 watts, enclosed in aviation red obstruction light globes. The position of these intermediate lights on the vertical plane should be as close to equidistant positions between the top beacon and the ground level as the particular shape and type of construction of the structure will permit. These lights should be placed at regular intervals on the horizontal plane in a manner to insure unobstructed visibility of at least two lights on each level from aircraft at any normal angle of approach.

[O.M.&L. standards (part), filed 9/13/61.]

WAC 12-24-210 Obstruction lighting standards--Group of structural hazards. Towers, poles, tanks, smokestacks and similar obstructions which are so grouped as to present a common hazard to air navigation should be lighted in accordance with the following specifications:

(1) **Specification "H-1."**

(a) This specification applies to a group of closely spaced towers, poles, tanks, smokestacks or similar obstructions of approximately the same over-all height above ground, or water if so situated, in which the spacing between the individual structures does not exceed 150 feet.

(b) The group may be considered an extensive obstruction and lighted in accordance with the "E" specifications for prominent buildings and similar extensive obstructions.

(2) **Specification "H-2."**

(a) This specification applies to a group of closely spaced towers, poles, tanks, smokestacks and similar obstructions, which may or may not be of the same over-all height, in which the spacing between the individual structures is not in all cases equal to or less than 150 feet.

(b) Each prominent object within the group should be lighted in accordance with the specifications hereinbefore prescribed for individual towers, poles, and similar

obstructions or a corresponding over-all height above ground, or water if so situated.

(c) In addition, there should be installed at the top of a prominent center obstruction or on a special tower located near the center of the group of obstructions, at least one rotating beacon producing aviation red flashes. The frequency of its flashes should be such as hereinbefore specified for rotating beacons.

[O.M.&L. standards (part), filed 9/13/61.]

WAC 12-24-215 Obstruction lighting standards--Hazard areas. Areas in which a visible or invisible hazard, or hazards, exists should be lighted in accordance with the following specifications.

(1) The obstruction lighting prescribed hereinafter is in addition to such lighting as may be necessary on any natural or manmade obstruction located within the hazard area.

(2) **Specification "I-1."**

(a) An area in which a visible or invisible hazard, or hazards, to aircraft exists.

(b) There should be mounted on top of a tower or other suitable structure, located near the center of the area, at least one rotating beacon producing aviation red flashes. The frequency of its flashes should be such as hereinbefore specified for rotating beacons.

(3) **Specification "I-2."**

(a) A large area in which a visible or invisible hazard, or hazards, to aircraft exists.

(b) There should be installed at two or more places around the perimeter of the area a rotating beacon, mounted on top of a tower or other suitable structure, producing aviation red flashes. The beacons should be located in a manner to insure unobstructed visibility of at least one of the beacons from aircraft at any normal angle of approach. The frequency of its flashes should be such as hereinbefore specified for rotating beacons.

[O.M.&L. standards (part), filed 9/13/61.]

APPENDIX

WAC 12-24-350 Appendix rules--General. (1) The main body of this publication presents standards for marking and lighting objects, which are potential hazards to the safe operation of aircraft, for the purpose of indicating their presence to pilots. The material in this appendix includes texts of laws and regulations, together with information to provide guidance in complying with these texts of laws and regulations, pertaining to such objects.

(2) Existing or contemplated structures which, by reason of their height and location relative to landing areas, constitute potential hazards to the safe operation of aircraft continually demand attention in the effort to provide and maintain maximum safety for air commerce.

(3) It is vitally important that prompt notification of the construction or alteration of towers, electric transmission and telephone lines, smokestacks, water towers, buildings and similar structures, of certain heights and

distances from landing areas and civil airways, be given to the aeronautical public through notices to airmen before any such structure is constructed or altered. Achievement of this result requires the cooperation of all federal, state and municipal agencies, private industry and individuals engaged in such construction or alteration.

(4) For this purpose, regulations of the Washington state aeronautics commission have been promulgated requiring the submission of Form 426 prior to the beginning of the construction or alteration of structures falling within the prescribed limits of air activity. The limits within which construction or alteration requires the submission of the form have been set after careful study of the problem and with due regard for the maximum protection of airmen.

(5) In the case of an existing structure on which a proper notice has already been submitted, some latitude for repairs is permitted by an explanation of the term "alteration." Notice may be omitted if the alteration or alterations will not increase or decrease the height of the top or any part of the structure from that previously reported by more than 1 foot for each 500 feet, or fraction thereof, of the distance that the structure is situated from the nearest boundary of the landing area involved. However, notice must be given of any alteration or alterations increasing or decreasing the height of the top or any part of a structure by more than 10 feet from that previously reported.

(6) The information required on proposed construction or alteration is clearly explained in the Form 426 prepared for that purpose and is essentially that material needed to warn airmen of a potential hazard to air navigation. It is necessary, therefore, that all applicable questions therein be answered without exception. Copies of these forms may be obtained from the Washington State Aeronautics Commission, Boeing Field, Seattle, Washington.

(7) The distance between the nearest boundary of a landing area and the site of the construction or alteration may be measured by the use of maps, or on the surface of the earth by an automobile mileage meter, or other convenient but reasonably accurate means.

(8) The term "navigable water" as used in connection with obstructions to air navigation, denotes all water suitable for the take-off or landing of water aircraft. Other geographical features which combine hydrographic and topographic characteristics, such as marshes, swamps and bogs, come within the meaning of the term "ground" as described in the act.

(9) The state aeronautics commission desires to assist those contemplating construction which may present a potential hazard to air navigation in selecting locations for the structures which will create a minimum of interference with air operations; to recommend the proper obstruction marking and lighting to insure adequate protection to aircraft; and to minimize the possibility of damage to structures from collision by aircraft.

(10) For this purpose the commission has provided a special advisory service consisting of personnel who conduct the specific investigation of each case. This service

is available upon request, which may be by letter or in person. The request should be accompanied by a complete description of the proposed construction, including the geographic coordinates and the distance and direction of the site from the nearest town; the distance from the nearest landing area; the height of the structure above the ground and the over-all height of the structure above mean sea level. A map or sketch showing the height and location of all tall structures in the vicinity should also be furnished. The investigation will ordinarily take approximately ten days because of the necessary contacts with aeronautical interests concerned. This period may be longer if the problem is a complex one, because every attempt is made by the investigators to resolve the problem with due regard to the safety factor.

(11) Interested contractors, engineers and architects should avail themselves of this service so as to prevent delays in obtaining the necessary permits for the construction.

[O.M.&L. standards, appendix (part), filed 9/13/61.]

WAC 12-24-360 Appendix rules--Criteria for determining obstructions to air navigation. (1) Introduction. In order to provide uniform criteria for determining obstructions to air navigation, this standard has been adopted by the Washington state aeronautics commission.

(2) Directive. In accordance with the procedure for establishing technical aeronautical standards specified in state obstruction marking and lighting law, "Criteria for determining obstructions to air navigation" set forth below is established as a state standard. This standard is the official Washington state aeronautics commission guide for determining obstructions to air navigation and supersedes all existing obstruction criteria which do not conform to its requirements.

(3) Specific instructions. Procedure for determining obstructions.

(a) Any structure or obstacle which obstructs the air space above ground or water level, when determined by the commission after a hearing to be a hazard or potential hazard to the safe flight of aircraft, shall be plainly marked, illuminated, painted, lighted or designated in a manner to be approved in accordance with the general rules and regulations of the commission so that the same will be clearly visible to airmen. In determining which structures or obstacles constitute or may become a hazard to air flight, the commission shall take into account only those obstacles located at river, lake and canyon crossings and in other low altitude flight paths usually traveled by aircraft. [Same as RCW 14.04.340.]

(b) The director shall have the authority to require owners, operators, lessees or others having the control or management of structures or obstacles over one hundred fifty feet above ground or water level and which are or may become a hazard to air flight to report the location of such existing or proposed structures or obstacles to the commission. For that purpose the director may issue subpoenas and subpoenas duces tecum returnable within twenty days to the commission. In the event a person refuses to obey the director's subpoena, the commission

may certify to the superior court all facts of any such refusal. The court shall summarily hear evidence on such refusal, and, if the evidence warrants, punish such person refusing in the same manner and to the same extent as for contempt committed before the court. [Same as RCW 14.04.350.]

(c) Objects which are located or will be located with respect to other objects of a permanent character such that there results no material increase in the aeronautical hazard will not be considered obstructions.

[O.M.&L. standards, appendix (part), filed 9/13/61.]

WAC 12-24-370 Appendix rules--Operation of moored balloons. (1) Scope. The following rules shall apply to moored balloons when operated anywhere in the state of Washington at altitude controlled by state law.

(2) General. Moored balloons may be operated without permit from or notice to the state when operated less than 150 feet above the surface at a location not usually traveled by aircraft.

(3) Operation requiring a permit. Unless operated under the conditions specified in "general" moored balloons subject to these regulations shall be operated under the authority of and in compliance with the terms and conditions of a permit issued by the state aeronautics commission when such moored balloons are operated:

- (a) Closer than 500 feet to the base of any cloud; or
- (b) During the hours of darkness; or
- (c) When ground visibility is less than 3 miles; or
- (d) At altitudes more than 150 feet above the surface;

or

- (e) In a location usually traveled by aircraft.
- (4) Written notice of intent must be submitted to the office of the commission at least 30 days prior to the date of operation. Such notice shall contain the name and address of the owner and person operating the balloon, the date or dates of the proposed operation, and the location and altitude at which the proposed operation will be conducted. No moored balloons will be operated without written approval from the Washington state aeronautics commission.

(5) Rapid deflation device. No moored balloon having a diameter of more than 6 feet or a gas capacity of more than 115 cubic feet shall be operated unless it is equipped with a device or means of automatic and rapid deflation in the event of an escape from its moorings.

[O.M.&L. standards, appendix (part), filed 9/13/61.]

WAC 12-24-380 Appendix rules--Illustrations.

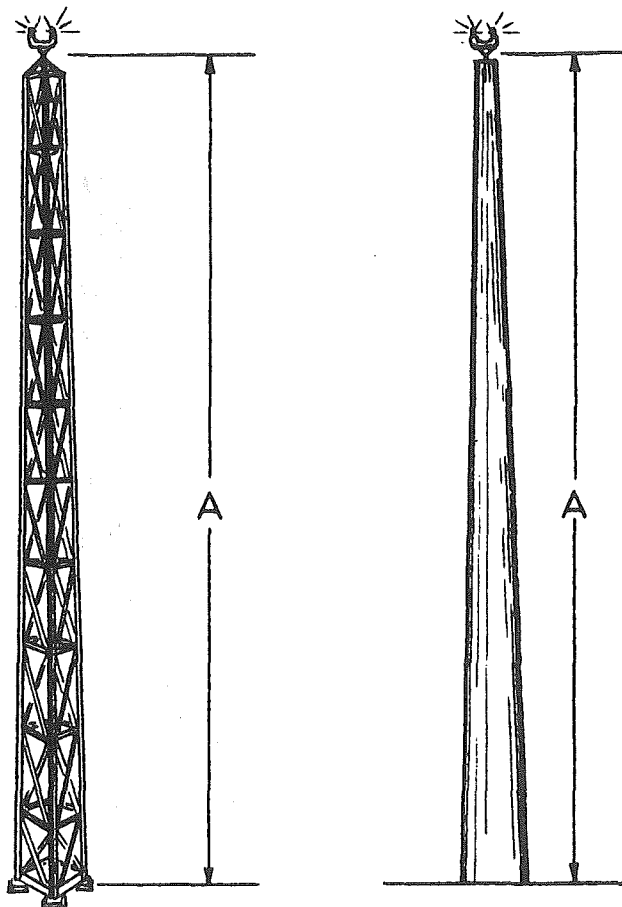

A = NOT MORE THAN 150 FT.

- (1) Lighting of towers, poles and similar obstructions.

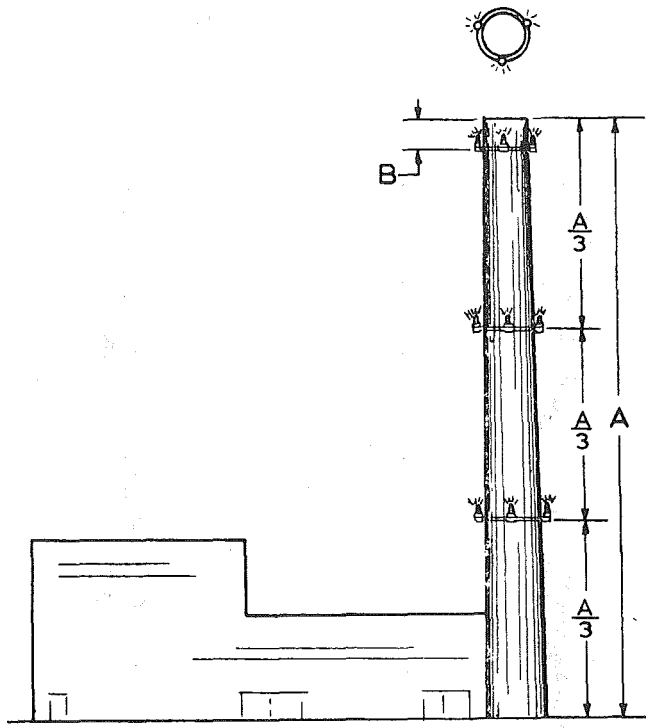

A = 300 TO 450 FT.
B = 5 TO 10 FT.

(2) Lighting of smokestacks and similar obstructions.

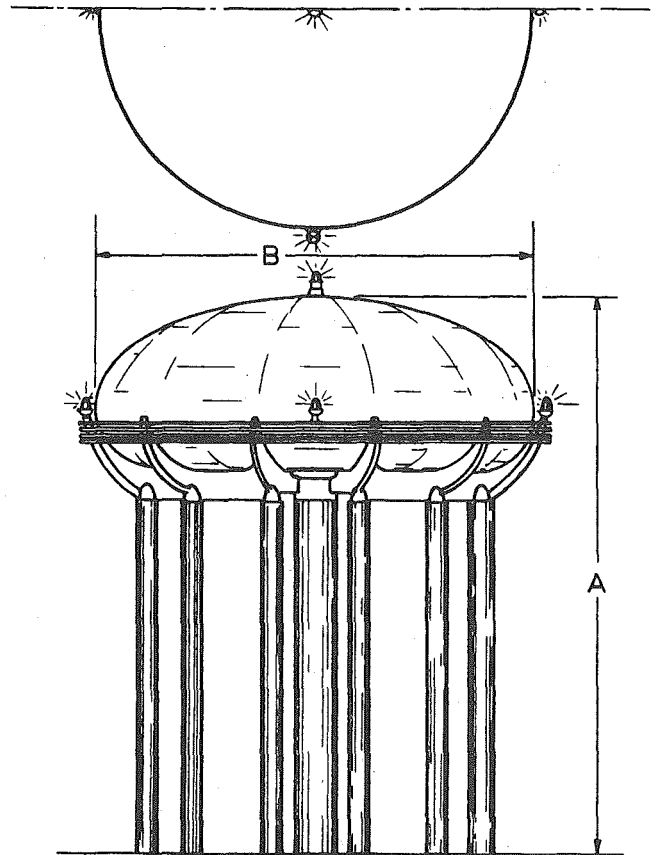

A = 150 TO 300 FT B = 150 FT OR LESS

(4) Lighting of water towers and similar obstructions.

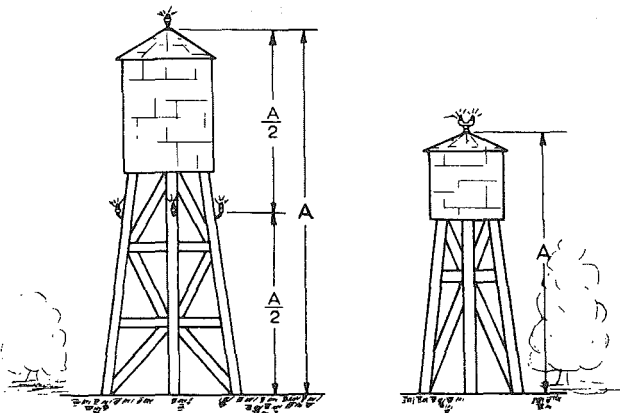

A = 150 TO 300 FT.
B = 150 FT OR LESS

A & B = 150 FT OR LESS

(3) Lighting of water towers and similar obstructions.

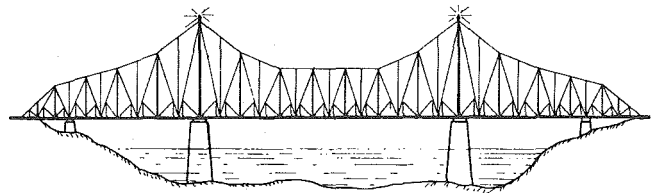

(5) Lighting of bridges.

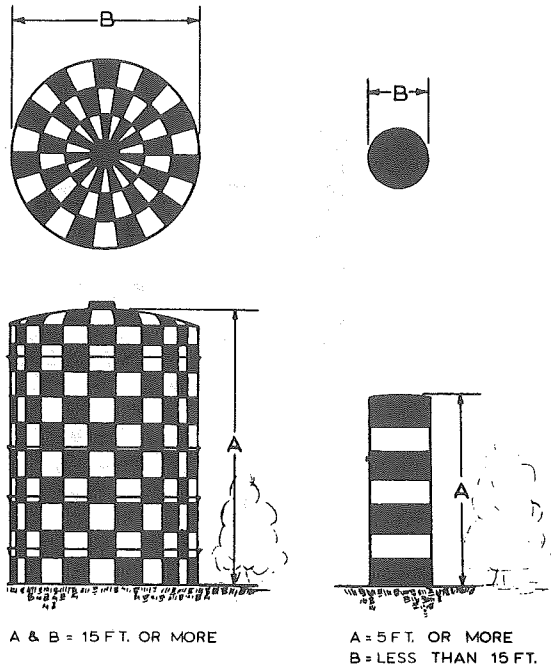
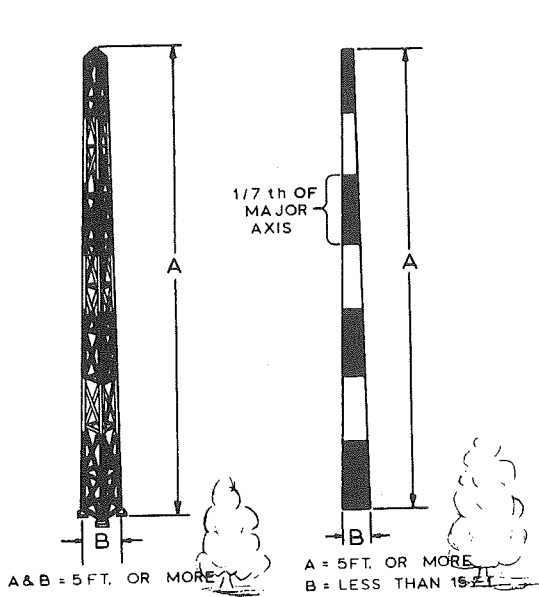

(6) Painting of towers, poles and similar obstructions.

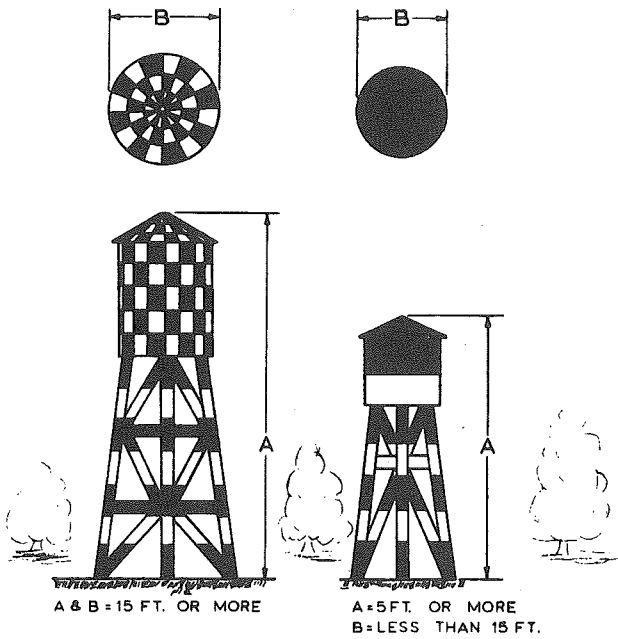

(7) Painting of water towers and similar obstructions.

(8) Painting of gas holders and similar obstructions.

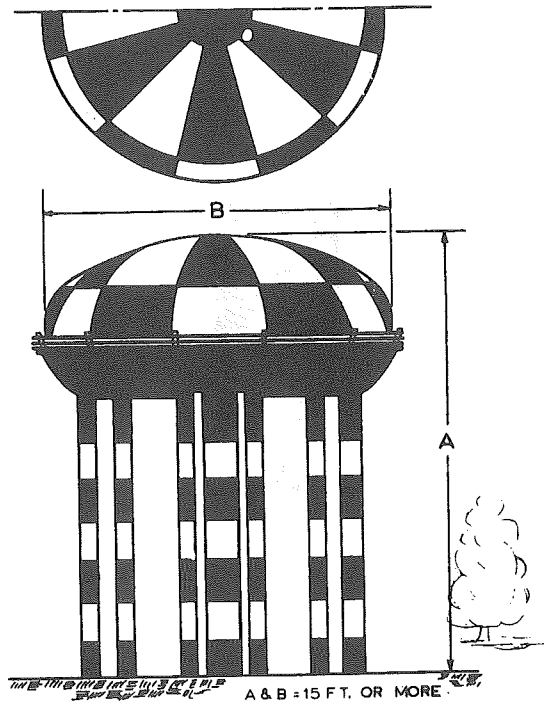

(9) Painting of water towers and similar obstructions.

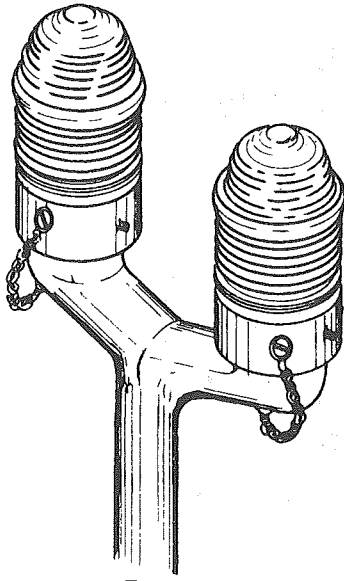

(10) Typical double obstruction light fitting.

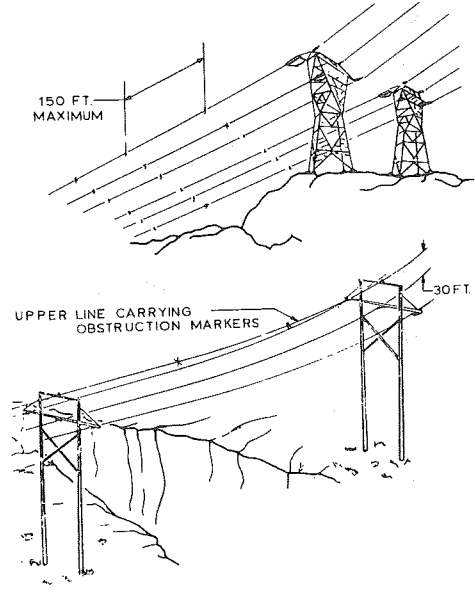

(12) Marking power lines, cables and similar obstructions.

[O.M.&L. standards, appendix (part), filed 9/13/61.]

**Chapter 12-40 WAC
STATE AIRPORT RULES**

WAC	
12-40-010	Definitions.
12-40-020	Aeronautics division to manage.
12-40-030	Opening and closing of airports.
12-40-040	Controlled operations.
12-40-050	Fees.
12-40-060	Nondiscrimination.
12-40-070	Exclusive grants prohibited.
12-40-080	Representations.
12-40-090	Provisions in agreements.
12-40-100	State/federal agreements controlling.
12-40-110	Grounds for refusal to grant agreement.
12-40-120	Preexisting agreements.
12-40-130	All use at own risk.
12-40-140	Temporary rules.
12-40-150	Accident notification.
12-40-160	Hazard notification.
12-40-170	Littering.

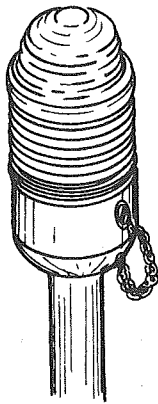

(11) Typical single obstruction light fitting.

WAC 12-40-010 Definitions. (1) "State airport" means any airport operated by the department of transportation, whether by agreement or ownership, including all real and personal property associated with the operation of the airport whether or not such property is owned by the department of transportation.

(2) "Controlled user" means any user of the airport whose use is controlled by an agreement with the department of transportation, including other governmental agencies.

(3) "Noncontrolled user" means any other person not included in subsection (2) of this section.

(4) "Special use permit" means any permit issued by the department of transportation to any person for the

conduct of activities at a state airport which are non-commercial in nature, such as (but not limited to) testing equipment, temporary easements, and long term parking of vehicles other than aircraft. A fee may or may not be charged.

(5) "Letter of agreement" means a letter issued to a person by the department of transportation trading the services of that person at a state airport for some benefit to that person. No fee will be charged.

(6) "NOTAM" means a notice to airmen issued by the Federal Aviation Administration.

(7) "Flowage fee" means a fee charged by the department of transportation on the amount of fuel delivered into aircraft at a state airport.

[Statutory Authority: RCW 47.68.100 and 47.68.210. 83-11-041 (Order 80), § 12-40-010, filed 5/18/83.]

WAC 12-40-020 Aeronautics division to manage.

The assistant secretary for aeronautics shall exercise all management powers incident to the operation of state airports.

[Statutory Authority: RCW 47.68.100 and 47.68.210. 83-11-041 (Order 80), § 12-40-020, filed 5/18/83.]

WAC 12-40-030 Opening and closing of airports.

(1) Because of surface conditions and/or snow cover, the following state airports will be closed to all traffic (except in an emergency) from approximately October 1 to June 1 of each year, by NOTAM.

- (a) Bandera
- (b) Lester
- (c) Nason Creek
- (d) Stehekin
- (e) Avey
- (f) Lake Wenatchee
- (g) Copalis
- (h) Sullivan Lake
- (i) Tieton
- (j) Ranger Creek
- (k) Skykomish
- (l) Easton

(2) The following state airports may be closed during the winter due to conditions, by NOTAM.

- (a) Winthrop/Intercity
- (b) Little Goose
- (c) Lower Granite
- (d) Quillayute
- (e) Lower Monumental
- (f) Woodland

(3) Opening and closing dates may change at some airports, and pilots shall check NOTAMS prior to using any state airport. It is strongly suggested that even when open, pilots should check with the aeronautics division on current conditions, especially at those airports located in mountainous areas.

[Statutory Authority: RCW 47.68.100 and 47.68.210. 83-11-041 (Order 80), § 12-40-030, filed 5/18/83.]

WAC 12-40-040 Controlled operations.

(1) The department of transportation may enter into any contract, lease, special use permit, letter of agreement, or other

arrangement with any person for controlled operations at state airports.

(2) All controlled operations shall be conducted only under an agreement with the department of transportation.

(3) The following operations require the execution of an agreement, lease, special use permit, or other arrangement as appropriate, between the department of transportation, and the controlled user:

- (a) Any construction on a state airport;
- (b) The permanent, semipermanent or seasonal use of hangars or tie-downs on a state airport, except transient use;
- (c) Any right-of-ground access other than by public roadway or easement, so called "through the fence" operations;
- (d) Fuel sales or storage at a state airport;
- (e) Long term parking of vehicles or storage of property;
- (f) Exchange of services between the department of transportation and a person or group;
- (g) Any commercial operation, except transient non-scheduled air taxi operations;
- (h) Any use of airport property which is not incidental to normal airport operations;
- (i) Glider towing, parachuting, ballooning, and ultralight use at state airports, except transient;
- (j) Any other use as may be designated by the department of transportation.

[Statutory Authority: RCW 47.68.100 and 47.68.210. 83-11-041 (Order 80), § 12-40-040, filed 5/18/83.]

WAC 12-40-050 Fees. (1) Any contract, lease, or special use permit executed may require the payment of fees to the department of transportation. Services may be accepted in lieu of fees, but only by prior agreement. No services will be applied to past fees incurred.

(2) All fees collected under this section by the department of transportation will be credited towards maintenance of all state airports.

(3) Fees for commercial operations will be commensurate with the value of the opportunity to do business on or at the airport and the services and facilities furnished by the state at the airport for which no separate charge is made.

[Statutory Authority: RCW 47.68.100 and 47.68.210. 83-11-041 (Order 80), § 12-40-050, filed 5/18/83.]

WAC 12-40-060 Nondiscrimination. No controlled user shall discriminate on the basis of race, sex, age, or national origin in the hiring and dismissal of employees, or in the use of his facilities.

[Statutory Authority: RCW 47.68.100 and 47.68.210. 83-11-041 (Order 80), § 12-40-060, filed 5/18/83.]

WAC 12-40-070 Exclusive grants prohibited. The department of transportation will not grant exclusive use rights of any kind at a state airport.

[Statutory Authority: RCW 47.68.100 and 47.68.210. 83-11-041 (Order 80), § 12-40-070, filed 5/18/83.]

WAC 12-40-080 Representations. No controlled user shall, in connection with raising any investment funds or advertising, represent to anyone that they have the endorsement, support, or approval of the state for any development or plan of action unless and until such endorsement has been given in writing.

[Statutory Authority: RCW 47.68.100 and 47.68.210. 83-11-041 (Order 80), § 12-40-080, filed 5/18/83.]

WAC 12-40-090 Provisions in agreements. All leases, special use permits, letters of agreement, or other documents shall contain the following provisions, as applicable:

(1) Transferability of any agreement is contingent on approval by the department of transportation. This shall include the sale of stock in a controlled user which would change the management of that use;

(2) All applicable Federal Aviation Administration regulations will be adhered to, and any violation of those regulations may be deemed a violation of the controlled user's agreement;

(3) In the event of violation of the terms of any agreement, the department of transportation will serve notice of the violation and where appropriate, notice of the corrective action that must be taken by the controlled user or notice of intention to forfeit said agreement. Provided, no forfeiture shall be taken before the expiration of ten days, during which time the controlled user may give notice of appeal to the secretary of transportation, who shall hear such appeal at a public meeting within thirty days and render a decision within five days of the public meeting;

(4) Commercial users shall, if deemed necessary by the department of transportation, give bond in favor of the state of Washington for the value of one year's fees, or the total of the value of the agreement if less than one year in term;

(5) Facilities constructed on state property under any agreement with the department of transportation shall become property of the department of transportation at the conclusion of the agreement including any renewals, extensions, or renegotiations of the agreement;

(6) Any disputes between a controlled user and the department of transportation, except violations of agreements for which forfeiture is sought, shall be submitted in writing to the secretary of transportation. The secretary shall provide a written decision within ten days which shall be the final, binding disposition of the the dispute;

(7) All facilities shall be open to inspection of department of transportation personnel at all times;

(8) Controlled users shall, as appropriate:

(a) Maintain insurance against fire, windstorm, and other hazards and, if applicable, hangar-keepers insurance;

(b) Maintain policies of public liability insurance in such amount as the department of transportation shall require;

(c) Hold the state harmless for all claims of liability arising from their use, and provide the department of transportation with certificate evidencing their insurance

coverage and naming the state of Washington as an additional insured.

[Statutory Authority: RCW 47.68.100 and 47.68.210. 83-11-041 (Order 80), § 12-40-090, filed 5/18/83.]

WAC 12-40-100 State/federal agreements controlling. Where the state of Washington has entered into an agreement with the federal government concerning a specific airport, that agreement will control, where applicable, any agreement sought or subsequently granted to a controlled user.

[Statutory Authority: RCW 47.68.100 and 47.68.210. 83-11-041 (Order 80), § 12-40-100, filed 5/18/83.]

WAC 12-40-110 Grounds for refusal to grant agreement. The department of transportation may refuse to grant an operating agreement to any person if:

(1) Safety will be compromised;

(2) The proposed operation is not consistent with airport purposes;

(3) The proposed operation is not in the best interests of the state of Washington; or

(4) The proposed operation is in conflict with prior agreements.

[Statutory Authority: RCW 47.68.100 and 47.68.210. 83-11-041 (Order 80), § 12-40-110, filed 5/18/83.]

WAC 12-40-120 Preexisting agreements. Any agreements existing on the date of this section shall continue in force under the terms of the agreement. All subsequent or renewal agreements will be made in conformance with these rules.

[Statutory Authority: RCW 47.68.100 and 47.68.210. 83-11-041 (Order 80), § 12-40-120, filed 5/18/83.]

WAC 12-40-130 All use at own risk. The use of state airports by all persons shall be solely at the risk of the user. State airports are maintained principally for emergency use and the state does not warrant the conditions at any state airport to be suitable for any other use.

[Statutory Authority: RCW 47.68.100 and 47.68.210. 83-11-041 (Order 80), § 12-40-130, filed 5/18/83.]

WAC 12-40-140 Temporary rules. The department of transportation may, from time to time, issue temporary and/or emergency rules affecting one or more state airports. These rules will be available from the aeronautics division and may be distributed, as necessary, by other means, including NOTAM.

[Statutory Authority: RCW 47.68.100 and 47.68.210. 83-11-041 (Order 80), § 12-40-140, filed 5/18/83.]

WAC 12-40-150 Accident notification. Any person involved in or witnessing an accident or hazardous incident at a state airport shall report such accident or incident to the aeronautics division as soon as possible. The report is required in addition to reports required under National Transportation Safety Board Rules, Part 830.

[Statutory Authority: RCW 47.68.100 and 47.68.210. 83-11-041 (Order 80), § 12-40-150, filed 5/18/83.]

WAC 12-40-160 Hazard notification. Any person having knowledge of hazards at or near a state airport is encouraged to notify the aeronautics division of the nature of the hazard.

[Statutory Authority: RCW 47.68.100 and 47.68.210. 83-11-041 (Order 80), § 12-40-160, filed 5/18/83.]

WAC 12-40-170 Littering. Because of their remote location, many state airports have no provision for trash removal. Users are expected to pack out all trash. Persons littering state airports will be prosecuted under the Litter Control Act, chapter 70.93 RCW.

[Statutory Authority: RCW 47.68.100 and 47.68.210. 83-11-041 (Order 80), § 12-40-170, filed 5/18/83.]