

# Title 246 WAC

## DEPARTMENT OF HEALTH

### Chapters

#### AGENCY DESCRIPTION

- 246-01 Description and organization.
- 246-03 State Environmental Policy Act—Guidelines.
- 246-05 Local public health—Guidelines.
- 246-08 Practice and procedure.
- 246-10 Administrative procedure—Adjudicative proceedings.
- 246-11 Model procedural rules for boards.
- 246-15 Whistleblower complaints in health care settings.
- 246-50 Coordinated quality improvement program.

#### COMMUNICABLE DISEASES

- 246-100 Communicable and certain other diseases.
- 246-110 Contagious disease—School districts and day care centers.

#### HUMAN IMMUNODEFICIENCY VIRUS (HIV)

- 246-130 Human immunodeficiency virus (HIV) infection interventions.

#### TUBERCULOSIS

- 246-170 Tuberculosis—Prevention, treatment, and control.
- 246-171 Tuberculosis—Financial responsibility.

#### ENVIRONMENTAL HEALTH

- 246-203 General sanitation.
- 246-205 Decontamination of illegal drug manufacturing or storage sites.

#### FOOD HANDLING

- 246-215 Food service.
- 246-217 Food worker permits.

#### RADIATION

- 246-220 Radiation protection—General provisions.
- 246-221 Radiation protection standards.
- 246-222 Radiation protection—Worker rights.
- 246-224 Radiation protection—Machine assembly and registration.
- 246-225 Radiation protection—X-rays in the healing arts.
- 246-227 Radiation protection—Industrial x-ray.
- 246-228 Radiation protection—Analytical x-ray equipment.
- 246-229 Radiation protection—Particle accelerators.
- 246-232 Radioactive material—Licensing applicability.
- 246-233 Radioactive materials—General licenses.
- 246-235 Radioactive materials—Specific licenses.
- 246-239 Radiation protection—Nuclear medicine.
- 246-240 Radiation protection—Medical therapy.

- 246-243 Radiation protection—Industrial radiography.
- 246-244 Radiation protection—Wireline services.
- 246-247 Radiation protection—Air emissions.
- 246-249 Radioactive waste—Use of the commercial disposal site.
- 246-250 Radioactive waste—Licensing land disposal.
- 246-252 Radiation protection—Uranium and/or thorium milling.
- 246-254 Radiation protection—Fees.

#### RECREATIONAL WATER

- 246-260 Water recreation facilities.
- 246-262 Recreational water contact facilities.

#### SEWER SYSTEMS

- 246-270 Sewer systems—Certification of necessity for water district involvement.
- 246-271 Public sewage.
- 246-272 On-site sewage systems.
- 246-273 On-site sewage system additives.

#### SHELLFISH

- 246-280 Recreational shellfish beaches.
- 246-282 Sanitary control of shellfish.

#### WATER SYSTEMS

- 246-290 Public water supplies.
- 246-291 Group B public water systems.
- 246-292 Water works operator certification.
- 246-293 Water System Coordination Act.
- 246-294 Drinking water operating permits.
- 246-295 Satellite system management agencies.

#### FACILITY STANDARDS AND LICENSING

- 246-310 Certificate of need.
- 246-314 Facility construction review.
- 246-316 Boarding homes.
- 246-318 Hospitals.
- 246-321 Hospice care center.
- 246-322 Private psychiatric and alcoholism hospitals.
- 246-323 Residential treatment facilities for psychiatrically impaired children and youth.
- 246-324 Private alcohol and chemical dependency hospitals.
- 246-325 Adult residential rehabilitation centers and private adult treatment homes.
- 246-326 Alcoholism treatment facilities.
- 246-327 Home health agencies.
- 246-328 Adult family home resident managers and providers.
- 246-329 Childbirth centers.
- 246-331 Hospice agencies.
- 246-333 Approval of eye banks.
- 246-336 Home care agency rules.

- 246-338 Medical test site rules.
- 246-340 Second trimester abortion facilities.
- 246-358 Temporary worker housing.
- 246-360 Transient accommodations.
- 246-366 Primary and secondary schools.
- 246-374 Outdoor music festivals.
- 246-376 Camps.
- 246-380 State institutional survey program.
- 246-388 Rural health care facility licensing rules.
- 246-390 Drinking water certification rules.

#### HEALTH INFORMATION

- 246-420 Sentinel birth defects.
- 246-430 Cancer reporting.
- 246-451 Hospitals—Assessments and related reports.
- 246-453 Hospital charity care.
- 246-454 Hospitals—System of accounting, financial reporting, budgeting, cost allocation.
- 246-455 Hospital patient discharge information reporting.
- 246-490 Vital statistics.
- 246-491 Vital statistics—Certificates.

#### HEALTH PROMOTION AND CHRONIC DISEASE PREVENTION

- 246-510 Standards for community health clinics.
- 246-560 Rural health system project.

#### LABORATORY

- 246-650 Newborn screening.
- 246-680 Prenatal tests—Congenital and heritable disorders.

#### PARENT/CHILD HEALTH

- 246-710 Coordinated children's services.
- 246-760 Auditory and visual standards—School districts.
- 246-762 Scoliosis screening—School districts.
- 246-780 Farmers' market nutrition program.
- 246-790 Special supplemental food program for women, infants, and children (WIC).

#### PROFESSIONAL STANDARDS AND LICENSING

- 246-800 General provisions—Professionals.
- 246-802 Acupuncturists.
- 246-808 Chiropractic quality assurance commission.
- 246-810 Counselors.
- 246-812 Board of denture technology.
- 246-815 Dental hygienists.
- 246-817 Dental quality assurance commission.
- 246-822 Dieticians or nutritionists.
- 246-824 Dispensing opticians.
- 246-826 Health care assistants.
- 246-828 Hearing aid fitters and dispensers.
- 246-830 Massage practitioners.
- 246-834 Midwives.
- 246-836 Naturopathic physicians.
- 246-838 Practical nurses.
- 246-839 Registered nurses.

- 246-840 Practical and registered nursing.
- 246-841 Nursing assistants.
- 246-842 Nursing assistants—Nursing homes—Nursing assistants training program.
- 246-843 Nursing home administrators.
- 246-845 Nursing pool.
- 246-847 Occupational therapists.
- 246-849 Ocularists.
- 246-851 Optometrists.
- 246-852 Consumer access to vision care.
- 246-853 Osteopathic physicians and surgeons.
- 246-854 Osteopathic physicians' assistants.
- 246-855 Osteopathic physicians' acupuncture assistants.
- 246-856 Board of pharmacy—General.
- 246-858 Pharmacists—Internship requirements.
- 246-861 Pharmacists—Professional pharmaceutical education.
- 246-863 Pharmacists—Licensing.
- 246-865 Pharmaceutical services—Extended care facility.
- 246-867 Impaired pharmacist rehabilitation.
- 246-869 Pharmacy licensing.
- 246-871 Pharmaceutical—Parenteral products for nonhospitalized patients.
- 246-873 Pharmacy—Hospital standards.
- 246-875 Pharmacy—Patient medication record systems.
- 246-877 Pharmaceutical—Sales prohibited.
- 246-878 Good compounding practices.
- 246-879 Pharmaceutical wholesalers.
- 246-881 Pharmacy—Prescription drug price advertising.
- 246-883 Pharmaceutical—Sales requiring prescriptions.
- 246-885 Pharmacy—Identification, imprints, markings, and labeling of legend drugs.
- 246-886 Animal control—Legend drugs.
- 246-887 Pharmacy—Regulations implementing the Uniform Controlled Substances Act.
- 246-889 Pharmaceutical—Precursor substance control.
- 246-891 Pharmacy—Prophylactics.
- 246-893 Pharmacy—Public records access pursuant to Initiative 276.
- 246-895 Pharmacy—Good manufacturing practice for finished pharmaceuticals.
- 246-897 Pharmacy—Drug availability.
- 246-899 Pharmaceutical—Drug product substitution.
- 246-901 Pharmacy assistants.
- 246-903 Nuclear pharmacies and pharmacists.
- 246-904 Health care entities.
- 246-905 Pharmacy—Home dialysis program.
- 246-907 Pharmaceutical licensing periods and fees.
- 246-915 Physical therapists.
- 246-918 Physician assistants—Medical quality assurance commission.
- 246-919 Medical quality assurance commission.
- 246-922 Podiatric physicians and surgeons.
- 246-924 Psychologists.
- 246-926 Radiological technologists.
- 246-928 Respiratory care practitioners.
- 246-930 Sex offender treatment provider.
- 246-933 Veterinarians—Veterinary board.



- 246-935** Veterinary animal technicians.  
**246-937** Certified veterinary medication clerks.

**TRAUMA/EMERGENCY MEDICAL SERVICES**

- 246-976** Emergency medical services and trauma care systems.

**DISPOSITION OF CHAPTERS FORMERLY  
 CODIFIED IN THIS TITLE**

**Chapter 246-09  
 REFUND OF FEES**

- 246-09-060 Refund of fees. [Statutory Authority: RCW 43.01.072, 90-08-003 (Order 044), § 246-09-060, filed 3/22/90, effective 4/22/90.] Decodified by 91-02-049 (Order 121), filed 12/27/90, effective 1/31/91. Statutory Authority: RCW 43.70.040. Recodified as WAC 246-08-560.

**Chapter 246-132  
 CLASS IV HIV HEALTH INSURANCE ELIGIBILITY**

- 246-132-020 Class IV human immunodeficiency virus (HIV) insurance program. [Statutory Authority: RCW 70.24.130 and 70.24.440, 92-02-018 (Order 224), § 246-132-020, filed 12/23/91, effective 1/23/92. Statutory Authority: RCW 43.70.040, 91-02-049 (Order 121), recodified as § 246-132-020, filed 12/27/90, effective 1/31/91. Statutory Authority: Chapter 70.24 RCW and 1989 c 260 § 3, 90-03-052 (Order 020), § 248-180-010, filed 1/16/90, effective 2/16/90.] Repealed by 94-06-048, filed 3/1/94, effective 4/1/94. Statutory Authority: RCW 70.24.130 and 70.24.440.
- 246-132-030 Eligibility. [Statutory Authority: RCW 43.70.040, 91-02-049 (Order 121), recodified as § 246-132-030, filed 12/27/90, effective 1/31/91. Statutory Authority: Chapter 70.24 RCW and 1989 c 260 § 3, 90-03-052 (Order 020), § 248-180-020, filed 1/16/90, effective 2/16/90.] Repealed by 94-06-048, filed 3/1/94, effective 4/1/94. Statutory Authority: RCW 70.24.130 and 70.24.440.

**Chapter 246-201  
 BASIC PLUMBING PRINCIPLES**

- 246-201-001 Purpose and nature of regulations. [Statutory Authority: RCW 43.20.050, 91-02-051 (Order 124B), recodified as § 246-201-001, filed 12/27/90, effective 1/31/91; Regulation .94.001, effective 3/11/60.] Repealed by 96-19-043, filed 9/12/96, effective 10/13/96. Statutory Authority: RCW 43.20.050.
- 246-201-020 Water supply requirements. [Statutory Authority: RCW 43.20.050, 91-02-051 (Order 124B), recodified as § 246-201-020, filed 12/27/90, effective 1/31/91; Regulation .94.010, effective 3/11/60.] Repealed by 96-19-043, filed 9/12/96, effective 10/13/96. Statutory Authority: RCW 43.20.050.
- 246-201-030 Volume of flow. [Statutory Authority: RCW 43.20.050, 91-02-051 (Order 124B), recodified as § 246-201-030, filed 12/27/90, effective 1/31/91; Regulation .94.020, effective 3/11/60.] Repealed by 96-19-043, filed 9/12/96, effective 10/13/96. Statutory Authority: RCW 43.20.050.
- 246-201-040 Size of pipes. [Statutory Authority: RCW 43.20.050, 91-02-051 (Order 124B), recodified as § 246-201-040, filed 12/27/90, effective 1/31/91; Regulation .94.030, effective 3/11/60.] Repealed by 96-19-043, filed 9/12/96, effective 10/13/96. Statutory Authority: RCW 43.20.050.
- 246-201-050 Boilers and hot water tanks. [Statutory Authority: RCW 43.20.050, 91-02-051 (Order 124B), recodified as § 246-201-050, filed 12/27/90, effective 1/31/91; Regulation .94.040, effective 3/11/60.] Repealed by 96-19-043, filed 9/12/96, effective 10/13/96. Statutory Authority: RCW 43.20.050.
- 246-201-060 Sewage connection. [Statutory Authority: RCW 43.20.050, 91-02-051 (Order 124B), recodified as § 246-201-060, filed 12/27/90, effective 1/31/91; Regulation .94.050, effective 3/11/60.] Repealed by 96-19-043, filed

- 9/12/96, effective 10/13/96. Statutory Authority: RCW 43.20.050.
- 246-201-070 Water closets—Multiple dwellings. [Statutory Authority: RCW 43.20.050, 91-02-051 (Order 124B), recodified as § 246-201-070, filed 12/27/90, effective 1/31/91; Regulation .94.060, effective 3/11/60.] Repealed by 96-19-043, filed 9/12/96, effective 10/13/96. Statutory Authority: RCW 43.20.050.
- 246-201-080 Plumbing fixtures. [Statutory Authority: RCW 43.20.050, 91-02-051 (Order 124B), recodified as § 246-201-080, filed 12/27/90, effective 1/31/91; Regulation .94.070, effective 3/11/60.] Repealed by 96-19-043, filed 9/12/96, effective 10/13/96. Statutory Authority: RCW 43.20.050.
- 246-201-090 Drainage systems. [Statutory Authority: RCW 43.20.050, 91-02-051 (Order 124B), recodified as § 246-201-090, filed 12/27/90, effective 1/31/91; Regulation .94.080, effective 3/11/60.] Repealed by 96-19-043, filed 9/12/96, effective 10/13/96. Statutory Authority: RCW 43.20.050.
- 246-201-100 Drainage pipes. [Statutory Authority: RCW 43.20.050, 91-02-051 (Order 124B), recodified as § 246-201-100, filed 12/27/90, effective 1/31/91; Regulation .94.090, effective 3/11/60.] Repealed by 96-19-043, filed 9/12/96, effective 10/13/96. Statutory Authority: RCW 43.20.050.
- 246-201-110 Cleanouts. [Statutory Authority: RCW 43.20.050, 91-02-051 (Order 124B), recodified as § 246-201-110, filed 12/27/90, effective 1/31/91; Regulation .94.100, effective 3/11/60.] Repealed by 96-19-043, filed 9/12/96, effective 10/13/96. Statutory Authority: RCW 43.20.050.
- 246-201-120 Traps. [Statutory Authority: RCW 43.20.050, 91-02-051 (Order 124B), recodified as § 246-201-120, filed 12/27/90, effective 1/31/91; Regulation .94.110, effective 3/11/60.] Repealed by 96-19-043, filed 9/12/96, effective 10/13/96. Statutory Authority: RCW 43.20.050.
- 246-201-130 Pipes—Adequate air circulation. [Statutory Authority: RCW 43.20.050, 91-02-051 (Order 124B), recodified as § 246-201-130, filed 12/27/90, effective 1/31/91; Regulation .94.120, effective 3/11/60.] Repealed by 96-19-043, filed 9/12/96, effective 10/13/96. Statutory Authority: RCW 43.20.050.
- 246-201-140 Soil stacks. [Statutory Authority: RCW 43.20.050, 91-02-051 (Order 124B), recodified as § 246-201-140, filed 12/27/90, effective 1/31/91; Regulation .94.130, effective 3/11/60.] Repealed by 96-19-043, filed 9/12/96, effective 10/13/96. Statutory Authority: RCW 43.20.050.
- 246-201-150 Water and air pressure tests. [Statutory Authority: RCW 43.20.050, 91-02-051 (Order 124B), recodified as § 246-201-150, filed 12/27/90, effective 1/31/91; Regulation .94.140, effective 3/11/60.] Repealed by 96-19-043, filed 9/12/96, effective 10/13/96. Statutory Authority: RCW 43.20.050.
- 246-201-160 Clogging substances. [Statutory Authority: RCW 43.20.050, 91-02-051 (Order 124B), recodified as § 246-201-160, filed 12/27/90, effective 1/31/91; Regulation .94.150, effective 3/11/60.] Repealed by 96-19-043, filed 9/12/96, effective 10/13/96. Statutory Authority: RCW 43.20.050.
- 246-201-170 Food receptacles and the drainage system. [Statutory Authority: RCW 43.20.050, 91-02-051 (Order 124B), recodified as § 246-201-170, filed 12/27/90, effective 1/31/91; Regulation .94.160, effective 3/11/60.] Repealed by 96-19-043, filed 9/12/96, effective 10/13/96. Statutory Authority: RCW 43.20.050.
- 246-201-180 Location of water closets. [Statutory Authority: RCW 43.20.050, 91-02-051 (Order 124B), recodified as § 246-201-180, filed 12/27/90, effective 1/31/91; Regulation .94.170, effective 3/11/60.] Repealed by 96-19-043, filed 9/12/96, effective 10/13/96. Statutory Authority: RCW 43.20.050.
- 246-201-190 Disposal where no sewers. [Statutory Authority: RCW 43.20.050, 91-02-051 (Order 124B), recodified as § 246-201-190, filed 12/27/90, effective 1/31/91; Regulation .94.180, effective 3/11/60.] Repealed by 96-19-043, filed 9/12/96, effective 10/13/96. Statutory Authority: RCW 43.20.050.
- 246-201-200 Backflow requirements. [Statutory Authority: RCW 43.20.050, 91-02-051 (Order 124B), recodified as § 246-

- 201-200, filed 12/27/90, effective 1/31/91; Regulation .94.190, effective 3/11/60.] Repealed by 96-19-043, filed 9/12/96, effective 10/13/96. Statutory Authority: RCW 43.20.050.
- 246-201-210 Sanitary maintenance. [Statutory Authority: RCW 43.20.050. 91-02-051 (Order 124B), recodified as § 246-201-210, filed 12/27/90, effective 1/31/91; Regulation .94.200, effective 3/11/60.] Repealed by 96-19-043, filed 9/12/96, effective 10/13/96. Statutory Authority: RCW 43.20.050.
- Chapter 246-255**  
**RADIATION PROTECTION—FORMS**
- 246-255 Forms. [Forms set forth within chapter 402-990 WAC were filed January 8, 1969, entitled "Instructions for preparation of application for radioactive material license," (Forms RHF-1, RHF-2, RHF-3, RHF-4, RHF-5, RHF-14-1, RHF-14-2). Chapter 402-990 WAC was recodified as chapter 246-255 by WSR 91-02-049 (Order 121), filed December 27, 1990, effective January 31, 1991. Statutory Authority: RCW 43.70.040.] Repealed by 96-19-041, filed 9/12/96, effective 10/13/96. Statutory Authority: RCW 43.70.040.
- Chapter 246-264**  
**WATER SAFETY TEACHING STATIONS**
- 246-264-010 Definitions. [Statutory Authority: RCW 43.20.050. 91-02-051 (Order 124B), recodified as § 246-264-010, filed 12/27/90, effective 1/31/91; Order 34, § 248-132-010, filed 6/26/70.] Repealed by 96-19-043, filed 9/12/96, effective 10/13/96. Statutory Authority: RCW 43.20.050.
- 246-264-020 Scope of chapter—Size and depth. [Statutory Authority: RCW 43.20.050. 92-02-020 (Order 226B), § 246-264-020, filed 12/23/91, effective 1/23/92; 91-02-051 (Order 124B), recodified as § 246-264-020, filed 12/27/90, effective 1/31/91; Order 34, § 248-132-020, filed 6/26/70.] Repealed by 96-19-043, filed 9/12/96, effective 10/13/96. Statutory Authority: RCW 43.20.050.
- 246-264-030 Approval for construction. [Statutory Authority: RCW 43.20.050. 92-02-020 (Order 226B), § 246-264-030, filed 12/23/91, effective 1/23/92; 91-02-051 (Order 124B), recodified as § 246-264-030, filed 12/27/90, effective 1/31/91; Order 34, § 248-132-030, filed 6/26/70.] Repealed by 96-19-043, filed 9/12/96, effective 10/13/96. Statutory Authority: RCW 43.20.050.
- 246-264-040 Drinking fountain. [Statutory Authority: RCW 43.20.050. 91-02-051 (Order 124B), recodified as § 246-264-040, filed 12/27/90, effective 1/31/91; Order 34, § 248-132-040, filed 6/26/70.] Repealed by 96-19-043, filed 9/12/96, effective 10/13/96. Statutory Authority: RCW 43.20.050.
- 246-264-050 Plans and specifications—Approval—Notice to local health officer. [Statutory Authority: RCW 43.20.050. 92-02-020 (Order 226B), § 246-264-050, filed 12/23/91, effective 1/23/92; 91-02-051 (Order 124B), recodified as § 246-264-050, filed 12/27/90, effective 1/31/91; Order 34, § 248-132-050, filed 6/26/70.] Repealed by 96-19-043, filed 9/12/96, effective 10/13/96. Statutory Authority: RCW 43.20.050.
- 246-264-060 Toilet facilities. [Statutory Authority: RCW 43.20.050. 91-02-051 (Order 124B), recodified as § 246-264-060, filed 12/27/90, effective 1/31/91; Order 34, § 248-132-060, filed 6/26/70.] Repealed by 96-19-043, filed 9/12/96, effective 10/13/96. Statutory Authority: RCW 43.20.050.
- 246-264-070 Location. [Statutory Authority: RCW 43.20.050. 91-02-051 (Order 124B), recodified as § 246-264-070, filed 12/27/90, effective 1/31/91; Order 34, § 248-132-070, filed 6/26/70.] Repealed by 96-19-043, filed 9/12/96, effective 10/13/96. Statutory Authority: RCW 43.20.050.
- 246-264-080 Enclosure and cover. [Statutory Authority: RCW 43.20.050. 92-02-020 (Order 226B), § 246-264-080, filed 12/23/91, effective 1/23/92; 91-02-051 (Order 124B), recodified as § 246-264-080, filed 12/27/90, effective 1/31/91; Order 34, § 248-132-080, filed 6/26/70.] Repealed by 96-19-043, filed 9/12/96, effective 10/13/96. Statutory Authority: RCW 43.20.050.
- 246-264-090 Rinsing shower. [Statutory Authority: RCW 43.20.050. 91-02-051 (Order 124B), recodified as § 246-264-090, filed 12/27/90, effective 1/31/91; Order 34, § 248-132-090, filed 6/26/70.] Repealed by 96-19-043, filed 9/12/96, effective 10/13/96. Statutory Authority: RCW 43.20.050.
- 246-264-100 Foot rinse. [Statutory Authority: RCW 43.20.050. 91-02-051 (Order 124B), recodified as § 246-264-100, filed 12/27/90, effective 1/31/91; Order 34, § 248-132-100, filed 6/26/70.] Repealed by 96-19-043, filed 9/12/96, effective 10/13/96. Statutory Authority: RCW 43.20.050.
- 246-264-110 Number of bathers permitted. [Statutory Authority: RCW 43.20.050. 91-02-051 (Order 124B), recodified as § 246-264-110, filed 12/27/90, effective 1/31/91; Order 34, § 248-132-110, filed 6/26/70.] Repealed by 96-19-043, filed 9/12/96, effective 10/13/96. Statutory Authority: RCW 43.20.050.
- 246-264-120 Water quality. [Statutory Authority: RCW 43.20.050. 92-02-020 (Order 226B), § 246-264-120, filed 12/23/91, effective 1/23/92; 91-02-051 (Order 124B), recodified as § 246-264-120, filed 12/27/90, effective 1/31/91; Order 34, § 248-132-120, filed 6/26/70.] Repealed by 96-19-043, filed 9/12/96, effective 10/13/96. Statutory Authority: RCW 43.20.050.
- 246-264-130 Chlorine content. [Statutory Authority: RCW 43.20.050. 91-02-051 (Order 124B), recodified as § 246-264-130, filed 12/27/90, effective 1/31/91; Order 34, § 248-132-130, filed 6/26/70.] Repealed by 96-19-043, filed 9/12/96, effective 10/13/96. Statutory Authority: RCW 43.20.050.
- 246-264-140 Water recirculation. [Statutory Authority: RCW 43.20.050. 92-02-020 (Order 226B), § 246-264-140, filed 12/23/91, effective 1/23/92; 91-02-051 (Order 124B), recodified as § 246-264-140, filed 12/27/90, effective 1/31/91; Order 34, § 248-132-140, filed 6/26/70.] Repealed by 96-19-043, filed 9/12/96, effective 10/13/96. Statutory Authority: RCW 43.20.050.
- 246-264-150 Operation and sanitary control. [Statutory Authority: RCW 43.20.050. 92-02-020 (Order 226B), § 246-264-150, filed 12/23/91, effective 1/23/92; 91-02-051 (Order 124B), recodified as § 246-264-150, filed 12/27/90, effective 1/31/91; Order 34, § 248-132-150, filed 6/26/70.] Repealed by 96-19-043, filed 9/12/96, effective 10/13/96. Statutory Authority: RCW 43.20.050.
- 246-264-160 Bath house. [Statutory Authority: RCW 43.20.050. 91-02-051 (Order 124B), recodified as § 246-264-160, filed 12/27/90, effective 1/31/91; Order 34, § 248-132-160, filed 6/26/70.] Repealed by 96-19-043, filed 9/12/96, effective 10/13/96. Statutory Authority: RCW 43.20.050.
- 246-264-170 First aid. [Statutory Authority: RCW 43.20.050. 91-02-051 (Order 124B), recodified as § 246-264-170, filed 12/27/90, effective 1/31/91; Order 34, § 248-132-170, filed 6/26/70.] Repealed by 96-19-043, filed 9/12/96, effective 10/13/96. Statutory Authority: RCW 43.20.050.
- 246-264-180 Emergency telephone list. [Statutory Authority: RCW 43.20.050. 91-02-051 (Order 124B), recodified as § 246-264-180, filed 12/27/90, effective 1/31/91; Order 34, § 248-132-180, filed 6/26/70.] Repealed by 96-19-043, filed 9/12/96, effective 10/13/96. Statutory Authority: RCW 43.20.050.
- 246-264-190 Telephone required. [Statutory Authority: RCW 43.20.050. 91-02-051 (Order 124B), recodified as § 246-264-190, filed 12/27/90, effective 1/31/91; Order 34, § 248-132-190, filed 6/26/70.] Repealed by 96-19-043, filed 9/12/96, effective 10/13/96. Statutory Authority: RCW 43.20.050.
- 246-264-200 Health menace prohibited. [Statutory Authority: RCW 43.20.050. 92-02-020 (Order 226B), § 246-264-200, filed 12/23/91, effective 1/23/92; 91-02-051 (Order 124B), recodified as § 246-264-200, filed 12/27/90, effective 1/31/91; Order 34, § 248-132-200, filed 6/26/70.] Repealed by 96-19-043, filed 9/12/96, effective 10/13/96. Statutory Authority: RCW 43.20.050.

## Chapter 246-334

## DISPOSITION OF HUMAN REMAINS

- 246-334-010 Definitions. [Statutory Authority: RCW 43.20.050. 91-02-051 (Order 124B), recodified as § 246-334-010, filed 12/27/90, effective 1/31/91; Regulation .112.010, filed 2/18/66.] Repealed by 92-02-019 (Order 225B), filed 12/23/91, effective 1/23/92. Statutory Authority: RCW 43.20.050.
- 246-334-020 Approval required for tissue preservation. [Statutory Authority: RCW 43.20.050. 91-02-051 (Order 124B), recodified as § 246-334-020, filed 12/27/90, effective 1/31/91; Regulation .112.020, filed 2/18/66.] Repealed by 92-02-019 (Order 225B), filed 12/23/91, effective 1/23/92. Statutory Authority: RCW 43.20.050.
- 246-334-030 Approval required for tissue preservation—Provisions for approval. [Statutory Authority: RCW 43.20.050. 91-02-051 (Order 124B), recodified as § 246-334-030, filed 12/27/90, effective 1/31/91; Regulation .112.030, filed 2/18/66.] Repealed by 92-02-019 (Order 225B), filed 12/23/91, effective 1/23/92. Statutory Authority: RCW 43.20.050.
- 246-334-040 Approval required for tissue preservation—Exemptions from approval. [Statutory Authority: RCW 43.20.050. 91-02-051 (Order 124B), recodified as § 246-334-040, filed 12/27/90, effective 1/31/91; Regulation .112.040, filed 2/18/66.] Repealed by 92-02-019 (Order 225B), filed 12/23/91, effective 1/23/92. Statutory Authority: RCW 43.20.050.
- 246-334-050 Records. [Statutory Authority: RCW 43.20.050. 91-02-051 (Order 124B), recodified as § 246-334-050, filed 12/27/90, effective 1/31/91; Regulation .112.050, filed 2/18/66.] Repealed by 92-02-019 (Order 225B), filed 12/23/91, effective 1/23/92. Statutory Authority: RCW 43.20.050.
- 246-334-060 Labels. [Statutory Authority: RCW 43.20.050. 91-02-051 (Order 124B), recodified as § 246-334-060, filed 12/27/90, effective 1/31/91; Regulation .112.060, filed 2/18/66.] Repealed by 92-02-019 (Order 225B), filed 12/23/91, effective 1/23/92. Statutory Authority: RCW 43.20.050.

## Chapter 246-378

## MOBILE HOME PARKS

- 246-378-010 Definition. [Statutory Authority: RCW 43.20.050. 91-02-051 (Order 124B), recodified as § 246-378-010, filed 12/27/90, effective 1/31/91. Statutory Authority: 1981 c 304. 81-24-056 (Order 220), § 248-75-010, filed 12/1/81.] Repealed by 96-19-043, filed 9/12/96, effective 10/13/96. Statutory Authority: RCW 43.20.050.
- 246-378-020 Sewage disposal. [Statutory Authority: RCW 43.20.050 and 59.20.190. 92-02-019 (Order 225B), § 246-378-020, filed 12/23/91, effective 1/23/92. Statutory Authority: RCW 43.20.050. 91-02-051 (Order 124B), recodified as § 246-378-020, filed 12/27/90, effective 1/31/91. Statutory Authority: 1981 c 304. 81-24-056 (Order 220), § 248-75-020, filed 12/1/81.] Repealed by 96-19-043, filed 9/12/96, effective 10/13/96. Statutory Authority: RCW 43.20.050.
- 246-378-030 Water supply. [Statutory Authority: RCW 43.20.050 and 59.20.190. 92-02-019 (Order 225B), § 246-378-030, filed 12/23/91, effective 1/23/92. Statutory Authority: RCW 43.20.050. 91-02-051 (Order 124B), recodified as § 246-378-030, filed 12/27/90, effective 1/31/91. Statutory Authority: 1981 c 304. 81-24-056 (Order 220), § 248-75-030, filed 12/1/81.] Repealed by 96-19-043, filed 9/12/96, effective 10/13/96. Statutory Authority: RCW 43.20.050.
- 246-378-040 Refuse disposal. [Statutory Authority: RCW 43.20.050 and 59.20.190. 92-02-019 (Order 225B), § 246-378-040, filed 12/23/91, effective 1/23/92. Statutory Authority: RCW 43.20.050. 91-02-051 (Order 124B), recodified as § 246-378-040, filed 12/27/90, effective 1/31/91. Statutory Authority: 1981 c 304. 81-24-056 (Order 220), § 248-75-040, filed 12/1/81.] Repealed by 96-19-043, filed 9/12/96, effective 10/13/96. Statutory Authority: RCW 43.20.050.

- 246-378-050 General sanitation. [Statutory Authority: RCW 43.20.050 and 59.20.190. 92-02-019 (Order 225B), § 246-378-050, filed 12/23/91, effective 1/23/92. Statutory Authority: RCW 43.20.050. 91-02-051 (Order 124B), recodified as § 246-378-050, filed 12/27/90, effective 1/31/91. Statutory Authority: 1981 c 304. 81-24-056 (Order 220), § 248-75-050, filed 12/1/81.] Repealed by 96-19-043, filed 9/12/96, effective 10/13/96. Statutory Authority: RCW 43.20.050.

## Chapter 246-450

## HOSPITAL DATA—PUBLIC RECORDS

- 246-450-001 Purpose. [Statutory Authority: RCW 43.70.040. 91-02-049 (Order 121), recodified as § 246-450-001, filed 12/27/90, effective 1/31/91; Order 73-01, § 261-06-010, filed 1/11/74.] Repealed by 94-12-089, filed 6/1/94, effective 7/2/94. Statutory Authority: Chapters 43.070 [43.70] and 70.170 RCW.
- 246-450-010 Definitions. [Statutory Authority: RCW 43.70.040. 91-02-049 (Order 121), recodified as § 246-450-010, filed 12/27/90, effective 1/31/91. Statutory Authority: Chapter 70.39 RCW. 83-06-036 (Order 83-02, Resolution No. 83-02), § 261-06-020, filed 2/28/83; Order 73-01, § 261-06-020, filed 1/11/74.] Repealed by 94-12-089, filed 6/1/94, effective 7/2/94. Statutory Authority: Chapters 43.070 [43.70] and 70.170 RCW.
- 246-450-020 Public records available. [Statutory Authority: RCW 43.70.040. 91-02-049 (Order 121), recodified as § 246-450-020, filed 12/27/90, effective 1/31/91. Statutory Authority: Chapter 70.39 RCW. 84-20-066 (Order 84-05, Resolution No. 84-05), § 261-06-030, filed 10/1/84; 83-06-036 (Order 83-02, Resolution No. 83-02), § 261-06-030, filed 2/28/83; Order 73-01, § 261-06-030, filed 1/11/74.] Repealed by 94-12-089, filed 6/1/94, effective 7/2/94. Statutory Authority: Chapters 43.070 [43.70] and 70.170 RCW.
- 246-450-030 Public records officer. [Statutory Authority: RCW 43.70.040. 91-02-049 (Order 121), recodified as § 246-450-030, filed 12/27/90, effective 1/31/91. Statutory Authority: Chapter 70.39 RCW. 84-20-066 (Order 84-05, Resolution No. 84-05), § 261-06-040, filed 10/1/84; Order 73-01, § 261-06-040, filed 1/11/74.] Repealed by 94-12-089, filed 6/1/94, effective 7/2/94. Statutory Authority: Chapters 43.070 [43.70] and 70.170 RCW.
- 246-450-040 Office hours. [Statutory Authority: RCW 43.70.040. 91-02-049 (Order 121), recodified as § 246-450-040, filed 12/27/90, effective 1/31/91. Statutory Authority: Chapter 70.39 RCW. 83-06-036 (Order 83-02, Resolution No. 83-02), § 261-06-050, filed 2/28/83; Order 73-01, § 261-06-050, filed 1/11/74.] Repealed by 94-12-089, filed 6/1/94, effective 7/2/94. Statutory Authority: Chapters 43.070 [43.70] and 70.170 RCW.
- 246-450-050 Requests for public records. [Statutory Authority: RCW 43.70.040. 91-02-049 (Order 121), recodified as § 246-450-050, filed 12/27/90, effective 1/31/91. Statutory Authority: Chapter 70.39 RCW. 83-06-036 (Order 83-02, Resolution No. 83-02), § 261-06-060, filed 2/28/83; Order 73-01, § 261-06-060, filed 1/11/74.] Repealed by 94-12-089, filed 6/1/94, effective 7/2/94. Statutory Authority: Chapters 43.070 [43.70] and 70.170 RCW.
- 246-450-060 Inspection and copying. [Statutory Authority: RCW 43.70.040. 91-02-049 (Order 121), recodified as § 246-450-060, filed 12/27/90, effective 1/31/91. Statutory Authority: RCW 42.17.250 through 42.17.340 and chapter 70.39 RCW. 87-22-005 (Order 87-03, Resolution No. 87-03), § 261-06-070, filed 10/23/87. Statutory Authority: Chapter 70.39 RCW. 83-06-036 (Order 83-02, Resolution No. 83-02), § 261-06-070, filed 2/28/83; Order 73-01, § 261-06-070, filed 1/11/74.] Repealed by 94-12-089, filed 6/1/94, effective 7/2/94. Statutory Authority: Chapters 43.070 [43.70] and 70.170 RCW.
- 246-450-070 Exemptions. [Statutory Authority: RCW 43.70.040. 91-02-049 (Order 121), recodified as § 246-450-070, filed 12/27/90, effective 1/31/91. Statutory Authority: RCW 42.17.250 through 42.17.340 and chapter 70.39 RCW. 87-22-005 (Order 87-03, Resolution No. 87-03), § 261-06-

080, filed 10/23/87. Statutory Authority: Chapter 70.39 RCW. 83-06-036 (Order 83-02, Resolution No. 83-02), § 261-06-080, filed 2/28/83; Order 73-01, § 261-06-080, filed 1/11/74.] Repealed by 94-12-089, filed 6/1/94, effective 7/2/94. Statutory Authority: Chapters 43.070 [43.70] and 70.170 RCW.

246-450-080 Review of denials of public records requests. [Statutory Authority: RCW 43.70.040. 91-02-049 (Order 121), recodified as § 246-450-080, filed 12/27/90, effective 1/31/91. Statutory Authority: RCW 42.17.250 through 42.17.340 and chapter 70.39 RCW. 87-22-005 (Order 87-03, Resolution No. 87-03), § 261-06-090, filed 10/23/87. Statutory Authority: Chapter 70.39 RCW. 83-06-036 (Order 83-02, Resolution No. 83-02), § 261-06-090, filed 2/28/83; Order 73-01, § 261-06-090, filed 1/11/74.] Repealed by 94-12-089, filed 6/1/94, effective 7/2/94. Statutory Authority: Chapters 43.070 [43.70] and 70.170 RCW.

246-450-090 Protection of public records. [Statutory Authority: RCW 43.70.040. 91-02-049 (Order 121), recodified as § 246-450-090, filed 12/27/90, effective 1/31/91. Statutory Authority: Chapter 70.39 RCW. 83-06-036 (Order 83-02, Resolution No. 83-02), § 261-06-100, filed 2/28/83; Order 73-01, § 261-06-100, filed 1/11/74.] Repealed by 94-12-089, filed 6/1/94, effective 7/2/94. Statutory Authority: Chapters 43.070 [43.70] and 70.170 RCW.

246-450-100 Records index. [Statutory Authority: RCW 43.70.040. 91-02-049 (Order 121), recodified as § 246-450-100, filed 12/27/90, effective 1/31/91. Statutory Authority: RCW 42.17.250 through 42.17.340 and chapter 70.39 RCW. 87-22-005 (Order 87-03, Resolution No. 87-03), § 261-06-110, filed 10/23/87; Order 73-01, § 261-06-110, filed 1/11/74.] Repealed by 94-12-089, filed 6/1/94, effective 7/2/94. Statutory Authority: Chapters 43.070 [43.70] and 70.170 RCW.

**Chapter 246-452**

**HOSPITAL PRICE INFORMATION REPORTING**

246-452-001 Purpose. [Statutory Authority: RCW 43.70.040. 91-02-049 (Order 121), recodified as § 246-452-001, filed 12/27/90, effective 1/31/91; Order 76-01, § 261-12-010, filed 2/13/76; Order 74-07, § 261-12-010, filed 5/10/74.] Repealed by 94-12-089, filed 6/1/94, effective 7/2/94. Statutory Authority: Chapters 43.070 [43.70] and 70.170 RCW.

246-452-010 Definitions. [Statutory Authority: RCW 43.70.040. 91-02-049 (Order 121), recodified as § 246-452-010, filed 12/27/90, effective 1/31/91. Statutory Authority: Chapter 70.39 RCW. 84-20-066 (Order 84-05, Resolution No. 84-05), § 261-12-020, filed 10/1/84; Order 76-01, § 261-12-020, filed 2/13/76; Order 74-07, § 261-12-020, filed 5/10/74.] Repealed by 94-12-089, filed 6/1/94, effective 7/2/94. Statutory Authority: Chapters 43.070 [43.70] and 70.170 RCW.

246-452-020 Report of changes in or new prices—Reporting form. [Statutory Authority: RCW 43.70.040. 91-02-049 (Order 121), recodified as § 246-452-020, filed 12/27/90, effective 1/31/91. Statutory Authority: Chapter 70.39 RCW. 83-06-036 (Order 83-02, Resolution No. 83-02), § 261-12-040, filed 2/28/83; Order 76-01, § 261-12-040, filed 2/13/76; Order 74-07, § 261-12-040, filed 5/10/74.] Repealed by 94-12-089, filed 6/1/94, effective 7/2/94. Statutory Authority: Chapters 43.070 [43.70] and 70.170 RCW.

246-452-030 Information regarding pricing policy. [Statutory Authority: RCW 43.70.040. 91-02-049 (Order 121), recodified as § 246-452-030, filed 12/27/90, effective 1/31/91. Statutory Authority: Chapter 70.39 RCW. 83-06-036 (Order 83-02, Resolution No. 83-02), § 261-12-050, filed 2/28/83; Order 76-01, § 261-12-050, filed 2/13/76; Order 74-07, § 261-12-050, filed 5/10/74.] Repealed by 94-12-089, filed 6/1/94, effective 7/2/94. Statutory Authority: Chapters 43.070 [43.70] and 70.170 RCW.

246-452-040 Time deadline for submission of report. [Statutory Authority: RCW 43.70.040. 91-02-049 (Order 121), recodified as § 246-452-040, filed 12/27/90, effective

1/31/91. Statutory Authority: Chapter 70.39 RCW. 83-06-036 (Order 83-02, Resolution No. 83-02), § 261-12-055, filed 2/28/83; Order 76-01, § 261-12-055, filed 2/13/76.] Repealed by 94-12-089, filed 6/1/94, effective 7/2/94. Statutory Authority: Chapters 43.070 [43.70] and 70.170 RCW.

246-452-050 Changes in contracts. [Statutory Authority: RCW 43.70.040. 91-02-049 (Order 121), recodified as § 246-452-050, filed 12/27/90, effective 1/31/91; Order 74-07, § 261-12-060, filed 5/10/74.] Repealed by 94-12-089, filed 6/1/94, effective 7/2/94. Statutory Authority: Chapters 43.070 [43.70] and 70.170 RCW.

246-452-060 Additional information request. [Statutory Authority: RCW 43.70.040. 91-02-049 (Order 121), recodified as § 246-452-060, filed 12/27/90, effective 1/31/91; Order 76-01, § 261-12-070, filed 2/13/76.] Repealed by 94-12-089, filed 6/1/94, effective 7/2/94. Statutory Authority: Chapters 43.070 [43.70] and 70.170 RCW.

246-452-070 Commission review and response to reports. [Statutory Authority: RCW 43.70.040. 91-02-049 (Order 121), recodified as § 246-452-070, filed 12/27/90, effective 1/31/91; Order 76-01, § 261-12-080, filed 2/13/76.] Repealed by 94-12-089, filed 6/1/94, effective 7/2/94. Statutory Authority: Chapters 43.070 [43.70] and 70.170 RCW.

246-452-080 Penalties for violation. [Statutory Authority: RCW 43.70.040. 91-02-049 (Order 121), recodified as § 246-452-080, filed 12/27/90, effective 1/31/91. Statutory Authority: RCW 70.39.180. 86-11-041 (Order 86-01, Resolution No. 86-01), § 261-12-090, filed 5/16/86.] Repealed by 94-12-089, filed 6/1/94, effective 7/2/94. Statutory Authority: Chapters 43.070 [43.70] and 70.170 RCW.

**Chapter 246-520  
KIDNEY CENTERS**

246-520-001 Purpose. [Statutory Authority: RCW 43.20.050. 92-02-019 (Order 225B), § 246-520-001, filed 12/23/91, effective 1/23/92; 91-02-051 (Order 124B), recodified as § 246-520-001, filed 12/27/90, effective 1/31/91; 80-06-065 (Order 198), § 248-30-070, filed 5/22/80.] Repealed by 94-05-052, filed 2/10/94, effective 3/13/94. Statutory Authority: RCW 43.20.050

246-520-010 Definitions. [Statutory Authority: RCW 43.20.050. 92-02-019 (Order 225B), § 246-520-010, filed 12/23/91, effective 1/23/92; 91-02-051 (Order 124B), recodified as § 246-520-010, filed 12/27/90, effective 1/31/91; 85-03-063 (Order 279), § 248-30-080, filed 1/15/85; 83-18-002 (Order 265), § 248-30-080, filed 8/25/83; 80-06-065 (Order 198), § 248-30-080, filed 5/22/80.] Repealed by 94-05-052, filed 2/10/94, effective 3/13/94. Statutory Authority: RCW 43.20.050

246-520-020 Services. [Statutory Authority: RCW 43.20.050. 92-02-019 (Order 225B), § 246-520-020, filed 12/23/91, effective 1/23/92; 91-02-051 (Order 124B), recodified as § 246-520-020, filed 12/27/90, effective 1/31/91; 80-06-065 (Order 198), § 248-30-090, filed 5/22/80.] Repealed by 94-05-052, filed 2/10/94, effective 3/13/94. Statutory Authority: RCW 43.20.050

246-520-030 Reimbursement. [Statutory Authority: RCW 43.20.050. 92-02-019 (Order 225B), § 246-520-030, filed 12/23/91, effective 1/23/92; 91-02-051 (Order 124B), recodified as § 246-520-030, filed 12/27/90, effective 1/31/91; 83-18-002 (Order 265), § 248-30-100, filed 8/25/83; 80-06-065 (Order 198), § 248-30-100, filed 5/22/80.] Repealed by 94-05-052, filed 2/10/94, effective 3/13/94. Statutory Authority: RCW 43.20.050

246-520-040 Eligibility. [Statutory Authority: RCW 43.20.050. 92-02-019 (Order 225B), § 246-520-040, filed 12/23/91, effective 1/23/92; 91-02-051 (Order 124B), recodified as § 246-520-040, filed 12/27/90, effective 1/31/91; 85-03-063 (Order 279), § 248-30-110, filed 1/15/85; 83-18-002 (Order 265), § 248-30-110, filed 8/25/83. Statutory Authority: RCW 43.20.050 and SB 5021. 82-19-070 (Order 243), § 248-30-110, filed 9/20/82. Statutory Authority: RCW 43.20.050. 80-06-065 (Order 198), §

- 248-30-110, filed 5/22/80.] Repealed by 94-05-052, filed 2/10/94, effective 3/13/94. Statutory Authority: RCW 43.20.050
- 246-520-050 Transfer of resources without adequate consideration. [Statutory Authority: RCW 43.20.050. 92-02-019 (Order 225B), § 246-520-050, filed 12/23/91, effective 1/23/92; 91-02-051 (Order 124B), recodified as § 246-520-050, filed 12/27/90, effective 1/31/91; 85-03-063 (Order 279), § 248-30-115, filed 1/15/85.] Repealed by 94-05-052, filed 2/10/94, effective 3/13/94. Statutory Authority: RCW 43.20.050
- 246-520-060 Fiscal information. [Statutory Authority: RCW 43.20.050. 92-02-019 (Order 225B), § 246-520-060, filed 12/23/91, effective 1/23/92; 91-02-051 (Order 124B), recodified as § 246-520-060, filed 12/27/90, effective 1/31/91; 80-06-065 (Order 198), § 248-30-120, filed 5/22/80.] Repealed by 94-05-052, filed 2/10/94, effective 3/13/94. Statutory Authority: RCW 43.20.050
- 246-520-070 Procedures for eligibility determination. [Statutory Authority: RCW 43.20.050. 92-02-019 (Order 225B), § 246-520-070, filed 12/23/91, effective 1/23/92; 91-02-051 (Order 124B), recodified as § 246-520-070, filed 12/27/90, effective 1/31/91; 85-03-063 (Order 279), § 248-30-130, filed 1/15/85; 83-18-002 (Order 265), § 248-30-130, filed 8/25/83.] Repealed by 94-05-052, filed 2/10/94, effective 3/13/94. Statutory Authority: RCW 43.20.050
- Chapter 246-610**  
**CYTOGENETIC LABORATORY SERVICES**
- 246-610-010 Definitions. [Statutory Authority: RCW 43.20.050. 91-02-051 (Order 124B), recodified as § 246-610-010, filed 12/27/90, effective 1/31/91; 83-12-049 (Order 258), § 248-160-010, filed 6/1/83.] Repealed by 96-19-043, filed 9/12/96, effective 10/13/96. Statutory Authority: RCW 43.20.050.
- 246-610-020 Performance of cytogenetic laboratory procedures. [Statutory Authority: RCW 43.20.050. 91-02-051 (Order 124B), recodified as § 246-610-020, filed 12/27/90, effective 1/31/91; 83-12-049 (Order 258), § 248-160-020, filed 6/1/83.] Repealed by 96-19-043, filed 9/12/96, effective 10/13/96. Statutory Authority: RCW 43.20.050.
- 246-610-030 Fees. [Statutory Authority: RCW 43.20.050. 91-02-051 (Order 124B), recodified as § 246-610-030, filed 12/27/90, effective 1/31/91; 83-12-049 (Order 258), § 248-160-030, filed 6/1/83.] Repealed by 96-19-043, filed 9/12/96, effective 10/13/96. Statutory Authority: RCW 43.20.050.
- 246-610-040 Eligibility for reduced fee or no-fee services. [Statutory Authority: RCW 43.20.050. 91-02-051 (Order 124B), recodified as § 246-610-040, filed 12/27/90, effective 1/31/91; 83-12-049 (Order 258), § 248-160-040, filed 6/1/83.] Repealed by 96-19-043, filed 9/12/96, effective 10/13/96. Statutory Authority: RCW 43.20.050.
- Chapter 246-806**  
**CHIROPRACTIC, DOCTORS OF—BOARD OF CHIROPRACTIC EXAMINERS**
- 246-806-010 Definitions. [Statutory Authority: RCW 18.25.017. 91-05-026 (Order 111B), recodified as § 246-806-010, filed 2/12/91, effective 3/15/91. Statutory Authority: RCW 18.25.025. 81-05-004 (Order PL 371), § 114-12-021, filed 2/6/81.] Repealed by 96-16-074, filed 8/6/96, effective 9/6/96. Statutory Authority: Chapter 18.25 RCW.
- 246-806-020 Colleges—Policy. [Statutory Authority: RCW 18.25.017. 91-05-026 (Order 111B), recodified as § 246-806-020, filed 2/12/91, effective 3/15/91. Statutory Authority: RCW 18.25.025. 81-05-004 (Order PL 371), § 114-12-011, filed 2/6/81.] Repealed by 96-16-074, filed 8/6/96, effective 9/6/96. Statutory Authority: Chapter 18.25 RCW.
- 246-806-030 Accreditation of colleges—Procedure. [Statutory Authority: RCW 18.25.017. 91-05-026 (Order 111B), recodified as § 246-806-030, filed 2/12/91, effective 3/15/91. Statutory Authority: RCW 18.25.025. 81-05-004 (Order PL 371), § 114-12-031, filed 2/6/81.] Repealed by 96-16-074, filed 8/6/96, effective 9/6/96. Statutory Authority: Chapter 18.25 RCW.
- 246-806-040 Colleges—Educational standards required for accreditation. [Statutory Authority: RCW 18.25.017. 91-05-026 (Order 111B), recodified as § 246-806-040, filed 2/12/91, effective 3/15/91; 87-24-063 (Order PM 692), § 114-12-041, filed 12/1/87. Statutory Authority: RCW 18.25.025. 83-01-028 (Order PL 414), § 114-12-041, filed 12/8/82; 81-22-078 (Order PL 385), § 114-12-041, filed 11/4/81; 81-05-004 (Order PL 371), § 114-12-041, filed 2/6/81.] Repealed by 96-16-074, filed 8/6/96, effective 9/6/96. Statutory Authority: Chapter 18.25 RCW.
- 246-806-050 Examination review and appeal procedures. [Statutory Authority: RCW 18.25.017. 91-05-026 (Order 111B), recodified as § 246-806-050, filed 2/12/91, effective 3/15/91; 86-06-043 (Order PL 582), § 114-12-115, filed 3/4/86.] Repealed by 92-17-026 (Order 297B), filed 8/11/92, effective 9/11/92. Statutory Authority: RCW 18.25.017.
- 246-806-060 Examinations. [Statutory Authority: RCW 18.25.017. 92-17-026 (Order 297B), § 246-806-060, filed 8/11/92, effective 9/11/92; 91-05-026 (Order 111B), recodified as § 246-806-060, filed 2/12/91, effective 3/15/91; 89-18-085 (Order PM 861), § 114-12-126, filed 9/6/89, effective 10/7/89.] Repealed by 96-16-074, filed 8/6/96, effective 9/6/96. Statutory Authority: Chapter 18.25 RCW.
- 246-806-070 Chiropractic examination scores. [Statutory Authority: RCW 18.25.017. 92-17-026 (Order 297B), § 246-806-070, filed 8/11/92, effective 9/11/92; 91-05-026 (Order 111B), recodified as § 246-806-070, filed 2/12/91, effective 3/15/91; 89-21-058, § 114-12-132, filed 10/16/89, effective 11/16/89; 87-24-063 (Order PM 692), § 114-12-132, filed 12/1/87.] Repealed by 96-16-074, filed 8/6/96, effective 9/6/96. Statutory Authority: Chapter 18.25 RCW.
- 246-806-075 Adjudicative proceedings—Procedural rules for the board of chiropractic examiners. [Statutory Authority: RCW 18.25.017 and 18.25.020. 93-20-061, § 246-806-075, filed 10/1/93, effective 11/1/93.] Repealed by 96-16-074, filed 8/6/96, effective 9/6/96. Statutory Authority: Chapter 18.25 RCW.
- 246-806-080 Licensees residing and practicing out-of-state—Continuing education requirements. [Statutory Authority: RCW 18.25.017. 91-05-026 (Order 111B), recodified as § 246-806-080, filed 2/12/91, effective 3/15/91. Statutory Authority: RCW 18.25.017 and 18.25.070. 80-11-073 (Order PL 355), § 114-12-150, filed 8/20/80.] Repealed by 96-16-074, filed 8/6/96, effective 9/6/96. Statutory Authority: Chapter 18.25 RCW.
- 246-806-085 Thirty-day permit. [Statutory Authority: RCW 18.25.017. 92-17-026 (Order 297B), § 246-806-085, filed 8/11/92, effective 9/11/92.] Repealed by 96-16-074, filed 8/6/96, effective 9/6/96. Statutory Authority: Chapter 18.25 RCW.
- 246-806-090 Board approved continuing education. [Statutory Authority: RCW 18.25.017. 92-17-026 (Order 297B), § 246-806-090, filed 8/11/92, effective 9/11/92; 91-05-026 (Order 111B), recodified as § 246-806-090, filed 2/12/91, effective 3/15/91. Statutory Authority: RCW 18.25.070 and 18.25.075. 90-22-036 (Order 096B), § 114-12-155, filed 11/1/90, effective 12/2/90. Statutory Authority: RCW 18.25.017. 89-18-086, § 114-12-155, filed 9/6/89, effective 10/7/89; 86-06-043 (Order PL 582), § 114-12-155, filed 3/4/86.] Repealed by 96-16-074, filed 8/6/96, effective 9/6/96. Statutory Authority: Chapter 18.25 RCW.
- 246-806-100 Prior approval not required. [Statutory Authority: RCW 18.25.017 and 18.25.020. 93-09-055 (Order 356B), § 246-806-100, filed 4/19/93, effective 5/20/93. Statutory Authority: RCW 18.25.017. 91-05-026 (Order 111B), recodified as § 246-806-100, filed 2/12/91, effective 3/15/91; 89-18-085 (Order PM 861), § 114-12-164, filed 9/6/89, effective 10/7/89.] Repealed by 96-16-074, filed 8/6/96, effective 9/6/96. Statutory Authority: Chapter 18.25 RCW.
- 246-806-110 License renewal—Affidavit of compliance with continuing education requirements. [Statutory Authority: RCW 18.25.017 and 18.25.020. 93-09-055 (Order 356B), § 246-

- 806-110, filed 4/19/93, effective 5/20/93. Statutory Authority: RCW 18.25.017. 91-05-026 (Order 111B), recodified as § 246-806-110, filed 2/12/91, effective 3/15/91; 89-18-085 (Order PM 861), § 114-12-170, filed 9/6/89, effective 10/7/89; 88-17-084 (Order PM 764), § 114-12-170, filed 8/22/88. Statutory Authority: RCW 18.25.017 and 18.25.070. 80-11-073 (Order PL 355), § 114-12-170, filed 8/20/80.] Repealed by 96-16-074, filed 8/6/96, effective 9/6/96. Statutory Authority: Chapter 18.25 RCW.
- 246-806-120 Exemptions. [Statutory Authority: RCW 18.25.017. 91-05-026 (Order 111B), recodified as § 246-806-120, filed 2/12/91, effective 3/15/91; 80-17-019 (Order PL 362), § 114-12-180, filed 11/13/80.] Repealed by 96-16-074, filed 8/6/96, effective 9/6/96. Statutory Authority: Chapter 18.25 RCW.
- 246-806-130 Lapsed and inactive licenses—Requirements for reinstating or activating a license. [Statutory Authority: RCW 18.25.017 and 18.25.020. 93-09-055 (Order 356B), § 246-806-130, filed 4/19/93, effective 5/20/93. Statutory Authority: RCW 18.25.017. 91-05-026 (Order 111B), recodified as § 246-806-130, filed 2/12/91, effective 3/15/91. Statutory Authority: RCW 18.25.070 and 18.25.075. 90-22-036 (Order 096B), § 114-12-190, filed 11/1/90, effective 12/2/90. Statutory Authority: RCW 18.25.017. 89-18-085 (Order PM 861), § 114-12-190, filed 9/6/89, effective 10/7/89.] Repealed by 96-16-074, filed 8/6/96, effective 9/6/96. Statutory Authority: Chapter 18.25 RCW.
- 246-806-140 AIDS prevention and information education requirements. [Statutory Authority: RCW 18.25.017 and 18.25.020. 93-09-055 (Order 356B), § 246-806-140, filed 4/19/93, effective 5/20/93. Statutory Authority: RCW 18.25.017. 91-05-026 (Order 111B), recodified as § 246-806-140, filed 2/12/91, effective 3/15/91. Statutory Authority: RCW 70.24.270. 88-23-060 (Order PM 799), § 114-12-200, filed 11/15/88.] Repealed by 96-16-074, filed 8/6/96, effective 9/6/96. Statutory Authority: Chapter 18.25 RCW.
- 246-806-150 Temporary permits—Recognized jurisdictions. [Statutory Authority: RCW 18.26.110. 92-02-022 (Order 229B), § 246-806-150, filed 12/23/91, effective 1/23/92.] Repealed by 93-09-055 (Order 356B), filed 4/19/93, effective 5/20/93. Statutory Authority: RCW 18.25.017 and 18.25.020.
- 246-806-160 Temporary permits—Issuance and duration. [Statutory Authority: RCW 18.25.017 and 18.25.020. 93-09-055 (Order 356B), § 246-806-160, filed 4/19/93, effective 5/20/93. Statutory Authority: RCW 18.26.110. 92-02-022 (Order 229B), § 246-806-160, filed 12/23/91, effective 1/23/92.] Repealed by 96-16-074, filed 8/6/96, effective 9/6/96. Statutory Authority: Chapter 18.25 RCW.
- 246-806-170 Licensure by endorsement. [Statutory Authority: RCW 18.26.110. 92-02-022 (Order 229B), § 246-806-170, filed 12/23/91, effective 1/23/92.] Repealed by 96-16-074, filed 8/6/96, effective 9/6/96. Statutory Authority: Chapter 18.25 RCW.
- 246-806-180 Preceptor or direct supervisory doctor. [Statutory Authority: RCW 18.25.017. 92-17-026 (Order 297B), § 246-806-180, filed 8/11/92, effective 9/11/92. Statutory Authority: RCW 18.26.110. 92-02-022 (Order 229B), § 246-806-180, filed 12/23/91, effective 1/23/92.] Repealed by 96-16-074, filed 8/6/96, effective 9/6/96. Statutory Authority: Chapter 18.25 RCW.
- 246-806-190 Registration of chiropractic x-ray technicians. [Statutory Authority: RCW 18.25.017 and 18.25.020. 93-09-055 (Order 356B), § 246-806-190, filed 4/19/93, effective 5/20/93. Statutory Authority: RCW 18.26.110. 92-02-022 (Order 229B), § 246-806-190, filed 12/23/91, effective 1/23/92.] Repealed by 96-16-074, filed 8/6/96, effective 9/6/96. Statutory Authority: Chapter 18.25 RCW.
- 246-806-990 Chiropractic fees. [Statutory Authority: RCW 43.70.250. 92-07-017 (Order 251), § 246-806-990, filed 3/9/92, effective 4/9/92; 91-21-096 (Order 207), § 246-806-990, filed 10/21/91, effective 11/21/91. Statutory Authority: RCW 43.70.040. 91-05-031 (Order 136), recodified as § 246-806-990, filed 2/12/91, effective 3/15/91. Statutory Authority: RCW 43.70.250. 90-04-094 (Order 029), § 114-12-136, filed 2/7/90, effective 3/10/90. Statutory Authority: RCW 43.24.086. 87-10-028 (Order PM 650), § 114-12-136, filed 5/1/87; 83-22-060 (Order PL 446), § 114-12-136, filed 11/2/83. Formerly WAC 114-12-135.] Repealed by 96-16-074, filed 8/6/96, effective 9/6/96. Statutory Authority: Chapter 18.25 RCW.

**Chapter 246-807**  
**CHIROPRACTIC, DOCTORS OF—CHIROPRACTIC**  
**DISCIPLINARY BOARD**

- 246-807-020 Privileged communications. [Statutory Authority: RCW 18.26.110. 91-05-095 (Order 110B), recodified as § 246-807-020, filed 2/20/91, effective 3/23/91; Order PL 235, § 113-10-010, filed 12/31/75.] Repealed by 96-16-074, filed 8/6/96, effective 9/6/96. Statutory Authority: Chapter 18.25 RCW.
- 246-807-030 Patient abandonment. [Statutory Authority: RCW 18.26.110. 91-05-095 (Order 110B), recodified as § 246-807-030, filed 2/20/91, effective 3/23/91; Order PL 235, § 113-10-020, filed 12/31/75.] Repealed by 96-16-074, filed 8/6/96, effective 9/6/96. Statutory Authority: Chapter 18.25 RCW.
- 246-807-040 Consultation. [Statutory Authority: RCW 18.26.110. 91-05-095 (Order 110B), recodified as § 246-807-040, filed 2/20/91, effective 3/23/91; Order PL 235, § 113-10-030, filed 12/31/75.] Repealed by 96-16-074, filed 8/6/96, effective 9/6/96. Statutory Authority: Chapter 18.25 RCW.
- 246-807-050 Unethical requests. [Statutory Authority: RCW 18.26.110. 91-05-095 (Order 110B), recodified as § 246-807-050, filed 2/20/91, effective 3/23/91; Order PL 235, § 113-10-040, filed 12/31/75.] Repealed by 96-16-074, filed 8/6/96, effective 9/6/96. Statutory Authority: Chapter 18.25 RCW.
- 246-807-060 Patient welfare. [Statutory Authority: RCW 18.26.110. 91-05-095 (Order 110B), recodified as § 246-807-060, filed 2/20/91, effective 3/23/91; Order PL 235, § 113-10-050, filed 12/31/75.] Repealed by 96-16-074, filed 8/6/96, effective 9/6/96. Statutory Authority: Chapter 18.25 RCW.
- 246-807-070 Patient disclosure. [Statutory Authority: RCW 18.26.110. 91-05-095 (Order 110B), recodified as § 246-807-070, filed 2/20/91, effective 3/23/91; Order PL 235, § 113-10-060, filed 12/31/75.] Repealed by 96-16-074, filed 8/6/96, effective 9/6/96. Statutory Authority: Chapter 18.25 RCW.
- 246-807-080 Degree of skill. [Statutory Authority: RCW 18.26.110. 91-05-095 (Order 110B), recodified as § 246-807-080, filed 2/20/91, effective 3/23/91; Order PL 235, § 113-10-070, filed 12/31/75.] Repealed by 96-16-074, filed 8/6/96, effective 9/6/96. Statutory Authority: Chapter 18.25 RCW.
- 246-807-090 Illegal practitioners. [Statutory Authority: RCW 18.26.110. 91-05-095 (Order 110B), recodified as § 246-807-090, filed 2/20/91, effective 3/23/91; Order PL 235, § 113-10-090, filed 12/31/75.] Repealed by 96-16-074, filed 8/6/96, effective 9/6/96. Statutory Authority: Chapter 18.25 RCW.
- 246-807-100 Excessive professional charges. [Statutory Authority: RCW 18.26.110. 91-05-095 (Order 110B), recodified as § 246-807-100, filed 2/20/91, effective 3/23/91; 84-01-054 (Order PL 453), § 113-10-100, filed 12/16/83; Order PL 235, § 113-10-100, filed 12/31/75.] Repealed by 96-16-074, filed 8/6/96, effective 9/6/96. Statutory Authority: Chapter 18.25 RCW.
- 246-807-110 Disparaging other practitioners. [Statutory Authority: RCW 18.26.110. 91-05-095 (Order 110B), recodified as § 246-807-110, filed 2/20/91, effective 3/23/91; Order PL 235, § 113-10-110, filed 12/31/75.] Repealed by 96-16-074, filed 8/6/96, effective 9/6/96. Statutory Authority: Chapter 18.25 RCW.
- 246-807-115 Adjudicative proceedings—Procedural rules for the chiropractic disciplinary board. [Statutory Authority: RCW 18.26.110. 94-08-053, § 246-807-115, filed 4/1/94,



- effective 5/2/94.] Repealed by 96-16-074, filed 8/6/96, effective 9/6/96. Statutory Authority: Chapter 18.25 RCW.
- 246-807-120 Identification. [Statutory Authority: RCW 18.26.110. 91-05-095 (Order 110B), recodified as § 246-807-120, filed 2/20/91, effective 3/23/91; 84-01-054 (Order PL 453), § 113-12-010, filed 12/16/83; Order PL-137, § 113-12-010, filed 11/13/72; Order 8, § 113-12-010, filed 9/9/68.] Repealed by 96-16-074, filed 8/6/96, effective 9/6/96. Statutory Authority: Chapter 18.25 RCW.
- 246-807-125 License renewal form. [Statutory Authority: RCW 18.26.110. 94-16-012, § 246-807-125, filed 7/21/94, effective 8/21/94.] Repealed by 96-16-074, filed 8/6/96, effective 9/6/96. Statutory Authority: Chapter 18.25 RCW.
- 246-807-130 Health food store ownership. [Statutory Authority: RCW 18.26.110. 91-05-095 (Order 110B), recodified as § 246-807-130, filed 2/20/91, effective 3/23/91; 86-10-039 (Order PL 591), § 113-12-075, filed 5/5/86.] Repealed by 96-16-074, filed 8/6/96, effective 9/6/96. Statutory Authority: Chapter 18.25 RCW.
- 246-807-135 Cooperation with investigation. [Statutory Authority: RCW 18.26.110. 94-16-012, § 246-807-135, filed 7/21/94, effective 8/21/94.] Repealed by 96-16-074, filed 8/6/96, effective 9/6/96. Statutory Authority: Chapter 18.25 RCW.
- 246-807-140 Vitamins, minerals and food supplements. [Statutory Authority: RCW 18.26.110. 91-05-095 (Order 110B), recodified as § 246-807-140, filed 2/20/91, effective 3/23/91; 86-10-039 (Order PL 591), § 113-12-080, filed 5/5/86. Statutory Authority: RCW 18.26.110(2). 84-23-033 (Order PL 497), § 113-12-080, filed 11/15/84; Order 8, § 113-12-080, filed 9/9/68.] Repealed by 96-16-074, filed 8/6/96, effective 9/6/96. Statutory Authority: Chapter 18.25 RCW.
- 246-807-150 Pelvic or prostate examination prohibited. [Statutory Authority: RCW 18.26.110. 91-05-095 (Order 110B), recodified as § 246-807-150, filed 2/20/91, effective 3/23/91; 84-01-054 (Order PL 453), § 113-12-085, filed 12/16/83.] Repealed by 96-16-074, filed 8/6/96, effective 9/6/96. Statutory Authority: Chapter 18.25 RCW.
- 246-807-160 Intravaginal adjustment restricted. [Statutory Authority: RCW 18.26.110. 91-05-095 (Order 110B), recodified as § 246-807-160, filed 2/20/91, effective 3/23/91. Statutory Authority: RCW 18.130.050(1). 87-05-064 (Order PM 640), § 113-12-087, filed 2/18/87.] Repealed by 96-16-074, filed 8/6/96, effective 9/6/96. Statutory Authority: Chapter 18.25 RCW.
- 246-807-170 Billing. [Statutory Authority: RCW 18.26.110. 91-05-095 (Order 110B), recodified as § 246-807-170, filed 2/20/91, effective 3/23/91; 89-01-017 (Order PM 806), § 113-12-101, filed 12/9/88, effective 2/1/89.] Repealed by 91-10-051 (Order 162B), filed 4/26/91, effective 5/27/91. Statutory Authority: RCW 18.26.110 and 18.130.050.
- 246-807-171 Billing. [Statutory Authority: RCW 18.26.110 and 18.130.050. 91-10-051 (Order 162B), § 246-807-171, filed 4/26/91, effective 5/27/91.] Repealed by 96-16-074, filed 8/6/96, effective 9/6/96. Statutory Authority: Chapter 18.25 RCW.
- 246-807-173 Documentation of care. [Statutory Authority: RCW 18.26.110. 94-16-012, § 246-807-173, filed 7/21/94, effective 8/21/94. Statutory Authority: RCW 18.26.110 and 18.130.050. 91-10-051 (Order 162B), § 246-807-173, filed 4/26/91, effective 5/27/91.] Repealed by 96-16-074, filed 8/6/96, effective 9/6/96. Statutory Authority: Chapter 18.25 RCW.
- 246-807-180 Radiographic standards. [Statutory Authority: RCW 18.26.110. 91-24-052 (Order 220B), § 246-807-180, filed 11/27/91, effective 12/28/91; 91-05-095 (Order 110B), recodified as § 246-807-180, filed 2/20/91, effective 3/23/91; 89-01-017 (Order PM 806), § 113-12-103, filed 12/9/88, effective 2/1/89.] Repealed by 96-16-074, filed 8/6/96, effective 9/6/96. Statutory Authority: Chapter 18.25 RCW.
- 246-807-190 Delegation of services to auxiliary staff and graduate doctors of chiropractic. [Statutory Authority: RCW 18.26.110. 91-05-095 (Order 110B), recodified as § 246-807-190, filed 2/20/91, effective 3/23/91. Statutory Authority: RCW 18.26.110 and 18.130.050. 90-22-037 (Order 097B), § 113-12-104, filed 11/1/90, effective 12/2/90.] Repealed by 96-16-074, filed 8/6/96, effective 9/6/96. Statutory Authority: Chapter 18.25 RCW.
- 246-807-200 Acupuncture. [Statutory Authority: RCW 18.26.110. 91-05-095 (Order 110B), recodified as § 246-807-200, filed 2/20/91, effective 3/23/91. Statutory Authority: RCW 18.130.050(1). 87-05-064 (Order PM 640), § 113-12-115, filed 2/18/87; Order PL 235, § 113-12-115, filed 12/31/75. Formerly WAC 113-12-110.] Repealed by 96-16-074, filed 8/6/96, effective 9/6/96. Statutory Authority: Chapter 18.25 RCW.
- 246-807-210 Future care contracts prohibited. [Statutory Authority: RCW 18.26.110. 91-05-095 (Order 110B), recodified as § 246-807-210, filed 2/20/91, effective 3/23/91; 84-01-054 (Order PL 453), § 113-12-120, filed 12/16/83. Statutory Authority: RCW 18.26.110 (1) and (2). 79-10-099 (Order PL 315), § 113-12-120, filed 9/25/79; Order PL-145, § 113-12-120, filed 6/6/73.] Repealed by 96-16-074, filed 8/6/96, effective 9/6/96. Statutory Authority: Chapter 18.25 RCW.
- 246-807-220 Ethical standards—Prohibited publicity and advertising. [Statutory Authority: RCW 18.26.110. 91-05-095 (Order 110B), recodified as § 246-807-220, filed 2/20/91, effective 3/23/91; 87-24-064 (Order PM 693), § 113-12-150, filed 12/1/87; 84-01-054 (Order PL 453), § 113-12-150, filed 12/16/83; 80-11-043 (Order PL-352, Resolution No. 8-80), § 113-12-150, filed 8/18/80. Statutory Authority: RCW 18.26.110 (1) and (2). 79-10-099 (Order PL 315), § 113-12-150, filed 9/25/79. Statutory Authority: RCW 18.26.110(2). 78-05-052 (Order PL 287, Resolution No. 78-142), § 113-12-150, filed 4/25/78.] Repealed by 96-16-074, filed 8/6/96, effective 9/6/96. Statutory Authority: Chapter 18.25 RCW.
- 246-807-230 Ethical standards—Honoring of publicity and advertisements. [Statutory Authority: RCW 18.26.110. 91-24-052 (Order 220B), § 246-807-230, filed 11/27/91, effective 12/28/91; 91-05-095 (Order 110B), recodified as § 246-807-230, filed 2/20/91, effective 3/23/91. Statutory Authority: RCW 18.26.110(2). 78-05-052 (Order PL 287, Resolution 78-142), § 113-12-165, filed 4/25/78.] Repealed by 96-16-074, filed 8/6/96, effective 9/6/96. Statutory Authority: Chapter 18.25 RCW.
- 246-807-240 Ethical standards—Prohibited transactions. [Statutory Authority: RCW 18.26.110. 91-05-095 (Order 110B), recodified as § 246-807-240, filed 2/20/91, effective 3/23/91. Statutory Authority: RCW 18.26.110(2). 78-05-052 (Order PL 287, Resolution 78-142), § 113-12-170, filed 4/25/78.] Repealed by 96-16-074, filed 8/6/96, effective 9/6/96. Statutory Authority: Chapter 18.25 RCW.
- 246-807-250 Ethical standards—Professional notices, letterheads, cards, and mailings. [Statutory Authority: RCW 18.26.110. 91-24-052 (Order 220B), § 246-807-250, filed 11/27/91, effective 12/28/91; 91-05-095 (Order 110B), recodified as § 246-807-250, filed 2/20/91, effective 3/23/91. Statutory Authority: RCW 18.26.110(2). 78-05-052 (Order PL 287, Resolution 78-142), § 113-12-175, filed 4/25/78.] Repealed by 96-16-074, filed 8/6/96, effective 9/6/96. Statutory Authority: Chapter 18.25 RCW.
- 246-807-260 Ethical standards—Suggestion of need of chiropractic services. [Statutory Authority: RCW 18.26.110. 91-05-095 (Order 110B), recodified as § 246-807-260, filed 2/20/91, effective 3/23/91. Statutory Authority: RCW 18.26.110(2). 78-05-052 (Order PL 287, Resolution 78-142), § 113-12-180, filed 4/25/78.] Repealed by 96-16-074, filed 8/6/96, effective 9/6/96. Statutory Authority: Chapter 18.25 RCW.
- 246-807-270 Public testimonial advertising. [Statutory Authority: RCW 18.26.110. 91-05-095 (Order 110B), recodified as § 246-807-270, filed 2/20/91, effective 3/23/91. Statutory Authority: RCW 18.26.110(2). 84-23-033 (Order PL 497), § 113-12-190, filed 11/15/84.] Repealed by 96-16-



- 074, filed 8/6/96, effective 9/6/96. Statutory Authority: Chapter 18.25 RCW.
- 246-807-280 Full disclosure of cost of services. [Statutory Authority: RCW 18.26.110 and chapter 18.26 RCW. 93-24-107, § 246-807-280, filed 12/1/93, effective 1/1/94. Statutory Authority: RCW 18.26.110. 91-05-095 (Order 110B), recodified as § 246-807-280, filed 2/20/91, effective 3/23/91; 89-16-095 (Order PM 852), § 113-12-195, filed 8/2/89, effective 9/2/89; 87-24-064 (Order PM 693), § 113-12-195, filed 12/1/87. Statutory Authority: RCW 18.130.050(1). 87-05-064 (Order PM 640), § 113-12-195, filed 2/18/87. Statutory Authority: RCW 18.26.110(2). 84-23-033 (Order PL 497), § 113-12-195, filed 11/15/84.] Repealed by 96-16-074, filed 8/6/96, effective 9/6/96. Statutory Authority: Chapter 18.25 RCW.
- 246-807-290 Improper billing practices. [Statutory Authority: RCW 18.26.110 and chapter 18.26 RCW. 93-24-107, § 246-807-290, filed 12/1/93, effective 1/1/94. Statutory Authority: RCW 18.26.110. 91-05-095 (Order 110B), recodified as § 246-807-290, filed 2/20/91, effective 3/23/91. Statutory Authority: RCW 18.130.050(1). 87-05-064 (Order PM 640), § 113-12-197, filed 2/18/87.] Repealed by 96-16-074, filed 8/6/96, effective 9/6/96. Statutory Authority: Chapter 18.25 RCW.
- 246-807-300 Scope of practice—Revocation or suspension of license authorized for practice outside scope. [Statutory Authority: RCW 18.26.110. 94-16-012, § 246-807-300, filed 7/21/94, effective 8/21/94; 92-24-042 (Order 319B), § 246-807-300, filed 11/25/92, effective 12/26/92; 91-05-095 (Order 110B), recodified as § 246-807-300, filed 2/20/91, effective 3/23/91; 90-16-059 (Order 077) § 113-12-200, filed 7/27/90, effective 8/27/90; 88-17-100 (Order PM 765), § 113-12-200, filed 8/23/88; 87-24-064 (Order PM 693), § 113-12-200, filed 12/1/87. Statutory Authority: RCW 18.26.110(2). 84-23-033 (Order PL 497), § 113-12-200, filed 11/15/84. Statutory Authority: RCW 18.26.110. 81-13-002 (Order PL 380), § 113-12-200, filed 6/4/81.] Repealed by 96-16-074, filed 8/6/96, effective 9/6/96. Statutory Authority: Chapter 18.25 RCW.
- 246-807-310 Clinically necessary x-rays. [Statutory Authority: RCW 18.26.110. 91-05-095 (Order 110B), recodified as § 246-807-310, filed 2/20/91, effective 3/23/91. Statutory Authority: RCW 18.26.110(2). 84-23-033 (Order PL 497), § 113-12-210, filed 11/15/84.] Repealed by 96-16-074, filed 8/6/96, effective 9/6/96. Statutory Authority: Chapter 18.25 RCW.
- 246-807-311 Sexual misconduct. [Statutory Authority: RCW 18.26.110 and chapter 18.26 RCW. 93-24-107, § 246-807-311, filed 12/1/93, effective 1/1/94.] Repealed by 96-16-074, filed 8/6/96, effective 9/6/96. Statutory Authority: Chapter 18.25 RCW.
- 246-807-320 Records and x-rays and withdrawal from practice—Maintenance and retention of patient records. [Statutory Authority: RCW 18.26.110 and chapter 18.26 RCW. 93-24-107, § 246-807-320, filed 12/1/93, effective 1/1/94. Statutory Authority: RCW 18.26.110. 91-05-095 (Order 110B), recodified as § 246-807-320, filed 2/20/91, effective 3/23/91; 89-01-017 (Order PM 806), § 113-12-220, filed 12/9/88, effective 2/1/89.] Repealed by 96-16-074, filed 8/6/96, effective 9/6/96. Statutory Authority: Chapter 18.25 RCW.
- 246-807-330 Duties of a chiropractor who retires or withdraws from practice. [Statutory Authority: RCW 18.26.110. 91-05-095 (Order 110B), recodified as § 246-807-330, filed 2/20/91, effective 3/23/91; 89-01-017 (Order PM 806), § 113-12-230, filed 12/9/88, effective 2/1/89.] Repealed by 96-16-074, filed 8/6/96, effective 9/6/96. Statutory Authority: Chapter 18.25 RCW.
- 246-807-340 Mandatory reporting definitions. [Statutory Authority: RCW 18.26.110. 91-24-052 (Order 220B), § 246-807-340, filed 11/27/91, effective 12/28/91; 91-05-095 (Order 110B), recodified as § 246-807-340, filed 2/20/91, effective 3/23/91; 87-24-064 (Order PM 693), § 113-12-300, filed 12/1/87.] Repealed by 96-16-074, filed 8/6/96, effective 9/6/96. Statutory Authority: Chapter 18.25 RCW.
- 246-807-350 Mandatory reporting. [Statutory Authority: RCW 18.26.110. 91-05-095 (Order 110B), recodified as § 246-807-350, filed 2/20/91, effective 3/23/91; 87-24-064 (Order PM 693), § 113-12-310, filed 12/1/87.] Repealed by 96-16-074, filed 8/6/96, effective 9/6/96. Statutory Authority: Chapter 18.25 RCW.
- 246-807-360 Chiropractic associations or societies. [Statutory Authority: RCW 18.26.110. 91-05-095 (Order 110B), recodified as § 246-807-360, filed 2/20/91, effective 3/23/91; 87-24-064 (Order PM 693), § 113-12-320, filed 12/1/87.] Repealed by 96-16-074, filed 8/6/96, effective 9/6/96. Statutory Authority: Chapter 18.25 RCW.
- 246-807-370 Insurance carriers. [Statutory Authority: RCW 18.26.110. 91-05-095 (Order 110B), recodified as § 246-807-370, filed 2/20/91, effective 3/23/91; 87-24-064 (Order PM 693), § 113-12-330, filed 12/1/87.] Repealed by 96-16-074, filed 8/6/96, effective 9/6/96. Statutory Authority: Chapter 18.25 RCW.
- 246-807-380 Professional liability carriers. [Statutory Authority: RCW 18.26.110. 91-05-095 (Order 110B), recodified as § 246-807-380, filed 2/20/91, effective 3/23/91; 87-24-064 (Order PM 693), § 113-12-340, filed 12/1/87.] Repealed by 96-16-074, filed 8/6/96, effective 9/6/96. Statutory Authority: Chapter 18.25 RCW.
- 246-807-390 Courts. [Statutory Authority: RCW 18.26.110. 91-05-095 (Order 110B), recodified as § 246-807-390, filed 2/20/91, effective 3/23/91. Statutory Authority: RCW 18.130.070. 87-24-064 (Order PM 693), § 113-12-350, filed 12/1/87.] Repealed by 96-16-074, filed 8/6/96, effective 9/6/96. Statutory Authority: Chapter 18.25 RCW.
- 246-807-395 State and federal agencies. [Statutory Authority: RCW 18.26.110 and chapter 18.26 RCW. 93-24-107, § 246-807-395, filed 12/1/93, effective 1/1/94.] Repealed by 96-16-074, filed 8/6/96, effective 9/6/96. Statutory Authority: Chapter 18.25 RCW.
- 246-807-396 Professional standards review organizations. [Statutory Authority: RCW 18.26.110 and chapter 18.26 RCW. 93-24-107, § 246-807-396, filed 12/1/93, effective 1/1/94.] Repealed by 96-16-074, filed 8/6/96, effective 9/6/96. Statutory Authority: Chapter 18.25 RCW.
- 246-807-400 Peer review membership. [Statutory Authority: RCW 18.26.110. 92-01-070 (Order 227B), § 246-807-400, filed 12/16/91, effective 1/16/92.] Repealed by 96-16-074, filed 8/6/96, effective 9/6/96. Statutory Authority: Chapter 18.25 RCW.
- 246-807-410 Classification of chiropractic procedures and instrumentation. [Statutory Authority: RCW 18.26.110 and 18.130.050. 91-10-051 (Order 162B), § 246-807-410, filed 4/26/91, effective 5/27/91.] Repealed by 96-16-074, filed 8/6/96, effective 9/6/96. Statutory Authority: Chapter 18.25 RCW.
- 246-807-420 Peer review qualifications for appointment. [Statutory Authority: RCW 18.26.110. 92-01-070 (Order 227B), § 246-807-420, filed 12/16/91, effective 1/16/92.] Repealed by 96-16-074, filed 8/6/96, effective 9/6/96. Statutory Authority: Chapter 18.25 RCW.
- 246-807-430 Peer review conflict of interest. [Statutory Authority: RCW 18.26.110. 92-01-070 (Order 227B), § 246-807-430, filed 12/16/91, effective 1/16/92.] Repealed by 96-16-074, filed 8/6/96, effective 9/6/96. Statutory Authority: Chapter 18.25 RCW.
- 246-807-440 Peer review quorum. [Statutory Authority: RCW 18.26.110. 92-01-070 (Order 227B), § 246-807-440, filed 12/16/91, effective 1/16/92.] Repealed by 96-16-074, filed 8/6/96, effective 9/6/96. Statutory Authority: Chapter 18.25 RCW.
- 246-807-450 Peer review conduct of reviews. [Statutory Authority: RCW 18.26.110. 92-01-070 (Order 227B), § 246-807-450, filed 12/16/91, effective 1/16/92.] Repealed by 96-16-074, filed 8/6/96, effective 9/6/96. Statutory Authority: Chapter 18.25 RCW.
- 246-807-460 Mediation. [Statutory Authority: RCW 18.26.110. 92-01-070 (Order 227B), § 246-807-460, filed 12/16/91, effective 1/16/92.] Repealed by 96-16-074, filed 8/6/96,

- effective 9/6/96. Statutory Authority: Chapter 18.25 RCW.
- 246-807-470 Disciplinary board conflict of interest. [Statutory Authority: RCW 18.26.110. 92-01-070 (Order 227B), § 246-807-470, filed 12/16/91, effective 1/16/92.] Repealed by 96-16-074, filed 8/6/96, effective 9/6/96. Statutory Authority: Chapter 18.25 RCW.
- 246-807-480 Peer review fees. [Statutory Authority: RCW 18.26.110 and 18.26.340. 92-11-009 (Order 270B), § 246-807-480, filed 5/11/92, effective 6/11/92.] Repealed by 96-16-074, filed 8/6/96, effective 9/6/96. Statutory Authority: Chapter 18.25 RCW.
- 246-807-500 Philosophy governing voluntary substance abuse monitoring programs. [Statutory Authority: RCW 18.26.110 and chapter 18.26 RCW. 93-24-107, § 246-807-500, filed 12/1/93, effective 1/1/94.] Repealed by 96-16-074, filed 8/6/96, effective 9/6/96. Statutory Authority: Chapter 18.25 RCW.
- 246-807-510 Terms used in WAC 246-807-500 through 246-807-530. [Statutory Authority: RCW 18.26.110 and chapter 18.26 RCW. 93-24-107, § 246-807-510, filed 12/1/93, effective 1/1/94.] Repealed by 96-16-074, filed 8/6/96, effective 9/6/96. Statutory Authority: Chapter 18.25 RCW.
- 246-807-520 Approval of substance abuse monitoring programs. [Statutory Authority: RCW 18.26.110 and chapter 18.26 RCW. 93-24-107, § 246-807-520, filed 12/1/93, effective 1/1/94.] Repealed by 96-16-074, filed 8/6/96, effective 9/6/96. Statutory Authority: Chapter 18.25 RCW.
- 246-807-530 Participation in approved substance abuse monitoring program. [Statutory Authority: RCW 18.26.110 and chapter 18.26 RCW. 93-24-107, § 246-807-530, filed 12/1/93, effective 1/1/94.] Repealed by 96-16-074, filed 8/6/96, effective 9/6/96. Statutory Authority: Chapter 18.25 RCW.
- Chapter 246-816**  
**DENTISTS—DENTAL DISCIPLINARY BOARD**
- 246-816-015 Adjudicative proceedings—Procedural rules for the dental disciplinary board. [Statutory Authority: RCW 18.32.640. 94-12-038, § 246-816-015, filed 5/25/94, effective 6/25/94.] Repealed by 96-01-083, filed 12/18/95, effective 1/18/96. Statutory Authority: RCW 18.32.035.
- 246-816-020 Display of licenses. [Statutory Authority: RCW 18.32.640. 91-02-048 (Order 106B), recodified as § 246-816-020, filed 12/27/90, effective 1/31/91; 81-06-013 (Order PL 373), § 308-37-100, filed 2/20/81.] Repealed by 96-01-083, filed 12/18/95, effective 1/18/96. Statutory Authority: RCW 18.32.035.
- 246-816-030 Maintenance and retention of patient records. [Statutory Authority: RCW 18.32.640. 91-02-048 (Order 106B), recodified as § 246-816-030, filed 12/27/90, effective 1/31/91; 82-07-043 (Order PL 392), § 308-37-110, filed 3/17/82; 81-06-013 (Order PL 373), § 308-37-110, filed 2/20/81.] Repealed by 96-01-083, filed 12/18/95, effective 1/18/96. Statutory Authority: RCW 18.32.035.
- 246-816-040 Report of patient injury or mortality. [Statutory Authority: RCW 18.32.640. 91-02-048 (Order 106B), recodified as § 246-816-040, filed 12/27/90, effective 1/31/91; 81-06-013 (Order PL 373), § 308-37-120, filed 2/20/81.] Repealed by 96-01-083, filed 12/18/95, effective 1/18/96. Statutory Authority: RCW 18.32.035.
- 246-816-050 Recording requirements for all prescription drugs. [Statutory Authority: RCW 18.32.640 and 18.130.050. 92-05-012 (Order 243B), § 246-816-050, filed 2/7/92, effective 3/9/92. Statutory Authority: RCW 18.32.640. 91-02-048 (Order 106B), recodified as § 246-816-050, filed 12/27/90, effective 1/31/91. Statutory Authority: RCW 18.32.640(1). 83-04-050 (Order PL 423), § 308-37-130, filed 2/1/83; 81-06-013 (Order PL 373), § 308-37-130, filed 2/20/81.] Repealed by 96-01-083, filed 12/18/95, effective 1/18/96. Statutory Authority: RCW 18.32.035.
- 246-816-060 Recording requirement for scheduled drugs. [Statutory Authority: RCW 18.32.640. 91-02-048 (Order 106B), recodified as § 246-816-060, filed 12/27/90, effective 1/31/91. Statutory Authority: RCW 18.32.640(1). 83-04-050 (Order PL 423), § 308-37-135, filed 2/1/83.] Repealed by 96-01-083, filed 12/18/95, effective 1/18/96. Statutory Authority: RCW 18.32.035.
- 246-816-070 Prescribing, dispensing or distributing drugs. [Statutory Authority: RCW 18.32.640. 91-02-048 (Order 106B), recodified as § 246-816-070, filed 12/27/90, effective 1/31/91; 81-06-013 (Order PL 373), § 308-37-140, filed 2/20/81.] Repealed by 96-01-083, filed 12/18/95, effective 1/18/96. Statutory Authority: RCW 18.32.035.
- 246-816-075 Nondiscrimination. [Statutory Authority: RCW 18.32.640, 18.130.050(12) and 18.130.040 (3)(b)(iii). 91-03-109 (Order 127B), § 246-816-075, filed 1/22/91, effective 2/22/91.] Repealed by 96-01-083, filed 12/18/95, effective 1/18/96. Statutory Authority: RCW 18.32.035.
- 246-816-080 Patient abandonment. [Statutory Authority: RCW 18.32.640. 91-02-048 (Order 106B), recodified as § 246-816-080, filed 12/27/90, effective 1/31/91. Statutory Authority: RCW 18.32.640(1). 84-21-072 (Order PL 490), § 308-37-150, filed 10/17/84; 84-05-070 (Order PL 460), § 308-37-150, filed 2/22/84.] Repealed by 96-01-083, filed 12/18/95, effective 1/18/96. Statutory Authority: RCW 18.32.035.
- 246-816-090 Representation of care, fees, and records. [Statutory Authority: RCW 18.32.640. 91-02-048 (Order 106B), recodified as § 246-816-090, filed 12/27/90, effective 1/31/91. Statutory Authority: RCW 18.32.640(1). 85-05-040 (Order PL 520), § 308-37-160, filed 2/19/85.] Repealed by 96-01-083, filed 12/18/95, effective 1/18/96. Statutory Authority: RCW 18.32.035.
- 246-816-100 Disclosure of provider services. [Statutory Authority: RCW 18.32.640. 91-02-048 (Order 106B), recodified as § 246-816-100, filed 12/27/90, effective 1/31/91. Statutory Authority: RCW 18.32.640(1). 85-05-040 (Order PL 520), § 308-37-170, filed 2/19/85.] Repealed by 96-01-083, filed 12/18/95, effective 1/18/96. Statutory Authority: RCW 18.32.035.
- 246-816-110 Disclosure of membership affiliation. [Statutory Authority: RCW 18.32.640. 91-02-048 (Order 106B), recodified as § 246-816-110, filed 12/27/90, effective 1/31/91. Statutory Authority: RCW 18.32.640(1). 85-05-040 (Order PL 520), § 308-37-180, filed 2/19/85.] Repealed by 96-01-083, filed 12/18/95, effective 1/18/96. Statutory Authority: RCW 18.32.035.
- 246-816-120 Specialty representation. [Statutory Authority: RCW 18.32.640. 91-02-048 (Order 106B), recodified as § 246-816-120, filed 12/27/90, effective 1/31/91; 89-08-095 (Order PM 826), § 308-37-190, filed 4/5/89. Statutory Authority: RCW 18.32.640(1). 85-05-040 (Order PL 520), § 308-37-190, filed 2/19/85.] Repealed by 96-01-083, filed 12/18/95, effective 1/18/96. Statutory Authority: RCW 18.32.035.
- 246-816-130 Maintenance of records. [Statutory Authority: RCW 18.32.640. 91-02-048 (Order 106B), recodified as § 246-816-130, filed 12/27/90, effective 1/31/91; Order, § 1, filed 3/23/60.] Repealed by 96-01-083, filed 12/18/95, effective 1/18/96. Statutory Authority: RCW 18.32.035.
- 246-816-140 Prescriptions. [Statutory Authority: RCW 18.32.640. 91-02-048 (Order 106B), recodified as § 246-816-140, filed 12/27/90, effective 1/31/91. Statutory Authority: RCW 18.32.040. 82-04-024 (Order PL 391), § 308-40-020, filed 1/26/82; Order, § 2, filed 3/23/60.] Repealed by 96-01-083, filed 12/18/95, effective 1/18/96. Statutory Authority: RCW 18.32.035.
- 246-816-150 A rule applicable to dental technicians. [Statutory Authority: RCW 18.32.640. 91-02-048 (Order 106B), recodified as § 246-816-150, filed 12/27/90, effective 1/31/91; Order, filed 3/23/60.] Repealed by 96-01-083, filed 12/18/95, effective 1/18/96. Statutory Authority: RCW 18.32.035.
- 246-816-201 Purpose. [Statutory Authority: RCW 18.32.640 and 18.130.050. 92-05-012 (Order 243B), § 246-816-201, filed 2/7/92, effective 3/9/92. Statutory Authority: RCW 18.32.640. 91-02-048 (Order 106B), recodified as § 246-816-201, filed 12/27/90, effective 1/31/91; 81-17-054 (Order PL 382), § 308-38-100, filed 8/18/81.] Repealed by 96-01-083, filed 12/18/95, effective 1/18/96. Statutory Authority: RCW 18.32.035.

- 246-816-210 Definitions for WAC 246-816-201 through 246-816-260. [Statutory Authority: RCW 18.32.640 and 18.130.050. 92-05-012 (Order 243B), § 246-816-210, filed 2/7/92, effective 3/9/92. Statutory Authority: RCW 18.32.640. 91-02-048 (Order 106B), recodified as § 246-816-210, filed 12/27/90, effective 1/31/91; 81-17-054 (Order PL 382), § 308-38-110, filed 8/18/81.] Repealed by 96-01-083, filed 12/18/95, effective 1/18/96. Statutory Authority: RCW 18.32.035.
- 246-816-220 Acts that may be performed by unlicensed persons. [Statutory Authority: RCW 18.32.640. 91-02-048 (Order 106B), recodified as § 246-816-220, filed 12/27/90, effective 1/31/91; 81-17-054 (Order PL 382), § 308-38-120, filed 8/18/81.] Repealed by 96-01-083, filed 12/18/95, effective 1/18/96. Statutory Authority: RCW 18.32.035.
- 246-816-225 An act that may be performed by unlicensed persons outside the treatment facility. [Statutory Authority: RCW 18.32.640, 18.32.020 and 18.32.030. 93-19-111 (Order 400B), § 246-816-225, filed 9/20/93, effective 10/21/93.] Repealed by 96-01-083, filed 12/18/95, effective 1/18/96. Statutory Authority: RCW 18.32.035.
- 246-816-230 Acts that may not be performed by unlicensed persons. [Statutory Authority: RCW 18.32.640 and 18.130.050. 92-05-012 (Order 243B), § 246-816-230, filed 2/7/92, effective 3/9/92. Statutory Authority: RCW 18.32.640. 91-02-048 (Order 106B), recodified as § 246-816-230, filed 12/27/90, effective 1/31/91; 81-17-054 (Order PL 382), § 308-38-130, filed 8/18/81.] Repealed by 96-01-083, filed 12/18/95, effective 1/18/96. Statutory Authority: RCW 18.32.035.
- 246-816-240 Acts that may be performed by licensed dental hygienists under general supervision. [Statutory Authority: RCW 18.32.640. 92-20-036 (Order 307B), § 246-816-240, filed 9/29/92, effective 10/30/92; 91-02-048 (Order 106B), recodified as § 246-816-240, filed 12/27/90, effective 1/31/91; 81-17-054 (Order PL 382), § 308-38-140, filed 8/18/81.] Repealed by 96-01-083, filed 12/18/95, effective 1/18/96. Statutory Authority: RCW 18.32.035.
- 246-816-250 Acts that may be performed by licensed dental hygienists under close supervision. [Statutory Authority: RCW 18.32.640. 92-20-036 (Order 307B), § 246-816-250, filed 9/29/92, effective 10/30/92. Statutory Authority: RCW 18.32.640 and 18.130.050. 92-05-012 (Order 243B), § 246-816-250, filed 2/7/92, effective 3/9/92. Statutory Authority: RCW 18.32.640. 91-02-048 (Order 106B), recodified as § 246-816-250, filed 12/27/90, effective 1/31/91; 81-17-054 (Order PL 382), § 308-38-150, filed 8/18/81.] Repealed by 96-01-083, filed 12/18/95, effective 1/18/96. Statutory Authority: RCW 18.32.035.
- 246-816-260 Acts that may not be performed by dental hygienists. [Statutory Authority: RCW 18.32.640 and 18.130.050. 92-05-012 (Order 243B), § 246-816-260, filed 2/7/92, effective 3/9/92. Statutory Authority: RCW 18.32.640. 91-02-048 (Order 106B), recodified as § 246-816-260, filed 12/27/90, effective 1/31/91; 81-17-054 (Order PL 382), § 308-38-160, filed 8/18/81.] Repealed by 96-01-083, filed 12/18/95, effective 1/18/96. Statutory Authority: RCW 18.32.035.
- 246-816-301 Purpose. [Statutory Authority: RCW 18.32.640 and 18.130.050. 92-05-012 (Order 243B), § 246-816-301, filed 2/7/92, effective 3/9/92. Statutory Authority: RCW 18.32.640. 91-02-048 (Order 106B), recodified as § 246-816-301, filed 12/27/90, effective 1/31/91; 90-18-042 (Order 088), § 308-39-100, filed 8/29/90, effective 10/1/90; 81-06-013 (Order PL 373), § 308-39-100, filed 2/20/81.] Repealed by 96-01-083, filed 12/18/95, effective 1/18/96. Statutory Authority: RCW 18.32.035.
- 246-816-310 Definitions for WAC 246-816-301 through 246-816-410. [Statutory Authority: RCW 18.32.640 and 18.130.050. 92-05-012 (Order 243B), § 246-816-310, filed 2/7/92, effective 3/9/92. Statutory Authority: RCW 18.32.640. 91-02-048 (Order 106B), recodified as § 246-816-310, filed 12/27/90, effective 1/31/91; 90-18-042 (Order 088), § 308-39-110, filed 8/29/90, effective 10/1/90. Statutory Authority: RCW 18.32.640(1). 82-16-087 (Order PL 403), § 308-39-110, filed 8/4/82. Statutory Authority: RCW 18.32.640. 81-06-013 (Order PL 373), § 308-39-110, filed 2/20/81.] Repealed by 96-01-083, filed 12/18/95, effective 1/18/96. Statutory Authority: RCW 18.32.035.
- 246-816-320 Basic life support requirements. [Statutory Authority: RCW 18.32.640. 91-02-048 (Order 106B), recodified as § 246-816-320, filed 12/27/90, effective 1/31/91; 90-18-042 (Order 088), § 308-39-125, filed 8/29/90, effective 10/1/90.] Repealed by 96-01-083, filed 12/18/95, effective 1/18/96. Statutory Authority: RCW 18.32.035.
- 246-816-330 Local anesthesia. [Statutory Authority: RCW 18.32.640. 91-02-048 (Order 106B), recodified as § 246-816-330, filed 12/27/90, effective 1/31/91; 90-18-042 (Order 088), § 308-39-130, filed 8/29/90, effective 10/1/90.] Repealed by 96-01-083, filed 12/18/95, effective 1/18/96. Statutory Authority: RCW 18.32.035.
- 246-816-340 Nitrous oxide/oxygen sedation. [Statutory Authority: RCW 18.32.640. 91-02-048 (Order 106B), recodified as § 246-816-340, filed 12/27/90, effective 1/31/91; 90-18-042 (Order 088), § 308-39-140, filed 8/29/90, effective 10/1/90.] Repealed by 96-01-083, filed 12/18/95, effective 1/18/96. Statutory Authority: RCW 18.32.035.
- 246-816-350 Conscious sedation with an oral agent. [Statutory Authority: RCW 18.32.640. 91-02-048 (Order 106B), recodified as § 246-816-350, filed 12/27/90, effective 1/31/91; 90-18-041 (Order 087), § 308-39-150, filed 8/29/90, effective 10/1/90.] Repealed by 96-01-083, filed 12/18/95, effective 1/18/96. Statutory Authority: RCW 18.32.035.
- 246-816-360 Conscious sedation with parenteral or multiple oral agents. [Statutory Authority: RCW 18.32.640 and 18.130.050. 92-05-012 (Order 243B), § 246-816-360, filed 2/7/92, effective 3/9/92. Statutory Authority: RCW 18.32.640. 91-02-048 (Order 106B), recodified as § 246-816-360, filed 12/27/90, effective 1/31/91; 90-18-041 (Order 087), § 308-39-160, filed 8/29/90, effective 10/1/90.] Repealed by 96-01-083, filed 12/18/95, effective 1/18/96. Statutory Authority: RCW 18.32.035.
- 246-816-370 General anesthesia (including deep sedation). [Statutory Authority: RCW 18.32.640. 93-19-112 (Order 399B), § 246-816-370, filed 9/20/93, effective 10/21/93. Statutory Authority: RCW 18.32.640 and 18.130.050. 92-05-012 (Order 243B), § 246-816-370, filed 2/7/92, effective 3/9/92. Statutory Authority: RCW 18.32.640. 91-02-048 (Order 106B), recodified as § 246-816-370, filed 12/27/90, effective 1/31/91; 90-18-041 (Order 087), § 308-39-170, filed 8/29/90, effective 10/1/90.] Repealed by 96-01-083, filed 12/18/95, effective 1/18/96. Statutory Authority: RCW 18.32.035.
- 246-816-380 Mandatory reporting of death or significant complication. [Statutory Authority: RCW 18.32.640. 91-02-048 (Order 106B), recodified as § 246-816-380, filed 12/27/90, effective 1/31/91; 90-18-041 (Order 087), § 308-39-180, filed 8/29/90, effective 10/1/90.] Repealed by 96-01-083, filed 12/18/95, effective 1/18/96. Statutory Authority: RCW 18.32.035.
- 246-816-390 Applications—Permits—Renewals for the administration of conscious sedation with multiple oral or parenteral agents or general anesthesia (including deep sedation). [Statutory Authority: RCW 18.32.640 and 18.130.050. 92-05-012 (Order 243B), § 246-816-390, filed 2/7/92, effective 3/9/92. Statutory Authority: RCW 18.32.640. 91-02-048 (Order 106B), recodified as § 246-816-390, filed 12/27/90, effective 1/31/91; 90-18-041 (Order 087), § 308-39-190, filed 8/29/90, effective 10/1/90.] Repealed by 96-01-083, filed 12/18/95, effective 1/18/96. Statutory Authority: RCW 18.32.035.
- 246-816-400 Application of chapter 18.130 RCW. [Statutory Authority: RCW 18.32.640. 91-02-048 (Order 106B), recodified as § 246-816-400, filed 12/27/90, effective 1/31/91; 90-18-041 (Order 087), § 308-39-200, filed 8/29/90, effective 10/1/90.] Repealed by 96-01-083, filed 12/18/95, effective 1/18/96. Statutory Authority: RCW 18.32.035.
- 246-816-410 Effective date. [Statutory Authority: RCW 18.32.640 and 18.130.050. 92-05-012 (Order 243B), § 246-816-410, filed 2/7/92, effective 3/9/92. Statutory Authority: RCW

## Chapter 246-818

## DENTISTS—BOARD OF DENTAL EXAMINERS

- 18.32.640. 91-02-048 (Order 106B), recodified as § 246-816-410, filed 12/27/90, effective 1/31/91; 90-18-041 (Order 087), § 308-39-210, filed 8/29/90, effective 10/1/90.] Repealed by 96-01-083, filed 12/18/95, effective 1/18/96. Statutory Authority: RCW 18.32.035.
- 246-816-501 Intent. [Statutory Authority: RCW 18.32.640. 91-02-048 (Order 106B), recodified as § 246-816-501, filed 12/27/90, effective 1/31/91. Statutory Authority: RCW 18.130.175 and 18.32.534. 90-16-099 (Order 076), § 308-25-290, filed 8/1/90, effective 9/1/90.] Repealed by 96-01-083, filed 12/18/95, effective 1/18/96. Statutory Authority: RCW 18.32.035.
- 246-816-510 Terms used in WAC 246-816-501 through 246-816-530. [Statutory Authority: RCW 18.32.640 and 18.130.050. 92-05-012 (Order 243B), § 246-816-510, filed 2/7/92, effective 3/9/92. Statutory Authority: RCW 18.32.640. 91-02-048 (Order 106B), recodified as § 246-816-510, filed 12/27/90, effective 1/31/91. Statutory Authority: RCW 18.130.175 and 18.32.534. 90-16-099 (Order 076), § 308-25-310, filed 8/1/90, effective 9/1/90.] Repealed by 96-01-083, filed 12/18/95, effective 1/18/96. Statutory Authority: RCW 18.32.035.
- 246-816-520 Approval of substance abuse monitoring programs. [Statutory Authority: RCW 18.32.640. 91-02-048 (Order 106B), recodified as § 246-816-520, filed 12/27/90, effective 1/31/91. Statutory Authority: RCW 18.130.175 and 18.32.534. 90-16-099 (Order 076), § 308-25-320, filed 8/1/90, effective 9/1/90.] Repealed by 96-01-083, filed 12/18/95, effective 1/18/96. Statutory Authority: RCW 18.32.035.
- 246-816-530 Participation in approved substance abuse monitoring program. [Statutory Authority: RCW 18.32.640. 91-02-048 (Order 106B), recodified as § 246-816-530, filed 12/27/90, effective 1/31/91. Statutory Authority: RCW 18.130.175 and 18.32.534. 90-16-099 (Order 076), § 308-25-330, filed 8/1/90, effective 9/1/90.] Repealed by 96-01-083, filed 12/18/95, effective 1/18/96. Statutory Authority: RCW 18.32.035.
- 246-816-701 Purpose. [Statutory Authority: RCW 18.32.640. 92-09-069 (Order 263B), § 246-816-701, filed 4/14/92, effective 5/15/92.] Repealed by 96-01-083, filed 12/18/95, effective 1/18/96. Statutory Authority: RCW 18.32.035.
- 246-816-710 Definitions. [Statutory Authority: RCW 18.32.640. 92-09-069 (Order 263B), § 246-816-710, filed 4/14/92, effective 5/15/92.] Repealed by 96-01-083, filed 12/18/95, effective 1/18/96. Statutory Authority: RCW 18.32.035.
- 246-816-720 Use of barriers and sterilization techniques. [Statutory Authority: RCW 18.32.640. 92-09-069 (Order 263B), § 246-816-720, filed 4/14/92, effective 5/15/92.] Repealed by 96-01-083, filed 12/18/95, effective 1/18/96. Statutory Authority: RCW 18.32.035.
- 246-816-730 Management of single use items. [Statutory Authority: RCW 18.32.640. 92-09-069 (Order 263B), § 246-816-730, filed 4/14/92, effective 5/15/92.] Repealed by 96-01-083, filed 12/18/95, effective 1/18/96. Statutory Authority: RCW 18.32.035.
- 246-816-740 Effective date. [Statutory Authority: RCW 18.32.640. 92-09-069 (Order 263B), § 246-816-740, filed 4/14/92, effective 5/15/92.] Repealed by 96-01-083, filed 12/18/95, effective 1/18/96. Statutory Authority: RCW 18.32.035.
- 246-816-990 Dental anesthesia permit fees. [Statutory Authority: RCW 43.70.040. 91-02-049 (Order 121), recodified as § 246-816-990, filed 12/27/90, effective 1/31/91. Statutory Authority: RCW 43.70.250. 90-18-040 (Order 086), § 308-39-220, filed 8/29/90, effective 10/1/90.] Repealed by 95-16-122 and 96-01-083, filed 8/2/95 and 12/18/95, effective 9/1/95 and 1/18/96. Statutory Authority: RCW 43.70.040 and 18.32.035.
- 246-818-015 Adjudicative proceedings—Procedural rules for the board of dental examiners. [Statutory Authority: RCW 18.32.035. 94-08-011, § 246-818-015, filed 3/28/94, effective 4/28/94.] Repealed by 96-01-083, filed 12/18/95, effective 1/18/96. Statutory Authority: RCW 18.32.035.
- 246-818-020 Examination eligibility and application. [Statutory Authority: RCW 18.32.035. 94-11-088, § 246-818-020, filed 5/17/94, effective 6/17/94; 92-01-122 (Order 228B), § 246-818-020, filed 12/19/91, effective 1/19/92; 91-01-007 (Order 101B), recodified as § 246-818-020, filed 12/6/90, effective 1/31/91. Statutory Authority: RCW 18.32.040 and 18.130.050. 88-13-131 (Order PM 740), § 308-40-101, filed 6/22/88. Statutory Authority: RCW 18.32.040. 82-04-024 (Order PL 391), § 308-40-101, filed 1/26/82. Statutory Authority: RCW 18.29.030 and 18.32.040. 81-08-043 (Order PL 374), § 308-40-101, filed 3/31/81; 80-05-063 (Order PL 342), § 308-40-101, filed 4/22/80. Statutory Authority: RCW 18.32.040. 79-04-011 (Order 295, Resolution No. 295), § 308-40-101, filed 3/13/79.] Repealed by 96-01-083, filed 12/18/95, effective 1/18/96. Statutory Authority: RCW 18.32.035.
- 246-818-030 Examination content. [Statutory Authority: RCW 18.32.035. 91-01-007 (Order 101B), recodified as § 246-818-030, filed 12/6/90, effective 1/31/91. Statutory Authority: RCW 18.32.040(4) and 18.32.120. 89-06-075 (Order PM 819), § 308-40-102, filed 3/1/89. Statutory Authority: RCW 18.32.040 and 18.130.050. 88-13-131 (Order PM 740), § 308-40-102, filed 6/22/88. Statutory Authority: RCW 18.32.040. 87-09-097 (Order PM 649), § 308-40-102, filed 4/22/87; 86-08-046 (Order PL 583), § 308-40-102, filed 3/27/86; 84-07-050 (Order PL 462), § 308-40-102, filed 3/21/84; 83-08-021 (Order PL 431), § 308-40-102, filed 3/29/83; 82-04-024 (Order PL 391), § 308-40-102, filed 1/26/82; 79-04-011 (Order 295, Resolution No. 295), § 308-40-102, filed 3/13/79.] Repealed by 96-01-083, filed 12/18/95, effective 1/18/96. Statutory Authority: RCW 18.32.035.
- 246-818-040 Dismissal from examination. [Statutory Authority: RCW 18.32.035. 91-01-007 (Order 101B), recodified as § 246-818-040, filed 12/6/90, effective 1/31/91. Statutory Authority: RCW 18.32.040 and 18.130.050. 88-13-131 (Order PM 740), § 308-40-103, filed 6/22/88. Statutory Authority: RCW 18.32.040. 82-04-024 (Order PL 391), § 308-40-103, filed 1/26/82.] Repealed by 96-01-083, filed 12/18/95, effective 1/18/96. Statutory Authority: RCW 18.32.035.
- 246-818-050 Examination results. [Statutory Authority: RCW 18.32.120. 91-14-087 (Order 180B), § 246-818-050, filed 7/1/91, effective 8/1/91. Statutory Authority: RCW 18.32.035. 91-01-007 (Order 101B), recodified as § 246-818-050, filed 12/6/90, effective 1/31/91. Statutory Authority: RCW 18.32.640. 89-01-083 (Order PM 809), § 308-40-104, filed 12/20/88. Statutory Authority: RCW 18.32.040. 85-16-113 (Order PL 547), § 308-40-104, filed 8/7/85; 84-11-025 (Order PL 467), § 308-40-104, filed 5/11/84; 82-04-024 (Order PL 391), § 308-40-104, filed 1/26/82.] Repealed by 96-01-083, filed 12/18/95, effective 1/18/96. Statutory Authority: RCW 18.32.035.
- 246-818-060 Practical examination review procedures. [Statutory Authority: RCW 18.32.035. 92-01-122 (Order 228B), § 246-818-060, filed 12/19/91, effective 1/19/92; 91-01-007 (Order 101B), recodified as § 246-818-060, filed 12/6/90, effective 1/31/91. Statutory Authority: RCW 18.32.040 and 18.32.120. 89-13-052 (Order PM 834), § 308-40-105, filed 6/19/89. Statutory Authority: RCW 18.32.040 and 18.130.050. 88-13-131 (Order PM 740), § 308-40-105, filed 6/22/88. Statutory Authority: RCW 18.32.040. 87-09-097 (Order PM 649), § 308-40-105, filed 4/22/87; 82-04-024 (Order PL 391), § 308-40-105, filed 1/26/82. Statutory Authority: RCW 18.29.030 and 18.32.040. 80-18-009 (Order 363), § 308-40-105, filed 11/24/80; 80-05-063 (Order PL 342), § 308-40-105, filed 4/22/80.]

Reviser's note: Later promulgation, see chapter 246-817 WAC.

- Repealed by 96-01-083, filed 12/18/95, effective 1/18/96. Statutory Authority: RCW 18.32.035.
- 246-818-070 Written examination review procedures. [Statutory Authority: RCW 18.32.035. 92-01-122 (Order 228B), § 246-818-070, filed 12/19/91, effective 1/19/92; 91-01-007 (Order 101B), recodified as § 246-818-070, filed 12/6/90, effective 1/31/91. Statutory Authority: RCW 18.32.040 and 18.32.120. 89-13-052 (Order PM 834), § 308-40-106, filed 6/19/89.] Repealed by 96-01-083, filed 12/18/95, effective 1/18/96. Statutory Authority: RCW 18.32.035.
- 246-818-080 Application for licensure—AIDS education requirements. [Statutory Authority: RCW 18.32.035. 92-01-122 (Order 228B), § 246-818-080, filed 12/19/91, effective 1/19/92. 91-01-007 (Order 101B), recodified as § 246-818-080, filed 12/6/90, effective 1/31/91. Statutory Authority: RCW 70.24.270. 90-08-011, § 308-40-107, filed 3/26/90, effective 4/26/90.] Repealed by 96-01-083, filed 12/18/95, effective 1/18/96. Statutory Authority: RCW 18.32.035.
- 246-818-090 Graduates of nonaccredited schools. [Statutory Authority: RCW 18.32.035. 92-01-122 (Order 228B), § 246-818-090, filed 12/19/91, effective 1/19/92; 91-01-007 (Order 101B), recodified as § 246-818-090, filed 12/6/90, effective 1/31/91. Statutory Authority: RCW 18.32.040. 84-23-062 (Order PL 496), § 308-40-110, filed 11/21/84; 83-08-021 (Order PL 431), § 308-40-110, filed 3/29/83; 82-04-024 (Order PL 391), § 308-40-110, filed 1/26/82; Order PL 253, § 308-40-110, filed 7/13/76; Order PL 194, § 308-40-110, filed 7/27/75.] Repealed by 96-01-083, filed 12/18/95, effective 1/18/96. Statutory Authority: RCW 18.32.035.
- 246-818-100 Licenses—Persons licensed or qualified out-of-state who are faculty at school of dentistry—Conditions. [Statutory Authority: RCW 18.32.035. 91-01-007 (Order 101B), recodified as § 246-818-100, filed 12/6/90, effective 1/31/91. Statutory Authority: RCW 18.32.035 and 18.32.195. 90-11-083 (Order 057), § 308-40-115, filed 5/17/90, effective 6/17/90.] Repealed by 96-01-083, filed 12/18/95, effective 1/18/96. Statutory Authority: RCW 18.32.035.
- 246-818-110 AIDS prevention and information education requirements. [Statutory Authority: RCW 18.32.035. 91-01-007 (Order 101B), recodified as § 246-818-110, filed 12/6/90, effective 1/31/91. Statutory Authority: 1988 c 206 § 604. 89-11-053 (Order PM 837), § 308-40-140, filed 5/17/89.] Repealed by 92-01-122 (Order 228B), filed 12/19/91, effective 1/19/92. Statutory Authority: RCW 18.32.035.
- 246-818-120 Licensure without examination for dentists—Eligibility. [Statutory Authority: RCW 18.32.035. 93-07-108 (Order 350B), § 246-818-120, filed 3/23/93, effective 4/23/93; 92-01-122 (Order 228B), § 246-818-120, filed 12/19/91, effective 1/19/92; 91-01-007 (Order 101B), recodified as § 246-818-120, filed 12/6/90, effective 1/31/91; 90-18-038 (Order 085), § 308-40-150, filed 8/28/90, effective 9/28/90.] Repealed by 96-01-083, filed 12/18/95, effective 1/18/96. Statutory Authority: RCW 18.32.035.
- 246-818-130 Licensure without examination for dentists—Application procedure. [Statutory Authority: RCW 18.32.035. 93-12-005 (Order 363B), § 246-818-130, filed 5/19/93, effective 6/19/93; 92-01-122 (Order 228B), § 246-818-130, filed 12/19/91, effective 1/19/92; 91-01-007 (Order 101B), recodified as § 246-818-130, filed 12/6/90, effective 1/31/91; 90-18-038 (Order 085), § 308-40-151, filed 8/28/90, effective 9/28/90.] Repealed by 96-01-083, filed 12/18/95, effective 1/18/96. Statutory Authority: RCW 18.32.035.
- 246-818-140 Licensure without examination for dentists—Licensing examination standards. [Statutory Authority: RCW 18.32.035. 93-07-108 (Order 350B), § 246-818-140, filed 3/23/93, effective 4/23/93; 91-01-007 (Order 101B), recodified as § 246-818-140, filed 12/6/90, effective 1/31/91; 90-18-038 (Order 085), § 308-40-152, filed 8/28/90, effective 9/28/90.] Repealed by 96-01-083, filed 12/18/95, effective 1/18/96. Statutory Authority: RCW 18.32.035.
- 246-818-142 Temporary practice permits—Eligibility. [Statutory Authority: RCW 18.32.0365 and 18.130.075. 94-22-072,

- § 246-818-142, filed 11/2/94, effective 12/3/94.] Repealed by 96-01-083, filed 12/18/95, effective 1/18/96. Statutory Authority: RCW 18.32.035.
- 246-818-143 Temporary practice permits—Issuance and duration. [Statutory Authority: RCW 18.32.0365 and 18.130.075. 94-22-072, § 246-818-143, filed 11/2/94, effective 12/3/94.] Repealed by 96-01-083, filed 12/18/95, effective 1/18/96. Statutory Authority: RCW 18.32.035.
- 246-818-150 Renewal of licenses. [Statutory Authority: RCW 18.32.035. 91-01-007 (Order 101B), recodified as § 246-818-150, filed 12/6/90, effective 1/31/91. Statutory Authority: 1989 c 202 § 22. 90-05-039 (Order 036), § 308-40-135, filed 2/14/90, effective 3/1/90.] Repealed by 96-01-083, filed 12/18/95, effective 1/18/96. Statutory Authority: RCW 18.32.035.
- 246-818-990 Dentist fees. [Statutory Authority: RCW 43.70.040. 92-17-059 (Order 298), § 246-818-990, filed 8/18/92, effective 9/18/92; 91-02-049 (Order 121), recodified as § 246-818-990, filed 12/27/87, effective 1/31/91. Statutory Authority: RCW 43.70.250. 90-04-094 (Order 029), § 308-40-125, filed 2/7/90, effective 3/10/90. Statutory Authority: RCW 43.24.086. 87-18-031 (Order PM 667), § 308-40-125, filed 8/27/87. Statutory Authority: 1983 c 168 § 12. 83-17-031 (Order PL 442), § 308-40-125, filed 8/10/83. Formerly WAC 308-40-120.] Repealed by 94-02-058, filed 1/3/94, effective 3/1/94. Statutory Authority: RCW 43.70.040.
- 246-818-991 Dentist fees. [Statutory Authority: RCW 43.70.040. 94-02-058, § 246-818-991, filed 1/3/94, effective 3/1/94.] Repealed by 95-16-122 and 96-01-083, filed 8/2/95 and 12/18/95, effective 9/1/95 and 1/18/96. Statutory Authority: RCW 43.70.040 and 18.32.035.

Reviser's note: Later promulgation, see chapter 246-817 WAC.

#### Chapter 246-857

#### PHARMACISTS—PRACTICE AND PROCEDURE

- 246-857-020 Practice and procedure—Adoption by reference. [Statutory Authority: RCW 18.64.005 and 34.05.220. 92-12-035 (Order 277B), § 246-857-020, filed 5/28/92, effective 6/28/92. Statutory Authority: RCW 18.64.005 and chapter 18.64A RCW. 91-18-057 (Order 191B), recodified as § 246-857-020, filed 8/30/91, effective 9/30/91. Statutory Authority: RCW 18.64.005. 88-06-026 (Order 210), § 360-08-005, filed 2/25/88.] Repealed by 93-04-017 (Order 330B), filed 1/25/93, effective 2/25/93. Statutory Authority: RCW 18.64.005.
- 246-857-030 Appearance and practice before board—Who may appear. [Statutory Authority: RCW 18.64.005 and chapter 18.64A RCW. 91-18-057 (Order 191B), recodified as § 246-857-030, filed 8/30/91, effective 9/30/91; Regulation .08.010, filed 1/10/63; Regulation .08.010, filed 3/23/60.] Repealed by 93-04-017 (Order 330B), filed 1/25/93, effective 2/25/93. Statutory Authority: RCW 18.64.005.
- 246-857-040 Appearance and practice before board—Standards of ethical conduct. [Statutory Authority: RCW 18.64.005 and chapter 18.64A RCW. 91-18-057 (Order 191B), recodified as § 246-857-040, filed 8/30/91, effective 9/30/91; Regulation .08.030, filed 1/10/63; Regulation .08.040, filed 3/23/60.] Repealed by 93-04-017 (Order 330B), filed 1/25/93, effective 2/25/93. Statutory Authority: RCW 18.64.005.
- 246-857-050 Appearance and practice before board—Appearance by former employee of board or former member of attorney general's staff. [Statutory Authority: RCW 18.64.005 and chapter 18.64A RCW. 91-18-057 (Order 191B), recodified as § 246-857-050, filed 8/30/91, effective 9/30/91; Regulation .08.040, filed 1/10/63; Regulation .08.050, filed 3/23/60.] Repealed by 93-04-017 (Order 330B), filed 1/25/93, effective 2/25/93. Statutory Authority: RCW 18.64.005.
- 246-857-060 Appearance and practice before board—Former employee as expert witness. [Statutory Authority: RCW 18.64.005 and chapter 18.64A RCW. 91-18-057 (Order 191B), recodified as § 246-857-060, filed 8/30/91, effective 9/30/91; Regulation .08.050, filed 1/10/63; Regulation

- .08.060, filed 3/23/60.] Repealed by 93-04-017 (Order 330B), filed 1/25/93, effective 2/25/93. Statutory Authority: RCW 18.64.005.
- 246-857-070 Depositions and interrogatories in contested cases—Right to take. [Statutory Authority: RCW 18.64.005 and chapter 18.64A RCW. 91-18-057 (Order 191B), recodified as § 246-857-070, filed 8/30/91, effective 9/30/91; Regulation .08.230, filed 1/10/63; Regulation .08.230, filed 3/23/60.] Repealed by 93-04-017 (Order 330B), filed 1/25/93, effective 2/25/93. Statutory Authority: RCW 18.64.005.
- 246-857-080 Depositions and interrogatories in contested cases—Scope. [Statutory Authority: RCW 18.64.005 and chapter 18.64A RCW. 91-18-057 (Order 191B), recodified as § 246-857-080, filed 8/30/91, effective 9/30/91; Regulation .08.240, filed 1/10/63; Regulation .08.240, filed 3/23/60.] Repealed by 93-04-017 (Order 330B), filed 1/25/93, effective 2/25/93. Statutory Authority: RCW 18.64.005.
- 246-857-090 Depositions and interrogatories in contested cases—Officer before whom taken. [Statutory Authority: RCW 18.64.005 and chapter 18.64A RCW. 91-18-057 (Order 191B), recodified as § 246-857-090, filed 8/30/91, effective 9/30/91; Regulation .08.250, filed 1/10/63; Regulation .08.250, filed 3/23/60.] Repealed by 93-04-017 (Order 330B), filed 1/25/93, effective 2/25/93. Statutory Authority: RCW 18.64.005.
- 246-857-100 Depositions and interrogatories in contested cases—Authorization. [Statutory Authority: RCW 18.64.005 and chapter 18.64A RCW. 91-18-057 (Order 191B), recodified as § 246-857-100, filed 8/30/91, effective 9/30/91; Regulation .08.260, filed 1/10/63; Regulation .08.260, filed 3/23/60.] Repealed by 93-04-017 (Order 330B), filed 1/25/93, effective 2/25/93. Statutory Authority: RCW 18.64.005.
- 246-857-110 Depositions and interrogatories in contested cases—Protection of parties and deponents. [Statutory Authority: RCW 18.64.005 and chapter 18.64A RCW. 91-18-057 (Order 191B), recodified as § 246-857-110, filed 8/30/91, effective 9/30/91; Regulation .08.270, filed 1/10/63; Regulation .08.270, filed 3/23/60.] Repealed by 93-04-017 (Order 330B), filed 1/25/93, effective 2/25/93. Statutory Authority: RCW 18.64.005.
- 246-857-120 Depositions and interrogatories in contested cases—Oral examination and cross-examination. [Statutory Authority: RCW 18.64.005 and chapter 18.64A RCW. 91-18-057 (Order 191B), recodified as § 246-857-120, filed 8/30/91, effective 9/30/91; Regulation .08.280, filed 1/10/63; Regulation .08.280, filed 3/23/60.] Repealed by 93-04-017 (Order 330B), filed 1/25/93, effective 2/25/93. Statutory Authority: RCW 18.64.005.
- 246-857-130 Depositions and interrogatories in contested cases—Recordation. [Statutory Authority: RCW 18.64.005 and chapter 18.64A RCW. 91-18-057 (Order 191B), recodified as § 246-857-130, filed 8/30/91, effective 9/30/91; Regulation .08.290, filed 1/10/63; Regulation .08.290, filed 3/23/60.] Repealed by 93-04-017 (Order 330B), filed 1/25/93, effective 2/25/93. Statutory Authority: RCW 18.64.005.
- 246-857-140 Depositions and interrogatories in contested cases—Signing attestation and return. [Statutory Authority: RCW 18.64.005 and chapter 18.64A RCW. 91-18-057 (Order 191B), recodified as § 246-857-140, filed 8/30/91, effective 9/30/91; Regulation .08.300, filed 1/10/63; Regulation .08.300, filed 3/23/60.] Repealed by 93-04-017 (Order 330B), filed 1/25/93, effective 2/25/93. Statutory Authority: RCW 18.64.005.
- 246-857-150 Depositions and interrogatories in contested cases—Use and effect. [Statutory Authority: RCW 18.64.005 and chapter 18.64A RCW. 91-18-057 (Order 191B), recodified as § 246-857-150, filed 8/30/91, effective 9/30/91; Regulation .08.310, filed 1/10/63; Regulation .08.310, filed 3/23/60.] Repealed by 93-04-017 (Order 330B), filed 1/25/93, effective 2/25/93. Statutory Authority: RCW 18.64.005.
- 246-857-160 Depositions and interrogatories in contested cases—Fees of officers and deponents.[Statutory Authority: RCW 18.64.005 and chapter 18.64A RCW. 91-18-057 (Order 191B), recodified as § 246-857-160, filed 8/30/91, effective 9/30/91; Regulation .08.320, filed 1/10/63; Regulation .08.320, filed 3/23/60.] Repealed by 93-04-017 (Order 330B), filed 1/25/93, effective 2/25/93. Statutory Authority: RCW 18.64.005.
- 246-857-170 Depositions upon interrogatories—Submission of interrogatories. [Statutory Authority: RCW 18.64.005 and chapter 18.64A RCW. 91-18-057 (Order 191B), recodified as § 246-857-170, filed 8/30/91, effective 9/30/91; Regulation .08.330, filed 1/10/63; Regulation .08.330, filed 3/23/60.] Repealed by 93-04-017 (Order 330B), filed 1/25/93, effective 2/25/93. Statutory Authority: RCW 18.64.005.
- 246-857-180 Depositions upon interrogatories—Interrogation. [Statutory Authority: RCW 18.64.005 and 34.05.220. 92-12-035 (Order 277B), § 246-857-180, filed 5/28/92, effective 6/28/92. Statutory Authority: RCW 18.64.005 and chapter 18.64A RCW. 91-18-057 (Order 191B), recodified as § 246-857-180, filed 8/30/91, effective 9/30/91; Regulation .08.340, filed 1/10/63; Regulation .08.340, filed 3/23/60.] Repealed by 93-04-017 (Order 330B), filed 1/25/93, effective 2/25/93. Statutory Authority: RCW 18.64.005.
- 246-857-190 Depositions upon interrogatories—Attestation and return.[Statutory Authority: RCW 18.64.005 and chapter 18.64A RCW. 91-18-057 (Order 191B), recodified as § 246-857-190, filed 8/30/91, effective 9/30/91; Regulation .08.350, filed 1/10/63; Regulation .08.350, filed 3/23/60.] Repealed by 93-04-017 (Order 330B), filed 1/25/93, effective 2/25/93. Statutory Authority: RCW 18.64.005.
- 246-857-200 Depositions upon interrogatories—Provisions of deposition rule. [Statutory Authority: RCW 18.64.005 and chapter 18.64A RCW. 91-18-057 (Order 191B), recodified as § 246-857-200, filed 8/30/91, effective 9/30/91; Regulation .08.360, filed 1/10/63; Regulation .08.360, filed 3/23/60.] Repealed by 93-04-017 (Order 330B), filed 1/25/93, effective 2/25/93. Statutory Authority: RCW 18.64.005.
- 246-857-210 Official notice—Matters of law. [Statutory Authority: RCW 18.64.005 and chapter 18.64A RCW. 91-18-057 (Order 191B), recodified as § 246-857-210, filed 8/30/91, effective 9/30/91; Regulation .08.370, filed 1/10/63; Regulation .08.370, filed 3/23/60.] Repealed by 93-04-017 (Order 330B), filed 1/25/93, effective 2/25/93. Statutory Authority: RCW 18.64.005.
- 246-857-220 Official notice—Material facts. [Statutory Authority: RCW 18.64.005 and chapter 18.64A RCW. 91-18-057 (Order 191B), recodified as § 246-857-220, filed 8/30/91, effective 9/30/91; Regulation .08.380, filed 1/10/63; Regulation .08.380, filed 3/23/60.] Repealed by 93-04-017 (Order 330B), filed 1/25/93, effective 2/25/93. Statutory Authority: RCW 18.64.005.
- 246-857-230 Presumptions. [Statutory Authority: RCW 18.64.005 and chapter 18.64A RCW. 91-18-057 (Order 191B), recodified as § 246-857-230, filed 8/30/91, effective 9/30/91; Regulation .08.390, filed 1/10/63; Regulation .08.390, filed 3/23/60.] Repealed by 93-04-017 (Order 330B), filed 1/25/93, effective 2/25/93. Statutory Authority: RCW 18.64.005.
- 246-857-240 Stipulations and admissions of record. [Statutory Authority: RCW 18.64.005 and chapter 18.64A RCW. 91-18-057 (Order 191B), recodified as § 246-857-240, filed 8/30/91, effective 9/30/91; Regulation .08.400, filed 1/10/63; Regulation .08.400, filed 3/23/60.] Repealed by 93-04-017 (Order 330B), filed 1/25/93, effective 2/25/93. Statutory Authority: RCW 18.64.005.
- 246-857-250 Definition of issues before hearing. [Statutory Authority: RCW 18.64.005 and chapter 18.64A RCW. 91-18-057 (Order 191B), recodified as § 246-857-250, filed 8/30/91, effective 9/30/91; Regulation .08.420, filed 1/10/63; Regulation .08.420, filed 3/23/60.] Repealed by 93-04-017 (Order 330B), filed 1/25/93, effective 2/25/93. Statutory Authority: RCW 18.64.005.
- 246-857-260 Rules of evidence—Admissibility criteria. [Statutory Authority: RCW 18.64.005 and chapter 18.64A RCW. 91-18-057 (Order 191B), recodified as § 246-857-260,



- filed 8/30/91, effective 9/30/91; Regulation .08.520, filed 1/10/63; Regulation .08.520, filed 3/23/60.] Repealed by 93-04-017 (Order 330B), filed 1/25/93, effective 2/25/93. Statutory Authority: RCW 18.64.005.
- 246-857-270 Rules of evidence—Tentative admission—Exclusion—Discontinuance—Objections. [Statutory Authority: RCW 18.64.005 and chapter 18.64A RCW. 91-18-057 (Order 191B), recodified as § 246-857-270, filed 8/30/91, effective 9/30/91; Regulation .08.530, filed 1/10/63; Regulation .08.530, filed 3/23/60.] Repealed by 93-04-017 (Order 330B), filed 1/25/93, effective 2/25/93. Statutory Authority: RCW 18.64.005.
- 246-857-280 Petitions for rule making, amendment or repeal—Who may petition. [Statutory Authority: RCW 18.64.005 and chapter 18.64A RCW. 91-18-057 (Order 191B), recodified as § 246-857-280, filed 8/30/91, effective 9/30/91; Regulation .08.540, filed 1/10/63; Regulation .08.540, filed 3/23/60.] Repealed by 93-04-017 (Order 330B), filed 1/25/93, effective 2/25/93. Statutory Authority: RCW 18.64.005.
- 246-857-290 Petitions for rule making, amendment or repeal—Requisites. [Statutory Authority: RCW 18.64.005 and chapter 18.64A RCW. 91-18-057 (Order 191B), recodified as § 246-857-290, filed 8/30/91, effective 9/30/91; Regulation .08.550, filed 1/10/63; Regulation .08.550, filed 3/23/60.] Repealed by 93-04-017 (Order 330B), filed 1/25/93, effective 2/25/93. Statutory Authority: RCW 18.64.005.
- 246-857-300 Petitions for rule making, amendment or repeal—Agency must consider. [Statutory Authority: RCW 18.64.005 and chapter 18.64A RCW. 91-18-057 (Order 191B), recodified as § 246-857-300, filed 8/30/91, effective 9/30/91; Regulation .08.560, filed 1/10/63; Regulation .08.560, filed 3/23/60.] Repealed by 93-04-017 (Order 330B), filed 1/25/93, effective 2/25/93. Statutory Authority: RCW 18.64.005.
- 246-857-310 Petitions for rule making, amendment or repeal—Notice of disposition. [Statutory Authority: RCW 18.64.005 and chapter 18.64A RCW. 91-18-057 (Order 191B), recodified as § 246-857-310, filed 8/30/91, effective 9/30/91; Regulation .08.570, filed 1/10/63; Regulation .08.570, filed 3/23/60.] Repealed by 93-04-017 (Order 330B), filed 1/25/93, effective 2/25/93. Statutory Authority: RCW 18.64.005.
- 246-857-320 Declaratory rulings. [Statutory Authority: RCW 18.64.005 and 34.05.220. 92-12-035 (Order 277B), § 246-857-320, filed 5/28/92, effective 6/28/92. Statutory Authority: RCW 18.64.005 and chapter 18.64A RCW. 91-18-057 (Order 191B), recodified as § 246-857-320, filed 8/30/91, effective 9/30/91; Regulation .08.580, filed 1/10/63; Regulation .08.580, filed 3/23/60.] Repealed by 93-04-017 (Order 330B), filed 1/25/93, effective 2/25/93. Statutory Authority: RCW 18.64.005.
- 246-857-330 Forms. [Statutory Authority: RCW 18.64.005 and 34.05.220. 92-12-035 (Order 277B), § 246-857-330, filed 5/28/92, effective 6/28/92. Statutory Authority: RCW 18.64.005 and chapter 18.64A RCW. 91-18-057 (Order 191B), recodified as § 246-857-330, filed 8/30/91, effective 9/30/91; Regulation .08.590, filed 1/10/63; Regulation .08.590, filed 3/23/60.] Repealed by 93-04-017 (Order 330B), filed 1/25/93, effective 2/25/93. Statutory Authority: RCW 18.64.005.
- 246-857-340 SEPA exemption. [Statutory Authority: Chapter 43.21C RCW. 92-12-035 (Order 277B), § 246-857-340, filed 5/28/92, effective 6/28/92. Statutory Authority: RCW 18.64.005 and chapter 18.64A RCW. 91-18-057 (Order 191B), recodified as § 246-857-340, filed 8/30/91, effective 9/30/91; Order 128, § 360-45-010, filed 5/19/76.] Repealed by 93-04-017 (Order 330B), filed 1/25/93, effective 2/25/93. Statutory Authority: RCW 18.64.005.
- Chapter 246-917**  
**PHYSICIANS AND SURGEONS—BOARD OF MEDICAL EXAMINERS**
- 246-917-020 Board meetings. [Statutory Authority: RCW 18.71.017. 91-20-170 (Order 203B), § 246-917-020, filed 10/2/91, effective 11/2/91; 91-06-030 (Order 147B), recodified as § 246-917-020, filed 2/26/91, effective 3/29/91; Order PL 136, § 308-52-010, filed 11/16/72; Rules (part), filed 12/18/63.] Repealed by 96-03-073, filed 1/17/96, effective 2/17/96. Statutory Authority: RCW 18.71.017 and 18.71A.020.
- 246-917-025 Refunds. [Statutory Authority: RCW 18.71.017. 91-20-170 (Order 203B), § 246-917-025, filed 10/2/91, effective 11/2/91.] Repealed by 96-03-073, filed 1/17/96, effective 2/17/96. Statutory Authority: RCW 18.71.017 and 18.71A.020.
- 246-917-026 Application withdrawals. [Statutory Authority: RCW 18.71.017. 91-24-051 (Order 218B), § 246-917-026, filed 11/27/91, effective 12/28/91.] Repealed by 96-03-073, filed 1/17/96, effective 2/17/96. Statutory Authority: RCW 18.71.017 and 18.71A.020.
- 246-917-030 Approved United States and Canadian medical schools. [Statutory Authority: RCW 18.71.017. 91-06-030 (Order 147B), recodified as § 246-917-030, filed 2/26/91, effective 3/29/91; 81-03-079 (Order PL 369), § 308-52-120, filed 1/21/81; Order PL-278, § 308-52-120, filed 11/16/77.] Repealed by 96-03-073, filed 1/17/96, effective 2/17/96. Statutory Authority: RCW 18.71.017 and 18.71A.020.
- 246-917-040 Postgraduate medical training defined. [Statutory Authority: RCW 18.71.017. 91-06-030 (Order 147B), recodified as § 246-917-040, filed 2/26/91, effective 3/29/91; 89-12-053 (Order PM 849), § 308-52-255, filed 6/5/89; 85-11-048 (Order PL 530), § 308-52-255, filed 5/16/85; 84-19-021 (Order PL 481), § 308-52-255, filed 9/12/84; 84-15-068 (Order PL 473), § 308-52-255, filed 7/18/84; 81-03-079 (Order PL 369), § 308-52-255, filed 1/21/81.] Repealed by 96-03-073, filed 1/17/96, effective 2/17/96. Statutory Authority: RCW 18.71.017 and 18.71A.020.
- 246-917-050 Foreign medical graduates. [Statutory Authority: RCW 18.71.017. 91-06-030 (Order 147B), recodified as § 246-917-050, filed 2/26/91, effective 3/29/91; 81-03-079 (Order PL 369), § 308-52-040, filed 1/21/81; Order PL 240, § 308-52-040, filed 2/19/76; Order PL 183, § 308-52-040, filed 2/10/75; Order PL 136, § 308-52-040, filed 11/16/72; Rules (part), filed 12/18/63.] Repealed by 96-03-073, filed 1/17/96, effective 2/17/96. Statutory Authority: RCW 18.71.017 and 18.71A.020.
- 246-917-060 AIDS prevention and information education requirements. [Statutory Authority: RCW 18.71.017. 91-06-030 (Order 147B), recodified as § 246-917-060, filed 2/26/91, effective 3/29/91. Statutory Authority: RCW 70.24.270. 89-06-076 (Order PM 821), § 308-52-620, filed 3/1/89.] Repealed by 96-03-073, filed 1/17/96, effective 2/17/96. Statutory Authority: RCW 18.71.017 and 18.71A.020.
- 246-917-070 Credentialing of physicians and surgeons. [Statutory Authority: RCW 18.71.017. 91-20-170 (Order 203B), § 246-917-070, filed 10/2/91, effective 11/2/91; 91-06-030 (Order 147B), recodified as § 246-917-070, filed 2/26/91, effective 3/29/91. Statutory Authority: RCW 18.71.017 and 18.71A.020. 88-21-047 (Order PM 782), § 308-52-600, filed 10/13/88.] Repealed by 96-03-073, filed 1/17/96, effective 2/17/96. Statutory Authority: RCW 18.71.017 and 18.71A.020.
- 246-917-080 Examinations. [Statutory Authority: RCW 18.71.017. 91-06-030 (Order 147B), recodified as § 246-917-080, filed 2/26/91, effective 3/29/91; Order PL 136, § 308-52-030, filed 11/16/72; Rules (part), filed 12/18/63.] Repealed by 96-03-073, filed 1/17/96, effective 2/17/96. Statutory Authority: RCW 18.71.017 and 18.71A.020.
- 246-917-090 Applications for examination. [Statutory Authority: RCW 18.71.017. 91-06-030 (Order 147B), recodified as § 246-917-090, filed 2/26/91, effective 3/29/91. Statutory Authority: RCW 18.71.017 and 18.72.070. 90-05-001 (Order 031), § 308-52-100, filed 2/8/90, effective 3/11/90.



- Statutory Authority: RCW 18.71.017. 84-15-068 (Order PL 473), § 308-52-100, filed 7/18/84; Order PL 136, § 308-52-100, filed 11/16/72; Rules (part), filed 1/12/65.] Repealed by 96-03-073, filed 1/17/96, effective 2/17/96. Statutory Authority: RCW 18.71.017 and 18.71A.020.
- 246-917-100 Examination scores. [Statutory Authority: RCW 18.71A.020, 18.71.017, 18.71.060 and 18.71.070. 94-15-064, § 246-917-100, filed 7/19/94, effective 8/19/94. Statutory Authority: RCW 18.71.060 and 18.71.070. 93-21-017, § 246-917-100, filed 10/11/93, effective 11/11/93. Statutory Authority: RCW 18.71.017. 91-06-038 (Order 148B), § 246-917-100, filed 2/28/91, effective 3/31/91; 91-06-030 (Order 147B), recodified as § 246-917-100, filed 2/26/91, effective 3/29/91. Statutory Authority: RCW 18.71.017 and 18.71.070 [18.71.070]. 90-18-009 (Order 083), § 308-52-260, filed 8/24/90, effective 9/24/90. Statutory Authority: RCW 18.71.017. 89-06-077 (Order PM 822), § 308-52-260, filed 3/1/89; 85-03-084 (Order PL 508), § 308-52-260, filed 1/18/85; 79-06-063 (Order PL 304), § 308-52-260, filed 5/23/79; 78-04-028 (Order PL 284, Resolution No. 78-139), § 308-52-260, filed 3/14/78; Order PL 240, § 308-52-260, filed 2/19/76.] Repealed by 96-03-073, filed 1/17/96, effective 2/17/96. Statutory Authority: RCW 18.71.017 and 18.71A.020.
- 246-917-110 FLEX examination standards. [Statutory Authority: RCW 18.71.060 and 18.71.070. 93-21-017, § 246-917-110, filed 10/11/93, effective 11/11/93. Statutory Authority: RCW 18.71.017. 91-06-030 (Order 147B), recodified as § 246-917-110, filed 2/26/91, effective 3/29/91; 89-12-053 (Order PM 849), § 308-52-265, filed 6/5/89.] Repealed by 96-03-073, filed 1/17/96, effective 2/17/96. Statutory Authority: RCW 18.71.017 and 18.71A.020.
- 246-917-120 Examinations accepted for reciprocity or waiver. [Statutory Authority: RCW 18.71A.020, 18.71.017, 18.71.060 and 18.71.070. 94-15-064, § 246-917-120, filed 7/19/94, effective 8/19/94. Statutory Authority: RCW 18.71.060 and 18.71.070. 93-21-017, § 246-917-120, filed 10/11/93, effective 11/11/93. Statutory Authority: RCW 18.71.017. 91-06-030 (Order 147B), recodified as § 246-917-120, filed 2/26/91, effective 3/29/91; 86-03-056 (Order PL 577), § 308-52-270, filed 1/15/86; 85-03-084 (Order PL 508), § 308-52-270, filed 1/18/85; 78-04-028 (Order PL 284, Resolution No. 78-139), § 308-52-270, filed 3/14/78; Order PL 268, § 308-52-270, filed 5/11/77; Order PL 240, § 308-52-270, filed 2/19/76.] Repealed by 96-03-073, filed 1/17/96, effective 2/17/96. Statutory Authority: RCW 18.71.017 and 18.71A.020.
- 246-917-121 Special purpose examination. [Statutory Authority: RCW 18.130.250. 93-11-008 (Order 360B), § 246-917-121, filed 5/5/93, effective 6/5/93. Statutory Authority: RCW 18.71.017. 91-20-170 (Order 203B), § 246-917-121, filed 10/2/91, effective 11/2/91.] Repealed by 96-03-073, filed 1/17/96, effective 2/17/96. Statutory Authority: RCW 18.71.017 and 18.71A.020.
- 246-917-125 Temporary permits—Recognized jurisdictions. [Statutory Authority: RCW 18.71.017. 92-08-021 (Order 257B), § 246-917-125, filed 3/20/92, effective 4/20/92.] Repealed by 96-03-073, filed 1/17/96, effective 2/17/96. Statutory Authority: RCW 18.71.017 and 18.71A.020.
- 246-917-126 Temporary permits—Issuance and duration. [Statutory Authority: RCW 18.71.017. 92-08-021 (Order 257B), § 246-917-126, filed 3/20/92, effective 4/20/92.] Repealed by 96-03-073, filed 1/17/96, effective 2/17/96. Statutory Authority: RCW 18.71.017 and 18.71A.020.
- 246-917-130 License renewal. [Statutory Authority: RCW 18.71.017. 91-20-170 (Order 203B), § 246-917-130, filed 10/2/91, effective 11/2/91; 91-06-030 (Order 147B), recodified as § 246-917-130, filed 2/26/91, effective 3/29/91; Order PL 242, § 308-52-320, filed 3/15/76.] Repealed by 96-03-073, filed 1/17/96, effective 2/17/96. Statutory Authority: RCW 18.71.017 and 18.71A.020.
- 246-917-135 License renewal form. [Statutory Authority: RCW 18.130.250. 93-01-078 (Order 321B), § 246-917-135, filed 12/14/92, effective 1/14/93.] Repealed by 96-03-073, filed 1/17/96, effective 2/17/96. Statutory Authority: RCW 18.71.017 and 18.71A.020.
- 246-917-140 Scope. [Statutory Authority: RCW 18.71.017. 91-06-030 (Order 147B), recodified as § 246-917-140, filed 2/26/91, effective 3/29/91; Order PL 247, § 308-52-400, filed 5/17/76.] Repealed by 96-03-073, filed 1/17/96, effective 2/17/96. Statutory Authority: RCW 18.71.017 and 18.71A.020.
- 246-917-150 General requirements. [Statutory Authority: RCW 18.71.017. 91-06-030 (Order 147B), recodified as § 246-917-150, filed 2/26/91, effective 3/29/91; 89-12-053 (Order PM 849), § 308-52-405, filed 6/5/89. Statutory Authority: RCW 18.71.080 and 18.71A.020. 85-23-043 (Order PL 565), § 308-52-405, filed 11/18/85. Statutory Authority: RCW 18.71.017. 79-06-063 (Order PL 304), § 308-52-405, filed 5/23/79; Order PL 247, § 308-52-405, filed 5/17/76.] Repealed by 96-03-073, filed 1/17/96, effective 2/17/96. Statutory Authority: RCW 18.71.017 and 18.71A.020.
- 246-917-160 CME requirements during cycle revision. [Statutory Authority: RCW 18.71.017. 91-06-030 (Order 147B), recodified as § 246-917-160, filed 2/26/91, effective 3/29/91. Statutory Authority: RCW 18.71.080 and 18.71A.020. 85-23-043 (Order PL 565), § 308-52-406, filed 11/18/85. Statutory Authority: RCW 18.71.080. 81-23-051 (Order PL 386), § 308-52-406, filed 11/18/81.] Repealed by 96-03-073, filed 1/17/96, effective 2/17/96. Statutory Authority: RCW 18.71.017 and 18.71A.020.
- 246-917-170 Categories of creditable continuing medical education activities. [Statutory Authority: RCW 18.71.017. 91-06-030 (Order 147B), recodified as § 246-917-170, filed 2/26/91, effective 3/29/91. Statutory Authority: RCW 18.71.080 and 18.71A.020. 85-23-043 (Order PL 565), § 308-52-410, filed 11/18/85; Order PL 247, § 308-52-410, filed 5/17/76.] Repealed by 96-03-073, filed 1/17/96, effective 2/17/96. Statutory Authority: RCW 18.71.017 and 18.71A.020.
- 246-917-180 Continuing medical education requirement. [Statutory Authority: RCW 18.71.017. 91-06-030 (Order 147B), recodified as § 246-917-180, filed 2/26/91, effective 3/29/91; 89-12-053 (Order PM 849), § 308-52-415, filed 6/5/89. Statutory Authority: RCW 18.71.080 and 18.71A.020. 85-23-043 (Order PL 565), § 308-52-415, filed 11/18/85; Order PL 247, § 308-52-415, filed 5/17/76.] Repealed by 96-03-073, filed 1/17/96, effective 2/17/96. Statutory Authority: RCW 18.71.017 and 18.71A.020.
- 246-917-190 Approval not required. [Statutory Authority: RCW 18.71.017. 91-06-030 (Order 147B), recodified as § 246-917-190, filed 2/26/91, effective 3/29/91; Order PL 247, § 308-52-420, filed 5/17/76.] Repealed by 96-03-073, filed 1/17/96, effective 2/17/96. Statutory Authority: RCW 18.71.017 and 18.71A.020.
- 246-917-200 Certification of compliance. [Statutory Authority: RCW 18.71.017. 91-06-030 (Order 147B), recodified as § 246-917-200, filed 2/26/91, effective 3/29/91; Order PL 247, § 308-52-425, filed 5/17/76.] Repealed by 96-03-073, filed 1/17/96, effective 2/17/96. Statutory Authority: RCW 18.71.017 and 18.71A.020.
- 246-917-210 Brief adjudicative proceedings—Denials based on failure to meet education, experience, or examination prerequisites for licensure. [Statutory Authority: Chapters 18.71 and 34.05 RCW. 91-18-036 (Order 192B), § 246-917-210, filed 8/29/91, effective 9/29/91.] Repealed by 96-03-073, filed 1/17/96, effective 2/17/96. Statutory Authority: RCW 18.71.017 and 18.71A.020.
- 246-917-220 Adjudicative proceedings. [Statutory Authority: RCW 18.71.060 and 18.71.070. 93-21-017, § 246-917-220, filed 10/11/93, effective 11/11/93.] Repealed by 96-03-073, filed 1/17/96, effective 2/17/96. Statutory Authority: RCW 18.71.017 and 18.71A.020.
- 246-917-300 Retired active physician license. [Statutory Authority: RCW 18.130.250. 93-01-078 (Order 321B), § 246-917-300, filed 12/14/92, effective 1/14/93.] Repealed by 96-03-073, filed 1/17/96, effective 2/17/96. Statutory Authority: RCW 18.71.017 and 18.71A.020.
- 246-917-990 Physician and surgeon fees. [Statutory Authority: RCW 43.70.250. 93-16-102, § 246-917-990, filed 8/4/93,

effective 9/4/93; 92-08-062 (Order 258), § 246-917-990, filed 3/27/92, effective 4/27/92. Statutory Authority: RCW 43.70.040. 91-06-027 (Order 131), § 246-917-990, filed 2/26/91, effective 3/29/91.] Repealed by 96-03-073, filed 1/17/96, effective 2/17/96. Statutory Authority: RCW 18.71.017 and 18.71A.020.

#### Chapter 246-920

#### PHYSICIANS AND SURGEONS—MEDICAL DISCIPLINARY BOARD

- 246-920-020 Prescriptions—Schedule II stimulant drugs. [Statutory Authority: RCW 18.72.150. 91-02-012 (Order 105B), recodified as § 246-920-020, filed 12/21/90, effective 1/21/91. Statutory Authority: RCW 18.72.150(1). 79-02-044 (Order 296, Resolution No. 296), § 320-18-010, filed 1/29/79.] Repealed by 96-03-073, filed 1/17/96, effective 2/17/96. Statutory Authority: RCW 18.71.017 and 18.71A.020.
- 246-920-030 Cooperation with investigation. [Statutory Authority: RCW 18.72.150. 92-23-035 (Order 316B), § 246-920-030, filed 11/13/92, effective 12/14/92; 91-02-012 (Order 105B), recodified as § 246-920-030, filed 12/21/90, effective 1/21/91. Statutory Authority: RCW 18.130.050. 88-04-080 (Order PM 703), § 320-18-020, filed 2/3/88.] Repealed by 96-03-073, filed 1/17/96, effective 2/17/96. Statutory Authority: RCW 18.71.017 and 18.71A.020.
- 246-920-040 Use of drugs or autotransfusion to enhance athletic ability. [Statutory Authority: RCW 18.72.150. 91-02-012 (Order 105B), recodified as § 246-920-040, filed 12/21/90, effective 1/21/91. Statutory Authority: RCW 18.130.050(1). 88-14-112 (Order 744), § 320-18-030, filed 7/6/88.] Repealed by 96-03-073, filed 1/17/96, effective 2/17/96. Statutory Authority: RCW 18.71.017 and 18.71A.020.
- 246-920-120 Construction. [Statutory Authority: RCW 18.72.150. 91-02-012 (Order 105B), recodified as § 246-920-120, filed 12/21/90, effective 1/21/91. Statutory Authority: RCW 18.72.150, 18.130.050 and 18.130.070. 87-14-053 (Order PM 660), § 320-08-001, filed 7/1/87.] Repealed by 96-03-073, filed 1/17/96, effective 2/17/96. Statutory Authority: RCW 18.71.017 and 18.71A.020.
- 246-920-130 Responsibility for maintaining mailing address on file with the board. [Statutory Authority: RCW 18.72.150. 91-02-012 (Order 105B), recodified as § 246-920-130, filed 12/21/90, effective 1/21/91. Statutory Authority: Chapter 18.72 RCW. 90-20-049 (Order 092), § 320-08-002, filed 9/26/90, effective 10/27/90.] Repealed by 96-03-073, filed 1/17/96, effective 2/17/96. Statutory Authority: RCW 18.71.017 and 18.71A.020.
- 246-920-140 Appearance and practice before agency—Who may appear. [Statutory Authority: RCW 18.72.150. 91-02-012 (Order 105B), recodified as § 246-920-140, filed 12/21/90, effective 1/21/91. Statutory Authority: RCW 18.72.150, 18.130.050 and 18.130.070. 87-14-053 (Order PM 660), § 320-08-010, filed 7/1/87; Rule 320-08-010, filed 12/14/64.] Repealed by 96-03-073, filed 1/17/96, effective 2/17/96. Statutory Authority: RCW 18.71.017 and 18.71A.020.
- 246-920-150 Appearance and practice before agency—Solicitation of business unethical. [Statutory Authority: RCW 18.72.150. 91-02-012 (Order 105B), recodified as § 246-920-150, filed 12/21/90, effective 1/21/91. Statutory Authority: RCW 18.72.150, 18.130.050 and 18.130.070. 87-14-053 (Order PM 660), § 320-08-030, filed 7/1/87; Rule 320-08-020, filed 12/14/64.] Repealed by 96-03-073, filed 1/17/96, effective 2/17/96. Statutory Authority: RCW 18.71.017 and 18.71A.020.
- 246-920-160 Appearance and practice before agency—Standards of ethical conduct. [Statutory Authority: RCW 18.72.150. 91-02-012 (Order 105B), recodified as § 246-920-160, filed 12/21/90, effective 1/21/91. Statutory Authority: RCW 18.72.150, 18.130.050 and 18.130.070. 87-14-053 (Order PM 660), § 320-08-040, filed 7/1/87; Rule 320-08-030, filed 12/14/64.] Repealed by 96-03-073, filed 1/17/96, effective 2/17/96. Statutory Authority: RCW 18.71.017 and 18.71A.020.
- 246-920-170 Appearance and practice before agency—Appearance by former member of attorney general's staff. [Statutory Authority: RCW 18.72.150. 91-02-012 (Order 105B), recodified as § 246-920-170, filed 12/21/90, effective 1/21/91. Statutory Authority: RCW 18.72.150, 18.130.050 and 18.130.070. 87-14-053 (Order PM 660), § 320-08-050, filed 7/1/87; Rule 320-08-040, filed 12/14/64.] Repealed by 96-03-073, filed 1/17/96, effective 2/17/96. Statutory Authority: RCW 18.71.017 and 18.71A.020.
- 246-920-180 Appearance and practice before agency—Former employee and board member as witness. [Statutory Authority: RCW 18.72.150. 91-02-012 (Order 105B), recodified as § 246-920-180, filed 12/21/90, effective 1/21/91. Statutory Authority: RCW 18.72.150, 18.130.050 and 18.130.070. 87-14-053 (Order PM 660), § 320-08-055, filed 7/1/87.] Repealed by 96-03-073, filed 1/17/96, effective 2/17/96. Statutory Authority: RCW 18.71.017 and 18.71A.020.
- 246-920-190 Computation of time. [Statutory Authority: RCW 18.72.150. 91-02-012 (Order 105B), recodified as § 246-920-190, filed 12/21/90, effective 1/21/91. Statutory Authority: RCW 18.72.150, 18.130.050 and 18.130.070. 87-14-053 (Order PM 660), § 320-08-070, filed 7/1/87; Rule 320-08-050, filed 12/14/64.] Repealed by 96-03-073, filed 1/17/96, effective 2/17/96. Statutory Authority: RCW 18.71.017 and 18.71A.020.
- 246-920-200 Notice and opportunity for hearing in contested cases. [Statutory Authority: RCW 18.72.150. 91-02-012 (Order 105B), recodified as § 246-920-200, filed 12/21/90, effective 1/21/91. Statutory Authority: RCW 18.72.150, 18.130.050 and 18.130.070. 87-14-053 (Order PM 660), § 320-08-080, filed 7/1/87; Rule 320-08-060, filed 12/14/64.] Repealed by 96-03-073, filed 1/17/96, effective 2/17/96. Statutory Authority: RCW 18.71.017 and 18.71A.020.
- 246-920-210 Service of process—By whom served. [Statutory Authority: RCW 18.72.150. 91-02-012 (Order 105B), recodified as § 246-920-210, filed 12/21/90, effective 1/21/91. Statutory Authority: RCW 18.72.150, 18.130.050 and 18.130.070. 87-14-053 (Order PM 660), § 320-08-090, filed 7/1/87; Rule 320-08-070, filed 12/14/64.] Repealed by 96-03-073, filed 1/17/96, effective 2/17/96. Statutory Authority: RCW 18.71.017 and 18.71A.020.
- 246-920-220 Service of process—Upon whom served. [Statutory Authority: RCW 18.72.150. 91-02-012 (Order 105B), recodified as § 246-920-220, filed 12/21/90, effective 1/21/91. Statutory Authority: RCW 18.72.150, 18.130.050 and 18.130.070. 87-14-053 (Order PM 660), § 320-08-100, filed 7/1/87; Rule 320-08-080, filed 12/14/64.] Repealed by 96-03-073, filed 1/17/96, effective 2/17/96. Statutory Authority: RCW 18.71.017 and 18.71A.020.
- 246-920-230 Service of process—Service upon parties. [Statutory Authority: RCW 18.72.150. 91-02-012 (Order 105B), recodified as § 246-920-230, filed 12/21/90, effective 1/21/91; Rule 320-08-090, filed 12/14/64.] Repealed by 96-03-073, filed 1/17/96, effective 2/17/96. Statutory Authority: RCW 18.71.017 and 18.71A.020.
- 246-920-240 Service of process—Method of service. [Statutory Authority: RCW 18.72.150. 91-02-012 (Order 105B), recodified as § 246-920-240, filed 12/21/90, effective 1/21/91; Rule 320-08-100, filed 12/14/64.] Repealed by 96-03-073, filed 1/17/96, effective 2/17/96. Statutory Authority: RCW 18.71.017 and 18.71A.020.
- 246-920-250 Service of process—When service complete. [Statutory Authority: RCW 18.72.150. 91-02-012 (Order 105B), recodified as § 246-920-250, filed 12/21/90, effective 1/21/91; Rule 320-08-110, filed 12/14/64.] Repealed by 96-03-073, filed 1/17/96, effective 2/17/96. Statutory Authority: RCW 18.71.017 and 18.71A.020.
- 246-920-260 Service of process—Filing with Washington state medical disciplinary board. [Statutory Authority: RCW 18.72.150. 91-02-012 (Order 105B), recodified as § 246-920-260, filed 12/21/90, effective 1/21/91. Statutory Authority: RCW 18.72.150, 18.130.050 and 18.130.070. 87-14-053

- (Order PM 660), § 320-08-140, filed 7/1/87; Rule 320-08-120, filed 12/14/64.] Repealed by 96-03-073, filed 1/17/96, effective 2/17/96. Statutory Authority: RCW 18.71.017 and 18.71A.020.
- 246-920-270 Subpoenas where provided by law—Form. [Statutory Authority: RCW 18.72.150. 91-02-012 (Order 105B), recodified as § 246-920-270, filed 12/21/90, effective 1/21/91; Rule 320-08-130, filed 12/14/64.] Repealed by 96-03-073, filed 1/17/96, effective 2/17/96. Statutory Authority: RCW 18.71.017 and 18.71A.020.
- 246-920-280 Subpoenas where provided by law—Issuance to parties. [Statutory Authority: RCW 18.72.150. 91-02-012 (Order 105B), recodified as § 246-920-280, filed 12/21/90, effective 1/21/91. Statutory Authority: RCW 18.72.150, 18.130.050 and 18.130.070. 87-14-053 (Order PM 660), § 320-08-160, filed 7/1/87; Rule 320-08-140, filed 12/14/64.] Repealed by 96-03-073, filed 1/17/96, effective 2/17/96. Statutory Authority: RCW 18.71.017 and 18.71A.020.
- 246-920-290 Subpoenas where provided by law—Service. [Statutory Authority: RCW 18.72.150. 91-02-012 (Order 105B), recodified as § 246-920-290, filed 12/21/90, effective 1/21/91; Rule 320-08-150, filed 12/14/64.] Repealed by 96-03-073, filed 1/17/96, effective 2/17/96. Statutory Authority: RCW 18.71.017 and 18.71A.020.
- 246-920-300 Subpoenas where provided by law—Fees. [Statutory Authority: RCW 18.72.150. 91-02-012 (Order 105B), recodified as § 246-920-300, filed 12/21/90, effective 1/21/91. Statutory Authority: RCW 18.72.150, 18.130.050 and 18.130.070. 87-14-053 (Order PM 660), § 320-08-180, filed 7/1/87; Rule 320-08-160, filed 12/14/64.] Repealed by 96-03-073, filed 1/17/96, effective 2/17/96. Statutory Authority: RCW 18.71.017 and 18.71A.020.
- 246-920-310 Subpoenas where provided by law—Proof of service. [Statutory Authority: RCW 18.72.150. 91-02-012 (Order 105B), recodified as § 246-920-310, filed 12/21/90, effective 1/21/91. Statutory Authority: RCW 18.72.150, 18.130.050 and 18.130.070. 87-14-053 (Order PM 660), § 320-08-190, filed 7/1/87; Rule 320-08-170, filed 12/14/64.] Repealed by 96-03-073, filed 1/17/96, effective 2/17/96. Statutory Authority: RCW 18.71.017 and 18.71A.020.
- 246-920-320 Subpoenas where provided by law—Quashing. [Statutory Authority: RCW 18.72.150. 91-02-012 (Order 105B), recodified as § 246-920-320, filed 12/21/90, effective 1/21/91. Statutory Authority: RCW 18.72.150, 18.130.050 and 18.130.070. 87-14-053 (Order PM 660), § 320-08-200, filed 7/1/87; Rule 320-08-180, filed 12/14/64.] Repealed by 96-03-073, filed 1/17/96, effective 2/17/96. Statutory Authority: RCW 18.71.017 and 18.71A.020.
- 246-920-330 Subpoenas where provided by law—Enforcement. [Statutory Authority: RCW 18.72.150. 91-02-012 (Order 105B), recodified as § 246-920-330, filed 12/21/90, effective 1/21/91. Statutory Authority: RCW 18.72.150, 18.130.050 and 18.130.070. 87-14-053 (Order PM 660), § 320-08-210, filed 7/1/87; Rule 320-08-190, filed 12/14/64.] Repealed by 96-03-073, filed 1/17/96, effective 2/17/96. Statutory Authority: RCW 18.71.017 and 18.71A.020.
- 246-920-340 Subpoenas where provided by law—Geographical scope. [Statutory Authority: RCW 18.72.150. 91-02-012 (Order 105B), recodified as § 246-920-340, filed 12/21/90, effective 1/21/91; Rule 320-08-200, filed 12/14/64.] Repealed by 96-03-073, filed 1/17/96, effective 2/17/96. Statutory Authority: RCW 18.71.017 and 18.71A.020.
- 246-920-350 Depositions and interrogatories in contested cases—Right to take. [Statutory Authority: RCW 18.72.150. 91-02-012 (Order 105B), recodified as § 246-920-350, filed 12/21/90, effective 1/21/91; Rule 320-08-210, filed 12/14/64.] Repealed by 96-03-073, filed 1/17/96, effective 2/17/96. Statutory Authority: RCW 18.71.017 and 18.71A.020.
- 246-920-360 Depositions and interrogatories in contested cases—Scope. [Statutory Authority: RCW 18.72.150. 91-02-012 (Order 105B), recodified as § 246-920-360, filed 12/21/90, effective 1/21/91; Rule 320-08-220, filed 12/14/64.] Repealed by 96-03-073, filed 1/17/96, effective 2/17/96. Statutory Authority: RCW 18.71.017 and 18.71A.020.
- 246-920-370 Depositions and interrogatories in contested cases—Officer before whom taken. [Statutory Authority: RCW 18.72.150. 91-02-012 (Order 105B), recodified as § 246-920-370, filed 12/21/90, effective 1/21/91; Rule 320-08-230, filed 12/14/64.] Repealed by 96-03-073, filed 1/17/96, effective 2/17/96. Statutory Authority: RCW 18.71.017 and 18.71A.020.
- 246-920-380 Depositions and interrogatories in contested cases—Authorization. [Statutory Authority: RCW 18.72.150. 91-02-012 (Order 105B), recodified as § 246-920-380, filed 12/21/90, effective 1/21/91. Statutory Authority: RCW 18.72.150, 18.130.050 and 18.130.070. 87-14-053 (Order PM 660), § 320-08-260, filed 7/1/87; Rule 320-08-240, filed 12/14/64.] Repealed by 96-03-073, filed 1/17/96, effective 2/17/96. Statutory Authority: RCW 18.71.017 and 18.71A.020.
- 246-920-390 Depositions and interrogatories in contested cases—Protection of parties and deponents. [Statutory Authority: RCW 18.72.150. 91-02-012 (Order 105B), recodified as § 246-920-390, filed 12/21/90, effective 1/21/91. Statutory Authority: RCW 18.72.150, 18.130.050 and 18.130.070. 87-14-053 (Order PM 660), § 320-08-270, filed 7/1/87; Rule 320-08-250, filed 12/14/64.] Repealed by 96-03-073, filed 1/17/96, effective 2/17/96. Statutory Authority: RCW 18.71.017 and 18.71A.020.
- 246-920-400 Depositions and interrogatories in contested cases—Oral examination and cross-examination. [Statutory Authority: RCW 18.72.150. 91-02-012 (Order 105B), recodified as § 246-920-400, filed 12/21/90, effective 1/21/91; Rule 320-08-260, filed 12/14/64.] Repealed by 96-03-073, filed 1/17/96, effective 2/17/96. Statutory Authority: RCW 18.71.017 and 18.71A.020.
- 246-920-410 Depositions and interrogatories in contested cases—Recordation. [Statutory Authority: RCW 18.72.150. 91-02-012 (Order 105B), recodified as § 246-920-410, filed 12/21/90, effective 1/21/91; Rule 320-08-270, filed 12/14/64.] Repealed by 96-03-073, filed 1/17/96, effective 2/17/96. Statutory Authority: RCW 18.71.017 and 18.71A.020.
- 246-920-420 Depositions and interrogatories in contested cases—Signing attestation and return. [Statutory Authority: RCW 18.72.150. 91-02-012 (Order 105B), recodified as § 246-920-420, filed 12/21/90, effective 1/21/91. Statutory Authority: RCW 18.72.150, 18.130.050 and 18.130.070. 87-14-053 (Order PM 660), § 320-08-300, filed 7/1/87; Rule 320-08-280, filed 12/14/64.] Repealed by 96-03-073, filed 1/17/96, effective 2/17/96. Statutory Authority: RCW 18.71.017 and 18.71A.020.
- 246-920-430 Depositions and interrogatories in contested cases—Use and effect. [Statutory Authority: RCW 18.72.150. 91-02-012 (Order 105B), recodified as § 246-920-430, filed 12/21/90, effective 1/21/91. Statutory Authority: RCW 18.72.150, 18.130.050 and 18.130.070. 87-14-053 (Order PM 660), § 320-08-310, filed 7/1/87; Rule 320-08-290, filed 12/14/64.] Repealed by 96-03-073, filed 1/17/96, effective 2/17/96. Statutory Authority: RCW 18.71.017 and 18.71A.020.
- 246-920-440 Depositions and interrogatories in contested cases—Fees of officers and deponents. [Statutory Authority: RCW 18.72.150. 91-02-012 (Order 105B), recodified as § 246-920-440, filed 12/21/90, effective 1/21/91; Rule 320-08-300, filed 12/14/64.] Repealed by 96-03-073, filed 1/17/96, effective 2/17/96. Statutory Authority: RCW 18.71.017 and 18.71A.020.
- 246-920-450 Depositions upon interrogatories—Submission of interrogatories. [Statutory Authority: RCW 18.72.150. 91-02-012 (Order 105B), recodified as § 246-920-450, filed 12/21/90, effective 1/21/91; Rule 320-08-310, filed 12/14/64.] Repealed by 96-03-073, filed 1/17/96, effective 2/17/96. Statutory Authority: RCW 18.71.017 and 18.71A.020.

- 246-920-460 Depositions upon interrogatories—Interrogation. [Statutory Authority: RCW 18.72.150, 91-02-012 (Order 105B), recodified as § 246-920-460, filed 12/21/90, effective 1/21/91; Rule 320-08-320, filed 12/14/64.] Repealed by 96-03-073, filed 1/17/96, effective 2/17/96. Statutory Authority: RCW 18.71.017 and 18.71A.020.
- 246-920-470 Depositions upon interrogatories—Attestation and return. [Statutory Authority: RCW 18.72.150, 91-02-012 (Order 105B), recodified as § 246-920-470, filed 12/21/90, effective 1/21/91. Statutory Authority: RCW 18.72.150, 18.130.050 and 18.130.070. 87-14-053 (Order PM 660), § 320-08-350, filed 7/1/87; Rule 320-08-330, filed 12/14/64.] Repealed by 96-03-073, filed 1/17/96, effective 2/17/96. Statutory Authority: RCW 18.71.017 and 18.71A.020.
- 246-920-480 Depositions upon interrogatories—Provisions of deposition rule. [Statutory Authority: RCW 18.72.150, 91-02-012 (Order 105B), recodified as § 246-920-480, filed 12/21/90, effective 1/21/91; Rule 320-08-340, filed 12/14/64.] Repealed by 96-03-073, filed 1/17/96, effective 2/17/96. Statutory Authority: RCW 18.71.017 and 18.71A.020.
- 246-920-490 Official notice—Matters of law. [Statutory Authority: RCW 18.72.150, 91-02-012 (Order 105B), recodified as § 246-920-490, filed 12/21/90, effective 1/21/91. Statutory Authority: RCW 18.72.150, 18.130.050 and 18.130.070. 87-14-053 (Order PM 660), § 320-08-370, filed 7/1/87; Rule 320-08-350, filed 12/14/64.] Repealed by 96-03-073, filed 1/17/96, effective 2/17/96. Statutory Authority: RCW 18.71.017 and 18.71A.020.
- 246-920-500 Official notice—Material facts. [Statutory Authority: RCW 18.72.150, 91-02-012 (Order 105B), recodified as § 246-920-500, filed 12/21/90, effective 1/21/91. Statutory Authority: RCW 18.72.150, 18.130.050 and 18.130.070. 87-14-053 (Order PM 660), § 320-08-380, filed 7/1/87; Rule 320-08-360, filed 12/14/64.] Repealed by 96-03-073, filed 1/17/96, effective 2/17/96. Statutory Authority: RCW 18.71.017 and 18.71A.020.
- 246-920-510 Presumptions. [Statutory Authority: RCW 18.72.150, 91-02-012 (Order 105B), recodified as § 246-920-510, filed 12/21/90, effective 1/21/91. Statutory Authority: RCW 18.72.150, 18.130.050 and 18.130.070. 87-14-053 (Order PM 660), § 320-08-390, filed 7/1/87; Rule 320-08-370, filed 12/14/64.] Repealed by 96-03-073, filed 1/17/96, effective 2/17/96. Statutory Authority: RCW 18.71.017 and 18.71A.020.
- 246-920-520 Stipulations and admissions of record. [Statutory Authority: RCW 18.72.150, 91-02-012 (Order 105B), recodified as § 246-920-520, filed 12/21/90, effective 1/21/91. Statutory Authority: RCW 18.72.150, 18.130.050 and 18.130.070. 87-14-053 (Order PM 660), § 320-08-400, filed 7/1/87; Rule 320-08-380, filed 12/14/64.] Repealed by 96-03-073, filed 1/17/96, effective 2/17/96. Statutory Authority: RCW 18.71.017 and 18.71A.020.
- 246-920-530 Form and content of decisions in contested cases. [Statutory Authority: RCW 18.72.150, 91-02-012 (Order 105B), recodified as § 246-920-530, filed 12/21/90, effective 1/21/91. Statutory Authority: RCW 18.72.150, 18.130.050 and 18.130.070. 87-14-053 (Order PM 660), § 320-08-410, filed 7/1/87; Rule 320-08-390, filed 12/14/64.] Repealed by 96-03-073, filed 1/17/96, effective 2/17/96. Statutory Authority: RCW 18.71.017 and 18.71A.020.
- 246-920-540 Definition of issues before hearing. [Statutory Authority: RCW 18.72.150, 91-02-012 (Order 105B), recodified as § 246-920-540, filed 12/21/90, effective 1/21/91. Statutory Authority: RCW 18.72.150, 18.130.050 and 18.130.070. 87-14-053 (Order PM 660), § 320-08-420, filed 7/1/87; Rule 320-08-400, filed 12/14/64.] Repealed by 96-03-073, filed 1/17/96, effective 2/17/96. Statutory Authority: RCW 18.71.017 and 18.71A.020.
- 246-920-550 Prehearing conference rule—Authorized. [Statutory Authority: RCW 18.72.150, 91-02-012 (Order 105B), recodified as § 246-920-550, filed 12/21/90, effective 1/21/91. Statutory Authority: RCW 18.72.150, 18.130.050 and 18.130.070. 87-14-053 (Order PM 660), § 320-08-430, filed 7/1/87; Rule 320-08-410, filed 12/14/64.] Repealed by 96-03-073, filed 1/17/96, effective 2/17/96. Statutory Authority: RCW 18.71.017 and 18.71A.020.
- 246-920-560 Prehearing conference rule—Record of conference action. [Statutory Authority: RCW 18.72.150, 91-02-012 (Order 105B), recodified as § 246-920-560, filed 12/21/90, effective 1/21/91. Statutory Authority: RCW 18.72.150, 18.130.050 and 18.130.070. 87-14-053 (Order PM 660), § 320-08-440, filed 7/1/87; Rule 320-08-420, filed 12/14/64.] Repealed by 96-03-073, filed 1/17/96, effective 2/17/96. Statutory Authority: RCW 18.71.017 and 18.71A.020.
- 246-920-570 Motions. [Statutory Authority: RCW 18.72.150, 91-02-012 (Order 105B), recodified as § 246-920-570, filed 12/21/90, effective 1/21/91. Statutory Authority: RCW 18.72.150, 18.130.050 and 18.130.070. 87-14-053 (Order PM 660), § 320-08-445, filed 7/1/87.] Repealed by 96-03-073, filed 1/17/96, effective 2/17/96. Statutory Authority: RCW 18.71.017 and 18.71A.020.
- 246-920-580 Submission of documentary evidence in advance. [Statutory Authority: RCW 18.72.150, 91-02-012 (Order 105B), recodified as § 246-920-580, filed 12/21/90, effective 1/21/91. Statutory Authority: RCW 18.72.150, 18.130.050 and 18.130.070. 87-14-053 (Order PM 660), § 320-08-450, filed 7/1/87; Rule 320-08-430, filed 12/14/64.] Repealed by 96-03-073, filed 1/17/96, effective 2/17/96. Statutory Authority: RCW 18.71.017 and 18.71A.020.
- 246-920-590 Excerpts from documentary evidence. [Statutory Authority: RCW 18.72.150, 91-02-012 (Order 105B), recodified as § 246-920-590, filed 12/21/90, effective 1/21/91. Statutory Authority: RCW 18.72.150, 18.130.050 and 18.130.070. 87-14-053 (Order PM 660), § 320-08-460, filed 7/1/87; Rule 320-08-440, filed 12/14/64.] Repealed by 96-03-073, filed 1/17/96, effective 2/17/96. Statutory Authority: RCW 18.71.017 and 18.71A.020.
- 246-920-600 Expert or opinion testimony and testimony based on economic and statistical data—Number and qualifications of witnesses. [Statutory Authority: RCW 18.72.150, 91-02-012 (Order 105B), recodified as § 246-920-600, filed 12/21/90, effective 1/21/91. Statutory Authority: RCW 18.72.150, 18.130.050 and 18.130.070. 87-14-053 (Order PM 660), § 320-08-470, filed 7/1/87; Rule 320-08-450, filed 12/14/64.] Repealed by 96-03-073, filed 1/17/96, effective 2/17/96. Statutory Authority: RCW 18.71.017 and 18.71A.020.
- 246-920-610 Continuances. [Statutory Authority: RCW 18.72.150, 91-02-012 (Order 105B), recodified as § 246-920-610, filed 12/21/90, effective 1/21/91. Statutory Authority: RCW 18.72.150, 18.130.050 and 18.130.070. 87-14-053 (Order PM 660), § 320-08-510, filed 7/1/87; Rule 320-08-460, filed 12/14/64.] Repealed by 96-03-073, filed 1/17/96, effective 2/17/96. Statutory Authority: RCW 18.71.017 and 18.71A.020.
- 246-920-620 Rules of evidence—Admissibility criteria. [Statutory Authority: RCW 18.72.150, 91-02-012 (Order 105B), recodified as § 246-920-620, filed 12/21/90, effective 1/21/91. Statutory Authority: RCW 18.72.150, 18.130.050 and 18.130.070. 87-14-053 (Order PM 660), § 320-08-520, filed 7/1/87; Rule 320-08-470, filed 12/14/64.] Repealed by 96-03-073, filed 1/17/96, effective 2/17/96. Statutory Authority: RCW 18.71.017 and 18.71A.020.
- 246-920-630 Rules of evidence—Tentative admission—Exclusion—Discontinuance—Objections. [Statutory Authority: RCW 18.72.150, 91-02-012 (Order 105B), recodified as § 246-920-630, filed 12/21/90, effective 1/21/91. Statutory Authority: RCW 18.72.150, 18.130.050 and 18.130.070. 87-14-053 (Order PM 660), § 320-08-530, filed 7/1/87; Rule 320-08-480, filed 12/14/64.] Repealed by 96-03-073, filed 1/17/96, effective 2/17/96. Statutory Authority: RCW 18.71.017 and 18.71A.020.
- 246-920-640 Petitions for rule making, amendment or repeal—Who may petition. [Statutory Authority: RCW 18.72.150, 91-02-012 (Order 105B), recodified as § 246-920-640, filed 12/21/90, effective 1/21/91. Statutory Authority: RCW

- 18.72.150, 18.130.050 and 18.130.070. 87-14-053 (Order PM 660), § 320-08-540, filed 7/1/87; Rule 320-08-490, filed 12/14/64.] Repealed by 96-03-073, filed 1/17/96, effective 2/17/96. Statutory Authority: RCW 18.71.017 and 18.71A.020.
- 246-920-650 Petitions for rule making, amendment or repeal—Requisites. [Statutory Authority: RCW 18.72.150. 91-02-012 (Order 105B), recodified as § 246-920-650, filed 12/21/90, effective 1/21/91; Rule 320-08-500, filed 12/14/64.] Repealed by 96-03-073, filed 1/17/96, effective 2/17/96. Statutory Authority: RCW 18.71.017 and 18.71A.020.
- 246-920-660 Petitions for rule making, amendment or repeal—Agency must consider. [Statutory Authority: RCW 18.72.150. 91-02-012 (Order 105B), recodified as § 246-920-660, filed 12/21/90, effective 1/21/91; Rule 320-08-510, filed 12/14/64.] Repealed by 96-03-073, filed 1/17/96, effective 2/17/96. Statutory Authority: RCW 18.71.017 and 18.71A.020.
- 246-920-670 Petitions for rule making, amendment or repeal—Notice of disposition. [Statutory Authority: RCW 18.72.150. 91-02-012 (Order 105B), recodified as § 246-920-670, filed 12/21/90, effective 1/21/91; Rule 320-08-520, filed 12/14/64.] Repealed by 96-03-073, filed 1/17/96, effective 2/17/96. Statutory Authority: RCW 18.71.017 and 18.71A.020.
- 246-920-680 Declaratory rulings. [Statutory Authority: RCW 18.72.150. 91-02-012 (Order 105B), recodified as § 246-920-680, filed 12/21/90, effective 1/21/91; Rule 320-08-530, filed 12/14/64.] Repealed by 96-03-073, filed 1/17/96, effective 2/17/96. Statutory Authority: RCW 18.71.017 and 18.71A.020.
- 246-920-690 Forms. [Statutory Authority: RCW 18.72.150. 91-02-012 (Order 105B), recodified as § 246-920-690, filed 12/21/90, effective 1/21/91; Rule 320-08-540, filed 12/14/64.] Repealed by 96-03-073, filed 1/17/96, effective 2/17/96. Statutory Authority: RCW 18.71.017 and 18.71A.020.
- 246-920-710 General provisions. [Statutory Authority: RCW 18.72.150. 91-02-012 (Order 105B), recodified as § 246-920-710, filed 12/21/90, effective 1/21/91. Statutory Authority: RCW 18.72.150, 18.130.050 and 18.130.070. 87-14-047 (Order PM 659), § 320-20-010, filed 6/30/87. Statutory Authority: RCW 18.72.265. 80-16-024 (Order PL 360), § 320-20-010, filed 10/29/80, effective 1/1/81.] Repealed by 96-03-073, filed 1/17/96, effective 2/17/96. Statutory Authority: RCW 18.71.017 and 18.71A.020.
- 246-920-720 Mandatory reporting. [Statutory Authority: RCW 18.72.150. 91-02-012 (Order 105B), recodified as § 246-920-720, filed 12/21/90, effective 1/21/91. Statutory Authority: RCW 18.72.150, 18.130.050 and 18.130.070. 87-14-047 (Order PM 659), § 320-20-020, filed 6/30/87. Statutory Authority: RCW 18.72.265. 80-16-024 (Order PL 360), § 320-20-020, filed 10/29/80, effective 1/1/81.] Repealed by 96-03-073, filed 1/17/96, effective 2/17/96. Statutory Authority: RCW 18.71.017 and 18.71A.020.
- 246-920-730 Health care institutions. [Statutory Authority: Chapter 18.72 RCW. 91-17-015 (Order 190B), § 246-920-730, filed 8/13/91, effective 9/13/91. Statutory Authority: RCW 18.72.150. 91-02-012 (Order 105B), recodified as § 246-920-730, filed 12/21/90, effective 1/21/91. Statutory Authority: RCW 18.72.150, 18.130.050 and 18.130.070. 87-14-047 (Order PM 659), § 320-20-030, filed 6/30/87. Statutory Authority: RCW 18.72.265. 80-16-024 (Order PL 360), § 320-20-030, filed 10/29/80, effective 1/1/81.] Repealed by 96-03-073, filed 1/17/96, effective 2/17/96. Statutory Authority: RCW 18.71.017 and 18.71A.020.
- 246-920-740 Medical associations or societies. [Statutory Authority: RCW 18.72.150. 91-02-012 (Order 105B), recodified as § 246-920-740, filed 12/21/90, effective 1/21/91. Statutory Authority: RCW 18.72.265. 80-16-024 (Order PL 360), § 320-20-040, filed 10/29/80, effective 1/1/81.] Repealed by 96-03-073, filed 1/17/96, effective 2/17/96. Statutory Authority: RCW 18.71.017 and 18.71A.020.
- 246-920-750 Health care service contractors and disability insurance carriers. [Statutory Authority: RCW 18.72.150. 91-02-012 (Order 105B), recodified as § 246-920-750, filed 12/21/90, effective 1/21/91. Statutory Authority: RCW 18.72.265. 80-16-024 (Order PL 360), § 320-20-050, filed 10/29/80, effective 1/1/81.] Repealed by 96-03-073, filed 1/17/96, effective 2/17/96. Statutory Authority: RCW 18.71.017 and 18.71A.020.
- 246-920-760 Courts. [Statutory Authority: RCW 18.72.150. 91-02-012 (Order 105B), recodified as § 246-920-760, filed 12/21/90, effective 1/21/91. Statutory Authority: RCW 18.72.265. 80-16-024 (Order PL 360), § 320-20-070, filed 10/29/80, effective 1/1/81.] Repealed by 96-03-073, filed 1/17/96, effective 2/17/96. Statutory Authority: RCW 18.71.017 and 18.71A.020.
- 246-920-770 State and federal agencies. [Statutory Authority: RCW 18.72.150. 91-02-012 (Order 105B), recodified as § 246-920-770, filed 12/21/90, effective 1/21/91. Statutory Authority: RCW 18.72.265. 80-16-024 (Order PL 360), § 320-20-080, filed 10/29/80, effective 1/1/81.] Repealed by 96-03-073, filed 1/17/96, effective 2/17/96. Statutory Authority: RCW 18.71.017 and 18.71A.020.
- 246-920-780 Professional standards review organizations. [Statutory Authority: RCW 18.72.150. 91-02-012 (Order 105B), recodified as § 246-920-780, filed 12/21/90, effective 1/21/91. Statutory Authority: RCW 18.72.265. 80-16-024 (Order PL 360), § 320-20-090, filed 10/29/80, effective 1/1/81.] Repealed by 96-03-073, filed 1/17/96, effective 2/17/96. Statutory Authority: RCW 18.71.017 and 18.71A.020.
- 246-920-820 Election years in congressional districts. [Statutory Authority: RCW 18.72.150. 91-02-012 (Order 105B), recodified as § 246-920-820, filed 12/21/90, effective 1/21/91; Rule 320-12-010, filed 12/14/64.] Repealed by 91-20-168 (Order 202B), filed 10/2/91, effective 11/2/91. Statutory Authority: RCW 18.72.150.
- 246-920-830 Residential requirement. [Statutory Authority: RCW 18.72.150. 91-02-012 (Order 105B), recodified as § 246-920-830, filed 12/21/90, effective 1/21/91; Rule 320-12-020, filed 12/14/64.] Repealed by 91-20-168 (Order 202B), filed 10/2/91, effective 11/2/91. Statutory Authority: RCW 18.72.150.
- 246-920-840 Nominating petitions. [Statutory Authority: RCW 18.72.150. 91-02-012 (Order 105B), recodified as § 246-920-840, filed 12/21/90, effective 1/21/91. Statutory Authority: RCW 18.72.150, 18.130.050 and 18.130.070. 87-14-047 (Order PM 659), § 320-12-030, filed 6/30/87. Statutory Authority: RCW 18.72.150. 82-01-066 (Order PL 388), § 320-12-030, filed 12/18/81; Rule 320-12-030, filed 12/14/64.] Repealed by 91-20-168 (Order 202B), filed 10/2/91, effective 11/2/91. Statutory Authority: RCW 18.72.150.
- 246-920-850 Eligibility requirement in elections. [Statutory Authority: RCW 18.72.150. 91-02-012 (Order 105B), recodified as § 246-920-850, filed 12/21/90, effective 1/21/91; 82-01-066 (Order PL 388), § 320-12-040, filed 12/18/81; Rule 320-12-040, filed 12/14/64.] Repealed by 91-20-168 (Order 202B), filed 10/2/91, effective 11/2/91. Statutory Authority: RCW 18.72.150.
- 246-920-860 Time of election—Ballots. [Statutory Authority: RCW 18.72.150. 91-02-012 (Order 105B), recodified as § 246-920-860, filed 12/21/90, effective 1/21/91. Statutory Authority: RCW 18.72.150, 18.130.050 and 18.130.070. 87-14-047 (Order PM 659), § 320-12-050, filed 6/30/87. Statutory Authority: RCW 18.72.150. 82-01-066 (Order PL 388), § 320-12-050, filed 12/18/81; Rule 320-12-050, filed 12/14/64.] Repealed by 91-20-168 (Order 202B), filed 10/2/91, effective 11/2/91. Statutory Authority: RCW 18.72.150.
- 246-920-870 Identification by congressional district. [Statutory Authority: RCW 18.72.150. 91-02-012 (Order 105B), recodified as § 246-920-870, filed 12/21/90, effective 1/21/91. Statutory Authority: RCW 18.72.150, 18.130.050 and 18.130.070. 87-14-047 (Order PM 659), § 320-12-060, filed 6/30/87. Statutory Authority: RCW 18.72.150. 82-01-066 (Order PL 388), § 320-12-060, filed 12/18/81;

- Rule 320-12-060, filed 12/14/64.] Repealed by 91-20-168 (Order 202B), filed 10/2/91, effective 11/2/91. Statutory Authority: RCW 18.72.150.
- 246-920-880 Ballots. [Statutory Authority: RCW 18.72.150. 91-02-012 (Order 105B), recodified as § 246-920-880, filed 12/21/90, effective 1/21/91. Statutory Authority: RCW 18.72.150, 18.130.050 and 18.130.070. 87-14-047 (Order PM 659), § 320-12-070, filed 6/30/87. Statutory Authority: RCW 18.72.150. 82-01-066 (Order PL 388), § 320-12-070, filed 12/18/81; Rule 320-12-070, filed 12/14/64.] Repealed by 91-20-168 (Order 202B), filed 10/2/91, effective 11/2/91. Statutory Authority: RCW 18.72.150.
- 246-920-890 Canvassing and certification. [Statutory Authority: RCW 18.72.150. 91-02-012 (Order 105B), recodified as § 246-920-890, filed 12/21/90, effective 1/21/91; Rule 320-12-080, filed 12/14/64.] Repealed by 96-03-073, filed 1/17/96, effective 2/17/96. Statutory Authority: RCW 18.71.017 and 18.71A.020.
- Chapter 246-975  
AMBULANCES**
- 246-975-001 Declaration of purpose. [Statutory Authority: RCW 43.70.040. 91-02-049 (Order 121), recodified as § 246-975-001, filed 12/27/90, effective 1/31/91. Statutory Authority: RCW 18.73.080. 82-04-041 (Order 1752), § 248-17-010, filed 1/29/82; Order 1150, § 248-17-010, filed 9/2/76.] Repealed by 93-01-148 (Order 323), filed 12/23/92, effective 1/23/93. Statutory Authority: RCW 43.70.040 and chapters 18.71, 18.73 and 70.168 RCW.
- 246-975-010 Definitions. [Statutory Authority: RCW 43.70.040. 91-02-049 (Order 121), recodified as § 246-975-010, filed 12/27/90, effective 1/31/91. Statutory Authority: Chapter 18.73 RCW. 89-22-108 (Order 007), § 248-17-020, filed 11/1/89, effective 12/2/89. Statutory Authority: RCW 18.73.080. 84-17-036 (Order 2138), § 248-17-020, filed 8/10/84; 82-19-080 (Order 1881), § 248-17-020, filed 9/21/82; 82-04-041 (Order 1752), § 248-17-020, filed 1/29/82; Order 1150, § 248-17-020, filed 9/2/76.] Repealed by 93-01-148 (Order 323), filed 12/23/92, effective 1/23/93. Statutory Authority: RCW 43.70.040 and chapters 18.71, 18.73 and 70.168 RCW.
- 246-975-020 License(s) required. [Statutory Authority: RCW 43.70.040. 91-02-049 (Order 121), recodified as § 246-975-020, filed 12/27/90, effective 1/31/91. Statutory Authority: RCW 18.73.080. 82-04-041 (Order 1752), § 248-17-030, filed 1/29/82; Order 1150, § 248-17-030, filed 9/2/76.] Repealed by 93-01-148 (Order 323), filed 12/23/92, effective 1/23/93. Statutory Authority: RCW 43.70.040 and chapters 18.71, 18.73 and 70.168 RCW.
- 246-975-030 License expiration dates. [Statutory Authority: RCW 43.70.040. 91-02-049 (Order 121), recodified as § 246-975-030, filed 12/27/90, effective 1/31/91. Statutory Authority: RCW 18.73.080. 82-04-041 (Order 1752), § 248-17-040, filed 1/29/82; Order 1150, § 248-17-040, filed 9/2/76.] Repealed by 93-01-148 (Order 323), filed 12/23/92, effective 1/23/93. Statutory Authority: RCW 43.70.040 and chapters 18.71, 18.73 and 70.168 RCW.
- 246-975-040 License expiration dates. [Statutory Authority: RCW 43.70.040. 91-02-049 (Order 121), recodified as § 246-975-040, filed 12/27/90, effective 1/31/91. Statutory Authority: RCW 18.73.080. 82-04-041 (Order 1752), § 248-17-050, filed 1/29/82; Order 1150, § 248-17-050, filed 9/2/76.] Repealed by 93-01-148 (Order 323), filed 12/23/92, effective 1/23/93. Statutory Authority: RCW 43.70.040 and chapters 18.71, 18.73 and 70.168 RCW.
- 246-975-050 Denial, suspension, revocation of license—Notice—Adjudicative proceeding. [Statutory Authority: RCW 43.70.040. 91-02-049 (Order 121), recodified as § 246-975-050, filed 12/27/90, effective 1/31/91. Statutory Authority: Chapter 34.05 RCW, RCW 34.05.220 (1)(a) and 1989 1st ex.s. c 9 § 106. 90-06-019 (Order 039), § 248-17-060, filed 2/28/90, effective 3/1/90; Order 1150, § 248-17-060, filed 9/2/76.] Repealed by 93-01-148 (Order 323), filed 12/23/92, effective 1/23/93. Statutory Authority: RCW 43.70.040 and chapters 18.71, 18.73 and 70.168 RCW.
- 246-975-060 Ambulance vehicle and equipment. [Statutory Authority: RCW 43.70.040. 91-02-049 (Order 121), recodified as § 246-975-060, filed 12/27/90, effective 1/31/91; Order 1150, § 248-17-070, filed 9/2/76.] Repealed by 93-01-148 (Order 323), filed 12/23/92, effective 1/23/93. Statutory Authority: RCW 43.70.040 and chapters 18.71, 18.73 and 70.168 RCW.
- 246-975-070 Extrication equipment. [Statutory Authority: RCW 43.70.040. 91-02-049 (Order 121), recodified as § 246-975-070, filed 12/27/90, effective 1/31/91. Statutory Authority: RCW 18.73.080. 82-19-080 (Order 1881), § 248-17-080, filed 9/21/82; Order 1150, § 248-17-080, filed 9/2/76.] Repealed by 93-01-148 (Order 323), filed 12/23/92, effective 1/23/93. Statutory Authority: RCW 43.70.040 and chapters 18.71, 18.73 and 70.168 RCW.
- 246-975-080 Variances. [Statutory Authority: RCW 43.70.040. 91-02-049 (Order 121), recodified as § 246-975-080, filed 12/27/90, effective 1/31/91; Order 1150, § 248-17-090, filed 9/2/76.] Repealed by 93-01-148 (Order 323), filed 12/23/92, effective 1/23/93. Statutory Authority: RCW 43.70.040 and chapters 18.71, 18.73 and 70.168 RCW.
- 246-975-090 Radio communications equipment—Ambulance vehicle. [Statutory Authority: RCW 43.70.040. 91-02-049 (Order 121), recodified as § 246-975-090, filed 12/27/90, effective 1/31/91; Order 1150, § 248-17-100, filed 9/2/76.] Repealed by 93-01-148 (Order 323), filed 12/23/92, effective 1/23/93. Statutory Authority: RCW 43.70.040 and chapters 18.71, 18.73 and 70.168 RCW.
- 246-975-100 First aid vehicle and equipment. [Statutory Authority: RCW 43.70.040. 91-02-049 (Order 121), recodified as § 246-975-100, filed 12/27/90, effective 1/31/91. Statutory Authority: RCW 18.73.080. 82-19-080 (Order 1881), § 248-17-110, filed 9/21/82; Order 1150, § 248-17-110, filed 9/2/76.] Repealed by 93-01-148 (Order 323), filed 12/23/92, effective 1/23/93. Statutory Authority: RCW 43.70.040 and chapters 18.71, 18.73 and 70.168 RCW.
- 246-975-110 Extrication equipment. [Statutory Authority: RCW 43.70.040. 91-02-049 (Order 121), recodified as § 246-975-110, filed 12/27/90, effective 1/31/91. Statutory Authority: RCW 18.73.080. 82-19-080 (Order 1881), § 248-17-120, filed 9/21/82; Order 1150, § 248-17-120, filed 9/2/76.] Repealed by 93-01-148 (Order 323), filed 12/23/92, effective 1/23/93. Statutory Authority: RCW 43.70.040 and chapters 18.71, 18.73 and 70.168 RCW.
- 246-975-120 Variances. [Statutory Authority: RCW 43.70.040. 91-02-049 (Order 121), recodified as § 246-975-120, filed 12/27/90, effective 1/31/91; Order 1150, § 248-17-130, filed 9/2/76.] Repealed by 93-01-148 (Order 323), filed 12/23/92, effective 1/23/93. Statutory Authority: RCW 43.70.040 and chapters 18.71, 18.73 and 70.168 RCW.
- 246-975-130 Air ambulance services. [Statutory Authority: RCW 43.70.040. 91-02-049 (Order 121), recodified as § 246-975-130, filed 12/27/90, effective 1/31/91. Statutory Authority: RCW 18.73.080. 82-04-041 (Order 1752), § 248-17-135, filed 1/29/82.] Repealed by 93-01-148 (Order 323), filed 12/23/92, effective 1/23/93. Statutory Authority: RCW 43.70.040 and chapters 18.71, 18.73 and 70.168 RCW.
- 246-975-140 Radio communications equipment. [Statutory Authority: RCW 43.70.040. 91-02-049 (Order 121), recodified as § 246-975-140, filed 12/27/90, effective 1/31/91; Order 1150, § 248-17-140, filed 9/2/76.] Repealed by 93-01-148 (Order 323), filed 12/23/92, effective 1/23/93. Statutory Authority: RCW 43.70.040 and chapters 18.71, 18.73 and 70.168 RCW.
- 246-975-150 Variances from the requirements of this chapter. [Statutory Authority: RCW 43.70.040. 91-02-049 (Order 121), recodified as § 246-975-150, filed 12/27/90, effective 1/31/91; Order 1150, § 248-17-150, filed 9/2/76.] Repealed by 93-01-148 (Order 323), filed 12/23/92, effective 1/23/93. Statutory Authority: RCW 43.70.040 and chapters 18.71, 18.73 and 70.168 RCW.
- 246-975-160 Ambulance operator, ambulance director record requirements. [Statutory Authority: Chapter 18.73 RCW. 91-06-026 (Order 126), § 246-975-160, filed 2/26/91, effective 3/29/91. Statutory Authority: RCW 43.70.040. 91-







- 246-975-320 First responder—Certification and recertification. [Statutory Authority: RCW 43.70.040. 91-02-049 (Order 121), recodified as § 246-975-320, filed 12/27/90, effective 1/31/91. Statutory Authority: Chapter 18.73 RCW. 89-22-108 (Order 007), § 248-17-260, filed 11/1/89, effective 12/2/89. Statutory Authority: RCW 18.73.080. 84-17-036 (Order 2138), § 248-17-260, filed 8/10/84.] Repealed by 93-01-148 (Order 323), filed 12/23/92, effective 1/23/93. Statutory Authority: RCW 43.70.040 and chapters 18.71, 18.73 and 70.168 RCW.
- 246-975-330 Recertification—General requirements. [Statutory Authority: RCW 43.70.040. 91-02-049 (Order 121), recodified as § 246-975-330, filed 12/27/90, effective 1/31/91. Statutory Authority: Chapter 18.73 RCW. 89-22-108 (Order 007), § 248-17-261, filed 11/1/89, effective 12/2/89.] Repealed by 93-01-148 (Order 323), filed 12/23/92, effective 1/23/93. Statutory Authority: RCW 43.70.040 and chapters 18.71, 18.73 and 70.168 RCW.
- 246-975-340 First responder—Reciprocity, challenges and reinstatement. [Statutory Authority: RCW 43.70.040. 91-02-049 (Order 121), recodified as § 246-975-340, filed 12/27/90, effective 1/31/91. Statutory Authority: RCW 18.73.080. 84-17-036 (Order 2138), § 248-17-265, filed 8/10/84.] Repealed by 93-01-148 (Order 323), filed 12/23/92, effective 1/23/93. Statutory Authority: RCW 43.70.040 and chapters 18.71, 18.73 and 70.168 RCW.
- 246-975-350 First responder—Scope of care authorized, prohibited. [Statutory Authority: RCW 43.70.040. 91-02-049 (Order 121), recodified as § 246-975-350, filed 12/27/90, effective 1/31/91. Statutory Authority: RCW 18.73.080. 84-17-036 (Order 2138), § 248-17-270, filed 8/10/84.] Repealed by 93-01-148 (Order 323), filed 12/23/92, effective 1/23/93. Statutory Authority: RCW 43.70.040 and chapters 18.71, 18.73 and 70.168 RCW.
- 246-975-360 First responder—Revocation or suspension of certificate. [Statutory Authority: RCW 43.70.040. 91-02-049 (Order 121), recodified as § 246-975-360, filed 12/27/90, effective 1/31/91. Statutory Authority: RCW 18.73.080. 84-17-036 (Order 2138), § 248-17-275, filed 8/10/84.] Repealed by 93-01-148 (Order 323), filed 12/23/92, effective 1/23/93. Statutory Authority: RCW 43.70.040 and chapters 18.71, 18.73 and 70.168 RCW.
- 246-975-990 Ambulances and first-aid vehicles licensing and inspection fees. [Statutory Authority: RCW 43.70.040. 91-02-049 (Order 121), recodified as § 246-975-990, filed 12/27/90, effective 1/31/91. Statutory Authority: RCW 43.20B.110. 89-16-064 (Order 2839), § 440-44-023, filed 7/31/89, effective 8/31/89. Statutory Authority: 1982 c 201. 82-13-011 (Order 1825), § 440-44-023, filed 6/4/82.] Repealed by 93-01-148 (Order 323), filed 12/23/92, effective 1/23/93. Statutory Authority: RCW 43.70.040 and chapters 18.71, 18.73 and 70.168 RCW.
- Chapter 246-977**  
**ADVANCED LIFE SUPPORT TECHNICIANS**
- 246-977-001 Declaration of purpose. [Statutory Authority: RCW 43.70.040. 91-02-049 (Order 121), recodified as § 246-977-001, filed 12/27/90, effective 1/31/91. Statutory Authority: RCW 18.71.205. 78-09-055 (Order 1329), § 248-15-010, filed 8/22/78.] Repealed by 93-01-148 (Order 323), filed 12/23/92, effective 1/23/93. Statutory Authority: RCW 43.70.040 and chapters 18.71, 18.73 and 70.168 RCW.
- 246-977-010 Definitions. [Statutory Authority: RCW 43.70.040. 91-02-049 (Order 121), recodified as § 246-977-010, filed 12/27/90, effective 1/31/91. Statutory Authority: RCW 18.71.205. 87-19-025 (Order 2532), § 248-15-020, filed 9/10/87; 84-17-035 (Order 2137), § 248-15-020, filed 8/10/84; 81-23-016 (Order 1718), § 248-15-020, filed 11/12/81; 78-09-055 (Order 1329), § 248-15-020, filed 8/22/78.] Repealed by 93-01-148 (Order 323), filed 12/23/92, effective 1/23/93. Statutory Authority: RCW 43.70.040 and chapters 18.71, 18.73 and 70.168 RCW.
- 246-977-020 Medical program director. [Statutory Authority: RCW 43.70.040. 91-02-049 (Order 121), recodified as § 246-977-020, filed 12/27/90, effective 1/31/91. Statutory Authority: RCW 18.71.205. 87-19-025 (Order 2532), § 248-15-025, filed 9/10/87.] Repealed by 93-01-148 (Order 323), filed 12/23/92, effective 1/23/93. Statutory Authority: RCW 43.70.040 and chapters 18.71, 18.73 and 70.168 RCW.
- 246-977-030 Physician's trained mobile intravenous therapy technician—Airway management technician—Mobile intensive care paramedic, selection, general training, and knowledge standards. [Statutory Authority: RCW 43.70.040. 91-02-049 (Order 121), recodified as § 246-977-030, filed 12/27/90, effective 1/31/91. Statutory Authority: RCW 18.71.205. 84-17-035 (Order 2137), § 248-15-030, filed 8/10/84; 81-23-016 (Order 1718), § 248-15-030, filed 11/12/81; 78-09-055 (Order 1329), § 248-15-030, filed 8/22/78.] Repealed by 93-01-148 (Order 323), filed 12/23/92, effective 1/23/93. Statutory Authority: RCW 43.70.040 and chapters 18.71, 18.73 and 70.168 RCW.
- 246-977-040 Physician's trained mobile IV therapy technician—Training and knowledge standards. [Statutory Authority: RCW 43.70.040. 91-02-049 (Order 121), recodified as § 246-977-040, filed 12/27/90, effective 1/31/91. Statutory Authority: RCW 18.71.205. 89-06-003 (Order 2764), § 248-15-040, filed 2/16/89; 78-09-055 (Order 1329), § 248-15-040, filed 8/22/78.] Repealed by 93-01-148 (Order 323), filed 12/23/92, effective 1/23/93. Statutory Authority: RCW 43.70.040 and chapters 18.71, 18.73 and 70.168 RCW.
- 246-977-050 Physician's trained mobile airway management technician—Training and knowledge standards. [Statutory Authority: RCW 43.70.040. 91-02-049 (Order 121), recodified as § 246-977-050, filed 12/27/90, effective 1/31/91. Statutory Authority: RCW 18.71.205. 89-06-003 (Order 2764), § 248-15-050, filed 2/16/89; 81-23-016 (Order 1718), § 248-15-050, filed 11/12/81; 78-09-055 (Order 1329), § 248-15-050, filed 8/22/78.] Repealed by 93-01-148 (Order 323), filed 12/23/92, effective 1/23/93. Statutory Authority: RCW 43.70.040 and chapters 18.71, 18.73 and 70.168 RCW.
- 246-977-060 Physician's trained mobile intensive care paramedic—Training and knowledge standards. [Statutory Authority: RCW 43.70.040. 91-02-049 (Order 121), recodified as § 246-977-060, filed 12/27/90, effective 1/31/91. Statutory Authority: RCW 18.71.205. 78-09-055 (Order 1329), § 248-15-060, filed 8/22/78.] Repealed by 93-01-148 (Order 323), filed 12/23/92, effective 1/23/93. Statutory Authority: RCW 43.70.040 and chapters 18.71, 18.73 and 70.168 RCW.
- 246-977-070 Testing. [Statutory Authority: RCW 43.70.040. 91-02-049 (Order 121), recodified as § 246-977-070, filed 12/27/90, effective 1/31/91. Statutory Authority: RCW 18.71.205. 78-09-055 (Order 1329), § 248-15-070, filed 8/22/78.] Repealed by 93-01-148 (Order 323), filed 12/23/92, effective 1/23/93. Statutory Authority: RCW 43.70.040 and chapters 18.71, 18.73 and 70.168 RCW.
- 246-977-080 Certification and recertification. [Statutory Authority: RCW 43.70.040. 91-02-049 (Order 121), recodified as § 246-977-080, filed 12/27/90, effective 1/31/91. Statutory Authority: RCW 18.71.205. 84-17-035 (Order 2137), § 248-15-080, filed 8/10/84; 81-23-016 (Order 1718), § 248-15-080, filed 11/12/81; 78-09-055 (Order 1329), § 248-15-080, filed 8/22/78.] Repealed by 93-01-148 (Order 323), filed 12/23/92, effective 1/23/93. Statutory Authority: RCW 43.70.040 and chapters 18.71, 18.73 and 70.168 RCW.
- 246-977-090 Certification of individuals who have not completed a training course conducted by approved training physicians in the state of Washington. [Statutory Authority: RCW 43.70.040. 91-02-049 (Order 121), recodified as § 246-977-090, filed 12/27/90, effective 1/31/91. Statutory Authority: RCW 18.71.205. 81-23-016 (Order 1718), § 248-15-091, filed 11/12/81.] Repealed by 93-01-148 (Order 323), filed 12/23/92, effective 1/23/93. Statutory Authority: RCW 43.70.040 and chapters 18.71, 18.73 and 70.168 RCW.
- 246-977-100 Revocation, suspension or modification of certificate. [Statutory Authority: RCW 43.70.040. 91-02-049 (Order

121), recodified as § 246-977-100, filed 12/27/90, effective 1/31/91. Statutory Authority: RCW 18.71.205. 84-17-035 (Order 2137), § 248-15-100, filed 8/10/84; 78-09-055 (Order 1329), § 248-15-100, filed 8/22/78.] Repealed by 93-01-148 (Order 323), filed 12/23/92, effective 1/23/93. Statutory Authority: RCW 43.70.040 and chapters 18.71, 18.73 and 70.168 RCW.

246-977-110 Notice of decision—Adjudicative proceeding. [Statutory Authority: RCW 43.70.040. 91-02-049 (Order 121), recodified as § 246-977-110, filed 12/27/90, effective 1/31/91. Statutory Authority: Chapter 34.05 RCW, RCW 34.05.220 (1)(a) and 18.71.205. 90-06-019 (Order 039), § 248-15-110, filed 2/28/90, effective 3/1/90. Statutory Authority: RCW 18.71.205. 78-09-055 (Order 1329), § 248-15-110, filed 8/22/78.] Repealed by 93-01-148 (Order 323), filed 12/23/92, effective 1/23/93. Statutory Authority: RCW 43.70.040 and chapters 18.71, 18.73 and 70.168 RCW.

**Chapter 246-01 WAC**

**DESCRIPTION AND ORGANIZATION**

**WAC**

- 246-01-001 Purpose and authority.
- 246-01-010 Definitions.
- 246-01-020 Functions.
- 246-01-030 Secretary.
- 246-01-040 Department and professional boards—Relationship.
- 246-01-050 Department and state board of health—Relationship.
- 246-01-060 Department and local health departments/districts—Relationship.
- 246-01-070 Department and health professions resource committee—Relationship.
- 246-01-080 Organization.
- 246-01-090 Consumer assistance.
- 246-01-100 Current address.

**WAC 246-01-001 Purpose and authority.** (1) The purpose of this chapter is to describe the department of health and the general course and method of its operations. This chapter is adopted pursuant to RCW 34.05.220 and 42.17.250, and chapter 43.70 RCW.

(2) The department of health is charged with preserving public health, monitoring health care costs, maintaining minimal standards for quality in health care delivery, and generally overseeing and planning the state's activities as they relate to the health of its citizenry.

[Statutory Authority: RCW 43.70.050. 93-08-004 (Order 346), § 246-01-001, filed 3/24/93, effective 4/24/93.]

**WAC 246-01-010 Definitions.** As used in this chapter:

- (1) "Department" means the department of health.
- (2) "Secretary" means the secretary of the department of health or the secretary's designee.

[Statutory Authority: RCW 43.70.050. 93-08-004 (Order 346), § 246-01-010, filed 3/24/93, effective 4/24/93.]

**WAC 246-01-020 Functions.** The department balances its three core functions to accomplish its mission:

- (1) Assessment. To regularly assess state health needs and resources, the department shall:
  - (a) Collect data on health status, personal health services, and the environment;
  - (b) Address major health problems in the state or community and population groups at greatest risk; availability

ty and quality of service; resource availability; and the primary concerns of both citizens and providers; and

(c) Make budget and program revisions based on this assessment.

(2) Policy development. To develop and implement sound public policy, the department includes:

- (a) Knowledge gained from assessment;
- (b) Consideration of the political, organizational, and community environments;
- (c) Citizen participation; and
- (d) Cooperation with the state board of health and other state and local agencies.

(3) Assurance. To ensure the capacity of public health agencies to manage day-to-day operations and to respond to public health emergencies, the department shall:

- (a) Provide direct support when costs to replicate services in each local area would be prohibitive;
- (b) Provide technical assistance when services can be provided more effectively by local health agencies; and
- (c) Provide quality service.

[Statutory Authority: RCW 43.70.050. 93-08-004 (Order 346), § 246-01-020, filed 3/24/93, effective 4/24/93.]

**WAC 246-01-030 Secretary.** (1) The secretary is appointed by, and serves at the pleasure of, the governor. In addition to other powers, the secretary may:

- (a) Adopt rules;
- (b) Appoint advisory committees on areas of emerging concern;
- (c) Undertake studies, research, and analyses;
- (d) Delegate powers, duties, and functions;
- (e) Enter into contracts on behalf of the department; and
- (f) Act for the state in the initiation of, or the participation in, intergovernmental programs.

(2) In case of the absence or disability of the secretary, or in case the office of secretary becomes vacant, the deputy secretary shall have full charge and supervision of the department and shall have the same power and authority to act as the secretary.

(3) In the case of the absence or disability of the secretary and the deputy secretary, the person designated "acting secretary" shall have the same power and authority to act as the secretary. If no person has been so designated, then the power to act as acting secretary shall be vested in any of the assistant secretaries designated in WAC 246-01-080, in the order in which they are listed therein.

[Statutory Authority: RCW 43.70.050. 93-08-004 (Order 346), § 246-01-030, filed 3/24/93, effective 4/24/93.]

**WAC 246-01-040 Department and professional boards—Relationship.** The department works with the following professional boards, commissions, committees, and councils which have varying degrees of statutory authority, ranging from advisory powers to rule adoption and disciplinary powers:

- Health professions quality assurance committee.
- Chiropractic quality assurance commission.
- Dental quality assurance commission.
- Dental hygiene examining committee.
- Board of denture technology.
- Dispensing opticians examining committee.

Board on fitting and dispensing of hearing aids.  
 Massage examining board.  
 Medical quality assurance commission.  
 Mental health quality assurance council.  
 Midwifery advisory committee.  
 Naturopathic advisory committee.  
 Nursing home administrators board.  
 Nursing care quality assurance commission.  
 Board of occupational therapy.  
 Optometry board.  
 Board of osteopathic medicine and surgery.  
 Board of pharmacy.  
 Board of physical therapy.  
 Podiatry board.  
 Examining board of psychology.  
 Sex offender treatment provider advisory committee.  
 Veterinary board of governors.

[Statutory Authority: RCW 43.70.040, 95-10-043, § 246-01-040, filed 5/1/95, effective 6/1/95. Statutory Authority: RCW 43.70.050, 93-08-004 (Order 346), § 246-01-040, filed 3/24/93, effective 4/24/93.]

**WAC 246-01-050 Department and state board of health—Relationship.** (1) The secretary serves as a member of the state board of health.

(2) The state board of health may advise the secretary on health policy issues pertaining to the department and the state.

(3) The state board of health has statutory authority to adopt rules to protect the public health, and may delegate this authority to the secretary and rescind such delegated authority.

(4) The department enforces the rules, regulations, and orders of the state board of health.

[Statutory Authority: RCW 43.70.050, 93-08-004 (Order 346), § 246-01-050, filed 3/24/93, effective 4/24/93.]

**WAC 246-01-060 Department and local health departments/districts—Relationship.** (1) The department works with local health departments/districts in partnership to promote public health.

(2) The department provides notification of outbreaks and epidemics of disease that may occur and advises local departments/districts of the measures necessary to prevent and control such outbreaks and epidemics.

(3) Upon the request of a local health officer, the department may take legal action to enforce public health laws, rules, and regulations of the state board of health or local rules and regulations within the jurisdiction served by the local health department, and may institute any civil legal proceeding authorized by state law.

[Statutory Authority: RCW 43.70.050, 93-08-004 (Order 346), § 246-01-060, filed 3/24/93, effective 4/24/93.]

**WAC 246-01-070 Department and health professions resource committee—Relationship.** (1) The health professions resource committee is comprised of representatives of the department, department of social and health services, higher education coordinating board, state board for community and technical colleges, and office of the superintendent of public instruction.

(2) The department serves as the lead administrative agency for the health professions resource committee.

(3) The health professions resource committee shall develop a state-wide plan which identifies health personnel shortages and contains policies, designs, and strategies to implement activities to address and alleviate those shortages.

[Statutory Authority: RCW 43.70.050, 93-08-004 (Order 346), § 246-01-070, filed 3/24/93, effective 4/24/93.]

**WAC 246-01-080 Organization.** (1) The department is headed by the secretary. The office of the secretary provides overall agency management, and is comprised of the secretary, deputy secretary, state health officer, policy and planning, legislative and constituent relations, minority affairs, and the communications office.

(2) Six assistant secretaries direct specific programs within the department.

(a) *The assistant secretary for epidemiology and health statistics:*

(i) Collects and analyzes data that provides information about the health of the population, hospital costs, hospital diagnosis and procedures;

(ii) Collects information on all births, deaths, marriages, and divorces within the state and makes official documentation of these events available to the public;

(iii) Conducts surveillance of communicable and noncommunicable diseases and other health-related events. Investigates disease outbreaks, epidemics, and clusters; provides technical assistance and advice in developing and implementing prevention/control programs; provides expert consultation to local health departments on epidemiologically impacted issues and, when necessary, directs support for responding to emergent public health situations;

(iv) Develops a health services information system that supports the implementation of health reform as envisioned under the Health Services Act of 1993, and monitors the effectiveness of the reformed health care environment;

(v) Monitors the consistency, quality, continuity, and comprehensiveness of the department's health assessment activities, including disease surveillance and program evaluation;

(iv) Provides a scientific basis for health policy and program management decisions within the department and, when requested, to local health departments.

(b) *The assistant secretary for health systems quality assurance:*

(i) Administers laws and enforces rules, regulations, and standards for the following professions:

Acupuncturists  
 Airway management technicians  
 Animal technicians  
 Chiropractic x-ray technicians  
 Controlled substance researchers  
 Counselors/registered & certified  
 Dental hygienists  
 Dentists  
 Denturists  
 Dieticians/nutritionists  
 Dispensing opticians  
 Doctors of chiropractic  
 Drug manufacturers & wholesalers

Emergency medical technicians  
 First responders  
 Health care assistants  
 Hearing aid fitters  
 Intravenous technicians  
 Legend drug sample distributors  
 Massage practitioners  
 Midwives  
 Naturopathic physicians  
 Nursing assistants  
 Nursing home administrators  
 Nursing pools  
 Occupational therapists  
 Occupational therapists' assistants  
 Ocularists  
 Optometrists  
 Osteopathic physicians and surgeons  
 Osteopathic physicians' assistants  
 Osteopathic physicians' acupuncture assistants  
 Pharmacists  
 Paramedics  
 Pharmacy assistants  
 Physical therapists  
 Physicians and surgeons  
 Physician assistants  
 Podiatric physicians and surgeons  
 Practical nurses  
 Psychologists  
 Radiological technologists  
 Registered nurses  
 Respiratory care practitioners  
 Sex offender treatment providers  
 Veterinarians  
 Veterinary med clerks  
 X-ray technicians

(ii) Sets standards, inspects, licenses, or certifies, provides consultation, and reviews and approves construction of new buildings, alterations, additions, and conversions of health and residential care facilities for:

Acute care hospitals  
 Adult residential rehabilitation centers  
 Alcoholism treatment facilities  
 Alcoholism hospitals  
 Ambulatory surgery centers  
 Boarding homes  
 Childbirth centers  
 Child day care centers  
 Comprehensive outpatient rehabilitation  
 Department of corrections facilities  
 Juvenile rehabilitation facilities  
 End stage renal disease centers  
 Eye banks  
 Ferry systems  
 Group care facilities for children  
 Home health care agencies  
 Home care agencies  
 Hospice agencies  
 Hospice care facilities  
 Occupational therapist-independent practice  
 Outpatient physical therapy/speech pathology  
 Physical therapist-independent practice

Private adult treatment homes  
 Psychiatric hospitals  
 Residential treatment facilities for psychiatrically impaired children & youth  
 Rural health care facilities  
 Rural health care clinics  
 Soldiers' home  
 State school for the blind  
 State school for the deaf  
 State hospitals for the mentally ill  
 Temporary worker housing  
 Transient accommodations  
 Veterans' home

(iii) Regulates the development of various new health care facilities and services based on community need, financial feasibility, cost containment, and quality of care;

(iv) Establishes and promotes a system of emergency medical and trauma services, which includes: Developing, evaluating, and monitoring training programs; licensing and inspection; and technical assistance for a comprehensive state-wide integrated emergency medical system; and

(v) Regulates clinical laboratory testing sites and practices.

(c) *The assistant secretary for community and family health* is responsible for assessing the health status of Washington state citizens regarding disease, injury, and nutrition; developing policy based on those assessments that will prevent disease, premature death and disability, and will promote health lifestyles and environments; and assuring access to quality services consistent with approved policy in the following areas:

(i) Comprehensive planning for health services for children and adolescents and their families and primary caretakers, including parenting education, nutrition consultation, oral health programs, teen pregnancy prevention and immunizations;

(ii) A continuum of services designed for infants or children with, or at risk for, special health care needs and their families;

(iii) High quality low cost, comprehensive family planning and reproductive health care services;

(iv) Health and support services for pregnant women, lactating and other post-partum women, and infants;

(v) Supplemental foods, nutrition education, and referral for health services for eligible pregnant women, lactating and other post-partum women, and infants and children at risk;

(vi) Programs to control the complications of diabetes and to identify and develop interventions for the prevention of death and disability from intentional and unintentional injury;

(vii) Public education and marketing campaigns on a spectrum of health related topics; programs which develop and supply health and safety educational materials to schools, local health, and community agencies;

(viii) Surveillance and services designed to reduce death and disease related to cancer, heart disease and stroke by providing public education/awareness programs, screening projects, professional education, and development of community coalitions;

(ix) Surveillance and services that interrupt the transmission of human immunodeficiency virus (HIV) and other

sexually transmitted diseases (STD), and reduce associated morbidity and mortality by planning, as well as supporting the individual rights and human dignity of those infected and those considered at risk; and

(x) Surveillance and services that reduce the morbidity and mortality due to tuberculosis and vaccine-preventable disease.

(d) *The assistant secretary for environmental health* provides training, public education services, and technical assistance to local health agencies and other agencies; and provides direct surveillance, monitoring, and enforcement activities to prevent, control, and abate health hazards and nuisances related to:

- (i) Contaminated shellfish;
- (ii) Contamination due to illegal drug manufacturing and storage;
- (iii) Disease-carrying insects and rodents;
- (iv) Disposal of solid and liquid wastes;
- (v) Food service sanitation;
- (vi) On-site sewage disposal;
- (vii) Public drinking water systems;
- (viii) Ionizing radiation;
- (ix) Schools, campgrounds, and parks;
- (x) Toxic substance exposure; and
- (xi) Water recreation facilities.

(e) *The assistant secretary for public health laboratories* oversees laboratories that aid in the diagnosis, treatment, and prevention of various diseases by:

- (i) Testing and analyzing clinical and environmental specimens and samples including food, food products, shellfish, drinking water, and seawater;
- (ii) Testing to detect certain treatable metabolic disorders in newborns;
- (iii) Testing for radioactivity in materials, mine tailings, and ores; and
- (iv) Performing inorganic and organic chemical analyses on drinking water, and other environmental samples such as soil, paint chips, ceramics and potteries, beverages, food, and others.

(f) *The assistant secretary for management services* provides administrative, financial, contracting, facility information processing, and human resource services to the department's operating programs.

(3)(a) Each assistant secretary is hereby delegated authority to administer the programs within their respective areas of responsibility, including, without limitation, the authority to sign documents on behalf of the secretary and the department. Each assistant secretary is authorized to further delegate his or her authority to such persons and in such manner as deemed necessary or appropriate in the management of the department's business.

(b) In the absence of the secretary, the following are authorized to act on behalf of the department:

- (i) The deputy secretary;
- (ii) In the absence of the deputy secretary, the state health officer;
- (iii) In the absence of the state health officer, the assistant secretary for management services;
- (iv) In the absence of all of the foregoing, any assistant secretary.

(c) Any person designated as "acting" in a position described in this section shall have the same authority while

so designated as if she or he had been appointed to fill the position on a permanent basis.

[Statutory Authority: RCW 43.70.040. 95-10-043, § 246-01-080, filed 5/1/95, effective 6/1/95. Statutory Authority: RCW 43.70.050. 93-08-004 (Order 346), § 246-01-080, filed 3/24/93, effective 4/24/93.]

**WAC 246-01-090 Consumer assistance.** (1) The department provides a consumer assistance state-wide toll-free hotline. Consumer assistance personnel assist the public with information, concerns, or complaints about the department and serve as advocates for consumers who are complainants or witnesses in a licensing or disciplinary proceeding. The health consumer assistance line is 1-800-525-0127; its mailing address is P.O. Box 47891, Olympia, WA 98504-7891.

(2) The public may send submissions or written requests for information concerning the course and method of the department's operation to: Rules Coordinator, Management Services, 1300 S.E. Quince Street, P.O. Box 47902, Olympia, WA 98504-7902.

[Statutory Authority: RCW 43.70.050. 93-08-004 (Order 346), § 246-01-090, filed 3/24/93, effective 4/24/93.]

**WAC 246-01-100 Current address.** (1) Each person having a license issued by the department, each applicant for such a license, each recipient of benefits administered by the department, and each applicant for such benefits shall provide a current mailing address at the time of making application or reapplication.

(2) It is the responsibility of any such person to advise the appropriate office of the department in writing of any change in the address provided to the department.

(3) All official correspondence between the department and persons covered in this section shall be addressed to the most recent address provided to the department in writing by such person.

(4) For the purpose of this section, the term "license" shall have the meaning set forth in WAC 246-10-102.

[Statutory Authority: RCW 43.70.050. 93-08-004 (Order 346), § 246-01-100, filed 3/24/93, effective 4/24/93.]

## Chapter 246-03 WAC

### STATE ENVIRONMENTAL POLICY ACT— GUIDELINES

#### WAC

246-03-001	Purpose.
246-03-010	Definitions.
246-03-020	Adoption by reference.
246-03-030	Timing and procedures for specified major actions.
246-03-040	Exemptions for emergency actions.
246-03-050	Determination of lead agency and responsible official.
246-03-060	Recommended timing for threshold determination.
246-03-070	Threshold determination process.
246-03-080	Adjudicative proceeding.
246-03-090	Scoping.
246-03-100	Issuance of draft EIS.
246-03-110	Policies and procedures for conditioning or denying permits or other approvals.
246-03-120	Public hearings.
246-03-130	Responsibilities of the department as a consulted agency.
246-03-140	SEPA committee.
246-03-150	SEPA public information.

246-03-160 Severability.

**WAC 246-03-001 Purpose.** This chapter implements the state-wide rules in chapter 197-11 WAC as they apply to the department of health. These rules are promulgated under RCW 43.21C.120 (the State Environmental Policy Act) and chapter 197-11 WAC (SEPA rules).

[Statutory Authority: RCW 43.70.040. 91-02-050 (Order 122), § 246-03-001, filed 12/27/90, effective 1/31/91.]

**WAC 246-03-010 Definitions.** In addition to the definitions contained in WAC 197-11-700 through 197-11-799, the following terms shall have the listed meanings:

Acting agency means an agency with jurisdiction which has received an application for a license, or which is proposing an action.

Agency guidelines shall mean chapter 246-03 WAC.

Department shall mean the department of health.

Environmental report shall mean a document prepared by the applicant, when required by the department, for use in the preparation of a draft EIS.

Licensing means the agency process in granting, renewing or modifying a license.

Private applicant means any person or entity, other than an agency as defined in this section, applying for a license from an agency.

Secretary shall mean the secretary of the department of health.

SEPA committee means the departmental committee which oversees the department's SEPA activities. The committee's composition and responsibilities are outlined in WAC 246-03-140.

SEPA guidelines shall mean chapter 197-11 WAC.

[Statutory Authority: RCW 43.70.040. 91-02-050 (Order 122), § 246-03-010, filed 12/27/90, effective 1/31/91.]

**WAC 246-03-020 Adoption by reference.** The department of health adopts the following sections or subsections of chapter 197-11 WAC by reference:

## WAC

197-11-010 Authority.  
 197-11-020 Purpose.  
 197-11-030 Policy.  
 197-11-040 Definitions.  
 197-11-050 Lead agency.  
 197-11-055 Timing of the SEPA process.  
 197-11-060 Content of environmental review.  
 197-11-070 Limitations on actions during SEPA process.  
 197-11-080 Incomplete or unavailable information.  
 197-11-090 Supporting documents.  
 197-11-100 Information required of applicants.  
 197-11-300 Purpose of this part.  
 197-11-305 Categorical exemptions.  
 197-11-310 Threshold determination required.  
 197-11-315 Environmental checklist.  
 197-11-330 Threshold determination process.  
 197-11-335 Additional information.  
 197-11-340 Determination of nonsignificance (DNS).  
 197-11-350 Mitigated DNS.

197-11-360 Determination of significance (DS)/initiation of scoping.  
 197-11-390 Effect of threshold determination.  
 197-11-400 Purpose of EIS.  
 197-11-402 General requirements.  
 197-11-405 EIS types.  
 197-11-406 EIS timing.  
 197-11-408 Scoping.  
 197-11-410 Expanded scoping. (Optional)  
 197-11-420 EIS preparation.  
 197-11-425 Style and size.  
 197-11-430 Format.  
 197-11-435 Cover letter or memo.  
 197-11-440 EIS contents.  
 197-11-442 Contents of EIS on nonproject proposals.  
 197-11-443 EIS contents when prior nonproject EIS.  
 197-11-444 Elements of the environment.  
 197-11-448 Relationship of EIS to other considerations.  
 197-11-450 Cost-benefit analysis.  
 197-11-455 Issuance of DEIS.  
 197-11-460 Issuance of FEIS.  
 197-11-500 Purpose of this part.  
 197-11-502 Inviting comment.  
 197-11-504 Availability and cost of environmental documents.  
 197-11-508 SEPA register.  
 197-11-510 Public notice.  
 197-11-535 Public hearings and meetings.  
 197-11-545 Effect of no comment.  
 197-11-550 Specificity of comments.  
 197-11-560 FEIS response to comments.  
 197-11-570 Consulted agency costs to assist lead agency.  
 197-11-600 When to use existing environmental documents.  
 197-11-610 Use of NEPA documents.  
 197-11-620 Supplemental environmental impact statement—Procedures.  
 197-11-625 Addenda—Procedures.  
 197-11-630 Adoption—Procedures.  
 197-11-635 Incorporation by reference—Procedures.  
 197-11-640 Combining documents.  
 197-11-650 Purpose of this part.  
 197-11-655 Implementation.  
 197-11-660 Substantive authority and mitigation.  
 197-11-680 Appeals.  
 197-11-700 Definitions.  
 197-11-702 Act.  
 197-11-704 Action.  
 197-11-706 Addendum.  
 197-11-708 Adoption.  
 197-11-710 Affected tribe.  
 197-11-712 Affecting.  
 197-11-714 Agency.  
 197-11-716 Applicant.  
 197-11-718 Built environment.  
 197-11-720 Categorical exemption.  
 197-11-722 Consolidated appeal.  
 197-11-724 Consulted agency.  
 197-11-726 Cost-benefit analysis.  
 197-11-728 County/city.  
 197-11-730 Decision maker.  
 197-11-732 Department.

197-11-734 Determination of nonsignificance (DNS).  
 197-11-736 Determination of significance (DS).  
 197-11-738 EIS.  
 197-11-740 Environment.  
 197-11-742 Environmental checklist.  
 197-11-744 Environmental document.  
 197-11-746 Environmental review.  
 197-11-748 Environmentally sensitive area.  
 197-11-750 Expanded scoping.  
 197-11-752 Impacts.  
 197-11-754 Incorporation by reference.  
 197-11-756 Lands covered by water.  
 197-11-758 Lead agency.  
 197-11-760 License.  
 197-11-762 Local agency.  
 197-11-764 Major action.  
 197-11-766 Mitigated DNS.  
 197-11-768 Mitigation.  
 197-11-770 Natural environment.  
 197-11-772 NEPA.  
 197-11-774 Nonproject.  
 197-11-776 Phased review.  
 197-11-778 Preparation.  
 197-11-780 Private project.  
 197-11-782 Probable.  
 197-11-784 Proposal.  
 197-11-786 Reasonable alternative.  
 197-11-788 Responsible official.  
 197-11-790 SEPA.  
 197-11-792 Scope.  
 197-11-793 Scoping.  
 197-11-794 Significant.  
 197-11-796 State agency.  
 197-11-797 Threshold determination.  
 197-11-799 Underlying governmental action.  
 197-11-800 Categorical exemptions.  
 197-11-810 Exemptions and nonexemptions applicable to specific state agencies.  
 197-11-820 Department of licensing.  
 197-11-845 Department of social and health services.  
 197-11-880 Emergencies.  
 197-11-890 Petitioning DOE to change exemptions.  
 197-11-900 Purpose of this part.  
 197-11-902 Agency SEPA policies.  
 197-11-904 Agency SEPA procedures.  
 197-11-906 Content and consistency of agency procedures.  
 197-11-908 Environmentally sensitive areas.  
 197-11-910 Designation of responsible official.  
 197-11-912 Procedures on consulted agencies.  
 197-11-914 SEPA fees and costs.  
 197-11-916 Application to ongoing actions.  
 197-11-917 Relationship to chapter 197-10 WAC.  
 197-11-918 Lack of agency procedures.  
 197-11-920 Agencies with environmental expertise.  
 197-11-922 Lead agency rules.  
 197-11-924 Determining the lead agency.  
 197-11-926 Lead agency for governmental proposals.  
 197-11-928 Lead agency for public and private proposals.  
 197-11-930 Lead agency for private projects with one agency with jurisdiction.

197-11-932 Lead agency for private projects requiring licenses from more than one agency, when one of the agencies is a county/city.  
 197-11-934 Lead agency for private projects requiring licenses from a local agency, not a county/city, and one or more state agencies.  
 197-11-936 Lead agency for private projects requiring licenses from more than one state agency.  
 197-11-938 Lead agencies for specific proposals.  
 197-11-940 Transfer of lead agency status to a state agency.  
 197-11-942 Agreements on lead agency status.  
 197-11-944 Agreements on division of lead agency duties.  
 197-11-946 DOE resolution of lead agency disputes.  
 197-11-948 Assumption of lead agency status.  
 197-11-950 Severability.  
 197-11-955 Effective date.  
 197-11-960 Environmental checklist.  
 197-11-965 Adoption notice.  
 197-11-970 Determination of nonsignificance (DNS).  
 197-11-980 Determination of significance and scoping notice (DS).  
 197-11-985 Notice of assumption of lead agency status.  
 197-11-990 Notice of action.

[Statutory Authority: RCW 43.70.040, 91-02-050 (Order 122), § 246-03-020, filed 12/27/90, effective 1/31/91.]

**WAC 246-03-030 Timing and procedures for specified major actions. (1) Regulations and licenses relating to radioactive material.**

(a) Scope of major action.

(i) Regulations relating to radioactive material shall include the adoption or amendment by the department of any regulations incorporating general standards for issuance of licenses authorizing the possession, use and transfer of radioactive material pursuant to RCW 70.98.080, and 70.121.030.

(ii) The issuance, revocation or suspension of individual licenses under RCW 70.98.080 shall be exempt. However, the following licenses shall not be exempt: Licenses to operate low level waste burial facilities or licenses to operate or expand beyond design capacity mineral processing facilities, or their tailings areas, whose products, or byproducts, have concentrations of naturally occurring radioactive materials in excess of exempt concentrations as specified in WAC 246-232-010.

(b) Timing of SEPA requirements for regulations for radioactive material.

(i) A final EIS or determination of nonsignificance, whichever is determined appropriate by the lead agency's responsible official, shall be completed for proposed regulations relating to radioactive material prior to the hearing preceding final adoption of such regulations.

(ii) The responsible official shall mail to the department of ecology headquarters office in Olympia for listing in the "SEPA register" (see WAC 197-11-508) a copy of any determination of nonsignificance, a copy of the draft EIS, and a copy of the final EIS. Copies of the draft EIS shall also be mailed to those agencies identified in WAC 197-11-455, and of the final EIS to those agencies identified in WAC 197-11-460. The responsible official shall also give



public notice in the form and manner specified in RCW 43.21C.080 of the determination of nonsignificance or final EIS.

(c) Timing of SEPA requirements for licenses for uranium or thorium mills or radioactive waste burial facilities.

(i) The applicant shall be responsible for completing an environmental checklist, furnishing additional information needed by the department to make the threshold determination, and preparing an environmental report regarding the environmental impact of proposed activities for independent evaluation by the department, prior to issuance of a draft EIS by the responsible official. The environmental report shall be submitted within ninety days following determination of significance. The following material presents a more detailed description of the responsibilities of the private applicant as well as of the responsible official.

(ii) The applicant shall be responsible for contacting the responsible official during the early stages of the applicants planning activities to obtain an outline of SEPA requirements.

(iii) Thereafter the private applicant shall be responsible for preparation of an environmental checklist. The responsible official shall review each environmental checklist and, within fifteen days of the responsible official's receipt of the checklist, shall prepare and issue either a determination of nonsignificance as per WAC 197-11-340 or a determination of significance as per WAC 197-11-360.

(iv) When the responsible official has issued a determination of nonsignificance, the official shall send the determination and environmental checklist to the applicant and to all agencies with jurisdiction for review and comment as per WAC 197-11-340.

(v) When the responsible official makes a determination of significance, the preparation of an environmental report shall be completed in a manner consistent with the requirements for a draft EIS and shall be the responsibility of the private applicant. If the applicant desires, he may contract with an outside consultant for the preparation of the environmental report. The department may also contract with an outside consultant for the preparation of a draft or final EIS. The department or the department's contracted consultant will independently evaluate the environmental report and be responsible for the reliability of any information used in the draft or final EIS. Unless the scope or complexity of the proposal indicates otherwise, the final EIS shall be issued as described in WAC 197-11-460(6).

(vi) The responsible official shall request review of the draft EIS from the agencies listed in WAC 197-11-455 and from such other agencies as he determines.

(vii) The responsible official shall mail a copy of the draft EIS to the department of ecology headquarters in Olympia for listing in the "SEPA register" (see WAC 197-11-508) and also to those agencies listed in WAC 197-11-455.

(viii) When the responsible official determines that substantial changes are needed or that new information has become available, the preparation of an amended or new environmental report is the responsibility of the private applicant.

(ix) The responsible official shall mail a copy of the final EIS to the department of ecology headquarters office in

Olympia for listing in the "SEPA register" (see WAC 197-11-508). The responsible official shall also mail copies of the final EIS to those agencies specified in WAC 197-11-460 and shall give public notice of the completion of the final EIS in the form and manner specified in RCW 43.21C.080.

**(2) Water system plans for public water systems as per WAC 246-290-100 and RCW 70.116.050.**

(a) Scope of major action. Water system plans are plans developed and submitted to the department for review and approval pursuant to WAC 246-290-100 and RCW 70.116.050.

(b) Timing and procedures for water system plans prepared by private applicants.

(i) In general, when a private applicant has prepared a water system plan for review and approval by the department, the private applicant shall be responsible for completing an environmental checklist, furnishing additional information needed by the department to make the threshold determination, and preparing the draft and final EIS under the direction of the responsible official. The following material presents a more detailed description of the responsibilities of the private applicant as well as the responsible official.

(ii) Follow steps outlined in subsection (1)(c)(ii) through (iv) of this section.

(iii) When the responsible official makes a determination of significance, the preparation of a draft and final EIS shall be in compliance with WAC 197-11-400 through 197-11-620 and shall be the responsibility of the private applicant. If the applicant desires, he may contract with an outside consultant for preparation of the draft or final EIS. Unless the scope or complexity of the proposal indicates otherwise, the final EIS shall be completed within sixty days of the end of the comment period for the draft EIS.

(iv) See subsection (1)(c)(vi) and (vii) of this section.

(v) When the responsible official determines that substantial changes are needed or that new information has become available, the preparation of an amended or a new draft EIS is the responsibility of the private applicant.

(vi) See subsection (1)(c)(ix) of this section.

(vii) Every water system plan submitted by a private applicant to the department for review and approval shall be accompanied by either a determination of nonsignificance or a final EIS.

(c) Timing and procedure for water system plans prepared by agencies. Every water system plan submitted by an agency to the department for review and approval shall be accompanied by either a determination of nonsignificance or a final EIS.

**(3) New public water supply systems and major extensions of existing public water supply systems.**

(a) Scope of major action. The approval of engineering reports or plans and specifications pursuant to chapter 246-290 WAC for all surface water source development, all water system storage facilities greater than one-half million gallons, new transmission lines longer than one thousand feet and larger than eight inches in diameter located in new rights of way and major extensions to existing water distribution systems involving use of pipes greater than eight inches in diameter, which are designed to increase the existing service area by more than one square mile.

(b) Timing and procedures for projects proposed by private applicants.

(i) In general, when a private applicant seeks the approval of the department for a new public water supply or a major extension to an existing public water supply, the private applicant shall be responsible for completing an environmental checklist, furnishing additional information needed by the department to make the threshold determination, and preparing the draft and final EIS under the direction of the responsible official. The following material presents a more detailed description of the responsibilities of the private applicant as well as of the responsible official.

(ii) Follow steps outlined in subsection (1)(c)(ii) through (iv) of this section.

(iii) See subsection (2)(b)(iii) of this section.

(iv) See subsection (1)(c)(vi) and (vii) of this section.

(v) See subsection (2)(b)(v) of this section.

(vi) See subsection (1)(c)(ix) of this section.

(vii) Whenever preliminary engineering reports, or plans and specifications for a new public water supply system or a major extension to an existing public water supply system are submitted by a private applicant to the secretary for review and approval pursuant to chapter 246-290 WAC, these reports, plans and specifications shall be accompanied by a determination of nonsignificance or a final EIS.

(c) Timing and procedures for projects proposed by an agency. Whenever preliminary engineering reports, plans and specifications for a new public water supply system or a major extension to an existing public water supply system are submitted by an agency to the secretary for review and approval pursuant to chapter 246-290 WAC, these reports, plans and specifications shall be accompanied by a determination of nonsignificance or a final EIS.

**(4) Certificates of need.**

(a) Scope of major action. Certificate of need applications are subject to SEPA requirements whenever the applicant proposes to construct a new hospital or to construct major additions to the existing service capacity of such an institution: *Provided*, That such applications are not subject to SEPA requirements when the proposed construction consists of additions which provide less than twelve thousand square feet of floor area and with associated parking facilities designed for forty automobiles or less: *Provided further*, That certificate of need applications for "substantial acquisitions" are not subject to SEPA requirements.

(b) Timing and procedures for hospital certificates of need. Where a state or local agency other than the department is lead agency for hospital construction, the department shall not issue a certificate of need approving this hospital construction until the applicant has supplied it with a determination of nonsignificance or a final EIS, and until seven days after the issuance by the lead agency of any final EIS. Nothing in this subsection shall preclude the department from making a commitment to issue a certificate of need to an applicant subject to the timely receipt of an appropriate environmental impact statement or determination of nonsignificance.

**(5) Approval of sewerage general plans and/or water general plans described in RCW 36.94.010.**

(a) Scope of major action. Sewerage general plans and water general plans shall mean and include those described in RCW 36.94.010.

(b) Timing and procedures for water general plans. Every water general plan submitted by a county to the department for review and approval shall be accompanied by either a determination of nonsignificance or a final EIS.

**(6) Plans and specifications for new sewage treatment works or for major extensions to existing sewage treatment works pursuant to chapter 246-271 WAC.**

Scope of major action. Plans and specifications for new sewage treatment works or for major extensions to existing sewage treatment works are those which are reviewed and approved by the department pursuant to WAC 246-271-050.

**(7) Construction of any building, facility or other installation for the purpose of housing department personnel or for prisons or for fulfilling other statutorily directed or authorized functions.**

(a) Scope of major action. The construction of buildings, facilities or other installations for the purpose of housing department personnel or for other authorized functions shall be subject to SEPA requirements, but such construction shall not be subject to SEPA requirements when it consists of additions which provide less than twelve thousand square feet of floor area and with associated parking facilities designed for forty automobiles or less.

(b) Timing and procedures.

(i) The responsible official shall, prior to the request for construction bids, prepare an environmental checklist for each construction project of the type described in (a) of this subsection.

(ii) Within fifteen days of the request for construction bids, the responsible official shall make (A) a written declaration of nonsignificance where the responsible official determines that the proposed construction will not have a significant adverse environmental impact or (B) a written declaration of significance where the responsible official determines that the proposed construction will have a significant adverse environmental impact.

(iii) Where the responsible official has made a determination of significance, the preparation of the draft and final EIS shall be in compliance with WAC 197-11-400 through 197-11-620, and shall be the responsibility of the responsible official. Unless the scope or complexity of the proposal indicates otherwise, the final EIS shall be completed within sixty days of the end of the comment period for the draft EIS.

(iv) See subsection (1)(c)(vi) of this section.

(v) The responsible official shall mail to the department of ecology headquarters office in Olympia for listing in the "SEPA register" a copy of any determination of nonsignificance, a copy of the draft EIS, and a copy of the final EIS. Copies of the draft EIS shall also be mailed to those agencies identified in WAC 197-11-455, and of the final EIS to those agencies identified in WAC 197-11-460. The responsible official shall also give public notice in the form and manner specified in RCW 43.21C.080 of the determination of nonsignificance or final EIS.

**(8) Approval of final plans for construction of a private psychiatric hospital pursuant to WAC 246-322-020, or construction of an alcoholism treatment facility pursuant to WAC 246-326-020.**

(a) Scope of major action. The approval of final plans for construction of a private psychiatric hospital pursuant to WAC 246-322-020, or construction of an alcoholism

treatment center pursuant to WAC 246-326-020 shall be subject to SEPA requirements: *Provided*, That such construction shall not be subject to SEPA requirements when it consists of additions which provide less than twelve thousand square feet of floor area and with associated parking facilities designed for forty automobiles or less.

(b) Timing and procedures for construction of the type described. Where a state or local agency other than the department is lead agency for construction of the type described in (a) of this subsection, the department shall not approve final plans for construction of a private psychiatric hospital or alcoholism treatment center until the applicant for such approval has supplied the department with a final declaration of nonsignificance or a final EIS for the construction in question, and until seven days after the issuance by the lead agency of any final EIS.

[Statutory Authority: RCW 43.21C.120. 92-02-018 (Order 224), § 246-03-030, filed 12/23/91, effective 1/23/92. Statutory Authority: RCW 43.70.040. 91-02-050 (Order 122), § 246-03-030, filed 12/27/90, effective 1/31/91.]

**WAC 246-03-040 Exemptions for emergency actions.** If the secretary makes a written declaration that actions must be undertaken immediately or within a time too short to allow full compliance with SEPA requirements; and that such actions are necessary to avoid an imminent threat to public health or safety, or to prevent an imminent danger to public or private property, or to prevent an imminent threat of serious environmental degradation; then such actions may be undertaken without complying with SEPA requirements: *Provided*, That the department is the lead agency for such actions.

[Statutory Authority: RCW 43.70.040. 91-02-050 (Order 122), § 246-03-040, filed 12/27/90, effective 1/31/91.]

**WAC 246-03-050 Determination of lead agency and responsible official.** (1) The department shall be the lead agency for the following actions:

(a) Adoption or amendment of regulations relating to radioactive source materials; proposals to construct, operate, or expand any uranium or thorium mill, or any tailings areas generated by uranium or thorium milling, or any low level radioactive waste burial facilities. The responsible official would be the division director, division of radiation protection, environmental health programs. Lead agency determination for other mineral processing proposals should be made in accordance with WAC 197-11-924 through 197-11-948;

(b) Approval of comprehensive plans for public water supply systems when such plans are developed by private applicants and unless indicated otherwise by WAC 197-11-932, 197-11-934 and 197-11-936, and approval of new public water supply systems or major extensions of existing public water supply systems when such systems are being proposed by a private applicant unless indicated otherwise by WAC 197-11-932, 197-11-934, and 197-11-936. The responsible official would be the section head, water supply and waste section, division of environmental health;

(c) Construction of any building, facility, or other installation for the purpose of housing department personnel or for fulfilling other statutorily directed or authorized

functions. The responsible official would be a capital programs representative from the management services division, comptroller's office;

(2) Determination of the lead agency for department major actions not listed above shall be made in accordance with the procedures and requirements of WAC 246-03-140 (4)(c) and 197-11-922 through 197-11-948.

[Statutory Authority: RCW 43.21C.120. 92-02-018 (Order 224), § 246-03-050, filed 12/23/91, effective 1/23/92. Statutory Authority: RCW 43.70.040. 91-02-050 (Order 122), § 246-03-050, filed 12/27/90, effective 1/31/91.]

**WAC 246-03-060 Recommended timing for threshold determination.** In most cases the time required to complete a threshold determination should not exceed fifteen days. (WAC 197-11-310.)

[Statutory Authority: RCW 43.70.040. 91-02-050 (Order 122), § 246-03-060, filed 12/27/90, effective 1/31/91.]

**WAC 246-03-070 Threshold determination process.** In making a threshold determination, the responsible official shall follow the process outlined in WAC 197-11-330 through 197-11-390.

[Statutory Authority: RCW 43.70.040. 91-02-050 (Order 122), § 246-03-070, filed 12/27/90, effective 1/31/91.]

**WAC 246-03-080 Adjudicative proceeding.** Any person has the right to an adjudicative proceeding to contest the department's final threshold determination that an EIS is or is not necessary and/or the sufficiency of the final EIS. The proceeding is governed by the Administrative Procedure Act (chapter 34.05 RCW), the rules in this chapter, and by chapter 246-08 WAC. If any provision in this chapter conflicts with chapter 246-08 WAC, the provision in this chapter governs.

(1) A person contesting a department's decision shall within twenty-eight days of the department's official notice of issuance of a final threshold determination or final EIS:

(a) File a written application for an adjudicative proceeding by a method showing proof of receipt by the department of health; and

(b) Include in or with the application:

(i) A specific statement of the issue or issues and law involved; and

(ii) The grounds for contesting the department decision.

(2) The initial order should be made within sixty days of the department's receipt of the application. When a party files a petition for administrative review, the review order should be made within sixty days of the department's receipt of the petition. The time to enter an order is extended by as many days as the proceeding is continued on motion by any party.

(3)(a) If the adjudicative order is that an EIS should be filed, the presiding officer or reviewing officer shall remand the matter to the department of health to file an EIS.

(b) If the adjudicative order is that the final EIS is not sufficient, the presiding officer or reviewing officer shall remand the matter to the department of health to correct the insufficiency.

[Statutory Authority: RCW 43.70.040. 91-02-050 (Order 122), § 246-03-080, filed 12/27/90, effective 1/31/91.]

**WAC 246-03-090 Scoping.** When the department receives a scoping notice from a lead agency, the department shall submit any comments to the lead agency within twenty-one days from the date of issuance of the determination of significance. When the department is lead agency the steps in WAC 197-11-408 and 197-11-410 shall be followed.

[Statutory Authority: RCW 43.70.040. 91-02-050 (Order 122), § 246-03-090, filed 12/27/90, effective 1/31/91.]

**WAC 246-03-100 Issuance of draft EIS.** When the department is lead agency, it shall issue the draft EIS in accordance with WAC 197-11-455.

[Statutory Authority: RCW 43.70.040. 91-02-050 (Order 122), § 246-03-100, filed 12/27/90, effective 1/31/91.]

**WAC 246-03-110 Policies and procedures for conditioning or denying permits or other approvals.** (1) The policies and goals in this section are supplementary to existing authorities of the department.

(2) It is the policy of the department to avoid or mitigate adverse environmental impacts which may result from the department's decisions.

(3) The department shall use all practical means, consistent with other essential considerations of state policy, to improve and coordinate plans, functions, programs, and resources to the end that the state and its citizens may:

(a) Fulfill the responsibilities of each generation as trustee of the environment for succeeding generations;

(b) Assure for all people of Washington safe, healthful, productive, and aesthetically and culturally pleasing surroundings;

(c) Attain the widest range of beneficial uses of the environment without degradation, risk to health or safety, or other undesirable and unintended consequences;

(d) Preserve important historic, cultural, and natural aspects of our national heritage;

(e) Maintain, wherever possible, an environment which supports diversity and variety of individual choice;

(f) Achieve a balance between population and resource use which will permit high standards of living and a wide sharing of life's amenities; and

(g) Enhance the quality of renewable resources and approach the maximum attainable recycling of depletable resources.

(4) The department recognizes that each person has a fundamental and inalienable right to a healthful environment and that each person has a responsibility to contribute to the preservation and enhancement of the environment.

(5) The department shall ensure that presently unquantified environmental amenities and values will be given appropriate consideration in decision-making along with economic and technical considerations.

(6)(a) When the environmental document for a proposal shows it will cause significant adverse impacts, the responsible official shall consider whether:

(i) The environmental document identified mitigation measures that are reasonable and capable of being accomplished;

(ii) Other local, state, or federal requirements and enforcement would mitigate the significant adverse environmental impacts; and

(iii) Reasonable mitigation measures are sufficient to mitigate the significant adverse impacts.

(b) The responsible official may:

(i) Condition the approval for a proposal if mitigation measures are reasonable and capable of being accomplished and the proposal is inconsistent with the policies in this section; or

(ii) Deny the permit or approval for a proposal if reasonable mitigation measures are insufficient to mitigate significant adverse environmental impacts and the proposal is inconsistent with the policies in this section.

(c) The procedures in WAC 197-11-660 shall also be followed when conditioning or denying permits or other approvals.

[Statutory Authority: RCW 43.70.040. 91-02-050 (Order 122), § 246-03-110, filed 12/27/90, effective 1/31/91.]

**WAC 246-03-120 Public hearings.** A public hearing on the environmental impact of a proposal shall be held as specified in WAC 197-11-535.

[Statutory Authority: RCW 43.70.040. 91-02-050 (Order 122), § 246-03-120, filed 12/27/90, effective 1/31/91.]

**WAC 246-03-130 Responsibilities of the department as a consulted agency.** Other lead agencies may request the department for consultation during the SEPA process. The department shall then provide consultation in accordance with the requirements of WAC 197-11-502, 197-11-545 and 197-11-570.

[Statutory Authority: RCW 43.70.040. 91-02-050 (Order 122), § 246-03-130, filed 12/27/90, effective 1/31/91.]

**WAC 246-03-140 SEPA committee.** (1) There is hereby created a SEPA committee to oversee the department's SEPA activities.

(2) The SEPA committee shall be composed of:

(a) One representative from the division of drinking water, environmental health programs;

(b) One representative from the facility licensing and certification section;

(c) One capital programs representative from the comptroller's office, management services division; and

(d) One representative from the division of radiation protection, environmental health programs.

(3) A representative from the office of the attorney general will provide legal support to the committee.

(4) The SEPA committee shall:

(a) Oversee the department's SEPA activities to ensure compliance with these agency guidelines, the state SEPA guidelines, and the policies and goals set forth in the State Environmental Policy Act;

(b) Oversee the future revision of these agency guidelines so as to reflect:

(i) Future amendment of SEPA or the state SEPA guidelines;

(ii) The creation of new department programs.

(c) Designate the responsible official for any major action for which the department is lead agency when such designation has not occurred elsewhere in these agency guidelines.

[Statutory Authority: RCW 43.21C.120. 92-02-018 (Order 224), § 246-03-140, filed 12/23/91, effective 1/23/92. Statutory Authority: RCW 43.70.040. 91-02-050 (Order 122), § 246-03-140, filed 12/27/90, effective 1/31/91.]

**WAC 246-03-150 SEPA public information.** (1) When the department is lead agency, the responsible official shall retain SEPA documents required by this chapter and shall make them available to the public in accordance with chapter 42.17 RCW.

(2) When the department is lead agency, the responsible official shall transmit copies of the following documents to the department of ecology headquarters office in Olympia:

(a) All draft and final EISs. (See WAC 197-11-455 and 197-11-460.)

(b) All determinations of nonsignificance (see WAC 197-11-340).

[Statutory Authority: RCW 43.70.040. 91-02-050 (Order 122), § 246-03-150, filed 12/27/90, effective 1/31/91.]

**WAC 246-03-160 Severability.** If any provision of this chapter or its application to any person or circumstances is held invalid, the remainder of this chapter, or the application of the provision to other persons or circumstances, shall not be affected.

[Statutory Authority: RCW 43.70.040. 91-02-050 (Order 122), § 246-03-160, filed 12/27/90, effective 1/31/91.]

## Chapter 246-05 WAC

### LOCAL PUBLIC HEALTH—GUIDELINES

#### WAC

246-05-001	Purpose.
246-05-010	Definitions.
246-05-020	Appendix—County, city, or town in a public health district, department, or county-city department.
246-05-030	Assurance of nonsupplanting.

**WAC 246-05-001 Purpose.** The purpose of this chapter is to ensure that the appropriations to local health departments, described in section 225(9), chapter 24, Laws of 1993 1st ex. sess., will not be used to replace current local support for public health programs.

[Statutory Authority: RCW 43.70.020. 93-19-061, § 246-05-001, filed 9/13/93, effective 10/14/93.]

**WAC 246-05-010 Definitions.** "Department" means the department of health.

"Secretary" means the secretary of health, or the secretary's designee.

"Local health department" means the city, town, county or district which provides public health services to persons within the area.

[Statutory Authority: RCW 43.70.020. 93-19-061, § 246-05-010, filed 9/13/93, effective 10/14/93.]

### WAC 246-05-020 Appendix—County, city, or town in a public health district, department, or county-city department.

#### APPENDIX

#### Guidelines<sup>1</sup>

for Negotiating Support by a

County, City, or Town in

Maintaining and Operating the Local Public Health Agency

(District, Department, or County-City Department)

A. Every county, city, and town should furnish the support necessary to provide the following basic public health services<sup>2,3</sup>:

1. Personal health protection services

Epidemiologic services

Tuberculosis

Sexually transmitted diseases

Other communicable diseases

Immunizations

Family planning

Child health services

Crippled children's services

Maternal and infant services

Nutrition and/or WIC services

Chronic disease prevention, detection, hazard control

2. Environmental health protection services

Food

Water

Solid waste disposal

Liquid waste disposal

Living environment

Chemical and physical hazards

Vector control

3. Laboratory services necessary to support any of the programs listed in A 1 and 2 of this appendix (provide or purchase)

4. Vital records, birth, and death registration

5. Health promotion, information, and education

B. In addition, counties, cities, and towns at their option may choose to support additional public health protection and promotion actions or services. These may include, but not be limited to:

Dental health

School health services

Jail health services

Mental health services

Alcoholism services

Developmental disabilities

Health screening programs for the aging  
(Senior Citizens Services Act)

Home health services

Primary care for special population groups

Emergency health services

Community health planning

Any program area identified by local or state health officials when the health of the general population is shown to be at risk of adverse health effects.

C. Potential sources of funds:

1. Fees for permits and licenses
2. Charges for services
3. Contracts with counties, cities, schools, and other agencies
4. State and federal funds
5. Sales of property
6. Miscellaneous gifts and sales, e.g., sale of publications
7. County funds for special services not needed or desired by all participating counties and cities
8. City funds for special services
9. Reserve funds for special purposes
10. County general fund base support

D. Determination of equitable share for each municipality (county or city) of its fiscal support of basic health services:

1. The level of the basic health services budget and the respective county and city general fund contributions necessary to balance that budget should be determined through a negotiation process. The negotiators may wish to use some form of formula in this determination. Negotiating the formula is a basic part of the negotiation process. A number of formulas may be considered. Most formulas involve one or more of the following factors: Population (per capita), assessed valuation, use, need, or proportion of budget. No single formula is mandated state-wide, but a formula, once adopted by a local health board, should apply to all member jurisdictions. Agreements need not be limited to a single year. Multiyear contracts may be negotiated with the agreement adopting a basic formula but providing for annual adjustments of variable factors such as valuation or population.

2. The following formulas are presented as guidelines. Options 1 through 3 provide for a county base support while options 4 and 5 have no county base built into the formula. The county base is a variable replacing previous statutory millages for public health and tuberculosis. The base may vary. In multicounty health districts, the county *base* public health support is to be determined annually by the district health board in consultation with the respective boards of county commissioners and divided among the member counties in proportion to each county's assessed valuation. An acceptable alternative method is to vary the *base* among the county members of the health district as the board of health, in consultation with the respective boards of county commissioners, shall determine.

Option 1:

$$C = 1/2 B \frac{A_c}{A_t} + 1/2 B \frac{P_c}{P_t}$$

Where:

- C = Contribution of city or county needed to balance the budget (basic plus optional dollars)
- B = Dollars needed to balance the basic plus optional dollar portion of the local public health agency annual budget
- A<sub>c</sub> = The assessed valuation of the component governmental unit, i.e., the city, town, or unincorporated area of the county
- A<sub>t</sub> = The total assessed valuation of the governmental jurisdictions encompassed by the local public health agency
- P<sub>c</sub> = Population of the component governmental unit, i.e., the city, town, or unincorporated area of the county
- P<sub>t</sub> = Total population of the governmental jurisdictions encompassed by the health district

Variation 1:

Derive the proportion of assessed valuation and population in the formula from the average of several years instead of the current year only.

Option 2:

$$C = B \frac{A_c}{A_t}$$

Where:

- C = Contribution of city or county needed to balance the budget (basic plus optional dollars)
- B = Dollars needed to balance the basic plus optional portion of the local public health agency annual budget
- A<sub>c</sub> = The assessed valuation of the component governmental unit, i.e., the city, town, or unincorporated area of the county
- A<sub>t</sub> = The total assessed valuation of the governmental jurisdictions encompassed by the local public health agency

Option 3:

$$C = B \frac{P_c}{P_t}$$

Where:

- C = Contribution of city or county needed to balance the budget (basic plus optional dollars)
- B = Dollars needed to balance the basic plus optional portion of the local public health agency annual budget



$P_c$  = Population of the component governmental unit, i.e., the city, town, or unincorporated area of the county

$P_t$  = Total population of the governmental jurisdictions encompassed by the local public health agency

Variation 1:

The per capita share is graduated by grouping or classes of cities so that small cities pay less than large cities.

Variation 2:

The county *base* remains the same but the per capita share is applied only to the cities.

Option 4:

- (1) Charge each city or county the full estimated cost of environmental health services
- (2) Charge each county the full cost of tuberculosis services
- (3) Charge each city and county the remainder of tax necessary on a per capita basis
- (4) Reduce each city's charge by giving credit to them for the county property taxes paid by the property owners of each city
- (5) Small cities may be charged a reduced share per capita

Option 5:

Half of the necessary funds are divided among the cities and counties in proportion to a statistical report of the services provided to each. The other half are provided on the basis of population or another of the options identified.

<sup>1</sup>Pertains also to a county, city, or town which has withdrawn from a health district to operate its own health department or decides to contract with another municipality for such health services.

<sup>2</sup>Basic services are those services required by state law and regulations or provided under service contracts with the department of social and health services.

<sup>3</sup>A list of all applicable laws, administrative regulations, and available current service contracts will be provided by the state board of health upon request.

[Statutory Authority: RCW 43.20.050. 91-02-051 (Order 124B), recodified as § 246-05-020, filed 12/27/90, effective 1/31/91. Statutory Authority: RCW 70.46.080 and 43.20.050. 83-19-057 (Order 268), § 248-990-990, filed 9/20/83; 83-04-011 (Order 253), § 248-990-990, filed 1/24/83; Order 104, Appendix—Guidelines (codified as WAC 248-990-990), filed 9/25/74; Appendix, filed 8/4/67.]

**WAC 246-05-030 Assurance of nonsupplanting.**

Funds shall not be allocated by the secretary unless the authorized agent of the local health department provides assurance of compliance to the secretary that, "State funds received pursuant to section 225(9), chapter 24, Laws of 1993, shall be used solely to expand and complement, but not supplant, local support for public health programs."

[Statutory Authority: RCW 43.70.020. 93-19-061, § 246-05-030, filed 9/13/93, effective 10/14/93.]

**Chapter 246-08 WAC  
PRACTICE AND PROCEDURE**

**WAC**

**ADJUDICATIVE PROCEEDINGS**

- 246-08-101 Declaratory orders—Forms, content, and filing.  
246-08-102 Declaratory orders—Procedural rights of persons in relation to petition.  
246-08-103 Declaratory orders—Disposition of petition.  
246-08-106 Updating mailing lists.

**ADMINISTRATIVE PROCEDURES**

- 246-08-390 Acquisition, retention and security of health care information.

**POLICIES**

- 246-08-400 Searching and duplicating medical records.  
246-08-420 Public records—Access and exemptions.  
246-08-440 Protection of public records.  
246-08-450 Final orders, declaratory orders, interpretive statements and policy statements—Indexes.  
246-08-520 Equal opportunity/affirmative action.  
246-08-560 Fees—Payment—Refunds.

**DISPOSITION OF SECTIONS FORMERLY  
CODIFIED IN THIS CHAPTER**

- 246-08-001 Application of chapter 246-08 WAC. [Statutory Authority: RCW 34.05.220. 92-02-018 (Order 224), § 246-08-001, filed 12/23/91, effective 1/23/92. Statutory Authority: RCW 43.70.040. 91-02-049 (Order 121), recodified as § 246-08-001, filed 12/27/90, effective 1/31/91. Statutory Authority: RCW 34.05.220. 90-06-018 (Order 038), § 248-08-410, filed 2/28/90, effective 3/1/90; Regulation 08.410, effective 3/11/60.] Repealed by 93-13-005 (Order 369), filed 6/3/93, effective 7/4/93. Statutory Authority: RCW 43.70.040.
- 246-08-020 Application for an adjudicative proceeding. [Statutory Authority: RCW 34.05.220. 92-02-018 (Order 224), § 246-08-020, filed 12/23/91, effective 1/23/92. Statutory Authority: RCW 43.70.040. 91-02-049 (Order 121), recodified as § 246-08-020, filed 12/27/90, effective 1/31/91. Statutory Authority: RCW 34.05.220. 90-06-018 (Order 038), § 248-08-413, filed 2/28/90, effective 3/1/90.] Repealed by 93-13-005 (Order 369), filed 6/3/93, effective 7/4/93. Statutory Authority: RCW 43.70.040.
- 246-08-030 Administrative law judge—Authority—Application of law—Assignment—Disqualification. [Statutory Authority: RCW 34.05.220. 92-02-018 (Order 224), § 246-08-030, filed 12/23/91, effective 1/23/92. Statutory Authority: RCW 43.70.040. 91-02-049 (Order 121), recodified as § 246-08-030, filed 12/27/90, effective 1/31/91. Statutory Authority: RCW 34.05.220. 90-06-018 (Order 038), § 248-08-425, filed 2/28/90, effective 3/1/90.] Repealed by 93-13-005 (Order 369), filed 6/3/93, effective 7/4/93. Statutory Authority: RCW 43.70.040.
- 246-08-040 Representation. [Statutory Authority: RCW 43.70.040. 91-02-049 (Order 121), recodified as § 246-08-040, filed 12/27/90, effective 1/31/91. Statutory Authority: RCW 34.05.220. 90-06-018 (Order 038), § 248-08-428, filed 2/28/90, effective 3/1/90.] Repealed by 93-13-005 (Order 369), filed 6/3/93, effective 7/4/93. Statutory Authority: RCW 43.70.040.
- 246-08-050 Prehearing conference. [Statutory Authority: RCW 43.70.040. 91-02-049 (Order 121), recodified as § 246-08-050, filed 12/27/90, effective 1/31/91. Statutory Authority: RCW 34.05.220. 90-06-018 (Order 038), § 248-08-431, filed 2/28/90, effective 3/1/90.] Repealed by 93-13-005 (Order 369), filed 6/3/93, effective 7/4/93. Statutory Authority: RCW 43.70.040.
- 246-08-060 Notice of hearing. [Statutory Authority: RCW 43.70.040. 91-02-049 (Order 121), recodified as § 246-08-060, filed 12/27/90, effective 1/31/91. Statutory Authority: RCW 34.05.220. 90-06-018 (Order 038), § 248-08-434, filed

- 2/28/90, effective 3/1/90.] Repealed by 93-13-005 (Order 369), filed 6/3/93, effective 7/4/93. Statutory Authority: RCW 43.70.040.
- 246-08-070 Filing and service of papers. [Statutory Authority: RCW 34.05.220. 92-02-018 (Order 224), § 246-08-070, filed 12/23/91, effective 1/23/92. Statutory Authority: RCW 43.70.040. 91-02-049 (Order 121), recodified as § 246-08-070, filed 12/27/90, effective 1/31/91. Statutory Authority: RCW 34.05.220. 90-06-018 (Order 038), § 248-08-437, filed 2/28/90, effective 3/1/90.] Repealed by 93-13-005 (Order 369), filed 6/3/93, effective 7/4/93. Statutory Authority: RCW 43.70.040.
- 246-08-080 Vacating an order of dismissal for reason of default or withdrawal. [Statutory Authority: RCW 34.05.220. 92-02-018 (Order 224), § 246-08-080, filed 12/23/91, effective 1/23/92. Statutory Authority: RCW 43.70.040. 91-02-049 (Order 121), recodified as § 246-08-080, filed 12/27/90, effective 1/31/91. Statutory Authority: RCW 34.05.220. 90-06-018 (Order 038), § 248-08-440, filed 2/28/90, effective 3/1/90; Regulation 08.440, effective 3/11/60.] Repealed by 93-13-005 (Order 369), filed 6/3/93, effective 7/4/93. Statutory Authority: RCW 43.70.040.
- 246-08-090 Subpoenas. [Statutory Authority: RCW 43.70.040. 91-02-049 (Order 121), recodified as § 246-08-090, filed 12/27/90, effective 1/31/91. Statutory Authority: RCW 34.05.220. 90-06-018 (Order 038), § 248-08-446, filed 2/28/90, effective 3/1/90.] Repealed by 93-13-005 (Order 369), filed 6/3/93, effective 7/4/93. Statutory Authority: RCW 43.70.040.
- 246-08-100 Teleconference hearing. [Statutory Authority: RCW 34.05.220. 92-02-018 (Order 224), § 246-08-100, filed 12/23/91, effective 1/23/92. Statutory Authority: RCW 43.70.040. 91-02-049 (Order 121), recodified as § 246-08-100, filed 12/27/90, effective 1/31/91. Statutory Authority: RCW 34.05.220. 90-06-018 (Order 038), § 248-08-449, filed 2/28/90, effective 3/1/90.] Repealed by 93-13-005 (Order 369), filed 6/3/93, effective 7/4/93. Statutory Authority: RCW 43.70.040.
- 246-08-104 Petition for rule making—Form, content, and filing. [Statutory Authority: RCW 43.70.040. 93-13-005 (Order 369), § 246-08-104, filed 6/3/93, effective 7/4/93.] Repealed by 96-19-041, filed 9/12/96, effective 10/13/96. Statutory Authority: RCW 43.70.040.
- 246-08-105 Petition for rule making—Consideration and disposition. [Statutory Authority: RCW 43.70.040. 93-13-005 (Order 369), § 246-08-105, filed 6/3/93, effective 7/4/93.] Repealed by 96-19-041, filed 9/12/96, effective 10/13/96. Statutory Authority: RCW 43.70.040.
- 246-08-110 Rules of evidence. [Statutory Authority: RCW 43.70.040. 91-02-049 (Order 121), recodified as § 246-08-110, filed 12/27/90, effective 1/31/91. Statutory Authority: RCW 34.05.220. 90-06-018 (Order 038), § 248-08-452, filed 2/28/90, effective 3/1/90.] Repealed by 93-13-005 (Order 369), filed 6/3/93, effective 7/4/93. Statutory Authority: RCW 43.70.040.
- 246-08-120 Contents of orders. [Statutory Authority: RCW 43.70.040. 91-02-049 (Order 121), recodified as § 246-08-120, filed 12/27/90, effective 1/31/91. Statutory Authority: RCW 34.05.220. 90-06-018 (Order 038), § 248-08-461, filed 2/28/90, effective 3/1/90.] Repealed by 93-13-005 (Order 369), filed 6/3/93, effective 7/4/93. Statutory Authority: RCW 43.70.040.
- 246-08-130 Petition for review—Response to petition—Disqualification of review judge. [Statutory Authority: RCW 34.05.220. 92-02-018 (Order 224), § 246-08-130, filed 12/23/91, effective 1/23/92. Statutory Authority: RCW 43.70.040. 91-02-049 (Order 121), recodified as § 246-08-130, filed 12/27/90, effective 1/31/91. Statutory Authority: RCW 34.05.220. 90-06-018 (Order 038), § 248-08-464, filed 2/28/90, effective 3/1/90.] Repealed by 93-13-005 (Order 369), filed 6/3/93, effective 7/4/93. Statutory Authority: RCW 43.70.040.
- 246-08-140 Reconsideration. [Statutory Authority: RCW 34.05.220. 92-02-018 (Order 224), § 246-08-140, filed 12/23/91, effective 1/23/92. Statutory Authority: RCW 43.70.040. 91-02-049 (Order 121), recodified as § 246-08-140, filed 12/27/90, effective 1/31/91. Statutory Authority: RCW 34.05.220. 90-06-018 (Order 038), § 248-08-470, effective 2/28/90, effective 3/1/90; Regulation 08.470, effective 3/11/60.] Repealed by 93-13-005 (Order 369), filed 6/3/93, effective 7/4/93. Statutory Authority: RCW 43.70.040.
- 246-08-150 Adjudicative proceedings—Notice to limited-English-speaking parties. [Statutory Authority: RCW 43.70.040. 91-02-049 (Order 121), recodified as § 246-08-150, filed 12/27/90, effective 1/31/91. Statutory Authority: RCW 34.05.220. 90-06-018 (Order 038), § 248-08-515, filed 2/28/90, effective 3/1/90.] Repealed by 93-13-005 (Order 369), filed 6/3/93, effective 7/4/93. Statutory Authority: RCW 43.70.040.
- 246-08-160 Interpreters. [Statutory Authority: RCW 43.70.040. 91-02-049 (Order 121), recodified as § 246-08-160, filed 12/27/90, effective 1/31/91. Statutory Authority: RCW 34.05.220. 90-06-018 (Order 038), § 248-08-525, filed 2/28/90, effective 3/1/90.] Repealed by 93-13-005 (Order 369), filed 6/3/93, effective 7/4/93. Statutory Authority: RCW 43.70.040.
- 246-08-170 Group hearing. [Statutory Authority: RCW 43.70.040. 91-02-049 (Order 121), recodified as § 246-08-170, filed 12/27/90, effective 1/31/91. Statutory Authority: RCW 34.05.220. 90-06-018 (Order 038), § 248-08-535, filed 2/28/90, effective 3/1/90.] Repealed by 93-13-005 (Order 369), filed 6/3/93, effective 7/4/93. Statutory Authority: RCW 43.70.040.
- 246-08-180 Continuance. [Statutory Authority: RCW 43.70.040. 91-02-049 (Order 121), recodified as § 246-08-180, filed 12/27/90, effective 1/31/91. Statutory Authority: RCW 34.05.220. 90-06-018 (Order 038), § 248-08-545, filed 2/28/90, effective 3/1/90.] Repealed by 93-13-005 (Order 369), filed 6/3/93, effective 7/4/93. Statutory Authority: RCW 43.70.040.
- 246-08-190 Computation of time. [Statutory Authority: RCW 43.70.040. 91-02-049 (Order 121), recodified as § 246-08-190, filed 12/27/90, effective 1/31/91. Statutory Authority: RCW 34.05.220. 90-06-018 (Order 038), § 248-08-565, filed 2/28/90, effective 3/1/90.] Repealed by 93-13-005 (Order 369), filed 6/3/93, effective 7/4/93. Statutory Authority: RCW 43.70.040.
- 246-08-200 Judicial review of final adjudicative order. [Statutory Authority: RCW 34.05.220. 92-02-018 (Order 224), § 246-08-200, filed 12/23/91, effective 1/23/92. Statutory Authority: RCW 43.70.040. 91-02-049 (Order 121), recodified as § 246-08-200, filed 12/27/90, effective 1/31/91. Statutory Authority: RCW 34.05.220. 90-06-018 (Order 038), § 248-08-575, filed 2/28/90, effective 3/1/90.] Repealed by 93-13-005 (Order 369), filed 6/3/93, effective 7/4/93. Statutory Authority: RCW 43.70.040.
- 246-08-210 Variances, waivers, and exemptions. [Statutory Authority: RCW 43.70.040. 91-02-049 (Order 121), recodified as § 246-08-210, filed 12/27/90, effective 1/31/91. Statutory Authority: Chapter 34.05 RCW. 90-01-134 (Order 016), § 248-08-596, filed 12/20/89, effective 1/20/90. Statutory Authority: RCW 43.20.050. 85-15-063 (Order 289), § 248-08-596, filed 7/18/85; 84-16-031 (Order 272), § 248-08-596, filed 7/25/84. Formerly WAC 248-08-595.] Repealed by 93-13-005 (Order 369), filed 6/3/93, effective 7/4/93. Statutory Authority: RCW 43.70.040.
- 246-08-320 Delegation of authority by secretary. [Statutory Authority: RCW 43.70.040. 91-02-049 (Order 121), recodified as § 246-08-320, filed 12/27/90, effective 1/31/91. Statutory Authority: RCW 34.05.220. 90-06-018 (Order 038), § 248-320-340, filed 2/28/90, effective 3/1/90.] Repealed by 93-13-005 (Order 369), filed 6/3/93, effective 7/4/93. Statutory Authority: RCW 43.70.040.
- 246-08-330 Declaratory orders—Forms, content, and filing. [Statutory Authority: RCW 43.70.040. 91-02-049 (Order 121), recodified as § 246-08-330, filed 12/27/90, effective 1/31/91. Statutory Authority: RCW 34.05.220. 90-06-018 (Order 038), § 248-320-350, filed 2/28/90, effective 3/1/90.] Repealed by 93-13-005 (Order 369), filed 6/3/93, effective 7/4/93. Statutory Authority: RCW 43.70.040.

- 246-08-340 Declaratory orders—Procedural rights of persons in relation to petition. [Statutory Authority: RCW 43.70.040. 91-02-049 (Order 121), recodified as § 246-08-340, filed 12/27/90, effective 1/31/91. Statutory Authority: RCW 34.05.220. 90-06-018 (Order 038), § 248-320-360, filed 2/28/90, effective 3/1/90.] Repealed by 93-13-005 (Order 369), filed 6/3/93, effective 7/4/93. Statutory Authority: RCW 43.70.040.
- 246-08-350 Declaratory orders—Disposition of petition. [Statutory Authority: RCW 43.70.040. 91-02-049 (Order 121), recodified as § 246-08-350, filed 12/27/90, effective 1/31/91. Statutory Authority: RCW 34.05.220. 90-06-018 (Order 038), § 248-320-370, filed 2/28/90, effective 3/1/90.] Repealed by 93-13-005 (Order 369), filed 6/3/93, effective 7/4/93. Statutory Authority: RCW 43.70.040.
- 246-08-360 Petition for rule making—Form, content, and filing. [Statutory Authority: RCW 43.70.040. 91-02-049 (Order 121), recodified as § 246-08-360, filed 12/27/90, effective 1/31/91. Statutory Authority: RCW 34.05.220. 90-06-018 (Order 038), § 248-320-400, filed 2/28/90, effective 3/1/90.] Repealed by 93-13-005 (Order 369), filed 6/3/93, effective 7/4/93. Statutory Authority: RCW 43.70.040.
- 246-08-370 Petition for rule making—Consideration and disposition. [Statutory Authority: RCW 43.70.040. 91-02-049 (Order 121), recodified as § 246-08-370, filed 12/27/90, effective 1/31/91. Statutory Authority: RCW 34.05.220. 90-06-018 (Order 038), § 248-320-410, filed 2/28/90, effective 3/1/90.] Repealed by 93-13-005 (Order 369), filed 6/3/93, effective 7/4/93. Statutory Authority: RCW 43.70.040.
- 246-08-380 Updating mailing lists. [Statutory Authority: RCW 43.70.040. 91-02-049 (Order 121), recodified as § 246-08-380, filed 12/27/90, effective 1/31/91. Statutory Authority: RCW 34.05.220. 90-06-018 (Order 038), § 248-320-500, filed 2/28/90, effective 3/1/90.] Repealed by 93-13-005 (Order 369), filed 6/3/93, effective 7/4/93. Statutory Authority: RCW 43.70.040.

## ADJUDICATIVE PROCEEDINGS

**WAC 246-08-101 Declaratory orders—Forms, content, and filing.** A petition for a declaratory order shall generally adhere to the following form:

(1) At the top of the page shall appear the wording "Before the Washington state department of health." On the left side of the page below the foregoing the following caption shall be set out: "In the matter of the petition of (name of petitioning party) for a declaratory order." Opposite the foregoing caption shall appear the word "petition."

(2) The body of the petition shall be set out in numbered paragraphs. The first paragraph shall state the name and address of the petitioning party. The second paragraph shall state all rules or statutes that may be brought into issue by the petition. Succeeding paragraphs shall set out the statement of facts relied upon in form similar to that applicable to complaints in civil actions before the superior courts of this state. The concluding paragraphs shall contain the prayer of the petitioner. The petition shall be subscribed and verified in the manner prescribed for verification of complaints in the superior courts of this state.

(3) The original and two legible copies shall be filed with the appropriate board having jurisdiction in relation to a profession as provided in RCW 18.130.040 (2)(b). The original and two legible copies shall be filed with the Department of Health, Office of Professional Standards, PO Box 47872, Olympia, WA 98504-7872 if the secretary of the department of health has jurisdiction in relation to a profession or program as provided under RCW 18.130.040 (2)(a)

and 43.70.020 through 43.70.040 respectively. Petitions shall be on white paper, 8 1/2" x 11" in size.

[Statutory Authority: RCW 43.70.040. 93-13-005 (Order 369), § 246-08-101, filed 6/3/93, effective 7/4/93.]

**WAC 246-08-102 Declaratory orders—Procedural rights of persons in relation to petition.** If a petition for a declaratory order is set for specified proceedings under RCW 34.05.240 (5)(b), the department shall give not less than seven days advance written notice of the proceedings to the petitioner and all persons described under RCW 34.05.240(3). The notice shall contain the time, date, place, and nature of the proceedings and shall describe how interested persons may participate in the proceeding.

[Statutory Authority: RCW 43.70.040. 93-13-005 (Order 369), § 246-08-102, filed 6/3/93, effective 7/4/93.]

**WAC 246-08-103 Declaratory orders—Disposition of petition.** A declaratory order entered by the department or a decision declining to enter a declaratory order shall be in writing and shall be served upon the petitioner and all other persons described under RCW 34.05.240(3).

[Statutory Authority: RCW 43.70.040. 93-13-005 (Order 369), § 246-08-103, filed 6/3/93, effective 7/4/93.]

**WAC 246-08-106 Updating mailing lists.** (1) Periodically, the department may cause the following notice, or a notice substantially similar, to be mailed: "In order to maintain as current a mailing list as possible, and to eliminate mailing notices to those who no longer have need for such notices, the department will discontinue use of its old mailing lists, effective (date to be specified). If you wish to continue receiving copies of notices of intention to adopt, amend, or repeal rules after that date, please fill out the attached form and return it to the department at the address indicated on the form. If you do not return the form indicating your desire to continue to receive notices to adopt, amend, or repeal rules, your name or the names of your organization will be removed from the mailing lists."

(2) The notice regarding updating of mailing lists is to be mailed by first-class mail.

(3) The form to be filled out by those persons or organizations wishing to continue to receive department notices to adopt, amend, or repeal rules shall specify interest areas covered by these notices, thereby enabling those on mailing lists to limit correspondence received.

[Statutory Authority: RCW 43.70.040. 93-13-005 (Order 369), § 246-08-106, filed 6/3/93, effective 7/4/93.]

## ADMINISTRATIVE PROCEDURES

**WAC 246-08-390 Acquisition, retention and security of health care information.** This section sets forth the process by which the department of health or disciplining authority obtains and protects health care information under RCW 70.02.050. This section does not apply to health care information obtained by the department through other sources.

(1) Acquisition.

(a) The department shall request health care information in writing.

(b) Health care providers shall provide the requested information pursuant to RCW 70.02.050.

(2) Retention. The department shall maintain health care information obtained under this section as long as necessary to perform agency functions.

(3) Security. The department shall secure the records and protect confidentiality.

(a) The manager of the program within the department that requested the records shall act as the custodian of records, and shall provide access to the information only as necessary to perform agency responsibilities.

(b) The custodian shall monitor the location and security of the information.

(4) The department shall not make health care information obtained under RCW 70.02.050 available for public inspection and copying except as may be required by chapter 42.17 RCW. No health care information containing patient identifying data shall be made available for public inspection and copying under chapter 42.17 RCW. Health care information obtained under this section may be released to public agencies or entities as required by law or upon agreement by the agency or entity that the health care information will be used only for authorized statutory purposes and will not be disclosed further.

[Statutory Authority: RCW 70.02.050(3). 92-07-080 (Order 253), § 246-08-390, filed 3/17/92, effective 4/17/92.]

## POLICIES

**WAC 246-08-400 Searching and duplicating medical records.** Effective July 1, 1995, through June 30, 1997, the "reasonable fee" defined in RCW 70.02.010(12) for duplicating or searching a record shall not exceed sixty-nine cents per page for the first thirty pages and fifty-three cents for all other pages. In addition, a clerical fee for searching and handling may be charged not to exceed sixteen dollars. However, where editing of records by a health care provider is required by statute and is done by the provider personally, the fee may be the usual and customary charge for a basic office visit.

[Statutory Authority: RCW 43.70.040 and 70.02.101(12). 95-20-080, § 246-08-400, filed 10/4/95, effective 11/4/95.]

**WAC 246-08-420 Public records—Access and exemptions.** (1) Public records shall be available for inspection and copying during the department's normal business hours.

(2) The location of specific public records may be obtained by contacting the program where the records are maintained or the rules coordinator in the management services division.

(3) Requests for copies of public records shall be in writing and include:

(a) The name and address of the person requesting the record;

(b) A detailed description of the requested material; and

(c) If a list of names of individuals is being requested, an explanation of the purpose for which the request is made.

(4) No fee shall be charged for the inspection of public records, however the department may charge for reimbursement of the costs incurred by providing copies.

(5) The department reserves the right to determine that a public record is exempt from public disclosure under the provisions of chapter 42.17 RCW.

(6) The department reserves the right to delete identifying details when disclosing public records if there is reason to believe that disclosure of such details would be an invasion of personal privacy.

(7) The department, when denying a request for a public record, shall provide a statement of the specific exemption which authorizes the withholding of the record and a brief explanation of how the exemption applies to the record withheld.

(8) Upon receipt of such denial, the requesting party may seek review of the decision by letter addressed to the deputy secretary, 1112 S.E. Quince Street, P.O. Box 47890, Olympia, WA 98504-7890.

[Statutory Authority: RCW 43.70.050. 93-08-004 (Order 346), § 246-08-420, filed 3/24/93, effective 4/24/93.]

### WAC 246-08-440 Protection of public records.

Access to the record storage areas shall be restricted to insure that essential functions of the agency are carried out and public records are not damaged, altered, disorganized, or lost. Inspection shall be in the presence of an authorized department employee. Inspection shall be denied and the records withdrawn if the individual inspecting the records is doing so in a manner likely to damage, alter, or substantially disorganize them; or attempts to remove them from the prescribed location; or is excessively interfering or will unduly interfere with other essential functions of the department.

[Statutory Authority: RCW 43.70.050. 93-08-004 (Order 346), § 246-08-440, filed 3/24/93, effective 4/24/93.]

### WAC 246-08-450 Final orders, declaratory orders, interpretive statements and policy statements—Indexes.

(1) In accordance with RCW 42.17.260, the department shall index:

(a) Final orders that are issued in adjudicative proceedings as defined in RCW 34.05.010(1) and contain an analysis or decision of substantial importance to the department in carrying out its duties;

(b) Declaratory orders that contain an analysis or decision of substantial importance to the department in carrying out its duties;

(c) Interpretive statements as defined in RCW 34.05.010(8); and

(d) Policy statements as defined in RCW 34.05.010(14).

(2) The department shall maintain indexes of:

(a) Final orders meeting the criteria in subsection (1)(a) of this section, issued by the department and the disciplining authorities identified in RCW 18.130.040;

(b) Declaratory orders meeting the criteria in subsection (1)(b) of this section issued by the department and the state board of health; and

(c) Interpretive and policy statements issued by the department and state board of health.

(3) The indexes shall, at a minimum, contain the case or document number; type of document; name of parties, if applicable, unless such names are exempt from public disclosure; brief description of subject, program; pertinent legal citation; and location of the document.

(4) Any person may nominate a final adjudicative order or declaratory order to be evaluated for indexing by completing an Order Index Nomination Request Form which can be obtained from and returned to the Office of Professional Standards, PO Box 47872, Olympia, WA 98504-7872, along with a copy of the nominated order. The department shall make a final decision as to whether to index the nominated order, and that decision is not appealable.

(5) The department shall update the indexes on an ongoing basis and conduct an annual review to verify that the indexed documents continue to meet the criteria in subsection (1) of this section. The department may, at any time, delete a document from an index. Pursuant to RCW 42.17.260(6), a public record may not be cited in a proceeding if it has not been indexed.

(6) The indexes are public records and are available for public inspection and copying in accordance with WAC 246-08-420 and 246-08-440. Indexes are located as follows:

(a) The index of final adjudicative orders is located in the Office of Professional Standards, 2413 Pacific Avenue, Olympia, WA; and

(b) The index of declaratory orders, interpretive and policy statements issued by the department and the state board of health is located in the Office of the Secretary, 1112 Quince St. SE, Olympia, WA 98504.

[Statutory Authority: RCW 43.70.040. 94-04-079, § 246-08-450, filed 1/31/94, effective 3/3/94. Statutory Authority: 43.70.050. 93-08-004 (Order 346), § 246-08-450, filed 3/24/93, effective 4/24/93.]

**WAC 246-08-520 Equal opportunity/affirmative action.** The department is firmly committed to equal opportunity and nondiscrimination both in the work force and in the delivery of services and makes every good faith effort to achieve the objectives of the affirmative action plan.

(1) **Employment** - The department recruits, hires, develops, and promotes persons in all job classifications without regard to race, creed, color, sex, age, national origin, marital status, or presence of a mental, physical, or sensory handicap. The department seeks to maintain a working environment free of harassment or intimidation, and to reasonably accommodate persons of disability.

(2) **Affirmative action** - The department strives to correct deficiencies regarding the utilization of protected groups, consistent with WAC 356-05-327, according to the timetables set forth in the department's affirmative action plan.

(3) **Services** - The department provides services, programs, and lets contracts in a fair and impartial manner. No person shall, on the grounds of sex, race, creed, color, age, national origin, marital status, or handicap be excluded from participation in, be denied the benefits of, or be subjected to discrimination under any program or activity administered or supervised by the department as required by the federal government as a prerequisite for fiscal grants-in-aid (Sec. 601, Civil Rights Act of 1964; 78 Stat. 252; 42 U.S.C. 2000d) and chapter 49.60 RCW.

[Statutory Authority: RCW 43.70.050. 93-08-004 (Order 346), § 246-08-520, filed 3/24/93, effective 4/24/93. Statutory Authority: RCW 43.70.040. 91-02-049 (Order 121), recodified as § 246-08-520, filed 12/27/90, effective 1/31/91; Order 18, § 248-10-010, filed 2/11/69.]

**WAC 246-08-560 Fees—Payment—Refunds.** (1) Fees are due with applications for initial licensing and renewals. The department will not proceed on applications until required fees are paid.

(2) Fee payments may be made in person or by mail. Payment shall be by check, draft, or money order made payable to the department of health.

(3) If a license is denied, revoked, or suspended, fees shall not be refunded.

(4) Application for license after denial or revocation shall include fees as provided for in this title.

(5) Failure to pay fees when due shall invalidate the license/certification/registration and all privileges granted by the license/certification/registration. A late penalty fee shall be remitted in addition to the annual renewal fee.

(6) The department of health shall refund fees it collects that are paid in excess of the stated fee, or paid erroneously.

(7) The payee shall submit to the department a cancelled check or a cash receipt as proof of payment when requesting a refund.

(8) The department shall make refunds of five dollars or less only upon written request within thirteen months from date of payment.

[Statutory Authority: RCW 43.70.050. 93-08-004 (Order 346), § 246-08-560, filed 3/24/93, effective 4/24/93. Statutory Authority: RCW 43.70.040. 91-02-049 (Order 121), recodified as § 246-08-560, filed 12/27/90, effective 1/31/91. Statutory Authority: RCW 43.01.072. 90-08-003 (Order 044), § 246-09-060, filed 3/22/90, effective 4/22/90.]

## Chapter 246-10 WAC

### ADMINISTRATIVE PROCEDURE—ADJUDICATIVE PROCEEDINGS

#### WAC

#### SECTION I PRELIMINARY MATTERS

246-10-101	Application of chapter.
246-10-102	Definitions.
246-10-103	Signature authority.
246-10-104	Appearance of parties.
246-10-105	Computation of time.
246-10-106	Notarization, certification, and authentication.
246-10-107	Persons who may request adjudicative proceedings.
246-10-108	Representation.
246-10-109	Service and filing.
246-10-110	Jurisdiction.
246-10-111	Telephone proceedings.
246-10-112	Hearing location.
246-10-113	Good faith requirement.
246-10-114	Public records.
246-10-115	Expenses and witness fees.
246-10-116	Immunity.
246-10-117	Official notice and agency expertise.
246-10-118	Sanctions.
246-10-119	Intervention.
246-10-120	Form of pleadings and orders.
246-10-121	Notice to limited-English-speaking parties.
246-10-122	Interpreters.
246-10-123	Subpoenas.
246-10-124	Preliminary requirements.

SECTION II  
INITIATING ACTIONS

246-10-201	Form and content of initiating documents.
246-10-202	Amendment of initiating documents.
246-10-203	Request for adjudicative proceeding.
246-10-204	Default.
246-10-205	Scheduling orders.

SECTION III  
EMERGENCY ADJUDICATIVE PROCEEDINGS

246-10-301	Conduct of emergency adjudicative proceedings.
246-10-302	Effect of summary action.
246-10-303	Form and content of summary actions.
246-10-304	Adjudicative proceedings upon summary action.
246-10-305	Opportunity for prompt adjudicative proceeding.
246-10-306	Proceedings prior to prompt adjudicative proceeding.

SECTION IV  
SETTLEMENT AND PREHEARING PROCEEDINGS

246-10-401	Settlement conference.
246-10-402	Discovery.
246-10-403	Motions.
246-10-404	Prehearing conference.
246-10-405	Protective orders.

SECTION V  
BRIEF ADJUDICATIVE PROCEEDINGS

246-10-501	Application of brief adjudicative proceedings.
246-10-502	Preliminary record in brief adjudicative proceedings.
246-10-503	Conduct of brief adjudicative proceedings.
246-10-504	Effectiveness of orders on brief adjudicative proceedings.
246-10-505	Agency record in brief proceedings.

SECTION VI  
HEARING

246-10-601	Notice of adjudicative proceeding.
246-10-602	Conduct of adjudicative proceeding.
246-10-603	Evidence.
246-10-604	Proposed order.
246-10-605	Issuance of final order.
246-10-606	Standard of proof.
246-10-607	Consolidated proceedings.
246-10-608	Initial order.

SECTION VII  
POSTHEARING PROCESS

246-10-701	Appeal from initial order.
246-10-702	Final orders.
246-10-703	Stay of final orders.
246-10-704	Reconsideration of final orders.
246-10-705	Agency record of adjudicative proceedings.
246-10-706	Judicial review.
246-10-707	Vacating an order for reason of default or withdrawal.

SECTION I  
PRELIMINARY MATTERS

**WAC 246-10-101 Application of chapter.** (1) This chapter shall apply to adjudicative proceedings authorized to be conducted under the authority of the department of health.

(2) This chapter applies to adjudicative proceedings begun on or after the effective date of this chapter in programs administered by the department of health. For purposes of this section, "begun" shall mean the receipt by the appropriate office of an application for an adjudicative proceeding. These rules shall be the exclusive rules governing adjudicative proceedings under the jurisdiction of the department.

(3) To the extent that these rules differ by inclusion, deletion, or content from the model rules adopted by the

chief administrative law judge pursuant to RCW 34.05.250, this chapter shall prevail in order to provide a process consistent with the organization of the department.

(4) Where a provision of this chapter conflicts with another chapter of this title, the provision of this chapter shall prevail.

(5) Where a provision of this chapter conflicts with a provision of the Revised Code of Washington, the statute shall prevail.

[Statutory Authority: RCW 43.70.040, 93-13-005 (Order 369), § 246-10-101, filed 6/3/93, effective 7/4/93.]

**WAC 246-10-102 Definitions.** As used in these rules of practice and procedure, the following terms shall have the meaning set forth in this section unless the context clearly indicates otherwise. Other terms shall have their ordinary meaning unless defined elsewhere in this chapter.

"Adjudicative proceeding" or "hearing" shall mean a proceeding required by statute or constitutional right and conducted under the rules of this chapter, which provides an opportunity to be heard by the department prior to the entry of a final order under this chapter.

"Brief adjudicative proceeding" shall mean an adjudicative proceeding or hearing, the scope or conduct of which is limited as provided in this chapter.

"Department" shall mean the Washington state department of health and, where appropriate, the secretary of the Washington state department of health or the secretary's designee.

"Filing" shall mean receipt by the office of professional standards.

"Initiating document" shall mean a written agency document which initiates action against a license holder or applicant for license or recipient of benefits and which creates the right to an adjudicative proceeding. It may be entitled a statement of charges, notice of intent to deny, order, or by any other designation indicating the action or proposed action to be taken.

"License" shall have the meaning set forth in RCW 34.05.010, and includes any license, certification, registration, permit, approval, or any similar form of authorization required by law to be obtained from the department.

"Office of professional standards" shall mean the unit responsible for conducting adjudicative proceedings, whose address is:

Department of Health  
Office of Professional Standards  
2413 Pacific Avenue  
PO Box 47872  
Olympia, WA 98504-7872

"Presiding officer" shall mean the person who is assigned to conduct an adjudicative proceeding. The presiding officer may be an employee of the department who is authorized to issue a final decision as designee of the secretary, or an administrative law judge employed by the office of administrative hearings.

"Presiding officer for brief adjudicative proceedings" shall mean an employee of the department who is authorized to conduct brief adjudicative proceedings.



"Program" shall mean the administrative unit within the department responsible for implementation of a particular statute or rule.

"Prompt adjudicative proceeding" or "prompt hearing" shall mean a hearing conducted at the request of the license holder or applicant for license following summary action taken in accord with this chapter against that license holder or applicant.

"Protective order" shall mean an order issued under this chapter which limits the use of, access to, or disclosure of information or evidence.

"Recipient of benefits" shall mean an individual who has qualified for benefits administered by the department.

"Respondent" shall mean a person eligible to request an adjudicative proceeding in a program under the jurisdiction of the department who is named in an initiating document.

"Secretary" shall mean the secretary of the department of health or his/her designee.

"Summary action" shall mean an agency action to address an immediate danger to the public health, safety, or welfare and shall include, but not be limited to, a cease and desist order, an order of summary suspension, and an order of summary restriction of a license.

[Statutory Authority: RCW 43.70.040. 94-04-079, § 246-10-102, filed 1/31/94, effective 3/3/94; 93-13-005 (Order 369), § 246-10-102, filed 6/3/93, effective 7/4/93.]

**WAC 246-10-103 Signature authority.** (1) A person designated by the program shall sign all initiating documents issued under this chapter.

(2) The presiding officer shall sign all orders issued under this chapter.

(3) Authority to sign shall be indicated by designation of the title of the person signing and shall not require any other affirmation, affidavit, or allegation.

[Statutory Authority: RCW 43.70.040. 94-04-079, § 246-10-103, filed 1/31/94, effective 3/3/94; 93-13-005 (Order 369), § 246-10-103, filed 6/3/93, effective 7/4/93.]

**WAC 246-10-104 Appearance of parties.** If a respondent requests an adjudicative proceeding to contest the action, that party shall appear at all stages of the proceeding except as otherwise provided in this section.

(1) If the respondent is represented as provided in this chapter, the respondent shall appear personally at the hearing and at any scheduled settlement conference but need not appear at the prehearing conference or at presentation of motions.

(2) Parties may be represented by counsel at all proceedings.

(3) The respondent may appear by telephone at any portion of the proceedings conducted by telephone, in the discretion of the presiding officer following reasonable advance notice to the presiding officer and to the opposing party.

(4) The requirement of personal appearance may be waived for good cause in the discretion of the presiding officer.

(5) Failure to appear as provided in this chapter shall be grounds for taking final action by default.

[Statutory Authority: RCW 43.70.040. 93-13-005 (Order 369), § 246-10-104, filed 6/3/93, effective 7/4/93.]

**WAC 246-10-105 Computation of time.** (1) When computing a period of time prescribed or allowed by an applicable statute or rule, the day of the act, event, or default from which the designated period of time begins to run shall not be included.

(2) The last day of the computed period shall be included unless the last day is a Saturday, Sunday, or legal holiday.

(3) When the last day is a Saturday, Sunday, or legal holiday, the period shall run until the end of the next day which is not a Saturday, Sunday, or legal holiday.

(4) When the period of time prescribed or allowed is seven days or less, any intermediate Saturday, Sunday, and legal holiday shall be excluded from the computation.

[Statutory Authority: RCW 43.70.040. 93-13-005 (Order 369), § 246-10-105, filed 6/3/93, effective 7/4/93.]

**WAC 246-10-106 Notarization, certification, and authentication.** (1) A person's sworn written statement, declaration, verification, certificate, oath, or affidavit may be authenticated by an unsworn written statement which is executed in substantially the following form:

I certify (or declare) under penalty of perjury under the laws of the state of Washington that the foregoing is true and correct.

\_\_\_\_\_  
(Date and Place)

\_\_\_\_\_  
(Signature)

(2) Documents or records may be authenticated by a certification, as provided in subsection (1) of this section, from the custodian of the records or other qualified person that the documents or records are what they purport to be.

(3) Signature of any attorney shall be accompanied by and authenticated by that attorney's Washington State Bar Association number.

(4) Documents prepared and submitted by a party who is not represented by an attorney shall be signed and dated by that party and shall include that party's current address.

(5) Signature by a party or an attorney on a document shall constitute a certificate by the party or attorney that he/she has read the document, believes there are grounds to support it, and has not submitted the document for delay, harassment, or needless increase in the cost of a proceeding.

(6) Compliance with certification requirements of subsections (1) and (2) of this section creates a rebuttable presumption that a document is authentic.

[Statutory Authority: RCW 43.70.040. 93-13-005 (Order 369), § 246-10-106, filed 6/3/93, effective 7/4/93.]

**WAC 246-10-107 Persons who may request adjudicative proceedings.** The persons indicated may request an adjudicative proceeding under this chapter.

(1)(a) With respect to the denial of applications made under WAC 246-290-100, 246-290-110, 246-290-120, 246-290-130, 246-290-140, 246-291-100, 246-291-110, 246-291-120, 246-291-130, 246-291-140, and 246-295-040, the denied applicant may request an adjudicative proceeding.

(b) A person whose application for the approval of a new public water system is denied under WAC 246-293-190, a purveyor whose license is adversely affected by a departmental decision under WAC 246-293-190 or the county legislative authority having jurisdiction in the area affected by the decision may request an adjudicative proceeding under this chapter.

(c) A purveyor affected by the decision of the department under WAC 246-293-430 or the county legislative authority having jurisdiction in the area may request an adjudicative proceeding with respect to a decision made under WAC 246-293-430.

(d) A person upon whom a civil penalty is imposed under RCW 70.119A.040 may request an adjudicative proceeding.

(2) With respect to all other matters involving the issuance, denial of, or adverse action against, a license, the applicant or licensee may request an adjudicative proceeding.

(3) With respect to matters involving receipt of benefits or application therefor, the recipient of or applicant for the benefits may request an adjudicative proceeding.

(4) With respect to an application for approval of a school or curriculum, the person or authority that applied for such approval may request an adjudicative proceeding.

(5) With respect to the department's final threshold determination that an environmental impact statement (EIS) is or is not necessary and with respect to the adequacy of a final EIS, any person may request an adjudicative proceeding who:

(a) Is seeking to protect an interest within the zone of interests to be protected or regulated by the statute or constitutional guarantee in question; and

(b) Will be specifically and perceptibly harmed by the proposed action.

(6) Any application for an adjudicative proceeding that on its face demonstrates that the person making the application does not have standing under this rule may be summarily dismissed by entry of a decision pursuant to RCW 34.05.416. A motion to dismiss a matter for lack of standing may be made at any time prior to entry of the final order.

[Statutory Authority: RCW 18.130.050 and 43.70.040. 96-21-027, § 246-10-107, filed 10/7/96, effective 11/7/96. Statutory Authority: RCW 43.70.040. 94-04-079, § 246-10-107, filed 1/31/94, effective 3/3/94; 93-13-005 (Order 369), § 246-10-107, filed 6/3/93, effective 7/4/93.]

**WAC 246-10-108 Representation.** (1) Persons requesting an adjudicative proceeding may be represented subject to the following conditions:

(a) A person requesting an adjudicative proceeding may represent himself/herself or may be represented by an attorney who has complied with the admission to practice rules of the supreme court of the state of Washington;

(b) Every attorney representing a person requesting an adjudicative proceeding shall file a notice of appearance with the office of professional standards upon commencing representation, and shall file a notice of withdrawal of counsel with the office of professional standards upon terminating representation.

(c) No person requesting an adjudicative proceeding may be represented in an adjudicative proceeding by an employee of the department.

(2) No current or former employee of the department may appear as an expert, character witness, or representative of any party other than the state of Washington if he/she took an active part in investigating or evaluating the case or represented the agency in the matter, unless written permission of the secretary is granted. No current or former member of the attorney general's office staff who participated personally and substantially in investigating or evaluating the matter at issue while so employed may represent a party or otherwise participate in a related proceeding without first having obtained the written consent of the attorney general's office.

[Statutory Authority: RCW 43.70.040. 93-13-005 (Order 369), § 246-10-108, filed 6/3/93, effective 7/4/93.]

**WAC 246-10-109 Service and filing.** (1) A party filing a pleading, brief, or paper other than an initiating document or application for an adjudicative proceeding as required or permitted by these rules, shall serve a copy of the paper upon the opposing party or any designated representative of the opposing party prior to or simultaneous with filing.

(2) Unless otherwise provided by law, filing and service shall be made by personal service; by first class, registered, or certified mail; or by electronic telefacsimile transmission (FAX) where copies are mailed simultaneously.

(3) Filing shall be complete upon actual receipt during normal business hours at the office of professional standards.

(4) Service shall be complete when personal service is made; or mail is properly stamped, addressed, and deposited in the United States mail; or FAX transmission is completed and copies are deposited in the United States mail properly stamped and addressed.

(5) Proof of service shall consist of filing as required by these rules, together with one of the following:

(a) An acknowledgement of service;

(b) A certificate of service including the date the papers were served, the parties upon whom served, the signature of the serving party, and a statement that service was completed by:

(i) Personal service; or

(ii) Mailing in the United States mail a copy properly addressed with postage and fees prepaid to each party and each designated representative.

(6) For the purpose of service on a licensee or a person requesting an adjudicative proceeding, service shall be made at the last known address provided to the department in accordance with WAC 246-01-100, unless the program has actual knowledge of a different correct address for the person being served.

[Statutory Authority: RCW 43.70.040. 94-04-079, § 246-10-109, filed 1/31/94, effective 3/3/94; 93-13-005 (Order 369), § 246-10-109, filed 6/3/93, effective 7/4/93.]

**WAC 246-10-110 Jurisdiction.** (1) The department has jurisdiction over all licenses issued by the department and over all holders of and applicants for licenses. Such jurisdiction is retained even if an applicant requests to withdraw the application, or a licensee surrenders or fails to renew a license.

(2) The department has jurisdiction over unlicensed practice of any activity for which a license is required unless otherwise prohibited by law.

[Statutory Authority: RCW 43.70.040. 94-04-079, § 246-10-110, filed 1/31/94, effective 3/3/94; 93-13-005 (Order 369), § 246-10-110, filed 6/3/93, effective 7/4/93.]

**WAC 246-10-111 Telephone proceedings.** (1) The presiding officer may conduct all or part of the proceedings or permit a party or witness to appear by telephone or other electronic means if each participant in the proceedings has an opportunity to participate in, hear, and, if technically and economically feasible, see the entire proceeding while it is taking place. Cost of such appearance may be assessed to the party so appearing or on whose behalf the witness appears.

(2) If all or part of the proceedings is conducted as provided in subsection (1) of this section, the parties shall file and serve copies of all documentary evidence no less than three days prior to the proceeding. The presiding officer may, for good cause, allow exceptions to this requirement.

[Statutory Authority: RCW 43.70.040. 93-13-005 (Order 369), § 246-10-111, filed 6/3/93, effective 7/4/93.]

**WAC 246-10-112 Hearing location.** The presiding officer shall designate sites for the conduct of proceedings taking into account accessibility, efficiency, and economy.

[Statutory Authority: RCW 43.70.040. 93-13-005 (Order 369), § 246-10-112, filed 6/3/93, effective 7/4/93.]

**WAC 246-10-113 Good faith requirement.** Good faith shall be the standard for compliance with these rules. Failure to make a good faith effort to comply with these rules shall be grounds for sanctions as provided in this chapter.

[Statutory Authority: RCW 43.70.040. 93-13-005 (Order 369), § 246-10-113, filed 6/3/93, effective 7/4/93.]

**WAC 246-10-114 Public records.** (1) All papers, exhibits, transcripts, and other materials required by or submitted in accordance with this chapter shall be considered public records.

(2) Release of information upon request for public records shall be subject to the following limitations:

(a) Release of health care information shall comply with chapter 70.02 RCW and rules promulgated thereunder;

(b) Protective orders issued pursuant to WAC 246-10-405 shall prevail; and

(c) Chapter 42.17 RCW shall govern the release of records.

[Statutory Authority: RCW 43.70.040. 94-04-079, § 246-10-114, filed 1/31/94, effective 3/3/94; 93-13-005 (Order 369), § 246-10-114, filed 6/3/93, effective 7/4/93.]

**WAC 246-10-115 Expenses and witness fees.** (1) Fees and expenses shall be paid at the following rates to witnesses appearing under subpoena by the party requesting the appearance:

(a) Fees shall be paid at the daily rate established for jurors in district court of Thurston County; and

(b) Expenses shall be paid at the rate established for employees of the state of Washington, or as otherwise required by law.

(2) Fees for an expert witness shall be negotiated by and paid by the party requesting services of the expert.

(3) All expenses incurred in connection with proceedings under this chapter shall be paid by the party incurring the expense.

(4) The department shall pay expenses associated with:

(a) The facility in which proceedings are conducted; and

(b) Recording of the proceedings.

(5) Expenses related to preparation and distribution of the transcript of proceedings shall be paid by the party filing a motion or request for review of an initial order or petition for reconsideration, appealing a final order, or otherwise requesting the transcript.

[Statutory Authority: RCW 43.70.040. 94-04-079, § 246-10-115, filed 1/31/94, effective 3/3/94; 93-13-005 (Order 369), § 246-10-115, filed 6/3/93, effective 7/4/93.]

**WAC 246-10-116 Immunity.** The legislature has determined that persons who file complaints with or provide information to the department regarding health care practitioners licensed by the department are immune from civil liability, provided that such persons have acted in good faith. RCW 4.24.240 through 4.24.260, 18.130.170, 18.130.180, and 18.130.300 set forth the provisions under which immunity is granted.

[Statutory Authority: RCW 43.70.040. 93-13-005 (Order 369), § 246-10-116, filed 6/3/93, effective 7/4/93.]

**WAC 246-10-117 Official notice and agency expertise.** (1) Official notice may be taken as provided in RCW 34.05.452(5).

(2) The department, through its designated presiding officer, may use its expertise and specialized knowledge to evaluate and draw inferences from the evidence presented to it.

[Statutory Authority: RCW 43.70.040. 93-13-005 (Order 369), § 246-10-117, filed 6/3/93, effective 7/4/93.]

**WAC 246-10-118 Sanctions.** (1) Orders may include sanctions against either party.

(2) Grounds for sanctions may include:

(a) Failure to comply with these rules or orders of the presiding officer; and

(b) Willful interference with the progress of proceedings.

(3) Sanctions may include:

(a) Dismissal of the matter;

(b) Proceeding in default; and

(c) Other sanctions as appropriate.

(4) The order shall state the grounds upon which any sanctions are imposed.

[Statutory Authority: RCW 43.70.040. 93-13-005 (Order 369), § 246-10-118, filed 6/3/93, effective 7/4/93.]

**WAC 246-10-119 Intervention.** (1) The presiding officer may grant a petition for intervention pursuant to RCW 34.05.443.

(2) A request to intervene shall be handled as a pre-hearing motion and shall be subject to the dates contained in the scheduling order. Within the sound exercise of discretion, the presiding officer may allow intervention if:

(a) The intervenor is not a party to the matter but has a substantial interest in outcome of the matter and the interest of the intervenor is not adequately represented by a party, or other good cause exists; and

(b) Any representative of the intervenor meets the requirements of WAC 246-10-108.

(3) A person shall not be allowed to intervene if that person had notice of the agency's decision and, upon timely application, would have been able to appear as a party in the matter in which intervention is sought, but failed to make such timely application.

(4) If intervention is granted, the intervenor shall be subject to these rules on the same basis as the other parties to the proceeding, unless otherwise limited in the order granting intervention.

[Statutory Authority: RCW 43.70.040. 93-13-005 (Order 369), § 246-10-119, filed 6/3/93, effective 7/4/93.]

**WAC 246-10-120 Form of pleadings and orders.**

(1) Pleadings, orders, and other papers filed, served, or entered under this chapter shall be:

(a) Captioned with the name of the state of Washington, department of health and the title of the proceeding; and

(b) Signed by the person filing, serving, or entering the document. When that person is an attorney representing a party, the signature block shall include the attorney's Washington State Bar Association number.

(2) All orders shall comply with RCW 34.05.461 and the requirements of this chapter.

[Statutory Authority: RCW 43.70.040. 93-13-005 (Order 369), § 246-10-120, filed 6/3/93, effective 7/4/93.]

**WAC 246-10-121 Notice to limited-English-speaking parties.** When the program or the office of professional standards is notified or otherwise made aware that a limited-English-speaking person is a party in an adjudicative proceeding, all notices concerning the hearing, including notices of hearing, continuance, and dismissal, shall either be in the primary language of the party or shall include a notice in the primary language of the party which describes the significance of the notice and how the party may receive assistance in understanding and, if necessary, responding to the notice.

[Statutory Authority: RCW 43.70.040. 93-13-005 (Order 369), § 246-10-121, filed 6/3/93, effective 7/4/93.]

**WAC 246-10-122 Interpreters.** (1) A "hearing impaired person" means a person who, because of a hearing impairment or speech defect, cannot readily understand or communicate in spoken language. A "hearing impaired person" includes a person who is deaf, deaf and blind, or hard of hearing.

(2) A "limited-English-speaking person" means a person who because of a non-English-speaking cultural background cannot readily speak or understand the English language.

(3) If a hearing impaired person or a limited-English-speaking person is involved in an adjudicative proceeding and a need for an interpreter is made known to the office of professional standards, the presiding officer shall appoint an interpreter who is acceptable to the parties or, if the parties are unable to agree on an interpreter, the presiding officer shall select and appoint an interpreter.

(4) Before beginning to interpret, an interpreter shall take an oath or make affirmation that:

(a) A true interpretation shall be made to the impaired person of all the proceedings in a language or in a manner the impaired person understands; and

(b) The interpreter shall repeat the statements of the impaired person to the presiding officer, in the English language, to the best of the interpreter's skill and judgment.

(5) When an interpreter is used in a proceeding:

(a) The interpreter shall translate all statements made by other participants in the proceeding;

(b) The presiding officer shall ensure sufficient extra time is provided to permit translation; and

(c) The presiding officer shall ensure that the interpreter translates the entire proceeding to the hearing impaired person or limited-English-speaking person to the extent that the person has the same opportunity to understand the statements made as would a person not requiring an interpreter.

(6) An interpreter appointed under this section shall be entitled to a reasonable fee for services, including waiting time and reimbursement for actual necessary travel expenses. The program shall pay the interpreter fee and expenses incurred for interpreters for license holders, applicants, or recipients of benefits. The party on whose behalf a witness requiring an interpreter appears shall pay for interpreter services for that witness.

(7) All proceedings shall be conducted consistent with chapters 2.42 and 2.43 RCW.

[Statutory Authority: RCW 43.70.040. 93-13-005 (Order 369), § 246-10-122, filed 6/3/93, effective 7/4/93.]

**WAC 246-10-123 Subpoenas.** (1) The presiding officer, the secretary or designee, and attorneys for parties may issue subpoenas to residents of the state of Washington, to license holders and applicants for license, and to other persons or entities subject to jurisdiction under RCW 4.28.185.

(2) The presiding officer shall issue subpoenas pursuant to RCW 34.05.446(1) for parties not represented by counsel upon request of the party and upon a showing of relevance and reasonable scope of the testimony or evidence sought. Requests for issuance of subpoenas must be made in writing to the presiding officer stating the relevance and the scope of testimony or evidence sought.

(3) The person on whose behalf the subpoena is issued shall pay any witness fees and expenses as provided in WAC 246-10-115 or costs for interpreters for such witnesses as provided in WAC 246-10-122.

(4) Attendance of persons subpoenaed and production of evidence may be required at any designated place in the state of Washington.

(5) Every subpoena shall:

- (a) Comply with WAC 246-10-120;
- (b) Identify the party causing issuance of the subpoena;
- (c) State the title of the proceeding; and

(d) Command the person to whom the subpoena is directed to attend and give testimony and/or produce designated items under the person's control at a specified time and place.

(6) A subpoena may be served by any suitable person eighteen years of age or older by:

(a) Giving a copy to the person to whom the subpoena is addressed;

(b) Leaving a copy at the residence of the person to whom the subpoena is addressed with a person of suitable age and discretion;

(c) Sending a copy by mail to the current address on file with the department if the person is licensed by the department or has filed an application for a license with the department; or

(d) Sending a copy by certified mail with proof of receipt if the person is neither licensed by nor has applied for a license with the department.

(7) Proof of service may be made by:

(a) Affidavit of personal service;

(b) Certification by the person mailing the subpoena to a license holder or applicant; or

(c) Return or acknowledgment showing receipt by the person subpoenaed or his/her representative. Any person accepting certified or registered mail at the last known address of the person subpoenaed shall be considered an authorized representative.

(8) The presiding officer, upon motion made promptly and before the time specified for compliance in the subpoena, may:

(a) Quash or modify the subpoena if the subpoena is unreasonable or requires evidence not relevant to any matter at issue; or

(b) Condition denial of the motion upon just and reasonable conditions, including advancement of the reasonable cost by the person on whose behalf the subpoena is issued of producing the books, documents, or tangible things; or

(c) Issue a protective order under RCW 34.05.446.

(9) The department may seek enforcement of a subpoena under RCW 34.05.588(1) or proceed in default pursuant to WAC 246-10-204.

[Statutory Authority: RCW 43.70.040, 94-04-079, § 246-10-123, filed 1/31/94, effective 3/3/94; 93-13-005 (Order 369), § 246-10-123, filed 6/3/93, effective 7/4/93.]

**WAC 246-10-124 Preliminary requirements.** (1) An applicant for an initial license or renewal of an existing license shall not be entitled to an adjudicative proceeding unless the applicant has submitted:

(a) A completed initial application or renewal application, as appropriate; and

(b) All applicable application, examination, or renewal fees payable in connection with such application or license.

(2) An aggrieved applicant shall not be entitled to an adjudicative proceeding with respect to the denial of an application submitted under WAC 246-290-100, 246-290-110, 246-290-120, 246-290-130, 246-290-140, 246-291-100, 246-291-110, 246-291-120, 246-291-130, 246-291-140, or 246-295-040, unless the applicant has submitted to the district engineer or other departmental employee responsible for reviewing the submittal, a certification that, to the best of the applicant's knowledge and belief, the submittal is complete and demonstrates compliance with the state's drinking water regulations. Certification with respect to water system plans, project reports, construction documents and other submittals requiring preparational review by a licensed professional engineer shall be provided on behalf of the applicant by the licensed professional engineer preparing or reviewing the submittal. Failure to comply with these preliminary requirements shall result in the denial of the application for adjudicative proceeding without further review.

(3) An affected party shall not be entitled to an adjudicative proceeding with respect to a decision made under WAC 246-293-190 unless:

(a) Except with respect to a county legislative authority, the applicant shall have complied with all preliminary requirements established under the coordinated water system plan approved by the county legislative authority and the department or, if the critical water supply service area's external boundaries have been approved but a coordinated water system plan has not been approved and adopted, then with any interim requirements imposed by the county legislative authority; and

(b) Within sixty days of the department's receipt of the request for an adjudicative proceeding, the applicant submits copies of the complete record of all proceedings conducted under the applicable coordinated water system plan or interim requirements. If such proceedings were taped or otherwise recorded, the record submitted to the department shall include a transcript of the hearing or hearings which shall be prepared and certified as correct by a registered professional court reporter.

(c) Failure to comply with the preliminary requirements outlined herein shall result in a denial of the hearing application without further review.

(4) WAC 246-293-430.

(a) An adjudicative proceeding shall not be conducted with respect to a departmental decision made under WAC 246-293-430 unless, within sixty days of the department's receipt of the request for an adjudicative proceeding, the applicant has, at his or her own expense, submitted a transcript of the hearing conducted under WAC 246-293-430 from tapes or other record of the hearing which the department shall make available for that purpose. The transcript shall be prepared and certified as correct by a registered professional court reporter. Failure to comply with preliminary requirements established under this section shall result in the dismissal of the hearing application without further review.

(b) If a request for an adjudicative proceeding has been timely filed under this section and a transcript of the record has been timely submitted, the department shall promptly provide the presiding officer with copies of all documents

and exhibits admitted at the hearing conducted under WAC 246-293-430.

(c) The departmental employee responsible for the department's decision under WAC 246-293-430 shall provide a copy of his or her decision to the presiding officer and may submit documents or evidence not made part of the record at the hearing conducted under WAC 246-293-430. Copies of all such documents shall be provided to all other parties involved in the proceeding.

[Statutory Authority: RCW 18.130.050 and 43.70.040. 96-21-027, § 246-10-124, filed 10/7/96, effective 11/7/96. Statutory Authority: RCW 43.70.040. 94-04-079, § 246-10-124, filed 1/31/94, effective 3/3/94; 93-13-005 (Order 369), § 246-10-124, filed 6/3/93, effective 7/4/93.]

## SECTION II INITIATING ACTIONS

**WAC 246-10-201 Form and content of initiating documents.** (1) Initiating documents shall include a clear and concise statement of the:

(a) Identity and authority of the person issuing the document;

(b) Factual basis for the action or proposed action set forth in the document;

(c) Statutes and rules alleged to be at issue;

(d) Identity of the party against whom the action is taken or proposed to be taken;

(e) Action or proposed action or penalties, including the statutory or rule authority for those actions or penalties;

(f) Signature of the person issuing the document and the date signed; and

(g) Method by which an adjudicative proceeding may be requested.

(2) Initiating documents shall be accompanied by the following documents:

(a) Notice that the respondent may defend against the action or proposed action; and

(b) Form for requesting adjudicative proceeding.

(3) Initiating documents shall be served as described in WAC 246-10-109.

[Statutory Authority: RCW 43.70.040. 94-04-079, § 246-10-201, filed 1/31/94, effective 3/3/94; 93-13-005 (Order 369), § 246-10-201, filed 6/3/93, effective 7/4/93.]

**WAC 246-10-202 Amendment of initiating documents.** (1) Prior to the hearing date, initiating documents may be amended subject to the following conditions:

(a) Amended initiating documents shall meet the requirements of WAC 246-10-201(1);

(b) Amended initiating documents shall be accompanied by the documents described in WAC 246-10-201(2);

(c) Whenever amended initiating documents are issued, a new interval for response will begin, as described in WAC 246-10-203, unless the respondent requests the time periods set by the original initiating document; and

(d) Issuance of amended initiating documents ends all obligations of the parties under the prior initiating documents.

(2) On the hearing date, the initiating documents may be amended subject to the following conditions:

(a) The documents may be amended upon motion of the state;

(b) The documents may not be amended without the approval of the presiding officer; and

(c) Upon motion of a party or upon his/her own initiative, the presiding officer may grant a continuance on all or part of the matter if necessary to afford the respondent an opportunity to prepare a defense to the amended documents.

[Statutory Authority: RCW 43.70.040. 94-04-079, § 246-10-202, filed 1/31/94, effective 3/3/94; 93-13-005 (Order 369), § 246-10-202, filed 6/3/93, effective 7/4/93.]

**WAC 246-10-203 Request for adjudicative proceeding.** A respondent may respond to an initiating document by filing an application for an adjudicative proceeding or by waiving the opportunity for adjudicative proceeding.

(1) If the respondent wishes to file an application for an adjudicative proceeding:

(a) An application for adjudicative proceeding must be filed in accordance with the following time periods:

(i) For matters under chapter 18.130 RCW, the Uniform Disciplinary Act, within twenty days of service of the initiating documents unless an extension has been granted as provided in subsection (3) of this section; and

(ii) For all other matters in which the program proposes to deny, suspend, revoke or modify a license or proposes to impose a civil fine, within twenty-eight days of receipt of the initiating documents, unless otherwise provided by statute; and

(iii) For all other matters, within twenty days of service of the initiating documents, unless otherwise provided by statute.

(b) The application for adjudicative proceeding shall be made either on the Request for Adjudicative Proceeding Form accompanying the initiating documents or by a written document containing at least the following information:

(i) Name and address of the party requesting an adjudicative proceeding;

(ii) Name and address of the attorney representing the party, if any;

(iii) Identification of the portion or portions of the initiating documents contested;

(iv) Summary of the party's position on the portion or portions contested;

(v) Statement of the party's standing to request an adjudicative proceeding under WAC 246-10-107; and

(vi) For matters not under chapter 18.130 RCW and in which the department proposes to deny, suspend, revoke or modify a license or proposes to impose a civil fine, the application shall include a copy of the initiating document containing the adverse notice.

(c) By filing a request for adjudicative proceeding, the responding party agrees to appear personally at the adjudicative proceeding or, if otherwise approved by the presiding officer, by telephone, unless appearance is waived as authorized in WAC 246-10-104(4).

(d) The application for adjudicative proceeding shall contain a response to the initiating documents, indicating whether each charge is admitted, denied, or not contested, and responses shall be subject to the following conditions:



(i) Once admitted or not contested, an allegation may not be denied; and

(ii) An allegation denied or not contested may later be admitted.

(e) When an allegation is admitted or not contested, it shall be conclusively deemed to be true for all further proceedings. No proof of the allegation need be submitted.

(f) The application for adjudicative proceeding shall specify the representative, if any, designated pursuant to WAC 246-10-108 and any request for interpreter. The responding party shall amend the name of the representative and need for interpreter immediately if circumstances change prior to the hearing.

(g) The application for adjudicative proceeding shall be filed at the office of professional standards at the address specified in WAC 246-10-102.

(2) A respondent may waive an adjudicative proceeding and submit a written statement and other documents in defense or in mitigation of the charges. Such waiver and documents shall be filed:

(a) In accordance with the timelines in subsection (1)(a) of this section; and

(b) At the address indicated in subsection (1)(g) of this section.

(3) For matters under RCW 18.130.180, if the twenty-day limit for filing an application for adjudicative proceeding results in a hardship to the respondent, the respondent may request an extension of not more than sixty days upon a showing of good cause.

(a) The request for extension shall be filed within the twenty day limit and shall include:

(i) The reason for the request and the number of days for which the extension is requested; and

(ii) Documentation of the circumstances creating the hardship.

(b) The request shall be granted for a period not to exceed sixty days upon showing of:

(i) Illness of the respondent; or

(ii) Absence of the respondent from the county of residence or employment; or

(iii) Emergency in the respondent's family; or

(iv) Other good cause as determined by the presiding officer.

(c) If a request for extension is denied, the respondent shall have ten days from service of the order denying the extension or twenty days from service of the initiating documents, whichever is longer, to file an application for adjudicative proceeding.

[Statutory Authority: RCW 43.70.040, 94-04-079, § 246-10-203, filed 1/31/94, effective 3/3/94; 93-13-005 (Order 369), § 246-10-203, filed 6/3/93, effective 7/4/93.]

**WAC 246-10-204 Default.** (1) If a party fails to respond to initiating documents according to WAC 246-10-203, that party will be deemed to have waived the right to a hearing, and the secretary shall enter a final order without further contact with that party.

(2) If a party requests an adjudicative proceeding but fails to appear, without leave to do so, at a scheduled prehearing conference, the presiding officer may issue an order of default. The order shall include notice of opportu-

nity to request that the default order be vacated pursuant to RCW 34.05.440(3). Unless vacated, a default order under this subsection shall be grounds for the presiding officer to proceed to decide the matter in the absence of the respondent and without additional notice to the respondent and to issue a final order.

(3) If a party requests an adjudicative proceeding but fails to appear at the hearing, the presiding officer may issue an order of default in the same manner as subsection (2) of this section, or may proceed to hear the matter in the absence of the party and issue a final order.

(4) Final orders entered under this section shall meet the requirements of WAC 246-10-702 and shall contain:

(a) Findings of fact and conclusions of law based upon prima facie proof of the allegations contained in the initiating documents;

(b) Proof of service of or a good faith attempt to serve initiating documents and appropriate notices;

(c) A finding that there is no reason to believe that the party in default is in active military service;

(d) The penalties or conditions imposed by the order; and

(e) Notice of the opportunity to request reconsideration pursuant to RCW 34.05.470.

(5) Final and default orders entered under this section shall be served upon the parties in accordance with WAC 246-10-109.

(6) Notwithstanding subsections (1) through (5) of this section, if a party fails to respond to an initiating document issued consistent with the requirements of RCW 43.70.095 or 43.70.115, the initiating document shall become a final order upon its effective date unless the initiating document otherwise provides.

[Statutory Authority: RCW 18.130.050 and 43.70.040. '96-21-027, § 246-10-204, filed 10/7/96, effective 11/7/96. Statutory Authority: RCW 43.70.040, 94-04-079, § 246-10-204, filed 1/31/94, effective 3/3/94; 93-13-005 (Order 369), § 246-10-204, filed 6/3/93, effective 7/4/93.]

**WAC 246-10-205 Scheduling orders.** (1) Within thirty days after receipt of the application for adjudicative proceeding, the office of professional standards shall:

(a) Approve the application for full adjudicative procedure and issue and serve on the parties a scheduling order specifying the course of the proceeding; or

(b) Approve the application for a brief adjudicative procedure and issue and serve a notice of the date by which any additional written materials are to be submitted for consideration; or

(c) Deny the application according to RCW 34.05.416.

(2) For matters under chapter 18.130 RCW, the scheduling order shall contain:

(a) The date, time, and place of a settlement conference, a prehearing conference, and the hearing;

(b) The deadlines for completion of discovery and submission of prehearing motions; and

(c) The name, address, and telephone number of the assistant attorney general or other department representative who will represent the state in the matter.

(3) The scheduling order may be modified by order of the presiding officer upon his/her own initiative or upon motion of a party. Any request for a change in the schedul-

ing order shall be made by motion as provided in WAC 246-10-403.

(4) The presiding officer may waive establishing dates for the settlement conference, completion of discovery, submission of prehearing motions, and the prehearing conference, if, in the discretion of the presiding officer, those proceedings are not necessary or appropriate in a particular matter or type of case. However, either party may request by motion to the presiding officer that any or all of the dates be set.

(5) Dates contained in the scheduling order may be changed by the office of professional standards upon written request of either party made within fifteen days of issuance of the first scheduling order. All other changes must be made by motion pursuant to WAC 246-10-403.

[Statutory Authority: RCW 43.70.040. 94-04-079, § 246-10-205, filed 1/31/94, effective 3/3/94; 93-13-005 (Order 369), § 246-10-205, filed 6/3/93, effective 7/4/93.]

### SECTION III EMERGENCY ADJUDICATIVE PROCEEDINGS

**WAC 246-10-301 Conduct of emergency adjudicative proceedings.** (1) Summary action may be taken only after a review by the secretary or designee of such evidence, including affidavits, if appropriate, to establish:

(a) The existence of an immediate danger to the public health, safety, or welfare;

(b) The department's ability to address the danger through a summary action; and

(c) The summary action necessary to address the danger.

(2) No notice to any person potentially affected by a summary action shall be required prior to issuance of a summary action.

[Statutory Authority: RCW 43.70.040. 93-13-005 (Order 369), § 246-10-301, filed 6/3/93, effective 7/4/93.]

**WAC 246-10-302 Effect of summary action.** (1) Summary action takes effect upon entry of the order. Entry shall be the date of signature unless otherwise specified.

(2) No person shall be required to comply with a summary action until service has been made or the person has knowledge of the order, whichever occurs first.

(3) A summary action shall be served as promptly as practicable, in accordance with WAC 246-10-109.

(4) A summary action shall not be subject to the posthearing process provided in WAC 246-10-701, et seq., but a summary action may be appealed to superior court as provided by law.

[Statutory Authority: RCW 43.70.040. 93-13-005 (Order 369), § 246-10-302, filed 6/3/93, effective 7/4/93.]

**WAC 246-10-303 Form and content of summary actions.** (1) A summary action shall be entered in the form of an order containing findings of fact, conclusions of law, and the summary action imposed, as well as a statement of policy reasons for the decision.

(2) A summary action imposed by emergency adjudicative proceeding shall be limited to those actions necessary to alleviate an immediate danger to the public health, safety, or welfare.

[Title 246 WAC—page 50]

(3) Initiating documents, and all other documents required by WAC 246-10-201, shall accompany a summary action order when served.

[Statutory Authority: RCW 43.70.040. 93-13-005 (Order 369), § 246-10-303, filed 6/3/93, effective 7/4/93.]

**WAC 246-10-304 Adjudicative proceedings upon summary action.** Following summary action taken by the department, the respondent may:

(1) Request a prompt adjudicative proceeding conducted in accordance with this chapter; or

(2) Waive the prompt adjudicative proceeding and request a regularly scheduled adjudicative proceeding conducted in accordance with this chapter;

(3) Waive the right to an adjudicative proceeding and submit a written statement to be considered prior to the entry of the final order; or

(4) Waive the opportunity to be heard.

[Statutory Authority: RCW 43.70.040. 94-04-079, § 246-10-304, filed 1/31/94, effective 3/3/94; 93-13-005 (Order 369), § 246-10-304, filed 6/3/93, effective 7/4/93.]

**WAC 246-10-305 Opportunity for prompt adjudicative proceeding.** (1) Any respondent affected by a summary action shall be provided the opportunity to request a prompt adjudicative proceeding. Notice of the opportunity shall be provided in the notice of opportunity to defend against the allegations that are the basis for the summary action. The form for requesting an adjudicative proceeding shall include the option of requesting a prompt adjudicative proceeding.

(2) Any respondent affected by a summary action may request a prompt adjudicative proceeding, may elect a regularly scheduled adjudicative proceeding instead of a prompt adjudicative proceeding, or may waive the opportunity for adjudicative proceeding in accordance with WAC 246-10-203.

(3) Any request for a prompt adjudicative proceeding must be filed within ten days of the service of the summary action.

(4) If requested by the respondent, a prompt adjudicative proceeding shall be conducted within twenty days of service of a summary action.

(5) Regardless of whether a prompt adjudicative proceeding is requested, the matter shall be resolved as quickly as feasible in accordance with all other applicable rules.

[Statutory Authority: RCW 43.70.040. 94-04-079, § 246-10-305, filed 1/31/94, effective 3/3/94; 93-13-005 (Order 369), § 246-10-305, filed 6/3/93, effective 7/4/93.]

**WAC 246-10-306 Proceedings prior to prompt adjudicative proceeding.** A settlement conference may be requested, a settlement may be offered, and a prehearing conference may be conducted prior to a prompt adjudicative proceeding. Prehearing proceedings shall not delay a prompt adjudicative proceeding except by mutual agreement of the parties.

[Statutory Authority: RCW 43.70.040. 93-13-005 (Order 369), § 246-10-306, filed 6/3/93, effective 7/4/93.]

#### SECTION IV SETTLEMENT AND PREHEARING PROCEEDINGS

**WAC 246-10-401 Settlement conference.** (1) Following a request for an adjudicative proceeding, the office of professional standards may schedule a settlement conference as provided in WAC 246-10-205. The parties shall be notified of the date, time, and place of the settlement conference.

(2) The purpose of the settlement conference shall be to attempt to reach agreement on the issues and on a proposed order to be entered. Any agreement of the parties is subject to final approval by the presiding officer.

(3) The respondent shall attend the settlement conference as scheduled and may also be represented as provided in WAC 246-10-108. Representatives of the department will also attend. Other persons may attend by agreement of the parties.

(4) Either party may bring documents or other materials to the settlement conference for the purpose of settlement negotiations. No testimony will be taken. No documents or information submitted at the settlement conference will be admitted at the adjudicative proceeding unless stipulated by the parties or otherwise admitted into evidence by the presiding officer.

(5) If a settlement offer has been made in writing to the respondent and it is signed and returned by the respondent to the office of professional standards prior to the settlement conference, all subsequent dates set in the scheduling order are continued pending final review of the settlement by the presiding officer.

[Statutory Authority: RCW 43.70.040, 94-04-079, § 246-10-401, filed 1/31/94, effective 3/3/94; 93-13-005 (Order 369), § 246-10-401, filed 6/3/93, effective 7/4/93.]

**WAC 246-10-402 Discovery.** The parties are encouraged to exchange information and documents related to the case prior to the adjudicative proceeding. Formal discovery is obtained as follows:

(1) Methods, scope and limits:

(a) Parties may obtain discovery by production of records or things; deposition upon oral examination; requests for admission; or, if ordered by the presiding officer, written interrogatories.

(b) Unless otherwise limited by order of the presiding officer in accord with these rules, the scope of discovery shall be as follows:

(i) Parties may obtain discovery regarding any matter not privileged, which is relevant to the subject matter in the pending action. It is not grounds for objection that the information sought will be inadmissible at the adjudicative proceeding if the information sought appears reasonably calculated to lead to the discovery of admissible evidence.

(ii) The frequency or extent of use of the discovery methods set forth in these rules shall be limited by the presiding officer if the presiding officer determines that:

(A) The discovery sought is unreasonably cumulative or duplicative, or is obtainable from another source that is more convenient, less burdensome, or less expensive; or

(B) The party seeking discovery has had an ample opportunity by discovery to obtain the information sought; or

(C) The discovery is unduly burdensome or expensive, taking into account the needs of the case, limitations of the parties' resources, and the importance of the issues at stake.

(iii) The presiding officer may limit discovery upon his or her own initiative after reasonable notice or pursuant to a motion submitted by a party.

(2) Production of records, documents or things:

(a) Upon written request of a party the opposing party shall identify experts and other witnesses to be called at a hearing and shall provide other information necessary to enable the party to conduct depositions of the witnesses.

(b) Any party may serve on any other party a request, which must be signed by the party or designated representative:

(i) To produce and permit the party making the request or designee to inspect and copy any designated documents, or to inspect and copy, test, or sample any tangible things which constitute or contain matters within the scope of discovery and which are in the possession, custody or control of the party upon whom the request is served; or

(ii) To permit entry onto designated land or other property which is in the possession or control of the party upon whom the request is served for the purpose of inspection, measuring, surveying, photographing, testing or sampling the property or designated object or operation thereon which is within the scope of discovery.

(c) Any party who produces documents for inspection shall produce them as they are kept in the usual course of business or may, if the parties agree, organize and label them to correspond with the categories in the request.

(d) The party upon whom a request is made may, by motion to the presiding officer, move for an order denying the request to produce or modifying the conditions of the request. Denial of the request or change in the conditions of the request shall be within the discretion of the presiding officer and shall be made by written order.

(3) Depositions may be taken subject to the following conditions:

(a) Within the United States or a territory or insular possession subject to the dominion of the United States, depositions shall be taken before an officer authorized to administer oaths by the state of Washington or of the place where the examination is held. A presiding officer may, in his or her discretion or following motion of a party, preside at the deposition. Within a foreign country, depositions shall be taken before a secretary of an embassy or legation, consul general, vice-consul or consular agent of the United States, or a person designated by the presiding officer or agreed upon by the parties by stipulation in writing filed with the office of professional standards. Except by stipulation, no deposition shall be taken before any person who is a party or a privy of a party, or a privy of any representative of a party, or who is financially interested in the proceeding.

(b) A party desiring to take the deposition of a person upon oral examination shall give reasonable notice of not less than five days in writing to the person to be deposed and to the opposing party. The notice shall state the time and place for taking the deposition, the name and address of each person to be examined, if known, and if the name is not

known, a description sufficient to identify the person to be examined or the particular class or group to which the person to be examined belongs. On motion of a party upon whom the notice is served, the presiding officer may for cause shown, lengthen or shorten the time.

(c) After notice is served for taking a deposition, or upon motion of the presiding officer or upon motion reasonably made by any party or by the person to be examined, and upon notice and for good cause, the presiding officer may issue an order that the deposition shall not be taken or that it be taken subject to specified restrictions, conditions, or limitations.

(d) Depositions shall be recorded.

(i) The officer before whom the deposition is taken shall put the witness on oath or affirmation and shall personally or by someone acting under the officer's direction and in the officer's presence, record the testimony.

(ii) The officer or person acting under the officer's direction shall transcribe the testimony at the request of any party, provided that any expenses shall be paid by the requesting party.

(iii) The transcribed testimony shall be submitted to the person deposed for review and signature, unless review and signature are waived by that person. The officer shall append to the transcript any changes in form or substance that may be submitted by the parties.

(iv) Copies of the transcribed and, unless review and signature has been waived, signed testimony shall be served upon the person deposed and upon the parties.

(e) If the parties so stipulate in writing or on the record, depositions may be taken before any person, at any time or place, upon any notice, and in any manner and when so taken, may be used as any other deposition.

(4) Following motion of a party and opportunity for response by the opposing party, the presiding officer may order a party to respond to written interrogatories and may order that the interrogatories be subject to specified restriction, condition, or limitation.

[Statutory Authority: RCW 43.70.040, 94-04-079, § 246-10-402, filed 1/31/94, effective 3/3/94; 93-13-005 (Order 369), § 246-10-402, filed 6/3/93, effective 7/4/93.]

**WAC 246-10-403 Motions.** (1) The presiding officer shall rule on motions. The presiding officer may rule on motions without oral argument or may request or permit the parties to argue the motion in person or by telephone. Oral argument may be limited in time at the discretion of the presiding officer.

(2) All prehearing motions, including discovery and evidentiary motions, shall be made in writing and filed with the presiding officer prior to the dates set in the scheduling order.

(3) Motions for continuance must be made in writing and filed prior to the dates set in the scheduling order. If the adjudicative proceeding is scheduled to take place fewer than twenty days from service of the scheduling order, motions for continuance must be made within ten days of service of the scheduling order, but in no event fewer than five days prior to the hearing. Continuances may be granted by the presiding officer for good cause.

(4) The presiding officer may grant a continuance when a motion for continuance is not submitted within the time limits contained in subsection (3) of this section for good cause.

(5) The following is the recommended format for motions:

(a) A succinct statement of the facts contended to be material;

(b) A concise statement of the issue, issues or law upon which the presiding officer is requested to rule;

(c) The specific relief requested by the moving party;

(d) If the motion requires the consideration of facts or evidence not appearing on the record, the moving party shall also serve and file copies of all affidavits and photographic or documentary evidence presented in support of the motion;

(e) The legal authority upon which the motion is based; and

(f) A proposed order may accompany the motion, and should contain findings of fact and conclusions of law.

(6) The moving party shall file the motion, and the accompanying affidavits and photographic or documentary evidence when necessary, with the presiding officer and shall serve the motion, and the accompanying affidavits and photographic or documentary evidence when necessary, on all other parties.

(7) The opposing party shall file with the presiding officer, and serve upon the moving party, a responsive memorandum, and accompanying affidavits and photographic or documentary evidence when necessary, no later than eleven days following service of the motion, unless otherwise ordered by the presiding officer.

(8) The moving party may file with the presiding officer, and serve upon the opposing party, a reply memorandum no later than five days following service of the responsive memorandum, unless otherwise ordered by the presiding officer.

(9) Unless otherwise ordered by the presiding officer, all motions shall be decided without oral argument. A party requesting oral argument on a motion shall so indicate by typing "ORAL ARGUMENT REQUESTED" in the caption of the motion or the responsive memorandum. If a request for oral argument is granted, the presiding officer shall notify the parties of the date and time of the argument and whether the argument will be in person or by telephone conference.

(10) Motions to shorten time or emergency motions shall be exceptions to the rule, and a party may only make such motions in exigent or exceptional circumstances. When making such a motion, the moving party shall:

(a) Suggest a date and time when the moving party seeks to have the presiding officer hear the motion to shorten time, which should be at least forty-eight hours after filing;

(b) Suggest a date and time when the moving party seeks to have the presiding officer consider the merits of the underlying motion;

(c) Describe the exigent or exceptional circumstances justifying shortening of time in an affidavit or a memorandum accompanying the motion;

(d) Certify that the motion to shorten time and the underlying motion have been served on all other parties prior to the filing of the motion with the presiding officer. Any opposition to the motion to shorten time must be served and filed within twenty-four hours of the service of the motion.

If the presiding officer grants the motion to shorten time, the presiding officer shall notify the parties of the date by which the responsive memorandum to the underlying motion shall be served and filed.

(11) All motions will be decided as soon as practical, but not more than thirty days following the filing of the motion. If the presiding officer will not decide the motion within this time, the presiding officer shall notify the parties in writing of the date by which the motion will be decided.

(12) If a party serves a motion or responsive memorandum by mail, pursuant to WAC 246-10-109, then three days shall be added to the time within which the opposing party must file and serve the responsive or reply memorandum.

(13) All computations of time shall be calculated pursuant to WAC 246-10-105.

(14) Departmental motions for summary actions are exempted from all requirements of this rule.

[Statutory Authority: RCW 18.130.050 and 43.70.040. 96-21-027, § 246-10-403, filed 10/7/96, effective 11/7/96. Statutory Authority: RCW 43.70.040. 94-04-079, § 246-10-403, filed 1/31/94, effective 3/3/94; 93-13-005 (Order 369), § 246-10-403, filed 6/3/93, effective 7/4/93.]

**WAC 246-10-404 Prehearing conference.** (1) As provided in WAC 246-10-205, the presiding officer may schedule a prehearing conference to be held prior to the hearing. Parties shall be notified of the time and place of the first prehearing conference in the scheduling order.

(2) The presiding officer shall conduct prehearing conferences and shall issue rulings related to prehearing motions and evidentiary issues. The rulings shall govern the conduct of subsequent proceedings.

(3) The prehearing conference may be recorded as ordered by the presiding officer. All offers of proof and objections concerning matters raised at the prehearing conference must be made on the record at the prehearing conference.

(4) Following the final prehearing conference, the presiding officer shall issue a written prehearing order which will:

(a) Identify the issues to be considered at the hearing and indicate which party has the burden of proof on these issues;

(b) Specify the facts which are admitted or not contested by the parties;

(c) Identify those documents and exhibits that will be admitted at hearing;

(d) Identify expert and lay witnesses that may be called at hearing and the issues to which those witnesses may testify;

(e) Rule on motions;

(f) Accept amendments to the pleadings;

(g) Address such other issues or matters as may be reasonably anticipated to arise and which may aid in the disposition of the proceedings; and

(h) Rule on objections made in any preserved testimony.

(5) Following the prehearing conference, the presiding officer may issue an order directing that the matter be heard as a brief adjudicative proceeding, pursuant to WAC 246-10-501, et seq.

(6) Documentary evidence not offered in the prehearing conference shall not be received into evidence at the adjudicative proceeding in the absence of a clear showing that the

offering party had good cause for failing to produce the evidence at the prehearing conference.

(7) Witnesses not identified during the prehearing conference shall not be allowed to testify at the adjudicative proceeding in the absence of a clear showing that the party offering the testimony of such witness had good cause for failing to identify the witness at the prehearing conference.

(8) If the authenticity of documents submitted at the prehearing conference is not challenged at the prehearing conference, the documents shall be deemed authentic. However, a party shall be permitted to challenge such authenticity at a later time upon a clear showing of good cause for failure to object at the prehearing conference.

(9) Nothing in these rules shall prohibit the presiding officer from conducting a conference at any time, including during the hearing. The presiding officer shall state on the record the results of such conference.

(10) A party bound by a stipulation or admission of record may withdraw it in whole or in part only upon a determination by the presiding officer or hearing officer that:

(a) The stipulation or admission was made inadvertently or as a bona fide mistake of fact or law; and

(b) The withdrawal will not unjustly prejudice the rights of the other parties.

(11) In an appeal to superior court involving issues addressed in the prehearing order, the record of the prehearing conference, written motions and responses, the prehearing order, and any orders issued by the presiding officer pursuant to WAC 246-10-403, shall be the record.

[Statutory Authority: RCW 43.70.040. 94-04-079, § 246-10-404, filed 1/31/94, effective 3/3/94; 93-13-005 (Order 369), § 246-10-404, filed 6/3/93, effective 7/4/93.]

**WAC 246-10-405 Protective orders.** The presiding officer may issue a protective order at his or her discretion:

(1) To protect a party or person from annoyance, embarrassment, oppression, or undue burden or expense;

(2) To preserve confidentiality related to health care records or provider-client information;

(3) To protect examination processes;

(4) To protect the identity of a person supplying information to the department where the person indicates a desire for nondisclosure unless that person testifies or has been called to testify at an adjudicative proceeding; or

(5) To comply with applicable state or federal law.

[Statutory Authority: RCW 43.70.040. 93-13-005 (Order 369), § 246-10-405, filed 6/3/93, effective 7/4/93.]

## SECTION V BRIEF ADJUDICATIVE PROCEEDINGS

**WAC 246-10-501 Application of brief adjudicative proceedings.** (1) If an adjudicative proceeding is requested, a brief adjudicative proceeding will be conducted where the matter involves one or more of the following:

(a) A determination whether an applicant for a professional, business, or facility license meets the minimum criteria for an unrestricted license and the department proposes to deny such a license or to issue a restricted license;

(b) An application to approve a water system plan under WAC 246-290-100;

(c) An application to approve a project report under WAC 246-290-110;

(d) An application for source approval under WAC 246-290-130;

(e) An application to approve construction documents under WAC 246-290-120;

(f) An application to approve an existing Group A water system under WAC 246-290-140;

(g) An application for source approval under WAC 246-291-100 or 246-291-110;

(h) An application to approve a design report under WAC 246-291-120;

(i) An application to approve an existing Group B water system under WAC 246-291-130;

(j) An application to approve a water system plan under WAC 246-291-140;

(k) A decision under WAC 246-293-190;

(l) A decision with respect to service area conflicts under WAC 246-293-430;

(m) An application for approval as a satellite management agency under WAC 246-295-040;

(n) A civil penalty imposed under RCW 70.119A.040 when the amount of the civil penalty does not exceed two thousand five hundred dollars;

(o) A request to bank nursing home beds under RCW 70.38.111(8) and 70.38.115(13);

(p) A determination as to whether a person is in compliance with the terms and conditions of a final order previously issued by the department;

(q) Any approval of a school or curriculum when such approval by the department is required or authorized by statute or rule;

(r) A determination whether a license holder requesting renewal has submitted all required information and meets minimum criteria for license renewal; or

(s) A decision to deny, modify, or impose conditions upon an operating permit under WAC 246-294-050.

(2) If an adjudicative proceeding is requested, in a matter not listed in subsection (1) of this section, a brief adjudicative proceeding may be conducted in the discretion of the presiding officer when it appears that protection of the public interest does not require that the department provide notice and an opportunity to participate to persons other than the parties and:

(a) Only legal issues exist; or

(b) Both parties have agreed to a brief proceeding.

[Statutory Authority: RCW 18.130.050 and 43.70.040. 96-21-027, § 246-10-501, filed 10/7/96, effective 11/7/96. Statutory Authority: RCW 43.70.040. 94-04-079, § 246-10-501, filed 1/31/94, effective 3/3/94; 93-13-005 (Order 369), § 246-10-501, filed 6/3/93, effective 7/4/93.]

**WAC 246-10-502 Preliminary record in brief adjudicative proceedings.** (1) The preliminary record with respect to an application for a professional, business, or facility license, or for approval of a school or curriculum shall consist of the following:

(a) The application for the license or approval and all associated documents;

(b) All documents relied on by the program in proposing to deny the application;

(c) All correspondence between the applicant for license or approval and the program regarding the application.

(2) Preliminary record.

(a) The preliminary record with respect to decisions made under WAC 246-290-100, 246-290-110, 246-290-120, 246-290-130, 246-290-140, 246-291-100, 246-291-110, 246-291-120, 246-291-130, and 246-291-140 shall consist of the decision document, all documents constituting the applicant's submittal and such other documents as the applicant or the departmental employee reviewing the submittal may wish to include in the preliminary record.

(b) WAC 246-293-190.

(i) If proceedings are required and have been conducted by local agencies under the applicable coordinated water system plan, the preliminary record shall consist of the record submitted to the department under WAC 246-10-124(3).

(ii) If hearings are not required or have not been conducted by local agencies under the applicable coordinated water system plan or if the external boundaries of the coordination act area have been approved but a coordinated water system plan has not been adopted, then the preliminary record shall consist of such documents as the presiding officer may solicit from the affected parties.

(c) The preliminary record with respect to a decision made under WAC 246-293-430 shall consist of the record submitted to the presiding officer under WAC 246-10-124(4).

(d) The preliminary record with respect to a decision under WAC 246-294-050 shall consist of:

(i) The permit, if any;

(ii) All documents relied upon by the program in proposing to deny, modify, or impose conditions upon the permit; and

(iii) The decision document.

(e) The preliminary record with respect to decisions made under WAC 246-295-040 shall consist of the decision document, all documents constituting the applicant's submittal, comments submitted by the county, and such other documents as the applicant or the department may wish to include in the preliminary record.

(f) The preliminary record with respect to civil penalties imposed under RCW 70.119A.040 shall consist of the notice of imposition of penalties, the departmental order, if any, all documentation of communication between the program and the person or persons incurring the civil penalties regarding the violation or violations for which the civil penalties were imposed, and such other documents as the person or persons incurring the civil penalties or the department may wish to include in the preliminary record.

(3) The preliminary record with respect to compliance with prior department orders shall consist of:

(a) The official department file of the proceeding in which the order was issued;

(b) All matters submitted by the person to whom the order is directed purporting to demonstrate compliance with the order;

(c) All documents relied on by the department in asserting noncompliance; and

(d) All correspondence between the department and the person to whom the order is directed respecting compliance.



(4) The preliminary record with respect to matters submitted to a brief adjudicative proceeding under WAC 246-10-501(2) shall be as agreed by the parties.

(5) For the purposes of this section, "decision document" shall mean one or more documents that provide notice to the affected party of the department's action, and that contain(s) the information provided by an initiating document.

[Statutory Authority: RCW 18.130.050 and 43.70.040. 96-21-027, § 246-10-502, filed 10/7/96, effective 11/7/96. Statutory Authority: RCW 43.70.040. 94-04-079, § 246-10-502, filed 1/31/94, effective 3/3/94; 93-13-005 (Order 369), § 246-10-502, filed 6/3/93, effective 7/4/93.]

**WAC 246-10-503 Conduct of brief adjudicative proceedings.** (1) Brief adjudicative proceedings shall be conducted by a presiding officer for brief adjudicative proceedings designated by the assistant secretary having responsibility for the program that issued the initiating document that is the subject of the proceeding. The presiding officer for brief adjudicative proceedings shall have agency expertise in the subject matter but shall not have personally participated in the decision to issue the initiating document.

(2) The parties or their representatives may present written documentation in addition to the preliminary record. The presiding officer for brief adjudicative proceedings shall designate the date by which written documents must be submitted by the parties.

(3) The presiding officer for brief adjudicative proceedings may, in his or her discretion, entertain oral argument from the parties or their representatives, at a time and place designated by the presiding officer for brief adjudicative proceedings.

(4) No witnesses may appear to testify.

(5) In addition to the record, the presiding officer for brief adjudicative proceedings may employ agency expertise as a basis for decision.

(6) The presiding officer for brief adjudicative proceedings shall not issue an oral order. Within ten days of the final date for submission of materials or oral argument, if any, the presiding officer for brief adjudicative proceedings shall enter an initial order in accordance with WAC 246-10-608.

[Statutory Authority: RCW 18.130.050 and 43.70.040. 96-21-027, § 246-10-503, filed 10/7/96, effective 11/7/96. Statutory Authority: RCW 43.70.040. 94-04-079, § 246-10-503, filed 1/31/94, effective 3/3/94; 93-13-005 (Order 369), § 246-10-503, filed 6/3/93, effective 7/4/93.]

**WAC 246-10-504 Effectiveness of orders on brief adjudicative proceedings.** (1) Initial orders on brief adjudicative proceedings shall become final twenty-one days after service of the initial order unless:

(a) Administrative review has been requested pursuant to WAC 246-10-701; or

(b) On his or her own initiative, a designee of the secretary authorized to issue final orders determines to review the matter and, within twenty-one days of service of the initial order, provides notice to the parties of the date by which a determination shall be made.

(2) If administrative review is taken under subsection (1) of this section, each party shall be provided an opportunity to state its view of the matter, and the presiding officer

shall issue a written order containing findings of fact, conclusions of law, and order which shall be entered and served upon the parties within twenty days of service of the initial order or the request for review whichever is later.

(3) A request for review is deemed to be denied if the presiding officer does not act on the request within twenty days after the request is submitted.

(4) If administrative review is taken under subsection (1) of this section, the presiding officer may convert the matter to a full adjudicative proceeding.

[Statutory Authority: RCW 43.70.040. 94-04-079, § 246-10-504, filed 1/31/94, effective 3/3/94; 93-13-005 (Order 369), § 246-10-504, filed 6/3/93, effective 7/4/93.]

**WAC 246-10-505 Agency record in brief proceedings.** The agency record of brief adjudicative proceedings shall consist of:

(1) The preliminary record as set forth in WAC 246-10-502;

(2) All initiating documents including the notice of opportunity to defend;

(3) The request for adjudicative proceeding;

(4) All documents submitted in the proceeding;

(5) Any transcript or recording of any arguments presented; and

(6) All orders issued in the case.

[Statutory Authority: RCW 43.70.040. 93-13-005 (Order 369), § 246-10-505, filed 6/3/93, effective 7/4/93.]

## SECTION VI HEARING

**WAC 246-10-601 Notice of adjudicative proceeding.** Notice of an adjudicative proceeding shall be issued pursuant to RCW 34.05.434.

[Statutory Authority: RCW 43.70.040. 93-13-005 (Order 369), § 246-10-601, filed 6/3/93, effective 7/4/93.]

**WAC 246-10-602 Conduct of adjudicative proceeding.** (1) The adjudicative proceeding shall be conducted as provided in RCW 34.05.449 through 34.05.455.

(2) The presiding officer may take the following actions to the extent not already determined in a prehearing order:

(a) Conduct the hearing de novo;

(b) Determine the order of presentation of evidence;

(c) Administer oaths and affirmations;

(d) Issue subpoenas;

(e) Rule on procedural matters, objections, motions, and offers of proof;

(f) Receive relevant evidence;

(g) Interrogate witnesses called by the parties in an impartial manner to develop any facts necessary to fairly and adequately decide the matter;

(h) Call additional witnesses and request additional exhibits deemed necessary to complete the record and receive such evidence subject to full opportunity for cross-examination and rebuttal by all parties;

(i) Take any appropriate action necessary to maintain order during the adjudicative proceeding;

(j) Determine whether to permit or require oral argument or briefs and determine the time limits for submission thereof;

(k) Permit photographic and recording equipment at hearing subject to conditions necessary to preserve confidentiality and prevent disruption;

(l) Permit a person to waive any right conferred upon that person by chapter 34.05 RCW or this chapter, except as precluded by law; and

(m) Take any other action necessary and authorized by applicable law or rule.

(3) The presiding officer shall:

(a) Apply as the first source of law governing an issue those statutes and rules deemed applicable to the issue;

(b) If there is no statute or rule governing the issue, resolve the issue on the basis of the best legal authority and reasoning available, including that found in federal and Washington constitutions, statutes, rules, and court decisions; and

(c) Not declare any statute or rule invalid.

(4) If the validity of any statute or rule is raised as an issue, the presiding officer may permit arguments to be made on the record concerning the issue for the purpose of subsequent review.

(5) A party may move to disqualify the presiding officer pursuant to RCW 34.05.425(3).

[Statutory Authority: RCW 43.70.040. 93-13-005 (Order 369), § 246-10-602, filed 6/3/93, effective 7/4/93.]

**WAC 246-10-603 Evidence.** (1) The presiding officer shall rule on objections to the admissibility of evidence pursuant to RCW 34.05.452 unless those objections have been addressed in the prehearing order.

(2) The refusal of a witness to answer any question ruled proper shall be grounds for the presiding officer, at his/her discretion, to strike some or all prior testimony by that witness on related matters or to grant a continuance to allow a party to seek a court order to compel the witness to answer.

(3) Each person called as a witness in an adjudicative proceeding shall swear or affirm that the evidence about to be given in the adjudicative proceeding shall be the truth under the provisions of RCW 5.28.020 through 5.28.060.

[Statutory Authority: RCW 43.70.040. 93-13-005 (Order 369), § 246-10-603, filed 6/3/93, effective 7/4/93.]

**WAC 246-10-604 Proposed order.** At the conclusion of the hearing or by a date specified by the presiding officer, the presiding officer may require each party to submit to the presiding officer proposed findings of fact and conclusions of law and a proposed order.

[Statutory Authority: RCW 43.70.040. 94-04-079, § 246-10-604, filed 1/31/94, effective 3/3/94; 93-13-005 (Order 369), § 246-10-604, filed 6/3/93, effective 7/4/93.]

**WAC 246-10-605 Issuance of final order.** If the adjudicative proceeding is conducted by a presiding officer authorized to make the final decision, the presiding officer shall:

(1) Issue a final order containing findings of fact and conclusions of law and an order; and

(2) Serve a copy of the order on each party and any designated representative of the party.

[Statutory Authority: RCW 43.70.040. 93-13-005 (Order 369), § 246-10-605, filed 6/3/93, effective 7/4/93.]

**WAC 246-10-606 Standard of proof.** The order shall be based on the kind of evidence upon which reasonably prudent persons are accustomed to rely in the conduct of their affairs. In all cases involving an application for license the burden shall be on the applicant to establish that the application meets all applicable criteria. In all other cases the burden is on the department to prove the alleged factual basis set forth in the initiating document. Except as otherwise provided by statute, the burden in all cases is a preponderance of the evidence.

[Statutory Authority: RCW 43.70.040. 93-13-005 (Order 369), § 246-10-606, filed 6/3/93, effective 7/4/93.]

**WAC 246-10-607 Consolidated proceedings.** (1) When two or more applications for adjudicative proceeding involve a similar issue, the applications may be consolidated by the presiding officer and the hearings conducted together. The presiding officer may consolidate on his/her own motion or upon the request of a party.

(2) A party scheduled for a consolidated proceeding may request to withdraw from the consolidated proceeding in favor of an individual proceeding. The presiding officer may grant a motion to withdraw from a consolidated proceeding at any time when good cause is shown.

(3) Each respondent in a consolidated proceeding shall retain the right to representation.

[Statutory Authority: RCW 43.70.040. 94-04-079, § 246-10-607, filed 1/31/94, effective 3/3/94; 93-13-005 (Order 369), § 246-10-607, filed 6/3/93, effective 7/4/93.]

**WAC 246-10-608 Initial order.** If the adjudicative proceeding is conducted by a presiding officer who is not authorized to make the final decision, the presiding officer shall:

(1) Issue an initial order containing proposed findings of fact, conclusions of law, and a proposed order;

(2) Serve a copy of the initial order on each party and any designated representative of a party; and

(3) Forward the initial order and record of the adjudicative proceeding to the office of professional standards.

[Statutory Authority: RCW 43.70.040. 93-13-005 (Order 369), § 246-10-608, filed 6/3/93, effective 7/4/93.]

## SECTION VII POSTHEARING PROCESS

**WAC 246-10-701 Appeal from initial order.** (1) Any party may file a written petition for administrative review of an initial order issued under WAC 246-10-503 or 246-10-608 stating the specific grounds upon which exception is taken and the relief requested.

(2) Petitions for administrative review must be served upon the opposing party and filed with the office of professional standards within twenty-one days of service of the initial order.

(3) The opposing party may file a response to a petition for administrative review filed as provided in this section. The response shall be filed at the office of professional standards. The party filing the response shall serve a copy of the response upon the party requesting administrative review. If the initial order was entered pursuant to WAC 246-10-503, the response shall be filed within ten days of service of the petition. In all other matters, the response shall be filed within twenty days of service of the petition.

[Statutory Authority: RCW 43.70.040. 94-04-079, § 246-10-701, filed 1/31/94, effective 3/3/94; 93-13-005 (Order 369), § 246-10-701, filed 6/3/93, effective 7/4/93.]

**WAC 246-10-702 Final orders.** (1) The form and content of final orders shall be as follows:

(a) Final orders shall contain findings of fact, conclusions of law, and an order, and shall be signed by the presiding officer.

(b) Final orders may adopt by reference the initial order in whole or in part.

(c) Final orders may modify or revise the initial order in whole or in part.

(2) Final orders shall be served upon the parties and their representatives as provided in WAC 246-10-109.

(3) Final orders shall be issued following:

(a) A review of the record;

(b) A review of the initial order, if any;

(c) A review of any request for administrative review of the initial order and any response thereto; and

(d) Consideration of protection of the public health and welfare.

(4) Unless a later date is stated in the final order, final orders shall be effective when entered but a party shall not be required to comply with a final order until the order is served upon that party.

(5) Final orders may contain orders that specified portions of the agency record shall not be disclosed as public records if necessary to protect privacy interests, the public welfare, or vital governmental functions. Such orders shall include but are not limited to protective orders issued during the proceeding or pursuant to WAC 246-10-405.

[Statutory Authority: RCW 43.70.040. 94-04-079, § 246-10-702, filed 1/31/94, effective 3/3/94; 93-13-005 (Order 369), § 246-10-702, filed 6/3/93, effective 7/4/93.]

**WAC 246-10-703 Stay of final orders.** No final order will be stayed except by its own terms or by order of a court of competent jurisdiction.

[Statutory Authority: RCW 43.70.040. 93-13-005 (Order 369), § 246-10-703, filed 6/3/93, effective 7/4/93.]

**WAC 246-10-704 Reconsideration of final orders.**

(1) Within ten days of service of a final order, either party may file a petition for reconsideration, stating the specific grounds upon which reconsideration is requested and the relief requested.

(2) Grounds for reconsideration shall be limited to:

(a) Specific errors of fact or law; or

(b) Implementation of the final order would require department activities inconsistent with current department practice; or

(c) Specific circumstances render the person requesting reconsideration unable to comply with the terms of the order.

(3) Petitions for reconsideration must be served upon the opposing party and filed with the office of professional standards within ten days of service of the final order.

(4) If reconsideration is requested based on an error of fact, the request for reconsideration shall contain specific reference to the record. If reconsideration is requested based on testimony of record, the request for reconsideration shall contain specific reference to the testimony. The presiding officer may require that the party requesting reconsideration submit a copy of the transcript of the adjudicative proceeding and provide specific reference to the transcript.

(5) The petition for reconsideration is denied if, within twenty days of the date the petition is filed, the presiding officer:

(a) Denies the petition;

(b) Does not act upon the petition; or

(c) Does not serve the parties with notice of the date by which he/she will act on the petition.

(6) If the presiding officer determines to act upon the petition, the opposing party shall be provided at least ten days in which to file a response to the petition.

(7) Disposition of petitions for reconsideration shall be in the form of a written order denying the petition, granting the petition, and dissolving or modifying the final order, or granting the petition and setting the matter for further proceedings.

[Statutory Authority: RCW 43.70.040. 94-04-079, § 246-10-704, filed 1/31/94, effective 3/3/94; 93-13-005 (Order 369), § 246-10-704, filed 6/3/93, effective 7/4/93.]

**WAC 246-10-705 Agency record of adjudicative proceedings.** (1) The department shall maintain an official record of each adjudicative proceeding.

(2) The record shall include:

(a) Notices of all proceedings;

(b) Any prehearing order;

(c) Any motions, pleadings, briefs, petitions, and requests filed, and rulings thereon;

(d) Evidence received or considered;

(e) A statement of matters officially noted;

(f) Offers of proof and objections and rulings thereon;

(g) Any proposed findings, requested orders, and exceptions;

(h) Any recording of the adjudicative proceeding and any transcript of all or part of the adjudicative proceeding considered before final disposition of the matter;

(i) Any final order, initial order, or order on reconsideration; and

(j) Matters placed on the record following an ex parte communication, if any.

(3) The record shall be subject to disclosure as provided by chapter 42.17 RCW, the Public Records Act, and by WAC 246-10-114, except as limited by protective orders and provisions contained in the final order.

[Statutory Authority: RCW 43.70.040. 94-04-079, § 246-10-705, filed 1/31/94, effective 3/3/94; 93-13-005 (Order 369), § 246-10-705, filed 6/3/93, effective 7/4/93.]

**WAC 246-10-706 Judicial review.** (1) Judicial review of actions taken under this chapter shall be as provided in RCW 34.05.510, et seq.

(2) Notice of the opportunity for judicial review shall be provided in all final orders.

(3) Following a petition for judicial review, the record forwarded to the reviewing court shall be those portions of the agency record designated by the parties within the time period set by the secretary.

[Statutory Authority: RCW 43.70.040. 94-04-079, § 246-10-706, filed 1/31/94, effective 3/3/94; 93-13-005 (Order 369), § 246-10-706, filed 6/3/93, effective 7/4/93.]

**WAC 246-10-707 Vacating an order for reason of default or withdrawal.** (1) A party may petition to vacate a default order entered against that party for failing to attend an adjudicative proceeding requested by that party by:

(a) Specifying the grounds relied upon in the petition; and

(b) Filing the petition at the office of professional standards within seven days of service of the default order.

(2) The presiding officer shall consider the petition and shall:

(a) Grant the motion to vacate and reinstate the application for adjudicative proceeding, and may impose conditions on licensure pending final adjudication; or

(b) Deny the motion to vacate the default order.

[Statutory Authority: RCW 43.70.040. 94-04-079, § 246-10-707, filed 1/31/94, effective 3/3/94; 93-13-005 (Order 369), § 246-10-707, filed 6/3/93, effective 7/4/93.]

## Chapter 246-11 WAC

### MODEL PROCEDURAL RULES FOR BOARDS

#### WAC

##### SECTION I PRELIMINARY MATTERS

246-11-001	Purpose and application of chapter.
246-11-010	Definitions.
246-11-020	Signature authority.
246-11-030	Appearance of parties.
246-11-040	Computation of time.
246-11-050	Notarization, certification, and authentication.
246-11-060	Current address.
246-11-070	Representation.
246-11-080	Service and filing.
246-11-090	Jurisdiction.
246-11-100	Telephone proceedings.
246-11-110	Hearing location.
246-11-120	Good faith requirement.
246-11-130	Public records.
246-11-140	Expenses and witness fees.
246-11-150	Immunity.
246-11-160	Official notice and agency expertise.
246-11-170	Sanctions.
246-11-180	Intervention.
246-11-190	Form of pleadings and orders.
246-11-200	Notice to limited-English-speaking parties.
246-11-210	Interpreters.
246-11-220	Subpoenas.
246-11-230	Presiding officer and panel members.

##### SECTION II INITIATING ACTIONS

246-11-250	Form and content of initiating documents.
246-11-260	Amendment of initiating documents.
246-11-270	Request for adjudicative proceeding.
246-11-280	Default.
246-11-290	Scheduling orders.

##### SECTION III EMERGENCY ADJUDICATIVE PROCEEDINGS

246-11-300	Conduct of emergency adjudicative proceedings.
246-11-310	Effect of summary action.
246-11-320	Form and content of summary actions.
246-11-330	Adjudicative proceedings upon summary action.
246-11-340	Opportunity for prompt adjudicative proceeding.
246-11-350	Proceedings prior to prompt adjudicative proceeding.

##### SECTION IV SETTLEMENT AND PREHEARING PROCEEDINGS

246-11-360	Settlement conference.
246-11-370	Discovery.
246-11-380	Motions.
246-11-390	Prehearing conference.
246-11-400	Protective orders.

##### SECTION V BRIEF ADJUDICATIVE PROCEEDINGS

246-11-420	Application of brief adjudicative proceedings.
246-11-425	Preliminary record in brief adjudicative proceedings.
246-11-430	Conduct of brief adjudicative proceedings.
246-11-440	Effectiveness of orders on brief adjudicative proceedings.
246-11-450	Agency record in brief proceedings.

##### SECTION VI HEARING

246-11-470	Notice of adjudicative proceeding.
246-11-480	Conduct of adjudicative proceeding.
246-11-490	Evidence.
246-11-500	Proposed order.
246-11-510	Issuance of final order.
246-11-520	Standard of proof.
246-11-530	Consolidated proceedings.
246-11-540	Initial order.

##### SECTION VII POST HEARING PROCESS

246-11-550	Appeal from initial order.
246-11-560	Final orders.
246-11-570	Stay of final orders.
246-11-580	Reconsideration of final orders.
246-11-590	Agency record of adjudicative proceedings.
246-11-600	Judicial review.
246-11-610	Vacating an order for reason of default or withdrawal.

##### SECTION I PRELIMINARY MATTERS

**WAC 246-11-001 Purpose and application of chapter.** (1) This chapter contains model rules for adjudicative proceedings authorized to be conducted under the authority of a board having disciplining authority under the Uniform Disciplinary Act, chapter 18.130 RCW. Each board may adopt these rules as contained in this chapter or as modified.

(2) This chapter, as modified and adopted by the board, shall apply to adjudicative proceedings authorized to be conducted under the authority of the board.

(3) This chapter applies to adjudicative proceedings begun on or after the effective date of this chapter in programs administered by the board. For purposes of this

section, "begun" shall mean the receipt by the appropriate office of an application for an adjudicative proceeding. These rules shall be the exclusive rules governing adjudicative proceedings under the jurisdiction of the board.

(4) To the extent that these rules differ by inclusion, deletion, or content from the model rules adopted by the chief administrative law judge pursuant to RCW 34.05.250, this chapter shall prevail in order to provide a process consistent with the organization of the department and the board.

(5) Where a provision of this chapter conflicts with another chapter of Title 246 WAC, the provision of this chapter shall prevail.

(6) Where a provision of this chapter conflicts with a provision of the Revised Code of Washington, the statute shall prevail.

[Statutory Authority: RCW 18.130.050(1), 34.05.220 and 4.24.250. 93-08-003 (Order 347), § 246-11-001, filed 3/24/93, effective 4/24/93.]

**WAC 246-11-010 Definitions.** As used in these rules of practice and procedure, the following terms shall have the meaning set forth in this section unless the context clearly indicates otherwise. Other terms shall have their ordinary meaning unless defined elsewhere in this chapter.

"Adjudicative proceeding" or "hearing" shall mean a proceeding required by statute or constitutional right and conducted under the rules of this chapter, which provides an opportunity to be heard by the board prior to the entry of a final order under this chapter.

"Board" shall mean a disciplining authority under RCW 18.130.040 (2)(b) and (3).

"Brief adjudicative proceeding" shall mean an adjudicative proceeding or hearing, the scope or conduct of which is limited as provided in this chapter.

"Department" shall mean the Washington state department of health and, where appropriate, the secretary of the Washington state department of health or the secretary's designee.

"Filing" shall mean receipt by the office of the board.

"Initiating document" shall mean a written agency document which initiates action against a license holder or applicant for license and which creates the right to an adjudicative proceeding. It may be entitled a statement of charges, notice of intent to deny, or by any other designation indicating the action or proposed action to be taken.

"License" shall have the meaning set forth in RCW 34.05.010 and includes license to practice the profession for which the board is the disciplining authority and any approval of school or curriculum required by law or rule to be obtained from the board.

"Office of professional standards" shall mean the unit whose address is:

Department of Health  
Office of Professional Standards  
2413 Pacific Avenue  
PO Box 47872  
Olympia, WA 98504-7872

"Presiding officer" shall mean the person who is assigned to conduct an adjudicative proceeding and who may either be a member of the board, an individual appointed

pursuant to RCW 18.130.095(3), or an administrative law judge employed by the office of administrative hearings.

"Presiding officer for brief adjudicative proceedings" shall mean an employee of the department authorized by the board to conduct brief adjudicative proceedings.

"Program" shall mean the administrative unit within the department responsible for implementation of that chapter of Title 18 RCW establishing the board or its powers and responsibilities.

"Prompt adjudicative proceeding" or "prompt hearing" shall mean a hearing conducted at the request of the license holder or applicant for license following summary action taken in accord with this chapter against that license holder or applicant.

"Protective order" shall mean an order issued under this chapter which limits the use of, access to, or disclosure of information or evidence.

"Respondent" shall mean a license holder or applicant for license under the jurisdiction of the board who is named in an initiating document.

"Secretary" shall mean the secretary of the department of health or his/her designee.

"Summary action" shall mean an agency action to address an immediate danger to the public health, safety, or welfare and shall include, but not be limited to, a cease and desist order, an order of summary suspension, and an order of summary restriction of a license.

[Statutory Authority: RCW 18.130.050(1) and 18.130.060(3). 94-04-078, § 246-11-010, filed 1/31/94, effective 3/3/94. Statutory Authority: RCW 18.130.050(1) and 34.05.220. 93-08-003 (Order 347), § 246-11-010, filed 3/24/93, effective 4/24/93.]

**WAC 246-11-020 Signature authority.** (1) A person designated by the board shall sign all initiating documents issued under this chapter.

(2) All final orders shall be signed by a member of the panel of board members who heard the matter.

(3) All other orders shall be signed by the presiding officer conducting the proceeding.

(4) Authority to sign shall be indicated by designation of the title of the person signing and shall not require any other affirmation, affidavit, or allegation.

[Statutory Authority: RCW 18.130.050(1) and 18.130.060(3). 94-04-078, § 246-11-020, filed 1/31/94, effective 3/3/94. Statutory Authority: RCW 18.130.050(1). 93-08-003 (Order 347), § 246-11-020, filed 3/24/93, effective 4/24/93.]

**WAC 246-11-030 Appearance of parties.** If a respondent requests an adjudicative proceeding to contest the action, that party shall appear at all stages of the proceeding except as otherwise provided in this section.

(1) If the respondent is represented as provided in this chapter, the respondent shall appear personally at the hearing and at any scheduled settlement conference but need not appear at the prehearing conference or at presentation of motions.

(2) Parties may be represented by counsel at all proceedings.

(3) The respondent may appear by telephone at any portion of the proceedings conducted by telephone, in the discretion of the presiding officer following reasonable

advance notice to the presiding officer and to the opposing party.

(4) The requirement of personal appearance may be waived for good cause in the discretion of the presiding officer.

(5) Failure to appear as provided in this chapter shall be grounds for taking final action by default.

[Statutory Authority: RCW 18.130.050(1) and 18.130.060(3). 94-04-078, § 246-11-030, filed 1/31/94, effective 3/3/94. Statutory Authority: RCW 18.130.050(1). 93-08-003 (Order 347), § 246-11-030, filed 3/24/93, effective 4/24/93.]

**WAC 246-11-040 Computation of time.** (1) When computing a period of time prescribed or allowed by an applicable statute or rule, the day of the act, event, or default from which the designated period of time begins to run shall not be included.

(2) The last day of the computed period shall be included unless the last day is a Saturday, Sunday, or legal holiday.

(3) When the last day is a Saturday, Sunday, or legal holiday, the period shall run until the end of the next day which is not a Saturday, Sunday, or legal holiday.

(4) When the period of time prescribed or allowed is seven days or less, any intermediate Saturday, Sunday, and legal holiday shall be excluded from the computation.

[Statutory Authority: RCW 18.130.050(1) and 34.05.220. 93-08-003 (Order 347), § 246-11-040, filed 3/24/93, effective 4/24/93.]

**WAC 246-11-050 Notarization, certification, and authentication.** (1) A person's sworn written statement, declaration, verification, certificate, oath, or affidavit may be authenticated by an unsworn written statement which is executed in substantially the following form:

I certify (or declare) under penalty of perjury under the laws of the state of Washington that the foregoing is true and correct.

\_\_\_\_\_  
(Date and Place)                      \_\_\_\_\_  
(Signature)

(2) Documents or records may be authenticated by a certification, as provided in subsection (1) of this section, from the custodian of the records or other qualified person that the documents or records are what they purport to be.

(3) Signature of any attorney shall be accompanied by and authenticated by that attorney's Washington State Bar Association number.

(4) Documents prepared and submitted by a party who is not represented by an attorney shall be signed and dated by that party and shall include that party's current address.

(5) Signature by a party or an attorney on a document shall constitute a certificate by the party or attorney that he/she has read the document, believes there are grounds to support it, and has not submitted the document for the purpose of delay, harassment, or needless increase in the cost of a proceeding.

(6) Compliance with certification requirements of subsections (1) and (2) of this section creates a rebuttable presumption that a document is authentic.

[Statutory Authority: RCW 18.130.050(1) and 18.130.060(3). 94-04-078, § 246-11-050, filed 1/31/94, effective 3/3/94. Statutory Authority: RCW

18.130.050(1). 93-08-003 (Order 347), § 246-11-050, filed 3/24/93, effective 4/24/93.]

**WAC 246-11-060 Current address.** Each license holder and applicant shall provide a current mailing address and all subsequent address changes to the program. Whenever service upon any such person is required by these rules, the most recent address provided may be used unless the program has actual knowledge that the person resides at a different address.

[Statutory Authority: RCW 18.130.050(1) and 18.130.060(3). 94-04-078, § 246-11-060, filed 1/31/94, effective 3/3/94. Statutory Authority: RCW 18.130.050(1). 93-08-003 (Order 347), § 246-11-060, filed 3/24/93, effective 4/24/93.]

**WAC 246-11-070 Representation.** (1) License holders, applicants for license, and recipients of benefits may be represented subject to the following conditions:

(a) A license holder or applicant for license may represent himself/herself or may be represented by an attorney who has complied with the admission to practice rules of the supreme court of the state of Washington;

(b) Every attorney representing a license holder or applicant for license shall file a notice of appearance with the board upon commencing representation, and shall file a notice of withdrawal of counsel with the board upon terminating representation.

(c) No license holder or applicant may be represented in an adjudicative proceeding by an employee of the department.

(2) No current or former employee of the department may appear as an expert, character witness, or representative of any party other than the state of Washington if he/she took an active part in investigating or evaluating the case or represented the agency in the matter, unless written permission of the secretary is granted. No current or former member of the attorney general's office staff who participated personally and substantially in investigating or evaluating the matter at issue while so employed may represent a party or otherwise participate in a related proceeding without first having obtained the written consent of the attorney general's office.

[Statutory Authority: RCW 18.130.050(1). 93-08-003 (Order 347), § 246-11-070, filed 3/24/93, effective 4/24/93.]

**WAC 246-11-080 Service and filing.** (1) A party filing a pleading, brief, or paper other than an initiating document or application for an adjudicative proceeding as required or permitted by these rules, shall serve a copy of the paper upon the opposing party or any designated representative of the opposing party prior to or simultaneous with filing.

(2) Unless otherwise provided by law, filing and service shall be made by personal service; first class, registered, or certified mail.

(3) Filing shall be complete upon actual receipt during normal business hours at the board's office, unless filing is directed in writing to be made to another address.

(4) Service shall be complete when personal service is made; mail is properly stamped, addressed, and deposited in the United States mail.



(5) Proof of service shall consist of filing as required by these rules, together with one of the following:

- (a) An acknowledgement of service;
- (b) A certificate of service including the date the papers were served, the parties upon whom served, the signature of the serving party, and a statement that service was completed by:
  - (i) Personal service; or
  - (ii) Mailing in the United States mail a copy properly addressed with postage and fees prepaid to each party and each designated representative.

[Statutory Authority: RCW 18.130.050(1) and 18.130.060(3). 94-04-078, § 246-11-080, filed 1/31/94, effective 3/3/94. Statutory Authority: RCW 18.130.050(1). 93-08-003 (Order 347), § 246-11-080, filed 3/24/93, effective 4/24/93.]

**WAC 246-11-090 Jurisdiction.** (1) The board has jurisdiction over all licenses issued by the board and over all holders of and applicants for licenses as provided in RCW 18.130.040 (2)(b) and (3). Such jurisdiction is retained even if an applicant requests to withdraw the application, or a licensee surrenders or fails to renew a license.

(2) The department has jurisdiction over unlicensed practice of any activity for which a license is required.

[Statutory Authority: RCW 18.130.050(1) and 18.130.060(3). 94-04-078, § 246-11-090, filed 1/31/94, effective 3/3/94. Statutory Authority: RCW 18.130.050(1). 93-08-003 (Order 347), § 246-11-090, filed 3/24/93, effective 4/24/93.]

**WAC 246-11-100 Telephone proceedings.** (1) The presiding officer may conduct all or part of the proceedings or permit a party or witness to appear by telephone or other electronic means if each participant in the proceedings has an opportunity to participate in, hear, and, if technically and economically feasible, see the entire proceeding while it is taking place. Cost of such appearance may be assessed to the party so appearing or on whose behalf the witness appears.

(2) If all or part of the proceedings is conducted as provided in subsection (1) of this section, the parties shall file and serve copies of all documentary evidence no less than three days prior to the proceeding. The presiding officer may, for good cause, allow exceptions to this requirement.

[Statutory Authority: RCW 18.130.050(1) and 18.130.060(3). 94-04-078, § 246-11-100, filed 1/31/94, effective 3/3/94. Statutory Authority: RCW 18.130.050(1) and 4.24.250. 93-08-003 (Order 347), § 246-11-100, filed 3/24/93, effective 4/24/93.]

**WAC 246-11-110 Hearing location.** The presiding officer shall designate sites for the conduct of proceedings taking into account accessibility, efficiency, and economy.

[Statutory Authority: RCW 18.130.050(1) and 18.130.060(3). 94-04-078, § 246-11-110, filed 1/31/94, effective 3/3/94; 93-08-003 (Order 347), § 246-11-110, filed 3/24/93, effective 4/24/93.]

**WAC 246-11-120 Good faith requirement.** Good faith shall be the standard for compliance with these rules. Failure to make a good faith effort to comply with these rules shall be grounds for sanctions as provided in this chapter.

[Statutory Authority: RCW 18.130.050(1). 93-08-003 (Order 347), § 246-11-120, filed 3/24/93, effective 4/24/93.]

**WAC 246-11-130 Public records.** (1) All papers, exhibits, transcripts, and other materials required by or submitted in accordance with this chapter shall be considered public records.

(2) Release of information on a request for public records shall be subject to the following limitations:

(a) Release of health care information shall comply with chapter 70.02 RCW and rules promulgated thereunder;

(b) Protective orders issued pursuant to WAC 246-11-400 shall prevail; and

(c) Chapter 42.17 RCW shall govern the release of records.

[Statutory Authority: RCW 18.130.050(1) and 18.130.060(3). 94-04-078, § 246-11-130, filed 1/31/94, effective 3/3/94. Statutory Authority: RCW 18.130.050(1). 93-08-003 (Order 347), § 246-11-130, filed 3/24/93, effective 4/24/93.]

**WAC 246-11-140 Expenses and witness fees.** (1) Fees and expenses shall be paid at the following rates to witnesses appearing under subpoena by the party requesting the appearance:

(a) Fees shall be paid at the daily rate established for jurors in district court of Thurston County; and

(b) Expenses shall be paid at the rate established for employees of the state of Washington, or as otherwise required by law.

(2) Fees for an expert witness shall be negotiated by and paid by the party requesting services of the expert.

(3) All expenses incurred in connection with proceedings under this chapter shall be paid by the party incurring the expense.

(4) The program shall pay expenses associated with:

(a) The facility in which proceedings are conducted; and

(b) Recording of the proceedings.

(5) Expenses related to preparation and distribution of the transcript of proceedings shall be paid by the party filing a motion or request for review of an initial order or petition for reconsideration, appealing a final order, or otherwise requesting the transcript.

[Statutory Authority: RCW 18.130.050(1) and 18.130.060(3). 94-04-078, § 246-11-140, filed 1/31/94, effective 3/3/94. Statutory Authority: RCW 18.130.050(1), 18.130.060(3) and 34.05.566. 93-08-003 (Order 347), § 246-11-140, filed 3/24/93, effective 4/24/93.]

**WAC 246-11-150 Immunity.** The legislature has determined that persons who file complaints with or provide information to the department or board regarding health care practitioners licensed by the board or department are immune from civil liability, provided that such persons have acted in good faith. RCW 4.24.240 through 4.24.260, 18.130.170, 18.130.180, and 18.130.300 set forth the provisions under which immunity is granted.

[Statutory Authority: RCW 18.130.050(1). 93-08-003 (Order 347), § 246-11-150, filed 3/24/93, effective 4/24/93.]

**WAC 246-11-160 Official notice and agency expertise.** (1) Official notice may be taken as provided in RCW 34.05.452(5).

(2) The board may use its expertise and specialized knowledge to evaluate and draw inferences from the evidence presented to it.

[Statutory Authority: RCW 18.130.050(1) and 18.130.060(3). 94-04-078, § 246-11-160, filed 1/31/94, effective 3/3/94. Statutory Authority: RCW 18.130.050(1) and 34.05.452(5). 93-08-003 (Order 347), § 246-11-160, filed 3/24/93, effective 4/24/93.]

**WAC 246-11-170 Sanctions.** (1) Orders may include sanctions against either party.

(2) Grounds for sanctions may include:

(a) Failure to comply with these rules or orders of the presiding officer; and

(b) Willful interference with the progress of proceedings.

(3) Sanctions may include:

(a) Dismissal of the matter;

(b) Proceeding in default; and

(c) Other sanctions as appropriate.

(4) The order shall state the grounds upon which any sanctions are imposed.

[Statutory Authority: RCW 18.130.050(1). 93-08-003 (Order 347), § 246-11-170, filed 3/24/93, effective 4/24/93.]

**WAC 246-11-180 Intervention.** (1) The presiding officer may grant a petition for intervention pursuant to RCW 34.05.443.

(2) A request to intervene shall be handled as a pre-hearing motion and shall be subject to the dates contained in the scheduling order. Within the sound exercise of discretion, the presiding officer may allow intervention if:

(a) The intervenor is not a party to the matter but has a substantial interest in outcome of the matter and the interest of the intervenor is not adequately represented by a party, or other good cause exists; and

(b) Any representative of the intervenor meets the requirements of WAC 246-11-070.

(3) A person shall not be allowed to intervene if that person had notice of the board's decision and, upon timely application, would have been able to appear as a party in the matter in which intervention is sought, but failed to make such timely application.

(4) If intervention is granted, the intervenor shall be subject to these rules on the same basis as the other parties to the proceeding, unless otherwise limited in the order granting intervention.

[Statutory Authority: RCW 18.130.050(1) and 18.130.060(3). 94-04-078, § 246-11-180, filed 1/31/94, effective 3/3/94. Statutory Authority: RCW 18.130.050(1). 93-08-003 (Order 347), § 246-11-180, filed 3/24/93, effective 4/24/93.]

**WAC 246-11-190 Form of pleadings and orders.**

(1) Pleadings, orders, and other papers filed, served, or entered under this chapter shall be:

(a) Captioned with the name of the state of Washington, the name of the board, and the title and cause number, if any, of the proceeding; and

(b) Signed by the person filing, serving, or entering the document. When that person is an attorney representing a party, the signature block shall include the attorney's Washington State Bar Association number.

(2) All orders shall comply with RCW 34.05.461 and the requirements of this chapter.

[Statutory Authority: RCW 18.130.050(1). 93-08-003 (Order 347), § 246-11-190, filed 3/24/93, effective 4/24/93.]

**WAC 246-11-200 Notice to limited-English-speaking parties.** When the program or the office of professional standards is notified or otherwise made aware that a limited-English-speaking person is a party in an adjudicative proceeding, all notices concerning the hearing, including notices of hearing, continuance, and dismissal, shall either be in the primary language of the party or shall include a notice in the primary language of the party which describes the significance of the notice and how the party may receive assistance in understanding and, if necessary, responding to the notice.

[Statutory Authority: RCW 18.130.050(1) and 34.05.220. 93-08-003 (Order 347), § 246-11-200, filed 3/24/93, effective 4/24/93.]

**WAC 246-11-210 Interpreters.** (1) A "hearing impaired person" means a person who, because of a hearing impairment or speech defect cannot readily understand or communicate in spoken language. A "hearing impaired person" includes a person who is deaf, deaf and blind, or hard of hearing.

(2) A "limited-English-speaking person" means a person who because of a non-English speaking cultural background cannot readily speak or understand the English language.

(3) If a hearing impaired person or a limited-English-speaking person is involved in an adjudicative proceeding and a need for an interpreter is made known to the office of professional standards, the presiding officer shall appoint an interpreter who is acceptable to the parties or, if the parties are unable to agree on an interpreter, the presiding officer shall select and appoint an interpreter.

(4) Before beginning to interpret, an interpreter shall take an oath or make affirmation that:

(a) A true interpretation shall be made to the impaired person of all the proceedings in a language or in a manner the impaired person understands; and

(b) The interpreter shall repeat the statements of the impaired person to the presiding officer, in the English language, to the best of the interpreter's skill and judgment.

(5) When an interpreter is used in a proceeding:

(a) The interpreter shall translate all statements made by other participants in the proceeding;

(b) The presiding officer shall ensure sufficient extra time is provided to permit translation; and

(c) The presiding officer shall ensure that the interpreter translates the entire proceeding to the hearing impaired person or limited-English-speaking person to the extent that the person has the same opportunity to understand the statements made as would a person not requiring an interpreter.

(6) An interpreter appointed under this section shall be entitled to a reasonable fee for services, including waiting time and reimbursement for actual necessary travel expenses. The program shall pay the interpreter fee and expenses incurred for interpreters for license holders, applicants, or recipients of benefits. The party on whose behalf a witness

requiring an interpreter appears shall pay for interpreter services for that witness.

(7) All proceedings shall be conducted consistent with chapters 2.42 and 2.43 RCW.

[Statutory Authority: RCW 18.130.050(1) and 34.05.220. 93-08-003 (Order 347), § 246-11-210, filed 3/24/93, effective 4/24/93.]

**WAC 246-11-220 Subpoenas.** (1) The board, through the presiding officer, or other designated person, and attorneys for parties may issue subpoenas to residents of the state of Washington, to license holders and applicants for license, and to other persons or entities subject to jurisdiction under RCW 4.28.185.

(2) The presiding officer shall issue subpoenas pursuant to RCW 34.05.446(1) for parties not represented by counsel upon request of the party and upon a showing of relevance and reasonable scope of the testimony or evidence sought. Requests for issuance of subpoenas must be made in writing to the presiding officer stating the relevance and the scope of testimony or evidence sought.

(3) The person on whose behalf the subpoena is issued shall pay any witness fees and expenses as provided in WAC 246-11-140 or costs for interpreters for such witnesses as provided in WAC 246-11-210.

(4) Attendance of persons subpoenaed and production of evidence may be required at any designated place in the state of Washington.

(5) Every subpoena shall:

- (a) Comply with WAC 246-11-190;
- (b) Identify the party causing issuance of the subpoena;
- (c) State the title of the proceeding; and
- (d) Command the person to whom the subpoena is directed to attend and give testimony and/or produce designated items under the person's control at a specified time and place.

(6) A subpoena may be served by any suitable person eighteen years of age or older by:

(a) Giving a copy to the person to whom the subpoena is addressed;

(b) Leaving a copy at the residence of the person to whom the subpoena is addressed with a person of suitable age and discretion;

(c) Sending a copy by mail to the current address on file with the program if the person is licensed by the board or has filed an application for a license with the board; or

(d) Sending a copy by certified mail with proof of receipt if the person is neither licensed by nor has applied for a license with the board.

(7) Proof of service may be made by:

- (a) Affidavit of personal service;
- (b) Certification by the person mailing the subpoena to a license holder or applicant; or

(c) Return or acknowledgment showing receipt by the person subpoenaed or his/her representative. Any person accepting certified or registered mail at the last known address of the person subpoenaed shall be considered an authorized representative.

(8) The presiding officer, upon motion made promptly and before the time specified for compliance in the subpoena, may:

(a) Quash or modify the subpoena if the subpoena is unreasonable or requires evidence not relevant to any matter at issue; or

(b) Condition denial of the motion upon just and reasonable conditions, including advancement of the reasonable cost by the person on whose behalf the subpoena is issued of producing the books, documents, or tangible things; or

(c) Issue a protective order under RCW 34.05.446.

(9) The board may seek enforcement of a subpoena under RCW 34.05.588(1) or proceed in default pursuant to WAC 246-11-280.

[Statutory Authority: RCW 18.130.050(1) and 18.130.060(3). 94-04-078, § 246-11-220, filed 1/31/94, effective 3/3/94. Statutory Authority: RCW 18.130.050(1), 4.24.240, 4.24.250 and 4.24.260. 93-08-003 (Order 347), § 246-11-220, filed 3/24/93, effective 4/24/93.]

**WAC 246-11-230 Presiding officer and panel members.** (1) The board may appoint one or more persons as presiding officer for brief adjudicative proceedings as provided in WAC 246-11-430(1).

(2) The board shall authorize one of the following to serve as presiding officer for adjudicative proceedings:

- (a) A board member; or
- (b) An individual appointed pursuant to RCW 18.130.095(3); or
- (c) An administrative law judge employed by the office of administrative hearings.

(3) The board may designate certain of its members to hear a matter as a hearing panel as provided by law.

(4) Any party may move to disqualify the presiding officer, or a member of the board hearing the matter, as provided in RCW 34.05.425(3).

[Statutory Authority: RCW 18.130.050(1) and 18.130.060(3). 94-04-078, § 246-11-230, filed 1/31/94, effective 3/3/94. Statutory Authority: RCW 18.130.050(1). 93-08-003 (Order 347), § 246-11-230, filed 3/24/93, effective 4/24/93.]

## SECTION II INITIATING ACTIONS

**WAC 246-11-250 Form and content of initiating documents.** (1) Initiating documents shall include a clear and concise statement of the:

- (a) Identity and authority of the person issuing the document;
- (b) Factual basis for the action or proposed action set forth in the document;
- (c) Statutes and rules alleged to be at issue;
- (d) Identity of the party against whom the action is taken or proposed to be taken;
- (e) Action or proposed action or penalties, including the statutory or rule authority for those actions or penalties; and
- (f) Signature of the person issuing the document and the date signed; and
- (g) Method by which an adjudicative proceeding may be requested.

(2) Initiating documents shall be accompanied by the following documents:

- (a) Notice that the respondent may defend against the action or proposed action; and
- (b) Form for requesting adjudicative proceeding.

(3) Initiating documents shall be served as described in WAC 246-11-080.

[Statutory Authority: RCW 18.130.050(1) and 18.130.060(3). 94-04-078, § 246-11-250, filed 1/31/94, effective 3/3/94. Statutory Authority: RCW 18.130.050(1) and 34.05.220. 93-08-003 (Order 347), § 246-11-250, filed 3/24/93, effective 4/24/93.]

**WAC 246-11-260 Amendment of initiating documents.** (1) Prior to the hearing date, initiating documents may be amended subject to the following conditions:

(a) Amended initiating documents shall meet the requirements of WAC 246-11-250(1);

(b) Amended initiating documents shall be accompanied by the documents described in WAC 246-11-250(2);

(c) Whenever amended initiating documents are issued, a new interval for response will begin, as described in WAC 246-11-270, unless the respondent requests the time periods set by the original initiating document; and

(d) Issuance of amended initiating documents ends all obligations of the parties under the prior initiating documents.

(2) On the hearing date, the initiating documents may be amended subject to the following conditions:

(a) The documents may be amended upon motion of the state;

(b) The documents may not be amended without the approval of the presiding officer; and

(c) Upon motion of a party or upon his/her own initiative, the presiding officer may grant a continuance on all or part of the matter if necessary to afford the respondent an opportunity to prepare a defense to the amended documents.

[Statutory Authority: RCW 18.130.050(1) and 18.130.060(3). 94-04-078, § 246-11-260, filed 1/31/94, effective 3/3/94. Statutory Authority: RCW 18.130.050(1) and 34.05.220. 93-08-003 (Order 347), § 246-11-260, filed 3/24/93, effective 4/24/93.]

**WAC 246-11-270 Request for adjudicative proceeding.** A respondent may respond to an initiating document by filing an application for an adjudicative proceeding or by waiving the opportunity for adjudicative proceeding.

(1) If the respondent wishes to file an application for an adjudicative proceeding:

(a) An application for adjudicative proceeding must be filed in accordance with the following time periods:

(i) For matters under chapter 18.130 RCW, the Uniform Disciplinary Act, within twenty days of service of the initiating documents unless an extension has been granted as provided in subsection (3) of this section; and

(ii) For all other matters, within twenty days of service of the initiating documents, unless otherwise provided by statute.

(b) The application for adjudicative proceeding shall be made on the Request for Adjudicative Proceeding form accompanying the initiating documents or by a written document including substantially the same information.

(c) By filing a request for adjudicative proceeding, the responding party agrees to appear personally at the adjudicative proceeding or, if otherwise approved by the presiding officer, by telephone, unless appearance is waived as authorized in WAC 246-11-130(4).

(d) The application for adjudicative proceeding shall contain a response to the initiating documents, indicating whether each charge is admitted, denied or not contested, and responses shall be subject to the following conditions:

(i) Once admitted or not contested, an allegation may not be denied; and

(ii) An allegation denied or not contested may later be admitted.

(e) When an allegation is admitted or not contested, it shall be conclusively deemed to be true for all further proceedings. No proof of the allegation need be submitted.

(f) The application for adjudicative proceeding shall specify the representative, if any, designated pursuant to WAC 246-11-070 and any request for interpreter. The responding party shall amend the name of the representative and need for interpreter immediately if circumstances change prior to the hearing.

(g) The application for adjudicative proceeding shall be filed at the board's office.

(2) A respondent may waive an adjudicative proceeding and submit a written statement and other documents in defense or in mitigation of the charges. Such waiver and documents shall be filed:

(a) In accordance with the timelines in subsection (1)(a) of this section; and

(b) At the address indicated in subsection (1)(g) of this section.

(3) For matters under RCW 18.130.180, if the twenty-day limit for filing an application for adjudicative proceeding results in a hardship to the respondent, the respondent may request an extension of not more than sixty days upon a showing of good cause.

(a) The request for extension shall be filed within the twenty-day limit and shall include:

(i) The reason for the request and the number of days for which the extension is requested; and

(ii) Documentation of the circumstances creating the hardship.

(b) The request shall be granted for a period not to exceed sixty days upon showing of:

(i) Illness of the respondent; or

(ii) Absence of the respondent from the county of residence or employment; or

(iii) Emergency in the respondent's family; or

(iv) Other good cause as determined by the presiding officer.

(c) If a request for extension is denied, the respondent shall have ten days from service of the order denying the extension or twenty days from service of the initiating documents, whichever is longer, to file an application for adjudicative proceeding.

[Statutory Authority: RCW 18.130.050(1) and 18.130.060(3). 94-04-078, § 246-11-270, filed 1/31/94, effective 3/3/94. Statutory Authority: RCW 18.130.050(1) and 34.05.220. 93-08-003 (Order 347), § 246-11-270, filed 3/24/93, effective 4/24/93.]

**WAC 246-11-280 Default.** (1) If a party fails to respond to initiating documents according to WAC 246-11-270, that party will be deemed to have waived the right to a hearing, and the board shall enter a final order without further contact with that party.

(2) If a party requests an adjudicative proceeding but fails to appear, without leave to do so, at a scheduled prehearing conference, the presiding officer may issue an order of default. The order shall include notice of opportunity to request that the default order be vacated pursuant to RCW 34.05.440(3). Unless vacated, a default order under this subsection shall be grounds for the board to proceed to decide the matter in the absence of the respondent and without additional notice to the respondent and to issue a final order.

(3) If a party requests an adjudicative proceeding but fails to appear at the hearing, the presiding officer may issue an order of default in the same manner as subsection (2) of this section, or may proceed to hear the matter in the absence of the party and issue a final order.

(4) Final orders entered under this section shall contain:

(a) Findings of fact and conclusions of law based upon prima facie proof of the allegations contained in the initiating documents;

(b) Proof of service of or a good faith attempt to serve initiating documents and appropriate notices;

(c) A finding that there is no reason to believe that the party in default is in active military service;

(d) The penalties or conditions imposed by the order; and

(e) Notice of the opportunity to request reconsideration pursuant to RCW 34.05.470.

(5) Final and default orders entered under this section shall be served upon the parties in accordance with WAC 246-11-080.

[Statutory Authority: RCW 18.130.050(1) and 18.130.060(3). 94-04-078, § 246-11-280, filed 1/31/94, effective 3/3/94. Statutory Authority: RCW 18.130.050(1), 34.05.220, 34.05.440 and 34.05.470. 93-08-003 (Order 347), § 246-11-280, filed 3/24/93, effective 4/24/93.]

**WAC 246-11-290 Scheduling orders.** (1) Within thirty days after receipt of the application for adjudicative proceeding, the board or designee thereof, shall:

(a) Approve the application for full adjudicative procedure and issue and serve on the parties a scheduling order or other scheduling mechanism establishing timelines for discovery, settlement, and scheduled hearings; or

(b) Approve the application for a brief adjudicative procedure and issue and serve a notice of the date by which any additional written materials are to be submitted for consideration; or

(c) Deny the application according to RCW 34.05.416.

(2) If a scheduling order is issued:

(a) The scheduling order shall specify:

(i) The date, time, and place of a settlement conference, a prehearing conference, and the hearing;

(ii) The deadlines for completion of discovery and submission of prehearing motions; and

(iii) The name, address, and telephone number of the assistant attorney general or other department representative who will represent the state in the matter.

(b) The scheduling order may be modified by order of the presiding officer upon his/her own initiative or upon motion of a party. Any request for change of the scheduling mechanism or order shall be made by motion as provided in WAC 246-11-380.

(c) The presiding officer may waive establishing dates for the settlement conference, completion of discovery, submission of prehearing motions, and the prehearing conference, if, in the discretion of the presiding officer, those proceedings are not necessary or appropriate in a particular matter or type of case. However, either party may request by motion to the presiding officer that any or all of the dates be set.

(d) Dates contained in the scheduling order may be changed by the office of the board upon written request of either party made within fifteen days of issuance of the first scheduling order. All other changes must be made by motion pursuant to WAC 246-11-380.

[Statutory Authority: RCW 18.130.050(1) and 18.130.060(3). 94-04-078, § 246-11-290, filed 1/31/94, effective 3/3/94. Statutory Authority: RCW 18.130.050(1) and 34.05.419. 93-08-003 (Order 347), § 246-11-290, filed 3/24/93, effective 4/24/93.]

### SECTION III EMERGENCY ADJUDICATIVE PROCEEDINGS

**WAC 246-11-300 Conduct of emergency adjudicative proceedings.** (1) Summary action may be taken only after a review by the board of such evidence, including affidavits, if appropriate, to establish:

(a) The existence of an immediate danger to the public health, safety, or welfare;

(b) The board's ability to address the danger through a summary action, and

(c) The summary action necessary to address the danger.

(2) No notice to any person potentially affected by a summary action shall be required prior to issuance of a summary action.

[Statutory Authority: RCW 18.130.050(1) and 18.130.060(3). 94-04-078, § 246-11-300, filed 1/31/94, effective 3/3/94. Statutory Authority: RCW 18.130.050(1), 34.05.422 and 34.05.479. 93-08-003 (Order 347), § 246-11-300, filed 3/24/93, effective 4/24/93.]

**WAC 246-11-310 Effect of summary action.** (1) Summary action takes effect upon entry of the order.

(2) No person shall be required to comply with a summary action until service has been made or the person has knowledge of the order, whichever occurs first.

(3) A summary action shall be served as promptly as practicable, in accordance with WAC 246-11-080.

(4) A summary action shall not be subject to the post hearing process provided in WAC 246-11-550 through 246-11-610, but a summary action may be appealed to superior court as provided by law.

[Statutory Authority: RCW 18.130.050(1), 34.05.422 and 34.05.479. 93-08-003 (Order 347), § 246-11-310, filed 3/24/93, effective 4/24/93.]

**WAC 246-11-320 Form and content of summary actions.** (1) A summary action shall be entered in the form of an order containing findings of fact, conclusions of law, and the summary action imposed, as well as a statement of policy reasons for the decision.

(2) A summary action imposed by emergency adjudicative proceeding shall be limited to those actions necessary to alleviate an immediate danger to the public health, safety, or welfare.

(3) Initiating documents, and all other documents required by WAC 246-11-250 shall accompany a summary action order when served.

[Statutory Authority: RCW 18.130.050(1), 34.05.473 and 34.05.479. 93-08-003 (Order 347), § 246-11-320, filed 3/24/93, effective 4/24/93.]

**WAC 246-11-330 Adjudicative proceedings upon summary action.** Following summary action taken by the board, the respondent may:

- (1) Request a prompt adjudicative proceeding conducted in accordance with this chapter; or
- (2) Waive the prompt adjudicative proceeding and request a regularly scheduled adjudicative proceeding conducted in accordance with this chapter;
- (3) Waive the right to an adjudicative proceeding and submit a written statement to be considered prior to the entry of the final order; or
- (4) Waive the opportunity to be heard.

[Statutory Authority: RCW 18.130.050(1) and 18.130.060(3). 94-04-078, § 246-11-330, filed 1/31/94, effective 3/3/94. Statutory Authority: RCW 18.130.050(1) and 34.05.479. 93-08-003 (Order 347), § 246-11-330, filed 3/24/93, effective 4/24/93.]

**WAC 246-11-340 Opportunity for prompt adjudicative proceeding.** (1) Any respondent affected by a summary action shall be provided the opportunity to request a prompt adjudicative proceeding. Notice of the opportunity shall be provided in the notice of opportunity to defend against the allegations that are the basis for the summary action. The form for requesting an adjudicative proceeding shall include the option of requesting a prompt adjudicative proceeding.

(2) Any respondent affected by a summary action may request an prompt adjudicative proceeding, may elect a regularly scheduled adjudicative proceeding instead of a prompt adjudicative proceeding, or may waive the opportunity for adjudicative proceeding in accord with WAC 246-11-270.

(3) Any request for a prompt adjudicative proceeding must be filed within ten days of the service of the summary action.

(4) If requested by the respondent, a prompt adjudicative proceeding shall be conducted within twenty days of service of a summary action.

(5) Regardless whether a prompt adjudicative proceeding is requested, the matter shall be resolved as quickly as feasible in accordance with all other applicable rules.

[Statutory Authority: RCW 18.130.050(1) and 18.130.060(3). 94-04-078, § 246-11-340, filed 1/31/94, effective 3/3/94. Statutory Authority: RCW 18.130.050(1) and 34.05.479. 93-08-003 (Order 347), § 246-11-340, filed 3/24/93, effective 4/24/93.]

**WAC 246-11-350 Proceedings prior to prompt adjudicative proceeding.** A settlement conference may be requested, a settlement may be offered, and a prehearing conference may be conducted prior to a prompt adjudicative proceeding. Prehearing proceedings shall not delay a prompt adjudicative proceeding except by mutual agreement of the parties.

[Statutory Authority: RCW 18.130.050(1) and 34.05.479. 93-08-003 (Order 347), § 246-11-350, filed 3/24/93, effective 4/24/93.]

## SECTION IV SETTLEMENT AND PREHEARING PROCEEDINGS

**WAC 246-11-360 Settlement conference.** (1) Following a request for an adjudicative proceeding, a settlement conference shall be conducted if provided in the scheduling order. If another scheduling mechanism is issued, a settlement conference may be scheduled and held at the discretion of the board or other settlement processes may be utilized at the discretion of the board.

(2) The purpose of the settlement conference or other settlement process shall be to attempt to reach agreement on the issues and on a proposed order to be entered. Any agreement of the parties is subject to final approval by the board.

(3) The respondent shall attend the settlement conference as scheduled and may also be represented as provided in WAC 246-11-070. Representatives of the board and/or department will also attend. Other persons may attend by agreement of the parties.

(4) Either party may bring documents or other materials to the settlement conference for the purpose of settlement negotiations. No testimony will be taken. No documents or information submitted at the settlement conference will be admitted at the adjudicative proceeding unless stipulated by the parties or otherwise admitted into evidence by the presiding officer.

(5) If a settlement offer has been made in writing to the respondent and it is signed and returned by the respondent to the board prior to the settlement conference, all subsequent dates set in the scheduling order or other scheduling mechanism are continued pending final review of the settlement by the board.

[Statutory Authority: RCW 18.130.050(1) and 18.130.060(3). 94-04-078, § 246-11-360, filed 1/31/94, effective 3/3/94. Statutory Authority: RCW 18.130.050(1). 93-08-003 (Order 347), § 246-11-360, filed 3/24/93, effective 4/24/93.]

**WAC 246-11-370 Discovery.** The parties are encouraged to exchange information and documents related to the case prior to the adjudicative proceeding. Formal discovery is obtained as follows:

(1) Methods, scope and limits:

(a) Parties may obtain discovery by production of records or things; deposition upon oral examination; requests for admission; or, if ordered by the presiding officer, written interrogatories.

(b) Unless otherwise limited by order of the presiding officer in accord with these rules, the scope of discovery shall be as follows:

(i) Parties may obtain discovery regarding any matter not privileged, which is relevant to the subject matter in the pending action. It is not grounds for objection that the information sought will be inadmissible at the adjudicative proceeding if the information sought appears reasonably calculated to lead to the discovery of admissible evidence.

(ii) The frequency or extent of use of the discovery methods set forth in these rules shall be limited by the presiding officer if the presiding officer determines that:



(A) The discovery sought is unreasonably cumulative or duplicative, or is obtainable from another source that is more convenient, less burdensome, or less expensive; or

(B) The party seeking discovery has had an ample opportunity by discovery to obtain the information sought; or

(C) The discovery is unduly burdensome or expensive, taking into account the needs of the case, limitations of the parties' resources, and the importance of the issues at stake.

(iii) The presiding officer may limit discovery upon his or her own initiative after reasonable notice or pursuant to a motion submitted by a party.

(2) Production of records, documents, or things:

(a) Upon written request of a party the opposing party shall identify experts and other witnesses to be called at the hearing and shall provide other information necessary to enable the party to conduct depositions of the witnesses.

(b) Any party may serve on any other party a request, which must be signed by the party or designated representative:

(i) To produce and permit the party making the request or designee to inspect and copy any designated documents, or to inspect and copy, test, or sample any tangible things which constitute or contain matters within the scope of discovery and which are in the possession, custody or control of the party upon whom the request is served; or

(ii) To permit entry onto designated land or other property which is in the possession or control of the party upon whom the request is served for the purpose of inspection, measuring, surveying, photographing, testing or sampling the property or designated object or operation thereon which is within the scope of discovery.

(c) Any party who produces documents for inspection shall produce them as they are kept in the usual course of business or may, if the parties agree, organize and label them to correspond with the categories in the request.

(d) The party upon whom a request is made may, by motion to the presiding officer, move for an order denying the request to produce or modify the conditions of the request. Denial of the request of change in the conditions of the request shall be within the discretion of the presiding officer and shall be made by written order.

(3) Depositions may be taken subject to the following conditions:

(a) Within the United States or a territory or insular possession subject to the dominion of the United States, depositions shall be taken before an officer authorized to administer oaths by the state of Washington or of the place where the examination is held. A presiding officer may, in his or her discretion or following motion of a party, preside at the deposition. Within a foreign country, depositions shall be taken before a secretary of an embassy or legation, consul general, vice-consul or consular agent of the United States, or a person designated by the presiding officer or agreed upon by the parties by stipulation in writing filed with the presiding officer, if any, and otherwise with the disciplining authority. Except by stipulation, no deposition shall be taken before any person who is a party or a privy of a party, or a privy of a representative of a party, or who is financially interested in the proceeding.

(b) A party desiring to take the deposition of a person upon oral examination shall give reasonable notice of not

less than five days in writing to the person to be deposed and to the opposing party. The notice shall state the time and place for taking the deposition, the name and address of each person to be examined, if known, and if the name is not known, a description sufficient to identify the person to be examined or the particular class or group to which the person to be examined belongs. On motion of a party upon whom the notice is served, the presiding officer may for cause shown, lengthen or shorten the time.

(c) After notice is served for taking a deposition, or upon motion of the presiding officer, or upon motion reasonably made by any party or by the person to be examined, and upon notice and for good cause, the presiding officer may issue an order that the deposition shall not be taken or that it be taken subject to specified restrictions, conditions, or limitations.

(d) Depositions shall be recorded.

(i) The officer before whom the deposition is taken shall put the witness on oath or affirmation and shall personally or by someone acting under the officer's direction and in the officer's presence, record the testimony.

(ii) The officer or person acting under the officer's direction shall transcribe the testimony at the request of any party, provided that any expenses shall be paid by the requesting party.

(iii) The transcribed testimony shall be submitted to the person deposed for review and signature, unless review and signature are waived by that person. The officer shall append to the transcript any changes in form or substance that may be submitted by the parties.

(iv) Copies of the transcribed and, unless review and signature has been waived, signed testimony shall be served upon the person deposed and upon the parties.

(e) If the parties so stipulate in writing or on the record, depositions may be taken before any person, at any time or place, upon any notice, and in any manner and when so taken, may be used as any other deposition.

(4) Following motion of a party and opportunity for response by the opposing party, the presiding officer may order a party to respond to written interrogatories and may order that the interrogatories be subject to specified restriction, condition, or limitation.

[Statutory Authority: RCW 18.130.050(1) and 18.130.060(3). 94-04-078, § 246-11-370, filed 1/31/94, effective 3/3/94. Statutory Authority: RCW 18.130.050(1). 93-08-003 (Order 347), § 246-11-370, filed 3/24/93, effective 4/24/93.]

**WAC 246-11-380 Motions.** (1) The presiding officer shall rule on motions. The presiding officer may rule on motions without oral argument or may request or permit the parties to argue the motion in person or by telephone. Oral argument may be limited in time at the discretion of the presiding officer.

(2) All prehearing motions, including discovery and evidentiary motions, shall be made in writing and filed prior to the dates set in the scheduling order. Filing shall be at the board's office, unless filing is directed in writing to be made at another address.

(3) Motions for continuance must be made in writing and filed prior to the dates set in the scheduling order. If the adjudicative proceeding is scheduled to take place fewer than twenty days from service of the scheduling order,

motions for continuance must be made within ten days of service of the scheduling order, but in no event fewer than five days prior to the hearing. Continuances may be granted by the presiding officer for good cause.

(4) The presiding officer may grant a continuance when a motion for continuance is not submitted within the time limits contained in subsection (3) of this section for good cause.

(5) The following is the recommended format for motions:

(a) A succinct statement of the facts contended to be material;

(b) A concise statement of the issue, issues or law upon which the presiding officer is requested to rule;

(c) The specific relief requested by the moving party;

(d) If the motion requires the consideration of facts or evidence not appearing on the record, the moving party shall also serve and file copies of all affidavits and photographic or documentary evidence presented in support of the motion;

(e) The legal authority upon which the motion is based; and

(f) A proposed order may accompany the motion, and should contain findings of fact and conclusions of law.

(6) The moving party shall file the motion, and the accompanying affidavits and photographic or documentary evidence when necessary, with the board's office and with the presiding officer, and shall serve the motion, and the accompanying affidavits and photographic or documentary evidence when necessary, on all other parties.

(7) The opposing party shall file with the board's office and with the presiding officer, and serve upon the moving party, a responsive memorandum, and accompanying affidavits and photographic or documentary evidence when necessary, no later than eleven days following service of the motion, unless otherwise ordered by the presiding officer.

(8) The moving party may file with the board's office and with the presiding officer, and serve upon the opposing party, a reply memorandum no later than five days following service of the responsive memorandum, unless otherwise ordered by the presiding officer.

(9) Unless otherwise ordered by the presiding officer, all motions shall be decided without oral argument. A party requesting oral argument on a motion shall so indicate by typing "ORAL ARGUMENT REQUESTED" in the caption of the motion or the responsive memorandum. If a request for oral argument is granted, the presiding officer shall notify the parties of the date and time of the argument and whether the argument will be in person or by telephone conference.

(10) Motions to shorten time or emergency motions shall be exceptions to the rule, and a party may only make such motions in exigent or exceptional circumstances. When making such a motion, the moving party shall:

(a) Suggest a date and time when the moving party seeks to have the presiding officer hear the motion to shorten time, which should be at least forty-eight hours after filing;

(b) Suggest a date and time when the moving party seeks to have the presiding officer consider the merits of the underlying motion;

(c) Describe the exigent or exceptional circumstances justifying shortening of time in an affidavit or a memorandum accompanying the motion;

(d) Certify that the motion to shorten time and the underlying motion have been served on all other parties prior to the filing of the motion with the presiding officer. Any opposition to the motion to shorten time must be served and filed within twenty-four hours of the service of the motion. If the presiding officer grants the motion to shorten time, the presiding officer shall notify the parties of the date by which the responsive memorandum to the underlying motion shall be served and filed.

(11) All motions will be decided as soon as practical, but not more than thirty days following the filing of the motion. If the presiding officer will not decide the motion within this time, the presiding officer shall notify the parties in writing of the date by which the motion will be decided.

(12) If a party serves a motion or responsive memorandum by mail, pursuant to WAC 246-11-080, then three days shall be added to the time within which the opposing party must file and serve the responsive or reply memorandum. Service by electronic telefacsimile transmission (FAX) upon each party is permitted upon agreement of the parties, with proof of confirmation of service to be filed with the presiding officer.

(13) All computations of time shall be calculated pursuant to WAC 246-11-040.

(14) Departmental motions for summary actions are exempted from all requirements of this section.

[Statutory Authority: RCW 18.130.050 and 43.70.040. 96-21-027, § 246-11-380, filed 10/7/96, effective 11/7/96. Statutory Authority: RCW 18.130.050(1) and 18.130.060(3). 94-04-078, § 246-11-380, filed 1/31/94, effective 3/3/94. Statutory Authority: RCW 18.130.050(1). 93-08-003 (Order 347), § 246-11-380, filed 3/24/93, effective 4/24/93.]

**WAC 246-11-390 Prehearing conference.** (1) If a scheduling order is issued, the parties shall be notified of the time and place of the first prehearing conference in the scheduling order. If another scheduling mechanism is issued, a prehearing conference will be held upon motion of either party, unless board policy provides otherwise.

(2) The presiding officer shall determine whether the prehearing conferences will be conducted in person or by telephone conference call.

(3) The presiding officer shall conduct the prehearing conference and shall issue rulings related to prehearing motions and evidentiary issues. The rulings shall govern the conduct of subsequent proceedings.

(4) The prehearing conference may be recorded as ordered by the presiding officer. All offers of proof and objections concerning matters raised at the prehearing conference must be made on the record at the prehearing conference.

(5) Following the final prehearing conference, the presiding officer shall issue a written prehearing order which will:

(a) Identify the issues to be considered at the hearing and indicate which party has the burden of proof on these issues;

(b) Specify the facts which are admitted or not contested by the parties;

(c) Identify those documents and exhibits that will be admitted at hearing and those which may be distributed prior to hearing;

(d) Identify expert and lay witnesses that may be called at hearing and the issues to which those witnesses may testify;

(e) Rule on motions;

(f) Accept amendments to the pleadings;

(g) Address such other issues or matters as may be reasonably anticipated to arise and which may aid in the disposition of the proceedings; and

(h) Rule on objections made in any preserved testimony.

(6) Following the prehearing conference, the presiding officer may issue an order directing that the matter be heard as a brief adjudicative proceeding, pursuant to WAC 246-11-420 through 246-11-450.

(7) Documentary evidence not offered in the prehearing conference shall not be received into evidence at the adjudicative proceeding in the absence of a clear showing that the offering party had good cause for failing to produce the evidence at the prehearing conference.

(8) Witnesses not identified during the prehearing conference shall not be allowed to testify at the adjudicative proceeding in the absence of a clear showing that the party offering the testimony of such witness had good cause for failing to identify the witness at the prehearing conference.

(9) If the authenticity of documents submitted at the prehearing conference is not challenged at the prehearing conference, the documents shall be deemed authentic. However, a party shall be permitted to challenge such authenticity at a later time upon a clear showing of good cause for failure to object at the prehearing conference.

(10) Nothing in these rules shall prohibit the presiding officer from conducting a conference at any time, including during the hearing. The presiding officer shall state on the record the results of such conference.

(11) A party bound by a stipulation or admission of record may withdraw it in whole or in part only upon a determination by the presiding officer or hearing officer that:

(a) The stipulation or admission was made inadvertently or as a bona fide mistake of fact or law; and

(b) The withdrawal will not unjustly prejudice the rights of the other parties.

(12) In an appeal to superior court involving issues addressed in the prehearing order, the record of the prehearing conference, written motions and responses the prehearing order and any orders issued by the presiding officer pursuant to WAC 246-11-380, shall be the record.

[Statutory Authority: RCW 18.130.050(1) and 18.130.060(3). 94-04-078, § 246-11-390, filed 1/31/94, effective 3/3/94. Statutory Authority: RCW 18.130.050(1). 93-08-003 (Order 347), § 246-11-390, filed 3/24/93, effective 4/24/93.]

**WAC 246-11-400 Protective orders.** The presiding officer may issue a protective order at his or her discretion:

(1) To protect a party or person from annoyance, embarrassment, oppression, or undue burden or expense;

(2) To preserve confidentiality related to health care records or provider-client information;

(3) To protect examination processes;

(4) To protect the identity of a person supplying information to the department or board where the person indicates a desire for nondisclosure unless that person testifies or has been called to testify at an adjudicative proceeding; or

(5) To comply with applicable state or federal law.

[Statutory Authority: RCW 18.130.050(1) and 18.130.060(3). 94-04-078, § 246-11-400, filed 1/31/94, effective 3/3/94. Statutory Authority: RCW 18.130.050(1) and 34.05.446. 93-08-003 (Order 347), § 246-11-400, filed 3/24/93, effective 4/24/93.]

## SECTION V BRIEF ADJUDICATIVE PROCEEDINGS

**WAC 246-11-420 Application of brief adjudicative proceedings.** (1) If an adjudicative proceeding is requested, a brief adjudicative proceeding will be conducted where the matter involves one or more of the following:

(a) A determination whether an applicant for a license meets the minimum criteria for an unrestricted license and the board proposes to deny such a license or to issue a restricted license;

(b) A determination whether a person is in compliance with the terms and conditions of a final order previously issued by the board;

(c) Any approval of a school or curriculum when such approval by the board is required by statute or rule; and

(d) A determination whether a license holder requesting renewal has submitted all required information and meets minimum criteria for renewal.

(2) If an adjudicative proceeding is requested in a matter not listed in subsection (1) of this section, a brief adjudicative proceeding may be conducted in the discretion of the presiding officer when it appears that:

(a) Only legal issues exist; or

(b) Both parties have agreed to a brief proceeding; and

(c) The protection of the public interest does not require that the board provide notice and an opportunity to participate to persons other than the parties.

[Statutory Authority: RCW 18.130.050(1) and 18.130.060(3). 94-04-078, § 246-11-420, filed 1/31/94, effective 3/3/94. Statutory Authority: RCW 18.130.050(1) and 34.05.482. 93-08-003 (Order 347), § 246-11-420, filed 3/24/93, effective 4/24/93.]

**WAC 246-11-425 Preliminary record in brief adjudicative proceedings.** (1) The preliminary record with respect to an application for a license or for approval of a school or curriculum shall consist of:

(a) The application for the license or approval and all associated documents;

(b) All documents relied upon by the program in proposing to deny the application; and

(c) All correspondence between the applicant for license or approval and the program regarding the application.

(2) The preliminary record with respect to determination of compliance with a previously issued final order shall consist of:

(a) The previously issued final order;

(b) All reports or other documents submitted by the license holder, or at the direction of the license holder, in full or partial fulfillment of the terms of the final order; and

(c) All correspondence between the license holder and the program regarding compliance with the final order.

[Statutory Authority: RCW 18.130.050(1) and 18.130.060(3). 94-04-078, § 246-11-425, filed 1/31/94, effective 3/3/94.]

**WAC 246-11-430 Conduct of brief adjudicative proceedings.** (1) Brief adjudicative proceedings shall be conducted by a presiding officer for brief adjudicative proceedings designated by the board. The presiding officer for brief adjudicative proceedings shall have agency expertise in the subject matter but shall not have personally participated in the decision to issue the initiating document.

(2) The parties or their representatives may present written documentation. The presiding officer for brief adjudicative proceedings shall designate the date by which written documents must be submitted by the parties.

(3) The presiding officer for brief adjudicative proceedings may, in his or her discretion, entertain oral argument from the parties or their representatives.

(4) No witnesses may appear to testify.

(5) In addition to the record, the presiding officer for brief adjudicative proceedings may employ agency expertise as a basis for decision.

(6) The presiding officer for brief adjudicative proceedings shall not issue an oral order. Within ten days of the final date for submission of materials or oral argument, if any, the presiding officer for brief adjudicative proceedings shall enter an initial order in accordance with WAC 246-11-540.

[Statutory Authority: RCW 18.130.050 and 43.70.040. 96-21-027, § 246-11-430, filed 10/7/96, effective 11/7/96. Statutory Authority: RCW 18.130.050(1) and 18.130.060(3). 94-04-078, § 246-11-430, filed 1/31/94, effective 3/3/94. Statutory Authority: RCW 18.130.050(1). 93-08-003 (Order 347), § 246-11-430, filed 3/24/93, effective 4/24/93.]

**WAC 246-11-440 Effectiveness of orders on brief adjudicative proceedings.** (1) Initial orders on brief adjudicative proceedings shall become final twenty-one days after service of the initial order unless:

(a) Administrative review has been requested pursuant to WAC 246-11-550; or

(b) On its own initiative, the board determines to review the matter and, within twenty-one days of service of the initial order, provides notice to the parties of the date by which a determination shall be made.

(2) If review is taken under subsection (1) of this section, each party shall be provided an opportunity to state its view of the matter, and a written order containing findings of fact, conclusions of law, and order shall be entered and served upon the parties within twenty days of service of the initial order or the request for review, whichever is later.

(3) A request for review is deemed to be denied if the board does not act on the request within twenty days after the request is submitted.

(4) If administrative review is taken under subsection (1) of this section, the presiding officer may convert the matter to a full adjudicative proceeding.

[Statutory Authority: RCW 18.130.050(1) and 18.130.060(3). 94-04-078, § 246-11-440, filed 1/31/94, effective 3/3/94. Statutory Authority: RCW 18.130.050(1), 34.05.455, 34.05.485, 34.05.488 and 34.05.491. 93-08-003 (Order 347), § 246-11-440, filed 3/24/93, effective 4/24/93.]

**WAC 246-11-450 Agency record in brief proceedings.** The agency record of brief adjudicative proceedings shall consist of:

(1) The preliminary record as set forth in WAC 246-11-425;

(2) All initiating documents including the notice of opportunity to defend;

(3) The request for adjudicative proceeding;

(4) All documents submitted in the proceeding;

(5) Any transcript or recording of any testimony or arguments presented; and

(6) All orders issued in the case.

[Statutory Authority: RCW 18.130.050(1) and 18.130.060(3). 94-04-078, § 246-11-450, filed 1/31/94, effective 3/3/94. Statutory Authority: RCW 18.130.050(1) and 34.05.494. 93-08-003 (Order 347), § 246-11-450, filed 3/24/93, effective 4/24/93.]

## SECTION VI HEARING

**WAC 246-11-470 Notice of adjudicative proceeding.** Notice of an adjudicative proceeding shall be issued pursuant to RCW 34.05.434.

[Statutory Authority: RCW 18.130.050(1) and 34.05.434. 93-08-003 (Order 347), § 246-11-470, filed 3/24/93, effective 4/24/93.]

**WAC 246-11-480 Conduct of adjudicative proceeding.** (1) The adjudicative proceeding shall be conducted as provided in RCW 34.05.449 through 34.05.455.

(2) The presiding officer may take the following actions to the extent not already determined in a prehearing order:

(a) Conduct the hearing de novo;

(b) Determine the order of presentation of evidence;

(c) Administer oaths and affirmations;

(d) Issue subpoenas;

(e) Rule on procedural matters, objections, motions, and offers of proof;

(f) Receive relevant evidence;

(g) Interrogate witnesses called by the parties in an impartial manner to develop any facts necessary to fairly and adequately decide the matter;

(h) Call additional witnesses and request additional exhibits deemed necessary to complete the record and receive such evidence subject to full opportunity for cross-examination and rebuttal by all parties;

(i) Take any appropriate action necessary to maintain order during the adjudicative proceeding;

(j) Determine whether to permit or require oral argument or briefs and determine the time limits for submission thereof;

(k) Permit photographic and recording equipment at hearing subject to conditions necessary to preserve confidentiality and prevent disruption;

(l) Permit a person to waive any right conferred upon that person by chapter 34.05 RCW or this chapter, except as precluded by law; and

(m) Take any other action necessary and authorized by applicable law or rule.

(3) The presiding officer shall:

(a) Apply as the first source of law governing an issue those statutes and rules deemed applicable to the issue;

(b) If there is no statute or rule governing the issue, resolve the issue on the basis of the best legal authority and reasoning available, including that found in federal and

Washington Constitutions, statutes, rules, and court decisions; and

(c) Not declare any statute or rule invalid.

(4) If the validity of any statute or rule is raised as an issue, the presiding officer may permit arguments to be made on the record concerning the issue for the purpose of subsequent review.

(5) Members of the board hearing the matter may ask questions of any witness and may call additional witnesses.

(6) A party may move to disqualify the presiding officer or any member of the board pursuant to RCW 34.05.425(3).

[Statutory Authority: RCW 18.130.050(1) and 18.130.060(3). 94-04-078, § 246-11-480, filed 1/31/94, effective 3/3/94. Statutory Authority: RCW 18.130.050(1). 93-08-003 (Order 347), § 246-11-480, filed 3/24/93, effective 4/24/93.]

**WAC 246-11-490 Evidence.** (1) The presiding officer shall rule on objections to the admissibility of evidence pursuant to RCW 34.05.452 unless those objections have been addressed in the prehearing order.

(2) The refusal of a witness to answer any question ruled proper shall be grounds for the presiding officer, at his/her discretion, to strike some or all prior testimony by that witness on related matters or to grant a continuance to allow a party to seek a court order to compel the witness to answer.

(3) Each person called as a witness in an adjudicative proceeding shall swear or affirm that the evidence about to be given in the adjudicative proceeding shall be the truth under the provisions of RCW 5.28.020 through 5.28.060.

[Statutory Authority: RCW 18.130.050(1). 93-08-003 (Order 347), § 246-11-490, filed 3/24/93, effective 4/24/93.]

**WAC 246-11-500 Proposed order.** At the conclusion of the hearing or by a date specified by the presiding officer, the presiding officer may require each party to submit to the presiding officer proposed findings of fact and conclusions of law and a proposed order.

[Statutory Authority: RCW 18.130.050(1) and 18.130.060(3). 94-04-078, § 246-11-500, filed 1/31/94, effective 3/3/94. Statutory Authority: RCW 18.130.050(1). 93-08-003 (Order 347), § 246-11-500, filed 3/24/93, effective 4/24/93.]

**WAC 246-11-510 Issuance of final order.** If the adjudicative proceeding is heard by the board or a panel of the board the presiding officer and board or panel of the board shall:

(1) Issue a final order containing findings of fact and conclusions of law and an order; and

(2) Serve a copy of the order on each party and any designated representative of the party.

[Statutory Authority: RCW 18.130.050(1) and 18.130.060(3). 94-04-078, § 246-11-510, filed 1/31/94, effective 3/3/94. Statutory Authority: RCW 18.130.050(1). 93-08-003 (Order 347), § 246-11-510, filed 3/24/93, effective 4/24/93.]

**WAC 246-11-520 Standard of proof.** The order shall be based on the kind of evidence upon which reasonably prudent persons are accustomed to rely in the conduct of their affairs. In all cases involving an application for license the burden shall be on the applicant to establish that the application meets all applicable criteria. In all other

cases the burden is on the department to prove the alleged factual basis set forth in the initiating document. Except as otherwise provided by statute, the burden in all cases is a preponderance of the evidence.

[Statutory Authority: RCW 18.130.050(1). 93-08-003 (Order 347), § 246-11-520, filed 3/24/93, effective 4/24/93.]

**WAC 246-11-530 Consolidated proceedings.** (1) When two or more applications for adjudicative proceeding involve a similar issue, the applications may be consolidated by the presiding officer and the hearings conducted together. The presiding officer or hearings officer may consolidate on his/her own motion or upon the request of a party.

(2) A party scheduled for a consolidated proceeding may request to withdraw from the consolidated proceeding in favor of an individual proceeding. The presiding officer may grant a motion to withdraw from a consolidated proceeding at any time when good cause is shown.

(3) Each respondent in a consolidated proceeding shall retain the right to representation.

[Statutory Authority: RCW 18.130.050(1) and 18.130.060(3). 94-04-078, § 246-11-530, filed 1/31/94, effective 3/3/94. Statutory Authority: RCW 18.130.050(1) and 34.05.220. 93-08-003 (Order 347), § 246-11-530, filed 3/24/93, effective 4/24/93.]

**WAC 246-11-540 Initial order.** (1) If the adjudicative proceeding is not heard by the board or panel of the board the presiding officer shall:

(a) Issue an initial order containing proposed findings of fact, conclusions of law, and a proposed order;

(b) Serve a copy of the initial order on each party and any designated representative of a party; and

(c) Forward the initial order and record of the adjudicative proceeding to the office of the board.

(2) Initial orders on brief adjudicative proceedings shall become final orders as provided in WAC 246-11-540.

(3) Following receipt of initial orders in matters other than brief adjudicative proceedings, the board shall review the initial order and the record as provided in RCW 34.05.464, and issue a final order as provided in WAC 246-11-560.

[Statutory Authority: RCW 18.130.050(1) and 18.130.060(3). 94-04-078, § 246-11-540, filed 1/31/94, effective 3/3/94. Statutory Authority: RCW 18.130.050(1). 93-08-003 (Order 347), § 246-11-540, filed 3/24/93, effective 4/24/93.]

## SECTION VII POST HEARING PROCESS

**WAC 246-11-550 Appeal from initial order.** (1) Any party may file a written petition for administrative review of an initial order issued under WAC 246-11-430 or WAC 246-11-540 stating the specific grounds upon which exception is taken and the relief requested.

(2) Petitions for administrative review must be served upon the opposing party and filed with the office of the board within twenty-one days of service of the initial order.

(3) The opposing party may file a response to a petition for administrative review as provided in this section. The response shall be filed at the place specified in subsection (2) of this section. The party filing the response shall serve

a copy of the response upon the party requesting administrative review. If the initial order was entered pursuant to WAC 246-11-430, the response will be filed within ten days of service of the petition. In all other matters, the response will be filed within twenty days of service of the petition.

[Statutory Authority: RCW 18.130.050 and 43.70.040. 96-21-027, § 246-11-550, filed 10/7/96, effective 11/7/96. Statutory Authority: RCW 18.130.050(1) and 34.05.464. 93-08-003 (Order 347), § 246-11-550, filed 3/24/93, effective 4/24/93.]

**WAC 246-11-560 Final orders.** (1) The form and content of final orders shall be as follows:

(a) Final orders shall contain findings of fact, conclusions of law, and an order. All final orders shall be signed by a member of the panel of board members who heard the matter.

(b) Final orders may adopt by reference the initial order in whole or in part.

(c) Final orders may modify or revise the initial order in whole or in part.

(2) Final orders shall be served upon the parties and their representatives as provided in WAC 246-11-080.

(3) Final orders shall be issued following:

(a) A review of the record;

(b) A review of the initial order, if any;

(c) A review of any request for review of the initial order and any response thereto; and

(d) Consideration of protection of the public health and welfare.

(4) Unless a later date is stated in the final order, final orders shall be effective when entered but a party shall not be required to comply with a final order until the order is served upon that party.

(5) Final orders may contain orders that specified portions of the agency record shall not be disclosed as public records if necessary to protect privacy interests, the public welfare, or vital governmental functions. Such orders shall include but are not limited to protective orders issued during the proceeding or pursuant to WAC 246-11-400.

[Statutory Authority: RCW 18.130.050(1) and 18.130.060(3). 94-04-078, § 246-11-560, filed 1/31/94, effective 3/3/94. Statutory Authority: RCW 18.130.050(1), 34.05.464, 34.05.473 and chapter 42.17 RCW. 93-08-003 (Order 347), § 246-11-560, filed 3/24/93, effective 4/24/93.]

**WAC 246-11-570 Stay of final orders.** No final order will be stayed except by its own terms or by order of a court of competent jurisdiction.

[Statutory Authority: RCW 18.130.050(1) and 34.05.467. 93-08-003 (Order 347), § 246-11-570, filed 3/24/93, effective 4/24/93.]

**WAC 246-11-580 Reconsideration of final orders.**

(1) Within ten days of service of a final order, either party may file a petition for reconsideration, stating the specific grounds upon which reconsideration is requested and the relief requested.

(2) Grounds for reconsideration shall be limited to:

(a) Specific errors of fact or law; or

(b) Implementation of the final order would require department activities inconsistent with current department practice; or

(c) Specific circumstances render the person requesting the reconsideration unable to comply with the terms of the order.

(3) Petitions for reconsideration must be served upon the opposing party and filed with the office of the board within ten days of service of the final order.

(4) If reconsideration is requested based on an error of fact, the request for reconsideration shall contain specific reference to the record. If reconsideration is requested based on testimony of record, the request for reconsideration shall contain specific reference to the testimony. The presiding officer may require that the party requesting reconsideration submit a copy of the transcript of the adjudicative proceeding and provide specific reference to the transcript.

(5) The petition for reconsideration is denied if, within twenty days of the date the petition is filed, the presiding officer:

(a) Denies the petition;

(b) Does not act upon the petition; or

(c) Does not serve the parties with notice of the date by which he/she will act on the petition.

(6) If the presiding officer determines to act upon the petition, the opposing party shall be provided at least ten days in which to file a response to the petition.

(7) Disposition of petitions for reconsideration shall be in the form of a written order denying the petition, granting the petition and dissolving or modifying the final order, or granting the petition and setting the matter for further proceedings.

[Statutory Authority: RCW 18.130.050(1) and 18.130.060(3). 94-04-078, § 246-11-580, filed 1/31/94, effective 3/3/94. Statutory Authority: RCW 18.130.050(1) and 34.05.470. 93-08-003 (Order 347), § 246-11-580, filed 3/24/93, effective 4/24/93.]

**WAC 246-11-590 Agency record of adjudicative proceedings.** (1) The department shall maintain an official record of each adjudicative proceeding.

(2) The record shall include:

(a) Notices of all proceedings;

(b) Any prehearing order;

(c) Any motions, pleadings, briefs, petitions, and requests filed, and rulings thereon;

(d) Evidence received or considered;

(e) A statement of matters officially noted;

(f) Offers of proof and objections and rulings thereon;

(g) Any proposed findings, requested orders, and exceptions;

(h) Any recording of the adjudicative proceeding and any transcript of all or part of the adjudicative proceeding considered before final disposition of the matter;

(i) Any final order, initial order, or order on reconsideration; and

(j) Matters placed on the record following an ex parte communication, if any.

(3) The record shall be subject to disclosure as provided by RCW 42.17.250 through 42.17.340, and by WAC 246-11-130, except as limited by protective orders and provisions contained in the final order.

[Statutory Authority: RCW 18.130.050(1) and 18.130.060(3). 94-04-078, § 246-11-590, filed 1/31/94, effective 3/3/94. Statutory Authority: RCW 18.130.050(1), 34.05.476 and chapter 42.17 RCW. 93-08-003 (Order 347), § 246-11-590, filed 3/24/93, effective 4/24/93.]



**WAC 246-11-600 Judicial review.** (1) Judicial review of actions taken under this chapter shall be as provided in RCW 34.05.510 et seq.

(2) Notice of the opportunity for judicial review shall be provided in all final orders.

(3) Following a request for judicial review, the record forwarded to the reviewing court shall be those portions of the agency record designated by the parties within the time period set by the board.

[Statutory Authority: RCW 18.130.050(1) and 18.130.060(3). 94-04-078, § 246-11-600, filed 1/31/94, effective 3/3/94. Statutory Authority: RCW 18.130.050(1) and 34.05.510. 93-08-003 (Order 347), § 246-11-600, filed 3/24/93, effective 4/24/93.]

**WAC 246-11-610 Vacating an order for reason of default or withdrawal.** (1) A party may petition to vacate a default order entered against that party for failing to attend an adjudicative proceeding requested by that party by:

(a) Specifying the grounds relied upon in the petition; and

(b) Filing the petition at the office of professional standards within seven days of service of the default order.

(2) The presiding officer shall consider the petition and shall:

(a) Grant the motion to vacate and reinstate the application for adjudicative proceeding, and may impose conditions on licensure pending final adjudication; or

(b) Deny the motion to vacate the default order.

[Statutory Authority: RCW 18.130.050(1) and 18.130.060(3). 94-04-078, § 246-11-610, filed 1/31/94, effective 3/3/94. Statutory Authority: RCW 18.130.050(1) and 34.05.220. 93-08-003 (Order 347), § 246-11-610, filed 3/24/93, effective 4/24/93.]

**Chapter 246-15 WAC**

**WHISTLEBLOWER COMPLAINTS IN HEALTH CARE SETTINGS**

**WAC**

246-15-001	Purpose and scope.
246-15-010	Definitions.
246-15-020	Rights and responsibilities—Whistleblower and department.
246-15-030	Procedures for filing, investigation, and resolution of whistleblower complaints.

**WAC 246-15-001 Purpose and scope.** Regulations for whistleblower protection are hereby adopted pursuant to RCW 43.70.075. The purpose of these regulations is to protect the identity of persons who communicate in good faith to the department alleging the improper quality of care by a health care facility or provider as defined in this chapter, and set forth the process the department will use in receiving, investigating and resolving complaints.

[Statutory Authority: RCW 43.70.075 and 43.70.040. 97-02-013, § 246-15-001, filed 12/20/96, effective 1/20/97.]

**WAC 246-15-010 Definitions.** The words and phrases in this chapter have the following meanings unless the context clearly indicates otherwise.

(1) "Consumer" means:

(a) An individual receiving health care or services from a health care facility or health care professional;

(b) A person pursuant to RCW 7.70.065 authorized to provide informed consent to health care on behalf of (a) of this subsection who is not competent to consent.

(2) "Department" means the Washington state department of health.

(3) "Employee" means an individual employed by a health care facility or health care professional at the time the:

(a) Alleged improper quality of care occurred; or

(b) Alleged improper quality of care is discovered.

(4) "Good faith" means an honest and reasonable belief in the truth of the allegation.

(5) "Health care" means any care, service, or procedure provided by a health care facility or a health care provider:

(a) To diagnose, treat, or maintain a patient's physical or mental condition; or

(b) That affects the structure or function of the human body.

(6) "Health care facility" includes the following:

(a) Adult residential rehabilitation centers regulated pursuant to chapter 71.12 RCW;

(b) Alcoholism treatment facilities regulated pursuant to chapter 71.12 RCW;

(c) Alcoholism hospitals regulated pursuant to chapter 71.12 RCW;

(d) Ambulance and aid services regulated pursuant to chapter 18.73 RCW;

(e) Boarding homes regulated pursuant to chapter 18.20 RCW;

(f) Childbirth centers regulated pursuant to chapter 18.46 RCW;

(g) Home care agencies regulated pursuant to chapter 70.127 RCW;

(h) Home health agencies regulated pursuant to chapter 70.127 RCW;

(i) Hospice agencies regulated pursuant to chapter 70.127 RCW;

(j) Hospitals regulated pursuant to chapter 70.41 RCW;

(k) Pharmacies regulated pursuant to chapter 18.64 RCW;

(l) Private psychiatric hospitals regulated pursuant to chapter 71.12 RCW;

(m) Residential treatment facilities for psychiatrically impaired children and youth regulated pursuant to chapter 71.12 RCW;

(n) Rural health care facilities regulated pursuant to chapter 70.175 RCW.

(7) "Health care provider," "health care professional," "professional" or "provider" mean a person who is licensed, certified, registered or otherwise authorized by the law of this state to provide health care in the ordinary course of business or practice of a profession.

(8) "Improper quality of care," as defined in RCW 43.70.075, means any practice, procedure, action, or failure to act that violates any state law or rule of the applicable state health licensing authority under Title 18 RCW or chapters 70.41, 70.96A, 70.127, 70.175, 71.05, 71.12, and 71.24 RCW, and enforced by the department of health. Improper quality of care shall not include good faith personnel actions related to employee performance or actions taken according to established terms and conditions of employ-

ment. Good faith personnel action will not prevent investigations of alleged improper quality of care.

(9) "Whistleblower" means a consumer, employee, or health care professional who in good faith reports alleged quality of care concerns to the department of health.

[Statutory Authority: RCW 43.70.075 and 43.70.040. 97-02-013, § 246-15-010, filed 12/20/96, effective 1/20/97.]

**WAC 246-15-020 Rights and responsibilities—Whistleblower and department.** (1) A person who in good faith communicates a complaint or information as defined in this chapter as provided in RCW 43.70.075 is:

(a) Immune from civil liability on claims based upon that communication to the department under RCW 4.24.510;

(b) Entitled to recover costs and reasonable attorneys' fees incurred in establishing a defense under RCW 4.24.510 if prevailing upon the defense; and

(c) Afforded the protections and remedies of the human rights commission pursuant to chapter 49.60 RCW. The department will refer whistleblowers expressing concern about reprisal or retaliatory action to the human rights commission.

(2) The department will protect the identity of the whistleblower by revealing it only:

(a) To appropriate department staff or disciplining authority member;

(b) By court order; or

(c) If the complaint is not in good faith.

[Statutory Authority: RCW 43.70.075 and 43.70.040. 97-02-013, § 246-15-020, filed 12/20/96, effective 1/20/97.]

**WAC 246-15-030 Procedures for filing, investigation, and resolution of whistleblower complaints.** In filing, investigating and resolving a whistleblower complaint, the department will follow its usual procedures for complaint processing while protecting a whistleblower's identity consistent with WAC 246-15-020.

(1) Filing.

(a) Upon receipt of a complaint from a whistleblower alleging improper quality of care, department staff will enter the complaint into the tracking system for complaints against health care providers or facilities and create a file on that complaint.

(b) Staff will affix a permanent cover to the letter of complaint, or other form of notice, in the complaint file, noting the statutory citation for protection of identity of the complainant.

(c) Staff will assess priority of the case and conduct the initial case planning based on the complainant information.

(2) Investigation.

(a) For cases assigned to an investigation, staff will develop an investigative plan. The investigator will gather pertinent information and perform other functions as appropriate to the allegation. The investigator may interview witnesses or others with information relevant to the investigation, review records and consult with staff of other agencies.

(b) At the conclusion of the investigation, the investigator will prepare the necessary documents, such as an investigative report summarizing the findings, and other

documents necessary for the department to take further action.

(3) Resolution. The regulatory authority for the health facility or provider will:

(a) Review investigative findings to determine violation of any statutes or rules;

(b) Take appropriate disciplinary action as necessary;

(c) Ensure upon case closure, that the permanent cover affixed in subsection (1)(c) of this section will remain;

(d) Will code or obliterate references to the whistleblower complainant in investigative materials or in the investigative report as necessary to protect the whistleblower's identity prior to any public disclosure; and

(e) Make the case file available to the public upon case closure, subject to public disclosure and other relevant laws.

[Statutory Authority: RCW 43.70.075 and 43.70.040. 97-02-013, § 246-15-030, filed 12/20/96, effective 1/20/97.]

**Chapter 246-50 WAC  
COORDINATED QUALITY IMPROVEMENT  
PROGRAM**

**WAC**

246-50-001	Purpose and scope.
246-50-010	Definitions.
246-50-020	Coordinated quality improvement program— Components.
246-50-030	Approval process—Public disclosure.
246-50-040	Alternative programs.
246-50-990	Fees.

**WAC 246-50-001 Purpose and scope.** (1) This chapter establishes the criteria and approval process for health care entities who choose to apply for a department of health approved coordinated quality improvement program pursuant to RCW 43.70.510. Coordinated quality improvement programs approved by the department are provided discovery limitations pursuant to RCW 43.70.510 (3) and (4). Information and documents created specifically for, and collected and maintained by an approved quality improvement committee are also exempt from disclosure under chapter 42.17 RCW.

(2) This chapter allows health care provider groups, professional societies or organizations, health care service contractors, health maintenance organizations, health carriers approved pursuant to chapter 48.43 RCW, and any other person or entity providing health care coverage under chapter 48.42 RCW that is subject to the jurisdiction and regulation of any state agency or any subdivision thereof and health care institutions and medical facilities other than hospitals, to maintain a department-approved coordinated quality improvement program for the purpose of improving the quality of health care and identifying and preventing health care malpractice.

(3) Programs submitted for department approval should be consistent with the principles for the continuous improvement of the Washington state health care system published by the health care policy board.

(4) This chapter does not apply to hospital quality improvement programs required by RCW 70.41.200.

[Statutory Authority: RCW 43.70.510. 96-09-042, § 246-50-001, filed 4/11/96, effective 5/12/96; 94-24-001, § 246-50-001, filed 11/23/94, effective 12/24/94.]

**WAC 246-50-010 Definitions.** The words and phrases in this chapter have the following meanings unless the context clearly indicates otherwise.

(1) "Alternative program" means a coordinated quality improvement program determined by the department to be substantially equivalent to RCW 70.41.200(1).

(2) "Department" means the Washington state department of health.

(3) "Governing body" means:

(a) The person, persons or board responsible for the health care entity; or

(b) In the case of a provider group where no person, persons or board is in charge of all providers; the person, persons or group identified by the provider group to be responsible for the coordinated quality improvement program.

(4) "Health care entity" means a health care institution, medical facility, provider group, professional society or organization, health care service contractors, health maintenance organizations, health carriers approved pursuant to chapter 48.43 RCW, and any other person or entity providing health care coverage under chapter 48.42 RCW that is subject to the jurisdiction of any state agency or any subdivision thereof, authorized by RCW 43.70.510 to have a department-approved coordinated quality improvement program.

(5) "Health care institution" or "medical facility" includes the following:

(a) Adult residential rehabilitation centers regulated pursuant to chapter 71.12 RCW;

(b) Alcoholism treatment facilities regulated pursuant to chapters 71.12 and 70.96A RCW;

(c) Alcoholism hospitals regulated pursuant to chapters 71.12 and 70.96A RCW;

(d) Ambulance and aid services regulated pursuant to chapter 18.73 RCW;

(e) Boarding homes regulated pursuant to chapter 18.20 RCW;

(f) Childbirth centers regulated pursuant to chapter 18.46 RCW;

(g) Community mental health centers regulated pursuant to chapter 71.05 or 71.24 RCW;

(h) Eye banks regulated pursuant to RCW 68.50.630;

(i) Home health agencies regulated pursuant to chapter 70.127 RCW;

(j) Hospice care centers regulated pursuant to chapter 70.41 RCW;

(k) Hospice agencies regulated pursuant to chapter 70.127 RCW;

(l) Medical test sites regulated pursuant to chapter 70.42 RCW;

(m) Nursing homes regulated pursuant to chapter 18.51 RCW;

(n) Pharmacies regulated pursuant to chapter 18.64 RCW;

(o) Private psychiatric hospitals regulated pursuant to chapter 71.12 RCW;

(p) Residential treatment facilities for psychiatrically impaired children and youth regulated pursuant to chapter 71.12 RCW;

(q) Rural health facilities regulated pursuant to chapter 70.175 RCW;

(r) Facilities owned and operated by a political subdivision or instrumentality of the state, including, but not limited to:

(i) Public health departments;

(ii) Fire districts and departments;

(iii) Soldiers' and veterans' homes;

(iv) State mental health institutions;

(v) Health clinics operated by educational institutions;

(vi) Department of corrections health care facilities;

(vii) County jail health clinics; and

(viii) County drug and alcohol treatment facilities;

(s) Facilities required by federal law and implementing regulations, including, but not limited to:

(i) Native American health facilities; and

(ii) Veterans' affairs health services; and

(t) Other facilities determined by the department to be within the parameters of the definition of "health care facility" in RCW 43.72.010.

(6) "Health care provider" or "provider" means:

(a) A person regulated under Title 18 RCW to practice health or health related services or otherwise practicing health care services in this state consistent with state law; or

(b) An employee or agent of a person described in (a) of this subsection, acting in the course and scope of the employee's or agent's employment performing health care or auxiliary services.

(7) "Health care provider group" or "provider group" means an organized body of ten or more providers.

(8) "Negative health care outcome" means a patient death or impairment of bodily function other than those related to the natural course of illness, disease or proper treatment in accordance with generally accepted health care standards.

(9) "Professional society or organization" means a group of health care professionals, including, but not limited to, state or local health care professional associations.

(10) "Program" means coordinated quality improvement program pursuant to RCW 43.70.510.

[Statutory Authority: RCW 43.70.510. 96-09-042, § 246-50-010, filed 4/11/96, effective 5/12/96; 94-24-001, § 246-50-010, filed 11/23/94, effective 12/24/94.]

**WAC 246-50-020 Coordinated quality improvement program—Components.** A program under the provisions of RCW 43.70.510 shall include, at a minimum:

(1) The following components:

(a) A governing body;

(b) A committee, appointed by the governing body, with a broad representation of the services offered, responsible for:

(i) Reviewing services rendered, both retrospectively and prospectively, to improve the quality of health care by measuring key characteristics such as effectiveness, accuracy, timeliness, and cost;

(ii) Reviewing categories and methodologies of services rendered and to be rendered with the goal of improving health care outcomes;

(iii) Overseeing and coordinating the program;

(iv) Ensuring information gathered for the program is reviewed and used to revise health care policies and procedures; and

(v) Reporting to the governing body, at least semiannually, on program activities and actions taken as a result of those activities;

(c) Periodic evaluation of each provider under the purview of the program, including mental and physical capacity, competence in delivering health care, and verification of current credentials;

(d) A procedure for promptly resolving all complaints pertaining to accidents, injuries, treatment and other events that may result in claims of health care malpractice;

(e) A method for continually collecting and maintaining information concerning:

(i) Experience with negative health care outcomes and injurious incidents; and

(ii) Professional liability premiums, settlements, awards, costs for injury prevention and safety improvement activities;

(f) A method for maintaining information gathered under the purview of the program concerning a provider in that provider's personnel or credential file, assuring patient confidentiality;

(g) A process for reporting accidents, injuries, negative health outcomes, and other pertinent information to the quality improvement committee;

(h) A process assuring compliance with reporting requirements to appropriate local, state and federal authorities;

(i) A method for identifying documents and records created specifically for and collected and maintained by the quality improvement committee;

(j) Educational activities for personnel engaged in health care activities, including, but not limited to:

(i) Quality improvement;

(ii) Safety and injury prevention;

(iii) Responsibilities for reporting professional misconduct;

(iv) Legal aspects of providing health care;

(v) Improving communication with health care recipients; and

(vi) Causes of malpractice claims; or

(2) Components determined by the department to be substantially equivalent to subsection (1) of this section.

[Statutory Authority: RCW 43.70.510. 94-24-001, § 246-50-020, filed 11/23/94, effective 12/24/94.]

**WAC 246-50-030 Approval process—Public disclosure.** (1) A health care entity seeking department approval of a program shall submit to the department:

(a) An application on forms provided by the department;

(b) The program plan, printed on 8 1/2 by 11 inch paper, including:

(i) A table of contents clearly denoting, at a minimum, where each component specified in WAC 246-50-020 is located within the program plan; and

(ii) A detailed description of every aspect of the program;

(c) The fee specified in WAC 246-50-990; and

(d) Other information as may be required by the department.

(2) To maintain department approval, a health care entity modifying the scope, components or operation of an approved program, shall submit to the department:

(a) An application package specified in subsection (1) of this section; and

(b) A detailed description of the modification and how it affects the program.

(3) The department shall review each application package submitted pursuant to this section, and:

(a) Send written notification of approval to a health care entity submitting a program with the components specified in WAC 246-50-020; or

(b) Provide the health care entity an opportunity for a brief adjudicative proceeding according to RCW 34.05.482 when the department declines to approve a program.

(4) The department shall retain a copy of the program plan. Material received by the department will be subject to the public disclosure law, chapter 42.17 RCW. Health care entities submitting material that they believe is exempt from public disclosure should conspicuously mark the portion or portions and state the basis for exemption. The department will give notice to the submitting entity of any request under the Public Disclosure Act for public disclosure of material that has been marked in accordance with this subsection at least ten working days in advance of releasing the information. This will allow the submitting party to invoke the provisions of RCW 42.17.330.

[Statutory Authority: RCW 43.70.510. 94-24-001, § 246-50-030, filed 11/23/94, effective 12/24/94.]

**WAC 246-50-040 Alternative programs.** A health care entity seeking department approval of an alternative program shall submit to the department, in addition to the items specified in WAC 246-50-030(1), verification of certification or accreditation by an organization approved by the department.

[Statutory Authority: RCW 43.70.510. 94-24-001, § 246-50-040, filed 11/23/94, effective 12/24/94.]

**WAC 246-50-990 Fees.** A health care entity shall submit a fee with each application for department approval as follows:

(1) A coordinated quality improvement program pursuant to WAC 246-50-030(1) — two hundred fifty dollars;

(2) An alternative program pursuant to WAC 246-50-040 — forty dollars; and

(3) Modification of a department-approved program pursuant to WAC 246-50-030(2) — sixty-five dollars.

[Statutory Authority: RCW 43.70.510. 94-24-001, § 246-50-990, filed 11/23/94, effective 12/24/94.]

**Chapter 246-100 WAC**  
**COMMUNICABLE AND CERTAIN OTHER**  
**DISEASES**

**WAC**

246-100-006	Purpose.
246-100-011	Definitions.
246-100-016	Confidentiality.
246-100-021	Responsibilities and duties—Health care providers.
246-100-026	Responsibilities and duties—Veterinarians.
246-100-031	Responsibilities and duties—Laboratory directors.
246-100-036	Responsibilities and duties—Local health officers.
246-100-041	Responsibilities and duties—State health officer.
246-100-042	Reporting of blood lead levels.
246-100-046	Responsibilities and duties—Cases, suspected cases, carriers, contacts, and others.
246-100-071	Responsibility for reporting to and cooperating with the local health department.
246-100-072	Rules for notification of partners at-risk of HIV infection.
246-100-076	Reportable diseases and conditions.
246-100-081	Reports—Content—Time—Hospital monthly report permitted for certain diseases.
246-100-086	Reporting diseases and conditions directly to department.
246-100-091	Handling of reports by local health department—Handling of reports by department.
246-100-166	Immunization of child care and school children against certain vaccine-preventable diseases.
246-100-171	Special settings—Food service establishments.
246-100-176	Special settings—Schools.
246-100-181	Special settings—Child day care facilities.
246-100-186	Special settings—Health care facilities.
246-100-191	Animals, birds, pets—Measures to prevent human disease.
246-100-196	Animal bites—Report to local health department.
246-100-201	Birds—Measures to prevent psittacosis.
246-100-206	Special diseases—Sexually transmitted diseases.
246-100-207	Human immunodeficiency virus (HIV) testing—Ordering—Laboratory screening—Interpretation—Reporting.
246-100-208	Counseling standard—AIDS counseling.
246-100-209	Counseling standards—Human immunodeficiency virus (HIV) pretest counseling—HIV post-test counseling.
246-100-211	Special diseases—Tuberculosis.
246-100-216	Special diseases—Surveillance for influenza.
246-100-217	Special condition—Pesticide poisoning.
246-100-218	Special condition—Gunshot wounds.
246-100-231	Duties of laboratories—Submission of specimens by laboratories.
246-100-236	Duties of laboratories—Reporting of laboratory results indicative of certain reportable diseases.
246-100-241	Duties of laboratories—Duty to cooperate with local health departments and the department.

**DISPOSITION OF SECTIONS FORMERLY**  
**CODIFIED IN THIS CHAPTER**

246-100-221	Duties of laboratories—Annual registration of laboratories. [Statutory Authority: RCW 43.20.050. 91-02-051 (Order 124B), recodified as § 246-100-221, filed 12/27/90, effective 1/31/91; 87-11-047 (Order 302), § 248-100-221, filed 5/19/87.] Repealed by 96-19-043, filed 9/12/96, effective 10/13/96. Statutory Authority: RCW 43.20.050.
246-100-226	Duties of laboratories—Approval of laboratories to perform prenatal serologic tests for syphilis. [Statutory Authority: RCW 43.20.050. 92-02-019 (Order 225B), § 246-100-226, filed 12/23/91, effective 1/23/92; 91-02-051 (Order 124B), recodified as § 246-100-226, filed 12/27/90, effective 1/31/91; 87-11-047 (Order 302), § 248-100-226, filed 5/19/87.] Repealed by 96-19-043, filed 9/12/96, effective 10/13/96. Statutory Authority: RCW 43.20.050.

**WAC 246-100-006 Purpose.** The following rules and regulations are adopted under the authority of chapter 43.20 RCW to protect the health and well-being of the public by controlling communicable and certain other diseases.

[Statutory Authority: RCW 43.20.050. 91-02-051 (Order 124B), recodified as § 246-100-006, filed 12/27/90, effective 1/31/91; 87-11-047 (Order 302), § 248-100-006, filed 5/19/87.]

**WAC 246-100-011 Definitions.** The following definitions shall apply in the interpretation and enforcement of chapter 246-100 WAC:

(1) "Acquired immunodeficiency syndrome (AIDS)" means illness, disease, or conditions defined and described by the Centers for Disease Control, U.S. Public Health Service, Morbidity and Mortality Weekly Report (MMWR), December 18, 1992, Volume 41, Number RR-17.

(2) "AIDS counseling" means counseling directed toward:

(a) Increasing the individual's understanding of acquired immunodeficiency syndrome; and

(b) Assessing the individual's risk of HIV acquisition and transmission; and

(c) Affecting the individual's behavior in ways to reduce the risk of acquiring and transmitting HIV infection.

(3) "Board" means the Washington state board of health.

(4) "Carrier" means a person harboring a specific infectious agent and serving as a potential source of infection to others, but who may or may not have signs and/or symptoms of the disease.

(5) "Case" means a person, alive or dead, having been diagnosed to have a particular disease or condition by a health care provider with diagnosis based on clinical or laboratory criteria or both.

(6) "Category A disease or condition" means a reportable disease or condition of urgent public health importance, a case or suspected case of which must be reported to the local or state health officer immediately at the time of diagnosis or suspected diagnosis.

(7) "Category B disease or condition" means a reportable disease or condition of public health importance, a case of which must be reported to the local health officer no later than the next working day following date of diagnosis.

(8) "Category C disease or condition" means a reportable disease or condition of public health importance, a case of which must be reported to the local health officer within seven days of diagnosis.

(9) "Child day care facility" means an agency regularly providing care for a group of children for less than twenty-four hours a day and subject to licensing under chapter 74.15 RCW.

(10) "Communicable disease" means an illness caused by an infectious agent which can be transmitted from one person, animal, or object to another person by direct or indirect means including transmission via an intermediate host or vector, food, water, or air.

(11) "Contact" means a person exposed to an infected person, animal, or contaminated environment which might provide an opportunity to acquire the infection.

(12) "Department" means the Washington state department of social and health services.

(13) "Detention" or "detainment" means physical restriction of activities of an individual by confinement, consistent with WAC 246-100-206(8), for the purpose of monitoring and eliminating behaviors presenting imminent danger to public health and may include physical plant, facilities, equipment, and/or personnel to physically restrict activities of the individual to accomplish such purposes.

(14) "Food handler" means any person preparing, processing, handling, or serving food or beverages for people other than members of his or her household.

(15) "Food service establishment" means any establishment where food or beverages are prepared for sale or service on the premises or elsewhere, and any other establishment or operation where food is served or provided for the public with or without charge.

(16) "Health care facility" means:

(a) Any facility or institution licensed under chapter 18.20 RCW, boarding home, chapter 18.46 RCW, maternity homes, chapter 18.51 RCW, nursing homes, chapter 70.41 RCW, hospitals, or chapter 71.12 RCW, private establishments, clinics, or other settings where one or more health care providers practice; and

(b) In reference to a sexually transmitted disease, other settings as defined in chapter 70.24 RCW.

(17) "Health care provider" means any person having direct or supervisory responsibility for the delivery of health care or medical care who is:

(a) Licensed or certified in this state under Title 18 RCW; or

(b) Is military personnel providing health care within the state regardless of licensure.

(18) "HIV testing" means conducting a laboratory test or sequence of tests to detect the human immunodeficiency virus (HIV) or antibodies to HIV performed in accordance with requirements to WAC 246-100-207. To assure that the protection, including but not limited to, pre- and post-test counseling, consent, and confidentiality afforded to HIV testing as described in chapter 246-100 WAC also applies to the enumeration of CD4+ (T4) lymphocyte counts (CD4+ counts) and CD4+ (T4) percents of total lymphocytes (CD4+ percents) when used to diagnose HIV infection, CD4+ counts and CD4+ percents will be presumed HIV testing except when shown by clear and convincing evidence to be for use in the following circumstances:

(a) Monitoring previously diagnosed infection with HIV;

(b) Monitoring organ or bone marrow transplants;

(c) Monitoring chemotherapy;

(d) Medical research; or

(e) Diagnosis or monitoring of congenital immunodeficiency states or autoimmune states not related to HIV.

The burden of proving the existence of one or more of the circumstances identified in (a) through (e) of this subsection shall be on the person asserting such existence.

(19) "Infection control measures" means the management of infected persons, persons suspected to be infected, and others in such a manner as to prevent transmission of the infectious agent.

(20) "Isolation" means the separation or restriction of activities of infected persons, or of persons suspected to be infected, from other persons to prevent transmission of the infectious agent.

(21) "Laboratory director" means the director or manager, by whatever title known, having the administrative responsibility in any medical laboratory.

(22) "Local health department" means the city, town, county, or district agency providing public health services to persons within the area, as provided in chapter 70.05 RCW and chapter 70.08 RCW.

(23) "Local health officer" means the individual having been appointed under chapter 70.05 RCW as the health officer for the local health department, or having been appointed under chapter 70.08 RCW as the director of public health of a combined city-county health department.

(24) "Medical laboratory" means any facility analyzing specimens of original material from the human body for purposes of patient care.

(25) "Nosocomial infection" means an infection acquired in a hospital or other health care facility.

(26) "Outbreak" means the occurrence of cases of a disease or condition in any area over a given period of time in excess of the expected number of cases.

(27) "Post-test counseling" means counseling after the HIV test when results are provided and directed toward:

(a) Increasing the individual's understanding of human immunodeficiency virus (HIV) infection;

(b) Affecting the individual's behavior in ways to reduce the risk of acquiring and transmitting HIV infection;

(c) Encouraging the individual testing positive to notify persons with whom there has been contact capable of spreading HIV;

(d) Assessing emotional impact of HIV test results; and

(e) Appropriate referral for other community support services.

(28) "Pretest counseling" means counseling provided prior to HIV testing and aimed at:

(a) Helping an individual to understand:

(i) Ways to reduce the risk of human immunodeficiency virus (HIV) transmission;

(ii) The nature, purpose, and potential ramifications of HIV testing;

(iii) The significance of the results of HIV testing; and

(iv) The dangers of HIV infection; and

(b) Assessing the individual's ability to cope with the results of HIV testing.

(29) "Principal health care provider" means the attending physician or other health care provider recognized as primarily responsible for diagnosis and treatment of a patient or, in the absence of such, the health care provider initiating diagnostic testing or therapy for a patient.

(30) "Quarantine" means the separation or restriction on activities of a person having been exposed to or infected with an infectious agent, to prevent disease transmission.

(31) "Reportable disease or condition" means a disease or condition of public health importance, a case of which, and for certain diseases, a suspected case of which, must be brought to the attention of the local health officer.

(32) "School" means a facility for programs of education as defined in RCW 28A.210.070 (preschool and kindergarten through grade twelve).

(33) "Sexually transmitted disease (STD)" means a bacterial, viral, fungal, or parasitic disease or condition which is usually transmitted through sexual contact, including:



- (a) Acute pelvic inflammatory disease;
- (b) Chancroid;
- (c) Chlamydia trachomatis infection;
- (d) Genital and neonatal herpes simplex;
- (e) Genital human papilloma virus infection;
- (f) Gonorrhea;
- (g) Granuloma inguinale;
- (h) Hepatitis B infection;
- (i) Human immunodeficiency virus infection (HIV) and acquired immunodeficiency syndrome (AIDS);
- (j) Lymphogranuloma venereum;
- (k) Nongonococcal urethritis (NGU); and
- (l) Syphilis.

(34) "State health officer" means the person designated by the secretary of the department to serve as statewide health officer, or, in the absence of such designation, the person having primary responsibility for public health matters in the state.

(35) "Suspected case" means a person whose diagnosis is thought likely to be a particular disease or condition with suspected diagnosis based on signs and symptoms, laboratory evidence, or both.

(36) "Unusual communicable disease" means a communicable disease which is not commonly seen in the state of Washington but which is of general public health concern including, but not limited to, Lassa fever, smallpox, typhus, and yellow fever.

(37) "Veterinarian" means an individual licensed under provisions of chapter 18.92 RCW, veterinary medicine, surgery, and dentistry and practicing animal health care.

[Statutory Authority: Chapter 70.24 RCW. 93-08-036 (Order 354B), § 246-100-011, filed 4/1/93, effective 5/2/93. Statutory Authority: RCW 43.20.050 and 70.24.130. 92-02-019 (Order 225B), § 246-100-011, filed 12/23/91, effective 1/23/92. Statutory Authority: RCW 43.20.050. 91-02-051 (Order 124B), recodified as § 246-100-011, filed 12/27/90, effective 1/31/91. Statutory Authority: Chapter 70.24 RCW. 89-07-095 (Order 325), § 248-100-011, filed 3/22/89; 88-17-057 (Order 317), § 248-100-011, filed 8/17/88. Statutory Authority: RCW 43.20.050. 88-07-063 (Order 308), § 248-100-011, filed 3/16/88; 87-11-047 (Order 302), § 248-100-011, filed 5/19/87.]

**WAC 246-100-016 Confidentiality.** Identifying information about any individual with a reportable disease or condition pursuant to chapter 246-100 WAC shall be protected by persons with knowledge of such identity.

(1) Health care providers, employees of a health care facility or medical laboratory, and other individuals with knowledge of a person with sexually transmitted disease, following the basic principles of health care providers, which respect the human dignity and confidentiality of patients:

(a) May disclose identity of a person or release identifying information only as specified in RCW 70.24.105; and

(b) Shall establish and implement policies and procedures to maintain confidentiality related to a patient's medical information.

(2) For the purpose of RCW 70.24.105(6), customary methods for exchange of medical information shall be limited as follows:

(a) Health care providers may exchange confidential medical information related to HIV testing, HIV test results, and confirmed HIV or confirmed STD diagnosis and treatment in order to provide health care services to the patient. Meaning:

(i) The information shared impacts the care or treatment decisions concerning the patient; and

(ii) The health care provider requires the information for the patient's benefit.

(b) "Health care services to the patient" means personal interaction, treatment, consultation, or intervention for patient care.

(c) Health care facility administrators are authorized to permit access to medical information as necessary to fulfill professional duties. Health care facility administrators shall advise those persons permitted access under this section of the requirement to maintain confidentiality of such information as defined under this section and chapter 70.24 RCW. Professional duties means the following or functionally similar activities:

(i) Medical record or chart audits;

(ii) Peer reviews;

(iii) Quality assurance;

(iv) Utilization review purposes;

(v) Research review board reviews under chapter 42.48 RCW;

(vi) Risk management; and

(vii) Reviews required under federal or state law or rules.

(d) Health care facility administrators and health care providers responsible for office management are authorized to permit access to a patient's medical information and medical record by health care facility and medical staff or office staff to carry out duties required for care and treatment of a patient and the management of medical information and the patient's medical record.

(e) Health care facility administrators are authorized to permit exchange of medical information for training and teaching of health care providers and students when exchange of confidential medical information is necessary for such training and specifically related to the care of the patient.

(3) Health care providers, employees of a health care facility or medical laboratory, and other individuals with knowledge of a person with a reportable disease or condition, other than those specified in subsections (1) and (2) of this section, shall release identifying information only to other individuals responsible for protecting the health and well being of the public through control of communicable and certain other diseases.

(4) Local and state health department personnel shall maintain individual case reports as confidential records consistent with WAC 246-100-091.

(5) The Washington state public health laboratory, other laboratories approved as public health referral laboratories, and any persons, institutions, or facilities submitting specimens or records containing patient-identifying information shall maintain the identifying information accompanying submitted laboratory specimens as confidential records.

(6) Statistical summaries and epidemiologic studies based on individual case reports may be public information provided no individual is identified.

[Statutory Authority: RCW 43.20.050 and 70.24.130. 92-02-019 (Order 225B), § 246-100-016, filed 12/23/91, effective 1/23/92. Statutory Authority: RCW 43.20.050. 91-02-051 (Order 124B), recodified as § 246-100-016, filed 12/27/90, effective 1/31/91. Statutory Authority: RCW 70.24.105. 90-07-033 (Order 043), § 248-100-016, filed 3/14/90, effective

4/14/90. Statutory Authority: Chapter 70.24 RCW. 88-21-093 (Order 322), § 248-100-016, filed 10/19/88; 88-17-057 (Order 317), § 248-100-016, filed 8/17/88. Statutory Authority: RCW 43.20.050. 87-11-047 (Order 302), § 248-100-016, filed 5/19/87.]

**WAC 246-100-021 Responsibilities and duties—Health care providers.** Every health care provider, as defined in chapter 246-100 WAC, shall:

(1) Provide adequate, understandable instruction in control measures designed to prevent the spread of disease to:

- (a) Each patient with a communicable disease under his or her care,
- (b) Family of a patient with a communicable disease,
- (c) Contacts and others as appropriate to prevent spread of disease.

(2) Ensure notification of the local health officer or local health department regarding:

(a) Cases of reportable diseases and conditions. See WAC 246-100-071, 246-100-076, and 246-100-081;

(b) Outbreaks or suspected outbreaks of disease. See WAC 246-100-071, 246-100-076, and 246-100-081;

(c) Known barriers which might impede or prevent compliance with orders for infection control or quarantine; and

(d) Name, address, and other pertinent information for any case or carrier refusing to comply with prescribed infection control measures.

(3) Cooperate with public health authorities during investigation of:

(a) Circumstances of a case or suspected case of a reportable disease or condition or other communicable disease, and

(b) An outbreak or suspected outbreak of illness.

Comply with requirements in WAC 246-100-206, 246-100-211, and 246-100-217.

[Statutory Authority: RCW 43.20.050, 70.24.130 and 70.104.055. 92-02-019 (Order 225B), § 246-100-021, filed 12/23/91, effective 1/23/92. Statutory Authority: RCW 43.20.050. 91-02-051 (Order 124B), recodified as § 246-100-021, filed 12/27/90, effective 1/31/91. Statutory Authority: Chapter 70.104 RCW. 90-10-036 (Order 049), § 248-100-021, filed 4/26/90, effective 5/27/90. Statutory Authority: RCW 43.20.050. 87-11-047 (Order 302), § 248-100-021, filed 5/19/87.]

**WAC 246-100-026 Responsibilities and duties—Veterinarians.** (1) Veterinarians shall:

(a) Notify the local health officer of any human case, suspected case, outbreak, or suspected outbreak of reportable disease listed in WAC 246-100-076;

(b) Notify the state veterinarian, Washington state department of agriculture, within one working day of any animal case, suspected case, outbreak, or suspected outbreak of:

- (i) Anthrax,
- (ii) Brucellosis,
- (iii) Equine encephalitis,
- (iv) Plague,
- (v) Rabies,
- (vi) Psittacosis, and
- (vii) Tuberculosis.

(2) Upon receipt of a report of human disease, the state health officer shall immediately notify the state veterinarian of reports of:

- (a) Anthrax,
  - (b) Brucellosis,
  - (c) Psittacosis,
  - (d) Equine encephalitis,
  - (e) Plague,
  - (f) Rabies, and
  - (g) Tuberculosis in an animal handler.
- (3) Upon receipt of a report of animal disease, the state veterinarian shall notify the state health officer of reports of:
- (a) Anthrax,
  - (b) Brucellosis excluding Strain 19 disease,
  - (c) Psittacosis,
  - (d) Equine encephalitis,
  - (e) Plague,
  - (f) Rabies, and
  - (g) Tuberculosis.

[Statutory Authority: RCW 43.20.050. 92-02-019 (Order 225B), § 246-100-026, filed 12/23/91, effective 1/23/92; 91-02-051 (Order 124B), recodified as § 246-100-026, filed 12/27/90, effective 1/31/91; 88-07-063 (Order 308), § 248-100-026, filed 3/16/88.]

**WAC 246-100-031 Responsibilities and duties—Laboratory directors.** The director of each medical laboratory in the state shall:

(1) Register the laboratory with the department as described in WAC 246-100-221.

(2) Submit microbiologic cultures or subcultures or appropriate clinical material to the Washington state public health laboratory or other laboratory designated by the state health officer, as described in WAC 246-100-231.

(3) Report to the local health officer or state health officer certain positive test results, as described in WAC 246-100-236.

(4) Cooperate with local and state health department personnel in the investigation of an outbreak, suspected outbreak, case, suspected case, carrier, or contact of a communicable disease or reportable disease or condition, as described in WAC 246-100-241.

[Statutory Authority: RCW 43.20.050. 92-02-019 (Order 225B), § 246-100-031, filed 12/23/91, effective 1/23/92; 91-02-051 (Order 124B), recodified as § 246-100-031, filed 12/27/90, effective 1/31/91; 87-11-047 (Order 302), § 248-100-031, filed 5/19/87.]

**WAC 246-100-036 Responsibilities and duties—Local health officers.** (1) The local health officer shall review and determine appropriate action for:

(a) Each reported case or suspected case of a reportable disease or condition;

(b) Any disease or condition considered a threat to public health;

(c) Each reported outbreak or suspected outbreak of disease, requesting assistance from the department in carrying out investigations when necessary; and

(d) Instituting disease prevention and infection control, isolation, detention, and quarantine measures necessary to prevent the spread of communicable disease, invoking the power of the courts to enforce these measures when necessary.

(2) Local health officers shall:

(a) Submit reports to the state health officer as required in chapter 246-100 WAC;

(b) Establish a system at the local health department for maintaining confidentiality of written records and written and telephoned disease case reports consistent with WAC 246-100-016;

(c) Notify health care providers within the health district regarding requirements in this chapter;

(d) Distribute appropriate report forms to persons responsible for reporting;

(e) Notify the principal health care provider, if possible, prior to initiating a case investigation by the local health department;

(f) Make HIV testing, AIDS counseling, and pretest and post-test counseling, as defined in this chapter, available for voluntary, mandatory, and anonymous testing and counseling as required by RCW 70.24.400;

(g) Make information on anonymous HIV testing, AIDS counseling, and pretest and post-test counseling, as described under WAC 246-100-208 and 246-100-209, available;

(h) Use identifying information on HIV-infected individuals provided according to WAC 246-100-072 only:

(i) For purposes of contacting the HIV-positive individual to provide test results and post-test counseling; or

(ii) To contact sex and injection equipment-sharing partners; and

(i) Destroy documentation of referral information established in WAC 246-100-072 and this subsection containing identities and identifying information on HIV-infected individuals and at-risk partners of those individuals immediately after notifying partners or within three months, whichever occurs first.

(3) Each local health officer has the authority to:

(a) Carry out additional steps determined to be necessary to verify a diagnosis reported by a health care provider;

(b) Require any person suspected of having a reportable disease or condition to submit to examinations required to determine the presence of the disease or condition; and

(c) Investigate any case or suspected case of a reportable disease or condition or other illness, communicable or otherwise, if deemed necessary.

(4) Local health officers shall conduct investigations and institute control measures consistent with those indicated in the fifteenth edition 1990 of *Control of Communicable Diseases in Man*, edited by Abram S. Benenson, published by the American public health association, except:

(a) When superseded by more up-to-date measures, or

(b) When other measures are more specifically related to Washington state.

[Statutory Authority: RCW 43.20.050 and 70.24.130. 92-02-019 (Order 225B), § 246-100-036, filed 12/23/91, effective 1/23/92. Statutory Authority: RCW 43.20.050. 91-02-051 (Order 124B), recodified as § 246-100-036, filed 12/27/90, effective 1/31/91. Statutory Authority: Chapter 70.24 RCW. 89-02-008 (Order 324), § 248-100-036, filed 12/27/88. Statutory Authority: RCW 43.20.050. 88-07-063 (Order 308), § 248-100-036, filed 3/16/88.]

**WAC 246-100-041 Responsibilities and duties—State health officer.** (1) The state health officer shall have authority to:

(a) Require reporting of cases and suspected cases of disease and conditions in addition to those required in WAC 246-100-076 for a period of time less than thirty-six months when:

(i) The disease or condition is newly recognized or recently acknowledged as a public health concern, and

(ii) Epidemiologic investigation based on reports of cases may contribute to understanding of the disease or condition, and

(iii) Written notification is provided to all local health officers regarding:

(A) Additional reporting requirements, and

(B) Rationale or justification for specifying the disease or condition as reportable.

(b) Require laboratories to submit specimens indicative of infections in addition to those required in WAC 246-100-231 for a period of time less than thirty-six months, provided:

(i) The infection is of public health concern, and

(ii) Written notification is provided to all local health officers and all directors of medical laboratories registered as described in WAC 246-100-221 explaining:

(A) Actions required, and

(B) Reason for the addition.

(c) Eliminate the requirement for laboratories to report CD4+ counts and CD4+ percents as specified in WAC 246-100-236 if state and federal funding of HIV/AIDS-related health services do not depend on numbers of reported AIDS cases or if less than ten percent of cases reported are discovered through laboratory reporting of CD4+ count and CD4+ percent results.

(2) The state health officer's authorization to require reporting of cases or submission of laboratory specimens, other than those specified in WAC 246-100-076 and 246-100-231, shall expire thirty-six months from the date of written notification of local health officers and laboratory directors unless amended rules are adopted by the state board of health.

(3) The state health officer shall distribute periodic epidemiologic summary reports and an annual review of public health issues to local health officers and local health departments.

[Statutory Authority: Chapter 70.24 RCW. 93-08-036 (Order 354B), § 246-100-041, filed 4/1/93, effective 5/2/93. Statutory Authority: RCW 43.20.050. 92-02-019 (Order 225B), § 246-100-041, filed 12/23/91, effective 1/23/92; 91-02-051 (Order 124B), recodified as § 246-100-041, filed 12/27/90, effective 1/31/91; 87-11-047 (Order 302), § 248-100-041, filed 5/19/87.]

**WAC 246-100-042 Reporting of blood lead levels.**

(1) Pursuant to WAC 246-100-041, the state health officer finds as follows:

(a) Adverse health effects resulting from elevated levels of lead in the blood has been acknowledged as a public health concern throughout the United States;

(b) Epidemiologic investigation based on reports of the results of blood level tests may contribute to the understanding of the condition, its prevalence within the state of Washington, and especially the extent to which the condition affects both children and those who may be exposed to lead in the work place;

(c) Rapid follow-up and appropriate management of potentially hazardous blood lead levels is necessary to assure safe public health, and assists in development of programs to prevent future lead over-exposure.

(2) **Definitions.** For the purposes of this section, the following words and phrases have the following meanings:

(a) "Blood lead level" means a measurement of lead content in whole blood.

(b) "Reporting organization" means any medical laboratory which performs blood lead analysis at a site within the state of Washington; or any individual or organization which sends blood specimens to an out-of-state medical laboratory for lead testing, including in-state organizations which receive blood specimens from other in-state individuals or organizations, and then send those specimens to an out-of-state testing laboratory.

(c) "Testing laboratory" means a medical laboratory which performs a blood lead analysis.

**(3) Reporting of blood lead levels.**

(a) A reporting organization shall report all blood lead levels to the department of health, including those which are within normal limits. The department of health shall send a copy of any report with a blood lead level equal to or greater than 40 micrograms per deciliter in adults, or equal to or greater than 10 micrograms per deciliter in children less than 15 years of age, to the local health department serving the jurisdiction in which the tested person resides.

(b) An individual or organization which sends blood specimens to an out-of-state laboratory may fulfill its reporting obligation by arranging for the testing laboratory to submit adequate reports.

(c) Reports shall be made in a format approved by the department.

(d) For blood lead levels equal to or greater than 40 micrograms per deciliter for adults, or equal to or greater than 20 micrograms per deciliter in children less than 15 years of age, the department must be notified by telephone, fax or mail within seven calendar days of the date test was performed, or if the test was performed by an out-of-state laboratory the date when the test result was received. Telephone reports must be supplemented by a written report submitted no later than the fifth business day of the next month after the telephone contact. In event age of patient is not known, the reporting organization shall follow the reporting schedule for children less than 15 years of age.

(e) For blood lead levels equal to or greater than 20 micrograms per deciliter in adults, or equal to or greater than 10 micrograms per deciliter in children less than 15 years of age, a report shall be made to the department no later than the fifth business day of the next month after the month in which the test was performed, or if the test was performed by an out-of-state laboratory the month during which the test result was received. In the event age of patient is not known, the reporting organization shall follow the reporting schedule for children less than 15 years of age.

(f) Information to be reported to the department for blood lead levels specified in parts (3)(d) and (3)(e) shall include the following:

- (i) Name of the person tested;
- (ii) Name of the reporting organization;
- (iii) Name of the testing laboratory;
- (iv) Date specimen received;
- (v) Blood lead level of person tested;
- (vi) Name of health care provider ordering test;
- (vii) Address or telephone number of health care provider ordering test, if available;

(viii) Date of birth or the age of the person tested, if available;

(ix) Sex of person tested, if available;

(x) Race and ethnicity of person tested, if available;

(xi) Whether blood specimen is venous or capillary, if available;

(xii) Free erythrocyte or zinc protoporphyrin or zinc protoporphyrin/heme ratio, if performed, when available;

(xiii) Address and occupation of the person tested, or if a child the parents' occupation, if available;

(xiv) Name, address and telephone number of the employer, or if a child the parents' employer, if available;

(g) For all other blood lead levels, the reporting organization must either report the information specified in (3)(f) or submit a monthly summary report by the fifth day of the next month. The monthly summary must be categorized by the number of tests performed on specimens for children less than 15 years of age, the number of tests performed for individuals 15 years of age or older and the number of tests performed where patient's age is unknown. In each category the number of tests must be sorted by one of the following geographic indicators: patient county of residence, or patient postal zip code of residence, or provider county of practice, or provider postal zip code of practice.

**(4) Responsibilities of health care providers.** Upon request of a representative of the department of health or the department of labor and industries, a health care provider who has ordered a blood lead test shall provide the patient's address and telephone number to the department of health or the department of labor and industries, and when known the following information:

(a) Circumstances of lead exposure;

(b) Employer's name, address and telephone number, or, if a child, the same information on the employers of the parents;

(c) Occupation of person tested, or, if a child, occupation of parents;

(d) Type of industry of employer of person tested, or, if a child, type of industry of the employers of the parents;

(e) Reason for drawing lead level.

**(5) Confidentiality.**

(a) The medical laboratory report and all patient information provided by the health care provider shall be maintained in a confidential manner as with other disease reports and are not subject to public disclosure in any form under which the patient may be identified.

(b) The department of labor and industries shall have full access to information collected pursuant to this section, for the purposes of research, analysis, and follow-up of blood lead levels.

(6) This rule shall apply to tests performed for blood specimens drawn between May 15, 1996, and May 14, 1999.

[Statutory Authority: RCW 43.20.050, 96-11-077, § 246-100-042, filed 5/13/96, effective 6/13/96. Statutory Authority: RCW 43.20.050(3), 93-10-038 (Order 358), § 246-100-042, filed 4/28/93, effective 5/29/93.]

**WAC 246-100-046 Responsibilities and duties—Cases, suspected cases, carriers, contacts, and others.** (1) Persons shall cooperate with public health personnel during:

(a) Investigation of the circumstances of a case, suspected case, outbreak, or suspected outbreak of a communicable or other disease or condition; and

(b) Implementation of infection control measures, including isolation and quarantine measures.

(2) Individuals having knowledge of a person with a reportable disease or condition may notify the local health officer as described in WAC 246-100-071.

[Statutory Authority: RCW 43.20.050. 92-02-019 (Order 225B), § 246-100-046, filed 12/23/91, effective 1/23/92; 91-02-051 (Order 124B), recodified as § 246-100-046, filed 12/27/90, effective 1/31/91; 87-11-047 (Order 302), § 248-100-046, filed 5/19/87.]

**WAC 246-100-071 Responsibility for reporting to and cooperating with the local health department.** (1) A principal health care provider in attendance on a case of any reportable disease or condition shall report the case to the local health department as required in this chapter.

(2) Other health care providers in attendance on a case of a reportable disease or condition shall report the case to the local health department unless the case has already been reported.

(3) Health care facilities where more than one health care provider may be in attendance on a case of a reportable disease or condition may establish administrative procedures to assure forwarding of reports to the local health department without duplication. Neither the submission of a specimen to a public health laboratory as required in WAC 246-100-231 nor the laboratory reporting a positive test result as required in WAC 246-100-236 relieves the principal health care provider or health care facility from responsibility for reporting to the local health department.

(4) Individuals knowing about a person suspected to have any reportable disease or condition may report the name, other identifying information, and other known information described in WAC 246-100-081 to the local health department.

(5) School principals, school nurses, and day care center operators knowing of a case or suspected case of a reportable disease or condition in the school or center shall notify the local health department.

(6) Each school teacher and day care worker knowing of a case or suspected case of a reportable disease or condition shall report the name and other identifying information to the principal, school nurse, or day care center operator.

(7) Medical laboratories shall report laboratory evidence of certain reportable diseases to the local or state health department as described in WAC 246-100-236.

(8) Health care providers, health care facilities, laboratory directors, and individuals shall cooperate with the local health officer in the investigation of a case or suspected case of a reportable disease or condition, and shall, when requested by the local health officer, provide in a timely manner any information related to the clinical, laboratory, and epidemiologic circumstances of the case or suspected case.

[Statutory Authority: RCW 43.20.050. 92-02-019 (Order 225B), § 246-100-071, filed 12/23/91, effective 1/23/92; 91-02-051 (Order 124B), recodified as § 246-100-071, filed 12/27/90, effective 1/31/91; 87-11-047 (Order 302), § 248-100-071, filed 5/19/87.]

**WAC 246-100-072 Rules for notification of partners at-risk of HIV infection.** (1) A health care provider may consult with the local health officer or an authorized representative about an HIV-infected individual without identifying the individual.

(2) Only under the specific circumstances listed below, a principal health care provider shall report the identity of sex or injection equipment-sharing partners of an HIV-infected individual to the local health officer or an authorized representative:

(a) After being informed of the necessity to notify sex and injection-equipment sharing partners, the HIV-infected individual either refuses or is unable to notify partners that partners:

(i) May have been exposed to and infected with HIV; and

(ii) Should seek HIV-pretest counseling and consider HIV testing; and

(b) The HIV-infected individual neither accepts assistance nor agrees to referral to the local health officer or an authorized representative for assistance in notifying partners.

(3) Only in the specific circumstances listed below, a principal health care provider shall report the identity of an individual with a positive HIV test result to the local health officer or an authorized representative:

(a) The principal health care provider provided pretest counseling as described in WAC 246-100-209(1) before the individual was tested; and

(b) The principal health care provider made efforts, but was unable to meet face-to-face with the individual to notify the individual of the HIV-test result and to provide post-test counseling as required in WAC 246-100-209 in order to assure partner notification.

(4) A health care provider shall not disclose the identity of an HIV-infected individual or the identity of sex and injection equipment-sharing partners at risk of HIV infection, except as authorized in RCW 70.24.105, WAC 246-100-072, or 246-100-076.

(5) Local health officers and authorized representatives shall:

(a) Confirm conditions in subsections (2) and (3) of this section were met prior to initiating partner notification or receiving referral of identity of an HIV-infected individual; and

(b) Use identifying information, provided according to this section, on HIV-infected individuals only for contacting the HIV-infected individual to provide post-test counseling or to contact sex and injection equipment-sharing partners; and

(c) Destroy documentation of referral information established under this subsection, containing identities and identifying information on the HIV-infected individual and at-risk partners of that individual, immediately after notifying partners or within three months of the date information was received, whichever occurs first.

[Statutory Authority: RCW 43.20.050 and 70.24.130. 92-02-019 (Order 225B), § 246-100-072, filed 12/23/91, effective 1/23/92. Statutory Authority: RCW 43.20.050. 91-02-051 (Order 124B), recodified as § 246-100-072, filed 12/27/90, effective 1/31/91. Statutory Authority: Chapter 70.24 RCW. 89-02-008 (Order 324), § 248-100-072, filed 12/27/88.]

**WAC 246-100-076 Reportable diseases and conditions.** (1) The following diseases and conditions shall be reported as individual case reports to the local health department in accordance with requirements and procedures described throughout chapter 246-100 WAC:

(a) Category A diseases require an immediate report at the time a case is suspected or diagnosed and include:

- (i) Anthrax,
- (ii) Botulism (including food-borne, infant, and wound),
- (iii) Cholera,
- (iv) Diphtheria, noncutaneous,
- (v) Measles (rubeola),
- (vi) Paralytic shellfish poisoning,
- (vii) Plague,
- (viii) Poliomyelitis, and
- (ix) Rabies.

(b) Category B diseases or conditions require a case report within one day of diagnosis and include:

- (i) Brucellosis,
- (ii) Gastroenteritis of suspected food-borne or water-borne origin,
- (iii) Hemophilus influenzae invasive disease (excluding otitis media) in children age five years and under,
- (iv) Hepatitis A and B, acute,
- (v) Leptospirosis,
- (vi) Listeriosis,
- (vii) Meningococcal disease,
- (viii) Paratyphoid fever (see salmonellosis),
- (ix) Pertussis,
- (x) Rubella, including congenital,
- (xi) Salmonellosis, including paratyphoid fever and typhoid fever,
- (xii) Shigellosis,
- (xiii) Syphilis—primary, secondary, or congenital (for other, see Category C),
- (xiv) Tuberculosis (suspected or diagnosed),
- (xv) Typhoid fever, including carrier (see salmonellosis),
- (xvi) Unusual communicable disease (see definition WAC 246-100-011).

(c) Category C diseases or conditions require a case report within seven days of diagnosis and include:

- (i) Acquired immunodeficiency syndrome (AIDS) class IV human immunodeficiency virus (HIV, HTLV III, or LAV) disease (as classified by the Centers for Disease Control, U.S. Public Health Service, Morbidity and Mortality Weekly Report (MMWR), May 23, 1986, Volume 35, Number 20), and class P-2 pediatric HIV illness (as classified by the Centers for Disease Control, U.S. Public Health Service, MMWR, April 24, 1987, Volume 36, Number 15),
- (ii) Amebiasis,
- (iii) Campylobacteriosis,
- (iv) Chancroid,
- (v) Chlamydia trachomatis infection,
- (vi) E. coli 0157:H7 infection,
- (vii) Encephalitis, viral,
- (viii) Giardiasis,
- (ix) Gonorrhea,
- (x) Granuloma inguinale,
- (xi) Herpes simplex, initial genital infection,
- (xii) Herpes simplex, neonatal,
- (xiii) Hepatitis non-A, non-B, and unspecified,
- (xiv) Kawasaki syndrome,

- (xv) Legionellosis,
- (xvi) Leprosy (Hansen's disease),
- (xvii) Lyme disease,
- (xviii) Lymphogranuloma venereum,
- (xix) Malaria,
- (xx) Mycobacteriosis,
- (xxi) Mumps,
- (xxii) Nongonococcal urethritis,
- (xxiii) Pelvic inflammatory disease, acute,
- (xxiv) Pseudomonas folliculitis of suspected waterborne origin,
- (xxv) Psittacosis,
- (xxvi) Q fever,
- (xxvii) Relapsing fever (borreliosis),
- (xxviii) Reye Syndrome,
- (xxix) Rheumatic fever,
- (xxx) Rocky mountain spotted fever,
- (xxxi) Syphilis—other (see also Category B),
- (xxxii) Tetanus,
- (xxxiii) Tick paralysis,
- (xxxiv) Toxic shock syndrome,
- (xxxv) Trichinosis,
- (xxxvi) Tularemia,
- (xxxvii) Vibriosis,
- (xxxviii) Yersiniosis, and
- (xxxix) Severe adverse reaction to immunization.

(2) Any cluster or pattern of cases, suspected cases, deaths, or increased incidence of any disease or condition beyond that expected in a given period which may indicate an outbreak, epidemic, or related public health hazard shall be reported immediately by telephone to the local health officer. Such patterns include, but are not limited to, suspected or confirmed outbreaks of food borne or water-borne disease, chickenpox, influenza, viral meningitis, nosocomial infection suspected due to contaminated products or devices, or environmentally related disease.

(3) Local health officers may require reporting of additional diseases and conditions.

[Statutory Authority: RCW 70.28.032, 96-23-064, § 246-100-076, filed 11/20/96, effective 12/21/96. Statutory Authority: Chapter 70.24 RCW, 93-08-036 (Order 354B), § 246-100-076, filed 4/1/93, effective 5/2/93. Statutory Authority: RCW 43.20.050, 92-02-019 (Order 225B), § 246-100-076, filed 12/23/91, effective 1/23/92; 91-02-051 (Order 124B), recodified as § 246-100-076, filed 12/27/90, effective 1/31/91; 87-11-047 (Order 302), § 248-100-076, filed 5/19/87.]

**WAC 246-100-081 Reports—Content—Time—Hospital monthly report permitted for certain diseases.**

(1) Health care providers, health care facilities, and others as required in chapter 246-100 WAC shall report each case of a reportable disease or condition (Category A, B, and C), to the local health officer including the following information:

- (a) Name,
- (b) Address,
- (c) Age,
- (d) Sex,
- (e) Diagnosis or suspected diagnosis of disease or condition,
- (f) Identity of the principal health care provider (minimally first and last name), and
- (g) Name and address or telephone number of the person providing the report.



(2) Local health officers may require other information of epidemiologic or public health value including but not limited to:

- (a) Immunization status,
- (b) History and circumstances of possible exposure or source,
- (c) Identity of contacts at risk for disease, if known,
- (d) Occupation, school, or day care of case,
- (e) Date of onset of disease or condition, and
- (f) Race.

(3) Health care providers, health care facilities, and others required in chapter 246-100 WAC to report cases of disease or conditions shall:

(a) Immediately telephone the report of each case or suspected case of Category A disease or condition, WAC 246-100-076, to the local health department,

(b) Telephone a report of Category B disease or condition, WAC 246-100-076, to the local health department no later than one working day following diagnosis,

(c) Submit a written report of each Category C disease or condition, WAC 246-100-076, to the local health department within seven days of diagnosis including:

(i) Completion of an individual case report form provided or approved by the local health department, or

(ii) A telephone report if:

(A) Telephone reports are approved by the local health officer, and

(B) The local health officer assumes responsibility for completion of the written case report form.

(4) Hospitals may:

(a) Elect a monthly reporting system only for certain category C diseases or conditions including:

(i) Chlamydia trachomatis infection;

(ii) Kawasaki syndrome;

(iii) Leprosy (Hansen's disease);

(iv) Mumps;

(v) Mycobacteriosis, excluding tuberculosis;

(vi) Pelvic inflammatory disease, acute including those diseases classified as pelvic inflammatory disease in international classification of diseases, 9th revision, clinical modification, volume I and II, 1980;

(vii) Reye syndrome; and

(viii) Toxic shock syndrome.

(b) Be waived from requirements to report:

(i) Initial genital herpes simplex infection,

(ii) Nongonococcal urethritis, and

(iii) Pseudomonas folliculitis of suspected waterborne origin.

(5) Hospitals shall:

(a) Report immediately by telephone any outbreak or suspected outbreak (see WAC 246-100-076).

(b) Include in monthly reports permitted only for certain diseases specified in subsection (4) of this section, at least:

(i) Name of case,

(ii) Date of admission or outpatient visit, and

(iii) Name of principal health care provider.

(6) Principal health care providers shall report each case of disease or condition, including those listed in subsection (4) of this section within seven days of diagnosis and as specified in subsection (3) of this section.

[Statutory Authority: RCW 43.20.050. 92-02-019 (Order 225B), § 246-100-081, filed 12/23/91, effective 1/23/92; 91-02-051 (Order 124B),

(1997 Ed.)

recodified as § 246-100-081, filed 12/27/90, effective 1/31/91; 87-11-047 (Order 302), § 248-100-081, filed 5/19/87.]

**WAC 246-100-086 Reporting diseases and conditions directly to department.** (1) Health care providers and health care facilities shall telephone reports directly to the department for diseases and conditions under WAC 246-100-076 when:

(a) A local health department is closed at the time a case or suspected case of a category A reportable disease occurs, and

(b) A local health department is closed at the time an outbreak or suspected outbreak occurs (see WAC 246-100-076).

(2) The twenty-four hour department telephone number for reporting diseases or conditions under WAC 246-100-076 is (206) 361-2914 or SCAN 245-2914.

(3) Health care providers and health care facilities shall telephone reports of pesticide poisoning cases or suspected pesticide poisoning cases under RCW 70.104.055 directly to the department of health by dialing the twenty-four hour toll-free telephone number 1-800-356-2323.

[Statutory Authority: RCW 43.20.050 and 70.104.055. 92-02-019 (Order 225B), § 246-100-086, filed 12/23/91, effective 1/23/92. Statutory Authority: RCW 43.20.050. 91-02-051 (Order 124B), recodified as § 246-100-086, filed 12/27/90, effective 1/31/91. Statutory Authority: Chapter 70.104 RCW. 90-10-036 (Order 049), § 248-100-086, filed 4/26/90, effective 5/27/90. Statutory Authority: RCW 43.20.050. 87-11-047 (Order 302), § 248-100-086, filed 5/19/87.]

**WAC 246-100-091 Handling of reports by local health department—Handling of reports by department.**

(1) The local health officer or local health department shall:

(a) Notify the department immediately by telephone of any report of a case or suspected case of a category A disease or condition,

(b) Submit a department-approved individual case report form for each case of any reportable disease or condition to the department within seven days of completing the investigation and report. (The state health officer may waive the requirement to submit an individual case report if pertinent information was provided by phone.)

(c) Submit a written report on forms approved by the department for a cluster or outbreak of food borne or waterborne disease within seven days of completing the investigation. (The state health officer may waive the requirements to submit a written report if pertinent information was provided to the department by phone.)

(d) Maintain confidentiality procedures related to disclosure of identity of cases and suspected cases as specified in subsection (2) of this section.

(2) The state health officer and designees shall establish and maintain confidentiality procedures related to employee handling of all reports of cases and suspected cases, prohibiting disclosure of report information identifying an individual case or suspected cases except:

(a) To employees of the local health department, or other official agencies needing to know for the purpose of administering public health laws,

(b) To health care providers, specific designees of health care facilities, laboratory directors, and others for the purpose of collecting additional information about a case or

suspected case as required for disease prevention and control.

[Statutory Authority: RCW 43.20.050, 91-02-051 (Order 124B), recodified as § 246-100-091, filed 12/27/90, effective 1/31/91; 87-11-047 (Order 302), § 248-100-091, filed 5/19/87.]

**WAC 246-100-166 Immunization of child care and school children against certain vaccine-preventable diseases.** (1) Definitions for purposes of this section:

(a) "Certificate of immunization status (CIS) form" means a form provided by the department labeled DOH 348-013, including data entry spaces for immunization information including:

- (i) Name of child or student,
- (ii) Birth date,
- (iii) Gender,
- (iv) Type of vaccine,
- (v) Date of each dose of vaccine received specifying day, month, and year,
- (vi) Signature of parent, legal guardian, or adult in loco parentis, and
- (vii) Documented exemptions, if applicable and as specified in subsection (5) of this section.

(b) "Chief administrator" means:

(i) The person with the authority and responsibility for the immediate supervision of the operation of a school, child care center, or

(ii) A designee of the chief administrator assigned in writing to carry out the requirements of RCW 28A.210.160 through the statutory or corporate board of directors of the school district or school, or

(iii) Person or persons with the authority and responsibility for the general supervision of the operation of the school district or school.

(c) "Child" means any person regardless of age admitted to any child care center, preschool, kindergarten, or grades one through twelve program of education in:

- (i) Any public school district, or
- (ii) Any private school or private institution subject to approval by the state board of education or described in RCW 28A.305.130 and 28A.195.010 through 28A.195.060, or
- (iii) Any licensed child care facility which regularly provides care for a group of thirteen or more children for periods of less than twenty-four hours subject to licensure by the department of social and health services as described in chapter 74.15 RCW.

(d) "Full immunization" means vaccinated in accordance with schedules and immunizing agents approved by the state board of health in WAC 246-100-166 against:

- (i) Diphtheria,
- (ii) Tetanus,
- (iii) Pertussis or whooping cough,
- (iv) Measles or rubeola,
- (v) Rubella,
- (vi) Mumps,
- (vii) Poliomyelitis,
- (viii) Haemophilus influenzae type b disease, and
- (ix) Hepatitis b, after September 1, 1997.

(e) "Immunizing agents" means any vaccine or other biologic licensed and approved by the United States Food

and Drug Administration (FDA), or meeting World Health Organization (WHO) requirements, for immunization of persons against:

- (i) Diphtheria, tetanus, pertussis (DTP, DT, Td);
  - (ii) Measles;
  - (iii) Mumps;
  - (iv) Poliomyelitis, types I, II, and III (TOPV, IPV);
  - (v) Rubella;
  - (vi) Haemophilus influenzae type b vaccine (Hib); and
  - (vii) Hepatitis b.
- (f) "National immunization guidelines" means the schedule for immunization described in the "Recommended Childhood Immunization Schedule: United States—January 1995," approved by the Advisory Committee on Immunization Practices (ACIP), the American Academy of Pediatrics (AAP), and the American Academy of Family Physicians (AAFP).

(g) "Parent" means a person who is:

(i) The mother, father, legal guardian, or any adult in loco parentis of a child seventeen years of age or younger; or

- (ii) A person eighteen years of age or older; or
- (iii) An emancipated minor.

(h) "Transfer student" means a student previously enrolled in grades kindergarten through twelve moving from one school district or system to another at any time during the school year, excluding students transferring within a district or system when the school transfers records within the district.

(2) Full immunization schedule. Each child care center, preschool, and school shall establish and maintain requirements for full immunization of children attending child care and preschool through grade twelve.

(3) For child care and preschool children, full immunization means a child received age-appropriate vaccines as enumerated in the National Immunization Guidelines as defined in subsection (1) of this section.

(4) For a child entering kindergarten or first grade (school entry level), full immunization means a child received age-appropriate vaccines as enumerated in the National Immunization Guidelines as defined in subsection (1) of this section.

For transfer students and those above kindergarten or first grade, full immunization means a child received age-appropriate vaccines consistent with the National Immunization Guidelines as defined in subsection (1) of this section (not required of persons eighteen years of age and older).

(5) Conditions for child care, preschool, and school attendance when a child is not fully immunized:

(a) When a child lacks full immunization, the child care center, preschool, or school shall require satisfactory progress toward full immunization (conditional status) as a condition of school attendance including:

- (i) Documented proof of start or continuance of child's schedule of immunization;
- (ii) Assurance the scheduled immunization is consistent with the national immunization guidelines defined in subsection (1) of this section;
- (iii) Notification of child's parent(s) of when the schedule must be completed; and
- (iv) Exclusion of child from attendance as described in subsection (9) of this section if child has not received

required immunizations on schedule and if sufficient time has elapsed (one month from date due) for completion of next dose.

(6) Schools, preschools, and child care centers shall require documented proof related to immunization including:

(a) Completion of a certificate of immunization status (CIS) form by a parent as documented proof of:

- (i) Full immunization, or
- (ii) Initiation or continuation of a schedule (conditional status), or
- (iii) Exemption.

(b) Information from a written personal immunization record, as the source of the immunization data entered on the CIS form (substitution of a personal immunization record for a CIS form is prohibited);

(c) Acceptance of only the CIS form (no other state or local immunization forms) from new enrollees registering in kindergarten through grade twelve;

(d) In addition to current CIS form, acceptance of previous CIS forms, or locally developed forms approved by the department indicating the month and year of each immunization as the official immunization status for children enrolled prior to September 1, 1979.

(7) Schools, preschools, and child care centers shall accept medical exemptions and:

(a) Require a signature of a licensed medical doctor (M.D.), doctor of osteopathy (D.O.), doctor of naturopathy (N.D.), physician assistant, or nurse practitioner practicing within the limits of the medical or nurse practice acts to certify medical reasons to defer one or more immunizations on the CIS form;

(b) Admit children and keep on file a CIS form for children with:

(i) Temporary exemption from immunization for medical reasons if the required immunizations are received upon expiration of the exemption, or

(ii) Permanent exemptions.

(c) Include a statement on the CIS form informing the parent that should an outbreak of vaccine preventable disease for which the child is exempted occur, the child may be excluded from school or child care for the duration of the outbreak by order of the local health department as described in subsection (9) of this section; and

(d) Keep on file a list of children so exempted and transmit the list to the local health department if requested.

(8) Schools, preschools, and child care centers shall:

(a) Allow a parent to exempt his/her child from the required immunizations for religious, philosophical, or personal objections when the CIS form indicates:

(i) Type or exemption, and

(ii) Signature of parent.

(b) Keep on file a CIS form for each child so enrolled;

(c) Include a statement on the CIS form informing the parent that should an outbreak of vaccine preventable disease for which the child is exempted occur, the child may be excluded from school for the duration of the outbreak by order of the local health department as described in subsection (9) of this section; and

(d) Keep on file a list of children so exempted and transmit the list to the local health department if requested.

(9) Schools, preschools, and child care centers shall exclude children from school as follows:

(a) Exclude any child from school for failure to provide a completed CIS form as defined in subsection (1) of this section before or on the child's first day of attendance consistent with procedures required by the state board of education, Title 180 WAC;

(b) Exclude from attendance any child in a child care center for failure to provide a completed CIS form as defined in subsection (1) of this section before or on the child's first day of attendance;

(c) The chief administrator shall retain records on excluded children for at least three years including:

(i) Name,

(ii) Address, and

(iii) Date of exclusion.

(d) A health officer may exclude children from school, preschool, and child care attendance in the event of a child's exposure to a disease according to chapter 246-110 WAC, including children presenting proof of:

(i) Initiation of a schedule of immunization,

(ii) Medical exemption,

(iii) Religious exemption,

(iv) Philosophical exemption, or

(v) Personal exemption.

(10) Schools, preschools, and child care centers shall maintain records and require:

(a) A completed CIS form retained in the files for every child enrolled;

(b) Return of original CIS form or a legible copy to the parent in the event of the child's withdrawal or transfer from school (withholding a record for any reason, including nonpayment of school, preschool, or child care fees is prohibited);

(c) Access to immunization records by agents of the state or local health department for each child enrolled.

(11) Persons or organizations administering immunizations, either public or private, shall:

(a) Furnish each person immunized, or his or her parent, with a written record of immunization containing information required by the state board of health; and

(b) Provide immunizations and records in accordance with chapter 246-100 WAC.

(12) Chief administrators of schools, preschools, and child care centers shall forward a written annual report to the department and local health department on the immunization status of children as follows:

(a) For schools: By November 1 of each year on forms provided by the department (except in the event of a late school opening when the report is due thirty days after the first day of school);

(b) For preschools and child care centers: By February 1 of each year on forms provided by the department.

[Statutory Authority: RCW 28A.210.140, 96-04-079, § 246-100-166, filed 2/7/96, effective 3/9/96. Statutory Authority: RCW 28A.210.140 and 43.20.050, 91-15-066 (Order 182B), § 246-100-166, filed 7/22/91, effective 8/22/91. Statutory Authority: RCW 43.20.050, 91-02-051 (Order 124B), recodified as § 246-100-166, filed 12/27/90, effective 1/31/91; 88-07-063 (Order 308), § 248-100-166, filed 3/16/88.]

**WAC 246-100-171 Special settings—Food service establishments.** (1) Food handlers with communicable disease in an infectious or carrier state shall not handle food

or beverages if the infectious agent can be transmitted through food or beverages.

(2) Employers or persons in charge of food service establishments shall prohibit persons from work as food handlers with a known disease, condition, and/or carrier state including, but not limited to:

- (a) Amebiasis;
- (b) B hemolytic streptococcal infection;
- (c) Campylobacter;
- (d) Cholera;
- (e) Hepatitis A and Hepatitis unspecified;
- (f) Salmonellosis, including typhoid and paratyphoid;
- (g) Shigellosis;
- (h) Staphylococcal infections; and
- (i) Signs of undiagnosed infection including:

(A) Diarrhea (with episodes of over forty-eight hours requiring approval by a health care provider or local health officer prior to return to work);

- (B) Skin lesions;
- (C) Vomiting; or
- (D) Fever.

(3) Work restrictions, control measures, and removal of work restrictions on food handlers and food service establishments shall be consistent with:

(a) *Control of Communicable Diseases in Man*, 15th edition, Abram S. Benenson (editor), American public health association, 1990;

(b) Chapter 246-215 WAC food service sanitation, rules, and regulations of the Washington state board of health; and

(c) Chapter 69.06 RCW, food and beverage establishments, workers permits.

(4) Employers and persons in charge of food service establishments shall:

(a) Require notification or approval of removal of work restriction by a health care provider or local health officer for persons working with diseases, carrier states, conditions and signs listed in subsection (2) of this section; and

(b) Cooperate with public health officials investigating cases, outbreaks, or suspected outbreaks.

(5) The local health department has authority to:

(a) Require an examination of a person or persons to determine presence of infection,

(b) Adopt more stringent rules for excluding a food handler from work, and

(c) Protect public safety consistent with chapter 246-215 WAC by ordering food items to be:

- (i) Placed under a hold order,
- (ii) Destroyed immediately,
- (iii) Surrendered,
- (iv) Sampled, and
- (v) Submitted for laboratory testing.

[Statutory Authority: RCW 43.20.050. 92-02-019 (Order 225B), § 246-100-171, filed 12/23/91, effective 1/23/92; 91-02-051 (Order 124B), recodified as § 246-100-171, filed 12/27/90, effective 1/31/91; 88-07-063 (Order 308), § 248-100-171, filed 3/16/88.]

**WAC 246-100-176 Special settings—Schools.** Private and public schools, vocational schools, colleges, and universities shall cooperate with local and state health officers in carrying out requirements in chapters 246-110 and 246-100 WAC.

[Statutory Authority: RCW 43.20.050. 92-02-019 (Order 225B), § 246-100-176, filed 12/23/91, effective 1/23/92; 91-02-051 (Order 124B), recodified as § 246-100-176, filed 12/27/90, effective 1/31/91; 88-07-063 (Order 308), § 248-100-176, filed 3/16/88.]

**WAC 246-100-181 Special settings—Child day care facilities.** Child day care facilities shall:

(1) Establish policy and procedures for prevention and control of communicable diseases in employees, voluntary staff, and children that:

(a) Are consistent with "child health care plan guidelines" available from division of health, office of licensing and certification, personal care facilities survey section, ET-33, Olympia, Washington 98504; and/or

(b) Are consistent with additional or more stringent recommendations of the local health department; and

(c) Include a provision for reporting illness to the local health department when required in chapter 246-100 WAC and WAC 388-73-056.

(2) Consult with a health care provider or the local health department for information about infectious or communicable disease, as necessary.

[Statutory Authority: RCW 43.20.050. 92-02-019 (Order 225B), § 246-100-181, filed 12/23/91, effective 1/23/92; 91-02-051 (Order 124B), recodified as § 246-100-181, filed 12/27/90, effective 1/31/91; 88-07-063 (Order 308), § 248-100-181, filed 3/16/88.]

**WAC 246-100-186 Special settings—Health care facilities.** Health care facilities shall:

(1) Adopt written policy and procedures restricting work of employees, staff, students, and volunteers diagnosed to have a communicable disease from direct contact with patients, residents, and recipients of care during the period of communicability when:

(a) Transmission of the disease to recipients of care or other employees can occur in that particular job environment, and

(b) The disease can cause serious illness.

(2) Permit employees, staff, students, and volunteers to return to work when measures have been taken to prevent transmission of disease if:

(a) Measures are consistent with recommendations of an infection control committee or equivalent authorized group if existing, and

(b) Measures are consistent with recommendations of local health officer.

(3) Comply with applicable state licensure law and department rules regarding communicable disease screening and control.

[Statutory Authority: RCW 43.20.050. 91-02-051 (Order 124B), recodified as § 246-100-186, filed 12/27/90, effective 1/31/91; 88-07-063 (Order 308), § 248-100-186, filed 3/16/88.]

**WAC 246-100-191 Animals, birds, pets—Measures to prevent human disease.** (1) All persons and entities are prohibited from:

(a) Sale of milk, meat, hides, and hair from animals infected with anthrax; and

(b) Sale and display of turtles except as permitted under Title 21 CFR, Food and Drug Administration, part 1240.62, 1986.

(2) Except for bonafide public or private zoological parks, persons and entities are prohibited from:

(a) Importing into Washington state any bat, skunk, fox, raccoon, or coyote without a permit from the director of the Washington state department of agriculture, as required in WAC 16-54-125; and

(b) Acquiring, selling, bartering, exchanging, giving, purchasing, or trapping for retention as pets or for export any:

- (i) Bat,
- (ii) Skunk,
- (iii) Fox,
- (iv) Raccoon, and
- (v) Coyote.

(3) Local health officers shall determine whether or not to order the destroying or testing of animals other than cats and dogs if:

(a) The animal has bitten or otherwise exposed a person, and

(b) Rabies is suspected.

(4) When an animal has bitten or otherwise exposed a person, the local health officer shall institute any or all of the following as judged appropriate:

(a) Order testing and destruction of the animal,

(b) Order restriction of dogs and cats for ten days observation,

(c) Require examination and recommendation by a veterinarian related to signs of rabies, or

(d) Specify other appropriate actions for animals considered low risk for rabies.

(5) When an animal other than a bat is found to be rabid, the local health officer shall immediately institute a community-wide rabies control program including:

(a) Issuance of orders to pick up and impound all stray and unlicensed dogs and cats,

(b) Issuance of orders to owners of dogs and cats requiring proof of rabies vaccination of animals by a veterinarian within six previous months,

(c) Restriction of household mammals to owners' premises except when on a leash, or

(d) Institute actions other than subsection (5)(a), (b), and (c) of this section when judged appropriate.

(6) A person destroying an animal as described in this section shall:

(a) Avoid damaging the brain; and

(b) Transport the dead animal's head, brain, or body in a manner approved by the local health department.

(7) To improve surveillance for rabies, laboratories shall inform the local health officer prior to testing specimens and samples for rabies.

(8) When a cat or dog has been bitten or exposed to a rabid or suspected rabid animal, the local health officer shall require:

(a) Destruction of the exposed animal; or

(b) Revaccination, if currently vaccinated, including observation by owner for ninety days; or

(c) If not currently vaccinated, vaccination and strict isolation for six months with revaccination one month prior to release from isolation; or

(d) Any other action judged appropriate by the local health officer.

(9) A person importing a dog and/or a cat into Washington state shall comply with WAC 16-54-120.

[Statutory Authority: RCW 43.20.050. 91-02-051 (Order 124B), recodified as § 246-100-191, filed 12/27/90, effective 1/31/91; 88-07-063 (Order 308), § 248-100-191, filed 3/16/88.]

**WAC 246-100-196 Animal bites—Report to local health department.** Health care providers shall:

(1) Report all cases of humans exposed to secretions or bitten by domestic or wild animals, especially bats and carnivores, to the local health department or designated local authority;

(2) Report bites of rodents and lagomorphs only when an animal exhibits unusual behavior; and

(3) Use protocols established in *Communicable Diseases in Man*, 15th edition, Abram S. Benenson, editor, 1990, when treating wounds caused by animal bites.

[Statutory Authority: RCW 43.20.050. 92-02-019 (Order 225B), § 246-100-196, filed 12/23/91, effective 1/23/92; 91-02-051 (Order 124B), recodified as § 246-100-196, filed 12/27/90, effective 1/31/91; 88-07-063 (Order 308), § 248-100-196, filed 3/16/88.]

**WAC 246-100-201 Birds—Measures to prevent psittacosis.** (1) Definitions specific to this section:

(a) "Breeder" means a person or persons propagating birds for purpose of sale, trade, gift, or display;

(b) "Displayer" means a person, owner, or entity other than a public or private zoological park showing, exhibiting, or allowing a person or persons to handle or access a bird in a place open to the public or in a health care facility;

(c) "Leg band" means a smooth plastic or metal cylinder, either open (seamed) or closed (seamless), designed to be used to encircle a leg of a bird including permanent inscription of identification indicating:

(i) Code for individual bird, and

(ii) Code for breeder source except when open bands identify vendor rather than breeder.

(d) "Psittacine bird" or "bird" means all birds commonly known as:

(i) Parrots,

(ii) Macaws,

(iii) Cockatoos,

(iv) Lovebirds,

(v) Parakeets, and

(vi) All other birds of the order psittaciformes.

(e) "Vendor" means a person or entity selling, trading, or giving a bird to another person or entity.

(2) A person selling, trading, or otherwise transferring a bird shall identify each bird by:

(a) A coded and closed (seamless) leg band;

(b) A United States department of agriculture open (seamed) leg band; or

(c) An open (seamed) leg band only in cases where an original and closed (seamless) leg band was lost or required replacement due to injury or potential injury to the bird.

(3) A vendor transferring a bird to other than the general public shall maintain a record of transfer including acquisition, sales, and trade of a bird, for at least one year and including:

(a) Date of transaction;

(b) Name and address of the recipient and source;

(c) Number and type, including the common name of the bird transferred; and

(d) Leg band codes, including breeder or vendor and individual bird codes, omitting individual bird code only upon initial transfer of a bird propagated by the breeder.

(4) A vendor transferring a bird to the general public shall provide each buyer or recipient with:

(a) A sales slip or written document including all information required in subsection (3)(a), (b), (c), and (d) of this section; and

(b) A written warning or caution notice including:

(i) Information about possible human infection or disease caused by birds, especially psittacosis, parrot fever, and ornithosis;

(ii) Signs of infection or a sick bird including:

- (A) Nasal discharge,
- (B) Sneezing,
- (C) Coughing,
- (D) Ruffled feathers,
- (E) Lethargy, and
- (F) Diarrhea.

(iii) Signs and symptoms of an illness in a human including, but not limited to:

- (A) Chills,
- (B) Fever,
- (C) Headache,
- (D) Cough, and
- (E) Muscle aches.

(iv) Information that nasal discharge and droppings of an infected or sick bird may cause illness in humans; and

(v) Advice to consult veterinarian or health care provider, as appropriate, if signs or symptoms occur.

(5) A vendor shall post a readable sign in a public area with a warning described in subsection (4)(b) of this section.

(6) When investigation of a human case of psittacosis indicates probable infection from a bird, the local health officer shall:

(a) Order collection of blood or other appropriate samples from the suspect bird or birds for appropriate laboratory tests to rule out disease; or

(b) Use protocols established in *Communicable Diseases in Man*, 15th edition, Abram S. Benenson, editor, 1990; and

(c) Have authority to enforce requirements of this section on a nonpsittacine bird or birds when:

- (i) There is suspected exposure to an infected bird, or
- (ii) There is evidence a bird caused a disease.

(7) When a local health officer orders a quarantine of a bird or birds, the vendor shall:

- (a) Cooperate with the local health officer, and
- (b) Assume costs associated with action.

(8) Upon confirmation of psittacosis, vendors shall follow directions issued by the local health officer to:

(a) Place the birds under antibiotic treatment with environmental cleaning and sanitizing; or

(b) Destroy all birds on the premises followed by environmental cleaning and sanitizing; and

(c) Assume costs associated with psittacosis prevention and control action ordered by local and state health officer;

(d) Prohibit sale or addition of birds to inventory; and

(e) Prevent contact of any bird with the public.

(9) A person exhibiting or displaying a bird or birds in a place or area used or occupied by the public shall exhibit

the bird or birds in a manner preventing human exposure to the birds and bird discharges except:

(a) In single-purpose pet shops and aviaries, and

(b) At bird shows if:

(i) A room containing a bird or birds is separated from other areas and activities, and

(ii) The room entrance has a sign warning a person about potential exposure to psittacosis.

(10) Shipment and embargo of birds.

(a) Any person or entity receiving a psittacine bird or birds from points outside Washington state shall:

(i) Comply with Title 9 CFR, parts 92.3 and 92.8(b);

(ii) Refuse receipt of any bird originating from premises where psittacosis infection is suspected or known; and

(iii) Refuse receipt of any bird from a premise quarantined for psittacosis.

(b) The state health officer is authorized to:

(i) Order placement and removal of an embargo upon shipment of a live bird or birds into Washington state, and

(ii) Order any action necessary to control an outbreak or potential outbreak of psittacosis in Washington state.

[Statutory Authority: RCW 43.20.050. 92-02-019 (Order 225B), § 246-100-201, filed 12/23/91, effective 1/23/92; 91-02-051 (Order 124B), recodified as § 246-100-201, filed 12/27/90, effective 1/31/91; 88-07-063 (Order 308), § 248-100-201, filed 3/16/88.]

#### **WAC 246-100-206 Special diseases—Sexually transmitted diseases. (1) Definitions.**

(a) "Behaviors presenting imminent danger to public health (BPID)" means the following activities, under conditions specified below, performed by an individual with a laboratory confirmed HIV infection:

(i) Anal or vaginal intercourse without a latex condom;

or

(ii) Shared use of blood-contaminated injection equipment;

(iii) Donating or selling HIV-infected blood, blood products, or semen; and

(iv) Under the following specified conditions:

(A) The infected individual received post-test counseling as described in WAC 246-100-209 prior to repeating activities in subsection (1)(a)(i) and (ii) of this section; and

(B) The infected individual did not inform the persons, with whom activities described in subsection (1)(a)(i) and (ii) of this section occurred, of his or her infectious status.

(b) "Behaviors presenting possible risk" means:

(i) Actual actions resulting in "exposure presenting a possible risk" limited to:

(A) Anal, oral, or vaginal intercourse excluding conjugal visits; or

(B) Physical assault; or

(C) Sharing of injection equipment or sharp implements;

or

(D) Throwing or smearing of blood, semen, or vaginal fluids; or

(ii) Threatened action if:

(A) The threatening individual states he or she is infected with HIV; and

(B) The threatened behavior is listed in subsection (1)(b)(i)(A), (B), (C), and (D) of this section; and

(C) The threatened behavior could result in "exposure presenting a possible risk."



- (c) "Conduct endangering public health" means:
- (i) Anal, oral, or vaginal intercourse for all sexually transmitted diseases;
  - (ii) For HIV and Hepatitis B:
    - (A) Anal, oral, or vaginal intercourse; and/or
    - (B) Sharing of injection equipment; and/or
    - (C) Donating or selling blood, blood products, body tissues, or semen; and
  - (iii) Activities described in subsection (1)(d)(i) and (ii) of this section resulting in introduction of blood, semen, and/or vaginal fluids to:
    - (A) Mucous membranes;
    - (B) Eyes;
    - (C) Open cuts, wounds, lesions; or
    - (D) Interruption of epidermis.
- (d) "Exposure presenting possible risk" means one or more of the following:
- (i) Introduction of blood, semen, or vaginal fluids into:
    - (A) A body orifice or a mucous membrane;
    - (B) The eye; or
    - (C) An open cut, wound, lesion, or other interruption of the epidermis.
  - (ii) A needle puncture or penetrating wound resulting in exposure to blood, semen, and/or vaginal fluids.
- (e) "Reasonably believed" or "reason to believe," in reference to a sexually transmitted disease, means a health officer's belief which:
- (i) For the purpose of investigating the source and spread of disease, is based upon a credible report from an identifiable individual indicating another person is likely to have a sexually transmitted disease (STD) or to have been exposed to a STD; and
  - (ii) For the purpose of issuing a written order for an individual to submit to examination, counseling, or treatment is based upon:
    - (A) Laboratory test results confirming or suggestive of a STD; or
    - (B) A health care provider's direct observation of clinical signs confirming an individual has or is likely to have a STD; or
    - (C) Obtaining information directly from an individual infected with a STD about the identity of his or her sexual or needle-sharing contacts when:
      - (I) Contact with the infected individual occurred during a period when the disease may have been infectious; and
      - (II) The contact was sufficient to transmit the disease; and
      - (III) The infected individual is, in the health officer's judgment, credible and believable.
- (f) "Substantial exposure" means physical contact resulting in exposure presenting possible risk, limited to:
- (i) A physical assault upon the exposed person involving blood or semen;
  - (ii) Intentional, unauthorized, nonconsensual use of needles or sharp implements to inject or mutilate the exposed person;
  - (iii) An accidental parenteral or mucous membrane or nonintact skin exposure to blood, semen, or vaginal fluids.
- (2) Health care providers shall:
- (a) Report each case of sexually transmitted disease as required in chapter 246-100 WAC, and
  - (b) Instruct each patient regarding:
    - (i) Communicability of the disease, and
    - (ii) Requirements to refrain from acts that may transmit the disease to another.
- (c) Ensure completion of a prenatal serologic test for syphilis in each pregnant woman pursuant to RCW 70.24.090 including:
- (i) Submission of a blood sample for syphilis to a laboratory approved to perform prenatal serologic tests for syphilis, as required in RCW 70.24.090, at the time of the first prenatal visit, and
  - (ii) Decide whether or not to omit the serologic test for syphilis if the test was performed elsewhere during the current pregnancy.
- (3) Laboratories, health care providers, and other persons shall deny issuance of a certificate or statement implying an individual is free from sexually transmitted disease.
- (4) Local health officers, health care providers, and others, in addition to requirements in chapter 246-100 WAC, shall comply with the provisions in chapter 70.24 RCW.
- (5) Prevention of ophthalmia neonatorum.
- (a) Health care providers diagnosing or caring for a patient with gonococcal or chlamydial ophthalmia neonatorum shall report the case to the local health officer or local health department in accordance with the provisions of this chapter.
  - (b) The principal health care provider attending or assisting in the birth of any infant or caring for an infant after birth, shall ensure instillation of a department-approved prophylactic ophthalmic agent into the conjunctival sacs of the infant within the time frame established by the department in policy statement of ophthalmia agents approved for the prevention of ophthalmia neonatorum in the newborn, issued June 19, 1981.
- (6) State and local health officers or their authorized representatives shall:
- (a) Have authority to conduct or cause to be conducted an interview and investigation of persons infected or reasonably believed to be infected with a sexually transmitted disease; and
  - (b) Use procedures and measures described in WAC 246-100-036(4) in conducting investigations.
- (7) State and local health officers and their authorized representatives shall have authority to:
- (a) Issue written orders for medical examination, testing, and/or counseling under chapter 70.24 RCW, only after:
    - (i) All other efforts to protect public health have failed, including reasonable efforts to obtain the voluntary cooperation of the person to be affected by the order; and
    - (ii) Having sufficient evidence to "reasonably believe" the individual to be affected by the order:
      - (A) Has a sexually transmitted disease; and
      - (B) Is engaging in "conduct endangering public health"; and
  - (iii) Investigating and confirming the existence of "conduct endangering public health" by:
    - (A) Interviewing sources to assess their credibility and accuracy; and
    - (B) Interviewing the person to be affected by the order; and
  - (iv) Including in a written order all information required in RCW 70.24.024.

(b) Issue written orders for treatment under RCW 70.24.022 only after laboratory test results, or direct observation of clinical signs or assessment of clinical data by a physician, confirm the individual has, or is likely to have, a sexually transmitted disease;

(c) Issue written orders to cease and desist from specified activities, under RCW 70.24.024 only after:

(i) Determining the person to be affected by the order is engaging in "conduct endangering public health"; and

(ii) Laboratory test results, or direct observation of clinical signs or assessment of clinical data by a physician, confirm the individual has, or is likely to have, a sexually transmitted disease; and

(iii) Exhausting procedures described in subsection (7)(a) of this section; and

(iv) Enlisting, if appropriate, court enforcement of the orders described in subsections (7)(a) and (b) of this section; and

(d) Seek court orders for detainment under RCW 70.24.034, only for persons infected with HIV and only after:

(i) Exhausting procedures described in subsection (7)(a), (b), and (c) of this section; and

(ii) Enlisting, if appropriate, court enforcement of orders to cease and desist; and

(iii) Having sufficient evidence to "reasonably believe" the person is engaging in "behaviors presenting an imminent danger to public health."

(8) Conditions for detainment of individuals infected with sexually transmitted disease.

(a) A local health officer may notify the state health officer if he or she determines:

(i) The criteria for "behaviors presenting imminent danger to public health (BPID)" are met by an individual; and

(ii) Such individual fails to comply with a cease and desist order affirmed or issued by a court.

(b) A local or state health officer may request the prosecuting attorney to file an action in superior court to detain an individual specified in subsection (8)(a) of this section.

(c) The requesting local or state health officer or authorized representative shall:

(i) Notify the department prior to recommending the detainment setting where the individualized counseling and education plan may be carried out consistent with subsections (8)(d), (e), and (f) of this section;

(ii) Make a recommendation to the court for placement of such individual consistent with subsections (8)(d) and (f) of this section; and

(iii) Provide to the court an individualized plan for education and counseling consistent with subsection (8)(e) of this section.

(d) State board of health requirements for detainment of individuals demonstrating BPID:

(i) Sufficient number of staff, caregivers, and/or family members to:

(A) Provide round-the-clock supervision, safety of detainee, and security; and

(B) Limit and restrict activities to prevent BPID; and

(C) Make available any medical, psychological, or nursing care when needed; and

(D) Provide access to AIDS education and counseling; and

(E) Immediately notify the local or state health officer of unauthorized absence or elopement; and

(ii) Sufficient equipment and facilities to provide:

(A) Meals and nourishment to meet nutritional needs; and

(B) A sanitary toilet and lavatory; and

(C) A bathing facility; and

(D) Bed and clean bedding appropriate to size of detainee; and

(E) A safe detention setting appropriate to chronological and developmental age of detainee; and

(F) A private sleeping room; and

(G) Prevention of sexual exploitation.

(iii) Sufficient access to services and programs directed toward cessation of BPID and providing:

(A) Linguistically, socially, culturally, and developmentally appropriate ongoing AIDS education and counseling; and

(B) Psychological and psychiatric evaluation and counseling; and

(C) Implementation of court-ordered plan for individualized counseling and education consistent with subsection (8)(e) of this section.

(iv) If required, provide access to isolation and/or restraint in accordance with restraint and seclusion rules in WAC 275-55-263 (2)(c);

(v) Maintain a safe, secure environment free from harassment, physical danger, and sexual exploitation.

(e) Washington state board of health standards for an individualized counseling and education plan for a detainee include:

(i) Consideration of detainee's personal and environmental characteristics, culture, social group, developmental age, and language;

(ii) Identification of habitual and addictive behavior and relapse pattern;

(iii) Identification of unique risk factors and possible cross-addiction leading to behavior presenting imminent danger to public health;

(iv) Identification of obstacles to behavior change and determination of specific objectives for desired behavior;

(v) Provision of information about acquisition and transmission of HIV infection;

(vi) Teaching and training of individual coping skills to prevent relapse to BPID;

(vii) Specific counseling for chemical dependency, if required;

(viii) Identification of and assistance with access to community resources, including social services and self-help groups appropriate to provide ongoing support and maintenance of behavior change; and

(ix) Designation of a person primarily responsible for counseling and/or education who:

(A) Completed pretest and post-test counselor training approved by the office on AIDS; and

(B) Received training, as approved by the office on AIDS, focused on facilitating behavior change related to preventing BPID; and

(C) Has a post-graduate degree in social work, psychology, counseling, psychosocial nursing, or other allied profession; and

(D) Completed at least one year clinical experience after post-graduate education with a primary focus on individualized behavior change; and

(E) Is a certified counselor under chapter 18.19 RCW.

(x) Designation and provision of a qualified counselor under WAC 275-19-145 when the detainee is assessed to have a drug or alcohol problem.

(f) The state board of health designates the following settings appropriate for detainment provided a setting meets requirements in subsection (8)(d)(i), (ii), (iii), (iv), and (v) of this section:

(i) Homes, care facilities, or treatment institutions operated or contracted by the department;

(ii) Private homes, as recommended by the local or state health officer;

(iii) Boarding homes licensed under chapter 18.20 RCW;

(iv) Nursing homes licensed under chapter 18.51 RCW;

(v) Facilities licensed under chapter 71.12 RCW, including:

(A) Psychiatric hospitals, per chapter 246-322 WAC;

(B) Alcoholism treatment centers if certified for substance use under chapter 275-19 WAC;

(C) Adult residential rehabilitation centers, per chapter 246-325 WAC;

(D) Private adult treatment homes, per chapter 246-325 WAC;

(E) Residential treatment facilities for psychiatrically impaired children and youth, per chapter 246-323 WAC;

(vi) A hospital licensed under chapter 70.41 RCW.

(9) Jail administrators may order pretest counseling, post-test counseling, and HIV testing of persons detained in jail according to RCW 70.24.360 only under the following conditions:

(a) The jail administrator documents and reports to the local health officer, within seven days after the incident, any incident perceived to be actual or threatened "behaviors presenting possible risk"; and

(b) The local health officer:

(i) Determines the documented behavior or behaviors meet the criteria established in the definition of "behaviors presenting a possible risk"; and

(ii) Interviews the detained individual to evaluate the factual basis for alleged actual or threatened behavior; and

(iii) Makes a fact determination, based upon the documented behavior, the interview with the detained individual, and/or independent investigation, that sufficient factual evidence exists to support the allegation of actual or threatened "behaviors presenting possible risk"; and

(iv) Arranges for testing of the individual who is the source of the behavior to occur within seven days of the request from the jail administrator; and

(v) Reviews with the detained individual who is the source of the behavior the documentation of the actual or threatened behavior to try to assure understanding of the basis for HIV testing; and

(vi) Provides written approval of the jail administrator's order prior to HIV testing in accordance with subsection (7)(a)(i) of this section.

(c) The jail administrator maintains HIV test results and identity of the tested individual as a confidential, nondisclosable record, as provided in RCW 70.24.105.

(10) When an individual experiences a substantial exposure to another individual's body fluids and requests HIV testing of that other individual, the state and local health officers have authority to order pretest counseling, HIV testing, and post-test counseling of that other individual providing:

(a) The alleged exposure occurred when the individual was employed or acting as an authorized volunteer in one of the following employment categories:

(i) Law enforcement officer;

(ii) Firefighter;

(iii) Health care provider;

(iv) Staff of health care facilities; and

(b) The alleged substantial exposure occurred on the job; and

(c) The request to the health officer for testing and counseling of the individual was made within seven days of the occurrence of the alleged exposure; and

(d) The local health officer:

(i) Determines that the alleged exposure meets the criteria established in the definition of "substantial exposure"; and

(ii) Ensures that pretest counseling of the individual to be tested, or a legal representative, occurs; and

(iii) Arranges for testing of the individual who is the source of the exposure to occur within seven days of the request from the person exposed; and

(e) The exposed individual agrees to be tested for HIV if such testing is determined appropriate by the health officer; and

(f) Records on HIV testing ordered by a health officer are maintained only by the ordering health officer.

(11) For the purpose of RCW 49.60.172 concerning the absence of HIV infection as a bona fide occupational qualification only, "significant risk" means a job qualification which requires person-to-person contact likely to result in direct introduction of blood into the eye, an open cut or wound, or other interruption of the epidermis, when:

(a) No adequate barrier protection is practical; and

(b) Determined only on case-by-case basis consistent with RCW 49.60.180.

[Statutory Authority: RCW 43.20.050 and 70.24.130. 92-02-019 (Order 225B), § 246-100-206, filed 12/23/91, effective 1/23/92. Statutory Authority: RCW 43.20.050. 91-02-051 (Order 124B), recodified as § 246-100-206, filed 12/27/90, effective 1/31/91. Statutory Authority: Chapter 70.24 RCW. 89-07-095 (Order 325), § 248-100-206, filed 3/22/89; 88-21-093 (Order 322), § 248-100-206, filed 10/19/88; 88-17-056 (Order 316), § 248-100-206, filed 8/17/88. Statutory Authority: RCW 43.20.050. 87-11-047 (Order 302), § 248-100-206, filed 5/19/87.]

**WAC 246-100-207 Human immunodeficiency virus (HIV) testing—Ordering—Laboratory screening—Interpretation—Reporting.** (1) Any person ordering or prescribing an HIV test for another, except for seroprevalent studies under chapter 70.24 RCW or provided under subsections (2) and (3) of this section, shall:

(a) Provide or refer for pretest counseling described under WAC 246-100-209;

(b) Obtain or ensure informed specific consent of the individual to be tested separate from other consents prior to ordering or prescribing an HIV test, unless excepted under provisions in chapter 70.24 RCW; and

(c) Provide or refer for post-test counseling described under WAC 246-100-209 if HIV test is positive for or suggestive of HIV infection.

(2) Blood banks, tissue banks, and others collecting or processing blood, sperm, tissues, or organs for transfusion/transplanting shall:

(a) Obtain or ensure informed specific consent of the individual prior to ordering or prescribing an HIV test, unless excepted under provisions in chapter 70.24 RCW;

(b) Explain that the reason for HIV testing is to prevent contamination of the blood supply, tissue, or organ bank donations; and

(c) At the time of notification regarding a positive HIV test, provide or ensure at least one individual counseling session.

(3) Persons subject to regulation under Title 48 RCW and requesting an insured, subscriber, or potential insured or subscriber to furnish the results of an HIV test for underwriting purposes, as a condition for obtaining or renewing coverage under an insurance contract, health care service contract, or health maintenance organization agreement shall:

(a) Before drawing blood to perform an HIV test, provide written information to the individual tested explaining:

- (i) What an HIV test is;
- (ii) Behaviors placing a person at risk for HIV infection;
- (iii) The purpose of HIV testing in this setting is to determine eligibility for coverage;
- (iv) The potential risks of HIV testing; and
- (v) Where to obtain HIV pretest counseling.

(b) Obtain informed specific written consent for an HIV test. The written informed consent shall include:

(i) An explanation of confidential treatment of test result reports limited to persons involved in handling or determining applications for coverage or claims for the applicant or claimant; and

(ii) Requirements under subsection (3)(c) of this section.

(c) Establish procedures to inform an applicant of the following:

(i) Post-test counseling specified under WAC 246-100-209(4) is required if an HIV test is positive or indeterminate;

(ii) Post-test counseling is done at the time any positive or indeterminate HIV test result is given to the tested individual;

(iii) The applicant is required to designate a health care provider or health care agency to whom positive or indeterminate HIV test results are to be provided for interpretation and post-test counseling; and

(iv) When an individual applicant does not identify a designated health care provider or health care agency and the applicant's HIV test results are positive or indeterminate, the insurer, health care service contractor, or health maintenance organization shall provide the test results to the local health department for interpretation and post-test counseling.

(4) Laboratories and other places where HIV testing is performed shall demonstrate complete and satisfactory participation in an HIV proficiency testing program approved by the Department Laboratory Quality Assurance Section,

Mailstop K17-9, 1610 N.E. 150th, Seattle, Washington 98155.

(5) The department laboratory quality assurance section shall accept substitutions for EIA screening only as approved by the United States Food and Drug Administration (FDA) and a published list or other written FDA communication.

(6) Medical laboratories testing for the presence of HIV shall:

(a) Send an HIV test prevalence results report by telephone or in writing to the department office on AIDS (Mailstop K17-9, 1610 N.E. 150th, Seattle, Washington 98155), quarterly or more often; and

(b) Include in the report:

(i) Number of samples tested;

(ii) Number of samples repeatedly reactive by enzyme immuno assay (EIA);

(iii) Number of samples tested by western blot assay (WBA) or other confirmatory test as approved by department office on AIDS;

(iv) Number of positive test results by WBA or other confirmatory test as approved by department office on AIDS;

(v) Number of specimens tested by viral culture; and

(vi) Number of positive test results from viral cultures.

(7) Persons informing a tested individual of positive laboratory test results indicating HIV infection shall do so only when:

(a) HIV is isolated by viral culture technique; or

(b) HIV antibodies are identified by a sequence of tests which are reactive and include:

(i) A repeatedly reactive screening test such as the enzyme immunoassay (EIA); and

(ii) An additional, more specific, assay such as a positive western blot assay (WBA) or other tests as defined and described in the AIDS office manual, April, 1988, Department of Health, Office on AIDS, P.O. Box 47840, Olympia, Washington 98504-7840.

(c) Such information consists of relevant, pertinent facts communicated in such a way that it will be readily understood by the recipient.

[Statutory Authority: RCW 43.20.050 and 70.24.130. 92-02-019 (Order 225B), § 246-100-207, filed 12/23/91, effective 1/23/92. Statutory Authority: RCW 43.20.050. 91-02-051 (Order 124B), recodified as § 246-100-207, filed 12/27/90, effective 1/31/91. Statutory Authority: Chapter 70.24 RCW and RCW 70.24.130. 89-20-006 (Order 334), § 248-100-207, filed 9/22/89, effective 10/23/89. Statutory Authority: Chapter 70.24 RCW. 89-14-003 (Order 329), § 248-100-207, filed 6/22/89; 88-17-058 (Order 318), § 248-100-207, filed 8/17/88.]

**WAC 246-100-208 Counseling standard—AIDS counseling.**

(1) Principal health care providers shall counsel or ensure AIDS counseling for:

(a) Each pregnant woman; and

(b) Each patient seeking treatment of a sexually transmitted disease.

(2) Drug treatment programs under chapter 70.96A RCW shall provide or ensure provision of AIDS counseling for each person in a drug treatment program.

(3) Health care providers, persons, and organizations providing AIDS counseling shall:

(a) Assess the behaviors of each individual counseled for risk of acquiring and transmitting human immunodeficiency virus (HIV);

(b) Maintain a nonjudgmental environment during counseling which:

(i) Considers the individual's particular circumstances; and

(ii) Is culturally, socially, linguistically, and developmentally appropriate to the individual being counseled.

(c) Focus counseling on behaviors increasing the risk of HIV acquisition and transmission;

(d) Provide or ensure provision of personalized risk reduction education to individuals who:

(i) Are men who had sex with other men at any time since 1977;

(ii) Used intravenous substances at any time since 1977;

(iii) Engaged in sex for money or drugs at any time since 1977;

(iv) Have had sexual and/or injection equipment-sharing contact with persons listed in subsection (3)(d)(i), (ii), and (iii) of this section;

(v) Have been exposed to or known to have had a sexually transmitted disease at any time since 1977;

(vi) Are at increased risk of HIV infection by definition of United States Public Health Service, Centers for Disease Control;

(vii) Are enrolled in a drug treatment program under chapter 69.54 RCW; or

(viii) Received multiple transfusions of blood, plasma, or blood products from 1977 to 1985.

(e) Encourage individuals assessed to be at other than virtually no risk of HIV infection to:

(i) Receive AIDS risk reduction counseling;

(ii) Consider information about the nature, purpose, and potential ramifications of HIV testing;

(iii) Receive pretest counseling;

(iv) Consider confidential or anonymous voluntary HIV testing if appropriate; and

(v) "Virtually no risk of HIV infection" means persons with medical histories absent of and reporting none of the following factors:

(A) Transfusion with blood or blood products at any time since 1977;

(B) Residence at any time in countries where HIV is considered endemic since 1977;

(C) Unprotected sex between men at any time since 1977;

(D) Use of intravenous substances at any time since 1977, especially when sharing injection equipment;

(E) Engagement in sex for money or drugs at any time since 1977;

(F) Sexual and/or injection equipment-sharing contacts at any time since 1977 with persons listed in subsection (3)(e)(iii)(C), (D), and (E) of this section;

(G) Exposure to a sexually transmitted disease; and

(H) Increased risk of HIV infection by definition of United States Public Health Service, Centers for Disease Control.

(4) Persons and organizations providing AIDS counseling may provide additional or more comprehensive counseling than required in this section.

[Statutory Authority: RCW 43.20.050 and 70.24.130. 92-02-019 (Order 225B), § 246-100-208, filed 12/23/91, effective 1/23/92. Statutory Authority: RCW 43.20.050. 91-02-051 (Order 124B), recodified as § 246-

100-208, filed 12/27/90, effective 1/31/91. Statutory Authority: Chapter 70.24 RCW. 88-17-058 (Order 318), § 248-100-208, filed 8/17/88.]

**WAC 246-100-209 Counseling standards—Human immunodeficiency virus (HIV) pretest counseling—HIV post-test counseling.** (1) Health care providers and other persons providing pretest counseling shall:

(a) Assess the individual's risk of acquiring and transmitting HIV by evaluating information about the individual's possible risk-behaviors;

(b) Provide at least one individual counseling session prior to HIV testing;

(c) Inform any individual planning to be tested for HIV that:

(i) If the test result is positive, the tested individual needs to notify sex and injection equipment-sharing partners that partners:

(A) May have been exposed to and infected with HIV; and

(B) Should seek HIV pretest counseling and consider HIV testing; and

(ii) Unless HIV testing is anonymous, the principal health care provider is required to refer identities of at-risk partners to the local health officer or authorized representative if:

(A) The HIV-infected individual either refuses or is unable to notify partners of exposure, possible infection, and need for pretest counseling and HIV testing; or

(B) The HIV-infected individual neither accepts assistance nor agrees to referral to the local health officer or an authorized representative for assistance in notifying partners; and

(iii) Unless HIV testing is anonymous, the principal health care provider is required to refer the identify of the individual testing positive to the local health officer or an authorized representative if the principal health care provider made efforts, but was unable to meet face-to-face with the individual to:

(A) Notify the individual of the HIV test result; and

(B) Provide post-test counseling, as required in this section, to assure partner notification.

(2) When an individual is assessed by a counselor or health care provider as "virtually no risk of HIV infection," as defined in WAC 246-100-208 (3)(e)(v) a counselor or the health care provider shall, in addition to subsection (1)(a) of this section:

(a) Maintain a nonjudgmental environment during counseling which:

(i) Considers the individual's particular circumstances; and

(ii) Is culturally, socially, linguistically, and developmentally appropriate to the individual being counseled.

(b) Explain the nature, purpose, value, and reason for the HIV tests;

(c) Explain the possible effect of HIV testing and a positive HIV test result related to employment, insurance, housing, and other potential legal, social, and personal consequences;

(d) Develop and maintain a system of referral and make referrals that:

(i) Are accessible and confidential for those counseled;

(ii) Are acceptable to and supportive of those counseled;

(iii) Provide assistance to those counseled in maintaining risk reduction behaviors.

(e) Provide at least one individual counseling session at the time HIV test results are disclosed to individuals testing positive; and

(f) Maintain disclosure and confidentiality requirements in WAC 246-100-016.

(3) If the individual is assessed by a health care provider to be other than "virtually no risk of HIV infection," as defined in WAC 246-100-208 (3)(e)(v), the person providing pretest counseling shall maintain requirements in subsection (1) and (2) of this section and:

(a) Focus counseling on behaviors increasing the risk of HIV acquisition and transmission;

(b) Provide personalized risk reduction education to individuals who:

(i) Are men engaging in unprotected intercourse with other men at any time since 1977;

(ii) Used intravenous substances at any time since 1977, especially those sharing injection equipment;

(iii) Engaged in sex for money or drugs at any time since 1977;

(iv) Have had sexual and/or injection equipment-sharing contacts at any time since 1977 with persons listed in subsection (3)(b)(i), (ii), and (iii) of this section;

(v) Have been exposed to or diagnosed with a sexually transmitted disease;

(vi) Are at increased risk of HIV infection by definition of United States Public Health Services, Centers for Disease Control;

(vii) Are required by RCW 70.24.095 and 70.24.340 to receive HIV counseling and testing.

(c) Inform any individual planning to be tested for HIV of the need to notify sexual and injection equipment-sharing partners if test results are positive;

(d) Advise individuals listed in subsection (3)(b)(i), (ii), and (iii) of this section not to donate or sell blood, blood products, semen, organs, or other body tissues; and

(e) Emphasize or reemphasize the following counseling messages:

(i) The following will eliminate or decrease the risk of HIV infection:

(A) Sexual abstinence;

(B) A mutually monogamous relationship between uninfected people; and

(C) Following safer sex guidelines.

(ii) Do not share intravenous drugs and injection equipment;

(iii) Do not engage in behaviors in which blood, vaginal fluid, or semen is exchanged;

(iv) Condoms, even if used properly, do not supply absolute protection from HIV infection;

(v) Condoms may reduce risk of HIV infection if the condom is:

(A) Latex and used with a water-based lubricant rather than an oil-based lubricant, if a lubricant is used;

(B) Used in conjunction with spermicide during vaginal or anal intercourse; and

(C) Worn from start to finish of vaginal, oral, and anal intercourse.

(vi) Dental dams may reduce risk of HIV infection if the dental dam is:

(A) Latex; and

(B) Used from start to finish of oral intercourse.

(vii) The sexual behaviors having highest risk for HIV infection are those involving the exchange of blood or semen, especially receptive anal and vaginal intercourse;

(viii) Anal intercourse may increase the risk of condom failure and HIV infection;

(ix) Infected women should postpone pregnancy until more is known about how to prevent prenatal and perinatal transmission of HIV infection;

(x) Sexual negotiation skills can be learned to enhance risk reduction; and

(xi) Other sexually transmitted diseases, especially those causing genital ulcers, may increase the risk of acquiring or transmitting HIV infection.

(f) Make those counseled aware HIV retesting at a later date may be necessary or recommended.

(4) Persons providing post-test counseling shall:

(a) Follow requirements in subsection (1) of this section;

(b) Provide at least one individual counseling session at the time HIV test results are disclosed for individuals:

(i) Testing positive for HIV; or

(ii) Reporting practice of behaviors listed in (3)(b)(i), (ii), and (iii) of this section.

(c) If the individual being counseled tested positive for HIV infection:

(i) Provide assistance to persons in notifying partners; and/or

(ii) Offer to refer individuals to the local health officer as necessary for assistance in notifying partners; and/or

(iii) Offer to refer partners for counseling and testing; and

(iv) Develop or adopt a system to avoid documenting the names of referred partners in the permanent record of the individual being counseled; and

(v) Offer referral for alcohol and drug and mental health counseling, including suicide prevention, if appropriate; and

(vi) Refer for tuberculosis screening.

[Statutory Authority: RCW 43.20.050 and 70.24.130. 92-02-019 (Order 225B), § 246-100-209, filed 12/23/91, effective 1/23/92. Statutory Authority: RCW 43.20.050. 91-02-051 (Order 124B), recodified as § 246-100-209, filed 12/27/90, effective 1/31/91. Statutory Authority: Chapter 70.24 RCW. 89-02-008 (Order 324), § 248-100-209, filed 12/27/88; 88-17-058 (Order 318), § 248-100-209, filed 8/17/88.]

#### **WAC 246-100-211 Special diseases—Tuberculosis.**

(1) Health care providers diagnosing or caring for a person with tuberculosis, whether pulmonary or nonpulmonary, shall:

(a) Report the case to the local health officer or local health department in accordance with the provisions of this chapter, and

(b) Report patient status to the local health officer every three months or as requested.

(2) The local health officer or local health department shall:

(a) Have primary responsibility for control of tuberculosis within the designated jurisdiction;

(b) Maintain a tuberculosis control program including:

(i) Prophylaxis,

(ii) Treatment,

(iii) Surveillance,



- (iv) Case finding,
- (v) Contact tracing, and
- (vi) Other aspects of epidemiologic investigation;
- (c) Maintain a tuberculosis register of all persons with tuberculosis, whether new or recurrent, within the local jurisdiction including information about:
  - (i) Identification of patient,
  - (ii) Clinical condition,
  - (iii) Epidemiology of disease,
  - (iv) Frequency of examinations;
- (d) Impose isolation of a person with tuberculosis in an infectious stage if that person does not observe precautions to prevent the spread of the infection;
- (e) Designate the place of isolation when imposed;
- (f) Release the person from isolation when appropriate;
- (g) Maintain and provide outpatient tuberculosis diagnostic and treatment services as necessary, including public health nursing services and physician consultation; and
- (h) Submit reports of all cases to the department in accordance with the provisions of this chapter.
- (3) When a person with tuberculosis requires hospitalization,
  - (a) Hospital admission shall occur in accordance with procedures arranged by the local health officer and the medical director or administrator of the hospital, and
  - (b) The principal health care provider shall:
    - (i) Maintain responsibility for deciding date of discharge, and
    - (ii) Notify the local health officer of intended discharge in order to assure appropriate outpatient arrangements.

[Statutory Authority: RCW 43.20.050. 91-02-051 (Order 124B), recodified as § 246-100-211, filed 12/27/90, effective 1/31/91; 87-11-047 (Order 302), § 248-100-211, filed 5/19/87.]

**WAC 246-100-216 Special diseases—Surveillance for influenza.** Local health departments shall:

- (1) Maintain a surveillance system for influenza during the appropriate season which may include:
  - (a) Monitoring of excess school absenteeism,
  - (b) Sample check with health care providers, clinics, and hospitals regarding influenza like illnesses,
  - (c) Monitoring of work place absenteeism and other mechanisms.
- (2) Encourage submission of appropriate clinical specimens from a sample of patients with influenza-like illness to the Washington state public health laboratory or other laboratory approved by the state health officer.

[Statutory Authority: RCW 43.20.050. 91-02-051 (Order 124B), recodified as § 246-100-216, filed 12/27/90, effective 1/31/91; 87-11-047 (Order 302), § 248-100-216, filed 5/19/87.]

**WAC 246-100-217 Special condition—Pesticide poisoning.** (1) Definitions. For the purposes of this section, the following words and phrases have the following meanings unless the context clearly indicates otherwise:

- (a) "Case of pesticide poisoning" means a person, alive or dead, having been diagnosed as poisoned by any pesticide with the diagnosis based on clinical and/or laboratory evidence.

(b) "Pesticide" means any pesticide defined in RCW 70.104.020, as now stated and as may be amended in the future.

(c) "Pesticide applicator" means any person applying pesticides under the authority of the licensing provisions of chapter 15.58 RCW, as a pesticide applicator and/or operator and any person applying pesticides to more than one acre of land in a calendar year.

(d) "Pesticide poisoning" means the disturbance of function, damage to structure, or illness in humans resulting from the inhalation, absorption, ingestion of, or contact with any pesticide.

(e) "PIRT" means the pesticide incident reporting and tracking review panel established under the provisions of RCW 70.104.080 with responsibilities as described in RCW 70.104.090.

(f) "Suspected case of pesticide poisoning" means a case in which the diagnosis is thought more likely than not to be pesticide poisoning.

(2) Any attending physician or other health care provider recognized as primarily responsible for the diagnosis and treatment of a patient or, in the absence of a primary health care provider, the health care provider initiating diagnostic testing or therapy for a patient shall:

(a) Notify the department of any case or suspected case of pesticide poisoning, using the toll-free pesticide reporting telephone number (1-800-356-2323), within the following time limits:

(i) Immediately, when:

(A) A hospital admission is due to pesticide poisoning or suspected pesticide poisoning;

(B) A death is due to pesticide poisoning or suspected pesticide poisoning; or

(C) A threat to public health, such as multiple cases, is perceived;

(ii) Within four days for all other cases or suspected cases;

(b) Within seven days, submit to the department on a department-approved form, an individual case report for each case or suspected case of pesticide poisoning (unless the department of health waives the requirement to submit an individual case report because pertinent information was provided by phone);

(c) Comply with the same confidentiality requirements established for other reportable diseases or conditions in WAC 246-100-016; and

(d) Respond to department inquiries regarding reported cases.

(3) Health care providers notifying the department shall provide:

(a) Name of patient;

(b) Patient's home and/or mailing address;

(c) Patient's home and/or work telephone number;

(d) Age;

(e) Sex;

(f) Race/ethnicity;

(g) Diagnosis or suspected diagnosis, including:

(i) Name of pesticide, if known;

(ii) Date of exposure; and

(iii) Date of onset;

(h) Name, address, and telephone number of the principal health care provider;

(i) Name, address, and telephone number of the person reporting; and

(j) Occupation and employer's name and address, if occupational exposure.

(4) The department shall:

(a) Initiate an investigation of each report of a case or suspected case of pesticide poisoning and such cases of suspected pesticide poisoning of animals that may relate to human illness to document the incident within the following time limits:

(i) Immediately after notification is received from the health care provider of:

(A) A hospital admission due to pesticide poisoning or suspected pesticide poisoning;

(B) A death due to pesticide poisoning or suspected pesticide poisoning; or

(C) A threat to public health, such as multiple cases;

(ii) Within forty-eight hours after notification is received for all other cases;

(b) Supply case report forms to health care providers for purposes of reporting cases or suspected cases of pesticide poisoning;

(c) Document the known environmental, human, and/or other variables associated with the case or suspected case of pesticide poisoning;

(d) Report the results of the pesticide investigation to the principal health care provider named in the case report form and to the local health officer in whose jurisdiction the exposure has occurred;

(e) Provide a monthly report of cases or suspected cases of pesticide poisoning to the PIRT panel, as required under RCW 70.104.055; and

(f) Complete case investigations within ninety days unless extenuating circumstances or surveillance needs require a longer investigation time.

[Statutory Authority: RCW 43.20.050 and 70.104.055. 92-02-019 (Order 225B), § 246-100-217, filed 12/23/91, effective 1/23/92. Statutory Authority: RCW 43.20.050, 91-02-051 (Order 124B), recodified as § 246-100-217, filed 12/27/90, effective 1/31/91. Statutory Authority: Chapter 70.104 RCW. 90-10-036 (Order 049), § 248-100-217, filed 4/26/90, effective 5/27/90.]

**WAC 246-100-218 Special condition—Gunshot wounds.** (1) Pursuant to RCW 43.70.545 (relating to acts of violence) the state department of health finds that gunshot trauma is a significant public health problem which warrants mandatory reporting for purposes of monitoring, assessment, and development of prevention strategies.

(2) Definitions. For the purposes of this section, the following words and phrases have the following meanings:

(a) "Gunshot wound" means any injury caused by the projectile of any type gun including, but not limited to, rifles, shotguns, handguns, and bb/pellet guns.

(b) "Reportable gunshot wound" means a gunshot wound which results in death or an injury severe enough to warrant medical attention at a hospital emergency department in Washington state.

(3) Responsibilities of hospitals. Hospitals shall report to the state department of health all gunshot wounds treated in their emergency departments, regardless of whether the patient is subsequently hospitalized or discharged. Reports shall be made on reporting forms furnished by the state

department of health, and submitted within thirty days following the date of treatment.

(4) Responsibilities of medical examiners and coroners. Coroners and medical examiners shall report all gunshot deaths which occur in their jurisdictions. Reports shall be made on forms furnished by the state department of health, and submitted within sixty days following the date of death.

(5) Information to be reported. Information items to be reported include the following, provided they are routinely collected and available at the time of report preparation:

(a) Victim's name, gender, date of birth, race, and residence (city, state, zip code);

(b) Shooting date, time, and location;

(c) Type of gun used;

(d) Whether the shooting was done by the victim or another person;

(e) Whether the shooting was intentional or unintentional;

(f) Circumstance (e.g., argument, drive by shooting, other crime-related circumstance);

(g) Relationship between perpetrator and victim;

(h) Perpetrator's age, gender and race;

(i) Suspected drug or alcohol involvement;

(j) Anatomic location(s) of gunshot wound(s);

(k) Whether victim was released to home, admitted to hospital, transferred, or died.

(6) Record security and disclosure. Reports of gunshot wounds shall be treated as confidential records consistent with the requirements of the Health Care Information Act (chapter 70.02 RCW) and WAC 246-100-091.

[Statutory Authority: RCW 43.70.545. 96-08-028, § 246-100-218, filed 3/27/96, effective 4/27/96.]

**WAC 246-100-231 Duties of laboratories—Submission of specimens by laboratories.** (1) The director of every medical laboratory shall:

(a) Submit microbiologic cultures, subcultures, or appropriate clinical material as specified in subsection (2) of this section to the Washington state public health laboratory or other laboratory designated by the state health officer for diagnosis, confirmation, or further testing;

(b) Identify each specimen on a form provided or approved by the department including:

(i) The patient's name, and, if available,

(ii) Age, sex, date of onset of illness, first and last name of principal health care provider.

(2) When test results indicate possible infection with any of the following, laboratory action shall include:

(a) Brucellosis (*Brucella* species): Submit suspicious subcultures for confirmation and final identification;

(b) Cholera (*Vibrio cholerae*): Submit subcultures for confirmation and final identification;

(c) Diphtheria (*Corynebacterium diphtheriae*): Submit subcultures for identification and for toxin study when indicated;

(d) Malaria (*Plasmodium* species): Laboratories are encouraged to submit thick and thin stained smears for conformation, final identification, and forwarding for international epidemiologic surveillance;

(e) Meningococcal infection of blood or spinal fluid (*Neisseria meningitidis*): Submit subcultures for confirmation and final identification;

(f) Plague (*Yersinia pestis*): Submit subcultures or appropriate clinical material for confirmation;

(g) Salmonellosis, including typhoid fever (*Salmonella* species): Submit subcultures for confirmation and serotyping;

(h) Shigellosis (*Shigella* species): Submit subcultures for confirmation and serotyping;

(i) Syphilis (*Treponema pallidum*): Submit reactive or weakly reactive serologic specimens for confirmation and further definitive testing;

(j) Mycobacteriosis, including tuberculosis (*Mycobacterium* species): Submit subcultures of initial isolates for:

(i) *Mycobacterium tuberculosis*,

(ii) *Mycobacterium bovis*, and

(iii) Other mycobacterial species when isolate is suspected of causing disease.

(k) Tularemia (*Francisella tularensis*): Submit subcultures or appropriate clinical material for confirmation.

(3) When clinical impression and epidemiologic circumstances indicate a possible case of botulism, laboratory action shall include the following:

(a) Infant botulism: Submit stool for clostridium botulinum identification and toxin typing,

(b) Food borne botulism:

(i) Submit serum and stool for *C. botulinum* identification and toxin typing, and

(ii) If available, submit suspect foods (ideally in original containers).

(c) Wound botulism: Submit subculture or serum, debrided tissue, or swab sample from wound for *C. botulinum* identification.

(4) The state health officer may require submission of specimens for other infections of public health concern as described in WAC 246-100-041.

[Statutory Authority: RCW 43.20.050, 92-02-019 (Order 225B), § 246-100-231, filed 12/23/91, effective 1/23/92; 91-02-051 (Order 124B), recodified as § 246-100-231, filed 12/27/90, effective 1/31/91; 88-07-063 (Order 308), § 248-100-231, filed 3/16/88; 87-11-047 (Order 302), § 248-100-231, filed 5/19/87.]

**WAC 246-100-236 Duties of laboratories—Reporting of laboratory results indicative of certain reportable diseases.** (1) By December 31, 1987, medical laboratories shall:

(a) Report each positive culture or other suggestive test results to the local health officer by phone, written report, or submission of specimen within two working days, unless specified otherwise, for:

(i) Anthrax (*Bacillus anthracis*),

(ii) Botulism (*Clostridium botulinum*),

(iii) Cholera (*Vibrio cholerae*),

(iv) Diphtheria (*Corynebacterium diphtheriae*) - toxigenic strains,

(v) Gonorrhea (*Neisseria gonorrhoeae*) (report within seven days),

(vi) Measles (rubeola) (measles virus),

(vii) Plague (*Yersinia pestis*),

(viii) Rabies (rabies virus),

(ix) Brucellosis (*Brucella* species),

(x) Leptospirosis (*Leptospira interrogans*),

(xi) Listeria infection of blood or spinal fluid (*Listeria monocytogenes*),

(xii) Meningococcal infection of blood or spinal fluid (*N. meningitidis*),

(xiii) Pertussis (*Bordetella pertussis*),

(xiv) Salmonellosis (*Salmonella* species),

(xv) Shigellosis (*Shigella* species), and

(xvi) Hepatitis A (positive anti-HAV IgM),

(xvii) Mycobacteriosis.

(b) Send a copy of the state form accompanying specimen submitted as required in WAC 246-100-231 or identifying information including:

(i) Type of specimen tested (e.g., serum or sputum),

(ii) Test result,

(iii) Name of reporting laboratory,

(iv) Date of report,

(v) Name of requesting health care provider or health care facility, and

(vi) Name of patient.

(2) By December 31, 1987, medical laboratories shall report positive cultures or other suggestive test results for chlamydial infection (*Chlamydia trachomatis*) to local health departments monthly including either:

(a) Identifying information specified in subsection (1)(b)(i-vi) of this section, or

(b) Aggregate numbers of positive tests including age, sex, and site of infection when known.

(3) Medical laboratories shall label or stamp reports appropriately with information indicating "reportable disease" and the telephone number of the local health department, if such labels or stamps are provided by the local health department.

(4) State and local health officers and health departments receiving reports from medical laboratories shall:

(a) Allow time for the laboratory to notify the principal health care provider prior to contact if:

(i) Delay is unlikely to jeopardize public health, and

(ii) The laboratory requests a delay.

(b) Try to contact the principal health care provider and discuss circumstances prior to contact of a patient when possible.

(5) By June 1995, medical laboratories performing CD4+ (T4) tests or sending specimens for CD4 testing out-of-state shall submit to the state HIV/AIDS office monthly or quarterly reports on the enumeration of CD4+ (T4) lymphocyte counts (CD4+ counts) and CD4+ (T4) percents of total lymphocytes (CD4+ percents) for specimens submitted after January 1, 1995, of patients aged thirteen or older with CD4+ counts less than two hundred or CD4+ percents less than fourteen. Laboratories may, but are not required to, exclude information concerning specimens which are unrelated to HIV infection or performed in conjunction with medical research, but otherwise shall report the following information:

(a) Patient-specific identifier or anonymous code or, if authorized by the patient, the patient's name submitted to the laboratory; and

(b) Name of the patient's health care provider; and

(c) Address of patient's health care provider; and

(d) CD4+ count (and CD4+ percent if available); and

(e) Date of CD4+ count or CD4+ percent.

[Statutory Authority: RCW 70.24.130, 95-13-037, § 246-100-236, filed 6/14/95, effective 7/15/95. Statutory Authority: Chapter 70.24 RCW, 93-08-036 (Order 354B), § 246-100-236, filed 4/1/93, effective 5/2/93. Statutory Authority: RCW 43.20.050, 92-02-019 (Order 225B), § 246-100-236, filed 12/23/91, effective 1/23/92; 91-02-051 (Order 124B), recodified as § 246-100-236, filed 12/27/90, effective 1/31/91; 88-07-063 (Order 308), § 248-100-236, filed 3/16/88; 87-11-047 (Order 302), § 248-100-236, filed 5/19/87.]

**WAC 246-100-241 Duties of laboratories—Duty to cooperate with local health departments and the department.** (1) Medical laboratories shall:

(a) Cooperate with local health departments and the department in the investigation of an outbreak, suspected outbreak, case, suspected case, carrier, or contact of a communicable disease or reportable disease or condition, and

(b) Provide, in a timely manner, any information related to the laboratory features of the investigation when requested by the local or state health officer.

(2) A laboratory director may designate responsibility for working and cooperating with public health personnel to certain laboratory employees as long as designated employees are:

(a) Readily available, and

(b) Able to provide requested information in a timely manner.

[Statutory Authority: RCW 43.20.050, 91-02-051 (Order 124B), recodified as § 246-100-241, filed 12/27/90, effective 1/31/91; 87-11-047 (Order 302), § 248-100-241, filed 5/19/87.]

**Chapter 246-110 WAC**

**CONTAGIOUS DISEASE—SCHOOL DISTRICTS AND DAY CARE CENTERS**

**WAC**

246-110-001	Purpose.
246-110-010	Definition.
246-110-020	Control of communicable (contagious) disease.

**WAC 246-110-001 Purpose.** The following regulations are adopted by the board of health for the purpose of governing the presence on or about any school or day care center premises of susceptible persons who have, or have been exposed to, a communicable disease. These regulations are in addition to other requirements imposed by chapter 246-100 WAC.

In furtherance of the purpose and intent of the law and these regulations, it is recommended that parents of students whose medical supervision seems inadequate should be encouraged to obtain the services of a physician for the child. When the economic situation warrants, the parents should be guided to the appropriate source of community-sponsored medical care. These regulations are not intended to imply that any diagnosis or treatment will be performed by school or day care center personnel.

[Statutory Authority: RCW 43.20.050, 92-02-019 (Order 225B), § 246-110-001, filed 12/23/91, effective 1/23/92; 91-02-051 (Order 124B), recodified as § 246-110-001, filed 12/27/90, effective 1/31/91; 90-21-056 (Order 095), § 248-101-011, filed 10/15/90, effective 10/15/90.]

**WAC 246-110-010 Definition.** As used in this portion of these regulations, these terms shall mean:

(1) "Contact" means a person exposed to an infected person, animal, or contaminated environment which might provide an opportunity to acquire the infection.

(2) "Exposure" means such association with a person or animal in the infectious stage of a disease, or with a contaminated environment, as to provide the opportunity to acquire the infection.

(3) "Susceptible" means a person who does not possess sufficient resistance, whether natural or induced, to a pathogenic agent or disease to prevent contracting that disease when exposed thereto.

(4) "Communicable disease (contagious disease)" means an illness caused by an infectious agent which can be transmitted from one person, animal, or object to another person by direct or indirect means including transmission via an intermediate host or vector, food, water, or air. Communicable (contagious) diseases include, but are not limited to:

(a) Chickenpox

(b) Conjunctivitis (bacterial)

(c) Diphtheria

(d) Giardiasis

(e) Hepatitis A

(f) Invasive Haemophilus influenza disease (excluding otitis media)

(g) Measles

(h) Meningitis (bacterial)

(i) Mumps

(j) Pediculosis

(k) Pertussis

(l) Rubella

(m) Salmonellosis

(n) Shigellosis

(o) Tuberculosis

(5) "School" means each building, facility, and location at or within which any or all portions of a preschool, kindergarten and grades one through twelve program of education and related activities are conducted for two or more children by or in behalf of any public school district and by or in behalf of any private school or private institution subject to approval by the state board of education.

(6) "Day care center" means an agency which regularly provides care for a group of children for periods of less than twenty-four hours and is licensed pursuant to chapter 74.15 RCW.

(7) "Outbreak" means the occurrence of cases of a disease or condition in any area over a given period of time in excess of the expected number of cases.

[Statutory Authority: RCW 43.20.050, 91-02-051 (Order 124B), recodified as § 246-110-010, filed 12/27/90, effective 1/31/91; 90-21-056 (Order 095), § 248-101-021, filed 10/15/90, effective 10/15/90.]

**WAC 246-110-020 Control of communicable (contagious) disease.** (1) When there is an outbreak of a contagious disease, as defined in WAC 246-110-010, such that there is the potential for a case or cases within a school or day care center, the local health officer, if appropriate, after consultation with the secretary of health or designee shall take all medically appropriate actions deemed to be necessary to control or eliminate the spread of the disease, including, but not limited to:

(a) Closing the affected school(s) or day care center(s), or part(s) thereof;

(b) Closing other schools or day care centers in the local health officer's jurisdiction;

(c) Causing the cessation of selected school or day care center activities or functions;

(d) Excluding from schools or day care centers in the local health officer's jurisdiction any students, staff, and volunteers who are infected with, or deemed to be susceptible to, the disease.

(2) Prior to taking action the health officer shall:

(a) Consult with and discuss the ramifications of action with the superintendent of the school district, or the chief administrator of the day care center or their designees on the proposed action; and

(b) Provide the board of directors and the superintendent of the school district or the chief administrator of the day care center a written decision in the form and substance of an order directing them to take action;

(3) Where these actions have been taken, the local health officer shall, in addition:

(a) Set the terms and conditions permitting schools or day care centers to reopen; activities and functions to resume; and excluded students, staff and volunteers to be readmitted; and

(b) Pursue, in consultation with the secretary of health or designee and school and/or day care officials, the investigation of the source of disease, or order those actions necessary to the ultimate control of the disease.

[Statutory Authority: RCW 43.20.050, 92-02-019 (Order 225B), § 246-110-020, filed 12/23/91, effective 1/23/92; 91-02-051 (Order 124B), recodified as § 246-110-020, filed 12/27/90, effective 1/31/91; 90-21-056 (Order 095), § 248-101-221, filed 10/15/90, effective 10/15/90.]

**Chapter 246-130 WAC**

**HUMAN IMMUNODEFICIENCY VIRUS (HIV) INFECTION INTERVENTIONS**

**WAC**

246-130-001	Purpose.
246-130-010	Definitions.
246-130-020	Early intervention services.
246-130-030	Reimbursements.
246-130-040	Financial eligibility.
246-130-060	Medical and financial information.
246-130-070	Participation.

**DISPOSITION OF SECTIONS FORMERLY CODIFIED IN THIS CHAPTER**

246-130-050	Transfer of resources without adequate consideration. [Statutory Authority: RCW 43.70.040, 91-02-049 (Order 121), recodified as § 246-130-050, filed 12/27/90, effective 1/31/91. Statutory Authority: RCW 43.70.120, 90-17-087 (Order 071), § 248-168-050, filed 8/17/90, effective 9/17/90. Statutory Authority: RCW 43.20A.550, 87-22-012 (Order 2549), § 248-168-050, filed 10/26/87.] Repealed by 95-23-018, filed 11/7/95, effective 12/8/95. Statutory Authority: RCW 43.70.040 and 43.70.120.
-------------	---

**WAC 246-130-001 Purpose.** The department shall administer federal and state funds appropriated to assist eligible persons with HIV infection to access early intervention services.

[Statutory Authority: RCW 43.70.040 and 43.70.120, 95-23-018, § 246-130-001, filed 11/7/95, effective 12/8/95. Statutory Authority: RCW 43.70.040, 91-02-049 (Order 121), recodified as § 246-130-001, filed 12/27/90, effective 1/31/91. Statutory Authority: RCW 43.70.120, 90-17-087 (Order 071), § 248-168-010, filed 8/17/90, effective 9/17/90. Statutory Authority: RCW 43.20A.550, 87-22-012 (Order 2549), § 248-168-010, filed 10/26/87.]

**WAC 246-130-010 Definitions.** The following words and phrases have the following meaning in chapter 246-130 WAC unless the context clearly indicates otherwise:

"AIDS" means acquired immunodeficiency syndrome.

"APDP" means HIV/AIDS prescription drug program.

"Department" or "DOH" means the Washington state department of health.

"Early intervention services" means personal health services and behavioral risk reduction interventions codelivered with these services that reduce the rate of progression of HIV infection and reduce HIV transmission.

"HIP" means the HIV intervention program.

"HIV" means human immunodeficiency virus.

"Participation" means the amount of cost borne by the eligible client.

"Personal health services" mean clinical interventions and treatments, including but not limited to medications, that are delivered to individuals and are intended to reduce morbidity and mortality.

[Statutory Authority: RCW 43.70.040 and 43.70.120, 95-23-018, § 246-130-010, filed 11/7/95, effective 12/8/95. Statutory Authority: RCW 43.70.120, 92-02-018 (Order 224), § 246-130-010, filed 12/23/91, effective 1/23/92. Statutory Authority: RCW 43.70.040, 91-02-049 (Order 121), recodified as § 246-130-010, filed 12/27/90, effective 1/31/91. Statutory Authority: RCW 43.70.120, 90-17-087 (Order 071), § 248-168-015, filed 8/17/90, effective 9/17/90.]

**WAC 246-130-020 Early intervention services.** To the extent federal or state funds are appropriated for the purpose of providing services through HIP or APDP, the department shall contract with participating pharmacies, other health care providers, or social service providers for the delivery of early intervention services.

[Statutory Authority: RCW 43.70.040 and 43.70.120, 95-23-018, § 246-130-020, filed 11/7/95, effective 12/8/95. Statutory Authority: RCW 43.70.040, 91-02-049 (Order 121), recodified as § 246-130-020, filed 12/27/90, effective 1/31/91. Statutory Authority: RCW 43.70.120, 90-17-087 (Order 071), § 248-168-020, filed 8/17/90, effective 9/17/90. Statutory Authority: RCW 43.20A.550, 87-22-012 (Order 2549), § 248-168-020, filed 10/26/87.]

**WAC 246-130-030 Reimbursements.** The department will make reimbursement to contracted providers to provide early intervention services to eligible persons. The department shall produce a schedule of reimbursement for all services covered on a fee-for-service basis that shall be applicable to all contracted providers.

[Statutory Authority: RCW 43.70.040 and 43.70.120, 95-23-018, § 246-130-030, filed 11/7/95, effective 12/8/95. Statutory Authority: RCW 43.70.120, 92-02-018 (Order 224), § 246-130-030, filed 12/23/91, effective 1/23/92. Statutory Authority: RCW 43.70.040, 91-02-049 (Order 121), recodified as § 246-130-030, filed 12/27/90, effective 1/31/91. Statutory Authority: RCW 43.70.120, 90-17-087 (Order 071), § 248-168-030, filed 8/17/90, effective 9/17/90. Statutory Authority: RCW 43.20A.550, 87-22-012 (Order 2549), § 248-168-030, filed 10/26/87.]

**WAC 246-130-040 Financial eligibility.** The department shall provide early intervention services for persons with HIV infection, including those persons with disabling AIDS conditions, who meet financial eligibility requirements established by the department and who are not receiving similar services funded by other resources. Prior to their application, the department shall publish and seek public comment upon the process and criteria for establishing medical and financial eligibility for early intervention services. The department shall provide for public involvement in establishing and periodically reviewing these criteria, including seeking input from clients and providers of early intervention services.

The following exemptions shall not be considered in determining financial eligibility for early intervention services:

(1) A home, defined as real property owned by an eligible client as a principal place of residence, together with the property surrounding and contiguous thereto not to exceed five acres;

(2) Commercial property, or property used for the purpose of producing income, except to the extent that its value exceeds the sum of twenty thousand dollars;

(3) Household furnishings;

(4) An automobile;

(5) Savings, property, or other liquid assets, to the extent the value thereof does not exceed the sum of ten thousand dollars;

(6) Proceeds whether lump sum or annuities from a viatical settlement contract; and

(7) Accelerated benefits of a life insurance policy whether in lump sum or annuities.

[Statutory Authority: RCW 43.70.040 and 43.70.120. 95-23-018, § 246-130-040, filed 11/7/95, effective 12/8/95. Statutory Authority: RCW 43.70.120. 92-02-018 (Order 224), § 246-130-040, filed 12/23/91, effective 1/23/92. Statutory Authority: RCW 43.70.040. 91-02-049 (Order 121), recodified as § 246-130-040, filed 12/27/90, effective 1/31/91. Statutory Authority: RCW 43.70.120. 90-17-087 (Order 071), § 248-168-040, filed 8/17/90, effective 9/17/90. Statutory Authority: RCW 43.20A.550. 87-22-012 (Order 2549), § 248-168-040, filed 10/26/87.]

**WAC 246-130-060 Medical and financial information.** An individual seeking early intervention services shall provide medical and financial information upon request of the department including:

(1) Sources and amounts of resources to verify financial eligibility;

(2) Evidence that all other available resources or entitlements for which a person is eligible were accessed before a person could receive early intervention services through HIP or APDP; and

(3) Other medical or financial information as required by the department.

[Statutory Authority: RCW 43.70.040 and 43.70.120. 95-23-018, § 246-130-060, filed 11/7/95, effective 12/8/95. Statutory Authority: RCW 43.70.040. 91-02-049 (Order 121), recodified as § 246-130-060, filed 12/27/90, effective 1/31/91. Statutory Authority: RCW 43.70.120. 90-17-087 (Order 071), § 248-168-060, filed 8/17/90, effective 9/17/90. Statutory Authority: RCW 43.20A.550. 87-22-012 (Order 2549), § 248-168-060, filed 10/26/87.]

**WAC 246-130-070 Participation.** Eligible clients may be responsible for paying part of the cost of early

intervention services received according to participation standards established by the department.

[Statutory Authority: RCW 43.70.040 and 43.70.120. 95-23-018, § 246-130-070, filed 11/7/95, effective 12/8/95. Statutory Authority: RCW 43.70.040. 91-02-049 (Order 121), recodified as § 246-130-070, filed 12/27/90, effective 1/31/91. Statutory Authority: RCW 43.70.120. 90-17-087 (Order 071), § 248-168-070, filed 8/17/90, effective 9/17/90.]

## Chapter 246-170 WAC

### TUBERCULOSIS—PREVENTION, TREATMENT, AND CONTROL

#### WAC

246-170-002	Findings and purpose.
246-170-011	Definitions.
246-170-021	Responsibility of local health officers.
246-170-031	Local health department responsibilities.
246-170-035	Tuberculin skin testing and medication administration training.
246-170-041	Inpatient services requirements.
246-170-051	Procedures for involuntary testing, treatment, and detention.
246-170-055	Due process proceedings.
246-170-061	Initiation of testing or treatment.
246-170-065	Persons already detained, confined, or committed.

#### DISPOSITION OF SECTIONS FORMERLY CODIFIED IN THIS CHAPTER

246-170-001	Purpose. [Statutory Authority: RCW 70.33.020. 92-02-018 (Order 224), § 246-170-001, filed 12/23/91, effective 1/23/92. Statutory Authority: RCW 43.70.040. 91-02-049 (Order 121), recodified as § 246-170-001, filed 12/27/90, effective 1/31/91; Order 848, § 248-99-010, filed 8/23/73.] Repealed by 95-04-035, filed 1/24/95, effective 1/24/95. Statutory Authority: ESB 6158 and chapter 70.28 RCW.
246-170-010	Definitions. [Statutory Authority: RCW 70.33.020. 92-02-018 (Order 224), § 246-170-010, filed 12/23/91, effective 1/23/92. Statutory Authority: RCW 43.70.040. 91-02-049 (Order 121), recodified as § 246-170-010, filed 12/27/90, effective 1/31/91; Order 848, § 248-99-020, filed 8/23/73.] Repealed by 95-04-035, filed 1/24/95, effective 1/24/95. Statutory Authority: ESB 6158 and chapter 70.28 RCW.
246-170-020	Responsibility of local health officers. [Statutory Authority: RCW 43.70.040. 91-02-049 (Order 121), recodified as § 246-170-020, filed 12/27/90, effective 1/31/91; Order 848, § 248-99-030, filed 8/23/73.] Repealed by 95-04-035, filed 1/24/95, effective 1/24/95. Statutory Authority: ESB 6158 and chapter 70.28 RCW.
246-170-030	Local health department responsibilities. [Statutory Authority: RCW 70.33.020. 92-02-018 (Order 224), § 246-170-030, filed 12/23/91, effective 1/23/92. Statutory Authority: RCW 43.70.040. 91-02-049 (Order 121), recodified as § 246-170-030, filed 12/27/90, effective 1/31/91; Order 848, § 248-99-040, filed 8/23/73.] Repealed by 95-04-035, filed 1/24/95, effective 1/24/95. Statutory Authority: ESB 6158 and chapter 70.28 RCW.
246-170-040	Inpatient services. [Statutory Authority: RCW 43.70.040. 91-02-049 (Order 121), recodified as § 246-170-040, filed 12/27/90, effective 1/31/91; Order 848, § 248-99-050, filed 8/23/73.] Repealed by 95-04-035, filed 1/24/95, effective 1/24/95. Statutory Authority: ESB 6158 and chapter 70.28 RCW.
246-170-050	Infection control. [Statutory Authority: RCW 43.70.040. 91-02-049 (Order 121), recodified as § 246-170-050, filed 12/27/90, effective 1/31/91; Order 848, § 248-99-060, filed 8/23/73.] Repealed by 95-04-035, filed 1/24/95, effective 1/24/95. Statutory Authority: ESB 6158 and chapter 70.28 RCW.



- 246-170-060 Clinical services. [Statutory Authority: RCW 43.70.040. 91-02-049 (Order 121), recodified as § 246-170-060, filed 12/27/90, effective 1/31/91; Order 848, § 248-99-070, filed 8/23/73.] Repealed by 95-04-035, filed 1/24/95, effective 1/24/95. Statutory Authority: ESB 6158 and chapter 70.28 RCW.
- 246-170-070 Home treatment. [Statutory Authority: RCW 43.70.040. 91-02-049 (Order 121), recodified as § 246-170-070, filed 12/27/90, effective 1/31/91; Order 848, § 248-99-080, filed 8/23/73.] Repealed by 95-04-035, filed 1/24/95, effective 1/24/95. Statutory Authority: ESB 6158 and chapter 70.28 RCW.
- 246-170-080 Case monitoring. [Statutory Authority: RCW 70.33.020. 92-02-018 (Order 224), § 246-170-080, filed 12/23/91, effective 1/23/92. Statutory Authority: RCW 43.70.040. 91-02-049 (Order 121), recodified as § 246-170-080, filed 12/27/90, effective 1/31/91; Order 138, § 248-99-090, filed 2/7/77; Order 848, § 248-99-090, filed 8/23/73.] Repealed by 95-04-035, filed 1/24/95, effective 1/24/95. Statutory Authority: ESB 6158 and chapter 70.28 RCW.
- 246-170-090 Program review. [Statutory Authority: RCW 43.70.040. 91-02-049 (Order 121), recodified as § 246-170-090, filed 12/27/90, effective 1/31/91; Order 848, § 248-99-100, filed 8/23/73.] Repealed by 95-04-035, filed 1/24/95, effective 1/24/95. Statutory Authority: ESB 6158 and chapter 70.28 RCW.

**WAC 246-170-002 Findings and purpose.** (1) The board of health finds that:

(a) Pulmonary tuberculosis is a life-threatening airborne disease that can be casually transmitted without significant interaction with an infectious person. Tuberculosis has reemerged as an epidemic disease nationally, and though Washington state is not in an epidemic yet, the increasing number of cases in Washington state each year clearly demonstrate that absent timely and effective public health intervention in individual cases, the residents of the state of Washington are at risk of being infected by tuberculosis.

(b) In order to limit the spread of tuberculosis, it is essential that individuals who have the disease are diagnosed and treated before they infect others. Diagnosis requires a variety of methodologies including skin tests, x-rays, and laboratory analysis of sputum samples.

(c) A person with infectious tuberculosis who does not voluntarily submit to appropriate testing, treatment, or infection control methods poses an unreasonable risk of spreading the disease to those who come into the infectious person's proximity.

(d) Although the recommended course of treatment for tuberculosis varies somewhat from one individual to another, at a minimum, effective treatment requires a long-term regimen of multiple drug therapy. Some drugs are effective with some individuals but not others. The development of the appropriate course of treatment for any one individual may require trying different combinations of drugs and repeated drug susceptibility testing. The course of treatment may require as long as several years to complete.

(e) A person who begins a course of treatment for tuberculosis and fails to follow the recommended course through to completion is highly likely to relapse at some point into infectious tuberculosis. The person will most likely then be infected with what is known as multiple drug resistant tuberculosis, which is more virulent, more difficult to treat, and more likely to result in fatality. A person who is infectious with multiple drug resistant tuberculosis poses a significant risk of transmitting multiple drug resistant

tuberculosis to other persons, unless appropriate treatment and infection control methods are followed.

(f) Multiple drug resistant tuberculosis is a significant element in the epidemic that is being encountered nationwide, and effective public health interventions are necessary to prevent that epidemic from developing in or spreading to Washington state.

(2) The following rules are adopted for the purpose of establishing standards necessary to protect the public health by:

(a) Assuring the diagnosis, treatment, and prevention of tuberculosis; and

(b) Assuring that the highest priority is given to providing appropriate individualized preventive and curative treatment in the least restrictive setting.

[Statutory Authority: ESB 6158 and chapter 70.28 RCW. 95-04-035, § 246-170-002, filed 1/24/95, effective 1/24/95.]

**WAC 246-170-011 Definitions.** Unless the context clearly requires otherwise, the definitions in this section apply throughout this chapter.

"Case management" means a comprehensive, ongoing identification of needs, including the need for any medical, social, educational, or other support services; the development and implementation of a detailed plan of services and related activities; use of community linkages; and advocacy for the client performed in a prescribed, accountable manner.

"Confirmed" or "confirmed case" means an individual who has a positive bacteriologic culture for *Mycobacterium tuberculosis* complex or a suspected case that shows response to an appropriate course of treatment.

"Department" means the department of health.

"Detention" or "detain" means the act of restricting an individual's movement by confining the person.

"Directly observed therapy (DOT)" and "directly observed preventive therapy (DOPT)" mean providing oral medications to patients and observing ingestion of medications by patients.

"Infected" means an individual who has tubercle bacilli as identified by a positive tuberculin skin test, but is not capable of transmitting the organism to another person.

"Infectious" means the stage of disease in which an individual transmits viable tuberculosis organisms into the air.

"Inpatient" means health care furnished to an individual who has been admitted to a hospital.

"Outpatient" means health care furnished to an individual who is not an inpatient.

"Personal protective equipment" means respirators and other equipment as required by the department of labor and industries.

"Prevention" means the interventions that interrupt the spread of tuberculosis, either within an individual, within the population, or both.

"Preventive therapy" means either treatment to prevent infection in an uninfected person or treatment to prevent disease in an infected person.

"Primary health care provider" means the person who assumes the day-to-day medical care of a tuberculosis patient.

"Suspected case" means an individual with signs or symptoms suggestive of tuberculosis disease prior to confirmation.

"Treatment" means a course of long-term multiple drug or other appropriate therapy prescribed for an individual with suspected or confirmed disease in accordance with accepted medical practice and current applicable national and state guidelines, and may include preventive therapy.

"Tuberculin skin test" means the introduction of purified protein derivative (PPD) by the Mantoux method.

"Tuberculosis community health worker" means an unlicensed person trained to perform tuberculin skin testing, directly observed therapy, and directly observed preventive therapy and working pursuant to chapter 70.28 RCW as part of a program established by a state or local health officer to control tuberculosis.

[Statutory Authority: ESB 6158 and chapter 70.28 RCW. 95-04-035, § 246-170-011, filed 1/24/95, effective 1/24/95.]

**WAC 246-170-021 Responsibility of local health officers.** Each county, city-county and district health officer is responsible for the control of tuberculosis within a jurisdiction. Each health officer shall act as or shall designate a physician to act as tuberculosis control officer. This individual shall coordinate all aspects of the prevention, treatment, and control program.

[Statutory Authority: ESB 6158 and chapter 70.28 RCW. 95-04-035, § 246-170-021, filed 1/24/95, effective 1/24/95.]

**WAC 246-170-031 Local health department responsibilities.** (1) Each local health department shall assure the provision of a comprehensive program for the prevention, treatment, and control of tuberculosis. Services shall include:

(a) Prevention and screening, with emphasis on screening of high risk populations;

(b) Diagnosis and monitoring, including laboratory and radiology;

(c) Individualized treatment planning consistent with American Thoracic Society/Centers for Disease Control and Prevention statements based on the least restrictive measures necessary to assure appropriate treatment; and

(d) Case management.

(2) In the absence of third party reimbursement, the local health department shall assure the provision of inpatient or outpatient care, including DOT/DOPT and case management.

(3) Each local health department shall maintain a register of all diagnosed or suspected cases of tuberculosis. In addition, each local health department shall also maintain a register of individuals to whom that health department is providing preventive therapy. Quarterly status reports on suspected and diagnosed cases shall be furnished to the department of health tuberculosis control program.

(4) A physician knowledgeable in the diagnosis and treatment of tuberculosis approved by the department shall be available to provide review of diagnoses, plans of management and, if appropriate, discharge from inpatient facilities.

(5) Sufficient nursing, clerical, and other appropriate personnel shall be provided to furnish supervision of

preventive and outpatient treatment, surveillance, suspect evaluation, epidemiologic investigation, and contact workup.

[Statutory Authority: ESB 6158 and chapter 70.28 RCW. 95-04-035, § 246-170-031, filed 1/24/95, effective 1/24/95.]

**WAC 246-170-035 Tuberculin skin testing and medication administration training.** The department shall make available a course to be used by the state tuberculosis control program or local health departments to train tuberculosis community health workers.

This course shall include, but not be limited to:

(1) Tuberculosis infection and disease, including prevention, transmission, pathogenesis, diagnosis and treatment;

(2) The administration, reading, and interpretation of the Mantoux tuberculin skin test;

(3) The performance of oral directly observed therapy and directly observed preventive therapy;

(4) Adverse reactions to tuberculosis medications and how to monitor patients for adverse reactions;

(5) Appropriate referral mechanisms for positive skin tests, adverse reactions, or other medical needs;

(6) Personal health and safety requirements including the use of personal protective equipment.

[Statutory Authority: ESB 6158 and chapter 70.28 RCW. 94-20-080, § 246-170-035, filed 10/4/94, effective 11/4/94.]

**WAC 246-170-041 Inpatient services requirements.**

(1) Inpatient services to infectious or suspected cases shall be provided in hospitals or hospital units of correctional facilities. These facilities shall meet infection control program requirements pursuant to WAC 246-318-035, and shall provide:

(a) A single-patient room consistent with the guidelines set forth in the *1994 CDC Guidelines For Preventing the Transmission of Tuberculosis in Health Care Facilities*, or as hereafter amended. Copies of these guidelines are available from the Washington state department of health, TB control program;

(b) Medical, nursing, laboratory, radiology, pharmacy, patient education, and social services;

(c) Discharge conferences involving at least the current primary provider, a local health department representative, and transferring and receiving facility representatives.

(2) Suspected and infectious cases may be housed and treated in other settings not meeting the requirements of this section only as approved by the local health officer.

[Statutory Authority: ESB 6158 and chapter 70.28 RCW. 95-04-035, § 246-170-041, filed 1/24/95, effective 1/24/95.]

**WAC 246-170-051 Procedures for involuntary testing, treatment, and detention.** (1) A local health officer shall make reasonable efforts to obtain voluntary compliance with requests for examination, testing, and treatment prior to initiating the procedures for involuntary detention.

(2) If the local health officer has reason to believe that:

(a) A person is a suspected case, and that the person has failed to comply with a documented request from a health care practitioner or the local health officer to submit to examination and testing;

(b) A person with confirmed tuberculosis is failing to comply with an individual treatment plan approved by the local health officer;

(c) A person who is either a suspected or confirmed case and is failing to comply with infection control directives issued by the local health officer; or

(d) A person is a suspected or confirmed case of tuberculosis based upon generally accepted standards of medical and public health science. A local health officer shall investigate and evaluate the factual basis supporting his or her "reason to believe";

then the health officer may detain the person, cause the person to be detained by written order, or petition the superior court *ex parte* for an order to take the person into emergency detention for testing or treatment, or both. The period of detention shall not exceed seventy-two hours, excluding weekends and holidays.

(3) At the time of detention the person detained shall be given the following written notice:

NOTICE: You have the right to a superior court hearing within seventy-two hours of detention, excluding holidays and weekends. You have the right to legal counsel. If you are unable to afford legal counsel, then counsel will be appointed for you at government expense and you should request the appointment of counsel at this time. If you currently have legal counsel, then you have an opportunity to contact that counsel for assistance.

You have a right to contest the facts alleged against you, to cross-examine witnesses, and to present evidence and witnesses on your behalf.

You have a right to appeal any decision made by the court.

You may be given appropriate TB medications only on your informed consent, or pursuant to a court order.

(4) If a person is involuntarily detained under this section, within one judicial day of initial detention, the local health officer shall file with the superior court in the county of detention a petition for detention. A petition filed under this section shall specify:

(a) The basis for the local health officer's belief that the respondent is either a suspected or confirmed case; including the name, address and phone numbers of whom the health officer expects to testify in support of the petition for detention and identification of any and all medical tests and records relied upon by the local health officer;

(b) The specific actions taken by the local health officer to obtain voluntary compliance by the respondent with recommended examination and testing or treatment, as the case may be;

(c) The nature and duration of further detention or other court-ordered action that the local health officer believes is necessary in order to assure that the respondent is appropriately tested or treated;

(d) The basis for believing that further detention or other court-ordered action is necessary to protect the public health; and

(e) Other information the local health officer believes is pertinent to the proper resolution of the petition.

(5) Service on respondent. The health officer shall serve a copy of the petition on the individual named therein at the time of the detention. If the person informs the health officer that he or she is represented by legal counsel, service

on such counsel shall be made by delivering a copy of the petition to the attorney's office no later than the time of filing the petition with the superior court.

[Statutory Authority: ESB 6158 and chapter 70.28 RCW. 95-04-035, § 246-170-051, filed 1/24/95, effective 1/24/95.]

**WAC 246-170-055 Due process proceedings.** (1) A hearing on the petition for detention filed under WAC 246-170-051 shall be conducted in superior court within seventy-two hours after initial detention, excluding weekends and holidays. The local health officer shall have the burden of proving the allegations set forth in the petition by a preponderance of the evidence. The person named in the petition shall have the right to cross-examine witnesses, present evidence, and be represented by an attorney at any hearing held on the petition. If the person is indigent and requests appointment of legal counsel, legal counsel shall be appointed at public expense at least twenty-four hours prior to the superior court hearing.

(2) At the conclusion of the hearing, the court shall consider the evidence, the action taken by the health officer to secure voluntary compliance by the patient, and the purpose and intent of the public health laws, including this chapter, and may take one of the following actions:

(a) If the court finds that the respondent is a suspected case, the court may enter an order requiring that the person be subjected to further examination, testing, and treatment as specified in the court's order. If the court finds that further detention of the respondent is necessary in order to assure that the examination, testing, and treatment occurs, or to protect the public health the court may order that the respondent be detained for an additional period not to exceed forty-five days. The results of testing conducted under this chapter shall be provided to the court and the person detained or his or her legal counsel as soon as they are available to the local health officer. The court may then conduct an additional hearing to determine whether the person is a confirmed case and, if so, whether further measures are necessary to protect the public health pursuant to (b) or (c) of this subsection.

(b) If the court finds that the person is a confirmed case, that further measures less restrictive than detention of the respondent are necessary to assure that appropriate treatment is implemented and that imposition of less restrictive measures will be sufficient to protect the public health, the court may enter an order setting forth such measures and ordering the respondent to comply with the measures.

(c) If the court finds that the person is a confirmed case, that further detention of the respondent is necessary to protect the public health, and that imposition of less restrictive measures will not be sufficient to protect the public health, the court may order that the respondent be detained and treated for an additional period not to exceed forty-five days.

(d) If the court finds that there is insufficient evidence to support the petition for detention, then the court shall immediately release the person detained.

(3) A person detained under this chapter may be released prior to the expiration of the court-ordered detention if the health officer or the court finds that less restrictive measures are sufficient to protect the public health. The

court may impose such conditions on the release of the person as the court finds are necessary to protect the public health. A person detained under this chapter may also petition the court for release based upon new evidence or a change in circumstances.

(4) The court may extend a period of court-ordered detention for additional periods not to exceed one hundred eighty days each following a hearing as described in WAC 246-170-051 and this section, if the court finds that the requirements of subsection (2)(a), (b), or (c) of this section have been met and if the court finds that further detention is necessary to assure that appropriate treatment is implemented, and that imposition of less restrictive measures are not sufficient to protect the public health. As an alternative to extending the period of detention, if the court finds after hearing that further measures less restrictive than detention are necessary to assure that appropriate treatment is continued, and that imposition of less restrictive measures will be sufficient to protect the public health, the court may enter an order setting forth the measures and ordering the respondent to comply.

(5) In the event that a person has been released from detention prior to completion of the prescribed course of treatment and fails to comply with the prescribed course of treatment, the health officer where that individual is found may detain that person, and any court having jurisdiction of the person may order the person detained for an additional period or periods, not to exceed one hundred eighty days each, as the court finds necessary to protect the public health.

(6) If a person has been detained in a county other than the county in which the court that originally ordered the detention is located, venue of the proceedings may remain in the original county, or may be transferred to the county of detention. Change in venue may be sought either by the local health officer in the original county or in the county of detention, or by the person detained. Except as otherwise agreed between the original health officer and the health officer in the county of detention, the original health officer retains jurisdiction over the detained person, including financial responsibility for costs incurred in implementing and continuing the detention.

(7) Court orders entered under this chapter shall be entered only after a hearing at which the respondent is accorded the same rights as at the initial hearing on the petition for detention.

(8)(a) When a court order for detention is issued, the transporting law enforcement agency and the receiving facility shall be informed of the infectious TB status of the person for disease control and the protection of the health of the staff, other offenders and the public. Such information shall be made available prior to the transport.

(b) Whenever disclosure is made pursuant to this subsection, it shall be accompanied by a statement in writing which includes the following or substantially similar language: "This information has been disclosed to you from records whose confidentiality is protected by state law. State law prohibits you from making any further disclosure of it except as authorized by state law."

(c) Transporting agencies and/or receiving facilities shall establish and implement policies and procedures that maintain confidentiality related to the detained person's

medical information as defined in this subsection and state law.

[Statutory Authority: ESB 6158 and chapter 70.28 RCW. 95-04-035, § 246-170-055, filed 1/24/95, effective 1/24/95.]

#### **WAC 246-170-061 Initiation of testing or treatment.**

If a person has been detained under WAC 246-170-051 or 246-170-055, the health officer may begin testing or treatment, with informed consent, or pursuant to a court order as appropriate, pending the hearing required under WAC 246-170-055.

[Statutory Authority: ESB 6158 and chapter 70.28 RCW. 95-04-035, § 246-170-061, filed 1/24/95, effective 1/24/95.]

#### **WAC 246-170-065 Persons already detained, confined, or committed.**

(1) The provisions of WAC 246-170-051 through 246-170-061 do not apply to persons who have been lawfully detained, confined, or committed to the custody of a penal institution, a mental health facility, or another public or private institution. The person in charge of such facility or his or her designee shall report to the local health officer the names of persons in custody who are either a suspected or confirmed case. The report shall include information indicating the date upon which the person is to be released from the facility, if known, and if no specific release date has been determined, the earliest date upon which release is likely to occur. A person in custody may be ordered to undergo examination and testing or treatment, as appropriate, by the person in charge of the facility or designee, subject to such constitutional or other requirements as may be applicable.

(2) The person in charge of a custodial facility shall notify the local health officer and the department of the release of a person who is at the time of release reasonably believed to be either a suspected or confirmed case. The notice shall be given to the local health officer where the facility is located and to the local health officer having jurisdiction over the place to which the person is being released, if known. The notice shall be given as early as is practical, but in no event later than the time of the actual release.

[Statutory Authority: ESB 6158 and chapter 70.28 RCW. 95-04-035, § 246-170-065, filed 1/24/95, effective 1/24/95.]

### **Chapter 246-171 WAC**

#### **TUBERCULOSIS—FINANCIAL RESPONSIBILITY**

##### **WAC**

246-171-010	Definitions.
246-171-020	Statement of financial resources.
246-171-030	Statement of financial resources—Cooperation in obtaining information.
246-171-040	Statement of financial resources—Emergencies.
246-171-050	Financial ability—Determination.
246-171-060	Financial ability—Forms.
246-171-070	Financial ability—Review of financial ability.
246-171-080	Financial ability—Standards generally.
246-171-090	Financial ability—Inability to pay.
246-171-100	Financial ability—Specific minimum standards.
246-171-110	Payment by patient.
246-171-120	Liability of estate.
246-171-130	Statement of costs.
246-171-140	Payment by county.

**WAC 246-171-010 Definitions.** (1) "Tuberculosis facility" shall mean any hospital, sanatorium or other facility maintained by a county for the in-patient care of persons suffering from infection or suspected infection with *Mycobacterium tuberculosis*.

(2) "Local health department" shall mean the health department which provides public health services for tuberculosis control to persons within the jurisdictional area.

(3) "Local health officer" shall mean the legally qualified physician who has been appointed as the health officer for the city, town, county or district health department or his appointed tuberculosis control officer.

(4) "Department" shall mean the Washington state department of health.

(5) "Medical director" shall mean the director of the tuberculosis facility.

(6) "Responsible person" shall mean those responsible for the support of a patient in the following order:

(a) The spouse of the patient.

(b) The parents of a minor patient.

(c) The children of the patient where they have assumed the responsibility for the support of the patient.

(d) The guardian or legal representative of the patient.

(7) "Cost of care" of a hospitalized tuberculosis patient is all reasonable cost of services as computed by procedures and methods for determining reasonable cost necessary under provisions of the Health Insurance for the Aged Act of 1965 as amended.

(8) "Current income" shall be that monthly cash which the patient or his family earns during the time of hospitalization through wages, profits from business, dividends, interest, sick pay and benefits derived from health and accident insurance collectible as a result of illness and confinement in the tuberculosis facility. Funds derived from the liquidation of capital assets or withdrawal from savings may be used to supplement current income to the extent that such assets and savings exceed the exempt amount as specified in these regulations.

(9) "Admission" shall mean the entry of a patient into a tuberculosis facility and the completion of all necessary admission records to include financial data.

[Statutory Authority: RCW 43.70.040. 91-02-049 (Order 121), recodified as § 246-171-010, filed 12/27/90, effective 1/31/91; Order 31, § 248-118-010, filed 8/18/69.]

**WAC 246-171-020 Statement of financial resources.** Prior to admission as a patient to a tuberculosis facility, every patient, or the person responsible under the laws of the state of Washington for his support, shall provide the local health officer of the county of his residence a statement of his financial resources, holdings and obligations upon forms provided by the department. Said forms shall be in duplicate, one copy to be furnished to the tuberculosis facility, and one copy to be furnished to the local health officer: *Provided*, That no individual need provide any health official or tuberculosis facility a statement of his financial resources, holdings or obligations if he agrees to pay, and subsequently does pay that portion of the cost of hospitalization remaining after deducting all costs legitimately due from medical or hospital or health insurance, medicare, or other similar legitimate applicable prepaid health care or insurance type

resources: *Provided further*, That such individual is free to leave said tuberculosis facility at any time at his own discretion, with or without a medical discharge, but in no such instance will the hospital or sanatorium, nor physician nor nurse, be liable for any damages accruing from his ill health due to tuberculosis or complications thereof: *Provided further*, That an individual whose sputum, gastric contents or other bodily discharges are demonstrated to contain pathogenic *Mycobacterium* organisms, and who because of this is quarantined to protect others from the disease, shall not be liable for the cost of such hospitalization beyond that received from medical or health or hospital insurance, medicare or similar legitimate, applicable prepaid health care or insurance resources.

[Statutory Authority: RCW 43.70.040. 91-02-049 (Order 121), recodified as § 246-171-020, filed 12/27/90, effective 1/31/91; Order 31, § 248-118-020, filed 8/18/69.]

**WAC 246-171-030 Statement of financial resources—Cooperation in obtaining information.** Local health officers may have the assistance of the director of the tuberculosis facility, when necessary, in obtaining a statement of the patient's financial resources, holdings and obligations.

[Statutory Authority: RCW 43.70.040. 91-02-049 (Order 121), recodified as § 246-171-030, filed 12/27/90, effective 1/31/91; Order 31, § 248-118-021, filed 8/18/69.]

**WAC 246-171-040 Statement of financial resources—Emergencies.** If a patient must be admitted to the tuberculosis facility at night or on a holiday or weekend or as an emergency the statement shall be obtained as soon as practicable following admission.

[Statutory Authority: RCW 43.70.040. 91-02-049 (Order 121), recodified as § 246-171-040, filed 12/27/90, effective 1/31/91; Order 31, § 248-118-022, filed 8/18/69.]

**WAC 246-171-050 Financial ability—Determination.** Upon the filing of a financial statement as provided for under WAC 246-171-020 through 246-171-040, it shall be the duty of the local health officer to determine the financial ability of such patient, or the person responsible therefor, to contribute in whole or in part to the cost of care in such facility.

[Statutory Authority: RCW 70.33.020 and 70.30.072. 92-02-018 (Order 224), § 246-171-050, filed 12/23/91, effective 1/23/92. Statutory Authority: RCW 43.70.040. 91-02-049 (Order 121), recodified as § 246-171-050, filed 12/27/90, effective 1/31/91; Order 31, § 248-118-030, filed 8/18/69.]

**WAC 246-171-060 Financial ability—Forms.** In determining the financial responsibility of a patient, or the responsible person, it shall be the duty of the local health officer to complete the forms provided by the department. Said forms shall be made in triplicate, one copy to be furnished to the tuberculosis facility, one copy to be furnished to the department, and one to be retained by the local health officer.

[Statutory Authority: RCW 43.70.040. 91-02-049 (Order 121), recodified as § 246-171-060, filed 12/27/90, effective 1/31/91; Order 31, § 248-118-040, filed 8/18/69.]

**WAC 246-171-070 Financial ability—Review of financial ability.** The determination of financial ability to pay shall be reviewed at the patient's request or in the event that information of a substantial change in the patient's or responsible person's ability to pay should come to the attention of the health officer.

[Statutory Authority: RCW 43.70.040. 91-02-049 (Order 121), recodified as § 246-171-070, filed 12/27/90, effective 1/31/91; Order 31, § 248-118-050, filed 8/18/69.]

**WAC 246-171-080 Financial ability—Standards generally.** The patient or responsible person shall be charged that portion of the cost of care which he can pay from any and all sources of current income and capital available to him which is deemed to be in excess of his requirements to maintain the family standard of living at a level equal to that which existed prior to the patient's entry into the tuberculosis facility. In all cases, health insurance benefits accruing to the patient as a result of his hospitalization for tuberculosis shall be considered to be income in excess of that needed to maintain the family standard of living.

[Statutory Authority: RCW 43.70.040. 91-02-049 (Order 121), recodified as § 246-171-080, filed 12/27/90, effective 1/31/91; Order 31, § 248-118-060, filed 8/18/69.]

**WAC 246-171-090 Financial ability—Inability to pay.** If a patient or the responsible person is, in whole or in part, provided support by the Washington state department of public assistance, he shall be considered unable to pay any part of the cost of care.

[Statutory Authority: RCW 43.70.040. 91-02-049 (Order 121), recodified as § 246-171-090, filed 12/27/90, effective 1/31/91; Order 31, § 248-118-061, filed 8/18/69.]

**WAC 246-171-100 Financial ability—Specific minimum standards.** A patient, or the person responsible therefor, shall not be required to contribute to the cost of his hospital care to the extent that such contribution would require any of the following steps:

- (1) Lowering of normal living expenditures from their level prior to hospitalization.
- (2) Endangering the title to a home, furnishings, or automobile.
- (3) Employment of any dependent not employed prior to the beginning of the patient's hospitalization.
- (4) Depletion of hospitalization insurance benefits available to dependents.
- (5) Depletion of real property holdings; or depletion of cash savings or securities below the value at which such assets would yield, at five percent per annum, a prescribed percentage of the current total annual living expense. The total annual living expense shall be figured at twelve times the monthly total family needs as determined on the forms provided by the department. The percentage shall be prescribed as follows: One hundred percent if either the patient or the responsible person is sixty years of age or older; sixty percent if the patient or responsible person is at least fifty but not more than fifty-nine years; thirty percent if he is at least forty but not more than forty-nine years; and ten percent if he is less than forty years of age.

(6) Reducing the patient's assets below the amount that would be allowed as an award in lieu of homestead pursuant to RCW 11.52.010.

(7) Shortening of hospital stay to less than that necessary for adequate treatment.

[Statutory Authority: RCW 43.70.040. 91-02-049 (Order 121), recodified as § 246-171-100, filed 12/27/90, effective 1/31/91; Order 31, § 248-118-070, filed 8/18/69.]

**WAC 246-171-110 Payment by patient.** The patient, or the responsible person shall, upon a determination by the local health officer that he is capable of contributing to the cost of his hospitalization, pay to the sanatorium the amount determined by the local health officer who shall be informed of the payment on a monthly basis.

[Statutory Authority: RCW 43.70.040. 91-02-049 (Order 121), recodified as § 246-171-110, filed 12/27/90, effective 1/31/91; Order 31, § 248-118-080, filed 8/18/69.]

**WAC 246-171-120 Liability of estate.** The unpaid portion of any patient's share of charges for hospitalization shall be a liability of the estate which, while there is a surviving spouse, shall be considered as capital assets of the responsible person and subject to depletion according to WAC 246-171-100(5).

[Statutory Authority: RCW 70.33.020 and 70.30.072. 92-02-018 (Order 224), § 246-171-120, filed 12/23/91, effective 1/23/92. Statutory Authority: RCW 43.70.040. 91-02-049 (Order 121), recodified as § 246-171-120, filed 12/27/90, effective 1/31/91; Order 31, § 248-118-090, filed 8/18/69.]

**WAC 246-171-130 Statement of costs.** A statement of the cost of care shall be prepared by the director of the tuberculosis facility monthly and at the time of discharge. Each statement shall show the amount charged to the patient, or responsible person, to a responsible insurance carrier or fiscal intermediary and to the county in which the patient resided prior to his hospitalization.

[Statutory Authority: RCW 43.70.040. 91-02-049 (Order 121), recodified as § 246-171-130, filed 12/27/90, effective 1/31/91; Order 31, § 248-118-100, filed 8/18/69.]

**WAC 246-171-140 Payment by county.** The local health officer shall be responsible for payment of tuberculosis hospital expenses from county funds monthly in amounts sufficient to pay that portion of the cost of care which has not been paid by the patient or responsible person, his medical insurance carrier or fiscal intermediary. Payments received from the patient, responsible person or insurance carrier after costs have been paid from county funds shall be credited to the county's account.

[Statutory Authority: RCW 43.70.040. 91-02-049 (Order 121), recodified as § 246-171-140, filed 12/27/90, effective 1/31/91; Order 31, § 248-118-110, filed 8/18/69.]

## Chapter 246-203 WAC GENERAL SANITATION

### WAC

246-203-010  
246-203-020  
246-203-030

Definition—Public or common nuisance.  
Spitting.  
Common towel.



246-203-060	Water sold to the public for drinking purposes in bottles or other containers.
246-203-070	Ice sold for public use.
246-203-080	Pollution of ground water prohibited.
246-203-090	Stream pollution.
246-203-100	Disposal of human excreta.
246-203-110	Kitchen and laundry water.
246-203-120	Disposal of garbage, trash, rubbish, offal, dead animals, and manure.
246-203-130	Keeping of animals.
246-203-140	Stagnant water.
246-203-150	Highway sanitation.
246-203-160	Sanitation of public buildings.
246-203-170	Objectionable establishments and industrial wastes.
246-203-180	Piggeries.
246-203-200	Disease producing organisms for rodent extermination forbidden.
246-203-210	Common drinking cups.

**WAC 246-203-010 Definition—Public or common nuisance.** For the purpose of these regulations, a public or common nuisance shall be considered as that which is set up, maintained or continued so as to be injurious to the health, or an obstruction to the use of property by interfering with the repose, health, safety or life of any considerable number of persons.

[Statutory Authority: RCW 43.20.050. 91-02-051 (Order 124B), recodified as § 246-203-010, filed 12/27/90, effective 1/31/91; Regulation .50.010, effective 3/11/60.]

**WAC 246-203-020 Spitting.** Spitting upon the floors or walls of a public building or buildings used for public assemblage, of a building used for manufacturing or industrial purposes, or upon the floors or platforms or any part of any railroad or trolley car or ferry boat, or any other public conveyance, is prohibited.

[Statutory Authority: RCW 43.20.050. 91-02-051 (Order 124B), recodified as § 246-203-020, filed 12/27/90, effective 1/31/91; Regulation .50.020, effective 3/11/60.]

**WAC 246-203-030 Common towel.** No person, firm, corporation or authorities owning, in charge of, or in control of any lavatory or wash room in any hotel, theatre, lodging house, restaurant, factory, school, church, store, office building, railway or trolley station, or public conveyance by land, water or air, or other institution or conveyance frequented by the public, or which may be used for the purpose of public assembly or as a place of employment, shall provide in or about such lavatory or washroom any towel for common use.

The term "common use" in this section shall be construed to mean, the use of all or any portion of a towel by more than one person without adequate cleansing.

[Statutory Authority: RCW 43.20.050. 91-02-051 (Order 124B), recodified as § 246-203-030, filed 12/27/90, effective 1/31/91; Regulation .50.030, effective 3/11/60.]

**WAC 246-203-060 Water sold to the public for drinking purposes in bottles or other containers.** (1) **Quality.** No water shall be sold, offered for sale or rendered available for drinking purposes in bottles or other containers unless such water is of a sanitary quality approved by the secretary of the department of health.

(2) **Inspection.** All plants for the preparation of water for sale in bottles or other containers for drinking purposes and the sources of the water supply shall be inspected as frequently as necessary by a representative of the department of health, and samples of water collected for sanitary analyses at the department of health laboratories.

(3) **Sterilizing containers.** Bottles or other containers in which water is sold for drinking purposes shall be sterilized before refilling. The method of sterilization shall be approved by the secretary of the department of health.

(4) **Water purification.** Processes of purification of waters that are to be sold for drinking purposes shall be approved by the secretary of the department of health before the water can be sold or offered for sale.

[Statutory Authority: RCW 43.20.050. 92-02-019 (Order 225B), § 246-203-060, filed 12/23/91, effective 1/23/92; 91-02-051 (Order 124B), recodified as § 246-203-060, filed 12/27/90, effective 1/31/91; Regulation .50.060, effective 3/11/60.]

**WAC 246-203-070 Ice sold for public use.** (1) **Quality.** No ice shall be sold, offered for sale or rendered available for use to the public unless such ice is of a sanitary quality approved by the secretary of the department of health.

(2) **Information.** Any company, corporation, city or individual selling artificial ice for public consumption shall submit to the department of health complete information concerning the source of water supply used for the manufacture of the ice and a detailed description of the manufacturing processes involved.

Any company, corporation, city or individual harvesting natural ice shall file full information with the department of health with regard to the source of the ice and method of storage.

[Statutory Authority: RCW 43.20.050. 92-02-019 (Order 225B), § 246-203-070, filed 12/23/91, effective 1/23/92; 91-02-051 (Order 124B), recodified as § 246-203-070, filed 12/27/90, effective 1/31/91; Regulation .50.070, effective 3/11/60.]

**WAC 246-203-080 Pollution of ground water prohibited.** (1) No privy contents, drainage from a building, or the effluent from any sewage treatment device shall be discharged directly into any well, either abandoned or constructed for that purpose, that is carried to such a depth as to penetrate the water-bearing strata.

(2) No privy contents, drainage from a building, or the effluent from any sewage treatment device shall be discharged into any crevice, sink-hole, or other opening, either natural or artificial, in a rock formation which will or may permit the pollution or contamination of ground water, except with the approval of the secretary of the department of health.

[Statutory Authority: RCW 43.20.050. 92-02-019 (Order 225B), § 246-203-080, filed 12/23/91, effective 1/23/92; 91-02-051 (Order 124B), recodified as § 246-203-080, filed 12/27/90, effective 1/31/91; Regulation .50.080, effective 3/11/60.]

**WAC 246-203-090 Stream pollution.** If, after investigation by the state department of health of any stream, lake, or other body of water within the state or forming the boundaries thereof, it is found that the entrance of sewage or industrial wastes are contributing sufficient pollution to

endanger the public health and welfare, and the correction thereof is both possible and practicable, the secretary of the department of health will issue and enforce such special orders as may be necessary for the protection of the public health and welfare.

[Statutory Authority: RCW 43.20.050, 92-02-019 (Order 225B), § 246-203-090, filed 12/23/91, effective 1/23/92; 91-02-051 (Order 124B), recodified as § 246-203-090, filed 12/27/90, effective 1/31/91; Regulation .50.090, effective 3/11/60.]

**WAC 246-203-100 Disposal of human excreta.** (1) **Waters of the state defined.** For the purpose of this regulation, the term "waters of the state" wherever used, shall include all streams and springs, and all bodies of surface and of ground water, whether natural or artificial, within the boundaries of the state.

(2) **Privies shall be fly-proof.** No privy, cesspool, septic tank, or other receptacle for human excrement shall be constructed, maintained or used so that flies have or may have access to the excrementitious matter contained therein.

(3) **Privies shall not drain in any waters of the state.** No privy, urinal, cesspool, septic tank or other receptacle for human excrement shall be constructed, maintained or used which directly or indirectly drains or discharges over or upon the surface of the ground, or into any waters of the state either directly or indirectly; unless the contents of such urinal, cesspool, septic tank or receptacle for human excrement are subjected to some recognized sterilization treatment approved by the department of health.

(4) **Privies shall be kept clean.** All privies, urinals, cesspools, septic tanks or other receptacles for human excrement shall be cleansed at sufficiently frequent intervals to prevent the contents from overflowing.

(5) **Treating excreta on watersheds of public water supplies.** All schools, hamlets, villages, towns or industrial settlements which are now located or may be hereafter located on the watershed of any public water supply, not provided with a sewerage system, shall provide and maintain a reasonable system approved by the state director of health for collecting and disposing of all accumulations of human excrement within their respective jurisdiction or control.

(6) **Connection with sewer.** No privy, cesspool, septic tank or similar receptacle for human excrement shall be constructed, maintained or used on premises where a sewer is at all accessible which is part of a sewerage system from which sewage is lawfully discharged into the waters of the state.

(7) **Use of human excreta for fertilizer prohibited.** The contents of privies, cesspools, septic tanks or other receptacles for human excrement shall not be placed upon the surface of the ground or be used for fertilizing purposes for crops or gardens.

(8) **No privy near foodstuffs.** No privy, urinal, toilet or other receptacle for human excrement shall be constructed, maintained or used in any room, or have direct connection with any room wherein any kind of exposed foods or foodstuffs are prepared, stored or handled.

[Statutory Authority: RCW 43.20.050, 92-02-019 (Order 225B), § 246-203-100, filed 12/23/91, effective 1/23/92; 91-02-051 (Order 124B), recodified as § 246-203-100, filed 12/27/90, effective 1/31/91; Regulation .50.100, effective 3/11/60.]

**WAC 246-203-110 Kitchen and laundry water.** No kitchen or laundry water shall be discharged or be permitted to discharge or flow into any gutter, street, roadway or public place.

[Statutory Authority: RCW 43.20.050, 91-02-051 (Order 124B), recodified as § 246-203-110, filed 12/27/90, effective 1/31/91; Regulation .50.110, effective 3/11/60.]

**WAC 246-203-120 Disposal of garbage, trash, rubbish, offal, dead animals, and manure.** (1) **Definitions.** For the purpose of these regulations the following definitions shall apply:

"Garbage" shall mean all solid and semisolid kitchen refuse subject to decay or putrefaction and all market waste of animal and vegetable matter which was intended to be used as food.

"Trash and rubbish" shall mean all waste material not of putrescible nature, which for the purpose of this regulation shall include ashes.

"Offal" shall mean waste animal matter from butcher, slaughter, or packing houses.

"Dead animals" shall mean all animals large and small which may die or which may be killed for other than food purposes.

"Manure" shall mean cleanings from all barns, stables, corrals, pens, or cars used for stabling or penning of animals or fowl.

(2) **Methods of disposal.** Garbage, offal and manure; or rubbish, trash, and ashes mixed with garbage, offal or manure shall be disposed of by incineration, burial, sanitary fill or other method approved, and within a time limit set by the health officer. Such material shall not be disposed of by being deposited in any ditch, gulch, ravine, river, stream, lake, pond, nor upon the surface of the ground, on any highway rights of way, where it may become a nuisance or menace to health through the breeding of flies, harboring of rodents, or pollution of water.

(3) **Dead animals.** The carcass of any dead animal shall be removed and disposed of by burial, incineration or other proper method within twenty-four hours after death. If the carcass is buried it shall be placed so that every part shall be covered by at least two feet of earth and at a location not less than 100 feet from any well, spring, stream or other surface waters, and in a place not subject to overflow. In all cases of death from communicable disease, the carcass, if disposed of by burial, shall first be thoroughly enveloped in unslaked lime.

Proper disposal shall be made by the owner of the animal or by the owner of the property on which the dead animal is found. Where the owner of the animal is unknown and the carcass is found upon any street, alley or other public place, it shall be removed and disposed of by the county board of health at public expense.

[Statutory Authority: RCW 43.20.050, 91-02-051 (Order 124B), recodified as § 246-203-120, filed 12/27/90, effective 1/31/91; Regulation .50.120, effective 3/11/60; subsection (2) amended by filing of 6/3/65.]

**WAC 246-203-130 Keeping of animals.** (1) Any person, firm or corporation is prohibited from keeping or sheltering animals in such a manner that a condition resulting from same shall constitute a nuisance.

(2) In populous districts, stable manure must be kept in a covered watertight pit or chamber and shall be removed at least once a week during the period from April 1st to October 1st and, during the other months, at intervals sufficiently frequent to maintain a sanitary condition satisfactory to the health officer. Manure on farms or isolated premises other than dairy farms need not be so protected and removed unless ordered by the health officer.

(3) Manure shall not be allowed to accumulate in any place where it can prejudicially affect any source of drinking water.

[Statutory Authority: RCW 43.20.050. 91-02-051 (Order 124B), recodified as § 246-203-130, filed 12/27/90, effective 1/31/91; Regulation .50.130, effective 3/11/60.]

**WAC 246-203-140 Stagnant water.** (1) All marshes or swamps, and all pools or ponds, either natural or artificial, shall be maintained by the owners free from the breeding of mosquitoes. If treatment is required to prevent the breeding of mosquitoes, it shall be accomplished by filling, draining, stocking with larvae-eating fish, treating with larvicide or mineral oil or by some other method approved by the state department of health.

(2) No person shall maintain or permit to be maintained any privy vault, cesspool, well, cistern, rain barrel, or other receptacle containing water in such condition that mosquitoes may breed therein.

[Statutory Authority: RCW 43.20.050. 91-02-051 (Order 124B), recodified as § 246-203-140, filed 12/27/90, effective 1/31/91; Regulation .50.140, effective 3/11/60.]

**WAC 246-203-150 Highway sanitation.** Any municipality, community, institution, corporation, association, firm or person who owns, operates, or maintains on or near any public highway, a place catering to the traveling public, shall maintain and operate said place in such a way that it does not constitute a menace to public health or a public nuisance.

[Statutory Authority: RCW 43.20.050. 91-02-051 (Order 124B), recodified as § 246-203-150, filed 12/27/90, effective 1/31/91; Regulation .50.150, effective 3/11/60.]

**WAC 246-203-160 Sanitation of public buildings.** (1) **Definition.** A public building shall be construed to mean any theater, show-house, public hall, public meeting place, public transportation terminal, or any other public building not covered by specific regulations: *Provided*, That a public building shall not be construed to include any store, market, supermarket, or other commercial establishment open to the general public for commercial purposes which does not cater to an audience.

(2) **Lighting and ventilation.** All public buildings shall be properly lighted and ventilated according to the type of said building and the uses to which it is put.

(3) **Water supply.**

(a) Any public place supplied with water under pressure shall be equipped with sanitary drinking fountains of an approved type.

(b) Where water supplied for drinking is not obtained from a public water supply, such water shall be of a quality approved by the secretary of the department of health.

When not under pressure, drinking water shall be stored in a covered container of an approved type.

(c) The use of the common drinking cup is prohibited.

(4) **Toilet facilities.** Every public building shall be provided with adequate sanitary toilet facilities for each of the sexes; and such facilities shall be convenient and accessible. Every public building which must provide adequate sanitary toilet facilities shall provide at least one free sanitary toilet facility for each of the sexes. Where toilet facilities are voluntarily provided by any store, market, supermarket, or other commercial establishment for use by customers of such establishment or the general public, there shall be at least one free sanitary toilet facility provided for each of the sexes. It shall be the duty of the owner, manager, or other responsible person in charge to see that the toilet system is properly installed and maintained in a usable and sanitary condition at all times.

The method of sewage disposal for all public buildings shall comply with the rules and regulations of the state board of health.

(5) **Cleaning.** All public buildings shall be kept at all times in a clean and sanitary condition and the cleaning shall be carried on under proper sanitary conditions. All rooms used for public meetings shall be cleaned after each meeting held in them, such cleaning to consist of thorough sweeping of the floors and wiping of the woodwork, together with proper airing of the rooms. No room shall be swept without the use of a proper dust-laying substance. Dry dusting is prohibited. In construing this regulation all meetings held during the course of a single day shall be regarded as one meeting.

[Statutory Authority: RCW 43.20.050. 92-02-019 (Order 225B), § 246-203-160, filed 12/23/91, effective 1/23/92; 91-02-051 (Order 124B), recodified as § 246-203-160, filed 12/27/90, effective 1/31/91; Order 98, § 248-50-160, filed 4/5/74; Order 89, § 248-50-160, filed 10/3/73; Regulation .50.160, effective 3/11/60.]

**WAC 246-203-170 Objectionable establishments and industrial wastes.** (1) No person, partnership, firm or corporation maintaining a slaughter house, rendering works, depository of dead animals, glue works, tannery, wool washing establishment, paper mill, by-product coke oven, dye works, oil refinery, dairy, creamery, cheese factory, milk station or similar establishment; or engaged in the manufacture of gas, chemicals, explosives, fertilizers, or similar products; or in the business of soap making, fish oil extraction, bone boiling or similar occupation, shall allow any noxious exhalation, odors or gases that are deleterious or detrimental to public health to escape into the air, or any substance that is deleterious or detrimental to public health to accumulate upon the premises; or be thrown or allowed to discharge into any street, roadway or public place; or be thrown or allowed to discharge into any stream or other waters of the state.

(2) All slaughter houses, rendering works, bone boiling establishments, depositories for dead animals, garbage disposal works, piggeries and similar establishments handling organic matter shall have an adequate water supply for the purpose of keeping the place clean and sanitary. All floors shall be constructed of concrete or other impervious material and shall have adequate provision for drainage to a sewer or treatment works approved by the department of health.

[Statutory Authority: RCW 43.20.050. 92-02-019 (Order 225B), § 246-203-170, filed 12/23/91, effective 1/23/92; 91-02-051 (Order 124B), recodified as § 246-203-170, filed 12/27/90, effective 1/31/91; Regulation .50.170, effective 3/11/60.]

**WAC 246-203-180 Piggeries.** (1) No pigsty or piggery shall be built or maintained on marshy ground or land subject to overflow, nor within 200 feet of any stream or other source of water supply.

(2) When garbage is fed to pigs all unconsumed garbage shall be removed daily and disposed of by burial or incineration.

(3) No organic material furnishing food for flies shall be allowed to accumulate on the premises.

(4) All garbage shall be handled and fed upon platforms of concrete or other impervious material.

(5) Unslaked lime, hypochlorite of lime, borax or mineral oil shall be used daily in sufficient quantities to prevent offensive odors and the breeding of flies.

(6) All garbage, offal and flesh fed to swine must be sterilized by cooking before feeding.

[Statutory Authority: RCW 43.20.050. 91-02-051 (Order 124B), recodified as § 246-203-180, filed 12/27/90, effective 1/31/91; Order 44, § 248-50-180, filed 12/11/70; Regulation .50.180, effective 3/11/60.]

**WAC 246-203-200 Disease producing organisms for rodent extermination forbidden.** The use of any disease-producing organisms such as the so-called "rat viruses" or any bacteria for the purpose of rodent extermination is prohibited.

[Statutory Authority: RCW 43.20.050. 91-02-051 (Order 124B), recodified as § 246-203-200, filed 12/27/90, effective 1/31/91; Regulation .50.200, effective 3/11/60.]

**WAC 246-203-210 Common drinking cups.** No person, firm, corporation or authorities owning, in charge of, or in control of any hotel, theatre, restaurant, lodging house, factory, school, church, store, office building, railway, trolley or other public conveyance station, or public conveyance by land, water or air, or other institution or conveyance frequented by the public or which may be used for the purpose of public assembly or as a place of employment, is permitted to furnish any cup, vessel or other receptacle for common use in any such place for drinking or eating purposes.

The term "common use" in this section shall be construed to mean, for use by more than one person without adequate cleansing.

[Statutory Authority: RCW 43.20.050. 91-02-051 (Order 124B), recodified as § 246-203-210, filed 12/27/90, effective 1/31/91; Regulation .50.210, effective 3/11/60.]

### Chapter 246-205 WAC

#### DECONTAMINATION OF ILLEGAL DRUG MANUFACTURING OR STORAGE SITES

##### WAC

246-205-001	Purpose and authority.
246-205-010	Definitions.

#### DECONTAMINATION CONTRACTOR CERTIFICATION

246-205-020	Authorized contractor services.
246-205-030	Courses for training workers and supervisors.
246-205-040	Training course approval.
246-205-050	Worker and supervisor certification.
246-205-060	Worker and supervisor certificate renewal.
246-205-070	Authorized contractor certification.
246-205-080	Reciprocity.
246-205-090	On-site supervision.
246-205-100	Performance standards.
246-205-110	Denial, suspension, revocation of certification, and civil penalties.
246-205-120	Authorized contractor certification list.

#### LOCAL HEALTH OFFICER RESPONSIBILITIES

246-205-520	Posting of property.
246-205-530	Environmental assessment.
246-205-540	Evaluation.
246-205-550	Reporting.
246-205-560	Notification.
246-205-570	Contamination reduction.
246-205-580	Recording of decontamination.
246-205-990	Fees.

**WAC 246-205-001 Purpose and authority.** (1) This chapter is adopted to protect the public's health, safety, and welfare by establishing standards, procedures, and responsibilities for:

(a) The certification of contractors and their employees authorized to perform decontamination of illegal drug manufacturing or storage sites; and

(b) Regulating the occupancy and use of property where hazardous chemicals or chemical residues commonly associated with the manufacture of illegal drugs are or may be present.

(2) The statutory authority for the adoption of this chapter is chapter 64.44 RCW.

(a) Contractor certification rules are jointly adopted by the state board of health and the department of health; and

(b) Rules in this chapter pertaining to local health officers' responsibilities are adopted by the state board of health.

(3) This chapter does not apply to industrial sites where a person's manufacturing process uses a hazardous chemical when licensed or regulated by state or federal agencies.

[Statutory Authority: RCW 64.40.070 [64.44.070] and chapter 64.44 RCW. 92-10-027 (Order 268B), § 246-205-001, filed 4/29/92, effective 5/30/92. Statutory Authority: RCW 64.44.060 and chapter 64.44 RCW. 91-04-007 (Order 125SB), § 246-205-001, filed 1/24/91, effective 4/1/91.]

**WAC 246-205-010 Definitions.** For the purposes of this chapter, the following words and phrases shall have the following meanings unless the content clearly indicates otherwise.

(1) "Authorized contractor" means any person or persons:

(a) Registered under chapter 18.27 RCW; and  
(b) Certified by the department to decontaminate, demolish, or dispose of contaminated property as required by chapter 64.44 RCW and this chapter.

(2) "Basic course" means a training course which has been sponsored or approved by the department for workers and supervisors who perform or supervise decontamination on illegal drug manufacturing or storage sites.

(3) "Certificate" means a department issued written approval under this chapter.

(4) "Certified" means a person who has department issued written approval under this chapter.

(5) "Contaminated" or "contamination" means polluted by hazardous chemicals so that the property is unfit for human habitation or use due to immediate or long-term hazards. Property that at one time was contaminated but has been satisfactorily decontaminated according to procedures established by the state board of health is not "contaminated."

(6) "Decontamination" means the process of reducing levels of known contaminants to the lowest practical level using currently available methods and processes.

(7) "Department" means the Washington state department of health.

(8) "Disposal of contaminated property" means the disposition of contaminated property under the provisions of chapter 70.105 RCW.

(9) "Hazardous chemicals" means the following substances used in the manufacture of illegal drugs:

(a) Hazardous substances as defined in RCW 70.105D.020; and

(b) Precursor substances as defined in RCW 69.43.010 which the state board of health, in consultation with the state board of pharmacy, has determined present an immediate or long-term health hazard to humans.

(10) "Illegal drug manufacturing or storage site" means any property where a person illegally manufactures or stores a controlled substance or a law enforcement agency or the property owner believes a person illegally manufactured or stored a controlled substance.

(11) "Initial site assessment" means the first evaluation of a property to determine the nature and extent of observable damage and contamination.

(12) "List of contaminated properties" means a list of properties contaminated by illegal drug manufacturing or the storage of hazardous chemicals.

(13) "Local department" means the jurisdictional local health department or district.

(14) "Local health officer" means a health officer or authorized representative as defined under chapters 70.05, 70.08, and 70.46 RCW.

(15) "Person" means an individual, firm, association, copartnership, political subdivision, government agency, municipality, industry, public or private corporation, or other entity.

(16) "Posting" means attaching a written or printed announcement conspicuously on property which may be, or is determined to be, contaminated by illegal drug manufacturing or the storage of a hazardous chemical.

(17) "Property" means any site, lot, parcel of land, structure, or part of a structure involved in the illegal manufacture of a drug or storage of a hazardous chemical including but not limited to:

- (a) Single-family residences;
- (b) Units or multiplexes;
- (c) Condominiums;
- (d) Apartment buildings;
- (e) Motels and hotels;
- (f) Boats;
- (g) Motor vehicles;

(h) Trailers;

(i) Manufactured housing;

(j) Any ship, booth, or garden; or

(k) Any site, lot, parcel of land, structure, or part of a structure that may be contaminated by previous use.

(18) "Property owner" means a person with a lawful right of possession of the property by reason of obtaining it by purchase, exchange, gift, lease, inheritance, or legal action.

(19) "Refresher course" means a department sponsored or approved biennial training course for decontamination workers and supervisors. An approved refresher course:

(a) Reviews the subjects taught in the initial training course; and

(b) Includes updated information on emerging decontamination technology.

(20) "Storage site" means any property used for the storage of illegally manufactured controlled substances or hazardous chemicals.

(21) "Subcontractor" means a person hired by an authorized contractor for the purpose of providing on-site services.

(22) "Supervisor" means a person employed by an authorized contractor who is on site during the decontamination of an illegal drug manufacturing or storage site and who is responsible for the activities performed.

(23) "Worker" means a person employed by an authorized contractor who performs decontamination of an illegal drug manufacturing or storage site.

[Statutory Authority: RCW 64.40.070 [64.44.070] and chapter 64.44 RCW. 92-10-027 (Order 268B), § 246-205-010, filed 4/29/92, effective 5/30/92. Statutory Authority: RCW 64.44.060 and 64.44.070. 92-02-017 (Order 223SB), § 246-205-010, filed 12/23/91, effective 1/23/92. Statutory Authority: RCW 64.44.060 and chapter 64.44 RCW. 91-04-007 (Order 125SB), § 246-205-010, filed 1/24/91, effective 4/1/91.]

## DECONTAMINATION CONTRACTOR CERTIFICATION

### WAC 246-205-020 Authorized contractor services.

(1) Persons performing or causing to be performed any decontamination, demolition, or disposal of contaminated property shall use the services of an authorized contractor.

(2) Persons advertising or offering to undertake or perform any work necessary to decontaminate properties shall first comply with these rules and secure a certificate from the department under RCW 64.44.060 and this chapter.

[Statutory Authority: RCW 64.44.060 and chapter 64.44 RCW. 91-04-007 (Order 125SB), § 246-205-020, filed 1/24/91, effective 4/1/91.]

### WAC 246-205-030 Courses for training workers and supervisors. The department shall:

(1) Train, test, or approve courses to train and test the authorized contractor's workers and supervisors on the essential elements in assessing and decontaminating property used as an illegal drug manufacturing or storage site;

(2) Require a biennial refresher course.

[Statutory Authority: RCW 64.44.060 and chapter 64.44 RCW. 91-04-007 (Order 125SB), § 246-205-030, filed 1/24/91, effective 4/1/91.]

**WAC 246-205-040 Training course approval.** (1) Persons having department approval may sponsor basic and refresher worker and supervisor training courses.

(2) Training course approval shall be contingent on department evaluation of:

(a) The breadth of knowledge and experience required to properly train workers or supervisors;

(b) Adequacy and accuracy of content; and

(c) Training techniques.

(3) Department approved training courses shall provide at a minimum, information on:

(a) Rules and regulations:

(i) Chapters 69.43 and 69.50 RCW;

(ii) Federal Occupational Health and Safety Act and Washington Industrial Safety and Health Act requirements.

(b) Chemical terminology and classifications:

(i) Definitions, physical and chemical properties, class characteristics and hazards, special cases;

(ii) Equipment such as heating mantle, condenser, glassware;

(iii) Concepts such as acid, base, and pH;

(iv) Solvents;

(v) Metals and salts;

(vi) Corrosives;

(vii) Precursor substances;

(viii) By-products and contaminants;

(ix) Poisons such as cyanide and phosphine.

(c) Surface properties of chemicals:

(i) Absorption;

(ii) Adsorption;

(iii) Chemical bonding;

(iv) Specific chemicals such as 1-phenyl-2-propanone and phenylacetic acid.

(d) Illegal drug laboratories:

(i) Laboratory types including:

(A) Methamphetamine/Amphetamine;

(B) Hallucinogens;

(C) Others such as cocaine and opiates.

(ii) Chemicals;

(iii) Equipment;

(iv) An overview of synthetic processes used; and

(v) Booby traps.

(e) Health effects:

(i) General:

(A) Effects of exposure to classes of chemicals;

(B) Use of literature such as *Material Safety Data Sheet* and *Chemical Hazards Handbook*.

(ii) Toxicology:

(A) Routes of exposure; and

(B) Exposure limits such as time weighted averages and threshold limit value.

(iii) Symptomatology; and

(iv) First aid.

(f) Incompatibility of chemicals related to clean-up:

(i) General concepts such as heat generation and poisonous gas formation; and

(ii) Specific hazards such as lithium, aluminum hydride and water, phosphorous and air.

(g) Decontamination:

(i) Structures and vehicles including cars and boats, covering:

(A) Different techniques and required equipment;

(B) Applications of specific clean-up techniques using hypothetical case examples and correlating site status with appropriate techniques; and

(C) Decision making about and prioritization of techniques based upon case-specific information.

(ii) Contents, specifically removal vs. cleaning; and

(iii) Personal decontamination of crew members prior to leaving a decontamination site.

(h) Handling of contaminated materials:

State/federal requirements for dealing with hazardous chemicals specific to:

(i) Disposal;

(ii) Transportation; and

(iii) Storage.

(i) Reporting requirements.

(j) Site characterization which shall be required for supervisors only:

How to acquire and review existing site specific information including:

(i) Source of data from health department, property owner, law enforcement, or ecology department;

(ii) Site walk-through and assessment;

(iii) Sampling before and after cleanup including:

(A) Who;

(B) When;

(C) What;

(D) How; and

(E) Where.

(k) Recordkeeping and reporting which shall be required for supervisors only:

(i) Initial site assessment;

(ii) Obtaining necessary information;

(iii) Initial site testing;

(iv) Workplan including:

(A) Scope;

(B) Content; and

(C) Format.

(v) Final site testing;

(vi) Report completion;

(vii) Other responsibilities of authorized contractors;

(viii) Penalties and liability.

(4) Sponsors of basic and refresher training courses proposed for department approval shall submit:

(a) Course location and fees;

(b) Copies of course handouts;

(c) A detailed description of course content and the amount of time allotted to each major topic;

(d) A description of teaching methods to be utilized and a list of all audio-visual materials;

(e) A list of all personnel involved in course preparation and presentation and a description of their qualifications;

(f) When specifically requested by the department, copies of all audio-visual materials proposed for utilization; and

(g) A list of two hundred questions for development of an examination.

(5) Sponsors seeking initial and renewal department approval of training courses shall:

(a) Apply on forms provided by the department;

(b) Submit to the department completed application with the required fee as specified under WAC 246-205-990;



(c) Ensure initial course approval applications are received by the department sixty or more days before the requested approval date; and

(d) Ensure training course renewal applications are received by the department thirty or more days before expiration of the current approval.

(6) The department shall:

(a) Approve basic and refresher training courses;

(b) Issue the course sponsor an approval valid for two years from the date of issuance;

(c) Require additional subjects to be taught to update information on new technology and determine the amount of time to be allotted to adequately cover these subjects;

(d) Provide a detailed outline of subject matter developed by the department to the sponsor for required incorporation into the training course.

(7) The course sponsor shall provide the department with a list of the names, addresses, and Social Security numbers of all persons completing a basic or refresher training course ten days or less after a course is completed.

(8) The course sponsor shall:

(a) Notify the department in writing thirty or more days before a training course is scheduled to begin; and

(b) Include the date, time, and address of the locations where training will be conducted; and

(c) Obtain department approval in advance for any changes to a training course.

(9) A department representative may, at the department's discretion, attend a training course as an observer to verify the course sponsor conducts the training course in accordance with the program approved by the department.

(10) Course sponsors conducting training outside the state of Washington shall:

(a) Reimburse the department at current state of Washington per diem and travel allowance rates for travel expenses associated with department observance of the training courses; and

(b) Submit reimbursement to the department within thirty days of receipt of the billing notice.

(11) The training course sponsor shall limit each class to a maximum of thirty participants.

(12) The department may terminate the training course approval if in the department's judgment the sponsor fails to:

(a) Maintain the course content and quality as initially approved;

(b) Make changes to a course as required by the department.

[Statutory Authority: RCW 64.44.060 and 64.44.070. 92-02-017 (Order 223SB), § 246-205-040, filed 12/23/91, effective 1/23/92. Statutory Authority: RCW 64.44.060 and chapter 64.44 RCW. 91-04-007 (Order 125SB), § 246-205-040, filed 1/24/91, effective 4/1/91.]

**WAC 246-205-050 Worker and supervisor certification.** (1) Applicants seeking an initial certificate as a decontamination worker shall submit to the department:

(a) A completed application on a form provided by the department;

(b) A fee as prescribed in WAC 246-205-990; and

(c) Evidence of successful completion of:

(i) Eighty or more hours of hazardous material training satisfying the requirements of WAC 296-62-3040; and

(ii) A department sponsored or approved decontamination worker training course.

(2) Applicants seeking an initial certificate as a decontamination supervisor shall submit to the department:

(a) Evidence of a valid and current Washington state decontamination worker certificate;

(b) Evidence of forty or more hours of on-site experience in hazardous material or illegal drug manufacturing or storage site decontamination projects;

(c) A completed application on a form provided by the department;

(d) A fee as prescribed in WAC 246-205-990; and

(e) Evidence of successful completion of a department sponsored or approved decontamination supervisor training course.

(3) Applicants for department certification shall:

(a) Ensure the completed application is received by the department sixty or less days after the completion of the course; or

(b) Pass an examination administered by the department with a score of seventy percent or more.

(4) Persons shall supervise and perform decontamination work only following issuance of the certificate, valid for two years from the date of issuance.

(5) Persons shall make certificates available for inspection at all times during an illegal drug manufacturing or storage site decontamination project.

(6) The department may deny, suspend, or revoke a person's certificate as described under WAC 246-205-110.

[Statutory Authority: RCW 64.44.060 and chapter 64.44 RCW. 91-04-007 (Order 125SB), § 246-205-050, filed 1/24/91, effective 4/1/91.]

**WAC 246-205-060 Worker and supervisor certificate renewal.** (1) Certified workers and supervisors seeking a renewal certificate shall submit to the department:

(a) A completed application for certificate renewal on a form provided by the department;

(b) A fee as prescribed in WAC 246-205-990;

(c) Evidence of successful completion of a department sponsored or approved refresher training course. Refresher training shall include:

(i) A thorough review of the subjects required under WAC 246-205-030;

(ii) Update of information on state-of-the-art procedures and equipment;

(iii) Review of regulatory changes and interpretation; and

(iv) Other subjects if required by the department to update information on new technology and procedures.

(2) Workers whose certificates have been expired for more than two years shall retake the entire basic course. Supervisors whose certificates have been expired for more than two years shall retake the entire basic supervisor's course.

[Statutory Authority: RCW 64.44.060 and chapter 64.44 RCW. 91-04-007 (Order 125SB), § 246-205-060, filed 1/24/91, effective 4/1/91.]

**WAC 246-205-070 Authorized contractor certification.** (1) A contractor may perform decontamination, demolition, or disposal work at an illegal drug manufacturing

or storage site only after the department issues the contractor a certificate.

(2) The department shall not require companies and persons providing only initial site assessment, sample collection, transportation, and testing services for drug laboratory decontamination contractors to be certified or trained under this chapter.

(3) Applicants for department certification as an authorized contractor, shall submit to the department:

(a) Evidence of being licensed, bonded, and insured as a general contractor under the provisions of chapter 18.27 RCW.

(b) Evidence of successful completion of specialized training for each employee who will do work on an illegal drug manufacturing or storage site;

(c) Documentation that the contractor has at least one department certified supervisor;

(d) A completed application on a form provided by the department; and

(e) A fee as prescribed in WAC 246-205-990.

[Statutory Authority: RCW 64.44.060 and chapter 64.44 RCW. 91-04-007 (Order 125SB), § 246-205-070, filed 1/24/91, effective 4/1/91.]

**WAC 246-205-080 Reciprocity.** (1) The department may provide reciprocal certification for contractors, supervisors, and workers trained and certified in another state if standards and training are substantially equivalent to those of this chapter.

(2) Applicants for reciprocity shall submit to the department:

(a) A completed application on a form provided by the department;

(b) Documentation of specialized training for illegal drug manufacturing or storage site decontamination;

(c) Evidence of successful completion of training required by Federal Occupational Safety and Health Act, Washington Industrial Safety and Health Act regulations, and WAC 296-62-3040; and

(d) A fee as prescribed in WAC 246-205-990.

(3) After reviewing the application, the department may issue the applicant a certificate or require:

(a) Additional information;

(b) A refresher course; or

(c) A department-administered examination.

[Statutory Authority: RCW 64.44.060 and 64.44.070. 92-02-017 (Order 223SB), § 246-205-080, filed 12/23/91, effective 1/23/92. Statutory Authority: RCW 64.44.060 and chapter 64.44 RCW. 91-04-007 (Order 125SB), § 246-205-080, filed 1/24/91, effective 4/1/91.]

**WAC 246-205-090 On-site supervision.** (1) During decontamination, demolition, or disposal of contaminated property at illegal drug manufacturing or storage sites, a contractor employed supervisor meeting the qualifications required in this chapter shall be on site and responsible for the activities performed.

(2) The contractor employed supervisor shall, while on site, make available for inspection, department provided certification attesting to the supervisor's training and credentials.

[Statutory Authority: RCW 64.44.060 and chapter 64.44 RCW. 91-04-007 (Order 125SB), § 246-205-090, filed 1/24/91, effective 4/1/91.]

**WAC 246-205-100 Performance standards.** Authorized contractors and their employees working at a decontamination site shall, at a minimum, meet the following performance standards:

(1) File a workplan with and obtain approval of the local health department;

(2) Perform work in accordance with the approved workplan;

(3) Perform work meeting the requirements of state and local building codes;

(4) Comply with applicable Federal Occupational Safety and Health Act and Washington Industrial Safety and Health Act regulations and requirements;

(5) Comply with the requirements of chapter 70.105 RCW and chapter 173-303 WAC;

(6) Comply with the requirements of applicable department of ecology and Environmental Protection Agency regulations;

(7) Comply with applicable contractor regulations;

(8) Notify the state and local jurisdictional health department of all work performed within ten days after completion of the project;

(9) Perform all decontamination work only with department certified workers and supervisors; and

(10) Comply with all other applicable laws and regulations.

[Statutory Authority: RCW 64.44.060 and chapter 64.44 RCW. 91-04-007 (Order 125SB), § 246-205-100, filed 1/24/91, effective 4/1/91.]

**WAC 246-205-110 Denial, suspension, revocation of certification, and civil penalties.** (1) The department shall deny an initial, renewal, or reciprocal illegal drug manufacturing or storage site decontamination worker, supervisor, or contractor certificate if the applicant fails to meet the requirements of this chapter.

(2) The department may take disciplinary action against a worker, supervisor, or contractor if the following occurs:

(a) Failure to comply with the requirements of chapter 64.44 RCW to include the performance standards or any rule adopted under chapter 64.44 RCW and this chapter;

(b) Failure of a worker or supervisor to make certificates available for inspection on site; or

(c) Committing fraud or misrepresentation in:

(i) Applying for certification;

(ii) Seeking approval of a workplan; or

(iii) Documenting completion of the work to the local health department.

(3) The department may take disciplinary action against a decontamination worker, supervisor, or contractor including, but not limited to, denial, suspension, or revocation of certification.

(4) The department may impose against a contractor a civil penalty not to exceed five hundred dollars, for each violation in addition to or in lieu of certification denial, suspension, or revocation pursuant to this rule. Each day the violation continues shall be considered a separate violation.

(5) Adjudicative proceedings are governed by chapter 34.05 RCW, the Administrative Procedure Act, chapter 246-08 WAC, and this chapter.

[Statutory Authority: RCW 64.44.060 and chapter 64.44 RCW. 91-04-007 (Order 125SB), § 246-205-110, filed 1/24/91, effective 4/1/91.]

**WAC 246-205-120 Authorized contractor certification list.** The department shall maintain a list of authorized illegal drug manufacturing or storage site decontamination contractors. The department's authorized contractor list shall be made available to local health officials and other appropriate agencies semi-annually, and to the public upon request.

[Statutory Authority: RCW 64.44.060 and chapter 64.44 RCW. 91-04-007 (Order 125SB), § 246-205-120, filed 1/24/91, effective 4/1/91.]

#### LOCAL HEALTH OFFICER RESPONSIBILITIES

**WAC 246-205-520 Posting of property.** (1) Within one working day of notification by a law enforcement agency or property owner that a property may be contaminated by hazardous chemicals, the local health officer shall notify the public of the potential contamination by causing a posting of a notice on the premises.

(2) The local health officer's initial notice shall:

(a) Warn the public that entry to the property may be unsafe; and

(b) Not declare the property unfit for use unless in the local health officer's opinion an immediate public health threat exists.

(3) If, in the local health officer's opinion, an immediate public health threat exists, the local health officer shall cause a posting of an order prohibiting use of all or portions of the property as required under WAC 246-205-560.

(4) The local health officer shall cause the posting, but, based on applicable local regulations or agreements, actual physical attachment of the written notice to the property may be effected by the:

(a) Health officer;

(b) Law enforcement personnel;

(c) Fire department personnel; or

(d) Other local health officer designee.

[Statutory Authority: RCW 64.40.070 [64.44.070] and chapter 64.44 RCW. 92-10-027 (Order 268B), § 246-205-520, filed 4/29/92, effective 5/30/92.]

**WAC 246-205-530 Environmental assessment.** (1) Within fourteen days after a law enforcement agency or property owner notifies the local health officer of potential property contamination, the local health officer shall cause an inspection of the property to commence. To enable the local health officer to determine contamination, the property inspection shall include an acquisition of data such as evidence of hazardous chemical use or storage on site, the presence of chemical stains, or the presence of glassware or other paraphernalia associated with the manufacture of illegal drugs.

(2) As part of the property's inspection, the local health officer shall request copies of any law enforcement reports, forensic chemist reports, and any department of ecology hazardous material transportation manifests needed to evaluate:

(a) The length of time a person used the property as an illegal drug manufacturing or storage site;

(b) The size of the site actually used for the manufacture or storage of illegal drugs;

(c) What chemical process was involved in the manufacture of illegal drugs;

(d) What chemicals were removed from the scene; and  
(e) The location of the illegal drug manufacturing or storage site in relation to the habitable areas of the property.

(3) The local health officer may coordinate the property's inspection with other appropriate agencies. At the request of the local health officer, the Washington state department of ecology may conduct an environmental assessment and may sample the property's ground water, surface water, septic tank water, soil, and other media as necessary to enable the local health officer to evaluate the long-term public health threats.

(4) If the local health officer determines law enforcement and ecology documents do not provide enough data to determine whether the property is contaminated, the local health officer may conduct a site visit or use other methods of obtaining information, to include a review of the analytical results obtained through sampling of the property by an authorized contractor or by the local health officer.

[Statutory Authority: RCW 64.40.070 [64.44.070] and chapter 64.44 RCW. 92-10-027 (Order 268B), § 246-205-530, filed 4/29/92, effective 5/30/92.]

**WAC 246-205-540 Evaluation.** (1) In making a determination of contamination, the local health officer shall follow guidelines developed by the Washington state department of health or other more stringent guidelines as deemed appropriate. If the local health officer determines that a contaminant is present for which no guidelines exist, and further finds that the contaminant presents a potential immediate or long term health hazard, then the local health officer shall find that the property is unfit for use.

(2) If designated unfit for use, the local health officer shall cause a posting of an order prohibiting use of all or portions of the property as required under WAC 246-205-560.

(3) If the local health officer determines the property is not contaminated and is fit for use, the local health officer shall document the findings for future use. The local health officer's documentation shall include:

(a) Findings;

(b) Conclusions;

(c) Name of the property owner;

(d) Mailing and street address of the property owner;

(e) Parcel identification number and legal description of the property; and

(f) Clear directions for locating the property.

[Statutory Authority: RCW 64.40.070 [64.44.070] and chapter 64.44 RCW. 92-10-027 (Order 268B), § 246-205-540, filed 4/29/92, effective 5/30/92.]

**WAC 246-205-550 Reporting.** (1) When property is determined unfit for use, the local health officer shall report the contaminated property to the state department of health within one working day by:

(a) Telephone; and

(b) In writing within ten working days.

(2) The local health officer's written unfit for use report to the state department of health shall include:

(a) Description of the findings;

(b) Conclusions;

(c) Name of the property owner;

(d) Mailing and street address of the property owner;

- (e) Parcel identification number and legal description of the property to including township and section;
- (f) Tax account number;
- (g) Date property designated unfit for use; and
- (h) Clear directions for locating the property.

[Statutory Authority: RCW 64.40.070 [64.44.070] and chapter 64.44 RCW. 92-10-027 (Order 268B), § 246-205-550, filed 4/29/92, effective 5/30/92.]

**WAC 246-205-560 Notification.** (1) Within one working day after the local health officer's determination that a property is contaminated, the local health officer or the local health officer's designee shall post in a conspicuous place on the property an order prohibiting use of all or portions of the property.

(2) Within ten working days after the local health officer's determination that a property is contaminated, the local health officer shall cause to be served, either personally or by certified mail, return receipt requested, an order prohibiting use to all known:

- (a) Occupants; and
- (b) Persons having an interest in the property as shown upon the records of the auditor's office of the county in which the property is located.

(3) If the whereabouts of persons described under subsection (2) of this section is unknown and the same cannot be ascertained by the local health officer in the exercise of reasonable diligence, and the health officer makes an affidavit to that effect, then the serving of the order upon such persons may be made by:

- (a) Personal service; or
- (b) Mailing a copy of the order by certified mail, postage prepaid, return receipt requested:

(i) To each person at the address appearing on the last equalized tax assessment roll of the county where the property is located; or

(ii) At the address known to the county assessor.

(4) The local health officer shall also mail a copy of the order addressed to each person or party having a recorded right, title, estate, lien, or interest in the property.

(5) The local health officer's order shall:

(a) Describe the local health officer's intended course of action;

(b) Describe a property owner's penalties for noncompliance with this order;

(c) Prohibit a property owner's use of all or portions of the property;

(d) Describe what measures a property owner must take to have the property decontaminated; and

(e) Indicate the potential health risks involved.

(6) The local health officer shall:

(a) File a copy of the order prohibiting use of the property with the county auditor; and

(b) Provide a copy of such order to the local building permit department.

(7) The local health officer's order shall advise that:

(a) A hearing before the local health officer or local health board shall be held upon the request of a person notified of the order as required under this chapter; and

(b) The person's request for a hearing shall be made within ten days of the local health officer's serving of the order; and

(c) The hearing shall then be held within not less than twenty days or more than thirty days after the serving of the order; and

(d) In any hearing concerning whether property is fit for use, the property owner has the burden of showing that the property is decontaminated or fit for use.

[Statutory Authority: RCW 64.40.070 [64.44.070] and chapter 64.44 RCW. 92-10-027 (Order 268B), § 246-205-560, filed 4/29/92, effective 5/30/92.]

**WAC 246-205-570 Contamination reduction.** (1) An owner of contaminated property who desires to reduce the contamination shall use the services of an authorized contractor.

(2) The local health officer shall provide the property owner with a list of authorized contractors upon request.

(3) Before commencing contamination reduction, the property owner shall have a written work plan to reduce contamination of the property prepared by the contractor and approved by the local health officer. The work plan shall outline the contamination reduction and waste disposal procedures the contractor intends to use.

(4) The property owner and the contractor shall follow the state department of health contamination reduction guidelines or other more stringent procedures as deemed appropriate by the local health officer.

(5) The property owner shall be:

(a) Financially responsible for any property testing which may be required to demonstrate the presence or absence of hazardous chemicals;

(b) Financially responsible for the property's contamination reduction and disposal expenses, as well as costs incurred by the local health officer resulting from the enforcement of this chapter;

(c) Responsible for keeping records documenting contamination reduction procedures and submitting notarized copies of all records to the local health officer; and

(d) Responsible for petitioning the local health officer to review the contamination reduction records and to declare the property fit for use.

[Statutory Authority: RCW 64.40.070 [64.44.070] and chapter 64.44 RCW. 92-10-027 (Order 268B), § 246-205-570, filed 4/29/92, effective 5/30/92.]

**WAC 246-205-580 Recording of decontamination.** (1) Within ten working days of a request for review of contamination reduction records, the local health officer:

(a) Shall review the documentation to verify reduction of contamination to acceptable levels for reoccupancy as stated in state department of health guidelines or other more stringent requirements as deemed appropriate by the local health officer;

(b) May visit the property site to assess the thoroughness of the contractor's clean-up;

(c) May require the property owner to provide more extensive testing and assessment of the property site by an independent laboratory or firm qualified to perform such testing and assessment.

(2) If, after review of the information in subsection (1) of this section, the local health officer determines the property has been decontaminated, the local health officer shall within ten working days:

(a) Record a notice in the real property records of the county auditor where the property is located indicating that to the best of his or her knowledge, the basis upon which the property was originally declared unfit for use has been addressed by decontamination in accordance with board of health and department of health rules and guidelines.

(b) Send a copy of the notice to the property owner.

(c) Send a copy of the notice to the state department of health.

(d) Send a copy of the notice to the local building permit department.

[Statutory Authority: RCW 64.40.070 [64.44.070] and chapter 64.44 RCW. 92-10-027 (Order 268B), § 246-205-580, filed 4/29/92, effective 5/30/92.]

**WAC 246-205-990 Fees.** (1) The department shall charge fees for issuance and renewal of certificates. The department shall set the fees by rule.

(2) The fees shall cover the cost of issuing certificates, filing papers and notices, and administering this chapter. The costs shall include reproduction, travel, per diem, and administrative and legal support costs.

(3) Fees are nonrefundable and shall be in the form of check or money order made payable to the department.

(4) The department shall require payment of the following fees upon receipt of application:

(a) Twenty-five dollars shall be assessed for each initial, renewal, or reciprocal worker certificate application.

(b) Twenty-five dollars shall be assessed for each initial, renewal, or reciprocal supervisor certificate application.

(c) Five hundred dollars shall be assessed for each initial, renewal, or reciprocal authorized contractor certificate application. The applicant's certificate shall expire annually on the expiration date of the contractor's license issued under the provisions of chapter 18.27 RCW.

(d) Two hundred dollars shall be assessed for each initial application and fifty dollars shall be assessed for each renewal application for illegal drug manufacturing or storage site decontamination training course approval.

[Statutory Authority: RCW 64.44.060 and chapter 64.44 RCW. 91-04-007 (Order 125SB), § 246-205-990, filed 1/24/91, effective 4/1/91.]

## Chapter 246-215 WAC FOOD SERVICE

### WAC

246-215-001	Purpose and authority.
246-215-010	Definitions.
246-215-020	Food supplies.
246-215-030	Food protection.
246-215-040	Public health labeling.
246-215-050	Food preparation.
246-215-060	Modified atmosphere packaging.
246-215-070	Temperature control.
246-215-080	Personal hygiene.
246-215-090	Sanitary design, construction, and installation of equipment and utensils.
246-215-100	Equipment and utensil cleaning and sanitizing.
246-215-110	Poisonous or toxic materials.
246-215-120	Sanitary facilities and controls.
246-215-130	Garbage, rubbish, and litter.
246-215-140	Pests and pest control.
246-215-150	Construction and maintenance of physical facilities.
246-215-160	Mobile food units.

246-215-170	Customer self-service of food and bulk food dispensing.
246-215-180	Bed and breakfast food service operations.
246-215-190	Temporary food service establishments.
246-215-200	Permits required, suspension, revocation, enforcement.
246-215-210	Service of notices.
246-215-220	Hearings.
246-215-230	Inspections and investigations.
246-215-240	Examination, hold orders, condemnation, and destruction of food.
246-215-250	Review of plans and menu.
246-215-260	Procedure when disease transmission is suspected.
246-215-270	Variance clause.
246-215-280	Interpretation.
246-215-290	Separability clause.
246-215-300	Penalty clause.

### DISPOSITION OF SECTIONS FORMERLY CODIFIED IN THIS CHAPTER

246-215-009	Definitions. [Statutory Authority: RCW 43.20.050. 91-02-051 (Order 124B), recodified as § 246-215-009, filed 12/27/90, effective 1/31/91; 84-14-090 (Order 274), § 248-84-002, filed 7/3/84; 80-14-059 (Order 203), § 248-84-002, filed 10/1/80.] Repealed by 92-08-112 (Order 261B), filed 4/1/92, effective 5/2/92. Statutory Authority: RCW 43.20.050.
246-215-019	Food supplies. [Statutory Authority: RCW 43.20.050. 91-02-051 (Order 124B), recodified as § 246-215-019, filed 12/27/90, effective 1/31/91; 80-14-059 (Order 203), § 248-84-010, filed 10/1/80; Regulation .84.010, filed 6/4/63; Regulation .84.010, effective 3/11/60.] Repealed by 92-08-112 (Order 261B), filed 4/1/92, effective 5/2/92. Statutory Authority: RCW 43.20.050.
246-215-029	Food protection and storage. [Statutory Authority: RCW 43.20.050. 91-02-051 (Order 124B), recodified as § 246-215-029, filed 12/27/90, effective 1/31/91; 80-14-059 (Order 203), § 248-84-015, filed 10/1/80.] Repealed by 92-08-112 (Order 261B), filed 4/1/92, effective 5/2/92. Statutory Authority: RCW 43.20.050.
246-215-039	Food preparation, display, service and transportation. [Statutory Authority: RCW 43.20.050. 91-02-051 (Order 124B), recodified as § 246-215-039, filed 12/27/90, effective 1/31/91; 80-14-059 (Order 203), § 248-84-020, filed 10/1/80; Regulation .84.020, filed 6/4/63; Regulation .84.020, effective 3/11/60.] Repealed by 92-08-112 (Order 261B), filed 4/1/92, effective 5/2/92. Statutory Authority: RCW 43.20.050.
246-215-049	Personnel. [Statutory Authority: RCW 43.20.050. 91-02-051 (Order 124B), recodified as § 246-215-049, filed 12/27/90, effective 1/31/91; 80-14-059 (Order 203), § 248-84-025, filed 10/1/80.] Repealed by 92-08-112 (Order 261B), filed 4/1/92, effective 5/2/92. Statutory Authority: RCW 43.20.050.
246-215-059	Sanitary design, construction, and installation of equipment and utensils. [Statutory Authority: RCW 43.20.050. 91-02-051 (Order 124B), recodified as § 246-215-059, filed 12/27/90, effective 1/31/91; 84-14-090 (Order 274), § 248-84-030, filed 7/3/84; 80-14-059 (Order 203), § 248-84-030, filed 10/1/80; Regulation .84.030, filed 6/4/63; Regulation .84.030 effective 3/11/60.] Repealed by 92-08-112 (Order 261B), filed 4/1/92, effective 5/2/92. Statutory Authority: RCW 43.20.050.
246-215-069	Equipment and utensil cleaning and sanitation. [Statutory Authority: RCW 43.20.050. 91-02-051 (Order 124B), recodified as § 246-215-069, filed 12/27/90, effective 1/31/91; 84-14-090 (Order 274), § 248-84-035, filed 7/3/84; 80-14-059 (Order 203), § 248-84-035, filed 10/1/80.] Repealed by 92-08-112 (Order 261B), filed 4/1/92, effective 5/2/92. Statutory Authority: RCW 43.20.050.
246-215-079	Sanitary facilities and controls. [Statutory Authority: RCW 43.20.050. 91-02-051 (Order 124B), recodified as § 246-215-079, filed 12/27/90, effective 1/31/91; 80-14-059 (Order 203), § 248-84-040, filed 10/1/80; Regulation .84.040, filed 6/4/63; Regulation .84.040, effective

- 3/11/60.] Repealed by 92-08-112 (Order 261B), filed 4/1/92, effective 5/2/92. Statutory Authority: RCW 43.20.050.
- 246-215-089 Garbage and rubbish. [Statutory Authority: RCW 43.20.050. 91-02-051 (Order 124B), recodified as § 246-215-089, filed 12/27/90, effective 1/31/91; 80-14-059 (Order 203), § 248-84-045, filed 10/1/80.] Repealed by 92-08-112 (Order 261B), filed 4/1/92, effective 5/2/92. Statutory Authority: RCW 43.20.050.
- 246-215-099 Insect and rodent control. [Statutory Authority: RCW 43.20.050. 91-02-051 (Order 124B), recodified as § 246-215-099, filed 12/27/90, effective 1/31/91; 80-14-059 (Order 203), § 248-84-050, filed 10/1/80; Regulation .84.050, filed 6/4/63; Regulation .84.050, effective 3/11/60.] Repealed by 92-08-112 (Order 261B), filed 4/1/92, effective 5/2/92. Statutory Authority: RCW 43.20.050.
- 246-215-109 Construction and maintenance of physical facilities. [Statutory Authority: RCW 43.20.050. 91-02-051 (Order 124B), recodified as § 246-215-109, filed 12/27/90, effective 1/31/91; 80-14-059 (Order 203), § 248-84-055, filed 10/1/80.] Repealed by 92-08-112 (Order 261B), filed 4/1/92, effective 5/2/92. Statutory Authority: RCW 43.20.050.
- 246-215-119 Mobile units. [Statutory Authority: RCW 43.20.050. 91-02-051 (Order 124B), recodified as § 246-215-119, filed 12/27/90, effective 1/31/91; 80-14-059 (Order 203), § 248-84-060, filed 10/1/80; Regulation .84.060, filed 6/4/63; Rules (part), effective 3/11/60.] Repealed by 92-08-112 (Order 261B), filed 4/1/92, effective 5/2/92. Statutory Authority: RCW 43.20.050.
- 246-215-129 Bulk foods, storage, and display. [Statutory Authority: RCW 43.20.050. 91-02-051 (Order 124B), recodified as § 246-215-129, filed 12/27/90, effective 1/31/91; 84-14-090 (Order 274), § 248-84-062, filed 7/3/84.] Repealed by 92-08-112 (Order 261B), filed 4/1/92, effective 5/2/92. Statutory Authority: RCW 43.20.050.
- 246-215-139 Temporary food service establishments. [Statutory Authority: RCW 43.20.050. 91-02-051 (Order 124B), recodified as § 246-215-139, filed 12/27/90, effective 1/31/91; 80-14-059 (Order 203), § 248-84-065, filed 10/1/80.] Repealed by 92-08-112 (Order 261B), filed 4/1/92, effective 5/2/92. Statutory Authority: RCW 43.20.050.
- 246-215-149 Permits required, suspension and revocation procedures. [Statutory Authority: RCW 43.20.050. 91-02-051 (Order 124B), recodified as § 246-215-149, filed 12/27/90, effective 1/31/91; 80-14-059 (Order 203), § 248-84-070, filed 10/1/80; Regulation .84.070 (part), filed 6/4/63; Rules (part), effective 3/11/60.] Repealed by 92-08-112 (Order 261B), filed 4/1/92, effective 5/2/92. Statutory Authority: RCW 43.20.050.
- 246-215-159 Service of notices. [Statutory Authority: RCW 43.20.050. 91-02-051 (Order 124B), recodified as § 246-215-159, filed 12/27/90, effective 1/31/91; 80-14-059 (Order 203), § 248-84-075, filed 10/1/80.] Repealed by 92-08-112 (Order 261B), filed 4/1/92, effective 5/2/92. Statutory Authority: RCW 43.20.050.
- 246-215-169 Hearings. [Statutory Authority: RCW 43.20.050. 91-02-051 (Order 124B), recodified as § 246-215-169, filed 12/27/90, effective 1/31/91; 80-14-059 (Order 203), § 248-84-080, filed 10/1/80.] Repealed by 92-08-112 (Order 261B), filed 4/1/92, effective 5/2/92. Statutory Authority: RCW 43.20.050.
- 246-215-179 Inspections. [Statutory Authority: RCW 43.20.050. 91-02-051 (Order 124B), recodified as § 246-215-179, filed 12/27/90, effective 1/31/91; 80-14-059 (Order 203), § 248-84-085, filed 10/1/80.] Repealed by 92-08-112 (Order 261B), filed 4/1/92, effective 5/2/92. Statutory Authority: RCW 43.20.050.
- 246-215-189 Examination—Hold orders—Condemnation—Destruction of food. [Statutory Authority: RCW 43.20.050. 91-02-051 (Order 124B), recodified as § 246-215-189, filed 12/27/90, effective 1/31/91; 80-14-059 (Order 203), § 248-84-090, filed 10/1/80.] Repealed by 92-08-112 (Order 261B), filed 4/1/92, effective 5/2/92. Statutory Authority: RCW 43.20.050.
- 246-215-199 Review of plans. [Statutory Authority: RCW 43.20.050. 91-02-051 (Order 124B), recodified as § 246-215-199, filed 12/27/90, effective 1/31/91; 80-14-059 (Order 203), § 248-84-095, filed 10/1/80.] Repealed by 92-08-112 (Order 261B), filed 4/1/92, effective 5/2/92. Statutory Authority: RCW 43.20.050.
- 246-215-209 Procedure when infection is suspected. [Statutory Authority: RCW 43.20.050. 91-02-051 (Order 124B), recodified as § 246-215-209, filed 12/27/90, effective 1/31/91; 80-14-059 (Order 203), § 248-84-100, filed 10/1/80.] Repealed by 92-08-112 (Order 261B), filed 4/1/92, effective 5/2/92. Statutory Authority: RCW 43.20.050.
- 246-215-219 Variance clause. [Statutory Authority: RCW 43.20.050. 91-02-051 (Order 124B), recodified as § 246-215-219, filed 12/27/90, effective 1/31/91; 80-14-059 (Order 203), § 248-84-105, filed 10/1/80.] Repealed by 92-08-112 (Order 261B), filed 4/1/92, effective 5/2/92. Statutory Authority: RCW 43.20.050.
- 246-215-229 Interpretation. [Statutory Authority: RCW 43.20.050. 91-02-051 (Order 124B), recodified as § 246-215-229, filed 12/27/90, effective 1/31/91; 80-14-059 (Order 203), § 248-84-110, filed 10/1/80.] Repealed by 92-08-112 (Order 261B), filed 4/1/92, effective 5/2/92. Statutory Authority: RCW 43.20.050.
- 246-215-239 Sulfiting agents. [Statutory Authority: RCW 43.20.050. 91-02-051 (Order 124B), recodified as § 246-215-239, filed 12/27/90, effective 1/31/91; 85-11-024 (Order 288), § 248-84-120, filed 5/13/85.] Repealed by 92-08-112 (Order 261B), filed 4/1/92, effective 5/2/92. Statutory Authority: RCW 43.20.050.
- 246-215-500 Separability clause. [Statutory Authority: RCW 43.20.050. 91-02-051 (Order 124B), recodified as § 246-215-500, filed 12/27/90, effective 1/31/91; 80-14-059 (Order 203), § 248-84-500, filed 10/1/80.] Repealed by 92-08-112 (Order 261B), filed 4/1/92, effective 5/2/92. Statutory Authority: RCW 43.20.050.
- 246-215-900 Penalty clause. [Statutory Authority: RCW 43.20.050. 91-02-051 (Order 124B), recodified as § 246-215-900, filed 12/27/90, effective 1/31/91; 80-14-059 (Order 203), § 248-84-900, filed 10/1/80.] Repealed by 92-08-112 (Order 261B), filed 4/1/92, effective 5/2/92. Statutory Authority: RCW 43.20.050.

**WAC 246-215-001 Purpose and authority.** The purpose of chapter 246-215 WAC is to establish state board of health standards for food service under RCW 43.20.050 to promote and protect the health, safety, and well-being of the public and prevent the spread of disease by food.

[Statutory Authority: RCW 43.20.050. 92-08-112 (Order 261B), § 246-215-001, filed 4/1/92, effective 5/2/92; 91-02-051 (Order 124B), recodified as § 246-215-001, filed 12/27/90, effective 1/31/91; 80-14-059 (Order 203), § 248-84-001, filed 10/1/80; Regulation .84.001, filed 6/4/63; Regulation .84.001, effective 3/11/60.]

- WAC 246-215-010 Definitions.** (1) "Abbreviations":
- (a) "FDA" means United States Food and Drug Administration.
  - (b) "HACCP" means hazard analysis, critical control point.
  - (c) "PPM" means parts per million.
  - (d) "USA" means United States of America.
  - (e) "USDA" means United States Department of Agriculture.
  - (f) "WSDA" means Washington state department of agriculture.
- (2) "Adulterated" means the altered condition of food including:



(a) Bearing or containing any poisonous or deleterious substance in a quantity rendering food injurious to health;

(b) Bearing or containing any added poisonous or deleterious substance where no safe tolerance has been established by regulation, or exceeding such tolerance if one has been established;

(c) Consisting in whole or in part of any filthy, putrid, or decomposed substance, or otherwise being unfit for human consumption;

(d) Processing, preparing, packing, or holding potentially hazardous foods under improper time-temperature conditions or under other conditions increasing the probability of food contamination with excessive microorganisms or physical contaminants;

(e) Processing, preparing, packing, or holding food under insanitary conditions increasing the probability of food contamination or cross-contamination;

(f) Holding or packaging food in containers composed, in whole or in part, of any poisonous or deleterious substance rendering the contents potentially injurious to health; or

(g) Containing any product of a diseased animal, or an animal dying by means other than by slaughter, except as permitted under WAC 246-215-020(6).

(3) "Approved" means acceptable to the health officer based on his/her determination regarding conformance with appropriate standards and public health practice.

(4) "Approved source" means foods which are obtained by the food service establishment owner from persons who comply with applicable federal, state and local laws, ordinances and regulations.

(5) "Aquatic foods" means foods grown in or harvested from water, including all types of fish, shellfish and mollusks, edible crustacea, reptiles, amphibians, and mixtures containing aquatic foods and synthetic foods, such as surimi.

(6) "Base of operation" means an approved site for servicing, cleaning, sanitizing, supplying, and maintaining a mobile food unit.

(7) "Bed and breakfast" means a private home or inn offering lodging on a temporary basis to travelers, tourists, and transient guests which provides food service only to registered guests.

(8) "Bulk food" means processed or unprocessed food in containers where consumers withdraw desired quantities.

(9) "Caterer" means a person or food service establishment contracted to prepare food in an approved facility for final cooking or service at another location.

(10) "Commissary" means an approved food service establishment where food is stored, prepared, portioned, or packaged for service elsewhere.

(11) "Corrosion-resistant" means a material maintaining original surface characteristics under prolonged contact with food, cleaning compounds, or sanitizing solutions.

(12) "Critical control point" means a location where exercising a preventive measure or procedure eliminates, prevents, or minimizes a hazard or hazards from occurring after that point.

(13) "Cross-contamination" means the process where disease causing organisms are transferred from raw or other foods to equipment or ready-to-eat foods.

(14) "Department" means the Washington state department of health.

(15) "Durable" means capable of withstanding expected use and remaining easily cleanable.

(16) "Easily cleanable" means readily accessible with materials and finish fabricated to permit complete removal of residue by normal cleaning methods.

(17) "Equipment" means all stoves, ovens, ranges, hoods, slicers, mixers, meat blocks, tables, counters, refrigerators, sinks, dish machines, steam tables, and similar items used in the operation of a food service establishment.

(18) "Extensive remodel" means construction in a food service establishment requiring a building permit or plumbing permit, except for signs and fences.

(19) "Food" means any raw, cooked, or processed edible substance, ice, beverage, or ingredient used or intended for use or for sale, in whole or in part, for human consumption.

(20) "Food additive" means substances added directly or indirectly to food.

(21) "Food contact surfaces" means those surfaces of equipment and utensils normally contacting food, and those surfaces where food may drain, drip, or splash back onto surfaces normally in contact with food.

(22) "Food service establishment" means:

(a) A place, location, operation, site, or facility where food is manufactured, prepared, processed, packaged, dispensed, distributed, sold, served, or offered to the consumer regardless of whether or not compensation for food occurs, including but not limited to:

(i) Restaurants, snack bars, cafeterias, taverns, bars;

(ii) Retail food stores, supermarkets, retail meat markets, retail fish markets, retail bakeries, delicatessens;

(iii) Institutional operations licensed by the department or local health officer, such as schools, hospitals, jails, prisons, and child care facilities;

(iv) Central preparation sites, including caterers;

(v) Satellite servicing locations;

(vi) Temporary food service establishments or mobile food units;

(vii) Bed and breakfast operations;

(viii) Remote feeding sites; and

(ix) Vending machines dispensing potentially hazardous foods.

(b) Except for the following:

(i) Private homes where food is prepared or served for consumption by household members and/or their guests;

(ii) Establishments offering only commercially prepackaged nonpotentially hazardous foods;

(iii) Commercial food processing establishments, licensed and regulated by the USDA, FDA, or WSDA; and

(iv) Farmers exempt from licensure under RCW 36.71.090.

(23) "Food service worker" means the permit holder, an individual having supervisory or management duties, and any other person working in a food service establishment.

(24) "Frozen" means the condition of a food when it is continuously stored at or below 10° F.

(25) "Game meat" means warm-blooded and cold-blooded animals, excluding fish and meat food animals as defined by USDA, noncommercially raised and processed without continuous regulatory surveillance, including, but not limited to:

(a) Mammals such as deer, elk, antelope, buffalo, and bear;

- (b) Birds; and
  - (c) Reptiles such as alligator.
- (26) "Hazard analysis critical control point (HACCP)" means a method used to reduce the risk of foodborne illness by:
- (a) Identifying hazards of high risk foods;
  - (b) Assessing the hazards posed by each preparation step;
  - (c) Determining the critical points for controlling hazards;
  - (d) Monitoring a critical control point or points; and
  - (e) Implementing immediate and appropriate corrective action when control criteria are not met.
- (27) "Health officer" means the city, county, city-county, or district health officer defined under RCW 70.05.010(2), or his/her authorized representative, or the representative of the department.
- (28) "Hermetically sealed container" means a properly designed container, intended to keep the contents free of contamination by microorganisms and to maintain the commercial sterility of its contents after thermal processing.
- (29) "Imminent or actual health hazard" means:
- (a) A breakdown or lack of equipment or power causing improper temperature control for potentially hazardous foods; and/or
  - (b) Lack of water preventing adequate handwashing or equipment cleaning and sanitizing; and/or
  - (c) Emergency situations including fire, flood, building collapse, or similar accident or natural disaster; and/or
  - (d) A sewage backup or sewage contamination within a food service establishment; and/or
  - (e) An occurrence of an outbreak of foodborne illness linked to the food service establishment.
- (30) "Immediate service" means foods served to the public within thirty minutes of preparation.
- (31) "Menu" means a written or graphic description of foods prepared and offered for sale or service by a food service establishment.
- (32) "Mislabelled" means the presence of any false or misleading written, printed, or graphic material upon or accompanying food or food containers.
- (33) "Mobile food unit" means a readily movable food service establishment.
- (34) "Modified atmosphere packaging" means a process that completely encases food in an impermeable or partially permeable membrane, with either a partial or complete vacuum; or a gas or mixture of gases surrounding the food. Hermetically sealed containers are not considered to be modified atmosphere packaging.
- (35) "Owner" means a person owning and/or responsible for the operation of a food service establishment.
- (36) "Perishable food" means foods, other than potentially hazardous foods, where deterioration or spoilage due to loss of moisture or growth of molds and bacteria may occur.
- (37) "Person" means any individual, partnership, corporation, association, or other legal entity or agency of state, county, or municipal government, or agency of the federal government which is subject to the jurisdiction of the state.
- (38) "Person in charge" means the individual present in a food service establishment and designated supervisor of the

food service establishment at the time of inspection or any food service worker present when a designated supervisor is absent.

(39) "pH" means a measure of the amount of acid in a food product.

(40) "Potentially hazardous food" means any natural or synthetic edible item, material, or ingredient in a form supporting rapid and progressive growth of infectious or toxigenic microorganisms or the slower growth of *Clostridium botulinum*. Potentially hazardous food:

(a) Includes any food of animal origin, raw, cooked, or processed;

(b) Includes certain cooked or prepared foods of plant origin, including but not limited to:

- (i) Potato products;
- (ii) Dry legumes;
- (iii) Rice;
- (iv) Sprouts; and
- (v) Cut melons and cut cantaloupes.

(c) Excludes foods:

- (i) With a water activity ( $A_w$ ) value of 0.90 or less;
- (ii) With a pH level of 4.6 or below;
- (iii) Enclosed in unopened hermetically sealed containers commercially processed to achieve and maintain commercial sterility under nonrefrigerated storage and distribution conditions; and
- (iv) Where laboratory evidence acceptable to the health officer indicates no likelihood of rapid or progressive growth of infectious or toxigenic microorganisms or the slower growth of *Clostridium botulinum*.

(41) "Restructured" means potentially hazardous foods processed and formed so surface contaminants may become incorporated inside the final product.

(42) "Sanitary design" means smooth, nonabsorbent, and easily cleanable.

(43) "Sanitized" means effective bactericidal treatment by a process providing enough accumulative heat or concentration of chemicals for enough time to reduce the bacterial count, including pathogens, to a safe level on food contact surfaces.

(44) "Sealed" means free of cracks or other openings permitting entry or passage of moisture or air.

(45) "Self-service" means any site within a food service establishment where customers dispense their own food or beverages.

(46) "Served" means offered to a person for consumption.

(47) "Single service articles" means utensils designed, fabricated, and intended by the manufacturer for one time use.

(48) "Sulfiting agents" means chemicals used to treat food to increase shelf life and enhance appearance including:

- (a) Sulfur dioxide;
- (b) Sodium sulfite;
- (c) Sodium bisulfite;
- (d) Potassium bisulfite;
- (e) Sodium metabisulfite; and
- (f) Potassium metabisulfite.

(49) "Temporary food service establishment" means a food service establishment operating at a fixed location for not more than twenty-one consecutive days in conjunction with a single event or celebration.

(50) "Time/temperature" means the relationship between the length of time and the specific temperatures to which potentially hazardous foods are subjected during storage, transportation, preparation, cooking, reheating, dispensing, service, or sale.

(51) "Utensil" means any food contact implement used in storing, preparing, transporting, dispensing, serving, or selling of food.

(52) "Water activity (Aw)" means a measure of the amount of moisture available for bacterial growth in a food.

(53) "Wholesome" means in sound condition, clean, free from adulteration, and otherwise suitable for use as human food.

[Statutory Authority: RCW 43.20.050, 92-08-112 (Order 261B), § 246-215-010, filed 4/1/92, effective 5/2/92.]

**WAC 246-215-020 Food supplies.** Food service establishment owners shall:

(1) Use or sell food supplies which are:

(a) From approved sources;

(b) In compliance with applicable federal, state, and local laws, ordinances, and regulations;

(c) Clean, wholesome, and free from spoilage and adulteration;

(d) Protected from becoming adulterated;

(e) Safe for human consumption; and

(f) Hermetically sealed containers, processed in an approved commercial food processing establishment, when used.

(2) Use or sell commercially pasteurized fluid milk, fluid milk products, dry milk, and dry milk products which meet the Grade "A" quality standards contained in the most current version of

the federal Pasteurized Milk Ordinance, except:

(a) Grade "A" raw milk as defined under RCW 15.36.140 may be sold in the original container for off-premises consumption in retail food stores only;

(b) Unripened raw milk cheese and similar raw milk cultured products may be sold in retail stores for off-premises consumption and may be used in food service establishments, only if the foods are subsequently cooked to a minimum temperature of 165° F; and

(c) Properly fermented raw milk cheeses, produced using a flash heating process and meeting cheese composition requirements described under WAC 246-215-040 (6)(c), may be sold or used in food service establishments and are exempted from the cooking requirements of (b) of this subsection.

(3) Use or sell fresh and frozen shellfish (oysters, clams, mussels, and scallops):

(a) From sources approved by the department; or certified for interstate shipment in accordance with the National Shellfish Sanitation Program (NSSP); and

(b) Which are identified by one of the following methods:

(i) A tag or label containing name, address, state certification number, harvest date, and location attached to bags of unshucked shellfish;

(ii) A label containing name, address, and state certification number attached to containers of shucked shellfish; or

(iii) State certification numbers and harvest location provided on invoices accompanying shellfish.

(4) Use or sell eggs meeting WSDA or USDA standards. The use or sale of ungraded eggs, unpasteurized liquid eggs, except as specified in WAC 246-215-030 (1)(j), or cracked or checked eggs is prohibited.

(5) Use or sell only USDA inspected meat, meat products, poultry, and poultry products. Custom meat facilities defined in RCW 16.49.435 may process or handle uninspected meat for the household user. Custom meat facilities shall not use or sell uninspected meat to the public.

(6) Use or sell game meat:

(a) Processed in a state agriculture inspected processing plant;

(b) Processed in a processing plant with USDA voluntary inspection;

(c) Imported from outside the USA from a country having an approved program of inspection authorized by USDA or FDA; or

(d) Approved by the health officer for use in the following types of institutions:

(i) Jails and correction facilities; and

(ii) Distributing organizations limited to food banks and soup kitchens specified under RCW 69.80.020.

[Statutory Authority: RCW 43.20.050, 92-08-112 (Order 261B), § 246-215-020, filed 4/1/92, effective 5/2/92.]

**WAC 246-215-030 Food protection.** (1) Food service establishment owners shall protect food from potential or actual sources of contamination or adulteration during transporting, storing, preparing, cooking, displaying, and serving by the following methods:

(a) Covering food or food storage containers with tightly fitting covers manufactured from approved materials such as metal, plastic, plastic wrap, or aluminum foil, except:

(i) During necessary preparation or cooling periods;

(ii) When serving food to the customers;

(iii) When displaying or storing fresh, raw, unprocessed whole fruits and vegetables;

(iv) When displaying or storing raw, whole aquatic foods; and

(v) During storage, quarters or sides of meat, and primal cuts may be placed on clean sanitized hooks or racks.

(b) Prohibiting the storage of food under leaking refrigeration condensers, exposed or unprotected sewer lines, leaking water lines, or water lines with accumulations of condensed water;

(c) Storing foods above the floor level to prevent contamination and permit easy cleaning, except:

(i) Floor storage is permitted for foods stored in bulk if contained in impervious covered containers;

(ii) Storage on a floor surface is permitted when beverages are in pressurized beverage containers; or foods are protected by glass, durable plastic, cans, or other waterproof containers; and

(A) Floors beneath the foods are dry and easily cleanable; and

(B) Foods can be easily moved to allow cleaning of the floor.

(d) Prohibiting the storage of food, utensils, or single-service articles in toilet rooms, toilet room vestibules, or garbage rooms;

(e) Labeling foods removed from original containers, unless identity of the food is unmistakable;

(f) Providing protection from contamination through use of a sneeze guard, display case, packaging, or other effective measures;

(g) Minimizing hand contact with foods by:

(i) Using appropriate utensils, including single service food service gloves when practical; and

(ii) Providing tongs, bakery papers, scoops, spatulas, ladles, and similar utensils for handling foods during display or service.

(h) Prohibiting the storage of raw meats, poultry, and aquatic foods above foods requiring no additional cooking before service or in a manner increasing the probability of cross-contamination;

(i) Prohibiting the use of ice for human consumption following use for cold holding or after contamination; or

(j) Prohibiting use of pooled eggs prepared from raw eggs, except:

(i) If used for immediate service; or

(ii) If cooked to 140° F. or above within thirty minutes of breaking.

(k) Prohibiting egg breaking procedures where liquid eggs contact egg shells such as egg breaking machines;

(l) By any other methods approved by the health officer.

(2) In emergency situations when an imminent or actual health hazard exists, the owner or person in charge of a food service establishment shall take appropriate action to prevent adulteration of foods, including the following:

(a) Protecting foods from contamination;

(b) Ensuring proper temperature controls;

(c) Notifying the health officer; and

(d) Destroying contaminated, adulterated, or temperature abused foods after consultation with the health officer.

(3) Food service establishment owners shall:

(a) Prohibit application of sulfiting agents in the food service establishment;

(b) Prohibit the storage of sulfiting agents on the premises unless in packaged form, clearly labeled, and offered for retail sale; and

(c) Allow sulfiting agents only if contained within properly labeled commercially processed foods.

(4) When owners of food service establishments store or display mollusks in live holding systems, they shall protect the mollusks from contamination by:

(a) Requiring an approved source for seawater placed in the system; or

(b) Using a commercial mix for artificial seawater mixed with potable drinking water; and

(c) Completely separating mollusks from crustaceans or fish.

(5) Owners of food service establishments specified in WAC 246-215-020 (6)(d) shall establish control measures for the use of game meat. These control measures designed to prevent illness and approved by the health officer include:

(a) Requiring adequate facilities for butchering and processing;

(b) Designation of a person in charge who is responsible for:

(i) Record keeping of all game meat received and used;

(ii) Insuring separation of raw game meat from all other foods;

(iii) Adequate cooking of all game meat to 165° F. or above; and

(iv) Maintenance of temperature monitoring and control.

(c) Compliance with all other parts of this chapter, unless specified otherwise.

(6) Game meat, except sources specified in WAC 246-215-020 (6)(a), (b), and (c), may only be possessed, handled, and processed by retail food stores:

(a) When approved by the health officer;

(b) For hunters who bring their game meat to the retail store and receive the same game meat back after the completion of processing;

(c) So contamination is avoided by separating raw game meat from all other foods; and

(d) When all processing of game meat occurs at a separate time than processing of all other meat or meat products.

(7) Owners of food service establishments may sell or serve mold cultured cheeses. The sale or service of moldy cheese is prohibited unless the cheese is reconditioned by removing the mold in the following manner:

(a) If the cheese has been held under refrigeration, a one-half inch layer is removed and the moldy portions are discarded;

(b) If the cheese has been held at ambient temperatures, a one inch layer is removed and the moldy portions are discarded;

(c) The cutting is performed so that mold contamination of the new surfaces is minimized; and

(d) When cheese has high moisture content such as brie, camembert, cream cheese, or cottage cheese, or where mold filaments have deeply penetrated the surface, the entire cheese shall be discarded.

[Statutory Authority: RCW 43.20.050. 92-08-112 (Order 261B), § 246-215-030, filed 4/1/92, effective 5/2/92.]

**WAC 246-215-040 Public health labeling.** (1) Food service establishment owners shall label all food products offered for sale if enclosed in a package or container; except:

(a) Food products produced on-site;

(b) Nonpotentially hazardous bakery products from approved sources; or

(c) Single service portions or other packaged foods which are shipped to the food service establishment enclosed within a properly labeled master carton.

(2) Food service establishment owners shall label modified atmosphere packaged foods in compliance with WAC 246-215-060.

(3) Food service establishment owners shall ensure labels include:

(a) The common name of the food;

(b) All ingredients, including food additives, in descending order of predominance;

(c) The name, city, state, and zip code of the manufacturer; and

(d) A packaging date code, when required by law or when the food is potentially hazardous.

(4) Food service establishment owners shall ensure information contained on labels is:

- (a) Accurate;
- (b) Easily readable; and
- (c) In the English language, except that duplicate labeling in foreign languages is allowed.

(5) When labels, menus, or other printed or graphic materials are inaccurate or misleading and a report of illness or injury is associated with the food product, the health officer may:

- (a) Stop sale of the product until correctly labeled;
- (b) Require relabeling of the product; and
- (c) Issue public health advisories.

(6) Whenever raw milk or raw milk cheese or similar raw milk products are offered for sale in a food service establishment, the health officer shall:

(a) Require conspicuous labeling of raw milk or products containing raw milk as "raw milk" or "contains raw milk";

(b) Require conspicuous posting of signs near the product that state: "Warning: Raw milk or foods prepared from raw milk, such as unripened or fresh cheese, may be contaminated with dangerous bacteria capable of causing severe intestinal illnesses. Contact your local health department for advice or to report a suspected illness";

(c) Exempt properly fermented raw milk cheeses from the labeling requirements contained in this subsection, provided the cheeses are produced using a flash heating process and they meet the following cheese composition requirements:

- (i) Moisture content of 40% or less;
- (ii) Saline-in-moisture content of 3.75% or greater;
- (iii) Water activity (Aw) of 0.96 or less; and
- (iv) pH of 5.40 or less.

(7) Food service establishment owners shall label packaged or bulk foods containing sulfiting agents at detectable levels as follows:

(a) Accept accurate labels placed on packaged foods by the manufacturer;

(b) Place a label on prepackaged foods stating, "This food contains a sulfiting agent";

(c) Place a sign or label on the bulk food container or in a conspicuous place nearby stating, "The following food or foods contain a sulfiting agent, . . . . .";

(d) Except these foods may be sold without labeling:

- (i) Wine by the glass;
- (ii) Salad bars; and

(iii) Delicatessens and similar take-out food facilities when food is prepared on-site.

(8) Food service establishment owners shall provide prominent and conspicuous labels on bulk food display units with at least one of the following:

(a) Manufacturer's or processor's container label plainly in view;

(b) A card, sign, or other appropriate device stating the common name of the food; or

(c) A list of ingredients and any food additives contained in the product.

(9) Food service establishment owners shall ensure accurate labels are present on bulk containers of chemicals and pet foods.

(10) When raw or undercooked meats, eggs, or aquatic foods are offered for immediate service or for sale as ready-to-eat, the health officer shall require these foods to be identified, as such:

- (a) On the menu;
- (b) On the label; or
- (c) On a sign clearly visible to the patrons.

(11) The health officer may approve alternate wording on signs required in subsections (6) and (7) of this section.

[Statutory Authority: RCW 43.20.050. 92-08-112 (Order 261B), § 246-215-040, filed 4/1/92, effective 5/2/92.]

**WAC 246-215-050 Food preparation.** (1) The health officer may require a food service establishment owner to limit or modify food preparation and may delete some menu items when the available equipment is inadequate to rapidly cool or reheat, properly cook, hot hold, cold hold, or process potentially hazardous foods.

(2) Food service establishment owners shall prepare, display, serve, and transport food:

- (a) Only with safe and necessary time-temperature steps;
- (b) With a minimum amount of hand contact;
- (c) With suitable utensils;
- (d) On clean, sanitized surfaces:

(i) Washed, rinsed, and sanitized as required under this chapter prior to use; and

(ii) Washed, rinsed, and sanitized to prevent cross-contamination.

(3) Food service establishment owners shall:

(a) Maintain the internal temperature of potentially hazardous food at 45° F. or below, or 140° F. or above, at all times except as provided in these regulations;

(b) Minimize the time potentially hazardous foods remain at room temperature during preparation to a total time of two hours;

(c) Store in-use serving utensils:

(i) In the food product, only if the handle remains out of the food item; except in ice machines;

(ii) In a running water dipper well;

(iii) In water above 140° F., or below 45° F.;

(iv) For ice machines, either on a clean dry surface or in an approved utensil holder; or

(v) By other approved methods;

(vi) Except that in-use serving utensils for nonpotentially hazardous foods may be stored on a clean surface.

(d) Discard any leftover foods already served to a customer; except that packaged, nonpotentially hazardous foods which are still packaged in a sound and sanitary condition, may be re-served. Properly dispensed, nonpotentially hazardous foods such as those dispensed by using squeeze dispensers, covered containers with proper serving utensils, or shaker dispensers, may be re-served.

(e) Ensure all foods served raw are thoroughly washed with potable water before serving;

(f) Prepare potentially hazardous salads and sandwich spread using cold ingredients prechilled to 45° F. or below;

(g) Ensure potentially hazardous foods transported or stored in ice are prechilled to 45° F. or below.

[Statutory Authority: RCW 43.20.050. 92-08-112 (Order 261B), § 246-215-050, filed 4/1/92, effective 5/2/92.]

**WAC 246-215-060 Modified atmosphere packaging.**

(1) Modified atmosphere packaging of foods in food service establishments is permitted by the health officer for the following:

- (a) Nonpotentially hazardous foods;
  - (b) Raw meat;
  - (c) Natural hard or semi-soft cheeses containing live starter culture organisms; and
  - (d) Foods which are rapidly frozen and are stored frozen until reheated or thawed for immediate service. Foods frozen under this subsection shall meet all of the following continuous cooling and freezing requirements:
    - (i) Cooling foods from 140° F. to 70° F. or below within two hours;
    - (ii) Cooling foods from 140° F. to 45° F. or below within four hours;
    - (iii) Cooling foods to below 38° F. within twelve hours; and
    - (iv) Freezing foods completely to below 10° F. within twenty-four hours.
- (2) Food service establishment owners shall not perform modified atmosphere packaging on the premises for any foods unless allowed under subsection (1) of this section; except

(3) The health officer may allow additional foods to be modified atmosphere packaged only if an approved HACCP based procedure which controls the growth of bacterial pathogens is in place. Acceptable controls would be:

- (a) Maintaining water activity below 0.93;
- (b) Maintaining pH below 4.6;
- (c) Using processed meats or meat products, poultry, or poultry products produced in a plant regulated by USDA and received in an intact package before modified atmosphere packaging;
- (d) Properly curing the food on site using a standard recipe approved by the health officer with an initial sodium nitrite concentration of 120 ppm and 3.5% salt concentration; or

(e) Properly processing uncured meats or poultry on-site by monitoring critical control points established in the HACCP plan specified in subsection (4)(e) of this section.

(4) Whenever foods are modified atmosphere packaged under subsection (3) of this section, the health officer shall require all of the following:

- (a) Store the food at 38° F. or below;
- (b) Sell the food within fourteen days of packaging;
- (c) Prohibit exceeding the original processor's shelf life, if applicable;
- (d) Establish critical control points during processing, packaging, and storage;
- (e) Monitor critical control points established in (d) of this subsection by any or all of the following:
  - (i) Routine laboratory testing;
  - (ii) Measuring refrigerated storage temperatures;
  - (iii) Measuring temperatures during smoking or cooking processes;
  - (iv) Providing other information requested by the health officer; and
- (f) Maintain accurate records of critical control point monitoring specified in (e) of this subsection, for examination by the health officer;
- (g) Attach the following labels:

(i) "Keep refrigerated at 38° F. or below and use within seven days of purchase, unless frozen"; and

(ii) "Sell by month/day/year" with the date established within fourteen days of packaging.

(5) Modified atmosphere packaging of aquatic foods, including fish, is prohibited by the health officer except under subsections (1)(d), (3)(a), (b), or (d) of this section.

(6) The food service establishment owner shall designate a person in charge of all modified atmosphere packaging operations to be responsible for control measures contained in subsections (4) and (9) of this section.

(7) Modified atmosphere packaged foods packaged in USDA or FDA regulated plants and maintained in intact packages are exempted by the health officer from meeting labeling requirements contained in subsection (4)(g) of this section.

(8) The food service establishment owner shall destroy modified atmosphere packaged foods which have exceeded the requirement for foods to be sold within fourteen days of packaging (contained in subsection (4)(b) of this section), except until that date modified atmosphere packaged foods may be:

- (a) Frozen; or
- (b) Removed from the packaging and used in the food service establishment.

(9) Modified atmosphere packaged foods which have exceeded the requirement for foods to be sold within fourteen days of packaging (contained in subsection (4)(b) of this section) are prohibited by the health officer from sale.

[Statutory Authority: RCW 43.20.050, 92-08-112 (Order 261B), § 246-215-060, filed 4/1/92, effective 5/2/92.]

**WAC 246-215-070 Temperature control.** (1) The food service establishment owner shall:

(a) Provide metal, stem-type, numerically scaled food thermometers accurate to within 2° F. in the appropriate range for the foods being tested;

(b) Ensure thermometers are checked for accuracy;

(c) Be allowed to use digital thermometers or thermocouples to measure temperatures as long as they are accurate to within 2° F. and are capable of measuring all food temperatures contained in (e) of this subsection;

(d) Equip each refrigeration unit with a numerically scaled thermometer accurate to within 3° F. located:

(i) To be easily readable; and

(ii) In the warmest part of the unit.

(e) Ensure food service workers use thermometers to measure food temperatures to attain and maintain safety for potentially hazardous foods during:

(i) Cooking;

(ii) Reheating;

(iii) Hot holding;

(iv) Cooling; and

(v) Cold holding.

(2) Food service workers shall safely thaw potentially hazardous foods:

(a) In refrigeration units at a temperature of 45° F. or less;

(b) Under potable running water of a temperature of 70° F. or less with sufficient water velocity to agitate and float loose food particles into the overflow; or



(c) In an approved cooking unit as part of a continuous cooking process, only when the food depths or thickness for solid foods is less than four inches.

(3) Food service workers shall safely cook all parts of potentially hazardous foods requiring cooking to the following minimum internal temperatures:

(a) 165° F. or above for:

- (i) Poultry or any food containing poultry;
- (ii) Stuffed meats or stuffing containing meats; and
- (iii) Casseroles containing potentially hazardous foods.

(b) 155° F. or above for ground, fabricated, or restructured meats; except that ground beef may be cooked to lower temperatures if specifically ordered by the immediate consumer;

(c) 150° F. or above for pork or any food containing pork;

(d) 130° F. or above for:

- (i) Rare roast beef; and
- (ii) Rare beef steak, except that beef steak may be cooked to a lower temperature if specifically ordered by the immediate consumer.

(e) 140° F. or above for eggs and foods containing uncooked eggs, unless specifically ordered by the immediate consumer otherwise, except:

(i) Health care facilities such as nursing homes and hospitals shall only use pasteurized eggs or eggs cooked to 140° F. or above unless a physician's statement allows otherwise; and

(ii) Traditionally uncooked or undercooked eggs when used to prepare foods such as eggs benedict, caesar salad, meringue, or hollandaise sauce shall be:

- (A) Prepared for immediate service to the customer;
- (B) Rapidly cooled and held at 45° F. or less; or
- (C) Held hot at 140° F. or above.

(f) 140° F. or above for all other potentially hazardous foods except as specified under (a) through (e) of this subsection;

(g) Except that potentially hazardous foods that have been partially cooked or blanched shall be cooled rapidly using procedures contained in subsection (6) of this section and reheated before service as described in subsection (8) of this section.

(4) Food service establishment owners are prohibited from overnight cooking without temperature monitoring.

(5) Food service workers shall ensure potentially hazardous foods, after initial cooking or reheating, are held hot at or above the following temperatures:

- (a) 130° F. for unsliced rare roast beef; or
- (b) 140° F. for all other potentially hazardous foods;
- (c) Except that overnight hot holding without temperature monitoring is prohibited.

(6) When potentially hazardous foods require cooling or cold holding after preparation, rapid methods of cooling from 140° F. to 45° F. shall be used. Food service workers shall use methods including:

(a) Reducing very viscous foods such as refried beans, chowders, and gravies to a thickness of two inches or less and:

- (i) Placing immediately in a refrigerator or in a freezer; and
- (ii) Leaving uncovered until cooled to 45° F. or below, while protecting the food from cross-contamination.

(b) Reducing foods not listed in subsection (6)(a) of this section to a thickness of four inches or less and:

(i) Placing immediately in a refrigerator or freezer; and

(ii) Leaving uncovered until cooled to 45° F. or below, while protecting the food from cross-contamination.

(c) Placing liquid foods deeper than four inches into an ice and water bath provided:

- (i) The container is immersed to the depth of the food;
- (ii) Ice is replaced as it melts;
- (iii) The food is frequently stirred;
- (iv) A metal stem thermometer is used; and
- (v) The food is refrigerated or frozen once cooled to 45° F.

(d) Using other methods for rapid cooling approved by the health officer, provided the food is cooled from 140° F. to 45° F. or below within four hours.

(7) Food service workers shall ensure potentially hazardous foods requiring cold holding are kept at 45° F. or below by:

(a) Using mechanical refrigeration;

(b) Storing in ice provided:

- (i) The food is prechilled to 45° F. or below;
- (ii) The container is placed in ice to the height of the food;
- (iii) Ice is replaced as it melts; and
- (iv) Melt water is frequently drained.

(c) Using refreezable ice or similar products with prior approval by the health officer;

(d) Except cold holding temperatures required for commercially prepared modified atmosphere processed aquatic foods are 38° F. or below.

(8) Food service workers shall ensure potentially hazardous foods previously cooked and cooled are rapidly reheated from 45° F.:

(a) With no interruption in the reheating process;

(b) In one hour or less;

(c) To the following minimum temperatures:

(i) 165° F. for foods prepared in any food service establishment; or

(ii) 140° F. for foods prepared in any food processing establishment under jurisdiction of USDA or FDA only for initial reheating.

(d) In equipment designed to meet the performance standards provided in this subsection; and

(e) With frequent stirring for liquid or semi-solid potentially hazardous foods.

(9) Food service workers may reheat completely cooked potentially hazardous foods with no minimum reheating temperature only if they are:

(a) Served either hot or cold; and

(b) Reheated to order in individual portions when ordered by the consumer.

[Statutory Authority: RCW 43.20.050. 92-08-112 (Order 261B), § 246-215-070, filed 4/1/92, effective 5/2/92.]

**WAC 246-215-080 Personal hygiene.** (1) Food service workers shall wash their hands, including fingernails, in an approved handwashing facility by applying soap, using warm water, scrubbing thoroughly, rinsing, and then drying, using methods which prevent recontamination:

- (a) Before starting work; and

(b) During work, as often as necessary to prevent contamination of foods:

- (i) After using the toilet;
- (ii) After handling raw meat, poultry, or aquatic foods;
- (iii) After handling unclean items;
- (iv) After eating or smoking; and
- (v) Before preparing ready-to-eat foods.

(2) Food service workers shall:

- (a) Wear clean outer garments;
- (b) Maintain a high degree of personal cleanliness; and
- (c) Restrain hair as necessary.

(3) The food service establishment owner shall ensure bactericidal and viricidal hand rinses are used only in addition to approved handwashing methods.

(4) The food service establishment owner shall ensure eating or use of tobacco in any form by food service workers is permitted only in designated areas approved by the health officer.

(5) The food service establishment owner shall provide adequate facilities for the orderly storage of food workers' clothing and personal belongings.

(6) The person in charge of the food service establishment shall ensure all food service workers:

(a) Comply with the provisions of chapter 69.06 RCW and chapter 246-217 WAC;

(b) Obtain valid food and beverage service worker permits within thirty days of employment; and

(c) Maintain current food and beverage service worker permits.

(7) The person in charge of the food service establishment must display or file the food and beverage service workers permits, or copies thereof, where they are available for inspection by the health officer upon request.

[Statutory Authority: RCW 43.20.050. 92-08-112 (Order 261B), § 246-215-080, filed 4/1/92, effective 5/2/92.]

**WAC 246-215-090 Sanitary design, construction, and installation of equipment and utensils.** (1) Food service establishment owners shall use equipment and utensils designed and of such materials and workmanship to be:

- (a) Smooth;
- (b) Easily cleanable;
- (c) Durable;
- (d) In good repair; and
- (e) In conformance with the current standards and listings of the National Sanitation Foundation or equivalent.

(2) Food service establishment owners shall ensure food contact surfaces of equipment and utensils are:

- (a) Made of food grade material;
- (b) Smooth;
- (c) Easily accessible for cleaning;
- (d) Nontoxic;
- (e) Corrosion resistant; and
- (f) Nonabsorbent.

(3) When single service articles are used, the food service establishment owner shall ensure they are:

- (a) Made from clean, sanitary, and safe materials; and
- (b) Prohibited from reuse.

(4) Food service establishment owners shall install and maintain equipment to:

(a) Facilitate cleaning of equipment and adjacent areas; and

(b) Avoid placement under:

- (i) Exposed or unprotected sewer lines;
- (ii) Open stairwells;
- (iii) Unprotected insulation; and
- (iv) Other sources of contamination.

(5) Owners shall ensure food service establishments using equipment or utensils requiring cleaning and sanitizing are equipped with either:

(a) Approved mechanical dishwashing facilities and a sink with a minimum of two compartments in the dishwashing area;

(b) A sink with a minimum of three compartments, a space for soiled utensils ahead of the first compartment, and a drainboard for clean utensils when no mechanical dishwasher is available, or when utensils cannot be cleaned and sanitized in the mechanical dishwasher due to size or configuration; or

(c) A sink with a minimum of two compartments, a space for soiled utensils ahead of the first compartment, and a drainboard for clean utensils when:

(i) Only single service articles are provided for use by the consumer, very minimal utensil washing is needed, and the health officer determines it is consistent with the intent of the regulations; and

(ii) Only single service articles are provided for use by the consumer, only nonpotentially hazardous foods and ingredients are used, and the health officer determines it is consistent with the intent of the regulations.

(6) Food service establishment owners shall provide sink compartments of sufficient size to accommodate the largest utensil.

(7) Food service establishment owners of bars and taverns shall provide a sink compartment for disposing of liquid waste in addition to sinks necessary for cleaning and sanitizing.

(8) Food service establishment owners shall provide sufficient food preparation sinks in which foods may be:

- (a) Washed, soaked, rinsed, or drained;
- (b) Cooled or thawed; or
- (c) Processed in a manner requiring placement in a sink.

(9) Food service establishment owners shall prohibit use of food preparation sinks for:

- (a) Handwashing;
- (b) Utensil washing; and
- (c) Other activities which may contaminate foods.

(10) Food service establishment owners shall provide a mop sink or equivalent fixture capable of supplying and disposing of water for cleaning floors, walls, and other nonfood contact surfaces.

(11) The health officer may exempt food service establishment owners from subsections (5)(a), (7), (8), and (10) of this section when:

(a) A plan review was approved prior to the effective date of these regulations;

(b) The food service establishment was constructed prior to the effective date of these regulations; or

(c) The menu, method of food preparation, and volume of food preparation present no health hazard.

[Statutory Authority: RCW 43.20.050. 92-08-112 (Order 261B), § 246-215-090, filed 4/1/92, effective 5/2/92.]

**WAC 246-215-100 Equipment and utensil cleaning and sanitizing.** (1) The following articles shall be thoroughly washed, rinsed, and sanitized by a food service worker after each use:

- (a) Utensils; and
- (b) Food contact surfaces of equipment, except cooking surfaces.

(2) All utensils and food contact surfaces of equipment used in preparation, service, display, or storage of potentially hazardous food shall be sanitized by a food service worker:

(a) Following any interruption of operations during which contamination of the food contact surfaces may have occurred; and

(b) Whenever contamination has occurred.

(3) When equipment and utensils are used for the preparation of potentially hazardous foods on a continuous or production line basis, the food service establishment owner shall ensure utensils and the food contact surfaces of equipment are washed, rinsed, and sanitized. The health officer, based on food temperatures, type of food, and amount of particle accumulation shall specify the minimum time interval between cleaning operations.

(4) The food service establishment owner shall ensure cleaning and sanitizing of food contact surfaces of equipment and utensils are accomplished by first prescraping or prerinsing and then by either of the following methods:

- (a) Manual dishwashing in proper sequence:
  - (i) Washing in a clean, hot detergent solution;
  - (ii) Rinsing in clean, warm water;
  - (iii) Sanitizing by immersion for at least one minute in:
    - (A) A chemical sanitizing solution at proper concentration as described in C.F.R. 21.178; or
    - (B) A mechanically heated sink at a temperature of at least 170° F.; and
  - (iv) Air drying; or
- (b) Mechanical dishwashing which washes and then sanitizes by:

- (i) A high temperature final rinse with a minimum of 180° F. measured by the gauge;
- (ii) A high temperature final rinse with a minimum of 160° F. measured at the surface of the utensil;
- (iii) An approved concentration of chemical sanitizer as described in C.F.R. 21.178 which is automatically dispensed; or

(iv) A method approved by the health officer consistent with the intent of the regulations.

(5) The food service establishment owner shall ensure cleaned and sanitized equipment, utensils, and single service articles are stored to:

- (a) Protect from all sources of contamination; and
- (b) Minimize unnecessary handling.
- (6) Food service workers shall ensure wiping cloths used for cleaning up food spills or wiping work surfaces, table surfaces, high chairs, equipment, utensils, or foodworkers' hands are:

- (a) Kept in a clean, sanitary condition at all times;
- (b) Moistened with an approved sanitizing solution at all times when in use; and
- (c) Stored in a proper concentration of sanitizing solution between uses.

(7) Food service workers shall be responsible for monitoring sanitizing operations by:

- (a) Checking temperature gauges;
- (b) Measuring chemical concentrations with appropriate methods; or
- (c) Using premeasured sanitizing packages or tablets, following label directions.
- (8) The food service establishment owner shall ensure:
  - (a) Wiping cloths used for removing food spills from tableware such as plates or bowls, are clean, dry, and used for no other purposes;
  - (b) Cooking surfaces of equipment are cleaned at least once daily; and
  - (c) Nonfood contact surfaces of equipment are cleaned at such intervals to keep them clean and in a sanitary condition.

[Statutory Authority: RCW 43.20.050. 92-08-112 (Order 261B), § 246-215-100, filed 4/1/92, effective 5/2/92.]

**WAC 246-215-110 Poisonous or toxic materials.** (1) Food service establishment owners shall allow poisonous or toxic materials on the premises only under the following conditions:

- (a) When necessary and intended for the operation and maintenance of the food service establishment;
- (b) When used to prevent or control pests;
- (c) When used to clean and sanitize equipment, utensils, and work surfaces; or
- (d) When offered for sale in a retail food store, grocery, or similar food service establishment, provided these materials are separated from food and single-service articles by:

- (i) Spacing;
- (ii) Partitioning;
- (iii) Dividers; or
- (iv) Storage below food or single-service articles.

(2) Food service establishment owners shall ensure commercially filled containers of poisonous or toxic materials are labeled in accordance with Environmental Protection Agency regulations. Small containers may be filled or taken from a properly labeled container only when identified with the common name of the material.

(3) Food service establishment owners shall ensure poisonous or toxic materials are stored and used:

- (a) In accordance with the manufacturer's label requirements;
- (b) In a manner preventing adulteration of food and contamination of food contact surfaces, utensils, and single-service articles; and
- (c) So food service workers and other persons are protected from potential health and safety hazards.

(4) Food service establishment owners shall ensure lubricants used on food contact surfaces of equipment are nontoxic.

[Statutory Authority: RCW 43.20.050. 92-08-112 (Order 261B), § 246-215-110, filed 4/1/92, effective 5/2/92.]

**WAC 246-215-120 Sanitary facilities and controls.** (1) Food service establishment owners shall ensure:

- (a) Their water source is:
  - (i) Adequate in quantity and quality;
  - (ii) Supplied by a source approved under chapter 246-290 WAC (formerly chapter 248-54 WAC); and

(iii) Monitored according to standards established by the health officer.

- (b) Use of bottled water from an approved source; and
- (c) Ice used for any purpose is:

- (i) Made from an approved water source; and

- (ii) Manufactured, stored, transported, and handled in a sanitary manner.

(2) Food service establishment owners shall dispose of all liquid waste including gray water, mop water, and ice melt:

- (a) Into a public sewer system;

- (b) Into an approved on-site sewage disposal system; or

- (c) In another manner approved by the health officer.

(3) Food service establishment owners shall ensure plumbing is:

- (a) Sized, installed, and maintained in accordance with applicable state and local plumbing codes;

- (b) Free of cross connections between potable water supplies and:

- (i) Nonpotable or questionable sources of water; or

- (ii) Chemical feed lines or similar devices.

- (c) Indirectly drained from ice machines, food preparation sinks, beverage ice sinks, salad bars, dipper wells, and mechanical dishwashers, into:

- (i) A floor sink;

- (ii) Hub drain; or

- (iii) A similar device.

(4) Food service establishment owners shall install a properly vented dual check valve device or an approved reduced pressure backflow assembly between copper pipe or tubing and carbonated beverage dispensing machines. Carbonated beverage dispensing machines installed before the effective date of these regulations are exempt from this requirement.

(5) Food service establishment owners shall ensure toilets for food workers are:

- (a) Provided within the food service establishment; or

- (b) Convenient to food workers and within two hundred feet of the food service establishment.

(6) Food service establishment owners shall ensure toilet facilities for patrons are provided within, or convenient to, the food service establishment when:

- (a) Customer seating for on-premises consumption of food or drink is provided; and

- (b) The food service establishment was constructed or extensively remodeled after the effective date of these regulations.

(7) Toilet facilities may be used jointly by patrons and food service workers, provided patrons accessing the facility are excluded from food preparation and storage areas.

(8) Food service establishment owners shall ensure all toilet facilities are:

- (a) Of sanitary design;

- (b) Kept clean;

- (c) In good repair;

- (d) Provided with toilet paper; and

- (e) Provided with easily cleanable waste storage receptacles.

(9) Food service establishment owners shall ensure hand sinks are:

- (a) Accessible to food workers at all times;

- (b) Located to permit convenient use by all food workers in food preparation, food service, and utensil washing areas and in, or immediately adjacent to, toilet facilities; and

- (c) Used exclusively for hand washing.

(10) Food service establishment owners shall be responsible for maintenance of hand sinks designated for use by food service workers and patrons and ensure each hand sink is:

- (a) Provided with hot, at a minimum temperature of 100° F., and cold running water provided through a mixing faucet;

- (b) Provided with hand soap;

- (c) Provided with single use towels or other hand drying devices approved by the health officer; and

- (d) Kept clean and in good repair.

(11) Food service establishment owners shall ensure hand operated automatic faucets have a minimum cycle of fifteen seconds.

[Statutory Authority: RCW 43.20.050. 92-08-112 (Order 261B), § 246-215-120, filed 4/1/92, effective 5/2/92.]

#### **WAC 246-215-130 Garbage, rubbish, and litter.**

The food service establishment owner shall:

(1) Properly store and dispose of all garbage, rubbish, and litter in and around a food service establishment. Storage prior to disposal shall be in containers that are:

- (a) Durable;

- (b) Easily cleanable;

- (c) Insect and rodent proof;

- (d) Nonabsorbent;

- (e) In sound condition;

- (f) Watertight; and

- (g) Kept covered with tight fitting lids except when stored in a closed, pest-proof room or enclosure.

(2) Dispose of liquid wastes as waste water when collected from:

- (a) Leaking garbage containers;

- (b) Garbage compacting operations; or

- (c) Cleaning operations.

(3) Store all other rubbish in containers or other areas in a manner approved by the health officer.

(4) Use rooms, enclosures, areas, and containers adequate in size and number for garbage storage.

(5) Prevent overflows and nuisances caused by garbage, rubbish, and litter by:

- (a) Ensuring frequent disposal;

- (b) Providing adequate cleaning facilities; and

- (c) Ensuring that containers, rooms, and areas are cleaned as needed.

[Statutory Authority: RCW 43.20.050. 92-08-112 (Order 261B), § 246-215-130, filed 4/1/92, effective 5/2/92.]

**WAC 246-215-140 Pests and pest control.** Food service establishment owners shall:

(1) Take effective measures to minimize:

- (a) Entry of pests such as rodents and insects; and

- (b) Presence of pests.

(2) Ensure the premises are kept in such condition to prevent:

- (a) Harborage of pests; and

- (b) Feeding of pests.
- (3) Ensure only pesticides labeled for use in food service areas are stored on the premises or used to eliminate or control pests.
  - (4) Ensure pesticides are stored:
    - (a) In cabinets;
    - (b) In a physically separate place used for no other purpose; and
    - (c) Below or separate from food, food equipment, utensils, or single service articles.
  - (5) Ensure that pesticides are applied:
    - (a) In accordance with label directions; and
    - (b) In compliance with Washington state department of agriculture rules located in chapter 16-228 WAC, pesticide regulations, to prevent adulteration of foods and contamination of food contact surfaces.
  - (6) Employ the services of a licensed pest control operator when the health officer determines:
    - (a) Measures taken by the owner of the food service establishment are ineffective; or
    - (b) Pest problems are severe and extend beyond the property boundaries controlled by the food service establishment owner.
  - (7) Ensure that automatic dispensing aerosol units, if used, are:
    - (a) Prohibited in all areas where food is prepared or served; and
    - (b) Installed and used only in areas outside the influence area of ventilation systems and at least twenty feet away from any:
      - (i) Food storage area;
      - (ii) Food preparation or service area;
      - (iii) Unprotected food contact surfaces; and
      - (iv) Utensil washing or storage area.

[Statutory Authority: RCW 43.20.050. 92-08-112 (Order 261B), § 246-215-140, filed 4/1/92, effective 5/2/92.]

**WAC 246-215-150 Construction and maintenance of physical facilities.** Food service establishment owners shall:

- (1) Ensure floors and floor coverings in all areas are:
  - (a) Constructed of easily cleanable materials;
  - (b) Kept clean;
  - (c) In good repair; and
  - (d) Coved at the floor/wall junctures, except for carpeted areas.
- (2) Provide proper construction of floors and floor coverings with the following characteristics:
  - (a) Water impervious construction;
  - (b) Grease resistance;
  - (c) Durability; and
  - (d) Drains provided when water or pressure spray methods of cleaning are used, in any of the following areas:
    - (i) Food preparation areas;
    - (ii) Food and utensil storage areas;
    - (iii) Utensil washing areas;
    - (iv) Walk-in refrigerators;
    - (v) Dressing rooms or locker rooms with shower facilities; and
    - (vi) Bathrooms where toilets or urinals are located.

(3) Ensure walls, windows, doors, and ceilings in all areas are clean and in good repair.

(4) Ensure that walls are constructed, in addition to requirements in subsection (3) of this section, with the following characteristics:

- (a) Smooth finish;
- (b) Nonabsorbent surfaces; and
- (c) Construction with easily cleanable materials in the following areas:
  - (i) Walk-in refrigerators and freezers;
  - (ii) Food preparation areas;
  - (iii) Utensil washing areas;
  - (iv) Dressing rooms or locker rooms with shower facilities; and

(v) Bathrooms.

(5) Provide:

(a) Lighting of at least thirty foot candles in the following:

- (i) Areas where food is prepared or stored;
- (ii) Areas where utensils are washed;
- (iii) Areas where hands are washed;
- (iv) In bathrooms; and
- (v) When cleaning is occurring.

(b) Proper shields or guards for lights in the food preparation and storage areas.

(6) Ensure design, installation, and maintenance of ventilation systems in accordance with applicable state and local mechanical and fire codes; and

(a) Provide ventilation systems, when necessary, to keep all areas free of excessive:

- (i) Heat;
- (ii) Steam;
- (iii) Condensation;
- (iv) Fumes and vapors;
- (v) Obnoxious odors; and
- (vi) Smoke.

(b) Design and maintain ventilation hoods and filters to:

- (i) Prevent grease and condensate from dripping into food or onto food contact surfaces; and

(ii) Allow ready removal of filters for cleaning and replacement.

(7) Maintain the premises by:

(a) Allowing only articles necessary for operation and maintenance of the food service establishment to be stored there;

(b) Prohibiting use of any room in the food service establishment as living or sleeping quarters:

- (i) Except when separated from all food service operations by complete partitions and solid doors; and
- (ii) Except for bed and breakfasts.

(c) Allowing live animals only under the following conditions:

(i) Fish, crustacea, and shellfish for food purposes in aquariums;

(ii) Fish in aquariums for display or decor;

(iii) Patrol dogs accompanying security or police officers; or

(iv) Guide dogs or service dogs, as defined under chapter 70.84 RCW, are allowed to accompany a blind, visually handicapped, hearing impaired, or otherwise physically disabled person in all areas of a food service establishment except in food preparation areas.

(d) Allowing only food service workers or other persons authorized by the health officer in food preparation and storage areas.

[Statutory Authority: RCW 43.20.050. 92-08-112 (Order 261B), § 246-215-150, filed 4/1/92, effective 5/2/92.]

**WAC 246-215-160 Mobile food units.** (1) The owner of a mobile food unit shall comply with the requirements of this chapter, except as allowed in this section.

(2) The health officer may impose additional requirements to protect against health hazards related to the operation of a mobile food unit and may:

- (a) Limit the food preparation steps;
- (b) Restrict the mode of operation when facilities or equipment are inadequate to protect public health; or
- (c) Prohibit some menu items; and
- (d) When no imminent health hazard will result, may waive or modify requirements of this chapter.

(3) The person in charge of the mobile food unit shall ensure:

- (a) All foods, including ice, are from an approved source or commissary; and
- (b) All prepackaged foods are properly labeled, except when prepared in and sold from the same mobile food unit.

(4) The person in charge of the mobile food unit shall ensure proper temperature control of potentially hazardous foods on the unit by:

- (a) Prohibiting cooling of potentially hazardous foods or ingredients;
- (b) Allowing only potentially hazardous foods that have been cooked and cooled in an approved commissary to be reheated in individual portions for immediate service;
- (c) Allowing only foods processed in commercial food processing plants to be reheated from 45° F. to 140° F. or above within one hour when reheated at the commissary or when reheated on the mobile unit after leaving the commissary.

(d) Prohibiting cooking of raw meats greater than one inch in thickness;

(e) Preheating hot holding equipment and prechilling cold holding equipment before loading potentially hazardous food onto the mobile unit; and

(f) Monitoring temperatures of potentially hazardous foods with a thermometer.

(5) The person in charge of the mobile food unit shall ensure:

(a) Preparation steps for potentially hazardous foods are minimized to decrease risk of foodborne illness;

(b) Facilities are adequate for all food preparation steps on the mobile unit; and

(c) Daily preparation of potentially hazardous foods prepared on the mobile unit.

(6) The owner of a mobile food unit shall:

(a) Allow only food service workers and persons authorized by the health officer to be present in the mobile food unit; and

(b) Ensure that all food service workers in the mobile food unit have current food and beverage service workers permits, unless all foods are prepackaged and nonpotentially hazardous.

(7) The owner of a mobile food unit shall ensure cold holding of potentially hazardous foods is accomplished by use of:

(a) Mechanical refrigeration; or

(b) Ice, when all food is prechilled and packaged in sealed containers.

(8) The owner of a mobile food unit shall only provide single service articles for use by the consumer.

(9) When a mobile food unit has a water supply:

(a) The source and system design shall be approved by the health officer;

(b) The capacity of the system shall be sufficient to furnish enough hot and cold water for each of the following procedures if they occur on the mobile food unit:

- (i) Food preparation;
- (ii) Utensil cleaning;
- (iii) Sanitizing;
- (iv) Handwashing; and
- (v) Facility cleaning.

(10) The owner of a mobile food unit with a water system shall ensure:

(a) All liquid waste is stored in a wastewater retention tank with at least fifteen percent more capacity than the water tank; and

(b) Wastewater is retained on the mobile food unit until disposed of by a method approved by the health officer.

(11) The owner of a mobile food unit shall provide:

(a) A three-compartment sink with hot and cold running water to wash, rinse, and sanitize utensils when equipment or utensils are reused on the mobile food unit; except

(b) This requirement may be waived or modified by the health officer when:

- (i) Limited food preparation occurs; or
- (ii) Additional clean utensils are available and utensil washing can take place at an approved base of operation.

(12) The person in charge of the mobile food unit shall provide a separate handwashing facility for food workers consisting of:

- (a) A sink with potable, warm, running water;
- (b) Soap; and
- (c) Paper towels.

(13) Food workers may use a three-compartment utensil washing sink for handwashing if:

(a) The mobile food unit owner locates it in the food preparation area; and

(b) The health officer determines that periodic handwashing will not interfere with washing of utensils.

(14) When only prepackaged food items are served, the health officer may waive or modify requirements for handwashing.

(15) The person in charge of the mobile food unit shall ensure toilet facilities for food workers are available and readily accessible within two hundred feet of the unit during operation.

(16) The owner of a mobile food unit or permit applicant shall submit properly prepared plans and specifications of the mobile food unit, base of operation, and/or commissary to the health officer for approval before:

- (a) Construction or remodeling begins;
- (b) The menu of the mobile food unit is changed; or
- (c) The method of food preparation is changed.



(17) The owner or permit applicant shall include in the plan:

- (a) Menu and food preparation steps;
  - (b) Floor plan;
  - (c) Equipment specifications and location;
  - (d) Finish schedule;
  - (e) Proposed itinerary or sites to be served;
  - (f) Source of water and specifications of the on-board plumbing;
  - (g) Site used for sewage disposal;
  - (h) Availability of restrooms for food service workers;
- and
- (i) Base of operation or commissary.

(18) The permit applicant shall obtain approval from the department of labor and industries, if necessary.

[Statutory Authority: RCW 43.20.050. 92-08-112 (Order 261B), § 246-215-160, filed 4/1/92, effective 5/2/92.]

**WAC 246-215-170 Customer self-service of food and bulk food dispensing.** (1) Food service establishment owners shall protect foods from adulteration and contamination during customer self-service by:

(a) Designating a person to be responsible for the customer self-service area. This person shall:

(i) Monitor the customer self-service and bulk food areas to prevent tampering and contamination of foods;

(ii) Ensure adequate temperature control of potentially hazardous foods by:

(A) Cooking, reheating, or prechilling foods before offering for sale;

(B) Monitoring food temperatures with a metal stem thermometer; and

(C) Correcting improper storage practices.

(iii) Clean up any spills that occur and rotate stock;

(iv) Clean and sanitize storage containers and utensils used for food storage or handling of foods; and

(v) Dispose of any bulk foods returned to the food service establishment or contaminated by customers.

(b) Separating all bulk food display units from any containers of chemicals which might contaminate bulk foods and from pet foods by approved methods including one of the following:

(i) Horizontal separation, different aisles, or partitions between bulk foods and chemicals or pet foods; or

(ii) Vertical separation with chemicals or pet foods stored below bulk foods.

(c) Storing and dispensing all foods on display for customer self-service or bulk foods by one of the following:

(i) Gravity dispensing units;

(ii) Display units or storage containers with covers or lids; or

(iii) Foods on display while being held hot or cold shall be protected with a properly designed sneeze guard, display case, or easily movable cover.

(2) Food service workers shall utilize:

(a) Proper utensils when required in this section using the following:

(i) Properly designed and cleaned scoops, spatulas, tongs, and similar dispensing utensils present in or on each display unit;

(ii) In-use serving utensils stored in the food with the handles extending out of the food; or

(iii) Dispensing utensils stored clean and dry between uses in a protective enclosure or utensil holder.

(b) Containers for display of ready-to-eat foods with the lowest access point at least thirty inches above floor level, except for:

(i) Raw fruits and vegetables;

(ii) Honey;

(iii) Oil; or

(iv) Similar liquids as approved by the health officer.

[Statutory Authority: RCW 43.20.050. 92-08-112 (Order 261B), § 246-215-170, filed 4/1/92, effective 5/2/92.]

**WAC 246-215-180 Bed and breakfast food service operations.** (1) Owners of bed and breakfast homes and inns shall comply with all food supply, food handling, personal hygiene, food protection, food service establishment maintenance, permitting, and enforcement requirements under WAC 246-215-020, 246-215-030, 246-215-050, 246-215-060, 246-215-070, 246-215-080, 246-215-090, 246-215-100, 246-215-110, 246-215-120, 246-215-130, 246-215-140, 246-215-200, 246-215-210, 246-215-220, 246-215-230, 246-215-240, 246-215-260 and 246-215-300, except as otherwise provided in this section.

(2) The health officer may impose additional requirements to protect against health hazards related to the food service portion of a bed and breakfast operation and when no health hazard will result, may waive or modify requirements of these regulations.

(3) Owners of bed and breakfast homes and inns may prepare foods in their residential kitchen when:

(a) All food service is limited to overnight guests;

(b) Potentially hazardous foods items are prepared for immediate service;

(c) Cooling and/or reheating of potentially hazardous foods prepared on-site is prohibited;

(d) A minimum of a three-compartment sink or a sink together with a homestyle dishwasher with 155° F. water provided by a booster or a sanitizing cycle is available and used;

(e) Food supplies for domestic use are separated from food supplies intended for customer use; and

(f) Children under age ten and pets are kept out of the kitchen during preparation of foods for bed and breakfast guests.

[Statutory Authority: RCW 43.20.050. 92-08-112 (Order 261B), § 246-215-180, filed 4/1/92, effective 5/2/92.]

**WAC 246-215-190 Temporary food service establishments.** (1) The owner of a temporary food service establishment shall comply with the requirements of this chapter, except as allowed in this section.

(2) The health officer may impose additional requirements to protect against health hazards related to the operation of the temporary food service establishment and may:

(a) Limit the preparation steps; or

(b) Prohibit some menu items; and

(c) When no health hazard will result, waive or modify requirements of this chapter.

(3) The owner of a temporary food service establishment shall ensure proper time/temperature control by:

(a) Prohibiting cooling of potentially hazardous foods at temporary food service establishments, except potentially hazardous foods may be cooled before an event if:

(i) The food product that was cooled will be served cold; or

(ii) Individual portions of the food are reheated for immediate service;

(iii) The food was cooled in an approved facility with adequate cooling capacity and cold holding facilities; and

(iv) Cooling procedures meet requirements contained in WAC 246-215-070(6).

(b) Ensuring rapid reheating of all potentially hazardous foods from 45° F. to a minimum temperature of 165° F. within thirty minutes, except when individual portions are reheated for immediate service.

(4) The owner of a temporary food service establishment shall safely prepare foods by:

(a) Providing adequate facilities at the temporary food service establishment for all proposed food preparation steps; and

(b) Ensuring all off-site preparation is done in an approved facility.

(5) The owner of a temporary food service establishment shall:

(a) Apply for a permit to operate a temporary food service establishment, as far in advance as possible, to allow adequate time for review by the health officer;

(b) Require the person in charge of the temporary food service establishment to obtain a valid food and beverage service worker permit before beginning work;

(c) Allow only food service workers and other persons authorized by the health officer to be present in a temporary food service establishment;

(d) Require the use of only single service articles for use by consumers;

(e) Separate grills and barbecues from public access by using ropes or other approved methods; and

(f) Construct booths to minimize:

(i) Public access;

(ii) Dust;

(iii) Mud; and

(iv) Overhead contamination.

(6) The owner of a temporary food service establishment shall provide:

(a) Approved hand washing facilities for food workers at the temporary food service establishment with:

(i) Clean, warm, running water;

(ii) Soap; and

(iii) Paper towels.

(b) Readily accessible and available toilet facilities within two hundred feet of the temporary food service establishment; and

(c) Access within two hundred feet to a three compartment sink with running water to wash, rinse, and sanitize utensils when:

(i) Equipment or utensils are reused on-site; or

(ii) The temporary food service establishment operates for two or more consecutive days;

(iii) Except the health officer may approve an alternative utensil cleaning method when three compartment sinks are not available and no health hazard will exist.

(7) The health officer may allow handwashing in a three compartment utensil washing sink only if:

(a) The sink is located in the food preparation area; and

(b) Periodic handwashing will not interfere with washing of utensils.

[Statutory Authority: RCW 43.20.050. 92-08-112 (Order 261B), § 246-215-190, filed 4/1/92, effective 5/2/92.]

**WAC 246-215-200 Permits required, suspension, revocation, enforcement.** (1) Any person desiring to operate a food service establishment shall:

(a) Comply with the provisions of these regulations; and

(b) Make written application for a permit on forms provided by the health officer.

(2) Food service establishment owners operating a food service establishment:

(a) Shall possess a valid permit issued to him/her by the health officer;

(b) Shall post the permit conspicuously in the food service establishment;

(c) May be guilty of a misdemeanor pursuant to RCW 70.05.120 and/or local regulations if operating without a valid permit issued by the health officer; and

(d) May be exempt from the permit requirements for the sale of certain foods with prior authorization of the health officer and concurrence of the department.

(3) The health officer may suspend any permit to operate a food service establishment if:

(a) Continued operation of the food service establishment constitutes an imminent or actual health hazard;

(b) Operations, facilities, or equipment in the food service establishment fail to comply with these regulations;

(c) The holder of the permit does not comply with these regulations; or

(d) Interference with the health officer in the performance of his/her duties has occurred.

(4) When the health officer has suspended a food service establishment permit, the person in charge:

(a) Shall immediately cease all food service operations;

(b) Shall be notified in writing by the health officer that the food service establishment permit is immediately suspended upon service of the notice and the suspension shall remain in effect until a hearing with the health officer occurs. If the health officer finds the operation to be in compliance with the requirements of these regulations the suspension will be lifted;

(c) May request a hearing by filing a written request for a hearing with the health officer within ten days of receipt of the notice of suspension; and

(d) Shall be notified, if a written request for a hearing is not filed within ten days, that the suspension is sustained.

(5) Any food service establishment owner whose food service permit has been suspended may at any time make written application for a reinspection for the purpose of reinstatement of the permit. The application shall include a statement, signed by the owner, that in the owner's opinion, the conditions causing the suspension of the permit have been corrected.

(6) Within two working days following receipt of a written request for a reinspection, the health officer shall make a reinspection, and reinstate the permit if the owner of the food service establishment is in compliance with these regulations.

(7) The health officer may use a permit suspension process different from those specified under subsections (3), (4), (5), or (6) of this section, if adopted by the local board of health.

(8) The health officer may revoke a food service permit after providing the owner of the food service establishment an opportunity for a hearing if:

(a) Serious and repeated violation(s) of any requirements of these regulations have occurred; or

(b) Repeated interference with, or assault upon, the health officer in the performance of his/her duty has occurred.

(9) Before revocation, the health officer shall notify, in writing, the owner of the food service establishment or the person in charge of the specific reason(s) why the permit is to be revoked. The notice shall state:

(a) That the permit will be revoked at the end of the ten days following such notice unless a written request for a hearing is filed with the health officer by the owner of the food service establishment within such ten-day period; and

(b) If a request for a hearing is not filed by the owner of the food service establishment within the ten-day period, the revocation of the permit becomes final.

(10) Any owner of a food service establishment whose permit has been revoked by the health officer, after a period of six months may:

(a) Make written application for a new permit; and

(b) Request a hearing with the health officer to determine whether a new permit will be issued.

(11) The health officer may use a permit revocation process different from those specified under subsections (8), (9), and (10) of this section if adopted by the local board of health.

(12) The health officer may initiate any one, or a combination of, compliance methods which include, but are not limited to:

(a) Holding an administration conference with the food service establishment owner or person in charge;

(b) Placing the owner of the food service establishment on probation;

(c) Setting conditions for continued operation of the food service establishment, by the owner, during the probation period;

(d) Requiring additional education and/or training of employees, management, and owners of the food service establishment; and

(e) Completing a hazard analysis critical control point (HACCP) evaluation and requiring monitoring procedures be implemented for critical control points identified.

[Statutory Authority: RCW 43.20.050. 92-08-112 (Order 261B), § 246-215-200, filed 4/1/92, effective 5/2/92.]

**WAC 246-215-210 Service of notices.** (1) A notice provided for in these regulations is properly served when it is:

(a) Delivered to the holder of the permit;

(b) Delivered to the person in charge of the food service establishment; or

(c) Sent by registered or certified mail, return receipt requested, to the last known address of the holder of the permit.

(2) A copy of the notice shall be filed in the records of the health officer.

[Statutory Authority: RCW 43.20.050. 92-08-112 (Order 261B), § 246-215-210, filed 4/1/92, effective 5/2/92.]

**WAC 246-215-220 Hearings.** (1) The hearings provided for in these regulations shall be:

(a) Conducted by the health officer or his/her designee; and

(b) Conducted at a time and place designated by the health officer.

(2) The health officer or designee shall:

(a) Make a final finding based upon the complete hearing record;

(b) Sustain, modify, or rescind any notice or order considered in the hearing; and

(c) Furnish a written report of the hearing decision to the holder of the permit.

(3) An alternate hearing process, if adopted by a local board of health, may be used.

[Statutory Authority: RCW 43.20.050. 92-08-112 (Order 261B), § 246-215-220, filed 4/1/92, effective 5/2/92.]

**WAC 246-215-230 Inspections and investigations.**

(1) Inspections or investigations of a food service establishment:

(a) Shall be performed by the health officer as often as necessary for the enforcement of these regulations;

(b) Shall be required by the health officer:

(i) Before issuing a new permit to a new food service establishment; and

(ii) Following extensive remodeling of a food service establishment.

(c) May be required by the health officer:

(i) For renewal of a permit;

(ii) Before issuing a new permit to an existing food service establishment; and

(iii) For an existing food service establishment when the on-site management has changed.

(2) The person in charge of any food service establishment shall permit the health officer, after proper identification, to enter at any time, for the purpose of making inspections or investigations to determine compliance with these regulations.

(3) The person in charge of the food service establishment shall permit the health officer to examine the records of the establishment to obtain information pertaining to:

(a) Food and supplies purchased, received, or used; and

(b) Any person employed which is pertinent to an illness investigation; or

(c) Other matters which may affect health or the enforcement of these regulations.

(4) The health officer may conduct a HACCP in lieu of, or in addition to, routine inspections. The health officer may investigate to ensure monitoring of critical control points.

(5) Whenever an inspection of a food service establishment is made:

(a) The health officer shall record the findings on an inspection report form approved by the department;

(b) The health officer shall state on the completed inspection report specific violations found, and establish a specific and reasonable period of time for correction; and

(c) The health officer shall furnish a copy of the completed inspection report to the person in charge of the food service establishment at the conclusion of the inspection.

(6) The health officer shall inspect all food service establishments at least once a year.

(7) The health officer shall conduct additional inspections of food service establishments based upon the risk of foodborne illness transmission as determined by:

- (a) Types of foods served;
- (b) Methods of food preparation and service;
- (c) Number of meals served; and
- (d) Past history of compliance.

[Statutory Authority: RCW 43.20.050. 92-08-112 (Order 261B), § 246-215-230, filed 4/1/92, effective 5/2/92.]

**WAC 246-215-240 Examination, hold orders, condemnation, and destruction of food.** (1) The person in charge of a food service establishment in which food has been improperly handled, stored, or prepared shall:

(a) Voluntarily destroy the questionable food; or

(b) Contact the health officer to determine if the food is safe for human consumption.

(2) The person in charge of a food service establishment shall denature or destroy any food if the health officer determines the food presents an imminent or actual health hazard.

(3) The health officer may examine or collect samples of food as often as necessary for enforcement of these regulations.

(4) The health officer may, after notice to the person in charge, place a written hold order on any suspect food until a determination on its safety can be made and shall:

- (a) Tag;
- (b) Label; or

(c) Otherwise identify any food subject to the hold order and complete a department-approved form for all suspect food.

(5) The hold order issued by the health officer shall include:

(a) Instructions for filing a written request for a hearing with the health officer within ten calendar days; and

(b) Notification that if a hearing is not requested in accordance with the instructions provided in the hold order, and the health officer does not vacate the hold order, the food shall be destroyed under the supervision of the health officer.

(6) When foods are subject to a hold order by the health officer the food service establishment owner is prohibited from:

- (a) Using;
- (b) Serving; or
- (c) Moving them from the food service establishment.

(7) The health officer shall permit storage of food under conditions specified in the hold order, unless storage is not possible without risk to the public health, in which case, immediate destruction shall be ordered and accomplished by the owner of the food service establishment.

(8) Based upon evidence provided at the hearing, the health officer shall either:

(a) Vacate the hold order; or

(b) Direct the owner of the food service establishment by written order to:

(i) Denature or destroy such food; or

(ii) Bring the food into compliance with the provisions of these regulations.

[Statutory Authority: RCW 43.20.050. 92-08-112 (Order 261B), § 246-215-240, filed 4/1/92, effective 5/2/92.]

**WAC 246-215-250 Review of plans and menu.** (1)

The food service establishment owner shall submit properly prepared plans and specifications to the health officer for approval whenever:

(a) A food service establishment is constructed;

(b) An existing structure is converted for use as a food service establishment;

(c) Significant changes to the methods of food preparation or style of service occurs; or

(d) An existing food service establishment undergoes an extensive remodel, provided that the health officer may waive a complete plan review if:

(i) The remodel does not substantially affect the requirements of these regulations; or

(ii) The health officer requires minor modifications of the existing food service establishment to improve compliance with these regulations.

(2) The health officer shall base plan approval on:

(a) Information on proposed type of menu and style of service, including:

(i) Type of food to be served;

(ii) Method of food preparation and type of cooking;

(iii) Seating capacity and anticipated maximum meals per day;

(iv) Designation of smoking and nonsmoking sections as applicable;

(v) Methods of customer service;

(vi) Type of customer utensils; and

(vii) Number of employees per shift.

(b) Information on proposed site, including:

(i) Site plan;

(ii) Availability of approved public water supply;

(iii) Availability of approved sewage disposal; and

(iv) Accessibility for delivery traffic, garbage storage, garbage pickup frequency, and other auxiliary needs.

(c) Information on proposed facilities, including:

(i) Floor plan;

(ii) Finishes used on floors, walls, and ceilings;

(iii) Number, types, and locations of sinks and drain boards;

(iv) Plumbing specifications, such as types and locations of fixtures, drains, and grease traps;

(v) Restroom design and number of fixtures;

(vi) Types and locations of lighting; and

(vii) Types and locations of ventilation, including exhaust hoods, screened windows, or doors.

(d) Information on proposed equipment, including:

(i) Material and design of food contact surfaces;

(ii) Refrigeration and shelving design for rapid cooling, prechilling, thawing, and separation of raw meats from other foods;

(iii) Ice-making equipment for supplying ice bath cooling, salad bar, or buffet service;

(iv) Cooking, reheating, and hot holding equipment;

(v) Shelving for dry food storage;

(vi) Mechanical dishwashing machine and associated equipment; and

(vii) Design and installation of equipment, including self-service and display equipment.

(3) The procedure for plan approval is as follows:

(a) The food service establishment owner shall submit plans as described in this chapter;

(b) The health officer shall grant approval if the health officer determines the plans are satisfactory;

(c) The food service establishment owner shall submit a food service permit application and request a preoperational inspection; and

(d) Prior to operation of the food service establishment, the health officer shall provide a preoperational inspection to determine conformance with approved plans and compliance with these regulations.

[Statutory Authority: RCW 43.20.050. 92-08-112 (Order 261B), § 246-215-250, filed 4/1/92, effective 5/2/92.]

**WAC 246-215-260 Procedure when disease transmission is suspected.** (1) When a possible foodborne illness incident is reported to any food service employee, the person in charge of the food service establishment shall:

(a) Immediately report the incident to the local health officer; and

(b) Remove from sale and refrigerate any suspect foods until released by the health officer.

(2) When the health officer suspects that a food service establishment, or its employees, may be a source of a foodborne illness, the health officer shall take appropriate action to control the transmission of disease. Such actions shall include any or all of the following:

(a) Secure records that may enable identification of persons potentially exposed to the disease, and/or require additional assistance in locating such persons;

(b) Secure the illness history of each suspected employee;

(c) Exclude any suspected employee(s) from working in food service establishments until, in the opinion of the health officer, there is no further risk of disease transmission;

(d) Suspend the permit of the food service establishment until, in the opinion of the health officer, there is no further risk of disease transmission;

(e) Restrict the work activities of any suspected employee;

(f) Require medical and laboratory examinations of any food service employee and of his/her body discharges;

(g) Obtain any suspect food for laboratory examination; and

(h) Require the destruction of suspect food or prevent it from being served.

(3) The health officer shall prohibit food handlers with a communicable illness in a disease or carrier state from handling food if the infectious agent can be transmitted through food.

(4) The provisions of chapter 246-100 WAC, Communicable and certain other diseases shall apply.

[Statutory Authority: RCW 43.20.050. 92-08-112 (Order 261B), § 246-215-260, filed 4/1/92, effective 5/2/92.]

**WAC 246-215-270 Variance clause.** The health officer, upon written petition of the owner of the food service establishment, may grant a variance to any section of these regulations covering physical facilities, equipment standards, and food source requirements when:

(1) No health hazard would exist as a result of this action; and

(2) The variance is consistent with the intent of these regulations.

[Statutory Authority: RCW 43.20.050. 92-08-112 (Order 261B), § 246-215-270, filed 4/1/92, effective 5/2/92.]

**WAC 246-215-280 Interpretation.** (1) These regulations shall be enforced by the health officer in accordance with the interpretations contained in the 1976 edition of the United States Public Health Service, "Food Service Sanitation Manual," where applicable.

(2) When a section of these regulations conflicts with the "Food Service Sanitation Manual," these regulations shall apply.

(3) A local board of health may adopt more stringent regulations than those contained in these regulations.

[Statutory Authority: RCW 43.20.050. 92-08-112 (Order 261B), § 246-215-280, filed 4/1/92, effective 5/2/92.]

**WAC 246-215-290 Separability clause.** Should any section, paragraph, clause, or phrase of these rules and regulations be declared unconstitutional or invalid for any reason, the remaining rules and regulations shall not be affected.

[Statutory Authority: RCW 43.20.050. 92-08-112 (Order 261B), § 246-215-290, filed 4/1/92, effective 5/2/92.]

**WAC 246-215-300 Penalty clause.** Any person violating, refusing, or neglecting to comply with these regulations shall:

(1) Upon conviction be guilty of a misdemeanor under RCW 70.05.120; or

(2) May be subject to a civil penalty under local health department/district rules and regulations.

[Statutory Authority: RCW 43.20.050. 92-08-112 (Order 261B), § 246-215-300, filed 4/1/92, effective 5/2/92.]

**Chapter 246-217 WAC**  
**FOOD WORKER PERMITS**

**WAC**

246-217-001	Objective.
246-217-002	Legal authority of the state board of health.
246-217-010	Definitions.
246-217-011	Definitions.
246-217-020	Communicable disease.
246-217-030	Form of permits—Fees.
246-217-040	Requirements for permits.
246-217-050	Examination may be required.
246-217-060	Revocation of permit.
246-217-070	Right of appeal.

**WAC 246-217-001 Objective.** For the purpose of preventing the spread of infectious diseases and attaining a uniform sanitary standard in the state, it is deemed essential to require all food workers in the state to demonstrate through the process of an examination that they possess an adequate knowledge of the sanitary principles and practices involved in the preparation, storage, and service of foods and beverages, and in the handling of related equipment and facilities by extending the provisions of chapter 197, Laws of 1957, and (chapter 248-86 WAC), to all such workers.

[Statutory Authority: RCW 43.20.050. 91-02-051 (Order 124B), recodified as § 246-217-001, filed 12/27/90, effective 1/31/91; Regulation .87.001, effective 3/11/60.]

**WAC 246-217-002 Legal authority of the state board of health.** RCW 69.06.010 and 69.06.020. See also RCW 43.20.050.

[Statutory Authority: RCW 43.20.050. 91-02-051 (Order 124B), recodified as § 246-217-002, filed 12/27/90, effective 1/31/91; Regulation .86.999, effective 3/11/60.]

**WAC 246-217-010 Definitions.** As used in this chapter of the rules and regulations, the following definitions shall apply:

(1) A "food service worker" shall mean a person engaged in a food and/or beverage establishment and who may contribute to the transmission of infectious diseases through the nature of his contact with food products and/or equipment and facilities. This shall not include persons engaged in food handling operations where the products are sterilized after packaging or in the processing of frozen fruits or vegetables, nor nonsupervisory personnel assisting with food services functions of churches, lodges, granges and similar organizations when such are exempted from collected retail sales tax by rule 169 of the tax commission of the state of Washington as effective May 1, 1935.

(2) The term "food establishment" shall include, but is not limited to, all food handling operations associated with school lunches, carnivals, circuses, intrastate ferries, state institutions, bakeries, shellfish processing plants, caterers, hospitals, nursing homes, maternity homes, boarding homes, child care agencies, churches, lodges, granges, clubs, and food demonstrations.

[Statutory Authority: RCW 43.20.050. 91-02-051 (Order 124B), recodified as § 246-217-010, filed 12/27/90, effective 1/31/91; Regulation .87.002, effective 3/11/60.]

**WAC 246-217-011 Definitions.** Definitions as used in this chapter of the rules and regulations and in chapter 197, Laws of 1957, (chapter 69.06 RCW) -

(1) "Act" or "this act" means chapter 197, Laws of 1957, (chapter 69.06 RCW).

(2) "Person" means any individual, firm, partnership, corporation, company, association, or joint stock association, and the legal successor thereof.

(3) "Director" means the state director of health.

(4) "Department" means the state department of health.

(5) "Jurisdictional health department" refers to one of the following:

(a) Local health district as defined in chapter 70.46 RCW.

(b) City-county health department as defined in chapter 70.08 RCW.

(c) City health department as defined in chapter 70.04 RCW.

(d) County health department as defined in chapter 70.06 RCW.

(6) All other words and designations shall have the meaning as set forth in WAC 248-100-001.

[Statutory Authority: RCW 43.20.050. 91-02-051 (Order 124B), recodified as § 246-217-011, filed 12/27/90, effective 1/31/91; Regulation .86.001, effective 3/11/60.]

**WAC 246-217-020 Communicable disease.** It shall be unlawful and a violation of these regulations for any person with a communicable disease in the infectious state or a known carrier of a communicable disease or infectious condition to handle, prepare, serve or sell food, food products, or beverages for public consumption and it shall be unlawful and a violation of these regulations for any person to knowingly employ such person so afflicted.

[Statutory Authority: RCW 43.20.050. 91-02-051 (Order 124B), recodified as § 246-217-020, filed 12/27/90, effective 1/31/91; Regulation .87.020, effective 3/11/60.]

**WAC 246-217-030 Form of permits—Fees.** (1) All permits required by this act shall be issued by the jurisdictional health department and signed by the local health officer or his authorized representative.

(2) All applicants for a permit or renewal of a permit shall pay to the jurisdictional health department a fee in the amount of eight dollars, effective August 1, 1992. Such fee shall be used by the jurisdictional health department to defray the expenses arising out of the administration of this act.

(3) The permit shall conform to the following specifications:

(a) The permit shall be six inches by five inches in size and shall consist of two sections titled as follows:

(i) Food and beverage service worker's permit, and

(ii) Food and beverage service worker's health record.

(b) The permit is given to the worker and the health record is kept on file in the health department.

(4) The permit shall contain the following information:

(a) Number of the permit;

(b) Signature of the worker;

(c) Occupation;

(d) Home address;



(e) The statement, "THIS CERTIFIES THAT . . . . . has satisfied the requirements of chapter 197, Laws of 1957, and the state board of health for issuance of permit";

(f) Manual chapters covered in test shall be noted;

(g) Permit expiration date; and

(h) Signature of health officer.

(5) On the reverse side of the permit there shall be noted the following:

"Please note: This card is valid only to the employee whose signature appears on the reverse side. It must be filed at place of employment and shown upon request to sanitarian, health officer, or deputy.

**Instructions Governing Personal Hygiene and Sanitation**

- 1. Do not work if you are ill with a "catching" sickness, such as sore throat, common cold, diarrhea, or other contagious disease.
2. Notify the health department if you, any person in your home, or your place of business has a contagious disease or a disease suspected of being contagious.
3. Keep your hands and fingernails clean. Wash your hands frequently, particularly every time after going to the toilet, blowing the nose, or handling soiled objects.
4. Use disposal tissue for blowing the nose or spitting. Spitting can be a dangerous habit.
5. Do not pick pimples, boils, or your nose. This is a dangerous source of infection. If you have sores of this kind, keep them covered with a dressing.
6. Handle foods with your fingers as little as possible. Use utensils whenever you can, as in picking up butter, etc.
7. Avoid handling rims of glasses, cups, soup bowls, and eating surfaces of silver.
8. Protect food by keeping it covered from flies, keeping perishable foods and cream-filled pastries properly refrigerated."

(6) The food and beverage service worker's health record shall contain the following information:

- (a) Date issued;
(b) Number;
(c) Name;
(d) Age;
(e) Sex;
(f) Home address;
(g) Occupation;
(h) Where employed;
(i) City;
(j) Typhoid fever . . . . . No ( ) Yes ( ) Date . . .
(k) Amoebic dysentery . . . . . No ( ) Yes ( ) Date . . .
(l) Laboratory examinations, x-rays, or skin tests:
(i) Test . . . . . Result . . . . . Date . . .
(ii) Test . . . . . Result . . . . . Date . . .
(iii) Test . . . . . Result . . . . . Date . . .
(m) Manual chapters covered in test shall be noted.

(7) The reverse side of the health record shall contain: "Follow-up remarks."

[Statutory Authority: RCW 43.20.050 and chapter 69.03 RCW. 92-14-093 (Order 286B), § 246-217-030, filed 6/30/92, effective 7/31/92. Statutory Authority: RCW 43.20.050. 91-02-051 (Order 124B), recodified as § 246-217-030, filed 12/27/90, effective 1/31/91. Statutory Authority: Chapter 69.06 RCW. 87-19-069 (Order 346), § 248-86-010, filed 9/16/87; Regulation .86.010, effective 3/11/60.]

WAC 246-217-040 Requirements for permits. (1) The local health officer shall furnish to applicant for a permit or renewal of permit a copy of the latest edition of the "Food and Beverage Service Workers' Manual," as prepared by the department and approved by the director.

(2) In order to qualify for issuance of a permit or renewal of a permit, the applicant shall demonstrate his knowledge of elementary acceptable practices in the sanitary preparation, service, and storage of food and beverages, and the proper sanitation of equipment and facilities, by satisfactorily completing an examination conducted by the local health officer or his authorized representative on such subjects, based on the practices and procedures set forth in the "Food and Beverage Service Workers' Manual."

[Statutory Authority: RCW 43.20.050. 91-02-051 (Order 124B), recodified as § 246-217-040, filed 12/27/90, effective 1/31/91; Regulation .86.020, effective 3/11/60.]

WAC 246-217-050 Examination may be required. Whenever, in the judgment of the director or any local health officer, circumstances indicate the necessity, specified persons engaged in the preparation, service, or sale of food or unbottled beverages for public consumption shall, upon request of such public health officials and at no additional charge to such persons, submit to examination by the local health officer, or a legally qualified physician designated by him for the purpose of determining the presence of a communicable disease or infection.

[Statutory Authority: RCW 43.20.050. 91-02-051 (Order 124B), recodified as § 246-217-050, filed 12/27/90, effective 1/31/91; Regulation .86.040, effective 3/11/60.]

WAC 246-217-060 Revocation of permit. The food and beverage service workers' permit may be revoked by the local health officer, or by the director, upon evidence indicating repeated or continuing violations of accepted procedures and practices in the preparation, service, or storage of food or beverage offered for public consumption, or upon demonstration of the presence of a communicable disease in the infectious state, or an infectious condition of potential hazard to the public or to the persons' co-workers, or for falsification of information required for issuance of the permit.

[Statutory Authority: RCW 43.20.050. 91-02-051 (Order 124B), recodified as § 246-217-060, filed 12/27/90, effective 1/31/91; Regulation .86.050, effective 3/11/60.]

WAC 246-217-070 Right of appeal. Any food or beverage service worker whose permit has been revoked by a local health officer, or the director, may appeal to the local board of health, or the state board of health in the event such revocation is by the director, for review of the findings. Such appeal must be in writing and must be filed with the appropriate board of health within ten days of revocation of the worker's permit. While such appeal is pending, the

revocation of the worker's permit shall be stayed until such time as the appropriate board of health has reviewed the findings and entered its decision.

[Statutory Authority: RCW 43.20.050, 91-02-051 (Order 124B), recodified as § 246-217-070, filed 12/27/90, effective 1/31/91; Regulation .86.060, effective 3/11/60.]

**Chapter 246-220 WAC**  
**RADIATION PROTECTION—GENERAL**  
**PROVISIONS**

**WAC**

246-220-001	Authority.
246-220-002	Purpose.
246-220-003	Scope.
246-220-007	Statement of philosophy.
246-220-010	Definitions.
246-220-020	Records.
246-220-030	Inspections.
246-220-040	Tests and surveys.
246-220-050	Exemptions.
246-220-060	Violations.
246-220-070	Impounding.
246-220-080	Prohibited uses.
246-220-090	Communications.
246-220-100	Additional requirements.
246-220-110	Appendix A—Determination of $A_1$ and $A_2$ values.
246-220-120	Appendix B—Information on transportation special form licensed material.
246-220-130	Appendix C—The international system of units (SI).

**WAC 246-220-001 Authority.** Rules and regulations set forth herein are adopted pursuant to the provisions of chapter 70.98 RCW.

[Statutory Authority: RCW 43.70.040, 91-02-049 (Order 121), recodified as § 246-220-001, filed 12/27/90, effective 1/31/91; Order 1095, § 402-12-010, filed 2/6/76; Order 1, § 402-12-010, filed 1/8/69; Rules (part), filed 10/26/66.]

**WAC 246-220-002 Purpose.** It is the purpose of these regulations to state such requirements as shall be applied to the use of all ionizing radiation, radiation machines, and radioactive materials to ensure the maximum protection of the public health and the maximum safety to all persons at, or in the vicinity of, the place of use, storage, or disposal thereof. These regulations are intended to be consistent with the best use of radiation machines and radioactive materials.

[Statutory Authority: RCW 70.98.050, 94-01-073, § 246-220-002, filed 12/9/93, effective 1/9/94. Statutory Authority: RCW 43.70.040, 91-02-049 (Order 121), recodified as § 246-220-002, filed 12/27/90, effective 1/31/91. Statutory Authority: RCW 70.98.080, 87-01-031 (Order 2450), § 402-12-030, filed 12/11/86; Order 1095, § 402-12-030, filed 2/6/76; Order 1, § 402-12-030, filed 1/8/69; Rules (part), filed 10/26/66.]

**WAC 246-220-003 Scope.** Except as otherwise specifically provided, these regulations apply to all persons who receive, possess, use, transfer, own or acquire any source of radiation, provided, however, that nothing in these regulations shall apply to any person to the extent such person is subject to regulation by the U.S. Nuclear Regulatory Commission.\*

Note: \*Attention is directed to the fact that regulation by the state of source material, by-product material, and special nuclear material in quantities not sufficient to form a critical mass is

subject to the provisions of the agreement between the state and the U.S. Nuclear Regulatory Commission and to Part 150 of the commission's regulations (10 CFR Part 150).

[Statutory Authority: RCW 43.70.040, 91-02-049 (Order 121), recodified as § 246-220-003, filed 12/27/90, effective 1/31/91; Order 1095, § 402-12-040, filed 2/6/76; Order 1, § 402-12-040, filed 1/8/69; Rules (part), filed 10/26/66.]

**WAC 246-220-007 Statement of philosophy.** In accordance with the recommendations of the Environmental Protection Agency, formerly the Federal Radiation Council, approved by the president of the United States of America, persons engaged in activities under licenses issued by the Washington state department of health pursuant to the Atomic Energy Act of 1954, as amended, shall, in addition to complying with the requirements set forth in chapter 246-221 WAC, make every reasonable effort to maintain radiation exposures, and releases of radioactive materials in effluents to unrestricted areas, as low as is reasonably achievable. Such persons should make particular efforts to keep the radiation exposure of an embryo or fetus as low as is reasonably achievable during the entire gestation period as recommended by the National Council on Radiation Protection and Measurements. The term "as low as is reasonably achievable" means making every reasonable effort to maintain exposures to radiation as far below the dose limits in these regulations as is practical, consistent with the purpose for which the licensed or registered activity is undertaken, taking into account the state of technology, the economics of improvements in relation to the state of technology, the economics of improvements in relation to benefits to the public health and safety, and other socio-economic considerations, and in relation to the utilization of nuclear energy, ionizing radiation, and radioactive materials in the public interest.

[Statutory Authority: RCW 70.98.050, 94-01-073, § 246-220-007, filed 12/9/93, effective 1/9/94. Statutory Authority: RCW 70.98.050 and 70.98.080, 91-15-112 (Order 184), § 246-220-007, filed 7/24/91, effective 8/24/91. Statutory Authority: RCW 43.70.040, 91-02-049 (Order 121), recodified as § 246-220-007, filed 12/27/90, effective 1/31/91. Statutory Authority: RCW 70.98.050, 81-01-011 (Order 1570), § 402-10-010, filed 12/8/80; Order 1095, § 402-10-010, filed 2/6/76.]

**WAC 246-220-010 Definitions.** As used in these regulations, these terms have the definitions set forth below. Additional definitions used only in a certain part will be found in that part.

(1) " $A_1$ " means the maximum activity of special form radioactive material permitted to be transported in a Type A package. " $A_2$ " means the maximum activity of normal form radioactive material permitted to be transported in a Type A package.  $A_1$  and  $A_2$  values are assigned to individual radionuclides and are tabulated in WAC 246-220-110, Appendix A. Methods of calculating values are also given.

(2) "Absorbed dose" means the energy imparted by ionizing radiation per unit mass of irradiated material. The units of absorbed dose are the gray (Gy) and the rad.

(3) "Accelerator produced material" means any material made radioactive by exposing it in a particle accelerator.

(4) "Act" means Nuclear energy and radiation, chapter 70.98 RCW.

(5) "Activity" means the rate of disintegration or transformation or decay of radioactive material. The units of activity are the becquerel (Bq) and the curie (Ci).

(6) "Adult" means an individual eighteen or more years of age.

(7) "Agreement state" means any state with which the United States Nuclear Regulatory Commission has entered into an effective agreement under section 274 b. of the Atomic Energy Act of 1954, as amended (73 Stat. 689).

(8) "Airborne radioactive material" means any radioactive material dispersed in the air in the form of particulates, dusts, fumes, mists, vapors, or gases.

(9) "Airborne radioactivity area" means a room, enclosure, or operating area in which airborne radioactive material exists in concentrations (a) in excess of the derived air concentration (DAC) specified in WAC 246-221-290, Appendix A, or (b) to such a degree that an individual present in the area without respiratory protective equipment could exceed, during the hours an individual is present in a week, an intake of 0.6 percent of the annual limit on intake (ALI) or twelve DAC-hours.

(10) "Alert" means events may occur, are in progress, or have occurred that could lead to a release of radioactive material but that the release is not expected to require a response by offsite response organizations to protect persons offsite.

(11) "Annual limit on intake" (ALI) means the derived limit for the amount of radioactive material taken into the body of an adult worker by inhalation or ingestion in a year. ALI is the smaller value of intake of a given radionuclide in a year by the reference man that would result in a committed effective dose equivalent of 0.05 Sv (5 rem) or a committed dose equivalent of 0.5 Sv (50 rem) to any individual organ or tissue. ALI values for intake by ingestion and by inhalation of selected radionuclides are given in WAC 246-221-290.

(12) "Background radiation" means radiation from cosmic sources; naturally occurring radioactive materials, including radon, except as a decay product of source or special nuclear material, and including global fallout as it exists in the environment from the testing of nuclear explosive devices. "Background radiation" does not include sources of radiation from radioactive materials regulated by the department.

(13) "Becquerel" (Bq) means the SI unit of activity. One becquerel is equal to 1 disintegration or transformation per second ( $s^{-1}$ ).

(14) "Bioassay" means the determination of kinds, quantities or concentrations, and, in some cases, the locations of radioactive material in the human body, whether by direct measurement, in vivo counting, or by analysis and evaluation of materials excreted or removed from the human body. For purposes of these regulations, "radiobioassay" is an equivalent term.

(15) "Byproduct material" means: (a) Any radioactive material (except special nuclear material) yielded in or made radioactive by exposure to the radiation incident to the process of producing or utilizing special nuclear material, and (b) the tailings or wastes produced by the extraction or concentration of uranium or thorium from any ore processed primarily for its source material content, including discrete surface wastes resulting from uranium or thorium solution

extraction processes. Underground ore bodies depleted by these solution extraction operations do not constitute "by-product material" within this definition.

(16) "Calendar quarter" means not less than twelve consecutive weeks nor more than fourteen consecutive weeks. The first calendar quarter of each year shall begin in January and subsequent calendar quarters shall be so arranged such that no day is included in more than one calendar quarter and no day in any one year is omitted from inclusion within a calendar quarter. No licensee or registrant shall change the method of determining calendar quarters for purposes of these regulations except at the beginning of a calendar year.

(17) "Calibration" means the determination of (a) the response or reading of an instrument relative to a series of known radiation values over the range of the instrument, or (b) the strength of a source of radiation relative to a standard.

(18) "CFR" means Code of Federal Regulations.

(19) "Class" means a classification scheme for inhaled material according to its rate of clearance from the pulmonary region of the lung. Materials are classified as D, W, or Y, which applies to a range of clearance half-times: For Class D, Days, of less than ten days, for Class W, Weeks, from ten to one hundred days, and for Class Y, Years, of greater than one hundred days. For purposes of these regulations, "lung class" and "inhalation class" are equivalent terms. For "class of waste" see WAC 246-249-040.

(20) "Collective dose" means the sum of the individual doses received in a given period of time by a specified population from exposure to a specified source of radiation.

(21) "Committed dose equivalent" ( $H_{T,50}$ ) means the dose equivalent to organs or tissues of reference (T) that will be received from an intake of radioactive material by an individual during the fifty-year period following the intake.

(22) "Committed effective dose equivalent" ( $H_{E,50}$ ) is the sum of the products of the weighting factors applicable to each of the body organs or tissues that are irradiated and the committed dose equivalent to each of these organs or tissues ( $H_{E,50} = \sum w_T H_{T,50}$ ).

(23) "Controlled area." See "Restricted area."

(24) "Curie" means a unit of quantity of radioactivity. One curie (Ci) is that quantity of radioactive material which decays at the rate of  $3.7 \times 10^{10}$  transformations per second (tps).

(25) "Declared pregnant woman" means a woman who has voluntarily informed her employer, in writing, of her pregnancy, and her estimated date of conception.

(26) "Deep dose equivalent" ( $H_d$ ), which applies to external whole body exposure, means the dose equivalent at a tissue depth of 1 centimeter ( $1000 \text{ mg/cm}^2$ ).

(27) "Department" means the department of health, division of radiation protection, which has been designated as the state radiation control agency.

(28) "Depleted uranium" means the source material uranium in which the isotope Uranium-235 is less than 0.711 percent by weight of the total uranium present. Depleted uranium does not include special nuclear material.

(29) "Derived air concentration" (DAC) means the concentration of a given radionuclide in air which, if breathed by the reference man for a working year of two thousand hours under conditions of light work, results in an

intake of one ALI. For purposes of these regulations, the condition of light work is an inhalation rate of 1.2 cubic meters of air per hour for two thousand hours in a year. DAC values are given in WAC 246-221-290.

(30) "Derived air concentration-hour" (DAC-hour) means the product of the concentration of radioactive material in air, expressed as a fraction or multiple of the derived air concentration for each radionuclide, and the time of exposure to that radionuclide, in hours. A licensee or registrant may take two thousand DAC-hours to represent one ALI, equivalent to a committed effective dose equivalent of 0.05 Sv (5 rem).

(31) "Dose" is a generic term that means absorbed dose, dose equivalent, effective dose equivalent, committed dose equivalent, committed effective dose equivalent, total organ dose equivalent, or total effective dose equivalent. For purposes of these regulations, "radiation dose" is an equivalent term.

(32) "Dose commitment" means the total radiation dose to a part of the body that will result from retention in the body of radioactive material. For purposes of estimating the dose commitment, it is assumed that from the time of intake the period of exposure to retained material will not exceed fifty years.

(33) "Dose equivalent ( $H_T$ )" means the product of the absorbed dose in tissue, quality factor, and all other necessary modifying factors at the location of interest. The units of dose equivalent are the sievert (Sv) and rem.

(34) "Dose limits" means the permissible upper bounds of radiation doses established in accordance with these regulations. For purposes of these regulations, "limits" is an equivalent term.

(35) "Dosimetry processor" means a person that processes and evaluates individual monitoring devices in order to determine the radiation dose delivered to the monitoring devices.

(36) "dpm" means disintegrations per minute. See also "curie."

(37) "Effective dose equivalent ( $H_E$ )" means the sum of the products of the dose equivalent to each organ or tissue ( $H_T$ ) and the weighting factor ( $w_T$ ) applicable to each of the body organs or tissues that are irradiated ( $H_E = \sum w_T H_T$ ).

(38) "Embryo/fetus" means the developing human organism from conception until the time of birth.

(39) "Entrance or access point" means any opening through which an individual or extremity of an individual could gain access to radiation areas or to licensed radioactive materials. This includes entry or exit portals of sufficient size to permit human entry, without respect to their intended use.

(40) "Exposure" means (a), when used as a verb, being exposed to ionizing radiation or to radioactive material, or (b), when used as a noun, the quotient of  $\Delta Q$  by  $\Delta m$  where " $\Delta Q$ " is the absolute value of the total charge of the ions of one sign produced in air when all the electrons (negatrons and positrons) liberated by photons in a volume element of air having mass " $\Delta m$ " are completely stopped in air. The special unit of exposure is the roentgen (R) and the SI equivalent is the coulomb per kilogram. One roentgen is equal to  $2.58 \times 10^{-4}$  coulomb per kilogram of air.

(41) "Exposure rate" means the exposure per unit of time, such as roentgen per minute and milliroentgen per hour.

(42) "External dose" means that portion of the dose equivalent received from any source of radiation outside the body.

(43) "Extremity" means hand, elbow, arm below the elbow, foot, knee, and leg below the knee.

(44) "Eye dose equivalent" means the external dose equivalent to the lens of the eye at a tissue depth of 0.3 centimeter ( $300 \text{ mg/cm}^2$ ).

(45) "Former United States Atomic Energy Commission (AEC) or United States Nuclear Regulatory Commission (NRC) licensed facilities" means nuclear reactors, nuclear fuel reprocessing plants, uranium enrichment plants, or critical mass experimental facilities where AEC or NRC licenses have been terminated.

(46) "Generally applicable environmental radiation standards" means standards issued by the United States Environmental Protection Agency (EPA) under the authority of the Atomic Energy Act of 1954, as amended, that impose limits on radiation exposures or levels, or concentrations or quantities of radioactive material, in the general environment outside the boundaries of locations under the control of persons possessing or using radioactive material.

(47) "Gray" (Gy) means the SI unit of absorbed dose. One gray is equal to an absorbed dose of 1 joule/kilogram (100 rad).

(48) "Healing arts" means the disciplines of medicine, dentistry, osteopathy, chiropractic, podiatry, and veterinary medicine.

(49) "High radiation area" means any area, accessible to individuals, in which radiation levels could result in an individual receiving a dose equivalent in excess of 1 mSv (0.1 rem) in one hour at 30 centimeters from any source of radiation or from any surface that the radiation penetrates. For purposes of these regulations, rooms or areas in which diagnostic x-ray systems are used for healing arts purposes are not considered high radiation areas.

(50) "Highway route controlled quantity" means a quantity of radioactive material in a single package which exceeds:

- (a) 3,000 times the  $A_1$  or  $A_2$  quantity as appropriate; or
- (b) 30,000 curies, whichever is less.

(51) "Human use" means the intentional internal or external administration of radiation or radioactive material to human beings.

(52) "Immediate" or "immediately" means as soon as possible but no later than four hours after the initiating condition.

(53) "IND" means investigatory new drug for which an exemption has been claimed under the United States Food, Drug and Cosmetic Act (Title 21 CFR).

(54) "Individual" means any human being.

(55) "Individual monitoring" means the assessment of:

- (a) Dose equivalent (i) by the use of individual monitoring devices or (ii) by the use of survey data; or
- (b) Committed effective dose equivalent (i) by bioassay or (ii) by determination of the time-weighted air concentrations to which an individual has been exposed, that is, DAC-hours.

(56) "Individual monitoring devices" means devices designed to be worn by a single individual for the assessment of dose equivalent. For purposes of these regulations, individual monitoring equipment, personnel monitoring device, personnel dosimeter, and dosimeter are equivalent terms. Examples of individual monitoring devices are film badges, thermoluminescent dosimeters (TLDs), pocket ionization chambers, and personal air sampling devices.

(57) "Inspection" means an official examination or observation by the department including but not limited to, tests, surveys, and monitoring to determine compliance with rules, regulations, orders, requirements and conditions of the department.

(58) "Interlock" means a device arranged or connected such that the occurrence of an event or condition is required before a second event or condition can occur or continue to occur.

(59) "Internal dose" means that portion of the dose equivalent received from radioactive material taken into the body.

(60) "Irretrievable source" means any sealed source containing licensed material which is pulled off or not connected to the wireline downhole and for which all reasonable effort at recovery, as determined by the department, has been expended.

(61) "License" means a license issued by the department in accordance with the regulations adopted by the department.

(62) "Licensed material" means radioactive material received, possessed, used, transferred, or disposed under a general or specific license issued by the department.

(63) "Licensee" means any person who is licensed by the department in accordance with these regulations and the act.

(64) "Licensing state" means any state with regulations equivalent to the suggested state regulations for control of radiation relating to, and an effective program for, the regulatory control of NARM and which has been granted final designation by the Conference of Radiation Control Program Directors, Inc.

(65) "Lost or missing licensed material" means licensed material whose location is unknown. This definition includes licensed material that has been shipped but has not reached its planned destination and whose location cannot be readily traced in the transportation system.

(66) "Major processor" means a user processing, handling, or manufacturing radioactive material exceeding Type A quantities as unsealed sources or material, or exceeding four times Type B quantities as sealed sources, but does not include nuclear medicine programs, universities, industrial radiographers, or small industrial programs. Type A and B quantities are defined in Section 71.4 of 10 CFR Part 71.

(67) "Member of the public" means an individual except when the individual is receiving an occupational dose.

(68) "Minor" means an individual less than eighteen years of age.

(69) "Monitoring" means the measurement of radiation, radioactive material concentrations, surface area activities or quantities of radioactive material and the use of the results of these measurements to evaluate potential exposures and

doses. For purposes of these regulations, radiation monitoring and radiation protection monitoring are equivalent terms.

(70) "NARM" means any naturally occurring or accelerator-produced radioactive material. It does not include by-product, source, or special nuclear material. For the purpose of meeting the definition of a Licensing State by the Conference of Radiation Control Program Directors, Inc. (CRCPD), NARM refers only to discrete sources of NARM. Diffuse sources of NARM are excluded from consideration by the CRCPD for Licensing State designation purposes.

(71) "Natural radioactivity" means radioactivity of naturally occurring nuclides.

(72) "NDA" means a new drug application which has been submitted to the United States Food and Drug Administration.

(73) "Nonstochastic effect" means a health effect, the severity of which varies with the dose and for which a threshold is believed to exist. Radiation-induced cataract formation is an example of a nonstochastic effect. For purposes of these regulations, a "deterministic effect" is an equivalent term.

(74) "Normal form radioactive material" means radioactive material which has not been demonstrated to qualify as "special form radioactive material."

(75) "Nuclear Regulatory Commission" (NRC) means the United States Nuclear Regulatory Commission or its duly authorized representatives.

(76) "Nuclear waste" as used in WAC 246-232-090(5) means any quantity of source or byproduct material, (not including radiography sources being returned to the manufacturer) required to be in Type B packaging while transported to, through, or across state boundaries to a disposal site, or to a collection point for transport to a disposal site. Nuclear waste, as used in these regulations, is a special classification of radioactive waste.

(77) "Occupational dose" means the dose received by an individual in the course of employment in which the individual's assigned duties involve exposure to sources of radiation, whether in the possession of the licensee, registrant, or other person. Occupational dose does not include dose received: From background radiation, as a patient from medical practices, from voluntary participation in medical research programs, or as a member of the public.

(78) "Ore refineries" means all processors of a radioactive material ore.

(79) "Package" means the packaging together with its radioactive contents as presented for transport.

(80) "Particle accelerator" means any machine capable of accelerating electrons, protons, deuterons, or other charged particles in a vacuum and of discharging the resultant particulate or other radiation into a medium at energies usually in excess of 1 MeV.

(81) "Permittee" means a person who has applied for, and received, a valid site use permit for use of the low-level waste disposal facility at Hanford, Washington.

(82) "Person" means any individual, corporation, partnership, firm, association, trust, estate, public or private institution, group, agency, political subdivision of this state, any other state or political subdivision or agency thereof, and any legal successor, representative, agent or agency of the foregoing, but shall not include federal government agencies.

(83) "Personal supervision" means supervision such that the supervisor is physically present at the facility and in such proximity that contact can be maintained and immediate assistance given as required.

(84) "Personnel monitoring equipment." See individual monitoring devices.

(85) "Pharmacist" means an individual licensed by this state to compound and dispense drugs, and poisons.

(86) "Physician" means an individual licensed by this state to prescribe and dispense drugs in the practice of medicine.

(87) "Planned special exposure" means an infrequent exposure to radiation, separate from and in addition to the annual occupational dose limits.

(88) "Practitioner" means an individual licensed by the state in the practice of a healing art (i.e., physician, dentist, podiatrist, chiropractor, etc.).

(89) "Public dose" means the dose received by a member of the public from exposure to sources of radiation under the licensee's or registrant's control or to radioactive material released by the licensee. It does not include occupational dose, dose received from background radiation, dose received as a patient from medical practices, or dose received from voluntary participation in medical research programs.

(90) "Qualified expert" means an individual who has demonstrated to the satisfaction of the department he/she has the knowledge, training, and experience to measure ionizing radiation, to evaluate safety techniques, and to advise regarding radiation protection needs. The department reserves the right to recognize the qualifications of an individual in specific areas of radiation protection.

(91) "Quality factor" (Q) means the modifying factor, listed in Tables I and II, that is used to derive dose equivalent from absorbed dose.

TABLE I  
QUALITY FACTORS AND ABSORBED DOSE EQUIVALENCIES

TYPE OF RADIATION	Quality Factor (Q)	Absorbed Dose Equal to A Unit Dose Equivalent <sup>a</sup>
X, gamma, or beta radiation and high-speed electrons	1	1
Alpha particles, multiple-charged particles, fission fragments and heavy particles of unknown charge	20	0.05
Neutrons of unknown energy	10	0.1
High-energy protons	10	0.1

<sup>a</sup> Absorbed dose in rad equal to 1 rem or the absorbed dose in gray equal to 1 Sv.

If it is more convenient to measure the neutron fluence rate rather than to determine the neutron dose equivalent rate in sievert per hour or rem per hour as required for Table I, then 0.01 Sv (1 rem) of neutron radiation of unknown energies may, for purposes of these regulations, be assumed to result from a total fluence of 25 million neutrons per square centimeter incident upon the body. If sufficient information exists to estimate the approximate energy distribution of the neutrons, the licensee or registrant may use the fluence rate per unit dose equivalent or the appropriate Q value from Table II to convert a measured tissue dose in gray or rad to dose equivalent in sievert or rem.

TABLE II  
MEAN QUALITY FACTORS, Q, AND FLUENCE PER UNIT DOSE EQUIVALENT FOR MONOENERGETIC NEUTRONS

Neutron Energy (MeV)	Quality Factor <sup>a</sup> (Q)	Fluence per Unit Dose Equivalent <sup>b</sup> (neutrons cm <sup>-2</sup> rem <sup>-1</sup> )	Fluence per Unit Dose Equivalent <sup>b</sup> (neutrons cm <sup>-2</sup> Sv <sup>-1</sup> )
(thermal) 2.5 x 10 <sup>-8</sup>	2	980 x 10 <sup>6</sup>	980 x 10 <sup>8</sup>
1 x 10 <sup>-7</sup>	2	980 x 10 <sup>6</sup>	980 x 10 <sup>8</sup>
1 x 10 <sup>-6</sup>	2	810 x 10 <sup>6</sup>	810 x 10 <sup>8</sup>
1 x 10 <sup>-5</sup>	2	810 x 10 <sup>6</sup>	810 x 10 <sup>8</sup>
1 x 10 <sup>-4</sup>	2	840 x 10 <sup>6</sup>	840 x 10 <sup>8</sup>
1 x 10 <sup>-3</sup>	2	980 x 10 <sup>6</sup>	980 x 10 <sup>8</sup>
1 x 10 <sup>-2</sup>	2.5	1010 x 10 <sup>6</sup>	1010 x 10 <sup>8</sup>
1 x 10 <sup>-1</sup>	7.5	170 x 10 <sup>6</sup>	170 x 10 <sup>8</sup>
5 x 10 <sup>-1</sup>	11	39 x 10 <sup>6</sup>	39 x 10 <sup>8</sup>
1	11	27 x 10 <sup>6</sup>	27 x 10 <sup>8</sup>
2.5	9	29 x 10 <sup>6</sup>	29 x 10 <sup>8</sup>
5	8	23 x 10 <sup>6</sup>	23 x 10 <sup>8</sup>
7	7	24 x 10 <sup>6</sup>	24 x 10 <sup>8</sup>
10	6.5	24 x 10 <sup>6</sup>	24 x 10 <sup>8</sup>
14	7.5	17 x 10 <sup>6</sup>	17 x 10 <sup>8</sup>



20	8	$16 \times 10^6$	$16 \times 10^8$
40	7	$14 \times 10^6$	$14 \times 10^8$
60	5.5	$16 \times 10^6$	$16 \times 10^8$
$1 \times 10^2$	4	$20 \times 10^6$	$20 \times 10^8$
$2 \times 10^2$	3.5	$19 \times 10^6$	$19 \times 10^8$
$3 \times 10^2$	3.5	$16 \times 10^6$	$16 \times 10^8$
$4 \times 10^2$	3.5	$14 \times 10^6$	$14 \times 10^8$

a Value of quality factor (Q) at the point where the dose equivalent is maximum in a 30-cm diameter cylinder tissue-equivalent phantom.

b Monoenergetic neutrons incident normally on a 30-cm diameter cylinder tissue-equivalent phantom.

(92) "Quarter" means a period of time equal to one-fourth of the year observed by the licensee, approximately thirteen consecutive weeks, providing that the beginning of the first quarter in a year coincides with the starting date of the year and that no day is omitted or duplicated in consecutive quarters.

(93) "Rad" means the special unit of absorbed dose. One rad equals one-hundredth of a joule per kilogram of material; for example, if tissue is the material of interest, then 1 rad equals 100 ergs per gram of tissue. One rad is equal to an absorbed dose of 100 erg/gram or 0.01 joule/kilogram (0.01 gray).

(94) "Radiation" means alpha particles, beta particles, gamma rays, x-rays, neutrons, high-speed electrons, high-speed protons, and other particles capable of producing ions. For purposes of these regulations, ionizing radiation is an equivalent term. Radiation, as used in these regulations, does not include magnetic fields or nonionizing radiation, such as radiowaves or microwaves, visible, infrared, or ultraviolet light.

(95) "Radiation area" means any area, accessible to individuals, in which radiation levels could result in an individual receiving a dose equivalent in excess of 0.05 mSv (0.005 rem) in one hour at thirty centimeters from the source of radiation or from any surface that the radiation penetrates.

(96) "Radiation machine" means any device capable of producing ionizing radiation except those devices with radioactive materials as the only source of radiation.

(97) "Radiation safety officer" means an individual who has the knowledge and responsibility to apply appropriate radiation protection regulations and has been assigned such responsibility by the licensee or registrant.

(98) "Radiation source." See "Source of radiation."

(99) "Radioactive material" means any material (solid, liquid, or gas) which emits radiation spontaneously.

(100) "Radioactive waste" means any radioactive material which is no longer of use and intended for disposal or treatment for the purposes of disposal.

(101) "Radioactivity" means the transformation of unstable atomic nuclei by the emission of radiation.

(102) "Reference man" means a hypothetical aggregation of human physical and physiological characteristics determined by international consensus. These characteristics may be used by researchers and public health workers to standardize results of experiments and to relate biological insult to a common base.

(103) "Registrable item" means any radiation machine except those exempted by RCW 70.98.180 or exempted by the department pursuant to the authority of RCW 70.98.080.

(104) "Registrant" means any person who is registered by the department or is legally obligated to register with the department in accordance with these regulations and the act.

(105) "Registration" means registration with the department in accordance with the regulations adopted by the department.

(106) "Regulations of the United States Department of Transportation" means the regulations in 49 CFR Parts 170-189, 14 CFR Part 103, and 46 CFR Part 146.

(107) "Rem" means the special unit of any of the quantities expressed as dose equivalent. The dose equivalent in rem is equal to the absorbed dose in rad multiplied by the quality factor (1 rem = 0.01 Sv).

(108) "Research and development" means: (a) Theoretical analysis, exploration, or experimentation; or (b) the extension of investigative findings and theories of a scientific or technical nature into practical application for experimental and demonstration purposes, including the experimental production and testing of models, devices, equipment, materials, and processes. Research and development does not include the internal or external administration of radiation or radioactive material to human beings.

(109) "Respiratory protective equipment" means an apparatus, such as a respirator, used to reduce an individual's intake of airborne radioactive materials.

(110) "Restricted area" means any area to which access is limited by the licensee or registrant for purposes of protecting individuals against undue risks from exposure to radiation and radioactive material. "Restricted area" shall not include any areas used for residential quarters, although a separate room or rooms in a residential building may be set apart as a restricted area.

(111) "Roentgen" (R) means the special unit of exposure. One roentgen equals  $2.58 \times 10^{-4}$  coulombs/kilogram of air.

(112) "Sanitary sewerage" means a system of public sewers for carrying off waste water and refuse, but excluding sewage treatment facilities, septic tanks, and leach fields owned or operated by the licensee or registrant.

(113) "Sealed source" means any device containing radioactive material to be used as a source of radiation which has been constructed in such a manner as to prevent the escape of any radioactive material.

(114) "Shallow dose equivalent" ( $H_s$ ), which applies to the external exposure of the skin or an extremity, means the dose equivalent at a tissue depth of 0.007 centimeter (7 mg/cm<sup>2</sup>) averaged over an area of 1 square centimeter.

(115) "SI" means an abbreviation of the International System of Units.

(116) "Sievert" means the SI unit of any of the quantities expressed as dose equivalent. The dose equivalent in sievert is equal to the absorbed dose in gray multiplied by the quality factor (1 Sv = 100 rem).

(117) "Site area emergency" means events may occur, are in progress, or have occurred that could lead to a significant release of radioactive material and that could require a response by offsite response organizations to protect persons offsite.

(118) "Site boundary" means that line beyond which the land or property is not owned, leased, or otherwise controlled by the licensee or registrant.

(119) "Source container" means a device in which radioactive material is transported or stored.

(120) "Source material" means: (a) Uranium or thorium, or any combination thereof, in any physical or chemical form, or (b) ores which contain by weight one-twentieth of one percent (0.05 percent) or more of (i) uranium, (ii) thorium, or (iii) any combination thereof. Source material does not include special nuclear material.

(121) "Source material milling" means the extraction or concentration of uranium or thorium from any ore processing primarily for its source material content.

(122) "Source of radiation" means any radioactive material, or any device or equipment emitting or capable of producing ionizing radiation.

(123) "Special form radioactive material" means radioactive material which satisfies the following conditions:

(a) It is either a single solid piece or is contained in a sealed capsule that can only be opened by destroying the capsule;

(b) The piece or capsule has at least one dimension not less than five millimeters (0.197 inch); and

(c) It satisfies the test requirements specified by the United States Nuclear Regulatory Commission. A special form encapsulation designed in accordance with the United States Nuclear Regulatory Commission requirements in effect on June 30, 1983, and constructed prior to July 1, 1985, may continue to be used. A special form encapsulation either designed or constructed after June 30, 1985, must meet requirements of this definition applicable at the time of its design or construction.

(124) "Special nuclear material" means:

(a) Plutonium, uranium-233, uranium enriched in the isotope 233 or in the isotope 235, and any other material that the United States Nuclear Regulatory Commission, pursuant to the provisions of section 51 of the Atomic Energy Act of 1954, as amended, determines to be special nuclear material, but does not include source material; or

(b) Any material artificially enriched in any of the foregoing, but does not include source material.

(125) "Special nuclear material in quantities not sufficient to form a critical mass" means uranium enriched in the isotope U-235 in quantities not exceeding three hundred fifty grams of contained U-235; Uranium-233 in quantities not exceeding two hundred grams; Plutonium in quantities not exceeding two hundred grams; or any combination of them in accordance with the following formula: For each kind of special nuclear material, determine the ratio between the quantity of that special nuclear material and the quantity specified above for the same kind of special nuclear material. The sum of such ratios for all of the kinds of special

nuclear material in combination shall not exceed "1" (i.e., unity). For example, the following quantities in combination would not exceed the limitation and are within the formula:

$$\frac{175(\text{grams contained U-235})}{350} + \frac{50(\text{grams U-233})}{200} + \frac{50(\text{grams Pu})}{200} < 1$$

(126) "Stochastic effect" means a health effect that occurs randomly and for which the probability of the effect occurring, rather than its severity, is assumed to be a linear function of dose without threshold. Hereditary effects and cancer incidence are examples of stochastic effects. For purposes of these regulations, probabilistic effect is an equivalent term.

(127) "Survey" means an evaluation of the radiological conditions and potential hazards incident to the production, use, release, disposal, or presence of sources of radiation. When appropriate, such evaluation includes, but is not limited to, tests, physical examinations, calculations and measurements of levels of radiation or concentration of radioactive material present.

(128) "Test" means (a) the process of verifying compliance with an applicable regulation, or (b) a method for determining the characteristics or condition of sources of radiation or components thereof.

(129) "These regulations" mean all parts of the rules for radiation protection of the state of Washington.

(130) "Total effective dose equivalent" (TEDE) means the sum of the deep dose equivalent for external exposures and the committed effective dose equivalent for internal exposures.

(131) "Total organ dose equivalent (TODE)" means the sum of the deep dose equivalent and the committed dose equivalent to the organ or tissue receiving the highest dose.

(132) "Type A packaging" means packaging designed in accordance with 49 CFR 173.411 and 173.412 to retain its integral containment and shielding under normal conditions of transport as demonstrated by tests described in 49 CFR 173.465 or 173.466 as appropriate. The contents are limited to A<sub>1</sub> or A<sub>2</sub> quantities. The package does not require competent authority approval.

(133) "Type A quantity" means a quantity of radioactive material less than or equal to the A<sub>1</sub> or A<sub>2</sub> value for a single radionuclide, or for which the sum of the fractions does not exceed unity for a mixture of radionuclides.

(134) "Type B packaging" means packaging approved by the United States Nuclear Regulatory Commission for the transport of quantities of radioactivity in excess of A<sub>1</sub> or A<sub>2</sub>. It is defined in detail in 10 CFR 71.4.

(135) "Type B quantity" means a quantity of radioactive material in excess of a Type A quantity. It requires Type B packaging for transportation.

(136) "United States Department of Energy" means the Department of Energy established by Public Law 95-91, August 4, 1977, 91 Stat. 565, 42 U.S.C. 7101 et seq., to the extent that the department exercises functions formerly

vested in the United States Atomic Energy Commission, its chairman, members, officers and components and transferred to the United States Energy Research and Development Administration and to the administrator thereof pursuant to sections 104 (b), (c) and (d) of the Energy Reorganization Act of 1974 (Public Law 93-438, October 11, 1974, 88 Stat. 1233 at 1237, 42 U.S.C. 5814 effective January 19, 1975) and retransferred to the Secretary of Energy pursuant to section 301(a) of the Department of Energy Organization Act (Public Law 95-91, August 4, 1977, 91 Stat. 565 at 577-578, 42 U.S.C. 7151, effective October 1, 1977).

(137) "Unrefined and unprocessed ore" means ore in its natural form prior to any processing, such as grinding, roasting, beneficiating, or refining.

(138) "Unrestricted area" (uncontrolled area) means any area which is not a restricted area. Areas where the external dose exceeds 2 mrem in any one hour or where the public dose, taking into account occupancy factors, will exceed 100 mrem total effective dose equivalent in any one year must be restricted.

(139) "Very high radiation area" means an area, accessible to individuals, in which radiation levels could result in an individual receiving an absorbed dose in excess of 5 Gy (500 rad) in one hour at one meter from a source of radiation or from any surface that the radiation penetrates.

(140) "Waste handling licensees" mean persons licensed to receive and store radioactive wastes prior to disposal and/or persons licensed to dispose of radioactive waste.

(141) "Week" means seven consecutive days starting on Sunday.

(142) "Weighting factor"  $w_T$  for an organ or tissue (T) means the proportion of the risk of stochastic effects resulting from irradiation of that organ or tissue to the total risk of stochastic effects when the whole body is irradiated uniformly. For calculating the effective dose equivalent, the values of  $w_T$  are:

ORGAN DOSE WEIGHTING FACTORS

Organ or Tissue	$w_T$
Gonads	0.25
Breast	0.15
Red bone marrow	0.12
Lung	0.12
Thyroid	0.03
Bone surfaces	0.03
Remainder	0.30 <sup>a</sup>
Whole Body	1.00 <sup>b</sup>

<sup>a</sup> 0.30 results from 0.06 for each of 5 "remainder" organs, excluding the skin and the lens of the eye, that receive the highest doses.

<sup>b</sup> For the purpose of weighting the external whole body dose, for adding it to the internal dose, a single weighting factor,  $w_T = 1.0$ , has been specified. The use of other weighting factors for external exposure will be approved on a case-by-case basis until such time as specific guidance is issued.

(143) "Whole body" means, for purposes of external exposure, head, trunk including male gonads, arms above the elbow, or legs above the knee.

(144) "Worker" means an individual engaged in activi-

ties under a license or registration issued by the department and controlled by a licensee or registrant but does not include the licensee or registrant. Where the licensee or registrant is an individual rather than one of the other legal entities defined under "person," the radiation exposure limits for the worker also apply to the individual who is the licensee or registrant. If students of age eighteen years or older are subjected routinely to work involving radiation, then the students are considered to be workers. Individuals of less than eighteen years of age shall meet the requirements of WAC 246-221-050.

(145) "Working level" (WL) means any combination of short-lived radon daughters in 1 liter of air that will result in the ultimate emission of  $1.3 \times 10^5$  MeV of potential alpha particle energy. The short-lived radon daughters are — for radon-222: polonium-218, lead-214, bismuth-214, and polonium-214; and for radon-220: polonium-216, lead-212, bismuth-212, and polonium-212.

(146) "Working level month" (WLM) means an exposure to one working level for one hundred seventy hours — two thousand working hours per year divided by twelve months per year is approximately equal to one hundred seventy hours per month.

(147) "Year" means the period of time beginning in January used to determine compliance with the provisions of these regulations. The licensee or registrant may change the starting date of the year used to determine compliance by the licensee or registrant provided that the change is made at the beginning of the year and that no day is omitted or duplicated in consecutive years.

[Statutory Authority: RCW 70.98.050. 95-01-108, § 246-220-010, filed 12/21/94, effective 1/21/95; 94-01-073, § 246-220-010, filed 12/9/93, effective 1/9/94. Statutory Authority: RCW 70.98.050 and 70.98.080. 91-15-112 (Order 184), § 246-220-010, filed 7/24/91, effective 8/24/91. Statutory Authority: RCW 43.70.040. 91-02-049 (Order 121), recodified as § 246-220-010, filed 12/27/90, effective 1/31/91. Statutory Authority: RCW 70.98.080. 87-01-031 (Order 2450), § 402-12-050, filed 12/11/86; 83-19-050 (Order 2026), § 402-12-050, filed 9/16/83. Statutory Authority: Chapter 70.121 RCW. 81-16-031 (Order 1683), § 402-12-050, filed 7/28/81. Statutory Authority: RCW 70.98.050. 81-01-011 (Order 1570), § 402-12-050, filed 12/8/80; Order 1095, § 402-12-050, filed 2/6/76; Order 708, § 402-12-050, filed 8/24/72; Order 1, § 402-12-050, filed 7/2/71; Order 1, § 402-12-050, filed 1/8/69; Rules (part), filed 10/26/66.]

**WAC 246-220-020 Records.** (1) Each licensee or registrant shall maintain records relating to the receipt, use, storage, transfer, or disposal of radiation sources, and such other records as the department may require which will permit the determination of the extent of occupational and public exposure from such radiation sources. Copies of these records shall be submitted to the department on request. These requirements are subject to such exemptions as may be provided by department rules.

(2) In accordance with the Public Disclosure Act, the department shall make available to each licensee and/or registrant departmental records pertaining to that licensee or registrant, at his/her written request.

[Statutory Authority: RCW 43.70.040. 91-02-049 (Order 121), recodified as § 246-220-020, filed 12/27/90, effective 1/31/91. Statutory Authority: RCW 70.98.050. 81-01-011 (Order 1570), § 402-12-080, filed 12/8/80; Order 1095, § 402-12-080, filed 2/6/76; Order 1, § 402-12-080, filed 1/8/69; Rules (part), filed 10/26/66.]

**WAC 246-220-030 Inspections.** (1) Each licensee and/or registrant shall afford the department at all reasonable times opportunity to inspect sources of radiation and the premises and facilities wherein such sources of radiation are used or stored.

(2) Each licensee and/or registrant shall make available to the department for inspection, upon reasonable notice, records maintained pursuant to these regulations.

(3) In accordance with the Public Disclosure Act, the department shall make available to each licensee and/or registrant a copy of every inspection report written which covers any inspection of the licensee's and/or registrant's source of radiation, records, premises, or facilities. Copies of these inspection records shall be submitted to the licensee or registrant by the department upon the receipt of the written request of the licensee and/or registrant.

(4) Any person who resists, impedes, or in any manner interferes with, any individual who performs inspections which are related to any activity or facility registration/license issued by the department is subject to immediate license and/or registration certificate revocation as well as applicable civil and criminal penalties.

[Statutory Authority: RCW 43.70.040. 91-02-049 (Order 121), recodified as § 246-220-030, filed 12/27/90, effective 1/31/91. Statutory Authority: RCW 70.98.080. 83-19-050 (Order 2026), § 402-12-090, filed 9/16/83. Statutory Authority: RCW 70.98.050. 81-01-011 (Order 1570), § 402-12-090, filed 12/8/80; Order 1095, § 402-12-090, filed 2/6/76; Order 1, § 402-12-090, filed 1/8/69; Rules (part), filed 10/26/66.]

**WAC 246-220-040 Tests and surveys.** (1) Each licensee and registrant shall perform upon instructions from the department or shall permit the department to perform such reasonable tests and surveys as the department deems appropriate or necessary including, but not limited to, tests and surveys of:

- (a) Sources of radiation;
- (b) Facilities wherein sources of radiation are used or stored;
- (c) Radiation detection and monitoring instruments; and
- (d) Other equipment and devices used in connection with utilization or storage of licensed or registered sources of radiation.

(2) In accordance with the Public Disclosure Act, the department shall provide to the licensee and/or registrant copies of all tests and surveys conducted on the licensee's and/or registrant's sources of radiation, upon written request of the licensee and/or registrant. The department shall acknowledge the receipt of the request in a timely manner by telephone or letter.

[Statutory Authority: RCW 43.70.040. 91-02-049 (Order 121), recodified as § 246-220-040, filed 12/27/90, effective 1/31/91. Statutory Authority: RCW 70.98.050. 81-01-011 (Order 1570), § 402-12-100, filed 12/8/80; Order 1095, § 402-12-100, filed 2/6/76; Order 1, § 402-12-100, filed 1/8/69; Rules (part), filed 10/26/66.]

**WAC 246-220-050 Exemptions.** (1) The department may, upon application therefor or upon its own initiative, grant such exemptions or exceptions from the requirements of these regulations as it determines are authorized by law and will not result in undue hazard to public health and safety or property.

(2) Any U.S. Department of Energy contractor or subcontractor and any U.S. Nuclear Regulatory Commission contractor or subcontractor of the following categories operating within this state is exempt from these regulations to the extent that such contractor or subcontractor under the applicable contract receives, possesses, uses, transfers or acquires sources of radiation:

(a) Prime contractors performing work for the Department of Energy at U.S. government-owned or controlled sites, including the transportation of sources of radiation to or from such sites and the performance of contract services during temporary interruptions of such transportation;

(b) Prime contractors of the Department of Energy performing research in, or development, manufacture, storage, testing or transportation of, atomic weapons or components thereof;

(c) Prime contractors of the Department of Energy using or operating nuclear reactors or other nuclear devices in a United States government-owned vehicle or vessel; and

(d) Any other prime contractor or subcontractor of the Department of Energy or of the Nuclear Regulatory Commission when the state and the Nuclear Regulatory Commission jointly determine (i) that the exemption of the prime contractor or subcontractor is authorized by law, and (ii) that under the terms of the contract or subcontract, there is adequate assurance that the work thereunder can be accomplished without undue risk to the public health and safety.

[Statutory Authority: RCW 70.98.050 and 70.98.080. 91-15-112 (Order 184), § 246-220-050, filed 7/24/91, effective 8/24/91. Statutory Authority: RCW 43.70.040. 91-02-049 (Order 121), recodified as § 246-220-050, filed 12/27/90, effective 1/31/91. Statutory Authority: RCW 70.98.050. 81-01-011 (Order 1570), § 402-12-125, filed 12/8/80; Order 1095, § 402-12-125, filed 2/6/76.]

**WAC 246-220-060 Violations.** An injunction or other court order may be obtained prohibiting any violation of any provision of the act or any regulation or order issued thereunder. Any person who violates any provision of the act or any regulation or order issued thereunder may be guilty of a gross misdemeanor and upon conviction, may be punished by fine or imprisonment or both, as provided by law.

[Statutory Authority: RCW 43.70.040. 91-02-049 (Order 121), recodified as § 246-220-060, filed 12/27/90, effective 1/31/91; Order 1095, § 402-12-130, filed 2/6/76; Order 1, § 402-12-130, filed 1/8/69; Rules (part), filed 10/26/66.]

**WAC 246-220-070 Impounding.** Sources of radiation shall be subject to impoundment pursuant to RCW 70.98.-160.

[Statutory Authority: RCW 43.70.040. 91-02-049 (Order 121), recodified as § 246-220-070, filed 12/27/90, effective 1/31/91. Statutory Authority: RCW 70.98.080. 87-01-031 (Order 2450), § 402-12-140, filed 12/11/86; Order 1095, § 402-12-140, filed 2/6/76; Order 1, § 402-12-140, filed 1/8/69; Rules (part), filed 10/26/66.]

**WAC 246-220-080 Prohibited uses.** (1) Hand-held fluoroscopic screens shall not be used unless listed in the Registry of Sealed Sources and Devices or accepted for certifications by the United States Food and Drug Administration, Center for Devices and Radiological Health.

(2) Shoe-fitting fluoroscopic devices shall not be used.

[Statutory Authority: RCW 70.98.050, 94-01-073, § 246-220-080, filed 12/9/93, effective 1/9/94. Statutory Authority: RCW 43.70.040, 91-02-049 (Order 121), recodified as § 246-220-080, filed 12/27/90, effective 1/31/91; Order 1095, § 402-12-150, filed 2/6/76.]

**WAC 246-220-090 Communications.** All communications and reports concerning these regulations, and applications filed thereunder, should be addressed to the Department of Health, Division of Radiation Protection, P.O. Box 47827, Olympia, Washington 98504-7827. The emergency telephone number in Seattle, is 206-682-5327 or 206 (NUCLEAR).

[Statutory Authority: RCW 70.98.050, 94-01-073, § 246-220-090, filed 12/9/93, effective 1/9/94. Statutory Authority: RCW 70.98.050 and 70.98.080, 91-15-112 (Order 184), § 246-220-090, filed 7/24/91, effective 8/24/91. Statutory Authority: RCW 43.70.040, 91-02-049 (Order 121), recodified as § 246-220-090, filed 12/27/90, effective 1/31/91. Statutory Authority: RCW 70.98.080, 83-19-050 (Order 2026), § 402-12-160, filed 9/16/83. Statutory Authority: RCW 70.98.050, 81-01-011 (Order 1570), § 402-12-160, filed 12/8/80; Order 1095, § 402-12-160, filed 2/6/76.]

**WAC 246-220-100 Additional requirements.** The department may, by rule, regulation, or order, impose upon any licensee or registrant such requirements in addition to those established in these regulations as it deems appropriate or necessary to minimize danger to public health and safety or property.

[Statutory Authority: RCW 43.70.040, 91-02-049 (Order 121), recodified as § 246-220-100, filed 12/27/90, effective 1/31/91. Statutory Authority: RCW 70.98.050, 81-01-011 (Order 1570), § 402-12-170, filed 12/8/80; Order 1095, § 402-12-170, filed 2/6/76.]

**WAC 246-220-110 Appendix A—Determination of  $A_1$  and  $A_2$  values.** I. Single radionuclides.

(1) For a single radionuclide of known identity, the values of  $A_1$  and  $A_2$  are taken from Table A-1 if listed there. The values  $A_1$  and  $A_2$  in Table A-1 are also applicable for radionuclides contained in ( $\alpha$ , n) or ( $\gamma$ , n) neutron sources.

(2) For any single radionuclide whose identity is known but which is not listed in Table A-1, the values of  $A_1$  and  $A_2$  are determined according to the following procedure:

(a) If the radionuclide emits only one type of radiation,  $A_1$  is determined according to the rules in paragraphs (i), (ii), (iii) and (iv) of this paragraph. For radionuclides emitting different kinds of radiation,  $A_1$  is the most restrictive value of those determined for each kind of radiation. However, in both cases,  $A_1$  is restricted to a maximum of 37 TBq (1000 Ci). If a parent nuclide decays into a shorter lived daughter with a half-life not greater than 10 days,  $A_1$  is calculated for both the parent and the daughter, and the more limiting of the two values is assigned to the parent nuclide.

(i) For gamma emitters,  $A_1$  is determined by the expression:

$$A_1 = \frac{9}{\text{GRC}} \text{ curies}$$

where GRC is the gamma-ray constant, corresponding to the dose in R/h at 1 m per Ci; the number 9 results from the choice of 1 rem/h at a distance of 3 m as the reference dose-equivalent rate.

(ii) For X-ray emitters,  $A_1$  is determined by the atomic number of the nuclide:

$$\begin{aligned} \text{for } Z < 55, A_1 &= 37 \text{ TBq (1000 Ci)} \\ \text{for } Z > 55, A_1 &= 7.4 \text{ TBq (200 Ci)} \end{aligned}$$

where Z is the atomic number of the nuclide.

(iii) For beta emitters,  $A_1$  is determined by the maximum beta energy ( $E_{\text{max}}$ ) according to Table A-2;

(iv) For alpha emitters,  $A_1$  is determined by the expression:

$$A_1 = 1000 A_3$$

where  $A_3$  is the value listed in Table A-3;

(b)  $A_2$  is the more restrictive of the following two values:

- (i) The corresponding  $A_1$ ; and
- (ii) The value  $A_3$  obtained from Table A-3.

(3) For any single radionuclide whose identity is unknown, the value of  $A_1$  is taken to be 74 GBq (2 Ci) and the value of  $A_2$  is taken to be 74 MBq (0.002 Ci). However, if the atomic number of the radionuclide is known to be less than 82, the value of  $A_1$  is taken to be 370 GBq (10 Ci) and the value of  $A_2$  is taken to be 14.8 GBq (0.4 Ci).

II. Mixtures of radionuclides, including radioactive decay chains.

(1) For mixed fission products the following activity limits may be assumed if a detailed analysis of the mixture is not carried out:

$$\begin{aligned} A_1 &= 370 \text{ GBq (10 Ci)} \\ A_2 &= (14.8 \text{ GBq (0.4 Ci)}) \end{aligned}$$

(2) A single radioactive decay chain is considered to be a single radionuclide when the radionuclides are present in their naturally occurring proportions and no daughter nuclide has a half-life either longer than 10 days or longer than that of the parent nuclide. The activity to be taken into account and the  $A_1$  or  $A_2$  value from Table A-1 to be applied are those corresponding to the parent nuclide of that chain. When calculating  $A_1$  or  $A_2$  values, radiation emitted by daughters must be considered. However, in the case of radioactive decay chains in which any daughter nuclide has a half-life either longer than 10 days or greater than that of the parent nuclide, the parent and daughter nuclides are considered to be mixtures of different nuclides.

(3) In the case of a mixture of different radionuclides, where the identity and activity of each radionuclide are known, the permissible activity of each radionuclide  $R_1, R_2, \dots, R_n$  is such that  $F_1 + F_2 + \dots + F_n$  is not greater than unity, where

$$\begin{aligned} F_1 &= \frac{\text{Total activity of } R_1}{A_1(R_1)} \\ F_2 &= \frac{\text{Total activity of } R_2}{A_1(R_2)} \\ F_n &= \frac{\text{Total activity of } R_n}{A_1(R_n)} \end{aligned}$$

$A_1(R_1, R_2, \dots, R_n)$  is the value of  $A_1$  or  $A_2$  as appropriate for the nuclide  $R_1, R_2, R_n$ .

(4) When the identity of each radionuclide is known but the individual activities of some of the radionuclides are not

known, the formula given in paragraph (3) is applied to establish the values of  $A_1$  or  $A_2$  as appropriate. All the radionuclides whose individual activities are not known (their total activity will, however, be known) are classed in a single group and the most restrictive value of  $A_1$  and  $A_2$  applicable to any one of them is used as the value of  $A_1$  or  $A_2$  in the denominator of the fraction.

(5) Where the identity of each radionuclide is known but the individual activity of none of the radionuclides is

known, the most restrictive value of  $A_1$  or  $A_2$  applicable to any one of the radionuclides present is adopted as the applicable value.

(6) When the identity of none of the nuclides is known, the value of  $A_1$  is taken to be 74 GBq (2 Ci) and the value of  $A_2$  is taken to be 74 MBq (0.002 Ci). However, if alpha emitters are known to be absent, the value of  $A_2$  is taken to be 14.8 GBq (0.4 Ci).

TABLE A-1.— $A_1$  AND  $A_2$  VALUES FOR RADIONUCLIDES

(See footnotes at end of table)

Symbol of radionuclide	Element and atomic number	$A_1$ ( Ci)	$A_2$ (Ci)	Specific activity (Ci/g)
$^{227}_{Ac}$	Actinium (89)	1000	0.003	$7.2 \times 10$
$^{228}_{Ac}$		10	4	$2.2 \times 10^6$
$^{105}_{Ag}$	Silver (47)	40	40	$3.1 \times 10^4$
$^{110m}_{Ag}$		7	7	$4.7 \times 10^3$
$^{111}_{Ag}$		100	20	$1.6 \times 10^5$
$^{241}_{Am}$	Americium (95)	8	0.008	3.2
$^{243}_{Am}$		8	0.008	$1.9 \times 10^{-1}$
$^{37}_{Ar}$ (compressed or uncompressed)*	Argon (18)	1000	1000	$1.0 \times 10^5$
$^{41}_{Ar}$ (uncompressed)*		20	20	$4.3 \times 10^7$
$^{41}_{Ar}$ (compressed)*		1	1	$4.3 \times 10^7$
$^{73}_{As}$	Arsenic (33)	1000	400	$2.4 \times 10^4$
$^{74}_{As}$		20	20	$1.0 \times 10^5$
$^{76}_{As}$		10	10	$1.6 \times 10^6$
$^{77}_{As}$		300	20	$1.1 \times 10^6$
$^{211}_{At}$	Astatine (85)	200	7	$2.1 \times 10^6$
$^{193}_{Au}$	Gold (79)	200	200	$9.3 \times 10^5$
$^{196}_{Au}$		30	30	$1.2 \times 10^5$
$^{198}_{Au}$		40	20	$2.5 \times 10^5$
$^{199}_{Au}$		200	25	$2.1 \times 10^5$
$^{131}_{Ba}$	Barium (56)	40	40	$8.7 \times 10^4$
$^{133}_{Ba}$		40	10	$4.0 \times 10^2$
$^{140}_{Ba}$		20	20	$7.3 \times 10^4$
$^7_{Be}$	Beryllium (4)	300	300	$3.5 \times 10^5$
$^{206}_{Bi}$	Bismuth (83)	5	5	$9.9 \times 10^4$
$^{207}_{Bi}$		10	10	$2.2 \times 10^2$
$^{210}_{Bi}$ (RaE)		100	4	$1.2 \times 10^5$
$^{212}_{Bi}$		6	6	$1.5 \times 10^7$
$^{249}_{Bk}$	Berkelium (97)	1000	1	$1.8 \times 10^3$
$^{77}_{Br}$	Bromine (35)	70	25	$7.1 \times 10^5$
$^{82}_{Br}$		6	6	$1.1 \times 10^6$
$^{11}_{C}$	Carbon (6)	20	20	$8.4 \times 10^8$
$^{14}_{C}$		1000	60	4.6
$^{45}_{Ca}$	Calcium (20)	1000	25	$1.9 \times 10^4$
$^{47}_{Ca}$		20	20	$5.9 \times 10^5$
$^{109}_{Cd}$	Cadmium (48)	1000	70	$2.6 \times 10^3$
$^{115m}_{Cd}$		30	30	$2.6 \times 10^4$
$^{115}_{Cd}$		80	20	$5.1 \times 10^5$
$^{139}_{Ce}$	Cerium (58)	100	100	$6.5 \times 10^3$
$^{141}_{Ce}$		300	25	$2.8 \times 10^4$
$^{143}_{Ce}$		60	20	$6.6 \times 10^5$
$^{144}_{Ce}$		10	7	$3.2 \times 10^3$
$^{249}_{Cf}$	Californium (98)	2	0.002	3.1
$^{250}_{Cf}$		7	0.007	$1.3 \times 10^2$



$^{252}\text{Cf}$		2	0.009	$6.5 \times 10^2$
$^{36}\text{Cl}$	Chlorine (17)	300	10	$3.2 \times 10^{-2}$
$^{38}\text{Cl}$		10	10	$1.3 \times 10^8$
$^{242}\text{Cm}$	Curium (96)	200	0.2	$3.3 \times 10^3$
$^{243}\text{Cm}$		9	0.009	$4.2 \times 10$
$^{244}\text{Cm}$		10	0.01	$8.2 \times 10$
$^{245}\text{Cm}$		6	0.006	$1.0 \times 10^{-1}$
$^{246}\text{Cm}$		6	0.006	$3.6 \times 10^{-1}$
$^{56}\text{Co}$	Cobalt (27)	5	5	$3.0 \times 10^4$
$^{57}\text{Co}$		90	90	$8.5 \times 10^3$
$^{58\text{m}}\text{Co}$		1000	1000	$5.9 \times 10^6$
$^{58}\text{Co}$		20	20	$3.1 \times 10^4$
$^{60}\text{Co}$		7	7	$1.1 \times 10^3$
$^{51}\text{Cr}$	Chromium (24)	600	600	$9.2 \times 10^4$
$^{129}\text{Cs}$	Cesium (55)	40	40	$7.6 \times 10^5$
$^{131}\text{Cs}$		1000	1000	$1.0 \times 10^5$
$^{134\text{m}}\text{Cs}$		1000	10	$7.4 \times 10^6$
$^{134}\text{Cs}$		10	10	$1.2 \times 10^3$
$^{135}\text{Cs}$		1000	25	$8.8 \times 10^{-4}$
$^{136}\text{Cs}$		7	7	$7.4 \times 10^4$
$^{137}\text{Cs}$		30	10	$9.8 \times 10$
$^{64}\text{Cu}$	Copper (29)	80	25	$3.8 \times 10^6$
$^{67}\text{Cu}$		200	25	$7.9 \times 10^5$
$^{165}\text{Dy}$	Dysprosium (66)	100	20	$8.2 \times 10^6$
$^{166}\text{Dy}$		1000	200	$2.3 \times 10^5$
$^{169}\text{Er}$	Erbium (68)	1000	25	$8.2 \times 10^4$
$^{171}\text{Er}$		50	20	$2.4 \times 10^6$
$^{152\text{m}}\text{Eu}$	Europium (63)	30	30	$2.2 \times 10^6$
$^{152}\text{Eu}$		20	10	$1.9 \times 10^2$
$^{154}\text{Eu}$		10	5	$1.5 \times 10^2$
$^{155}\text{Eu}$		400	60	$1.4 \times 10^3$
$^{18}\text{F}$	Fluorine (9)	20	20	$9.3 \times 10^7$
$^{52}\text{Fe}$	Iron (26)	5	5	$7.3 \times 10^6$
$^{55}\text{Fe}$		1000	1000	$2.2 \times 10^3$
$^{59}\text{Fe}$		10	10	$4.9 \times 10^4$
$^{67}\text{Ga}$	Gallium (31)	100	100	$6.0 \times 10^5$
$^{68}\text{Ga}$		20	20	$4.0 \times 10^7$
$^{72}\text{Ga}$		7	7	$3.1 \times 10^6$
$^{153}\text{Gd}$	Gadolinium (64)	200	100	$3.6 \times 10^3$
$^{159}\text{Gd}$		300	20	$1.1 \times 10^6$
$^{68}\text{Ge}$	Germanium (32)	20	10	$7.0 \times 10^3$
$^{71}\text{Ge}$		1000	1000	$1.6 \times 10^5$
$^3\text{H}$	Hydrogen (1) see T-Tritium			
$^{181}\text{Hf}$	Hafnium (72)	30	25	$1.6 \times 10^4$
$^{197\text{m}}\text{Hg}$	Mercury (80)	200	200	$6.6 \times 10^5$
$^{197}\text{Hg}$		200	200	$2.5 \times 10^5$
$^{203}\text{Hg}$		80	25	$1.4 \times 10^4$
$^{166}\text{Ho}$	Holmium (67)	30	30	$6.9 \times 10^5$
$^{123}\text{I}$	Iodine (53)	50	50	$1.9 \times 10^6$
$^{125}\text{I}$		1000	70	$1.7 \times 10^4$
$^{126}\text{I}$		40	10	$7.8 \times 10^4$
$^{129}\text{I}$		1000	2	$1.6 \times 10^{-4}$
$^{131}\text{I}$		40	10	$1.2 \times 10^5$
$^{132}\text{I}$		7	7	$1.1 \times 10^7$
$^{133}\text{I}$		30	10	$1.1 \times 10^6$
$^{134}\text{I}$		8	8	$2.7 \times 10^7$
$^{135}\text{I}$		10	10	$3.5 \times 10^6$
$^{111}\text{In}$	Indium (49)	30	25	$4.2 \times 10^5$
$^{113\text{m}}\text{In}$		60	60	$1.6 \times 10^7$
$^{114\text{m}}\text{In}$		30	20	$2.3 \times 10^4$
$^{115\text{m}}\text{In}$		100	20	$6.1 \times 10^6$
$^{190}\text{Ir}$	Iridium (77)	10	10	$6.2 \times 10^4$

192 <sub>Ir</sub>		20	10	9.1X10 <sup>3</sup>
194 <sub>Ir</sub>		10	10	8.5X10 <sup>5</sup>
42 <sub>K</sub>	Potassium (19)	10	10	6.0X10 <sup>6</sup>
43 <sub>K</sub>		20	10	3.3X10 <sup>6</sup>
85m <sub>Kr</sub> (uncompressed)*	Krypton (36)	100	100	8.4X10 <sup>6</sup>
85m <sub>Kr</sub> (compressed)*		3	3	8.4X10 <sup>6</sup>
85 <sub>Kr</sub> (uncompressed)*		1000	1000	4.0X10 <sup>2</sup>
85 <sub>Kr</sub> (compressed)*		5	5	4.0X10 <sup>2</sup>
87 <sub>Kr</sub> (uncompressed)*		20	20	2.8X10 <sup>7</sup>
87 <sub>Kr</sub> (compressed)*		0.6	0.6	2.8X10 <sup>7</sup>
140 <sub>La</sub>	Lanthanum (57)	30	30	5.6X10 <sup>5</sup>
177 <sub>Lu</sub>	Lutetium (71)	300	25	1.1X10 <sup>5</sup>
MFP	Mixed fission products	10	0.4	
28 <sub>Mg</sub>	Magnesium (12)	6	6	5.2X10 <sup>6</sup>
52 <sub>Mn</sub>	Manganese (25)	5	5	4.4X10 <sup>5</sup>
54 <sub>Mn</sub>		20	20	8.3X10 <sup>3</sup>
56 <sub>Mn</sub>		5	5	2.2X10 <sup>7</sup>
99 <sub>Mo</sub>	Molybdenum (42)	100	20	4.7X10 <sup>5</sup>
13 <sub>N</sub>	Nitrogen (7)	20	10	1.5X10 <sup>9</sup>
22 <sub>Na</sub>	Sodium (11)	8	8	6.3X10 <sup>3</sup>
24 <sub>Na</sub>		5	5	8.7X10 <sup>6</sup>
93m <sub>Nb</sub>	Niobium (41)	1000	200	1.1X10 <sup>3</sup>
95 <sub>Nb</sub>		20	20	3.9X10 <sup>4</sup>
97 <sub>Nb</sub>		20	20	2.6X10 <sup>7</sup>
147 <sub>Nd</sub>	Neodymium (60)	100	20	8.0X10 <sup>4</sup>
149 <sub>Nd</sub>		30	20	1.1X10 <sup>7</sup>
59 <sub>Ni</sub>	Nickel (28)	1000	900	8.1X10 <sup>-2</sup>
63 <sub>Ni</sub>		1000	100	4.6X10
65 <sub>Ni</sub>		10	10	1.9X10 <sup>7</sup>
237 <sub>Np</sub>	Neptunium (93)	5	0.005	6.9X10 <sup>-4</sup>
239 <sub>Np</sub>		200	25	2.3X10 <sup>5</sup>
185 <sub>Os</sub>	Osmium (76)	20	20	7.3X10 <sup>3</sup>
191 <sub>Os</sub>		600	200	4.6X10 <sup>4</sup>
191m <sub>Os</sub>		200	200	1.2X10 <sup>6</sup>
193 <sub>Os</sub>		100	20	5.3X10 <sup>5</sup>
32 <sub>P</sub>	Phosphorus (15)	30	30	2.9X10 <sup>5</sup>
230 <sub>Pa</sub>	Protactinium (91)	20	0.8	3.2X10 <sup>4</sup>
231 <sub>Pa</sub>		2	0.002	4.5X10 <sup>-2</sup>
233 <sub>Pa</sub>		100	100	2.1X10 <sup>4</sup>
201 <sub>Pb</sub>	Lead (82)	20	20	1.7X10 <sup>6</sup>
210 <sub>Pb</sub>		100	0.2	8.8X10
212 <sub>Pb</sub>		6	5	1.4X10 <sup>6</sup>
103 <sub>Pd</sub>	Palladium (46)	1000	700	7.5X10 <sup>4</sup>
109 <sub>Pd</sub>		100	20	2.1X10 <sup>6</sup>
147 <sub>Pm</sub>	Promethium (61)	1000	25	9.4X10 <sup>2</sup>
149 <sub>Pm</sub>		100	20	4.2X10 <sup>5</sup>
210 <sub>Po</sub>	Polonium (84)	200	0.2	4.5X10 <sup>3</sup>
142 <sub>Pr</sub>	Praseodymium (59)	10	10	1.2X10 <sup>4</sup>
143 <sub>Pr</sub>		300	20	6.6X10 <sup>4</sup>
191 <sub>Pt</sub>	Platinum (78)	100	100	2.3X10 <sup>5</sup>
193m <sub>Pt</sub>		200	200	2.0X10 <sup>5</sup>
197m <sub>Pt</sub>		300	20	1.2X10 <sup>7</sup>
197 <sub>Pt</sub>		300	20	8.8X10 <sup>5</sup>
238 <sub>Pu</sub>	Plutonium (94)	3	0.003	1.7X10
239 <sub>Pu</sub>		2	0.002	6.2X10 <sup>-2</sup>
240 <sub>Pu</sub>		2	0.002	2.3X10 <sup>-1</sup>
241 <sub>Pu</sub>		1000	0.1	1.1X10 <sup>2</sup>
242 <sub>Pu</sub>		3	0.003	3.9X10 <sup>-3</sup>
223 <sub>Ra</sub>	Radium (88)	50	0.2	5.0X10 <sup>4</sup>
224 <sub>Ra</sub>		6	0.5	1.6X10 <sup>5</sup>
226 <sub>Ra</sub>		10	0.05	1.0
228 <sub>Ra</sub>		10	0.05	2.3X10 <sup>2</sup>

## Radiation Protection—General Provisions

246-220-110

222 <sub>Rn</sub>	Radon (86)	10	2	1.5X10 <sup>5</sup>
81 <sub>Rb</sub>	Rubidium (37)	30	25	8.2X10 <sup>6</sup>
86 <sub>Rb</sub>		30	30	8.1X10 <sup>4</sup>
87 <sub>Rb</sub>		Unlimited	Unlimited	6.6X10 <sup>-8</sup>
Rb(natural)		Unlimited	Unlimited	1.8X10 <sup>-5</sup>
186 <sub>Re</sub>	Rhenium (75)	100	20	1.9X10 <sup>5</sup>
187 <sub>Re</sub>		Unlimited	Unlimited	3.8X10 <sup>-8</sup>
188 <sub>Re</sub>		10	10	1.0X10 <sup>6</sup>
Re(natural)		Unlimited	Unlimited	2.4X10 <sup>-8</sup>
103m <sub>Rh</sub>	Rhodium (45)	1000	1000	3.2X10 <sup>7</sup>
105 <sub>Rh</sub>		200	25	8.2X10 <sup>5</sup>
97 <sub>Ru</sub>	Ruthenium (44)	80	80	5.5X10 <sup>5</sup>
103 <sub>Ru</sub>		30	25	3.2X10 <sup>4</sup>
105 <sub>Ru</sub>		20	20	6.6X10 <sup>6</sup>
106 <sub>Ru</sub>		10	7	3.4X10 <sup>3</sup>
35 <sub>S</sub>	Sulphur (16)	1000	60	4.3X10 <sup>4</sup>
122 <sub>Sb</sub>	Antimony (51)	30	30	3.9X10 <sup>5</sup>
124 <sub>Sb</sub>		5	5	1.8X10 <sup>4</sup>
125 <sub>Sb</sub>		40	25	1.4X10 <sup>3</sup>
46 <sub>Sc</sub>	Scandium (21)	8	8	3.4X10 <sup>4</sup>
47 <sub>Sc</sub>		200	20	8.2X10 <sup>5</sup>
48 <sub>Sc</sub>		5	5	1.5X10 <sup>6</sup>
75 <sub>Se</sub>	Selenium (34)	40	40	1.4X10 <sup>4</sup>
31 <sub>Si</sub>	Silicon (14)	100	20	3.9X10 <sup>7</sup>
147 <sub>Sm</sub>	Samarium (62)	Unlimited	Unlimited	2.0X10 <sup>-8</sup>
151 <sub>Sm</sub>		1000	90	2.6X10
153 <sub>Sm</sub>		300	20	4.4X10 <sup>5</sup>
113 <sub>Sn</sub>	Tin (50)	60	60	1.0X10 <sup>4</sup>
119m <sub>Sn</sub>		100	100	4.4X10 <sup>3</sup>
125 <sub>Sn</sub>		10	10	1.1X10 <sup>5</sup>
85m <sub>Sr</sub>	Strontium (38)	80	80	3.2X10 <sup>7</sup>
85 <sub>Sr</sub>		30	30	2.4X10 <sup>4</sup>
87m <sub>Sr</sub>		50	50	1.2X10 <sup>7</sup>
89 <sub>Sr</sub>		100	10	2.9X10 <sup>4</sup>
90 <sub>Sr</sub>		10	0.4	1.5X10 <sup>2</sup>
91 <sub>Sr</sub>		10	10	3.6X10 <sup>6</sup>
92 <sub>Sr</sub>		10	10	1.3X10 <sup>7</sup>
T(uncompressed)*	Tritium (1)	1000	1000	9.7X10 <sup>3</sup>
T(compressed)*		1000	1000	9.7X10 <sup>3</sup>
T(activated luminous paint)		1000	1000	9.7X10 <sup>3</sup>
T(absorbed on solid carrier)		1000	1000	9.7X10 <sup>3</sup>
T(tritiated water)		1000	1000	9.7X10 <sup>3</sup>
T(other forms)		20	20	9.7X10 <sup>3</sup>
182 <sub>Ta</sub>		Tantalum (73)	20	20
160 <sub>Tb</sub>	Terbium (65)	20	10	1.1X10 <sup>4</sup>
96m <sub>Tc</sub>	Technetium (43)	1000	1000	3.8X10 <sup>7</sup>
96 <sub>Tc</sub>		6	6	3.2X10 <sup>5</sup>
97m <sub>Tc</sub>		1000	200	1.5X10 <sup>4</sup>
97 <sub>Tc</sub>		1000	400	1.4X10 <sup>-3</sup>
99m <sub>Tc</sub>		100	100	5.2X10 <sup>6</sup>
99 <sub>Tc</sub>		1000	25	1.7X10 <sup>-2</sup>
125m <sub>Te</sub>		Tellurium (52)	1000	100
127M <sub>Te</sub>	300		20	4.0X10 <sup>4</sup>
127 <sub>Te</sub>	300		20	2.6X10 <sup>6</sup>
129M <sub>Te</sub>	30		10	2.5X10 <sup>4</sup>
129 <sub>Te</sub>	100		20	2.0X10 <sup>7</sup>
131m <sub>Te</sub>	10		10	8.0X10 <sup>5</sup>
132 <sub>Te</sub>		7	7	3.1X10 <sup>5</sup>
227 <sub>Th</sub>	Thorium (90)	200	0.2	3.2X10 <sup>4</sup>
228 <sub>Th</sub>		6	0.008	8.3X10 <sup>2</sup>
230 <sub>Th</sub>		3	0.003	1.9X10 <sup>-2</sup>
231 <sub>Th</sub>		1000	25	5.3X10 <sup>5</sup>

232 <sub>Th</sub>		Unlimited	Unlimited	1.1X10 <sup>-7</sup>
234 <sub>Th</sub>		10	10	2.3X10 <sup>4</sup>
Th(natural)		Unlimited	Unlimited	2.2X10 <sup>-7</sup>
Th(irradiated)**				
200 <sub>Tl</sub>	Thallium (81)	20	20	5.8X10 <sup>5</sup>
201 <sub>Tl</sub>		200	200	2.2X10 <sup>5</sup>
202 <sub>Tl</sub>		40	40	5.4X10 <sup>4</sup>
204 <sub>Tl</sub>		300	10	4.3X10 <sup>2</sup>
170 <sub>Tm</sub>	Thulium (69)	300	10	6.0X10 <sup>3</sup>
171 <sub>Tm</sub>		1000	100	1.1X10 <sup>3</sup>
230 <sub>U</sub>	Uranium (92)	100	0.1	2.7X10 <sup>4</sup>
232 <sub>U</sub>		30	0.03	2.1X10
233 <sub>U</sub>		100	0.1	9.5X10 <sup>-3</sup>
234 <sub>U</sub>		100	0.1	6.2X10 <sup>-3</sup>
235 <sub>U</sub>		100	0.2	2.1X10 <sup>-6</sup>
236 <sub>U</sub>		200	0.2	6.3X10 <sup>-5</sup>
238 <sub>U</sub>		Unlimited	Unlimited	3.3X10 <sup>-7</sup>
U(natural)		Unlimited	Unlimited	(SEE TABLE A-4)
U(enriched) < 20%		Unlimited	Unlimited	(SEE TABLE A-4)
	20% or greater	100	0.1	(SEE TABLE A-4)
U(depleted)		Unlimited	Unlimited	(SEE TABLE A-4)
U(irradiated)***				
48 <sub>V</sub>	Vanadium (23)	6	6	1.7X10 <sup>5</sup>
181 <sub>W</sub>	Tungsten (74)	200	100	5.0X10 <sup>3</sup>
185 <sub>W</sub>		1000	25	9.7X10 <sup>-3</sup>
187 <sub>W</sub>		40	20	7.0X10 <sup>5</sup>
127 <sub>Xe</sub> (uncompressed)*	Xenon (54)	70	70	2.8X10 <sup>4</sup>
127 <sub>Xe</sub> (compressed)*		5	5	2.8X10 <sup>4</sup>
131 <sub>m</sub> <sub>Xe</sub> (compressed)*		10	10	1.0X10 <sup>5</sup>
131 <sub>m</sub> <sub>Xe</sub> (uncompressed)*		100	100	1.0X10 <sup>5</sup>
133 <sub>Xe</sub> (uncompressed)*		1000	1000	1.9X10 <sup>5</sup>
133 <sub>Xe</sub> (compressed)*		5	5	1.9X10 <sup>5</sup>
135 <sub>Xe</sub> (uncompressed)*		70	70	2.5X10 <sup>5</sup>
135 <sub>Xe</sub> (compressed)*		2	2	2.5X10 <sup>5</sup>
87 <sub>Y</sub>	Yttrium (39)	20	20	4.5X10
90 <sub>Y</sub>		10	10	2.5X10 <sup>5</sup>
91 <sub>m</sub> <sub>Y</sub>		30	30	4.1X10 <sup>7</sup>
91 <sub>Y</sub>		30	30	2.5X10 <sup>4</sup>
92 <sub>Y</sub>		10	10	9.5X10 <sup>6</sup>
93 <sub>Y</sub>		10	10	3.2X10 <sup>6</sup>
169 <sub>Yb</sub>	Ytterbium (70)	80	80	2.3X10 <sup>5</sup>
175 <sub>Yb</sub>		400	25	1.8X10 <sup>5</sup>
65 <sub>Zn</sub>	Zinc (30)		30	308.0X10 <sup>3</sup>
69 <sub>m</sub> <sub>Zn</sub>		40	20	3.3X10 <sup>6</sup>
69 <sub>Zn</sub>		300	20	5.3X10 <sup>7</sup>
93 <sub>Zr</sub>	Zirconium (40)	1000	200	3.5X10 <sup>-3</sup>
95 <sub>Zr</sub>		20	20	2.1X10 <sup>4</sup>
97 <sub>Zr</sub>		20	20	2.0X10 <sup>6</sup>

\*For the purpose for Table A-1, compressed gas means a gas at a pressure which exceeds the ambient atmospheric pressure at the location where the containment system was closed.

\*\*The values of A<sub>1</sub> and A<sub>2</sub> must be calculated in accordance with the procedure specified in Appendix A, paragraph II(3), taking into account the activity of the fission products and of the uranium-233 in addition to that of the thorium.

\*\*\*The values of A<sub>1</sub> and A<sub>2</sub> must be calculated in accordance with the procedure specified in Appendix A, paragraph II(3), taking into account the activity of the fission products and plutonium isotopes in addition to that of the uranium.

TABLE A-2  
RELATIONSHIP BETWEEN A<sub>1</sub> AND E<sub>max</sub> FOR BETA EMITTERS

E <sub>max</sub> (MeV)	A <sub>1</sub> (Ci)
< 0.5	1000
0.5 - < 1.0	300
1.0 - < 1.5	100
1.5 - < 2.0	30
≥ 2.0	10

TABLE A-3  
RELATIONSHIP BETWEEN A<sub>3</sub> AND THE ATOMIC NUMBER OF THE RADIONUCLIDE

Atomic Number	A <sub>3</sub>		
	Half-life less than 1000 days	Half-life 1000 days to 10 <sup>6</sup> years	Half-life greater than 10 <sup>6</sup> years
1 to 81	3 Ci	.05 Ci	3 Ci
82 and above	.002 Ci	.002 Ci	3 Ci

TABLE A-4—ACTIVITY-MASS RELATIONSHIPS FOR URANIUM/THORIUM

Thorium and uranium enrichment <sup>1</sup> wt % <sup>235</sup> U present	Specific activity	
	Ci/g	g/Ci
0.45	5.0x10 <sup>-7</sup>	2.0x10 <sup>6</sup>
0.72 (natural)	7.06x10 <sup>-7</sup>	1.42x10 <sup>6</sup>
1.0	7.6x10 <sup>-7</sup>	1.3x10 <sup>6</sup>
1.5	1.0x10 <sup>-6</sup>	1.0x10 <sup>6</sup>
5.0	2.7x10 <sup>-6</sup>	3.7x10 <sup>5</sup>
10.0	4.8x10 <sup>-6</sup>	2.1x10 <sup>5</sup>
20.0	1.0x10 <sup>-5</sup>	1.0x10 <sup>5</sup>
35.0	2.0x10 <sup>-5</sup>	5.0x10 <sup>4</sup>
50.0	2.5x10 <sup>-5</sup>	4.0x10 <sup>4</sup>
90.0	5.8x10 <sup>-5</sup>	1.7x10 <sup>4</sup>
93.0	7.0x10 <sup>-5</sup>	1.4x10 <sup>4</sup>
95.0	9.1x10 <sup>-5</sup>	1.1x10 <sup>4</sup>
Natural Thorium	2.2x10 <sup>-7</sup>	4.6x10 <sup>6</sup>

<sup>1</sup> The figures for uranium include representative values for the activity of the uranium-234 which is concentrated during the enrichment process. The activity for Thorium includes the equilibrium concentration of Thorium-228.

[Statutory Authority: RCW 70.98.050. 95-01-108, § 246-220-110, filed 12/21/94, effective 1/21/95. Statutory Authority: RCW 43.70.040. 91-02-049 (Order 121), recodified as § 246-220-110, filed 12/27/90, effective 1/31/91. Statutory Authority: RCW 70.98.080. 87-01-031 (Order 2450), § 402-12-200, filed 12/11/86; Order 1095, § 402-12-200, filed 2/6/76.]

**WAC 246-220-120 Appendix B—Information on transportation special form licensed material.** (1) "Special form" means any of the following physical forms of licensed material:

(a) The material is in solid form having no dimension less than 0.5 millimeter or at least one dimension greater than five millimeters; does not melt, sublime, or ignite in air at a temperature of 1,000 degrees Fahrenheit; will not shatter or crumble if subjected to the percussion test described in this section; and is not dissolved or converted into dispersible form to the extent of more than 0.005 percent by weight

by immersion for one week in water at 68 degrees Fahrenheit or in air at 86 degrees Fahrenheit; or

(b) The material is securely contained in a capsule having no dimension less than 0.5 millimeter or at least one dimension greater than five millimeters, which will retain its contents if subjected to the tests prescribed in this section; and which is constructed of materials which do not melt, sublime, or ignite in air at 1,475 degrees Fahrenheit, and do not dissolve, or convert into dispersible form, to the extent of more than 0.005 percent by weight by immersion for one week in water at 68 degrees Fahrenheit or in air at 86 degrees Fahrenheit.

(2) *Tests for special form licensed material.*

(a) Free drop - A free drop through a distance of thirty feet onto a flat essentially unyielding horizontal surface, striking the surface in such a position as to suffer maximum damage.

(b) Percussion - Impact of the flat circular end of a one inch diameter steel rod weighing three pounds, dropped through a distance of forty inches. The capsule or material shall be placed on a sheet of lead, of hardness number 3.5 to 4.5 on the Vickers scale, and not more than one inch thick, supported by a smooth essentially unyielding surface.

(c) Heating - Heating in air to a temperature of 1,475 degrees Fahrenheit and remaining at that temperature for a period of ten minutes.

(d) Immersion - Immersion for twenty-four hours in water at room temperature. The water shall be at pH 6-pH 8, with a maximum conductivity of ten micromhos per centimeter.

[Statutory Authority: RCW 70.98.050. 94-01-073, § 246-220-120, filed 12/9/93, effective 1/9/94. Statutory Authority: RCW 43.70.040. 91-02-049 (Order 121), recodified as § 246-220-120, filed 12/27/90, effective 1/31/91. Statutory Authority: RCW 70.98.080. 87-01-031 (Order 2450), § 402-12-210, filed 12/11/86; Order 1095, § 402-12-210, filed 2/6/76.]

**WAC 246-220-130 Appendix C—The international system of units (SI). Conversion factors.**

Multiply	by	to obtain
becquerels	2.703 x 10 <sup>-11</sup>	curies
becquerels	2.703 x 10 <sup>-8</sup>	millicuries
curies	3.700 x 10 <sup>10</sup>	becquerels
curies	2.220 x 10 <sup>12</sup>	disintegrations/min (dpm)
curies	10 <sup>3</sup>	millicuries
curies	10 <sup>6</sup>	microcuries
curies	10 <sup>12</sup>	picocuries
dis/min (dpm)	4.505 x 10 <sup>-10</sup>	millicuries
dis/min (dpm)	4.505 x 10 <sup>-7</sup>	microcuries
dis/sec (Bq)	2.703 x 10 <sup>-8</sup>	millicuries
dis/sec (Bq)	2.703 x 10 <sup>-5</sup>	microcuries
gray	100	rad
microcuries	3.700 x 10 <sup>4</sup>	becquerels
microcuries	2.220 x 10 <sup>6</sup>	disintegrations/min (dpm)
millicuries	3.700 x 10 <sup>7</sup>	becquerels
millicuries	2.220 x 10 <sup>9</sup>	disintegrations/min (dpm)
rad	0.01	gray
rem	0.01	sievert
sievert	100	rem

[Statutory Authority: RCW 70.98.050. 94-01-073, § 246-220-130, filed 12/9/93, effective 1/9/94. Statutory Authority: RCW 70.98.050 and 70.98.080. 91-15-112 (Order 184), § 246-220-130, filed 7/24/91, effective 8/24/91. Statutory Authority: RCW 43.70.040. 91-02-049 (Order 121), recodified as § 246-220-130, filed 12/27/90, effective 1/31/91. Statutory Authority: RCW 70.98.050. 81-01-011 (Order 1570), § 402-12-250, filed 12/8/80.]

## Chapter 246-221 WAC

## RADIATION PROTECTION STANDARDS

## WAC

246-221-001	Purpose and scope.
246-221-005	Radiation protection programs.
246-221-010	Occupational dose limits for adults.
246-221-015	Compliance with requirements for summation of external and internal doses.
246-221-020	Determination of prior occupational dose.
246-221-030	Requirements for planned special exposures.
246-221-040	Determination of internal exposure of individuals to concentrations of radioactive materials in restricted areas.
246-221-050	Occupational dose limits for minors.
246-221-055	Dose to an embryo/fetus.
246-221-060	Dose limits for individual members of the public.
246-221-070	Compliance with dose limits for individual members of the public.
246-221-080	Leak tests.
246-221-090	Personnel monitoring for external dose.
246-221-100	Personnel monitoring for internal dose.
246-221-102	Control of access to high radiation areas.
246-221-104	Control of access to very high radiation areas.
246-221-106	Control of access to very high radiation areas— Irradiators.
246-221-110	Surveys.
246-221-113	Use of process, engineering or other controls.
246-221-117	Use of individual respiratory protection equipment.
246-221-120	Caution signs, and labels.
246-221-130	Exceptions from posting and labeling requirements.
246-221-140	Instruction of personnel.
246-221-150	Security and control of stored radioactive material and radiation machines.
246-221-160	Procedures for picking up, receiving, and opening packages.
246-221-170	Waste disposal, general requirement.
246-221-180	Method of obtaining approval of proposed disposal procedures.
246-221-190	Disposal by release into sanitary sewerage systems.
246-221-200	Disposal by burial in soil.
246-221-210	Disposal by incineration.
246-221-220	Disposal of specific wastes.
246-221-230	Records important to radiation safety.
246-221-240	Reports of stolen, lost or missing radiation sources.
246-221-250	Notification of incidents.
246-221-260	Reports of overexposures and excessive levels and concentrations.
246-221-265	Special reports to the department—Planned special exposures, individual monitoring results from certain licensees, and leaking sources.
246-221-270	Vacating premises and release of equipment.
246-221-275	Notification of changes in a facility.
246-221-280	Notifications and reports to individuals.
246-221-285	Protection factors for respirators.
246-221-290	Appendix A—Annual limits on intake (ALI) and derived air concentrations (DAC) of radionuclides for occupational exposure; effluent concentrations; concentrations for release to sanitary sewerage.
246-221-300	Appendix B—Minimum quantities of radioactive material requiring labeling.

standards for protection against radiation prescribed in this chapter.

(2) The limits in this chapter do not apply to doses due to background radiation, to exposure of patients to radiation for the purpose of medical diagnosis or therapy, or to voluntary participation in medical research programs.

(3) Nothing in this chapter shall be interpreted as limiting actions that may be necessary to protect health and safety in an emergency.

(4) The definitions contained in WAC 246-220-010 also apply to this chapter. WAC 246-220-007, Statement of philosophy, is directly applicable to this chapter.

[Statutory Authority: RCW 70.98.050. 94-01-073, § 246-221-001, filed 12/9/93, effective 1/9/94. Statutory Authority: RCW 70.98.050 and 70.98.080. 91-15-112 (Order 184), § 246-221-001, filed 7/24/91, effective 8/24/91. Statutory Authority: RCW 43.70.040. 91-02-049 (Order 121), recodified as § 246-221-001, filed 12/27/90, effective 1/31/91; Order 1095, § 402-24-010, filed 2/6/76; Order 1, § 402-24-010, filed 1/8/69; Rules (part), filed 10/26/66.]

**WAC 246-221-005 Radiation protection programs.**

(1) Each specific licensee shall develop, document, and implement a radiation protection program sufficient to ensure compliance with the provisions of this chapter.

(2) The licensee shall use, to the extent practicable, procedures and engineering controls based upon sound radiation protection principles to achieve occupational doses and doses to members of the public that are as low as is reasonably achievable (ALARA).

(3) The licensee shall review the radiation protection program content and implementation at the frequency specified in the license.

(4) Each licensee shall maintain records of the radiation protection program, including:

(a) The provisions of the program; and

(b) Audits, where required, and other reviews of program content and implementation.

[Statutory Authority: RCW 70.98.050. 94-01-073, § 246-221-005, filed 12/9/93, effective 1/9/94.]

**WAC 246-221-010 Occupational dose limits for adults.** (1) The licensee or registrant shall control the occupational dose to individual adults, except for planned special exposures pursuant to WAC 246-221-030, to the following dose limits:

(a) An annual limit, which is the more limiting of:

(i) The total effective dose equivalent being equal to 0.05 Sv (5 rem); or

(ii) The sum of the deep dose equivalent and the committed dose equivalent to any individual organ or tissue other than the lens of the eye being equal to 0.50 Sv (50 rem).

(b) The annual limits to the lens of the eye, to the skin, and to the extremities which are:

(i) An eye dose equivalent of 0.15 Sv (15 rem); and

(ii) A shallow dose equivalent of 0.50 Sv (50 rem) to the skin or to any extremity.

(2) Doses received in excess of the annual limits, including doses received during accidents, emergencies, and planned special exposures, must be subtracted from the limits specified in WAC 246-221-030 for planned special

**WAC 246-221-001 Purpose and scope.** (1) This chapter establishes standards for protection against radiation hazards. Except as otherwise specifically provided, this chapter applies to all licensees or registrants. The requirements of this chapter are designed to control the receipt, possession, use, transfer, and disposal of sources of radiation by any licensee or registrant so the total dose to an individual, including doses resulting from all sources of radiation other than background radiation, does not exceed the



exposures that the individual may receive during the current year and during the individual's lifetime.

(3) The assigned deep dose equivalent and shallow dose equivalent shall be for the portion of the body receiving the highest exposure. The deep dose equivalent, eye dose equivalent and shallow dose equivalent may be assessed from surveys or other radiation measurements for the purpose of demonstrating compliance with the occupational dose limits, if the individual monitoring device was not in the region of highest potential exposure, or the results of individual monitoring are unavailable.

(4) Derived air concentration (DAC) and annual limit on intake (ALI) values are specified in WAC 246-221-290 and may be used to determine the individual's dose and to demonstrate compliance with the occupational dose limits.

(5) Notwithstanding the annual dose limits, the licensee shall limit the soluble uranium intake by an individual to 10 milligrams in a week in consideration of chemical toxicity.

(6) The licensee or registrant shall reduce the dose that an individual may be allowed to receive in the current year by the amount of occupational dose received while employed by any other person during the current year as determined in accordance with WAC 246-221-020.

[Statutory Authority: RCW 70.98.050. 94-01-073, § 246-221-010, filed 12/9/93, effective 1/9/94. Statutory Authority: RCW 70.98.050 and 70.98.080. 91-15-112 (Order 184), § 246-221-010, filed 7/24/91, effective 8/24/91. Statutory Authority: RCW 43.70.040. 91-02-049 (Order 121), recodified as § 246-221-010, filed 12/27/90, effective 1/31/91. Statutory Authority: RCW 70.98.080. 87-01-031 (Order 2450), § 402-24-020, filed 12/11/86. Statutory Authority: RCW 70.98.050. 81-01-011 (Order 1570), § 402-24-020, filed 12/8/80; Order 1095, § 402-24-020, filed 2/6/76; Order 1, § 402-24-020, filed 1/8/69; Rules (part), filed 10/26/66.]

**WAC 246-221-015 Compliance with requirements for summation of external and internal doses.** (1) If the licensee is required to monitor pursuant to both WAC 246-221-090 and 246-221-100, the licensee shall demonstrate compliance with the dose limits by summing external and internal doses. If the licensee is required to monitor only pursuant to WAC 246-221-090 or only pursuant to WAC 246-221-100, then summation is not required to demonstrate compliance with the dose limits. The licensee may demonstrate compliance with the requirements for summation of external and internal doses pursuant to subsections (2), (3), and (4) of this section. The dose equivalents for the lens of the eye, the skin, and the extremities are not included in the summation, but are subject to separate limits.

(2) **Intake by inhalation.** If the only intake of radionuclides is by inhalation, the total effective dose equivalent limit is not exceeded if the sum of the deep dose equivalent divided by the total effective dose equivalent limit, and one of the following, does not exceed unity:

(a) The sum of the fractions of the inhalation ALI for each radionuclide; or

(b) The total number of derived air concentration-hours (DAC-hours) for all radionuclides divided by two thousand; or

(c) The sum of the calculated committed effective dose equivalents to all significantly irradiated organs or tissues (T) calculated from bioassay data using appropriate biological models and expressed as a fraction of the annual limit. For purposes of this requirement, an organ or tissue is deemed to be significantly irradiated if, for that organ or tissue, the

product of the weighting factors,  $w_T$ , and the committed dose equivalent,  $H_{T,50}$ , per unit intake is greater than ten percent of the maximum weighted value of  $H_{50}$ , that is,  $w_T H_{T,50}$ , per unit intake for any organ or tissue.

(3) **Intake by oral ingestion.** If the occupationally exposed individual also receives an intake of radionuclides by oral ingestion greater than ten percent of the applicable oral ALI, the licensee shall account for this intake and include it in demonstrating compliance with the limits.

(4) **Intake through wounds or absorption through skin.** The licensee shall evaluate and, to the extent practical, account for intakes through wounds or skin absorption. The intake through intact skin has been included in the calculation of DAC for hydrogen-3 and does not need to be evaluated or accounted for pursuant to this section.

(5) **External dose from airborne radioactive material.** Licensees shall, when determining the dose from airborne radioactive material, include the contribution to the deep dose equivalent, eye dose equivalent, and shallow dose equivalent from external exposure to the radioactive cloud. Airborne radioactivity measurements and DAC values shall not be used as the primary means to assess the deep dose equivalent when the airborne radioactive material includes radionuclides other than noble gases or if the cloud of airborne radioactive material is not relatively uniform. The determination of the deep dose equivalent to an individual shall be based upon measurements using instruments or individual monitoring devices.

[Statutory Authority: RCW 70.98.050. 94-01-073, § 246-221-015, filed 12/9/93, effective 1/9/94.]

**WAC 246-221-020 Determination of prior occupational dose.** (1) For each individual who may enter the licensee's or registrant's restricted area and is likely to receive, in a year, an occupational dose requiring monitoring pursuant to WAC 246-221-090 and 246-221-100, the licensee or registrant shall:

(a) Determine the occupational radiation dose received during the current year; and

(b) Attempt to obtain the records of lifetime cumulative occupational radiation dose.

(2) Prior to permitting an individual to participate in a planned special exposure, the licensee or registrant shall determine:

(a) The internal and external doses from all previous planned special exposures; and

(b) All doses in excess of the limits, including doses received during accidents and emergencies, received during the lifetime of the individual.

(3) In complying with the requirements of subsection (1) of this section, a licensee or registrant may:

(a) Accept, as a record of the occupational dose that the individual received during the current year, a written signed statement from the individual, or from the individual's most recent employer for work involving radiation exposure, that discloses the nature and the amount of any occupational dose that the individual received during the current year; and

(b) Accept, as the record of lifetime cumulative radiation dose, an up-to-date Form RHF-4A, or equivalent, signed by the individual and countersigned by an appropriate official of the most recent employer for work involving

radiation exposure, or the individual's current employer, if the individual is not employed by the licensee or registrant; and

(c) Obtain reports of the individual's dose equivalent from the most recent employer for work involving radiation exposure, or the individual's current employer, if the individual is not employed by the licensee or registrant, by telephone, telegram, facsimile, or letter. The licensee or registrant shall request a written verification of the dose data if the authenticity of the transmitted report cannot be established.

(4) The licensee or registrant shall record the exposure history, as required by subsection (1) of this section, on Form RHF-4A, or other clear and legible record, of all the information required on that form. The form or record shall show each period in which the individual received occupational exposure to radiation or radioactive material and shall be signed by the individual who received the exposure. For each period for which the licensee or registrant obtains reports, the licensee or registrant shall use the dose shown in the report in preparing Form RHF-4A. For any period in which the licensee or registrant does not obtain a report, the licensee or registrant shall place a notation on Form RHF-4A indicating the periods of time for which data are not available.

(5) Licensees or registrants are not required to reevaluate the separate external dose equivalents and internal committed dose equivalents or intakes of radionuclides assessed under the regulations in effect before January 1, 1994. Further, occupational exposure histories obtained and recorded on Form RHF-4 before January 1, 1994, would not have included effective dose equivalent, but may be used in the absence of specific information on the intake of radionuclides by the individual.

(6) If the licensee or registrant is unable to obtain a complete record of an individual's current and previously accumulated occupational dose, the licensee or registrant shall assume:

(a) In establishing administrative controls under WAC 246-221-010(6) for the current year, that the allowable dose limit for the individual is reduced by 12.5 mSv (1.25 rem) for each calendar quarter for which records were unavailable and the individual was engaged in activities that could have resulted in occupational radiation exposure; and

(b) That the individual is not available for planned special exposures.

(7) The licensee or registrant shall retain the records on Form RHF-4A or equivalent until the department terminates each pertinent license requiring this record. The licensee or registrant shall retain records used in preparing Form RHF-4 or RHF-4A for three years after the record is made.

[Statutory Authority: RCW 70.98.050. 94-01-073, § 246-221-020, filed 12/9/93, effective 1/9/94. Statutory Authority: RCW 70.98.050 and 70.98.080. 91-15-112 (Order 184), § 246-221-020, filed 7/24/91, effective 8/24/91. Statutory Authority: RCW 43.70.040. 91-02-049 (Order 121), recodified as § 246-221-020, filed 12/27/90, effective 1/31/91. Statutory Authority: RCW 70.98.050. 81-01-011 (Order 1570), § 402-24-024, filed 12/8/80; Order 1095, § 402-24-024, filed 2/6/76.]

**WAC 246-221-030 Requirements for planned special exposures.** A licensee or registrant may authorize an adult worker to receive doses in addition to and account-

ed for separately from the doses received under the limits specified in WAC 246-221-010 provided that each of the following conditions is satisfied:

(1) The licensee or registrant authorizes a planned special exposure only in an exceptional situation when alternatives that might avoid the higher exposure are unavailable or impractical.

(2) The licensee or registrant, and employer if the employer is not the licensee or registrant, specifically authorizes the planned special exposure, in writing, before the exposure occurs.

(3) Before a planned special exposure, the licensee or registrant ensures that each individual involved is:

(a) Informed of the purpose of the planned operation; and

(b) Informed of the estimated doses and associated potential risks and specific radiation levels or other conditions that might be involved in performing the task; and

(c) Instructed in the measures to be taken to keep the dose ALARA considering other risks that may be present.

(4) Prior to permitting an individual to participate in a planned special exposure, the licensee or registrant ascertains prior doses as required by WAC 246-221-020(2) during the lifetime of the individual for each individual involved.

(5) Subject to WAC 246-221-010(2), the licensee or registrant shall not authorize a planned special exposure that would cause an individual to receive a dose from all planned special exposures and all doses in excess of the limits to exceed:

(a) The numerical values of any of the dose limits in WAC 246-221-010(1) in any year; and

(b) Five times the annual dose limits in WAC 246-221-010(1) during the individual's lifetime.

(6) The licensee or registrant maintains records that describe:

(a) The exceptional circumstances requiring the use of a planned special exposure; and

(b) The name of the management official who authorized the planned special exposure and a copy of the signed authorization; and

(c) What actions were necessary; and

(d) Why the actions were necessary; and

(e) What precautions were taken to assure that doses were maintained ALARA; and

(f) What individual and collective doses were expected to result.

(7) The licensee or registrant records the best estimate of the dose resulting from the planned special exposure in the individual's record and informs the individual, in writing, of the dose within thirty days from the date of the planned special exposure. The dose from planned special exposures shall not be considered in controlling future occupational dose of the individual pursuant to WAC 246-221-010(1) but shall be included in evaluations required by subsections (4) and (5) of this section.

(8) The licensee or registrant submits a written report in accordance with WAC 246-221-265.

[Statutory Authority: RCW 70.98.050. 94-01-073, § 246-221-030, filed 12/9/93, effective 1/9/94. Statutory Authority: RCW 70.98.050 and 70.98.080. 91-15-112 (Order 184), § 246-221-030, filed 7/24/91, effective 8/24/91. Statutory Authority: RCW 43.70.040. 91-02-049 (Order 121), recodified as § 246-221-030, filed 12/27/90, effective 1/31/91. Statutory

Authority: RCW 70.98.050. 81-01-011 (Order 1570), § 402-24-027, filed 12/8/80.]

**WAC 246-221-040 Determination of internal exposure of individuals to concentrations of radioactive materials in restricted areas.** For purposes of assessing dose used to determine compliance with occupational dose equivalent limits, the licensee shall, when required under WAC 246-221-100, take suitable and timely measurements of:

(a) Concentrations of radioactive materials in air in work areas; or

(b) Quantities of radionuclides in the body; or

(c) Quantities of radionuclides excreted from the body;

or

(d) Combinations of these measurements.

(2) Unless respiratory protective equipment is used, as provided in WAC 246-221-117, or the assessment of intake is based on bioassays, the licensee shall assume that an individual inhales radioactive material at the airborne concentration in which the individual is present.

(3) When specific information on the physical and biochemical properties of the radionuclides taken into the body or the behavior or the material in an individual is known, the licensee may:

(a) Use that information to calculate the committed effective dose equivalent, and, if used, the licensee shall document that information in the individual's record; and

(b) Upon prior approval of the department, adjust the DAC or ALI values to reflect the actual physical and chemical characteristics of airborne radioactive material, for example, aerosol size distribution or density; and

(c) Separately assess the contribution of fractional intakes of Class D, W, or Y compounds of a given radionuclide to the committed effective dose equivalent. See WAC 246-221-290.

(4) If the licensee chooses to assess intakes of Class Y material using the measurements given in subsection (1)(b) or (c) of this section, the licensee may delay the recording and reporting of the assessments for periods up to seven months, unless otherwise required by WAC 246-221-250 or 246-221-260. This delay permits the licensee to make additional measurements basic to the assessments.

(5) If the identity and concentration of each radionuclide in a mixture are known, the fraction of the DAC applicable to the mixture for use in calculating DAC-hours shall be either:

(a) The sum of the ratios of the concentration to the appropriate DAC value, that is, D, W, or Y, from WAC 246-221-290 for each radionuclide in the mixture; or

(b) The ratio of the total concentration for all radionuclides in the mixture to the most restrictive DAC value for any radionuclide in the mixture.

(6) If the identity of each radionuclide in a mixture is known, but the concentration of one or more of the radionuclides in the mixture is not known, the DAC for the mixture shall be the most restrictive DAC of any radionuclide in the mixture.

(7) When a mixture of radionuclides in air exists, a licensee may disregard certain radionuclides in the mixture if:

(a) The licensee uses the total activity of the mixture in demonstrating compliance with the dose limits in WAC 246-221-010 and in complying with the monitoring requirements in WAC 246-221-100; and

(b) The concentration of any radionuclide disregarded is less than ten percent of its DAC; and

(c) The sum of these percentages for all of the radionuclides disregarded in the mixture does not exceed thirty percent.

(8) When determining the committed effective dose equivalent, the following information may be considered:

(a) In order to calculate the committed effective dose equivalent, the licensee may assume that the inhalation of one ALI, or an exposure of 2,000 DAC-hours, results in a committed effective dose equivalent of 0.05 Sv (5 rem) for radionuclides that have their ALIs or DACs based on the committed effective dose equivalent.

(b) For an ALI and the associated DAC determined by the nonstochastic organ dose limit of 0.50 Sv (50 rem), the intake of radionuclides that would result in a committed effective dose equivalent of 0.05 Sv (5 rem), that is, the stochastic ALI, is listed in parentheses in Table I of WAC 246-221-290. The licensee may, as a simplifying assumption, use the stochastic ALIs to determine committed effective dose equivalent. However, if the licensee uses the stochastic ALIs, the licensee shall also demonstrate that the limit in WAC 246-221-010 (1)(a)(ii) is met.

[Statutory Authority: RCW 70.98.050. 94-01-073, § 246-221-040, filed 12/9/93, effective 1/9/94. Statutory Authority: RCW 70.98.050 and 70.98.080. 91-15-112 (Order 184), § 246-221-040, filed 7/24/91, effective 8/24/91. Statutory Authority: RCW 43.70.040. 91-02-049 (Order 121), recodified as § 246-221-040, filed 12/27/90, effective 1/31/91. Statutory Authority: RCW 70.98.050. 81-01-011 (Order 1570), § 402-24-030, filed 12/8/80; Order 1095, § 402-24-030, filed 2/6/76; Order 1, § 402-24-030, filed 1/8/69; Rules (part), filed 10/26/66.]

**WAC 246-221-050 Occupational dose limits for minors.** No licensee or registrant shall possess, use, or transfer sources of radiation in such a manner as to cause any occupationally exposed individual who is under 18 years of age, to receive a dose in excess of 10 percent of the annual occupational dose limits specified in WAC 246-221-010(1).

[Statutory Authority: RCW 70.98.050. 94-01-073, § 246-221-050, filed 12/9/93, effective 1/9/94. Statutory Authority: RCW 70.98.050 and 70.98.080. 91-15-112 (Order 184), § 246-221-050, filed 7/24/91, effective 8/24/91. Statutory Authority: RCW 43.70.040. 91-02-049 (Order 121), recodified as § 246-221-050, filed 12/27/90, effective 1/31/91. Statutory Authority: RCW 70.98.050. 81-01-011 (Order 1570), § 402-24-035, filed 12/8/80; Order 1095, § 402-24-035, filed 2/6/76.]

**WAC 246-221-055 Dose to an embryo/fetus.** (1) The licensee or registrant shall ensure that the dose to an embryo/fetus during the entire pregnancy, due to occupational exposure of a declared pregnant woman, does not exceed 5 mSv (0.5 rem).

(2) Once pregnancy has been declared, the licensee or registrant shall make every effort to avoid substantial variation above a uniform monthly exposure rate to a declared pregnant woman so as to satisfy the limit in subsection (1) of this section.

(3) If by the time the woman declares pregnancy to the licensee or registrant, the dose to the embryo/fetus has

exceeded 4.5 mSv (0.45 rem), the licensee or registrant shall be deemed to be in compliance with subsection (1) of this section if the additional dose to the embryo/fetus does not exceed 0.50 mSv (0.05 rem) during the remainder of the pregnancy.

(4) The dose to an embryo/fetus shall be taken as the sum of:

(a) The calculated dose equivalent to the embryo/fetus resulting from external exposure of the declared pregnant woman or, in the absence of this information, the deep dose equivalent to the declared pregnant woman; and

(b) The dose to the embryo/fetus from radionuclides in the embryo/fetus and radionuclides in the declared pregnant woman.

(5) The licensee or registrant shall maintain the records of dose to an embryo/fetus with the records of dose to the declared pregnant woman. The declaration of pregnancy, including the estimated date of conception, shall also be kept on file, but may be maintained separately from the dose records.

[Statutory Authority: RCW 70.98.050. 94-01-073, § 246-221-055, filed 12/9/93, effective 1/9/94.]

**WAC 246-221-060 Dose limits for individual members of the public.** (1) Each licensee or registrant shall conduct operations so that:

(a) The total effective dose equivalent to individual members of the public from the licensed or registered operation does not exceed 1 mSv (0.1 rem) in a year, exclusive of the dose contribution from the licensee's or registrant's disposal of radioactive material into sanitary sewerage in accordance with WAC 246-221-190; and

(b) The dose in any unrestricted area from external sources does not exceed 0.02 mSv (0.002 rem) in any one hour.

(2) If the licensee or registrant permits members of the public to have access to restricted areas, they shall be escorted and the limits for members of the public continue to apply to those individuals.

(3) Notwithstanding subsection (1) of this section, a licensee or registrant may continue to operate a facility constructed and put into operation prior to January 1, 1994, where the annual dose limit for an individual member of the public is more than 1 mSv (0.1 rem) and less than 5 mSv (0.5 rem) total effective dose equivalent, provided:

(a) The facility's approved operating conditions for each radiation source remain the same. Any increase in the following operating conditions shall require reevaluation and/or modification of the facility shielding applicable to the source of radiation to meet the 1 mSv (0.1 rem) total effective dose equivalent limit for individual members of the public: size of the radiation source, workload, or occupancy factors associated with the source of radiation; and

(b) Any change in the permanent shielding of the facility due to remodeling, repair or replacement shall require the facility to meet the 1 mSv (0.1 rem) total effective dose equivalent limit for individual members of the public for areas affected by that portion of the shielding.

(4) Each licensee or registrant shall maintain records sufficient to demonstrate compliance with the dose limit for individual members of the public.

[Statutory Authority: RCW 70.98.050. 94-01-073, § 246-221-060, filed 12/9/93, effective 1/9/94. Statutory Authority: RCW 70.98.050 and 70.98.080. 91-15-112 (Order 184), § 246-221-060, filed 7/24/91, effective 8/24/91. Statutory Authority: RCW 43.70.040. 91-02-049 (Order 121), recodified as § 246-221-060, filed 12/27/90, effective 1/31/91. Statutory Authority: RCW 70.98.080. 87-01-031 (Order 2450), § 402-24-040, filed 12/11/86. Statutory Authority: RCW 70.98.050. 81-01-011 (Order 1570), § 402-24-040, filed 12/8/80; Order 1095, § 402-24-040, filed 2/6/76; Order 1, § 402-24-040, filed 1/8/69; Rules (part), filed 10/26/66.]

**WAC 246-221-070 Compliance with dose limits for individual members of the public.** (1) The licensee shall make or cause to be made surveys of radiation levels in unrestricted areas and radioactive materials in effluents released to unrestricted areas to demonstrate compliance with the dose limits for individual members of the public in WAC 246-221-060.

(2) A licensee shall show compliance with the annual dose limit in WAC 246-221-060 by:

(a) Demonstrating by measurement or calculation that the total effective dose equivalent to the individual likely to receive the highest dose from the licensed operation does not exceed the annual dose limit; or

(b) Demonstrating that:

(i) The annual average concentrations of radioactive material released in gaseous and liquid effluents at the boundary of the unrestricted area do not exceed the values specified in Table II of WAC 246-221-290; and

(ii) If an individual were continually present in an unrestricted area, the dose from external sources would not exceed 0.02 mSv (0.002 rem) in an hour and 0.50 mSv (0.05 rem) in a year.

(3) Upon approval from the department, the licensee may adjust the effluent concentration values in WAC 246-221-290, Table II, for members of the public, to take into account the actual physical and chemical characteristics of the effluents, such as, aerosol size distribution, solubility, density, radioactive decay equilibrium, and chemical form.

(4) The provisions of this section do not apply to disposal of radioactive material into sanitary sewerage systems, which is governed by WAC 246-221-190.

[Statutory Authority: RCW 70.98.050. 94-01-073, § 246-221-070, filed 12/9/93, effective 1/9/94. Statutory Authority: RCW 70.98.050 and 70.98.080. 91-15-112 (Order 184), § 246-221-070, filed 7/24/91, effective 8/24/91. Statutory Authority: RCW 43.70.040. 91-02-049 (Order 121), recodified as § 246-221-070, filed 12/27/90, effective 1/31/91. Statutory Authority: RCW 70.98.080. 87-01-031 (Order 2450), § 402-24-050, filed 12/11/86; Order 1095, § 402-24-050, filed 2/6/76; Order 1, § 402-24-050, filed 1/8/69; Rules (part), filed 10/26/66.]

**WAC 246-221-080 Leak tests.** (1) Each sealed radioactive source possessed under the provisions of a specific license, other than hydrogen-3 (tritium), with a half-life greater than thirty days and in any form other than gas, shall be tested and results obtained for leakage and/or contamination prior to initial use and at six-month intervals or as specified by the license, except that each source designed for the purpose of emitting alpha particles shall be tested at intervals not to exceed three months. If at any other time there is reason to suspect that a sealed source might have been damaged, it shall be tested for leakage and results obtained before further use. In the absence of a certificate from a transferor indicating that a test for leakage has been made within six months prior to the transfer (three

months for a source designed to emit alpha particles), the sealed source shall not be put into use until tested and the results received.

(2) Leak tests shall be capable of detecting the presence of 185 Bq (0.005 microcurie) of removable contamination. The results of leak tests made pursuant to subsection (1) of this section shall be recorded in units of becquerel or microcuries and shall be maintained for inspection by the department. Any test conducted pursuant to subsection (1) which reveals the presence of 185 Bq (0.005 microcurie) or more of removable contamination shall be considered evidence that the sealed source is leaking. The licensee shall immediately withdraw the source from use shall take action to prevent the spread of contamination and shall cause it to be decontaminated and repaired or to be disposed in accordance with WAC 246-232-080. If a sealed source shows evidence of leaking, a report shall be filed with the department within five days of the test, describing the equipment involved, the test results, and the corrective action taken.

(3) Test samples shall be taken from the sealed source or from the internal surfaces or the opening of the container in which the sealed source is stored or from surfaces of devices or equipment in which the sealed source is permanently mounted. Tests for contamination and leakage may be made by wiping appropriate accessible surfaces on which one might expect contamination to accumulate and measuring these wipes for transferred contamination. Test samples shall also be taken from the interior surfaces of the container in which a sealed source of radium is stored.

(4) Leak tests are required for sealed radioactive sources that are greater than 3.7 MBq (100 microcuries) for beta and gamma emitting sources and greater than 370 KBq (10 microcuries) for sources designed to emit alpha particles.

(5) Tests for leakage or contamination shall be performed by persons specifically authorized by the department, an agreement state, a licensing state, or the United States Nuclear Regulatory Commission to perform such services.

[Statutory Authority: RCW 70.98.050. 94-01-073, § 246-221-080, filed 12/9/93, effective 1/9/94. Statutory Authority: RCW 70.98.050 and 70.98.080. 91-15-112 (Order 184), § 246-221-080, filed 7/24/91, effective 8/24/91. Statutory Authority: RCW 43.70.040. 91-02-049 (Order 121), recodified as § 246-221-080, filed 12/27/90, effective 1/31/91. Statutory Authority: RCW 70.98.080. 83-19-050 (Order 2026), § 402-24-060, filed 9/16/83. Statutory Authority: RCW 70.98.050. 81-01-011 (Order 1570), § 402-24-060, filed 12/8/80; Order 1095, § 402-24-060, filed 2/6/76; Order 1, § 402-24-060, filed 1/8/69; Rules (part), filed 10/26/66.]

**WAC 246-221-090 Personnel monitoring for external dose.** Each licensee or registrant shall monitor occupational exposure from sources of radiation at levels sufficient to demonstrate compliance with the occupational dose limits of WAC 246-221-010, 246-221-030, 246-221-050 and 246-221-055.

(1) Each licensee or registrant shall supply and shall require the use of individual monitoring devices by:

(a) Each adult likely to receive, in one year from sources external to the body, a dose in excess of ten percent of the applicable limits specified in WAC 246-221-010(1).

(b) Each minor or declared pregnant woman likely to receive, in one year from sources external to the body, a dose in excess of ten percent of the applicable limits specified in WAC 246-221-050 or 246-221-055.

(c) Each individual who enters a high or very high radiation area.

(2) Personnel monitoring devices assigned to an individual:

(a) Shall not intentionally be exposed to give a false or erroneous reading;

(b) Shall be assigned to one individual per exposure interval (i.e., weekly, monthly) and used to determine exposure for that individual only;

(c) Shall not be worn by any individual other than that individual originally assigned to the device;

(d) Personnel monitoring devices that are exposed while not being worn by the assigned individual shall be processed and recorded as soon as possible. A replacement monitoring device shall be assigned to the individual immediately. A record of the circumstances of the exposure shall be retained.

(3) All personnel dosimeters, except for direct and indirect reading pocket ionization chambers and those dosimeters used to measure the dose to any extremities, that require processing to determine the radiation dose and that are utilized by licensees or registrants to comply with subsection (1) of this section, with other applicable provisions of chapters 246-220 through 246-255 WAC, or with conditions specified in a licensee's license must be processed and evaluated by a dosimetry processor:

(a) Holding current personnel dosimetry accreditation from either the National Voluntary Laboratory Accreditation Program (NVLAP) of the National Institute of Standards and Technology (formerly known as the National Bureau of Standards) or the United States Department of Energy Laboratory Accreditation Program for Personnel Dosimetry Systems (DOELAP); and

(b) Approved in this accreditation process for the type of radiation or radiations included in the NVLAP or DOELAP program that most closely approximate the type of radiation or radiations for which the individual wearing the dosimeter is monitored.

(4) For the purposes of this section "dosimetry processor" means an individual or an organization that processes and evaluates personnel monitoring devices in order to determine the radiation dose delivered to the device.

(5) Each licensee or registrant shall maintain records of doses received by all individuals for whom monitoring was required pursuant to subsection (1) of this section, and records of doses received during planned special exposures, accidents, and emergency conditions. Assessments of dose equivalent and records made using units in effect before January 1, 1994, need not be changed. These records shall include, when applicable:

(a) The deep dose equivalent to the whole body, eye dose equivalent, shallow dose equivalent to the skin, and shallow dose equivalent to the extremities; and

(b) The total effective dose equivalent when required by WAC 246-221-015; and

(c) The total of the deep dose equivalent and the committed dose to the organ receiving the highest total dose (total organ dose equivalent).

(6) The licensee or registrant shall maintain the records specified in subsection (5) of this section on department Form RHF-5A, in accordance with the instructions provided thereon, or in clear and legible records containing all the

information required by Form RHF-5A; and shall update the information at least annually.

(7) Each licensee or registrant shall ensure that individuals, for whom they are required to monitor occupational doses in accordance with subsection (1) of this section, wear individual monitoring devices as follows:

(a) An individual monitoring device used for monitoring the dose to the whole body shall be worn at the unshielded or least shielded location of the whole body likely to receive the highest exposure. When a protective apron is worn, the location of the individual monitoring device is typically at the neck (collar).

(b) Any additional individual monitoring device used for monitoring the dose to an embryo/fetus of a declared pregnant woman, pursuant to WAC 246-221-055(1), shall be located at the waist under any protective apron being worn by the woman.

(c) An individual monitoring device used for monitoring the eye dose equivalent, to demonstrate compliance with WAC 246-221-010 (1)(b)(i), shall be located at the neck (collar), outside any protective apron being worn by the monitored individual, or at an unshielded location closer to the eye.

(d) An individual monitoring device used for monitoring the dose to the extremities, to demonstrate compliance with WAC 246-221-010 (1)(b)(ii), shall be worn on the extremity likely to receive the highest exposure. Each individual monitoring device shall be oriented to measure the highest dose to the extremity being monitored.

[Statutory Authority: RCW 70.98.050. 94-01-073, § 246-221-090, filed 12/9/93, effective 1/9/94. Statutory Authority: RCW 70.98.050 and 70.98.080. 92-06-008 (Order 245), § 246-221-090, filed 2/21/92, effective 3/23/92. Statutory Authority: RCW 43.70.040. 91-02-049 (Order 121), recodified as § 246-221-090, filed 12/27/90, effective 1/31/91. Statutory Authority: RCW 70.98.050. 81-01-011 (Order 1570), § 402-24-070, filed 12/8/80; Order 1095, § 402-24-070, filed 2/6/76; Order 708, § 402-24-070, filed 8/24/72; Order 1, § 402-24-070, filed 1/8/69; Rules (part), filed 10/26/66.]

**WAC 246-221-100 Personnel monitoring for internal dose.** (1) Each licensee shall monitor, to determine compliance with WAC 246-221-040, the occupational intake of radioactive material by and assess the committed effective dose equivalent to:

(a) Adults likely to receive, in 1 year, an intake in excess of ten percent of the applicable ALI in Table I, Columns 1 and 2, of WAC 246-221-290; and

(b) Minors and declared pregnant women likely to receive, in one year, a committed effective dose equivalent in excess of 0.50 mSv (0.05 rem).

(2) Where necessary or desirable in order to aid in determining the extent of an individual's exposure to concentrations of radioactive material, the department may incorporate license provisions or issue an order requiring a licensee or registrant to make available to the individual appropriate bioassay services and to furnish a copy of the reports of such services to the department.

(3) Each licensee shall maintain records of doses received by all individuals for whom monitoring was required pursuant to subsections (1) and (2) of this section, and records of doses received during planned special exposures, accidents, and emergency conditions. Assessments of dose equivalent and records made using units in

effect before January 1, 1994, need not be changed. These records shall include, when applicable:

(a) The estimated intake or body burden of radionuclides; and

(b) The committed effective dose equivalent assigned to the intake or body burden of radionuclides; and

(c) The specific information used to calculate the committed effective dose equivalent pursuant to WAC 246-221-040; and

(d) The total effective dose equivalent when required by WAC 246-221-015; and

(e) The total of the deep dose equivalent and the committed dose to the organ receiving the highest total dose (total organ dose equivalent).

(4) The licensee or registrant shall maintain the records specified in subsection (3) of this section on department Form RHF-5A, in accordance with the instructions provided thereon, or in clear and legible records containing all the information required by Form RHF-5A; and shall update the information at least annually.

[Statutory Authority: RCW 70.98.050. 94-01-073, § 246-221-100, filed 12/9/93, effective 1/9/94. Statutory Authority: RCW 43.70.040. 91-02-049 (Order 121), recodified as § 246-221-100, filed 12/27/90, effective 1/31/91; Order 1095, § 402-24-080, filed 2/6/76; Order 1, § 402-24-080, filed 1/8/69; Rules (part), filed 10/26/66.]

**WAC 246-221-102 Control of access to high radiation areas.** (1) The licensee or registrant shall ensure that each entrance or access point to a high radiation area has one or more of the following features:

(a) A control device that, upon entry into the area, causes the level of radiation to be reduced below that level at which an individual might receive a deep dose equivalent of 1 mSv (0.1 rem) in one hour at thirty centimeters from the source of radiation or from any surface that the radiation penetrates; or

(b) A control device that energizes a conspicuous visible or audible alarm signal so that the individual entering the high radiation area and the supervisor of the activity are made aware of the entry; or

(c) Entryways that are locked, except during periods when access to the areas is required, with positive control over each individual entry.

(2) In place of the controls required by subsection (1) of this section for a high radiation area, the licensee or registrant may substitute continuous direct or electronic surveillance that is capable of preventing unauthorized entry.

(3) The licensee or registrant may apply to the department for approval of alternative methods for controlling access to high radiation areas.

(4) The licensee or registrant shall establish the controls required by subsections (1) and (3) of this section in a way that does not prevent individuals from leaving a high radiation area.

(5) The licensee is not required to control each entrance or access point to a room or other area that is a high radiation area solely because of the presence of radioactive materials prepared for transport and packaged and labeled in accordance with the regulations of the United States Department of Transportation provided that:

(a) The packages do not remain in the area longer than three days; and



(b) The dose rate at one meter from the external surface of any package does not exceed 0.1 mSv (0.01 rem) per hour.

(6) The licensee is not required to control entrance or access to rooms or other areas in hospitals solely because of the presence of patients containing radioactive material, provided that there are personnel in attendance who are taking the necessary precautions to prevent the exposure of individuals to radiation or radioactive material in excess of the established limits and to operate within the ALARA provisions of the licensee's radiation protection program.

(7) The licensee or registrant is not required to control entrance or access to rooms or other areas as described in this section if the licensee or registrant has met all the specific requirements for access and control specified in other applicable chapters of these regulations, such as, chapter 246-243 WAC for industrial radiography, chapter 246-225 WAC for x-rays in the healing arts, and chapter 246-229 WAC for particle accelerators.

[Statutory Authority: RCW 70.98.050, 94-01-073, § 246-221-102, filed 12/9/93, effective 1/9/94.]

**WAC 246-221-104 Control of access to very high radiation areas.** (1) In addition to the requirements in WAC 246-221-102, the licensee or registrant shall institute additional measures to ensure that an individual is not able to gain unauthorized or inadvertent access to areas in which radiation levels could be encountered at five Gy (500 rad) or more in one hour at one meter from a source of radiation or any surface through which the radiation penetrates. This requirement does not apply to rooms or areas in which diagnostic x-ray systems are the only source of radiation, or to nonself-shielded irradiators.

(2) The licensee or registrant is not required to control entrance or access to rooms or other areas containing sources of radiation capable of producing a very high radiation area as described in this section if the licensee or registrant has met all the specific requirements for access and control specified in other applicable chapters of these regulations, such as, chapter 246-243 WAC for industrial radiography, chapter 246-225 WAC for x-rays in the healing arts, and chapter 246-229 WAC for particle accelerators.

[Statutory Authority: RCW 70.98.050, 94-01-073, § 246-221-104, filed 12/9/93, effective 1/9/94.]

**WAC 246-221-106 Control of access to very high radiation areas—Irradiators.** (1) This section applies to licensees or registrants with sources of radiation in nonself-shielded irradiators. This section does not apply to sources of radiation that are used in teletherapy, in industrial radiography, or in completely self-shielded irradiators in which the source of radiation is both stored and operated within the same shielding radiation barrier and, in the designed configuration of the irradiator, is always physically inaccessible to any individual and cannot create a radiation level of five Gy (500 rad) or more in one hour at one meter in an area that is accessible to any individual.

(2) Each area in which there may exist radiation levels in excess of five Gy (500 rad) in one hour at one meter from a source of radiation that is used to irradiate materials shall meet the following requirements:

(a) Each entrance or access point shall be equipped with entry control devices which:

(i) Function automatically to prevent any individual from inadvertently entering a very high radiation area; and

(ii) Permit deliberate entry into the area only after a control device is actuated that causes the radiation level within the area, from the source of radiation, to be reduced below that at which it would be possible for an individual to receive a deep dose equivalent in excess of one mSv (0.1 rem) in one hour; and

(iii) Prevent operation of the source of radiation if it would produce radiation levels in the area that could result in a deep dose equivalent to an individual in excess of one mSv (0.1 rem) in one hour.

(b) Additional control devices shall be provided so that, upon failure of the entry control devices to function as required by (a) of this subsection:

(i) The radiation level within the area, from the source of radiation, is reduced below that at which it would be possible for an individual to receive a deep dose equivalent in excess of one mSv (0.1 rem) in one hour; and

(ii) Conspicuous visible and audible alarm signals are generated to make an individual attempting to enter the area aware of the hazard and at least one other authorized individual, who is physically present, familiar with the activity, and prepared to render or summon assistance, aware of the failure of the entry control devices.

(c) The licensee or registrant shall provide control devices so that, upon failure or removal of physical radiation barriers other than the sealed source's shielded storage container:

(i) The radiation level from the source of radiation is reduced below that at which it would be possible for an individual to receive a deep dose equivalent in excess of one mSv (0.1 rem) in one hour; and

(ii) Conspicuous visible and audible alarm signals are generated to make potentially affected individuals aware of the hazard and the licensee or registrant or at least one other individual, who is familiar with the activity and prepared to render or summon assistance, aware of the failure or removal of the physical barrier.

(d) When the shield for stored sealed sources is a liquid, the licensee shall provide means to monitor the integrity of the shield and to signal, automatically, loss of adequate shielding.

(e) Physical radiation barriers that comprise permanent structural components, such as walls, that have no credible probability of failure or removal in ordinary circumstances need not meet the requirements of (c) and (d) of this subsection.

(f) Each area shall be equipped with devices that will automatically generate conspicuous visible and audible alarm signals to alert personnel in the area before the source of radiation can be put into operation and in time for any individual in the area to operate a clearly identified control device, which must be installed in the area and which can prevent the source of radiation from being put into operation.

(g) Each area shall be controlled by use of such administrative procedures and such devices as are necessary to ensure that the area is cleared of personnel prior to each use of the source of radiation.



(h) Each area shall be checked by a radiation measurement to ensure that, prior to the first individual's entry into the area after any use of the source of radiation, the radiation level from the source of radiation in the area is below that at which it would be possible for an individual to receive a deep dose equivalent in excess of one mSv (0.1 rem) in one hour.

(i) Entry and exit portals that are used in transporting materials to and from the irradiation area, and that are not intended for use by individuals, shall be controlled by such devices and administrative procedures as are necessary to physically protect and warn against inadvertent entry by any individual through these portals. Exit portals for irradiated materials shall be equipped to detect and signal the presence of any loose radioactive material that is carried toward such an exit and automatically to prevent loose radioactive material from being carried out of the area.

(3) The entry control devices required in subsection (2)(a) of this section shall be tested for proper functioning:

(a) Prior to initial operation with the source of radiation on any day, unless operations were continued uninterrupted from the previous day; and

(b) Prior to resumption of operation of the source of radiation after any unintentional interruption; and

(c) In accordance with a schedule for periodic tests of the entry control and warning systems submitted by the licensee or registrant and approved by the department.

(4) The licensee or registrant shall not conduct operations, other than those necessary to place the source of radiation in safe condition or to effect repairs on controls, unless control devices are functioning properly.

(5) Licensees, registrants, or applicants for licenses or registrations for sources of radiation within the purview of subsection (2) of this section which will be used in a variety of positions or in locations, such as open fields or forests, that make it impracticable to comply with certain requirements of subsection (2) of this section, such as those for the automatic control of radiation levels, may apply to the department for approval of alternative safety measures. Alternative safety measures shall provide personnel protection at least equivalent to those specified in subsection (2) of this section. At least one of the alternative measures shall include an entry-preventing interlock control based on a measurement of the radiation that ensures the absence of high radiation levels before an individual can gain access to the area where such sources of radiation are used.

(6) The entry control devices required by subsections (2) and (3) of this section shall be established in such a way that no individual will be prevented from leaving the area.

(7) The licensee shall maintain records of tests made pursuant to subsection (3) of this section on entry control devices for very high radiation areas. These records shall include the date, time, and results of each such test of function.

[Statutory Authority: RCW 70.98.050. 94-01-073, § 246-221-106, filed 12/9/93, effective 1/9/94.]

**WAC 246-221-110 Surveys.** (1) Each licensee or registrant shall make or cause to be made such surveys, as defined in WAC 246-220-010, as may be necessary for the licensee or registrant to establish compliance with these

regulations and are reasonable under the circumstances to evaluate radiation levels, concentrations or quantities of radioactive material, and the extent of potential radiation hazards that may be present. Records of such surveys shall be preserved as specified in WAC 246-221-230. Information on performing surveys may be found in the United States Nuclear Regulatory Commission's Regulatory Guide 8.23.

(2) The licensee shall ensure that instruments and equipment used for quantitative radiation measurements, for example, dose rate and effluent monitoring, are calibrated annually at intervals not to exceed thirteen months for the radiation measured.

[Statutory Authority: RCW 70.98.050. 94-01-073, § 246-221-110, filed 12/9/93, effective 1/9/94. Statutory Authority: RCW 70.98.050 and 70.98.080. 91-15-112 (Order 184), § 246-221-110, filed 7/24/91, effective 8/24/91. Statutory Authority: RCW 43.70.040. 91-02-049 (Order 121), recodified as § 246-221-110, filed 12/27/90, effective 1/31/91. Statutory Authority: RCW 70.98.080. 87-01-031 (Order 2450), § 402-24-085, filed 12/11/86; 83-19-050 (Order 2026), § 402-24-085, filed 9/16/83. Statutory Authority: RCW 70.98.050. 81-01-011 (Order 1570), § 402-24-085, filed 12/8/80; Order 1095, § 402-24-085, filed 2/6/76.]

**WAC 246-221-113 Use of process, engineering or other controls.** (1) The licensee shall use, to the extent practicable, process or other engineering controls, such as, containment or ventilation, to control the concentrations of radioactive material in air.

(2) When it is not practicable to apply process or other engineering controls to control the concentrations of radioactive material in air to values below those that define an airborne radioactivity area, the licensee shall, consistent with maintaining the total effective dose equivalent ALARA, increase monitoring and limit intakes by one or more of the following means:

- (a) Control of access; or
- (b) Limitation of exposure times; or
- (c) Use of respiratory protection equipment; or
- (d) Other controls.

[Statutory Authority: RCW 70.98.050. 94-01-073, § 246-221-113, filed 12/9/93, effective 1/9/94.]

**WAC 246-221-117 Use of individual respiratory protection equipment.** (1) If the licensee uses respiratory protection equipment to limit intakes pursuant to WAC 246-221-113:

(a) The licensee shall use only respiratory protection equipment that is:

(i) Tested and certified or had certification extended by the National Institute for Occupational Safety and Health and the Mine Safety and Health Administration; or

(ii) Approved by the department on the basis of the licensee's submittal of an application for authorized use of other respiratory protection equipment, including a demonstration by testing, or a demonstration on the basis of reliable test information, that the material and performance characteristics of the equipment are capable of providing the proposed degree of protection under anticipated conditions of use.

(b) The licensee shall implement and maintain a respiratory protection program that includes:

(i) Air sampling sufficient to identify the potential hazard, permit proper equipment selection, and estimate exposures; and

(ii) Surveys and bioassays, as appropriate, to evaluate actual intakes; and

(iii) Testing of respirators for operability immediately prior to each use; and

(iv) Written procedures regarding selection, fitting, issuance, maintenance, cleaning, repair, and testing of respirators, including testing for operability immediately prior to each use; supervision and training of personnel; monitoring, including air sampling and bioassays; and recordkeeping; and

(v) Determination by a physician prior to initial fitting of respirators, and at least every twelve months thereafter, that the individual user is physically able to use the respiratory protection equipment.

(c) The licensee shall issue a written policy statement on respirator usage covering:

(i) The use of process or other engineering controls, instead of respirators; and

(ii) The routine, nonroutine, and emergency use of respirators; and

(iii) The length of periods of respirator use and relief from respirator use.

(d) The licensee shall advise each respirator user that the user may leave the area at any time for relief from respirator use in the event of equipment malfunction, physical or psychological distress, procedural or communication failure, significant deterioration of operating conditions, or any other conditions that might require such relief.

(e) The licensee shall use equipment within the equipment manufacturer's expressed limitations for type and mode of use and shall provide proper visual, communication, and other special capabilities, such as adequate skin protection, when needed.

(2) When estimating exposure of individuals to airborne radioactive materials, the licensee may make allowance for respiratory protection equipment used to limit intakes pursuant to WAC 246-221-113, provided that the following conditions, in addition to those in subsection (1) of this section, are satisfied:

(a) The licensee selects respiratory protection equipment that provides a protection factor, specified in WAC 246-221-285, greater than the multiple by which peak concentrations of airborne radioactive materials in the working area are expected to exceed the values specified in WAC 246-221-290, Table I, Column 3. However, if the selection of respiratory protection equipment with a protection factor greater than the peak concentration is inconsistent with the goal specified in WAC 246-221-113 of keeping the total effective dose equivalent ALARA, the licensee may select respiratory protection equipment with a lower protection factor provided that such a selection would result in a total effective dose equivalent that is ALARA. The concentration of radioactive material in the air that is inhaled when respirators are worn may be initially estimated by dividing the average concentration in air, during each period of uninterrupted use, by the protection factor. If the exposure is later found to be greater than initially estimated, the corrected value shall be used; if the exposure is later found

to be less than initially estimated, the corrected value may be used.

(b) The licensee shall obtain authorization from the department before assigning respiratory protection factors in excess of those specified in WAC 246-221-285. The department may authorize a licensee to use higher protection factors on receipt of an application that:

(i) Describes the situation for which a need exists for higher protection factors, and

(ii) Demonstrates that the respiratory protection equipment provides these higher protection factors under the proposed conditions of use.

(3) In an emergency, the licensee shall use as emergency equipment only respiratory protection equipment that has been specifically certified or had certification extended for emergency use by the National Institute for Occupational Safety and Health and the Mine Safety and Health Administration.

(4) Unless already authorized by license condition, the licensee shall notify the department in writing at least thirty days before the date that respiratory protection equipment is first used pursuant to either subsection (1) or (2) of this section.

[Statutory Authority: RCW 70.98.050. 94-01-073, § 246-221-117, filed 12/9/93, effective 1/9/94.]

**WAC 246-221-120 Caution signs, and labels.** (1) The radiation symbol shall be used on all signs, labels, or other written means of warning individuals concerning radiation hazards.

(a) The symbol prescribed by this section is the conventional three-blade design: Radiation symbol

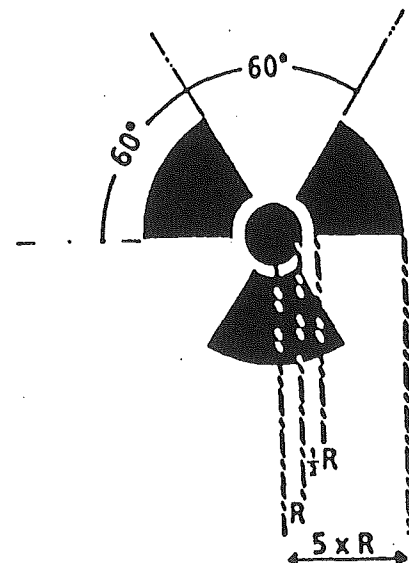

(b) The symbol prescribed by this section shall be:

(i) Magenta, purple, or black on a yellow background; or

(ii) Conspicuously etched or stamped without regard to a color requirement on sources, source holders or device components containing sources which are subjected to extreme environmental conditions which would cause the color to deteriorate.

(2) The conventional radiation symbol as described in subsection (1) of this section shall be used only for:

(a) Instructing individuals to be cognizant of a potential radiation hazard as prescribed in subsections (4) through (10) of this section.

(b) Indicating that information presented pertains to the topic of radiation.

(3) In addition to the contents of signs and labels prescribed in this section, a licensee or registrant may provide on or near such signs and labels any additional information which may be appropriate in aiding individuals to minimize exposure to radiation.

(4) Each *radiation area* and entrance thereto shall be conspicuously posted with a sign or signs bearing the radiation caution symbol and the words: CAUTION\* - RADIATION AREA. However, in an exceptionally large room where other activities of a nonradiological nature are conducted the entrance need not be posted provided a conspicuous barricade with an appropriate number of signs is established to delineate the radiation area.

(5) Each high radiation area and all entrances thereto shall be conspicuously posted with a sign or signs bearing the radiation caution symbol and the words: CAUTION\* - HIGH RADIATION AREA or DANGER - HIGH RADIATION AREA. To avoid unnecessary exposure, the licensee or registrant may satisfy this requirement by posting the sign at the estimated location or vicinity of the high radiation area.

(6) Each very high radiation area shall be conspicuously posted with a sign or signs bearing the radiation caution symbol and the words: GRAVE DANGER - VERY HIGH RADIATION AREA. To avoid unnecessary exposure, the licensee or registrant may satisfy this requirement by posting the sign at the estimated location or vicinity of the very high radiation area.

(7) Each airborne radioactivity area shall be conspicuously posted with a sign or signs bearing the radiation caution symbol and the words: CAUTION\* - AIRBORNE RADIOACTIVITY AREA or DANGER - AIRBORNE RADIOACTIVITY AREA.

(8) Each area or room in which any radioactive material is used or stored in an amount exceeding 10 times the quantity of radioactive material specified in WAC 246-221-300 shall be conspicuously posted with a sign or signs bearing the radiation caution symbol and the words: CAUTION\* - RADIOACTIVE MATERIAL or DANGER - RADIOACTIVE MATERIAL.

(9) Each container of radioactive material shall bear a durable, clearly visible label identifying the radioactive contents including:

(a) The radiation caution symbol and the words: CAUTION\* - RADIOACTIVE MATERIAL or DANGER - RADIOACTIVE MATERIAL.

(b) Sufficient information to permit individuals handling or using the containers, or working in the vicinity thereof, to take precautions to avoid or minimize exposures, such as radionuclides present, radiation levels, estimate of activity and mass enrichment.

(c) Where containers are used for storage, the quantities and kinds of radioactive materials in the containers and the date of measurement of the quantities.

(10) All radiation machines shall be labeled in a conspicuous manner so as to caution individuals that radiation is produced when the machine is being operated.

[Statutory Authority: RCW 70.98.050. 94-01-073, § 246-221-120, filed 12/9/93, effective 1/9/94. Statutory Authority: RCW 70.98.050 and 70.98.080. 91-15-112 (Order 184), § 246-221-120, filed 7/24/91, effective 8/24/91. Statutory Authority: RCW 43.70.040. 91-02-049 (Order 121), recodified as § 246-221-120, filed 12/27/90, effective 1/31/91. Statutory Authority: RCW 70.98.080. 87-01-031 (Order 2450), § 402-24-090, filed 12/11/86. Statutory Authority: RCW 70.98.050. 81-01-011 (Order 1570), § 402-24-090, filed 12/8/80; Order 1095, § 402-24-090, filed 2/6/76; Order 1, § 402-24-090, filed 1/8/69; Rules (part), filed 10/26/66.]

**WAC 246-221-130 Exceptions from posting and labeling requirements.** (1) A room or area is not required to be posted with a caution sign because of the presence of a sealed source, provided the radiation level 30 centimeters from the surface of the source container or housing does not exceed 0.05 mSv (five millirem) per hour.

(2) Rooms or other areas in hospitals are not required to be posted with caution signs because of the presence of patients containing radioactive material provided that confinement is not required pursuant to chapters 246-239 and 246-240 WAC.

(3) Caution signs are not required to be posted in areas or rooms containing radioactive material for periods of less than eight hours provided that:

(a) The material is constantly attended during such periods by an individual who shall take the precautions necessary to prevent the exposure of any individual to radiation or radioactive material in excess of the limits established in this part; and

(b) Such area or room is subject to the licensee's or registrant's control.

(4) A room or other area is not required to be posted with a caution sign because of the presence of radioactive material prepared for transport and packaged and labeled in accordance with regulations of the United States Department of Transportation.

(5) A room or area is not required to be posted with a caution sign because of the presence of a diagnostic x-ray system used solely for healing arts purposes.

(6) The interior of a teletherapy room is not required to be posted with caution signs provided such posting is conspicuously placed at the entrance(s) to the rooms.

(7) A licensee is not required to label:

(a) Containers holding licensed material in quantities less than the quantities listed in WAC 246-221-300; or

(b) Containers holding licensed material in concentrations less than those specified in WAC 246-221-290, Table III; or

(c) Containers attended by an individual who takes the precautions necessary to prevent the exposure of any individual to radiation or radioactive material in excess of the limits established by this chapter; or

(d) Containers when they are in transport and packaged and labeled in accordance with the regulations of the United States Department of Transportation; or

(e) Containers such as those located in water-filled canals, storage vaults, or hot cells, that are accessible only to individuals authorized to handle or use them, or to work in the vicinity of the containers, provided the contents are identified to these individuals by a readily available written

record. The record shall be retained as long as the containers are in use for the purpose indicated on the record; or

(f) Installed manufacturing or process equipment, such as chemical process equipment, piping, and tanks.

(8) Each licensee, prior to removal or disposal of empty uncontaminated containers to unrestricted areas, shall remove or deface the radioactive material label or otherwise clearly indicate that the container no longer contains radioactive materials.

[Statutory Authority: RCW 70.98.050. 94-01-073, § 246-221-130, filed 12/9/93, effective 1/9/94. Statutory Authority: RCW 70.98.050 and 70.98.080. 91-15-112 (Order 184), § 246-221-130, filed 7/24/91, effective 8/24/91. Statutory Authority: RCW 43.70.040. 91-02-049 (Order 121), recodified as § 246-221-130, filed 12/27/90, effective 1/31/91. Statutory Authority: RCW 70.98.080. 83-19-050 (Order 2026), § 402-24-095, filed 9/16/83. Statutory Authority: RCW 70.98.050. 81-01-011 (Order 1570), § 402-24-095, filed 12/8/80; Order 1095, § 402-24-095, filed 2/6/76.]

#### **WAC 246-221-140 Instruction of personnel.**

Instructions required for individuals working in or frequenting any portion of a restricted area are specified in WAC 246-222-020, 246-222-030, and 246-222-040.

[Statutory Authority: RCW 70.98.050 and 70.98.080. 91-15-112 (Order 184), § 246-221-140, filed 7/24/91, effective 8/24/91. Statutory Authority: RCW 43.70.040. 91-02-049 (Order 121), recodified as § 246-221-140, filed 12/27/90, effective 1/31/91. Statutory Authority: RCW 70.98.080. 83-19-050 (Order 2026), § 402-24-110, filed 9/16/83; Order 1095, § 402-24-110, filed 2/6/76; Order 708, § 402-24-110, filed 8/24/72; Order 1, § 402-24-110, filed 7/2/71; Order 1, § 402-24-110, filed 1/8/69; Rules (part), filed 10/26/66.]

**WAC 246-221-150 Security and control of stored radioactive material and radiation machines.** (1) Licensed radioactive materials and registered radiation machines shall be secured from, or controlled in such a manner so as to prevent, unauthorized access or removal from the place of storage.

(2) Licensed radioactive materials in an unrestricted area and not in storage shall be tended under the constant surveillance and immediate control of the licensee.

(3) Registered radiation machines in an unrestricted area and not in storage shall be under the control of the registrant.

[Statutory Authority: RCW 70.98.050. 94-01-073, § 246-221-150, filed 12/9/93, effective 1/9/94. Statutory Authority: RCW 43.70.040. 91-02-049 (Order 121), recodified as § 246-221-150, filed 12/27/90, effective 1/31/91. Statutory Authority: RCW 70.98.080. 83-19-050 (Order 2026), § 402-24-120, filed 9/16/83; Order 1095, § 402-24-120, filed 2/6/76; Order 1, § 402-24-120, filed 1/8/69; Rules (part), filed 10/26/66.]

**WAC 246-221-160 Procedures for picking up, receiving, and opening packages.** (1)(a) Each licensee who expects to receive a package containing quantities of radioactive material in excess of the Type A<sub>1</sub> or A<sub>2</sub> quantities specified in WAC 246-220-110 shall make arrangements to receive:

(i) The package when it is offered for delivery by the carrier; or

(ii) Immediate notification from the carrier of the arrival of the package at the carrier's terminal.

(b) Each licensee who picks up a package of radioactive material from a carrier's terminal shall pick up the package expeditiously upon receipt of notification from the carrier of its arrival.

(2) Each licensee shall:

(a) Monitor for radioactive contamination the external surfaces of any package labeled with a Radioactive White I, Yellow II or Yellow III label unless the package contains only radioactive material in the form of gas or in special form as defined in WAC 246-220-010 and 246-220-120; and

(b) Monitor the radiation levels of the external surfaces of any package labeled with a Radioactive White I, Yellow II or Yellow III label unless the package contains quantities of radioactive material that are less than or equal to the Type A quantity, as defined in WAC 246-220-110; and

(c) Monitor all packages known to contain radioactive material for radioactive contamination and radiation levels if the package has evidence of potential contamination, such as packages that are crushed, wet, or damaged.

(3) The monitoring shall be performed:

(a) Immediately upon receipt if there is evidence of package degradation or any other evidence of potential contamination or excessive radiation levels; or

(b) As soon as practicable after receipt, but no later than three hours after the package is received at the licensee's facility if received during the licensee's normal working hours, or no later than three hours from the beginning of the next working day if received after normal working hours.

(4) The licensee shall immediately notify the final delivery carrier and, by telephone and telegram, mailgram, or facsimile, the department when:

(a) For normal shipments, removable radioactive surface contamination exceeds either 22 dpm/cm<sup>2</sup> for beta-gamma emitting radionuclides, all radionuclides with half-lives less than ten days, natural uranium, natural thorium, uranium-235, uranium-238, thorium-232, and thorium-228 and thorium 230 when contained in ores or concentrates; or 2.2 dpm/cm<sup>2</sup> for all other alpha emitting radionuclides; or

(b) For exclusive use shipments, removable radioactive surface contamination exceeds either 220 dpm/cm<sup>2</sup> for beta-gamma emitting radionuclides, all radionuclides with half-lives less than ten days, natural uranium, natural thorium, uranium-235, uranium-238, thorium-232, and thorium-228 and thorium 230 when contained in ores or concentrates; or 22 dpm/cm<sup>2</sup> for all other alpha emitting radionuclides; or

(c) For normal or exclusive use shipments, external radiation levels exceed two mSv/hour (200 millirem per hour) at any point on the external surface of the package; or

(d) For exclusive use shipments where the shipment is made in a closed transport vehicle, packages are secured in a fixed position, and no loading or unloading occurs between the beginning and end of transportation, external radiation levels exceed ten mSv/hour (1000 millirem per hour) at any point on the external surface of the package.

(5) Each licensee shall establish and maintain procedures for safely opening packages in which radioactive material is received, and shall assure that such procedures are followed and that due consideration is given to instructions for the type of package being opened and the monitoring of potentially contaminated packaging material (including packages containing radioactive material in gaseous form) to assure that only background levels of radiation are present prior to disposal of such material as nonradioactive waste.

(6) Licensees transferring special form sources to and from a work site in vehicles owned or operated by the licensee are exempt from the contamination monitoring

requirements of subsection (2)(a) of this section but are not exempt from the monitoring requirement in subsection (2)(b) of this section for measuring radiation levels to ensure that the source is still properly lodged in its shield.

[Statutory Authority: RCW 70.98.050. 94-01-073, § 246-221-160, filed 12/9/93, effective 1/9/94. Statutory Authority: RCW 70.98.050 and 70.98.080. 91-15-112 (Order 184), § 246-221-160, filed 7/24/91, effective 8/24/91. Statutory Authority: RCW 43.70.040. 91-02-049 (Order 121), recodified as § 246-221-160, filed 12/27/90, effective 1/31/91. Statutory Authority: RCW 70.98.080. 87-01-031 (Order 2450), § 402-24-125, filed 12/11/86; 83-19-050 (Order 2026), § 402-24-125, filed 9/16/83. Statutory Authority: RCW 70.98.050. 81-01-011 (Order 1570), § 402-24-125, filed 12/8/80; Order 1095, § 402-24-125, filed 2/6/76.]

**WAC 246-221-170 Waste disposal, general requirement.** (1) No licensee shall dispose of any radioactive material except:

(a) By transfer to an authorized recipient as provided in WAC 246-232-080, or chapter 246-249 WAC; or

(b) As authorized pursuant to WAC 246-221-070, 246-221-180, 246-221-190, 246-221-200, 246-221-210, or 246-221-220.

(c) By decay in storage as authorized in a specific license.

(2) A person shall be specifically licensed to receive waste containing licensed material from other persons for:

(a) Treatment prior to disposal; or

(b) Treatment or disposal by incineration; or

(c) Decay in storage; or

(d) Disposal at a land disposal facility licensed pursuant to chapter 246-250 WAC; or

(e) Storage until transferred to a disposal facility authorized to receive the waste.

(3) Nothing in chapter 246-221 WAC relieves the licensee from complying with other applicable federal, state, and local regulations governing any other toxic or hazardous properties of materials that may be disposed pursuant to this chapter.

(4) Each licensee shall maintain records of all transfers and disposals of radioactive material.

[Statutory Authority: RCW 70.98.050. 94-01-073, § 246-221-170, filed 12/9/93, effective 1/9/94. Statutory Authority: RCW 70.98.050 and 70.98.080. 91-15-112 (Order 184), § 246-221-170, filed 7/24/91, effective 8/24/91. Statutory Authority: RCW 43.70.040. 91-02-049 (Order 121), recodified as § 246-221-170, filed 12/27/90, effective 1/31/91. Statutory Authority: RCW 70.98.050. 81-01-011 (Order 1570), § 402-24-130, filed 12/8/80; Order 1095, § 402-24-130, filed 2/6/76; Order 1, § 402-24-130, filed 1/8/69; Rules (part), filed 10/26/66.]

**WAC 246-221-180 Method of obtaining approval of proposed disposal procedures.** Any person may apply to the department for approval of proposed procedures to dispose of radioactive material in a manner not otherwise authorized in this chapter. Each application shall contain a description of the radioactive material, including the quantities and kinds of radioactive material and levels of radioactivity involved, the physical and chemical properties that have an impact on risk evaluation, and the proposed manner and conditions of disposal. The application, where appropriate, shall also include an analysis and evaluation of pertinent information as to the nature of the environment, including topographical, geological, meteorological, and hydrological characteristics; usage of ground and surface waters in the

general area; the nature and location of other potentially affected facilities; analyses and procedures to ensure that doses are maintained ALARA within the dose limits of this chapter; and procedures to be observed to minimize the risk of unexpected or hazardous exposures.

The department will not approve any application for a license to receive radioactive material from other persons for disposal on land not owned by a state or the federal government.

[Statutory Authority: RCW 70.98.050. 94-01-073, § 246-221-180, filed 12/9/93, effective 1/9/94. Statutory Authority: RCW 43.70.040. 91-02-049 (Order 121), recodified as § 246-221-180, filed 12/27/90, effective 1/31/91. Statutory Authority: RCW 70.98.080. 87-01-031 (Order 2450), § 402-24-135, filed 12/11/86; Order 1095, § 402-24-135, filed 2/6/76.]

**WAC 246-221-190 Disposal by release into sanitary sewerage systems.** (1) No licensee shall discharge radioactive material into a sanitary sewerage system unless:

(a) It is readily soluble or it is biological material which is readily dispersible in water;

(b) The quantity of any radioactive material released in any one month, if diluted by the average monthly quantity of water released by the licensee, will not result in an average concentration exceeding the limits specified in WAC 246-221-290, Table III; and

(c) The sum of the fractions for each radionuclide, if more than one radionuclide is released, will not exceed unity; where the fraction for each radionuclide is determined by dividing the actual monthly average concentration of each radionuclide released by the licensee into the sewer by the concentration of that radionuclide listed in Table III of WAC 246-221-290; and

(d) The total quantity of licensed and other radioactive material that the licensee releases into the sanitary sewerage system in a year does not exceed 185 GBq (5 Ci) of hydrogen-3, 37 GBq (1 Ci) of carbon-14, and 37 GBq (1 Ci) of all other radioactive materials combined.

(2) Excreta from individuals undergoing medical diagnosis or therapy with radioactive material shall be exempt from any limitations contained in this section.

[Statutory Authority: RCW 70.98.050. 94-01-073, § 246-221-190, filed 12/9/93, effective 1/9/94. Statutory Authority: RCW 70.98.050 and 70.98.080. 91-15-112 (Order 184), § 246-221-190, filed 7/24/91, effective 8/24/91. Statutory Authority: RCW 43.70.040. 91-02-049 (Order 121), recodified as § 246-221-190, filed 12/27/90, effective 1/31/91. Statutory Authority: RCW 70.98.080. 83-19-050 (Order 2026), § 402-24-140, filed 9/16/83. Statutory Authority: RCW 70.98.050. 81-01-011 (Order 1570), § 402-24-140, filed 12/8/80; Order 1095, § 402-24-140, filed 2/6/76; Order 1, § 402-24-140, filed 1/8/69; Rules (part), filed 10/26/66.]

**WAC 246-221-200 Disposal by burial in soil.** No licensee shall dispose of radioactive material by burial in soil except as specifically approved by the department pursuant to WAC 246-221-180.

[Statutory Authority: RCW 70.98.050 and 70.98.080. 91-15-112 (Order 184), § 246-221-200, filed 7/24/91, effective 8/24/91. Statutory Authority: RCW 43.70.040. 91-02-049 (Order 121), recodified as § 246-221-200, filed 12/27/90, effective 1/31/91. Statutory Authority: RCW 70.98.050. 81-01-011 (Order 1570), § 402-24-150, filed 12/8/80; Order 1095, § 402-24-150, filed 2/6/76; Order 1, § 402-24-150, filed 1/8/69; Rules (part), filed 10/26/66.]

**WAC 246-221-210 Disposal by incineration.** No licensee shall incinerate radioactive material for the purpose of disposal or preparation for disposal except as specifically approved by the department pursuant to WAC 246-221-070 and 246-221-180.

[Statutory Authority: RCW 70.98.050 and 70.98.080. 91-15-112 (Order 184), § 246-221-210, filed 7/24/91, effective 8/24/91. Statutory Authority: RCW 43.70.040. 91-02-049 (Order 121), recodified as § 246-221-210, filed 12/27/90, effective 1/31/91; Order 1095, § 402-24-160, filed 2/6/76; Order 1, § 402-24-160, filed 1/8/69; Rules (part), filed 10/26/66.]

**WAC 246-221-220 Disposal of specific wastes.** (1) Any licensee may dispose of the following licensed material without regard to its radioactivity:

(a) 1.85 KBq (0.05 microcuries) or less of hydrogen-3 or carbon-14, per gram of medium, used for liquid scintillation counting; and

(b) 1.85 KBq (0.05 microcuries) or less of hydrogen-3 or carbon-14, per gram of animal tissue averaged over the weight of the entire animal.

(2) The licensee shall not dispose of tissue under this section in a manner that would permit its use either as food for humans or as animal feed; and

(3) Nothing in this section, however, relieves the licensee of maintaining records showing the receipt, transfer and disposal of such byproduct material as specified in WAC 246-220-020; and

(4) Nothing in this section relieves the licensee from complying with other applicable federal, state and local regulations governing any other toxic or hazardous property of these materials.

[Statutory Authority: RCW 70.98.050. 94-01-073, § 246-221-220, filed 12/9/93, effective 1/9/94. Statutory Authority: RCW 70.98.050 and 70.98.080. 91-15-112 (Order 184), § 246-221-220, filed 7/24/91, effective 8/24/91. Statutory Authority: RCW 43.70.040. 91-02-049 (Order 121), recodified as § 246-221-220, filed 12/27/90, effective 1/31/91. Statutory Authority: RCW 70.98.080. 83-19-050 (Order 2026), § 402-24-165, filed 9/16/83.]

**WAC 246-221-230 Records important to radiation safety.** (1) Each licensee or registrant shall make and retain records of activities, program reviews, measurements, and calculations which may be necessary to determine the extent of occupational and public exposure from sources of radiation under the control of the licensee or registrant.

(2) Each record required by this section shall be legible throughout the specified retention period.

(3) Each licensee or registrant shall use the SI units: Becquerel, gray, sievert and coulomb per kilogram, or the special units: Curie, rad, rem, and roentgen, including multiples and subdivisions, and shall clearly indicate the units of all quantities on records required by these regulations.

(4) The licensee or registrant shall make a clear distinction among the quantities entered on the records required by these regulations such as, total effective dose equivalent, total organ dose equivalent, shallow dose equivalent, eye dose equivalent, deep dose equivalent, or committed effective dose equivalent.

(5) Records which must be maintained pursuant to this part shall be the original or a reproduced copy or microform if such reproduced copy or microform is duly authenticated

by authorized personnel and the microform is capable of producing a clear and legible copy after storage for the period specified by department regulations. The record may also be stored in electronic media with the capability for producing legible, accurate, and complete records during the required retention period. Electronic media data storage systems shall incorporate standard or universally recognized security measures. Records, such as letters, drawings, and specifications, shall include all pertinent information, such as stamps, initials, and signatures.

(6) The licensee shall maintain adequate safeguards against tampering with and loss of records.

(7) The licensee or registrant shall retain the following required records until the department terminates each pertinent license or registration requiring the record, and upon termination of the license or registration, the licensee or registrant shall store for at least thirty years:

(a) Records of prior occupational dose and exposure history as recorded on department Form RHF-4 or RHF-4A, or equivalent;

(b) Records on department Form RHF-5 or RHF-5A, or equivalent, of doses received by all individuals for whom monitoring was required pursuant to WAC 246-221-090 and 246-221-100;

(c) Records of doses received during planned special exposures, accidents, and emergency conditions;

(d) The specific information used to calculate the committed effective dose equivalent pursuant to WAC 246-221-040(3);

(e) Records of the results of surveys to determine the dose from external sources of radiation used, in the absence of or in combination with individual monitoring data, in the assessment of individual dose equivalents;

(f) Records of the results of measurements and calculations used to determine individual intakes of radioactive material and used in the assessment of internal dose;

(g) Records showing the results of air sampling, surveys, and bioassays required pursuant to WAC 246-221-117 (1)(b)(i) and (ii);

(h) Records of the results of measurements and calculations used to evaluate the release of radioactive effluents to the environment.

(8) The licensee or registrant shall retain the following records until the department terminates the pertinent license or registration requiring the record:

(a) Records of waste disposal made under the provisions of WAC 246-221-180, 246-221-190, 246-221-210 and 246-221-220, chapter 246-249 WAC, and any burials in soil as previously authorized;

(b) Records of dose to individual members of the public as required by WAC 246-221-060(4);

(c) Records of the provisions of the radiation protection program as required by WAC 246-221-005.

(9) The licensee or registrant shall retain the following records for three years after the record is made:

(a) Records of testing entry control devices for very high radiation areas as required by WAC 246-221-106(3);

(b) Records used in preparing department Form RHF-4 or RHF-4A;

(c) Records showing the results of general surveys required by WAC 246-221-110 and package surveys required by WAC 246-221-160;



(d) Records of calibrations required by WAC 246-221-110;

(e) Records of program audits and other reviews of the content and implementation of the radiation protection program required by WAC 246-221-005;

(f) Records of waste disposal by decay in storage.

(10) If there is a conflict between the department's regulations in this part, license condition, or other written department approval or authorization pertaining to the retention period for the same type of record, the retention period specified in the regulations in this part for such records shall apply unless the department, pursuant to WAC 246-220-050, has granted a specific exemption from the record retention requirements specified in the regulations in this part.

(11) The discontinuance or curtailment of activities does not relieve the licensee or registrant of responsibility for retaining all records required by this section.

[Statutory Authority: RCW 70.98.050. 94-01-073, § 246-221-230, filed 12/9/93, effective 1/9/94. Statutory Authority: RCW 70.98.050 and 70.98.080. 91-15-112 (Order 184), § 246-221-230, filed 7/24/91, effective 8/24/91. Statutory Authority: RCW 43.70.040. 91-02-049 (Order 121), recodified as § 246-221-230, filed 12/27/90, effective 1/31/91. Statutory Authority: RCW 70.98.080. 87-01-031 (Order 2450), § 402-24-170, filed 12/11/86; 83-19-050 (Order 2026), § 402-24-170, filed 9/16/83. Statutory Authority: RCW 70.98.050. 81-01-011 (Order 1570), § 402-24-170, filed 12/8/80; Order 1095, § 402-24-170, filed 2/6/76; Order 708, § 402-24-170, filed 8/24/72; Order 1, § 402-24-170, filed 7/2/71; Order 1, § 402-24-170, filed 1/8/69; Rules (part), filed 10/26/66.]

**WAC 246-221-240 Reports of stolen, lost or missing radiation sources.** (1) Each licensee and/or registrant shall report by telephone (206/682-5327) and confirm promptly by letter, telegram, mailgram, or facsimile to the State Department of Health, Division of Radiation Protection, P.O. Box 47827, Olympia, Washington 98504-7827.

(a) Immediately after its occurrence becomes known to the licensee, stolen, lost, or missing radioactive material in an aggregate quantity equal to or greater than one thousand times the quantity specified in WAC 246-221-300; or

(b) Within thirty days after its occurrence becomes known to the licensee, lost, stolen, or missing radioactive material in an aggregate quantity greater than ten times the quantity specified in Appendix C that is still missing or any item not exempted in chapter 246-232 WAC; or

(c) Immediately after its occurrence becomes known to the registrant, a stolen, lost, or missing radiation machine.

(2) Each licensee or registrant required to make a report pursuant to subsection (1) of this section shall, within thirty days after making the telephone report, make a written report to the department setting forth the following information:

(a) A description of the licensed or registered source of radiation involved, including, for radioactive material, the kind, quantity, and chemical and physical form; and, for radiation machines, the manufacturer, model and serial number, type and maximum energy of radiation emitted; and

(b) A description of the circumstances under which the loss or theft occurred; and

(c) A statement of disposition, or probable disposition, of the licensed or registered source of radiation involved; and

(d) Exposures of individuals to radiation, circumstances under which the exposures occurred, and the possible total effective dose equivalent to persons in unrestricted areas; and

(e) Actions that have been taken, or will be taken, to recover the source of radiation; and

(f) Procedures or measures that have been, or will be, adopted to ensure against a recurrence of the loss or theft of licensed or registered sources of radiation.

(3) Subsequent to filing the written report, the licensee or registrant shall also report additional substantive information on the loss or theft within thirty days after the licensee or registrant learns of such information.

(4) The licensee or registrant shall prepare any report filed with the department pursuant to this section so that names of individuals who may have received exposure to radiation are stated in a separate and detachable portion of the report.

[Statutory Authority: RCW 70.98.050. 94-01-073, § 246-221-240, filed 12/9/93, effective 1/9/94. Statutory Authority: RCW 70.98.050 and 70.98.080. 91-15-112 (Order 184), § 246-221-240, filed 7/24/91, effective 8/24/91. Statutory Authority: RCW 43.70.040. 91-02-049 (Order 121), recodified as § 246-221-240, filed 12/27/90, effective 1/31/91. Statutory Authority: RCW 70.98.080. 87-01-031 (Order 2450), § 402-24-180, filed 12/11/86; 83-19-050 (Order 2026), § 402-24-180, filed 9/16/83. Statutory Authority: RCW 70.98.050. 81-01-011 (Order 1570), § 402-24-180, filed 12/8/80; Order 1095, § 402-24-180, filed 2/6/76; Order 708, § 402-24-180, filed 8/24/72; Order 1, § 402-24-180, filed 7/2/71; Order 1, § 402-24-180, filed 1/8/69; Rules (part), filed 10/26/66.]

**WAC 246-221-250 Notification of incidents.** (1) **Immediate notification.** Notwithstanding other requirements for notification, each licensee and/or registrant shall immediately (as soon as possible but no later than four hours after discovery of an incident) notify the State Department of Health, Division of Radiation Protection, P.O. Box 47827, Olympia, Washington 98504-7827, by telephone (206/682-5327) and confirming letter, telegram, mailgram, or facsimile of any incident involving any radiation source which may have caused or threatens to cause:

(a) An individual to receive:

(i) A total effective dose equivalent of 0.25 Sv (25 rem) or more; or

(ii) An eye dose equivalent of 0.75 Sv (75 rem) or more; or

(iii) A shallow dose equivalent to the skin or extremities or a total organ dose equivalent of 2.5 Sv (250 rem) or more; or

(b) The release of radioactive material, inside or outside of a restricted area, so that, had an individual been present for twenty-four hours, the individual could have received an intake five times the occupational ALI. This provision does not apply to locations where personnel are not normally stationed during routine operations, such as hot-cells or process enclosures; or

(c) The loss of ability to take immediate protective actions necessary to avoid exposure to sources of radiation or releases of radioactive material that could exceed regulatory limits. Events which could cause such a loss of ability include fires, explosions, toxic gas releases, etc.

(2) **Twenty-four hour notification.** Each licensee and/or registrant shall within twenty-four hours of discovery of the event, notify the State Department of Health, Division of Radiation Protection, P.O. Box 47827, Olympia, Washington



98504-7827, by telephone (206/682-5327) and confirming letter, telegram, mailgram, or facsimile of any incident involving any radiation source possessed which may have caused or threatens to cause:

(a) An individual to receive, in a period of twenty-four hours:

(i) A total effective dose equivalent exceeding 0.05 Sv (5 rem); or

(ii) An eye dose equivalent exceeding 0.15 Sv (15 rem); or

(iii) A shallow dose equivalent to the skin or extremities or a total organ dose equivalent exceeding 0.5 Sv (50 rem); or

(b) The release of radioactive material, inside or outside of a restricted area, so that, had an individual been present for twenty-four hours, the individual could have received an intake in excess of one occupational ALI. This provision does not apply to locations where personnel are not normally stationed during routine operations, such as hot-cells or process enclosures; or

(c) An unplanned contamination incident that:

(i) Requires access to the contaminated area, by workers or the general public, to be restricted for more than twenty-four hours by imposing additional radiological controls or by prohibiting entry into the area;

(ii) Involves a quantity of material greater than five times the lowest annual limit on intake specified in WAC 246-221-290; and

(iii) Has access to the area restricted for a reason other than to allow radionuclides with a half-life of less than twenty-four hours to decay prior to decontamination; or

(d) Equipment failure or inability to function as designed when:

(i) The equipment is required by regulation or license condition to prevent releases exceeding regulatory limits, to prevent exposures to radiation and radioactive material exceeding regulatory limits or to mitigate the consequences of an accident;

(ii) The equipment is required to be available and operable at the time it becomes disabled or fails to function; and

(iii) No redundant equipment is available and operable to perform the required safety functions; or

(e) An unplanned medical treatment at a medical facility of an individual with spreadable radioactive contamination on the individual's clothing or body; or

(f) An unplanned fire or explosion damaging any radioactive material or any device, container or equipment containing radioactive material when:

(i) The quantity of radioactive material involved is greater than five times the lowest annual limit on intake specified in WAC 246-221-290; and

(ii) The damage affects the integrity of the radioactive material or its container.

(3) For each occurrence requiring notification pursuant to this section, a prompt investigation of the situation shall be initiated by the licensee/registrant. A written report of the findings of the investigation shall be sent to the department within thirty days.

(4) The licensee or registrant shall prepare each report filed with the department pursuant to this section so that names of individuals who have received exposure to sources

of radiation are stated in a separate and detachable portion of the report.

Any report filed with the department pursuant to this section shall contain the information described in WAC 246-221-260 (2) and (3).

(5) The provisions of this section do not apply to doses that result from planned special exposures, provided such doses are within the limits for planned special exposures and are reported pursuant to WAC 246-221-265.

(6) Telephone notifications that do not involve immediate or twenty-four hour notification shall not be made to the emergency number (Seattle 206/682-5327). Routine calls should be made to the Olympia office (360/753-3468).

(7) Telephone notification required under this section shall include, to the extent that the information is available at the time of notification:

(a) The caller's name and call-back telephone number;

(b) A description of the incident including date and time;

(c) The exact location of the incident;

(d) The radionuclides, quantities, and chemical and physical forms of the radioactive materials involved; and

(e) Any personnel radiation exposure data available.

[Statutory Authority: RCW 70.98.050, 95-01-108, § 246-221-250, filed 12/21/94, effective 1/21/95; 94-01-073, § 246-221-250, filed 12/9/93, effective 1/9/94. Statutory Authority: RCW 70.98.050 and 70.98.080, 91-15-112 (Order 184), § 246-221-250, filed 7/24/91, effective 8/24/91. Statutory Authority: RCW 43.70.040, 91-02-049 (Order 121), recodified as § 246-221-250, filed 12/27/90, effective 1/31/91. Statutory Authority: RCW 70.98.080, 87-01-031 (Order 2450), § 402-24-190, filed 12/11/86; 83-19-050 (Order 2026), § 402-24-190, filed 9/16/83. Statutory Authority: RCW 70.98.050, 81-01-011 (Order 1570), § 402-24-190, filed 12/8/80; Order 1095, § 402-24-190, filed 2/6/76; Order 708, § 402-24-190, filed 8/24/72; Order 1, § 402-24-190, filed 7/2/71; Order 1, § 402-24-190, filed 1/8/69; Rules (part), filed 10/26/66.]

**WAC 246-221-260 Reports of overexposures and excessive levels and concentrations.** (1) In addition to any notification required by WAC 246-221-250, each licensee or registrant shall submit a written report to the department within thirty days after learning of any of the following occurrences:

(a) Incidents for which notification is required by WAC 246-221-250; or

(b) Doses in excess of any of the following:

(i) The occupational dose limits for adults in WAC 246-221-010; or

(ii) The occupational dose limits for a minor in WAC 246-221-050; or

(iii) The limits for an embryo/fetus of a declared pregnant woman in WAC 246-221-055; or

(iv) The limits for an individual member of the public in WAC 246-221-060; or

(v) Any applicable limit in the license; or

(c) Levels of radiation or concentrations of radioactive material in:

(i) A restricted area in excess of applicable limits in the license; or

(ii) An unrestricted area in excess of ten times the applicable limit set forth in this chapter or in the license or registration, whether or not involving exposure of any individual in excess of the limits in WAC 246-221-060; or

(d) For source materials milling licensees and nuclear power plants subject to the provisions of United States Environmental Protection Agency's generally applicable environmental radiation standards in 40 CFR 190, levels of radiation or releases of radioactive material in excess of those standards, or of license conditions related to those standards.

(2) Each report required by subsection (1) of this section shall describe:

- (a) The incident and its exact location, time and date;
- (b) The extent of exposure of individuals to radiation or to radioactive material, including estimates of each individual's dose as required by subsection (3) of this section;
- (c) Levels of radiation and concentrations of radioactive material involved, including the radionuclides, quantities, and chemical and physical form;
- (d) The cause or probable cause of the exposure, levels of radiation or concentrations;
- (e) The manufacturer and model number (if applicable) of any equipment that failed or malfunctioned;
- (f) The results of any evaluations or assessments; and
- (g) Corrective steps taken or planned to assure against a recurrence, including the schedule for achieving conformance with applicable limits, generally applicable environmental standards, and associated license conditions.

(3) Each report filed with the department pursuant to this section shall include for each individual exposed the name, social security number, and date of birth, and an estimate of the individual's dose. With respect to the limit for the embryo/fetus in WAC 246-221-055, the identifiers should be those of the declared pregnant woman. The report shall be prepared so that this information is stated in a separate and detachable part of the report.

(4) Individuals shall be notified of reports in accordance with the requirements of WAC 246-222-040.

[Statutory Authority: RCW 70.98.050. 95-01-108, § 246-221-260, filed 12/21/94, effective 1/21/95; 94-01-073, § 246-221-260, filed 12/9/93, effective 1/9/94. Statutory Authority: RCW 70.98.050 and 70.98.080. 91-15-112 (Order 184), § 246-221-260, filed 7/24/91, effective 8/24/91. Statutory Authority: RCW 43.70.040. 91-02-049 (Order 121), recodified as § 246-221-260, filed 12/27/90, effective 1/31/91. Statutory Authority: RCW 70.98.050. 81-01-011 (Order 1570), § 402-24-200, filed 12/8/80; Order 1095, § 402-24-200, filed 2/6/76; Order 708, § 402-24-200, filed 8/24/72; Order 1, § 402-24-200, filed 7/2/71; Order 1, § 402-24-200, filed 1/8/69; Rules (part), filed 10/26/66.]

**WAC 246-221-265 Special reports to the department—Planned special exposures, individual monitoring results from certain licensees, and leaking sources.** (1) The licensee or registrant shall submit a written report to the department within thirty days following any planned special exposure conducted in accordance with WAC 246-221-030, informing the department that a planned special exposure was conducted and indicating the date the planned special exposure occurred and the information required by WAC 246-221-030.

(2) Each licensee in a category listed in subsection (3) of this section shall submit an annual report of the results of individual monitoring carried out by the licensee for each individual for whom monitoring was required by WAC 246-221-090 and 246-221-100 during that year. The licensee may include additional data for individuals for whom moni-

toring was provided but not required. The licensee shall use department Form RHF-5A or electronic media containing all the information required by department Form 5A.

(3) The requirement to submit individual monitoring results annually applies to each person licensed by the department to:

- (a) Possess or use sources of radiation for purposes of industrial radiography pursuant to chapters 246-235 and 246-243 WAC; or
- (b) Receive radioactive waste from other persons for disposal pursuant to chapter 246-250 WAC; or
- (c) Possess or use at any time, for processing or manufacturing for distribution pursuant to chapter 246-235 WAC, radioactive material in quantities exceeding any one of the following quantities:

Radionuclide	Ci	Activity GBq
Cesium-137	1	37
Cobalt-60	1	37
Gold-198	100	3,700
Iodine-131	1	37
Iridium-192	10	370
Krypton-85	1,000	37,000
Promethium-147	10	370
Technetium-99m	1,000	37,000

(4) The department may require as a license condition, or by rule, regulation, or order pursuant to WAC 246-220-100, reports of annual individual monitoring results from licensees processing or manufacturing for distribution radionuclides not on the list in subsection (3)(c) of this section, provided the radionuclides are in quantities sufficient to cause comparable radiation levels to those on the list.

(5) The licensee shall file the report required by subsection (2) of this section, covering the preceding year, on or before April 30 of each year. The licensee shall submit the report to the department.

(6) The licensee shall file a written report with the department within five days after learning that a sealed source is leaking or contaminated. The report shall describe the source, source holder, equipment in which the source is installed, the test results and the corrective action taken.

[Statutory Authority: RCW 70.98.050. 94-01-073, § 246-221-265, filed 12/9/93, effective 1/9/94.]

**WAC 246-221-270 Vacating premises and release of equipment.** (1) Each specific licensee shall, no less than 30 days before vacating or relinquishing possession or control of premises which may have been contaminated with radioactive material as a result of licensed activities, notify the department in writing of intent to vacate.

(2) Each licensee, before vacating any premise or transferring the premise, shall permanently decontaminate such premise below or equal to the standards specified in WAC 246-232-140. A survey shall be made after such decontamination and the department and the landlord or subsequent tenant or transferee shall be provided with a copy

of such survey no later than the date of vacating or relinquishing possession or control of the premise.

(3) No machinery, instruments, laboratory equipment or any other property used in contact with, or close proximity to radioactive material at a licensed premise shall be assigned, sold, leased, or transferred to an unlicensed person unless such property has been decontaminated to meet the standards specified in WAC 246-232-140. A survey shall be made after such decontamination and the department and subsequent owner or transferee shall be provided with a copy of such survey report.

[Statutory Authority: RCW 70.98.050. 94-01-073, § 246-221-270, filed 12/9/93, effective 1/9/94. Statutory Authority: RCW 43.70.040. 91-02-049 (Order 121), recodified as § 246-221-270, filed 12/27/90, effective 1/31/91; Order 1095, § 402-24-210, filed 2/6/76; Order 1, § 402-24-210, filed 1/8/69; Rules (part), filed 10/26/66.]

**WAC 246-221-275 Notification of changes in a facility.** Each licensee or registrant shall notify the department of changes in any room or area in a facility where a source of radiation is used. Changes of interest to the department include, but are not limited to, new or replacement equipment containing or emitting radiation, increased occupancy, repair or replacement of existing shielding, new shielding, alteration of the ventilation system, and changes in procedures done in the room or area.

[Statutory Authority: RCW 70.98.050. 94-01-073, § 246-221-275, filed 12/9/93, effective 1/9/94.]

**WAC 246-221-280 Notifications and reports to individuals.** (1) Requirements for notification and reports to individuals of exposure to radiation or radioactive material are specified in WAC 246-222-040.

(2) When a licensee or registrant is required pursuant to WAC 246-221-260 to report to the department any exposure of an individual or dosimetry device assigned to any individual to radiation from any source, the licensee or registrant shall also notify the individual. Such notice shall be transmitted at a time not later than the transmittal to the department, and shall comply with the provisions of WAC 246-222-040(1).

[Statutory Authority: RCW 70.98.050 and 70.98.080. 91-15-112 (Order 184), § 246-221-280, filed 7/24/91, effective 8/24/91. Statutory Authority: RCW 43.70.040. 91-02-049 (Order 121), recodified as § 246-221-280, filed 12/27/90, effective 1/31/91. Statutory Authority: RCW 70.98.080. 87-01-031 (Order 2450), § 402-24-215, filed 12/11/86; Order 1095, § 402-24-215, filed 2/6/76.]

**WAC 246-221-285 Protection factors for respirators.** (1) The licensee may use the following information in the selection of respiratory protective equipment to be used only where the contaminants have been identified and the concentration, or possible concentrations, are known.

Protection Factors <sup>1</sup>		Tested & Certified Equipment		
Description <sup>2</sup>	Modes <sup>3</sup>	Particulates only	Particulates, gases, vapors <sup>3</sup>	NIOSH & MSHA <sup>4</sup> tests for permissibility

**I. AIR-PURIFYING RESPIRATORS<sup>6</sup>**

Facepiece, half-mask <sup>7</sup>	NP	10	30 CFR 11,
Facepiece, full	NP	50	Subpart K.
Facepiece, half-mask, full, or hood	PP	1000	

**II. ATMOSPHERE-SUPPLYING RESPIRATORS**

**1. Air-line respirator**

Facepiece, half-mask	CF	1000	
Facepiece, half-mask	D	5	
Facepiece, full	CF	2000	
Facepiece, full	D	5	30 CFR 11,
Facepiece, full	PD	2000	Subpart J.
Hood <sup>8</sup>	CF		
Suit <sup>9, 10</sup>	CF		

**2. Self-contained breathing apparatus (SCBA)**

Facepiece, full	D	50	
Facepiece, full	PD	10,000 <sup>11</sup>	30 CFR 11,
Facepiece, full	RD	50	Subpart H.
Facepiece, full	RP	5,000 <sup>12</sup>	

**III. COMBINATION RESPIRATORS**

Any combination of air-purifying and atmosphere-supplying respirators for type and mode of operation as listed above  
30 CFR 11, Sec.11.63(b)

**FOOTNOTES**

1. The protection factor is a measure of the degree of protection afforded by a respirator, defined as the ratio of the concentration of airborne radioactive material outside the respiratory protective equipment to that inside the equipment, usually inside the facepiece, under conditions of use. It is applied to the ambient airborne concentration to estimate the concentrations inhaled by the wearer according to the following formula:

$$\text{Concentration inhaled} = \frac{\text{Ambient airborne concentration}}{\text{Protection factor}}$$

The protection factors apply:

- a. Only for individuals trained in using respirators and wearing properly fitted respirators that are used and maintained under supervision in a well-planned respiratory protective program.
  - b. For air-purifying respirators only when high efficiency particulate filters, above 99.97% removal efficiency by thermally generated 0.3 µm dioctyl phthalate (DOP) test or equivalent, are used in atmospheres not deficient in oxygen and not containing radioactive gas or vapor respiratory hazards.
  - c. No adjustment is to be made for the use of sorbents against radioactive material in the form of gases or vapors.
  - d. For atmosphere-supplying respirators only when supplied with adequate respirable air. Respirable air shall be provided of the quality and quantity required in accordance with the National Institute for Occupational Safety and Health and the Mine Safety and Health Administration certification described in 30 CFR 11. Oxygen and air shall not be used in the same apparatus.
2. Only for shaven faces and where nothing interferes with the seal of tight-fitting facepieces against the skin. Hoods and suits are excepted.
  3. The mode symbols are defined as follows:
    - CF = continuous flow
    - D = demand
    - NP = negative pressure, that is, negative phase during inhalation
    - PD = pressure demand, that is, always positive pressure
    - PP = positive pressure
    - RD = demand, recirculating or closed circuit
    - RP = pressure demand, recirculating or closed circuit

4. NIOSH & MSHA are the National Institute for Occupational Safety and Health and the Mine Safety and Health Administration.
5. Excluding radioactive contaminants that present an absorption or submersion hazard. For tritium oxide, approximately one-third of the intake occurs by absorption through the skin so that an overall protection factor of less than two is appropriate when atmosphere-supplying respirators are used to protect against tritium oxide. If the protection factor for respiratory protective equipment is five, the effective protection factor for tritium is about 1.4; with protection factors of ten, the effective factor for tritium oxide is about 1.7; and with protection factors of one hundred or more, the effective factor for tritium oxide is about 1.9. Air-purifying respirators are not suitable for protection against tritium oxide. See also footnote 9 concerning supplied-air suits.
6. Canisters and cartridges shall not be used beyond service-life limitations.
7. Under-chin type only. This type of respirator is not satisfactory for use where it might be possible, if an accident or emergency were to occur, for the ambient airborne concentrations to reach instantaneous values greater than ten times the pertinent values in Table I, Column 3 of WAC 246-221-290. This type of respirator is not suitable for protection against plutonium or other high-toxicity materials. The mask is to be tested for fit prior to use, each time it is donned.
8. Equipment shall be operated in a manner that ensures that proper air flow-rates are maintained. A protection factor of no more than one thousand may be utilized for tested-and-certified supplied-air hoods when a minimum air flow of six cubic feet per minute ( $0.17 \text{ m}^3/\text{min}$ ) is maintained and calibrated air line pressure gauges or flow measuring devices are used. A protection factor of up to two thousand may be used for tested and certified hoods only when the air flow is maintained at the manufacturer's recommended maximum rate for the equipment, this rate is greater than six cubic feet per minute ( $0.17 \text{ m}^3/\text{min}$ ) and calibrated air line pressure gauges or flow measuring devices are used.  
  
The design of the supplied-air hood or helmet, with a minimum flow of six cubic feet per minute ( $0.17 \text{ m}^3/\text{min}$ ) of air, may determine its overall efficiency and the protection it provides. For example, some hoods aspirate contaminated air into the breathing zone when the wearer works with hands-over-head. This aspiration may be overcome if a short cape-like extension to the hood is worn under a coat or overalls. Other limitations specified by the approval agency shall be considered before using a hood in certain types of atmospheres. See footnote 9.
9. Appropriate protection factors shall be determined, taking into account the design of the suit and its permeability to the contaminant under conditions of use. There shall be a standby rescue person equipped with a respirator or other apparatus appropriate for the potential hazards and communications equipment whenever supplied-air suits are used.
10. No approval schedules are currently available for this equipment. Equipment is to be evaluated by testing or on the basis of reliable test information.
11. This type of respirator may provide greater protection and be used as an emergency device in unknown concentrations for protection against inhalation hazards. External radiation hazards and other limitations to permitted exposure, such as skin absorption, must be taken into account in such circumstances.
12. Quantitative fit testing shall be performed on each individual, and no more than 0.02% leakage is allowed with this type of apparatus. Perceptible outward leakage of gas from this or any positive pressure self-contained breathing apparatus is unacceptable because service life will be reduced substantially. Special training in the use of this type of apparatus shall be provided to the wearer.

(2) The licensee may use protection factors for respirators approved by the United States Bureau of Mines and the

National Institute for Occupational Safety and Health, according to applicable approvals for respirators for type and mode of use to protect against airborne radionuclides, to the extent that they do not exceed the protection factors listed in the table given in subsection (1) of this section. The protection factors listed in this table may not be appropriate to circumstances where chemical or other respiratory hazards exist in addition to radioactive hazards. The selection and use of respirators for such circumstances should take into account applicable approvals of the United States Bureau of Mines and the National Institute for Occupational Safety and Health.

(3) The licensee should also be aware that the concentration values in Table I, Column 3 of WAC 246-221-290 are based on internal dose due to inhalation, and that radioactive contaminants may present external exposure hazards at higher concentrations. Under these circumstances, limitations on occupancy may have to be governed by external dose limits.

[Statutory Authority: RCW 70.98.050. 94-01-073, § 246-221-285, filed 12/9/93, effective 1/9/94.]

**WAC 246-221-290 Appendix A—Annual limits on intake (ALI) and derived air concentrations (DAC) of radionuclides for occupational exposure; effluent concentrations; concentrations for release to sanitary sewerage.** For each radionuclide, Table I indicates the chemical form which is to be used for selecting the appropriate ALI or DAC value. The ALIs and DACs for inhalation are given for an aerosol with an activity median aerodynamic diameter (AMAD) of  $1 \mu\text{m}$  (micron) and for three classes (D,W,Y) of radioactive material, which refer to their retention (approximately days, weeks or years) in the pulmonary region of the lung. This classification applies to a range of clearance half-times for D if less than ten days, for W from ten to one hundred days, and for Y greater than one hundred days. Table II provides concentration limits for airborne and liquid effluents released to the general environment. Table III provides concentration limits for discharges to sanitary sewerage.

Note: The values in Tables I, II, and III are presented in the computer "E" notation. In this notation a value of  $6\text{E}-02$  represents a value of  $6 \times 10^{-2}$  or 0.06.  $6\text{E}+2$  represents  $6 \times 10^2$  or 600, and  $6\text{E}+0$  represents  $6 \times 10^0$  or 6.

#### Table I "Occupational Values"

Note that the columns in Table I of this appendix captioned "Oral Ingestion ALI," "Inhalation ALI," and "DAC," are applicable to occupational exposure to radioactive material.

The ALIs in this appendix are the annual intakes of given radionuclide by "Reference Man" which would result in either: A committed effective dose equivalent of 0.05 Sv (5 rem), stochastic ALI; or a committed dose equivalent of 0.5 Sv (50 rem) to an organ or tissue, nonstochastic ALI. The stochastic ALIs were derived to result in a risk, due to irradiation of organs and tissues, comparable to the risk associated with deep dose equivalent to the whole body of 0.05 Sv (5 rem). The derivation includes multiplying the committed dose equivalent to an organ or tissue by a weighting factor,  $w_T$ . This weighting factor is the proportion

of the risk of stochastic effects resulting from irradiation of the organ or tissue, T, to the total risk of stochastic effects when the whole body is irradiated uniformly. The values of  $w_T$  are listed under the definition of weighting factor in WAC 246-221-005. The nonstochastic ALIs were derived to avoid nonstochastic effects, such as prompt damage to tissue or reduction in organ function.

A value of  $w_T = 0.06$  is applicable to each of the five organs or tissues in the "remainder" category receiving the highest dose equivalents, and the dose equivalents of all other remaining tissues may be disregarded. The following portions of the GI tract — stomach, small intestine, upper large intestine, and lower large intestine — are to be treated as four separate organs.

Note that the dose equivalents for an extremity, elbows, arms below the elbows, feet and lower legs, knees, and legs below the knees, skin, and lens of the eye are not considered in computing the committed effective dose equivalent, but are subject to limits that must be met separately.

When an ALI is defined by the stochastic dose limit, this value alone is given. When an ALI is determined by the non-stochastic dose limit to an organ, the organ or tissue to which the limit applies is shown, and the ALI for the stochastic limit is shown in parentheses. Abbreviated organ or tissue designations are used:

LLI wall = lower large intestine wall;  
St. wall = stomach wall;  
Blad wall = bladder wall; and  
Bone surf = bone surface.

The use of the ALIs listed first, the more limiting of the stochastic and nonstochastic ALIs, will ensure that nonstochastic effects are avoided and that the risk of stochastic effects is limited to an acceptably low value. If, in a particular situation involving a radionuclide for which the nonstochastic ALI is limiting, use of that nonstochastic ALI is considered unduly conservative, the licensee may use the stochastic ALI to determine the committed effective dose equivalent. However, the licensee shall also ensure that the 0.5 Sv (50 rem) dose equivalent limit for any organ or tissue is not exceeded by the sum of the external deep dose equivalent plus the internal committed dose equivalent to that organ, not the effective dose. For the case where there is no external dose contribution, this would be demonstrated if the sum of the fractions of the nonstochastic ALIs ( $ALI_{ns}$ ) that contribute to the committed dose equivalent to the organ receiving the highest dose does not exceed unity, that is,  $\sum$  (intake (in  $\mu\text{Ci}$ ) of each radionuclide/ $ALI_{ns}$ )  $\leq 1.0$ . If there is an external deep dose equivalent contribution of  $H_d$ , then this sum must be less than  $1 - (H_d/50)$ , instead of  $\leq 1.0$ .

The derived air concentration (DAC) values are derived limits intended to control chronic occupational exposures. The relationship between the DAC and the ALI is given by:

$$\text{DAC} = \text{ALI (in } \mu\text{Ci)} / (2000 \text{ hours per working year} \\ \times 60 \text{ minutes/hour} \times 2 \times 10^4 \text{ ml per minute}) = \\ [\text{ALI}/2.4 \times 10^9] \mu\text{Ci/ml,}$$

where  $2 \times 10^4$  ml per minute is the volume of air breathed per minute at work by Reference Man under working conditions of light work.

The DAC values relate to one of two modes of exposure: Either external submersion or the internal committed dose equivalents resulting from inhalation of radioactive materials. DACs based upon submersion are for immersion in a semi-infinite cloud of uniform concentration and apply to each radionuclide separately.

The ALI and DAC values include contributions to exposure by the single radionuclide named and any ingrowth of daughter radionuclides produced in the body by decay of the parent. However, intakes that include both the parent and daughter radionuclides should be treated by the general method appropriate for mixtures.

The values of ALI and DAC do not apply directly when the individual both ingests and inhales a radionuclide, when the individual is exposed to a mixture of radionuclides by either inhalation or ingestion or both, or when the individual is exposed to both internal and external irradiation. See WAC 246-221-015. When an individual is exposed to radioactive materials which fall under several of the translocation classifications of the same radionuclide, such as, Class D, Class W, or Class Y, the exposure may be evaluated as if it were a mixture of different radionuclides.

It should be noted that the classification of a compound as Class D, W, or Y is based on the chemical form of the compound and does not take into account the radiological half-life of different radionuclides. For this reason, values are given for Class D, W, and Y compounds, even for very short-lived radionuclides.

Table II "Effluent Concentrations"

The columns in Table II of this appendix captioned "Effluents," "Air" and "Water" are applicable to the assessment and control of dose to the public, particularly in the implementation of the provisions of WAC 246-221-070. The concentration values given in Columns 1 and 2 of Table II are equivalent to the radionuclide concentrations which, if inhaled or ingested continuously over the course of a year, would produce a total effective dose equivalent of 0.50 mSv (0.05 rem).

Consideration of nonstochastic limits has not been included in deriving the air and water effluent concentration limits because nonstochastic effects are presumed not to occur at or below the dose levels established for individual members of the public. For radionuclides, where the nonstochastic limit was governing in deriving the occupational DAC, the stochastic ALI was used in deriving the corresponding airborne effluent limit in Table II. For this reason, the DAC and airborne effluent limits are not always proportional as was the case in the previous Appendix A of this chapter.

The air concentration values listed in Table II, Column 1 were derived by one of two methods. For those radionuclides for which the stochastic limit is governing, the occupational stochastic inhalation ALI was divided by  $2.4 \times 10^9$ , relating the inhalation ALI to the DAC, as explained above, and then divided by a factor of three hundred. The factor of three hundred includes the following components: A factor of fifty to relate the 0.05 Sv (5 rem) annual occupational dose limit to the 1 mSv (0.1 rem) limit for

members of the public, a factor of three to adjust for the difference in exposure time and the inhalation rate for a worker and that for members of the public; and a factor of two to adjust the occupational values, derived for adults, so that they are applicable to other age groups.

For those radionuclides for which submersion, that is external dose, is limiting, the occupational DAC in Table I, Column 3 was divided by two hundred nineteen. The factor of two hundred nineteen is composed of a factor of fifty, as described above, and a factor of 4.38 relating occupational exposure for two thousand hours per year to full-time exposure (eight thousand seven hundred sixty hours per year). Note that an additional factor of two for age considerations is not warranted in the submersion case.

The water concentrations were derived by taking the most restrictive occupational stochastic oral ingestion ALI and dividing by  $7.3 \times 10^7$ . The factor of  $7.3 \times 10^7$  (ml) includes the following components: The factors of fifty and two described above and a factor of  $7.3 \times 10^5$  (ml) which is the annual water intake of Reference Man.

Note 2 of this appendix provides groupings of radionuclides which are applicable to unknown mixtures of radionuclides. These groupings, including occupational inhalation ALIs and DACs, air and water effluent concentrations and releases to sewer, require demonstrating that the most limiting radionuclides in successive classes are absent. The limit for the unknown mixture is defined when the presence of one of the listed radionuclides cannot be definitely excluded as being present either from knowledge of the radionuclide composition of the source or from actual measurements.

Table III "Releases to Sewers"

The monthly average concentrations for release to sanitary sewerage are applicable to the provisions in WAC 246-221-190. The concentration values were derived by taking the most restrictive occupational stochastic oral ingestion ALI and dividing by  $7.3 \times 10^6$  (ml). The factor of  $7.3 \times 10^6$  (ml) is composed of a factor of  $7.3 \times 10^5$  (ml), the annual water intake by Reference Man, and a factor of ten, such that the concentrations, if the sewage released by the licensee were the only source of water ingested by a Reference Man during a year, would result in a committed effective dose equivalent of 5 mSv (0.5 rem).

LIST OF ELEMENTS

Name	Symbol	Atomic Number	Name	Symbol	Atomic Number
Actinium	Ac	89	Mercury	Hg	80
Aluminum	Al	13	Molybdenum	Mo	42
Americium	Am	95	Neodymium	Nd	60
Antimony	Sb	51	Neptunium	Np	93
Argon	Ar	18	Nickel	Ni	28
Arsenic	As	33	Niobium	Nb	41
Astatine	At	85	Osmium	Os	76
Barium	Ba	56	Palladium	Pd	46
Berkelium	Bk	97	Phosphorus	P	15
Beryllium	Be	4	Platinum	Pt	78
Bismuth	Bi	83	Plutonium	Pu	94
Bromine	Br	35	Polonium	Po	84
Cadmium	Cd	48	Potassium	K	19
Calcium	Ca	20	Praseodymium	Pr	59
Californium	Cf	98	Promethium	Pm	61
Carbon	C	6	Protactinium	Pa	91
Cerium	Ce	58	Radium	Ra	88
Cesium	Cs	55	Radon	Rn	86
Chlorine	Cl	17	Rhenium	Re	75
Chromium	Cr	24	Rhodium	Rh	45
Cobalt	Co	27	Rubidium	Rb	37
Copper	Cu	29	Ruthenium	Ru	44
Curium	Cm	96	Samarium	Sm	62
Dysprosium	Dy	66	Scandium	Sc	21
Einsteinium	Es	99	Selenium	Se	34
Erbium	Er	68	Silicon	Si	14
Europium	Eu	63	Silver	Ag	47
Fermium	Fm	100	Sodium	Na	11
Fluorine	F	9	Strontium	Sr	38
Francium	Fr	87	Sulfur	S	16
Gadolinium	Gd	64	Tantalum	Ta	73
Gallium	Ga	31	Technetium	Tc	43
Germanium	Ge	32	Tellurium	Te	52
Gold	Au	79	Terbium	Tb	65
Hafnium	Hf	72	Thallium	Tl	81
Holmium	Ho	67	Thorium	Th	90
Hydrogen	H	1	Thulium	Tm	69
Indium	In	49	Tin	Sn	50
Iodine	I	53	Titanium	Ti	22
Iridium	Ir	77	Tungsten	W	74
Iron	Fe	26	Uranium	U	92
Krypton	Kr	36	Vanadium	V	23
Lanthanum	La	57	Xenon	Xe	54
Lead	Pb	82	Ytterbium	Yb	70
Lutetium	Lu	71	Yttrium	Y	39
Magnesium	Mg	12	Zinc	Zn	30
Manganese	Mn	25	Zirconium	Zr	40
Mendelevium	Md	101			

Table I Occupational Values

Table II Effluent Concentrations

Table III Releases to Sewers

Atomic No.	Radionuclide	Class	Table I Occupational Values			Table II Effluent Concentrations		Table III Releases to Sewers
			Col. 1 Oral Ingestion	Col. 2 Inhalation	Col. 3	Col. 1 Air	Col. 2 Water	
			ALI $\mu$ Ci	ALI $\mu$ Ci	DAC $\mu$ Ci/ml	$\mu$ Ci/ml	$\mu$ Ci/ml	Monthly Average Concentration $\mu$ Ci/ml

1	Hydrogen-3	Water, DAC includes skin absorption	8E+4	8E+4	2E-5	1E-7	1E-3	1E-2
---	------------	-------------------------------------	------	------	------	------	------	------

Gas (HT or T<sub>2</sub>) Submersion<sup>1</sup>: Use above values as HT and T<sub>2</sub> oxidize in air and in the body to HTO.



Radiation Protection Standards

246-221-290

4	Beryllium-7	W, all compounds except those given for Y Y, oxides, halides, and nitrates	4E+4 -	2E+4 2E+4	9E-6 8E-6	3E-8 3E-8	6E-4 -	6E-3 -
4	Beryllium-10	W, see <sup>7</sup> Be  Y, see <sup>7</sup> Be	1E+3 LLI wall (1E+3) -	2E+2 - 1E+1	6E-8 - 6E-9	2E-10 - 2E-11	- 2E-5 -	- 2E-4 -
6	Carbon-11 <sup>2</sup>	Monoxide Dioxide Compounds	- - 4E+5	1E+6 6E+5 4E+5	5E-4 3E-4 2E-4	2E-6 9E-7 6E-7	- - 6E-3	- - 6E-2
6	Carbon-14	Monoxide Dioxide Compounds	- - 2E+3	2E+6 2E+5 2E+3	7E-4 9E-5 1E-6	2E-6 3E-7 3E-9	- - 3E-5	- - 3E-4
9	Fluorine-18 <sup>2</sup>	D, fluorides of H, Li, Na, K, Rb, Cs, and Fr  W, fluorides of Be, Mg, Ca, Sr, Ba, Ra, Al, Ga, In, Tl, As, Sb, Bi, Fe, Ru, Os, Co, Ni, Pd, Pt, Cu, Ag, Au, Zn, Cd, Hg, Sc, Y, Ti, Zr, V, Nb, Ta, Mn, Tc, and Re Y, lanthanum fluoride	5E+4 St wall (5E+4) - -	7E+4 - - 9E+4 8E+4	3E-5 - - 4E-5 3E-5	1E-7 - - 1E-7 1E-7	- 7E-4 -	- 7E-3 -
11	Sodium-22	D, all compounds	4E+2	6E+2	3E-7	9E-10	6E-6	6E-5
11	Sodium-24	D, all compounds	4E+3	5E+3	2E-6	7E-9	5E-5	5E-4
12	Magnesium-28	D, all compounds except those given for W W, oxides, hydroxides, carbides, halides, and nitrates	7E+2 -	2E+3 1E+3	7E-7 5E-7	2E-9 2E-9	9E-6 -	9E-5 -
13	Aluminum-26	D, all compounds except those given for W  W, oxides, hydroxides, carbides, halides, and nitrates	4E+2 -	6E+1 9E+1	3E-8 4E-8	9E-11 1E-10	6E-6 -	6E-5 -
14	Silicon-31	D, all compounds except those given for W and Y W, oxides, hydroxides, carbides, and nitrates Y, aluminosilicate glass	9E+3 - -	3E+4 3E+4 3E+4	1E-5 1E-5 1E-5	4E-8 5E-8 4E-8	1E-4 - -	1E-3 - -
14	Silicon-32	D, see <sup>31</sup> Si  W, see <sup>31</sup> Si Y, see <sup>31</sup> Si	2E+3 LLI wall (3E+3) - -	2E+2 - 1E+2 5E+0	1E-7 - 5E-8 2E-9	3E-10 - 2E-10 7E-12	- 4E-5 -	- 4E-4 -
15	Phosphorus-32	D, all compounds except phosphates given for W W, phosphates of Zn <sup>2+</sup> , S <sup>3+</sup> , Mg <sup>2+</sup> , Fe <sup>3+</sup> , Bi <sup>3+</sup> , and lanthanides	6E+2 -	9E+2 4E+2	4E-7 2E-7	1E-9 5E-10	9E-6 -	9E-5 -
15	Phosphorus-33	D, see <sup>32</sup> P W, see <sup>32</sup> P	6E+3 -	8E+3 3E+3	4E-6 1E-6	1E-8 4E-9	8E-5 -	8E-4 -
16	Sulfur-35	Vapor D, sulfides and sulfates except those given for W  W, elemental sulfur, sulfides of Sr, Ba, Ge, Sn, Pb, As, Sb, Bi, Cu, Ag, Au, Zn, Cd, Hg, W, and Mo. Sulfates of Ca, Sr, Ba, Ra, As, Sb, and Bi	- 1E+4 LLI wall (8E+3) 6E+3 -	1E+4 2E+4 - -	6E-6 7E-6 - -	2E-8 2E-8 - -	- - 1E-4 -	- - 1E-3 -
17	Chlorine-36	D, chlorides of H, Li,						

		Na, K, Rb, Cs, and Fr W, chlorides of lantha- nides, Be, Mg, Ca, Sr, Ba, Ra, Al, Ga, In, Tl, Ge, Sn, Pb, As, Sb, Bi, Fe, Ru, Os, Co, Rh, Ir, Ni, Pd, Pt, Cu, Ag, Au, Zn, Cd, Hg, Sc, Y, Ti, Zr, Hf, V, Nb, Ta, Cr, Mo, W, Mn, Tc, and Re	2E+3	2E+3	1E-6	3E-9	2E-5	2E-4
17	Chlorine-38 <sup>2</sup>	D, see <sup>36</sup> Cl	2E+4 St wall (3E+4)	4E+4	2E-5	6E-8	-	-
		W, see <sup>36</sup> Cl	-	5E+4	2E-5	6E-8	3E-4	3E-3
17	Chlorine-39 <sup>2</sup>	D, see <sup>36</sup> Cl	2E+4 St wall (4E+4)	5E+4	2E-5	7E-8	-	-
		W, see <sup>36</sup> Cl	-	6E+4	2E-5	8E-8	5E-4	5E-3
18	Argon-37	Submersion <sup>1</sup>	-	-	1E+0	6E-3	-	-
18	Argon-39	Submersion <sup>1</sup>	-	-	2E-4	8E-7	-	-
18	Argon-41	Submersion <sup>1</sup>	-	-	3E-6	1E-8	-	-
19	Potassium-40	D, all compounds	3E+2	4E+2	2E-7	6E-10	4E-6	4E-5
19	Potassium-42	D, all compounds	5E+3	5E+3	2E-6	7E-9	6E-5	6E-4
19	Potassium-43	D, all compounds	6E+3	9E+3	4E-6	1E-8	9E-5	9E-4
19	Potassium-44 <sup>2</sup>	D, all compounds	2E+4 St wall (4E+4)	7E+4	3E-5	9E-8	-	-
			-	-	-	-	5E-4	5E-3
19	Potassium-45 <sup>2</sup>	D, all compounds	3E+4 St wall (5E+4)	1E+5	5E-5	2E-7	-	-
			-	-	-	-	7E-4	7E-3
20	Calcium-41	W, all compounds	3E+3 Bone surf (4E+3)	4E+3 Bone surf (4E+3)	2E-6	-	-	-
			-	-	-	5E-9	6E-5	6E-4
20	Calcium-45	W, all compounds	2E+3	8E+2	4E-7	1E-9	2E-5	2E-4
20	Calcium-47	W, all compounds	8E+2	9E+2	4E-7	1E-9	1E-5	1E-4
21	Scandium-43	Y, all compounds	7E+3	2E+4	9E-6	3E-8	1E-4	1E-3
21	Scandium-44m	Y, all compounds	5E+2	7E+2	3E-7	1E-9	7E-6	7E-5
21	Scandium-44	Y, all compounds	4E+3	1E+4	5E-6	2E-8	5E-5	5E-4
21	Scandium-46	Y, all compounds	9E+2	2E+2	1E-7	3E-10	1E-5	1E-4
21	Scandium-47	Y, all compounds	2E+3 LLI wall (3E+3)	3E+3	1E-6	4E-9	-	-
			-	-	-	-	4E-5	4E-4
21	Scandium-48	Y, all compounds	8E+2	1E+3	6E-7	2E-9	1E-5	1E-4
21	Scandium-49 <sup>2</sup>	Y, all compounds	2E+4	5E+4	2E-5	8E-8	3E-4	3E-3
22	Titanium-44	D, all compounds except those given for W and Y W, oxides, hydroxides, carbides, halides, and nitrates Y, SrTiO	3E+2	1E+1	5E-9	2E-11	4E-6	4E-5
			-	3E+1	1E-8	4E-11	-	-
			-	6E+0	2E-9	8E-12	-	-
22	Titanium-45	D, see <sup>44</sup> Ti W, see <sup>44</sup> Ti Y, see <sup>44</sup> Ti	9E+3	3E+4	1E-5	3E-8	1E-4	1E-3
			-	4E+4	1E-5	5E-8	-	-
			-	3E+4	1E-5	4E-8	-	-
23	Vanadium-47 <sup>2</sup>	D, all compounds except those given for W	3E+4 St wall (3E+4)	8E+4	3E-5	1E-7	-	-
		W, oxides, hydroxides, carbides, and halides	-	1E+5	4E-5	1E-7	-	-
23	Vanadium-48	D, see <sup>47</sup> V W, see <sup>47</sup> V	6E+2	1E+3	5E-7	2E-9	9E-6	9E-5
			-	6E+2	3E-7	9E-10	-	-
23	Vanadium-49	D, see <sup>47</sup> V	7E+4	3E+4	1E-5	-	-	-

		LLI wall (9E+4)	Bone surf (3E+4)	-	5E-8	1E-3	1E-2	
	W, see <sup>47</sup> V	-	2E+4	8E-6	2E-8	-	-	
24	Chromium-48	D, all compounds except those given for W and Y	6E+3	1E+4	5E-6	2E-8	8E-5	8E-4
	W, halides and nitrates	-	7E+3	3E-6	1E-8	-	-	
	Y, oxides and hydroxides	-	7E+3	3E-6	1E-8	-	-	
24	Chromium-49 <sup>2</sup>	D, see <sup>48</sup> Cr	3E+4	8E+4	4E-5	1E-7	4E-4	4E-3
	W, see <sup>48</sup> Cr	-	1E+5	4E-5	1E-7	-	-	
	Y, see <sup>48</sup> Cr	-	9E+4	4E-5	1E-7	-	-	
24	Chromium-51	D, see <sup>48</sup> Cr	4E+4	5E+4	2E-5	6E-8	5E-4	5E-3
	W, see <sup>48</sup> Cr	-	2E+4	1E-5	3E-8	-	-	
	Y, see <sup>48</sup> Cr	-	2E+4	8E-6	3E-8	-	-	
25	Manganese-51 <sup>2</sup>	D, all compounds except those given for W	2E+4	5E+4	2E-5	7E-8	3E-4	3E-3
	W, oxides, hydroxides, halides, and nitrates	-	6E+4	3E-5	8E-8	-	-	
25	Manganese-52m <sup>2</sup>	D, see <sup>51</sup> Mn	3E+4	9E+4	4E-5	1E-7	-	-
		St wall (4E+4)	-	-	-	5E-4	5E-3	
	W, see <sup>51</sup> Mn	-	1E+5	4E-5	1E-7	-	-	
25	Manganese-52	D, see <sup>51</sup> Mn	7E+2	1E+3	5E-7	2E-9	1E-5	1E-4
	W, see <sup>51</sup> Mn	-	9E+2	4E-7	1E-9	-	-	
25	Manganese-53	D, see <sup>51</sup> Mn	5E+4	1E+4	5E-6	-	7E-4	7E-3
				Bone surf (2E+4)	-	3E-8	-	
	W, see <sup>51</sup> Mn	-	1E+4	5E-6	2E-8	-	-	
25	Manganese-54	D, see <sup>51</sup> Mn	2E+3	9E+2	4E-7	1E-9	3E-5	3E-4
	W, see <sup>51</sup> Mn	-	8E+2	3E-7	1E-9	-	-	
25	Manganese-56	D, see <sup>51</sup> Mn	5E+3	2E+4	6E-6	2E-8	7E-5	7E-4
	W, see <sup>51</sup> Mn	-	2E+4	9E-6	3E-8	-	-	
26	Iron-52	D, all compounds except those given for W	9E+2	3E+3	1E-6	4E-9	1E-5	1E-4
	W, oxides, hydroxides, and halides	-	2E+3	1E-6	3E-9	-	-	
26	Iron-55	D, see <sup>52</sup> Fe	9E+3	2E+3	8E-7	3E-9	1E-4	1E-3
	W, see <sup>52</sup> Fe	-	4E+3	2E-6	6E-9	-	-	
26	Iron-59	D, see <sup>52</sup> Fe	8E+2	3E+2	1E-7	5E-10	1E-5	1E-4
	W, see <sup>52</sup> Fe	-	5E+2	2E-7	7E-10	-	-	
26	Iron-60	D, see <sup>52</sup> Fe	3E+1	6E+0	3E-9	9E-12	4E-7	4E-6
	W, see <sup>52</sup> Fe	-	2E+1	8E-9	3E-11	-	-	
27	Cobalt-55	W, all compounds except those given for Y	1E+3	3E+3	1E-6	4E-9	2E-5	2E-4
	Y, oxides, hydroxides, halides, and nitrates	-	3E+3	1E-6	4E-9	-	-	
27	Cobalt-56	W, see <sup>55</sup> Co	5E+2	3E+2	1E-7	4E-10	6E-6	6E-5
	Y, see <sup>55</sup> Co	4E+2	2E+2	8E-8	3E-10	-	-	
27	Cobalt-57	W, see <sup>55</sup> Co	8E+3	3E+3	1E-6	4E-9	6E-5	6E-4
	Y, see <sup>55</sup> Co	4E+3	7E+2	3E-7	9E-10	-	-	
27	Cobalt-58m	W, see <sup>55</sup> Co	6E+4	9E+4	4E-5	1E-7	8E-4	8E-3
	Y, see <sup>55</sup> Co	-	6E+4	3E-5	9E-8	-	-	
27	Cobalt-58	W, see <sup>55</sup> Co	2E+3	1E+3	5E-7	2E-9	2E-5	2E-4
	Y, see <sup>55</sup> Co	1E+3	7E+2	3E-7	1E-9	-	-	
27	Cobalt-60m <sup>2</sup>	W, see <sup>55</sup> Co	1E+6	4E+6	2E-3	6E-6	-	-
		St wall (1E+6)	-	-	-	2E-2	2E-1	
	Y, see <sup>55</sup> Co	-	3E+6	1E-3	4E-6	-	-	
27	Cobalt-60	W, see <sup>55</sup> Co	5E+2	2E+2	7E-8	2E-10	3E-6	3E-5
	Y, see <sup>55</sup> Co	2E+2	3E+1	1E-8	5E-11	-	-	
27	Cobalt-61 <sup>2</sup>	W, see <sup>55</sup> Co	2E+4	6E+4	3E-5	9E-8	3E-4	3E-3
	Y, see <sup>55</sup> Co	2E+4	6E+4	2E-5	8E-8	-	-	
27	Cobalt-62m <sup>2</sup>	W, see <sup>55</sup> Co	4E+4	2E+5	7E-5	2E-7	-	-
		St wall	-	-	-	-	-	

		Y, see <sup>55</sup> Co	(5E+4)	-	-	-	7E-4	7E-3
			-	2E+5	6E-5	2E-7	-	-
28	Nickel-56	D, all compounds except those given for W	1E+3	2E+3	8E-7	3E-9	2E-5	2E-4
		W, oxides, hydroxides, and carbides	-	1E+3	5E-7	2E-9	-	-
		Vapor	-	1E+3	5E-7	2E-9	-	-
28	Nickel-57	D, see <sup>56</sup> Ni	2E+3	5E+3	2E-6	7E-9	2E-5	2E-4
		W, see <sup>56</sup> Ni	-	3E+3	1E-6	4E-9	-	-
		Vapor	-	6E+3	3E-6	9E-9	-	-
28	Nickel-59	D, see <sup>56</sup> Ni	2E+4	4E+3	2E-6	5E-9	3E-4	3E-3
		W, see <sup>56</sup> Ni	-	7E+3	3E-6	1E-8	-	-
		Vapor	-	2E+3	8E-7	3E-9	-	-
28	Nickel-63	D, see <sup>56</sup> Ni	9E+3	2E+3	7E-7	2E-9	1E-4	1E-3
		W, see <sup>56</sup> Ni	-	3E+3	1E-6	4E-9	-	-
		Vapor	-	8E+2	3E-7	1E-9	-	-
28	Nickel-65	D, see <sup>56</sup> Ni	8E+3	2E+4	1E-5	3E-8	1E-4	1E-3
		W, see <sup>56</sup> Ni	-	3E+4	1E-5	4E-8	-	-
		Vapor	-	2E+4	7E-6	2E-8	-	-
28	Nickel-66	D, see <sup>56</sup> Ni	4E+2	2E+3	7E-7	2E-9	-	-
			LLI wall (5E+2)	-	-	-	6E-6	6E-5
		W, see <sup>56</sup> Ni	-	6E+2	3E-7	9E-10	-	-
		Vapor	-	3E+3	1E-6	4E-9	-	-
29	Copper-60 <sup>2</sup>	D, all compounds except those given for W and Y	3E+4	9E+4	4E-5	1E-7	-	-
			St wall (3E+4)	-	-	-	4E-4	4E-3
		W, sulfides, halides, and nitrates	-	1E+5	5E-5	2E-7	-	-
		Y, oxides and hydroxides	-	1E+5	4E-5	1E-7	-	-
29	Copper-61	D, see <sup>60</sup> Cu	1E+4	3E+4	1E-5	4E-8	2E-4	2E-3
		W, see <sup>60</sup> Cu	-	4E+4	2E-5	6E-8	-	-
		Y, see <sup>60</sup> Cu	-	4E+4	1E-5	5E-8	-	-
29	Copper-64	D, see <sup>60</sup> Cu	1E+4	3E+4	1E-5	4E-8	2E-4	2E-3
		W, see <sup>60</sup> Cu	-	2E+4	1E-5	3E-8	-	-
		Y, see <sup>60</sup> Cu	-	2E+4	9E-6	3E-8	-	-
29	Copper-67	D, see <sup>60</sup> Cu	5E+3	8E+3	3E-6	1E-8	6E-5	6E-4
		W, see <sup>60</sup> Cu	-	5E+3	2E-6	7E-9	-	-
		Y, see <sup>60</sup> Cu	-	5E+3	2E-6	6E-9	-	-
30	Zinc-62	Y, all compounds	1E+3	3E+3	1E-6	4E-9	2E-5	2E-4
30	Zinc-63 <sup>2</sup>	Y, all compounds	2E+4	7E+4	3E-5	9E-8	-	-
			St wall (3E+4)	-	-	-	3E-4	3E-3
30	Zinc-65	Y, all compounds	4E+2	3E+2	1E-7	4E-10	5E-6	5E-5
30	Zinc-69m	Y, all compounds	4E+3	7E+3	3E-6	1E-8	6E-5	6E-4
30	Zinc-69 <sup>2</sup>	Y, all compounds	6E+4	1E+5	6E-5	2E-7	8E-4	8E-3
30	Zinc-71m	Y, all compounds	6E+3	2E+4	7E-6	2E-8	8E-5	8E-4
30	Zinc-72	Y, all compounds	1E+3	1E+3	5E-7	2E-9	1E-5	1E-4
31	Gallium-65 <sup>2</sup>	D, all compounds except those given for W	5E+4	2E+5	7E-5	2E-7	-	-
			St wall (6E+4)	-	-	-	9E-4	9E-3
		W, oxides, hydroxides, carbides, halides, and nitrates	-	2E+5	8E-5	3E-7	-	-
31	Gallium-66	D, see <sup>65</sup> Ga	1E+3	4E+3	1E-6	5E-9	1E-5	1E-4
		W, see <sup>65</sup> Ga	-	3E+3	1E-6	4E-9	-	-
31	Gallium-67	D, see <sup>65</sup> Ga	7E+3	1E+4	6E-6	2E-8	1E-4	1E-3
		W, see <sup>65</sup> Ga	-	1E+4	4E-6	1E-8	-	-
31	Gallium-68 <sup>2</sup>	D, see <sup>65</sup> Ga	2E+4	4E+4	2E-5	6E-8	2E-4	2E-3
		W, see <sup>65</sup> Ga	-	5E+4	2E-5	7E-8	-	-
31	Gallium-70 <sup>2</sup>	D, see <sup>65</sup> Ga	5E+4	2E+5	7E-5	2E-7	-	-

			St wall (7E+4)	-	-	-	1E-3	1E-2
		W, see <sup>65</sup> Ga	-	2E+5	8E-5	3E-7	-	-
31	Gallium-72	D, see <sup>65</sup> Ga	1E+3	4E+3	1E-6	5E-9	2E-5	2E-4
		W, see <sup>65</sup> Ga	-	3E+3	1E-6	4E-9	-	-
31	Gallium-73	D, see <sup>65</sup> Ga	5E+3	2E+4	6E-6	2E-8	7E-5	7E-4
		W, see <sup>65</sup> Ga	-	2E+4	6E-6	2E-8	-	-
32	Germanium-66	D, all compounds except those given for W	2E+4	3E+4	1E-5	4E-8	3E-4	3E-3
		W, oxides, sulfides, and halides	-	2E+4	8E-6	3E-8	-	-
32	Germanium-67 <sup>2</sup>	D, see <sup>66</sup> Ge	3E+4	9E+4	4E-5	1E-7	-	-
			St wall (4E+4)	-	-	-	6E-4	6E-3
		W, see <sup>66</sup> Ge	-	1E+5	4E-5	1E-7	-	-
32	Germanium-68	D, see <sup>66</sup> Ge	5E+3	4E+3	2E-6	5E-9	6E-5	6E-4
		W, see <sup>66</sup> Ge	-	1E+2	4E-8	1E-10	-	-
32	Germanium-69	D, see <sup>66</sup> Ge	1E+4	2E+4	6E-6	2E-8	2E-4	2E-3
		W, see <sup>66</sup> Ge	-	8E+3	3E-6	1E-8	-	-
32	Germanium-71	D, see <sup>66</sup> Ge	5E+5	4E+5	2E-4	6E-7	7E-3	7E-2
		W, see <sup>66</sup> Ge	-	4E+4	2E-5	6E-8	-	-
32	Germanium-75 <sup>2</sup>	D, see <sup>66</sup> Ge	4E+4	8E+4	3E-5	1E-7	-	-
			St wall (7E+4)	-	-	-	9E-4	9E-3
		W, see <sup>66</sup> Ge	-	8E+4	4E-5	1E-7	-	-
32	Germanium-77	D, see <sup>66</sup> Ge	9E+3	1E+4	4E-6	1E-8	1E-4	1E-3
		W, see <sup>66</sup> Ge	-	6E+3	2E-6	8E-9	-	-
32	Germanium-78 <sup>2</sup>	D, see <sup>66</sup> Ge	2E+4	2E+4	9E-6	3E-8	-	-
			St wall (2E+4)	-	-	-	3E-4	3E-3
		W, see <sup>66</sup> Ge	-	2E+4	9E-6	3E-8	-	-
33	Arsenic-69 <sup>2</sup>	W, all compounds	3E+4	1E+5	5E-5	2E-7	-	-
			St wall (4E+4)	-	-	-	6E-4	6E-3
33	Arsenic-70 <sup>2</sup>	W, all compounds	1E+4	5E+4	2E-5	7E-8	2E-4	2E-3
33	Arsenic-71	W, all compounds	4E+3	5E+3	2E-6	6E-9	5E-5	5E-4
33	Arsenic-72	W, all compounds	9E+2	1E+3	6E-7	2E-9	1E-5	1E-4
33	Arsenic-73	W, all compounds	8E+3	2E+3	7E-7	2E-9	1E-4	1E-3
33	Arsenic-74	W, all compounds	1E+3	8E+2	3E-7	1E-9	2E-5	2E-4
33	Arsenic-76	W, all compounds	1E+3	1E+3	6E-7	2E-9	1E-5	1E-4
33	Arsenic-77	W, all compounds	4E+3	5E+3	2E-6	7E-9	-	-
			LLI wall (5E+3)	-	-	-	6E-5	6E-4
33	Arsenic-78 <sup>2</sup>	W, all compounds	8E+3	2E+4	9E-6	3E-8	1E-4	1E-3
34	Selenium-70 <sup>2</sup>	D, all compounds except those given for W	2E+4	4E+4	2E-5	5E-8	1E-4	1E-3
		W, oxides, hydroxides, carbides, and elemental Se	1E+4	4E+4	2E-5	6E-8	-	-
34	Selenium-73m <sup>2</sup>	D, see <sup>70</sup> Se	6E+4	2E+5	6E-5	2E-7	4E-4	4E-3
		W, see <sup>70</sup> Se	3E+4	1E+5	6E-5	2E-7	-	-
34	Selenium-73	D, see <sup>70</sup> Se	3E+3	1E+4	5E-6	2E-8	4E-5	4E-4
		W, see <sup>70</sup> Se	-	2E+4	7E-6	2E-8	-	-
34	Selenium-75	D, see <sup>70</sup> Se	5E+2	7E+2	3E-7	1E-9	7E-6	7E-5
		W, see <sup>70</sup> Se	-	6E+2	3E-7	8E-10	-	-
34	Selenium-79	D, see <sup>70</sup> Se	6E+2	8E+2	3E-7	1E-9	8E-6	8E-5
		W, see <sup>70</sup> Se	-	6E+2	2E-7	8E-10	-	-
34	Selenium-81m <sup>2</sup>	D, see <sup>70</sup> Se	4E+4	7E+4	3E-5	9E-8	3E-4	3E-3
		W, see <sup>70</sup> Se	2E+4	7E+4	3E-5	1E-7	-	-
34	Selenium-81 <sup>2</sup>	D, see <sup>70</sup> Se	6E+4	2E+5	9E-5	3E-7	-	-
			St wall	-	-	-	-	-

			(8E+4)	-	-	-	1E-3	1E-2
		W, see <sup>70</sup> Se	-	2E+5	1E-4	3E-7	-	-
34	Selenium-83 <sup>2</sup>	D, see <sup>70</sup> Se	4E+4	1E+5	5E-5	2E-7	4E-4	4E-3
		W, see <sup>70</sup> Se	3E+4	1E+5	5E-5	2E-7	-	-
35	Bromine-74m <sup>2</sup>	D, bromides of H, Li, Na, K, Rb, Cs, and Fr	1E+4 St wall (2E+4)	4E+4	2E-5	5E-8	-	-
		W, bromides of lantha- nides, Be, Mg, Ca, Sr, Ba, Ra, Al, Ga, In, Tl, Ge, Sn, Pb, As, Sb, Bi, Fe, Ru, Os, Co, Rh, Ir, Ni, Pd, Pt, Cu, Ag, Au, Zn, Cd, Hg, Sc, Y, Ti, Zr, Hf, V, Nb, Ta, Mn, Tc, and Re	-	4E+4	2E-5	6E-8	-	-
35	Bromine-74 <sup>2</sup>	D, see <sup>74m</sup> Br	2E+4 St wall (4E+4)	7E+4	3E-5	1E-7	-	-
		W, see <sup>74m</sup> Br	-	8E+4	4E-5	1E-7	5E-45E-3	-
35	Bromine-75 <sup>2</sup>	D, see <sup>74m</sup> Br	3E+4 St wall (4E+4)	5E+4	2E-5	7E-8	-	-
		W, see <sup>74m</sup> Br	-	5E+4	2E-5	7E-8	5E-4	5E-3
35	Bromine-76	D, see <sup>74m</sup> Br	4E+3	5E+3	2E-6	7E-9	5E-5	5E-4
		W, see <sup>74m</sup> Br	-	4E+3	2E-6	6E-9	-	-
35	Bromine-77	D, see <sup>74m</sup> Br	2E+4	2E+4	1E-5	3E-8	2E-4	2E-3
		W, see <sup>74m</sup> Br	-	2E+4	8E-6	3E-8	-	-
35	Bromine-80m	D, see <sup>74m</sup> Br	2E+4	2E+4	7E-6	2E-8	3E-4	3E-3
		W, see <sup>74m</sup> Br	-	1E+4	6E-6	2E-8	-	-
35	Bromine-80 <sup>2</sup>	D, see <sup>74m</sup> Br	5E+4 St wall (9E+4)	2E+5	8E-5	3E-7	-	-
		W, see <sup>74m</sup> Br	-	2E+5	9E-5	3E-7	1E-3	1E-2
35	Bromine-82	D, see <sup>74m</sup> Br	3E+3	4E+3	2E-6	6E-9	4E-5	4E-4
		W, see <sup>74m</sup> Br	-	4E+3	2E-6	5E-9	-	-
35	Bromine-83	D, see <sup>74m</sup> Br	5E+4 St wall (7E+4)	6E+4	3E-5	9E-8	-	-
		W, see <sup>74m</sup> Br	-	6E+4	3E-5	9E-8	9E-4	9E-3
35	Bromine-84 <sup>2</sup>	D, see <sup>74m</sup> Br	2E+4 St wall (3E+4)	6E+4	2E-5	8E-8	-	-
		W, see <sup>74m</sup> Br	-	6E+4	3E-5	9E-8	4E-4	4E-3
36	Krypton-74 <sup>2</sup>	Submersion <sup>1</sup>	-	-	3E-6	1E-8	-	-
36	Krypton-76	Submersion <sup>1</sup>	-	-	9E-6	4E-8	-	-
36	Krypton-77 <sup>2</sup>	Submersion <sup>1</sup>	-	-	4E-6	2E-8	-	-
36	Krypton-79	Submersion <sup>1</sup>	-	-	2E-5	7E-8	-	-
36	Krypton-81	Submersion <sup>1</sup>	-	-	7E-4	3E-6	-	-
36	Krypton-83m <sup>2</sup>	Submersion <sup>1</sup>	-	-	1E-2	5E-5	-	-
36	Krypton-85m	Submersion <sup>1</sup>	-	-	2E-5	1E-7	-	-
36	Krypton-85	Submersion <sup>1</sup>	-	-	1E-4	7E-7	-	-
36	Krypton-87 <sup>2</sup>	Submersion <sup>1</sup>	-	-	5E-6	2E-8	-	-
36	Krypton-88	Submersion <sup>1</sup>	-	-	2E-6	9E-9	-	-
37	Rubidium-79 <sup>2</sup>	D, all compounds	4E+4 St wall (6E+4)	1E+5	5E-5	2E-7	-	-
			-	-	-	-	8E-4	8E-3
37	Rubidium-81m <sup>2</sup>	D, all compounds	2E+5 St wall (3E+5)	3E+5	1E-4	5E-7	-	-
			-	-	-	-	4E-3	4E-2
37	Rubidium-81	D, all compounds	4E+4	5E+4	2E-5	7E-8	5E-4	5E-3



Radiation Protection Standards

246-221-290

37	Rubidium-82m	D, all compounds	1E+4	2E+4	7E-6	2E-8	2E-4	2E-3
37	Rubidium-83	D, all compounds	6E+2	1E+3	4E-7	1E-9	9E-6	9E-5
37	Rubidium-84	D, all compounds	5E+2	8E+2	3E-7	1E-9	7E-6	7E-5
37	Rubidium-86	D, all compounds	5E+2	8E+2	3E-7	1E-9	7E-6	7E-5
37	Rubidium-87	D, all compounds	1E+3	2E+3	6E-7	2E-9	1E-5	1E-4
37	Rubidium-88 <sup>2</sup>	D, all compounds	2E+4	6E+4	3E-5	9E-8	-	-
			St wall (3E+4)	-	-	-	4E-4	4E-3
37	Rubidium-89 <sup>2</sup>	D, all compounds	4E+4	1E+5	6E-5	2E-7	-	-
			St wall (6E+4)	-	-	-	9E-4	9E-3
38	Strontium-80 <sup>2</sup>	D, all soluble compounds except SrTiO	4E+3	1E+4	5E-6	2E-8	6E-5	6E-4
		Y, all insoluble com- pounds and SrTiO	-	1E+4	5E-6	2E-8	-	-
38	Strontium-81 <sup>2</sup>	D, see <sup>80</sup> Sr	3E+4	8E+4	3E-5	1E-7	3E-4	3E-3
		Y, see <sup>80</sup> Sr	2E+4	8E+4	3E-5	1E-7	-	-
38	Strontium-82	D, see <sup>80</sup> Sr	3E+2	4E+2	2E-7	6E-10	-	-
			LLI wall (2E+2)	-	-	-	3E-6	3E-5
		Y, see <sup>80</sup> Sr	2E+2	9E+1	4E-8	1E-10	-	-
38	Strontium-83	D, see <sup>80</sup> Sr	3E+3	7E+3	3E-6	1E-8	3E-5	3E-4
		Y, see <sup>80</sup> Sr	2E+3	4E+3	1E-6	5E-9	-	-
38	Strontium-85m <sup>2</sup>	D, see <sup>80</sup> Sr	2E+5	6E+5	3E-4	9E-7	3E-3	3E-2
		Y, see <sup>80</sup> Sr	-	8E+5	4E-4	1E-6	-	-
38	Strontium-85	D, see <sup>80</sup> Sr	3E+3	3E+3	1E-6	4E-9	4E-5	4E-4
		Y, see <sup>80</sup> Sr	-	2E+3	6E-7	2E-9	-	-
38	Strontium-87m	D, see <sup>80</sup> Sr	5E+4	1E+5	5E-5	2E-7	6E-4	6E-3
		Y, see <sup>80</sup> Sr	4E+4	2E+5	6E-5	2E-7	-	-
38	Strontium-89	D, see <sup>80</sup> Sr	6E+2	8E+2	4E-7	1E-9	-	-
			LLI wall (6E+2)	-	-	-	8E-6	8E-5
		Y, see <sup>80</sup> Sr	5E+2	1E+2	6E-8	2E-10	-	-
38	Strontium-90	D, see <sup>80</sup> Sr	3E+1	2E+1	8E-9	-	-	-
			Bone surf (4E+1)	Bone surf (2E+1)	-	3E-11	5E-7	5E-6
		Y, see <sup>80</sup> Sr	-	4E+0	2E-9	6E-12	-	-
38	Strontium-91	D, see <sup>80</sup> Sr	2E+3	6E+3	2E-6	8E-9	2E-5	2E-4
		Y, see <sup>80</sup> Sr	-	4E+3	1E-6	5E-9	-	-
38	Strontium-92	D, see <sup>80</sup> Sr	3E+3	9E+3	4E-6	1E-8	4E-5	4E-4
		Y, see <sup>80</sup> Sr	-	7E+3	3E-6	9E-9	-	-
39	Yttrium-86m <sup>2</sup>	W, all compounds except those given for Y	2E+4	6E+4	2E-5	8E-8	3E-4	3E-3
		Y, oxides and hydroxides	-	5E+4	2E-5	8E-8	-	-
39	Yttrium-86	W, see <sup>86m</sup> Y	1E+3	3E+3	1E-6	5E-9	2E-5	2E-4
		Y, see <sup>86m</sup> Y	-	3E+3	1E-6	5E-9	-	-
39	Yttrium-87	W, see <sup>86m</sup> Y	2E+3	3E+3	1E-6	5E-9	3E-5	3E-4
		Y, see <sup>86m</sup> Y	-	3E+3	1E-6	5E-9	-	-
39	Yttrium-88	W, see <sup>86m</sup> Y	1E+3	3E+2	1E-7	3E-10	1E-5	1E-4
		Y, see <sup>86m</sup> Y	-	2E+2	1E-7	3E-10	-	-
39	Yttrium-90m	W, see <sup>86m</sup> Y	8E+3	1E+4	5E-6	2E-8	1E-4	1E-3
		Y, see <sup>86m</sup> Y	-	1E+4	5E-6	2E-8	-	-
39	Yttrium-90	W, see <sup>86m</sup> Y	4E+2	7E+2	3E-7	9E-10	-	-
			LLI wall (5E+2)	-	-	-	7E-6	7E-5
		Y, see <sup>86m</sup> Y	-	6E+2	3E-7	9E-10	-	-
39	Yttrium-91m <sup>2</sup>	W, see <sup>86m</sup> Y	1E+5	2E+5	1E-4	3E-7	2E-3	2E-2
		Y, see <sup>86m</sup> Y	-	2E+5	7E-5	2E-7	-	-
39	Yttrium-91	W, see <sup>86m</sup> Y	5E+2	2E+2	7E-8	2E-10	-	-
			LLI wall (6E+2)	-	-	-	8E-6	8E-5
		Y, see <sup>86m</sup> Y	-	1E+2	5E-8	2E-10	-	-

39	Yttrium-92	W, see <sup>86</sup> mY Y, see <sup>86</sup> mY	3E+3 -	9E+3 8E+3	4E-6 3E-6	1E-8 1E-8	4E-5 -	4E-4 -
39	Yttrium-93	W, see <sup>86</sup> mY Y, see <sup>86</sup> mY	1E+3 -	3E+3 2E+3	1E-6 1E-6	4E-9 3E-9	2E-5 -	2E-4 -
39	Yttrium-94 <sup>2</sup>	W, see <sup>86</sup> mY	2E+4 St wall (3E+4)	8E+4 -	3E-5 -	1E-7 -	- 4E-4	- 4E-3
		Y, see <sup>86</sup> mY	-	8E+4	3E-5	1E-7	-	-
39	Yttrium-95 <sup>2</sup>	W, see <sup>86</sup> mY	4E+4 St wall (5E+4)	2E+5 -	6E-5 -	2E-7 -	- 7E-4	- 7E-3
		Y, see <sup>86</sup> mY	-	1E+5	6E-5	2E-7	-	-
40	Zirconium-86	D, all compounds except those given for W and Y W, oxides, hydroxides, halides, and nitrates Y, carbide	1E+3 - -	4E+3 3E+3 2E+3	2E-6 1E-6 1E-6	6E-9 4E-9 3E-9	2E-5 -	2E-4 -
40	Zirconium-88	D, see <sup>86</sup> Zr W, see <sup>86</sup> Zr Y, see <sup>86</sup> Zr	4E+3 - -	2E+2 5E+2 3E+2	9E-8 2E-7 1E-7	3E-10 7E-10 4E-10	5E-5 -	5E-4 -
40	Zirconium-89	D, see <sup>86</sup> Zr W, see <sup>86</sup> Zr Y, see <sup>86</sup> Zr	2E+3 - -	4E+3 2E+3 2E+3	1E-6 1E-6 1E-6	5E-9 3E-9 3E-9	2E-5 -	2E-4 -
40	Zirconium-93	D, see <sup>86</sup> Zr W, see <sup>86</sup> Zr Y, see <sup>86</sup> Zr	1E+3 Bone surf (3E+3) - -	6E+0 Bone surf (2E+1) 2E+1 Bone surf (6E+1) 6E+1 Bone surf (7E+1)	3E-9 - 1E-8 -	- 2E-11 - 9E-11 -	- 4E-5 -	- 4E-4 -
40	Zirconium-95	D, see <sup>86</sup> Zr W, see <sup>86</sup> Zr Y, see <sup>86</sup> Zr	1E+3 - -	1E+2 Bone surf (3E+2) 4E+2 3E+2	5E-8 -	- 4E-10 5E-10 4E-10	2E-5 -	2E-4 -
40	Zirconium-97	D, see <sup>86</sup> Zr W, see <sup>86</sup> Zr Y, see <sup>86</sup> Zr	6E+2 - -	2E+3 1E+3 1E+3	8E-7 6E-7 5E-7	3E-9 2E-9 2E-9	9E-6 -	9E-5 -
41	Niobium-88 <sup>2</sup>	W, all compounds except those given for Y Y, oxides and hydroxides	5E+4 St wall (7E+4) -	2E+5 -	9E-5 -	3E-7 -	- 1E-3	- 1E-2
41	Niobium-89 <sup>2</sup> (66 min)	W, see <sup>88</sup> Nb Y, see <sup>88</sup> Nb	1E+4 -	4E+4 4E+4	2E-5 2E-5	6E-8 5E-8	1E-4 -	1E-3 -
41	Niobium-89 (122 min)	W, see <sup>88</sup> Nb Y, see <sup>88</sup> Nb	5E+3 -	2E+4 2E+4	8E-6 6E-6	3E-8 2E-8	7E-5 -	7E-4 -
41	Niobium-90	W, see <sup>88</sup> Nb Y, see <sup>88</sup> Nb	1E+3 -	3E+3 2E+3	1E-6 1E-6	4E-9 3E-9	1E-5 -	1E-4 -
41	Niobium-93m	W, see <sup>88</sup> Nb Y, see <sup>88</sup> Nb	9E+3 LLI wall (1E+4) -	2E+3 -	8E-7 -	3E-9 -	- 2E-4	- 2E-3
41	Niobium-94	W, see <sup>88</sup> Nb Y, see <sup>88</sup> Nb	9E+2 -	2E+2 2E+1	8E-8 6E-9	3E-10 2E-11	1E-5 -	1E-4 -
41	Niobium-95m	W, see <sup>88</sup> Nb Y, see <sup>88</sup> Nb	2E+3 LLI wall (2E+3) -	3E+3 -	1E-6 -	4E-9 -	- 3E-5	- 3E-4
41	Niobium-95	W, see <sup>88</sup> Nb Y, see <sup>88</sup> Nb	2E+3 -	1E+3 1E+3	5E-7 5E-7	2E-9 2E-9	3E-5 -	3E-4 -
41	Niobium-96	W, see <sup>88</sup> Nb	1E+3	3E+3	1E-6	4E-9	2E-5	2E-4

Radiation Protection Standards

246-221-290

		Y, see <sup>88</sup> Nb	-	2E+3	1E-6	3E-9	-	-
41	Niobium-97 <sup>2</sup>	W, see <sup>88</sup> Nb	2E+4	8E+4	3E-5	1E-7	3E-4	3E-3
		Y, see <sup>88</sup> Nb	-	7E+4	3E-5	1E-7	-	-
41	Niobium-98 <sup>2</sup>	W, see <sup>88</sup> Nb	1E+4	5E+4	2E-5	8E-8	2E-4	2E-3
		Y, see <sup>88</sup> Nb	-	5E+4	2E-5	7E-8	-	-
42	Molybdenum-90	D, all compounds except those given for Y	4E+3	7E+3	3E-6	1E-8	3E-5	3E-4
		Y, oxides, hydroxides, and MoS	2E+3	5E+3	2E-6	6E-9	-	-
42	Molybdenum-93m	D, see <sup>90</sup> Mo	9E+3	2E+4	7E-6	2E-8	6E-5	6E-4
		Y, see <sup>90</sup> Mo	4E+3	1E+4	6E-6	2E-8	-	-
42	Molybdenum-93	D, see <sup>90</sup> Mo	4E+3	5E+3	2E-6	8E-9	5E-5	5E-4
		Y, see <sup>90</sup> Mo	2E+4	2E+2	8E-8	2E-10	-	-
42	Molybdenum-99	D, see <sup>90</sup> Mo	2E+3	3E+3	1E-6	4E-9	-	-
			LLI wall (1E+3)	-	-	-	2E-5	2E-4
		Y, see <sup>90</sup> Mo	1E+3	1E+3	6E-7	2E-9	-	-
42	Molybdenum-101 <sup>2</sup>	D, see <sup>90</sup> Mo	4E+4	1E+5	6E-5	2E-7	-	-
			St wall (5E+4)	-	-	-	7E-4	7E-3
		Y, see <sup>90</sup> Mo	-	1E+5	6E-5	2E-7	-	-
43	Technetium-93m <sup>2</sup>	D, all compounds except those given for W	7E+4	2E+5	6E-5	2E-7	1E-3	1E-2
		W, oxides, hydroxides, halides, and nitrates	-	3E+5	1E-4	4E-7	-	-
43	Technetium-93	D, see <sup>93m</sup> Tc	3E+4	7E+4	3E-5	1E-7	4E-4	4E-3
		W, see <sup>93m</sup> Tc	-	1E+5	4E-5	1E-7	-	-
43	Technetium-94m <sup>2</sup>	D, see <sup>93m</sup> Tc	2E+4	4E+4	2E-5	6E-8	3E-4	3E-3
		W, see <sup>93m</sup> Tc	-	6E+4	2E-5	8E-8	-	-
43	Technetium-94	D, see <sup>93m</sup> Tc	9E+3	2E+4	8E-6	3E-8	1E-4	1E-3
		W, see <sup>93m</sup> Tc	-	2E+4	1E-5	3E-8	-	-
43	Technetium-95m	D, see <sup>93m</sup> Tc	4E+3	5E+3	2E-6	8E-9	5E-5	5E-4
		W, see <sup>93m</sup> Tc	-	2E+3	8E-7	3E-9	-	-
43	Technetium-95	D, see <sup>93m</sup> Tc	1E+4	2E+4	9E-6	3E-8	1E-4	1E-3
		W, see <sup>93m</sup> Tc	-	2E+4	8E-6	3E-8	-	-
43	Technetium-96m <sup>2</sup>	D, see <sup>93m</sup> Tc	2E+5	3E+5	1E-4	4E-7	2E-3	2E-2
		W, see <sup>93m</sup> Tc	-	2E+5	1E-4	3E-7	-	-
43	Technetium-96	D, see <sup>93m</sup> Tc	2E+3	3E+3	1E-6	5E-9	3E-5	3E-4
		W, see <sup>93m</sup> Tc	-	2E+3	9E-7	3E-9	-	-
43	Technetium-97m	D, see <sup>93m</sup> Tc	5E+3	7E+3	3E-6	-	6E-5	6E-4
			-	St wall (7E+3)	-	1E-8	-	-
		W, see <sup>93m</sup> Tc	-	1E+3	5E-7	2E-9	-	-
43	Technetium-97	D, see <sup>93m</sup> Tc	4E+4	5E+4	2E-5	7E-8	5E-4	5E-3
		W, see <sup>93m</sup> Tc	-	6E+3	2E-6	8E-9	-	-
43	Technetium-98	D, see <sup>93m</sup> Tc	1E+3	2E+3	7E-7	2E-9	1E-5	1E-4
		W, see <sup>93m</sup> Tc	-	3E+2	1E-7	4E-10	-	-
43	Technetium-99m	D, see <sup>93m</sup> Tc	8E+4	2E+5	6E-5	2E-7	1E-3	1E-2
		W, see <sup>93m</sup> Tc	-	2E+5	1E-4	3E-7	-	-
43	Technetium-99	D, see <sup>93m</sup> Tc	4E+3	5E+3	2E-6	-	6E-5	6E-4
			-	St wall (6E+3)	-	8E-9	-	-
		W, see <sup>93m</sup> Tc	-	7E+2	3E-7	9E-10	-	-
43	Technetium-101 <sup>2</sup>	D, see <sup>93m</sup> Tc	9E+4	3E+5	1E-4	5E-7	-	-
			St wall (1E+5)	-	-	-	2E-3	2E-2
		W, see <sup>93m</sup> Tc	-	4E+5	2E-4	5E-7	-	-
43	Technetium-104 <sup>2</sup>	D, see <sup>93m</sup> Tc	2E+4	7E+4	3E-5	1E-7	-	-
			St wall (3E+4)	-	-	-	4E-4	4E-3
		W, see <sup>93m</sup> Tc	-	9E+4	4E-5	1E-7	-	-
44	Ruthenium-94 <sup>2</sup>	D, all compounds except those given for W and Y	2E+4	4E+4	2E-5	6E-8	2E-4	2E-3

		W, halides	-	6E+4	3E-5	9E-8	-	-
		Y, oxides and hydroxides	-	6E+4	2E-5	8E-8	-	-
44	Ruthenium-97	D, see <sup>94</sup> Ru	8E+3	2E+4	8E-6	3E-8	1E-4	1E-3
		W, see <sup>94</sup> Ru	-	1E+4	5E-6	2E-8	-	-
		Y, see <sup>94</sup> Ru	-	1E+4	5E-6	2E-8	-	-
44	Ruthenium-103	D, see <sup>94</sup> Ru	2E+3	2E+3	7E-7	2E-9	3E-5	3E-4
		W, see <sup>94</sup> Ru	-	1E+3	4E-7	1E-9	-	-
		Y, see <sup>94</sup> Ru	-	6E+2	3E-7	9E-10	-	-
44	Ruthenium-105	D, see <sup>94</sup> Ru	5E+3	1E+4	6E-6	2E-8	7E-5	7E-4
		W, see <sup>94</sup> Ru	-	1E+4	6E-6	2E-8	-	-
		Y, see <sup>94</sup> Ru	-	1E+4	5E-6	2E-8	-	-
44	Ruthenium-106	D, see <sup>94</sup> Ru	2E+2	9E+1	4E-8	1E-10	-	-
		LLI wall (2E+2)	-	-	-	-	3E-6	3E-5
		W, see <sup>94</sup> Ru	-	5E+1	2E-8	8E-11	-	-
		Y, see <sup>94</sup> Ru	-	1E+1	5E-9	2E-11	-	-
45	Rhodium-99m	D, all compounds except those given for W and Y	2E+4	6E+4	2E-5	8E-8	2E-4	2E-3
		W, halides	-	8E+4	3E-5	1E-7	-	-
		Y, oxides and hydroxides	-	7E+4	3E-5	9E-8	-	-
45	Rhodium-99	D, see <sup>99m</sup> Rh	2E+3	3E+3	1E-6	4E-9	3E-5	3E-4
		W, see <sup>99m</sup> Rh	-	2E+3	9E-7	3E-9	-	-
		Y, see <sup>99m</sup> Rh	-	2E+3	8E-7	3E-9	-	-
45	Rhodium-100	D, see <sup>99m</sup> Rh	2E+3	5E+3	2E-6	7E-9	2E-5	2E-4
		W, see <sup>99m</sup> Rh	-	4E+3	2E-6	6E-9	-	-
		Y, see <sup>99m</sup> Rh	-	4E+3	2E-6	5E-9	-	-
45	Rhodium-101m	D, see <sup>99m</sup> Rh	6E+3	1E+4	5E-6	2E-8	8E-5	8E-4
		W, see <sup>99m</sup> Rh	-	8E+3	4E-6	1E-8	-	-
		Y, see <sup>99m</sup> Rh	-	8E+3	3E-6	1E-8	-	-
45	Rhodium-101	D, see <sup>99m</sup> Rh	2E+3	5E+2	2E-7	7E-10	3E-5	3E-4
		W, see <sup>99m</sup> Rh	-	8E+2	3E-7	1E-9	-	-
		Y, see <sup>99m</sup> Rh	-	2E+2	6E-8	2E-10	-	-
45	Rhodium-102m	D, see <sup>99m</sup> Rh	1E+3	5E+2	2E-7	7E-10	-	-
		LLI wall (1E+3)	-	-	-	-	2E-5	2E-4
		W, see <sup>99m</sup> Rh	-	4E+2	2E-7	5E-10	-	-
		Y, see <sup>99m</sup> Rh	-	1E+2	5E-8	2E-10	-	-
45	Rhodium-102	D, see <sup>99m</sup> Rh	6E+2	9E+1	4E-8	1E-10	8E-6	8E-5
		W, see <sup>99m</sup> Rh	-	2E+2	7E-8	2E-10	-	-
		Y, see <sup>99m</sup> Rh	-	6E+1	2E-8	8E-11	-	-
45	Rhodium-103m <sup>2</sup>	D, see <sup>99m</sup> Rh	4E+5	1E+6	5E-4	2E-6	6E-3	6E-2
		W, see <sup>99m</sup> Rh	-	1E+6	5E-4	2E-6	-	-
		Y, see <sup>99m</sup> Rh	-	1E+6	5E-4	2E-6	-	-
45	Rhodium-105	D, see <sup>99m</sup> Rh	4E+3	1E+4	5E-6	2E-8	-	-
		LLI wall (4E+3)	-	-	-	-	5E-5	5E-4
		W, see <sup>99m</sup> Rh	-	6E+3	3E-6	9E-9	-	-
		Y, see <sup>99m</sup> Rh	-	6E+3	2E-6	8E-9	-	-
45	Rhodium-106m	D, see <sup>99m</sup> Rh	8E+3	3E+4	1E-5	4E-8	1E-4	1E-3
		W, see <sup>99m</sup> Rh	-	4E+4	2E-5	5E-8	-	-
		Y, see <sup>99m</sup> Rh	-	4E+4	1E-5	5E-8	-	-
45	Rhodium-107 <sup>2</sup>	D, see <sup>99m</sup> Rh	7E+4	2E+5	1E-4	3E-7	-	-
		St wall (9E+4)	-	-	-	-	1E-3	1E-2
		W, see <sup>99m</sup> Rh	-	3E+5	1E-4	4E-7	-	-
		Y, see <sup>99m</sup> Rh	-	3E+5	1E-4	3E-7	-	-
46	Palladium-100	D, all compounds except those given for W and Y	1E+3	1E+3	6E-7	2E-9	2E-5	2E-4
		W, nitrates	-	1E+3	5E-7	2E-9	-	-
		Y, oxides and hydroxides	-	1E+3	6E-7	2E-9	-	-
46	Palladium-101	D, see <sup>100</sup> Pd	1E+4	3E+4	1E-5	5E-8	2E-4	2E-3
		W, see <sup>100</sup> Pd	-	3E+4	1E-5	5E-8	-	-
		Y, see <sup>100</sup> Pd	-	3E+4	1E-5	4E-8	-	-
46	Palladium-103	D, see <sup>100</sup> Pd	6E+3	6E+3	3E-6	9E-9	-	-
		LLI wall (7E+3)	-	-	-	-	1E-4	1E-3

Radiation Protection Standards

246-221-290

		W, see <sup>100</sup> Pd	-	4E+3	2E-6	6E-9	-	-
		Y, see <sup>100</sup> Pd	-	4E+3	1E-6	5E-9	-	-
46	Palladium-107	D, see <sup>100</sup> Pd	3E+4	2E+4	9E-6	-	-	-
			LLI wall (4E+4)	Kidneys (2E+4)	-	3E-8	5E-4	5E-3
		W, see <sup>100</sup> Pd	-	7E+3	3E-6	1E-8	-	-
		Y, see <sup>100</sup> Pd	-	4E+2	2E-7	6E-10	-	-
46	Palladium-109	D, see <sup>100</sup> Pd	2E+3	6E+3	3E-6	9E-9	3E-5	3E-4
		W, see <sup>100</sup> Pd	-	5E+3	2E-6	8E-9	-	-
		Y, see <sup>100</sup> Pd	-	5E+3	2E-6	6E-9	-	-
47	Silver-102 <sup>2</sup>	D, all compounds except those given for W and Y	5E+4	2E+5	8E-5	2E-7	-	-
			St wall (6E+4)	-	-	-	9E-4	9E-3
		W, nitrates and sulfides	-	2E+5	9E-5	3E-7	-	-
		Y, oxides and hydroxides	-	2E+5	8E-5	3E-7	-	-
47	Silver-103 <sup>2</sup>	D, see <sup>102</sup> Ag	4E+4	1E+5	4E-5	1E-7	5E-4	5E-3
		W, see <sup>102</sup> Ag	-	1E+5	5E-5	2E-7	-	-
		Y, see <sup>102</sup> Ag	-	1E+5	5E-5	2E-7	-	-
47	Silver-104m <sup>2</sup>	D, see <sup>102</sup> Ag	3E+4	9E+4	4E-5	1E-7	4E-4	4E-3
		W, see <sup>102</sup> Ag	-	1E+5	5E-5	2E-7	-	-
		Y, see <sup>102</sup> Ag	-	1E+5	5E-5	2E-7	-	-
47	Silver-104 <sup>2</sup>	D, see <sup>102</sup> Ag	2E+4	7E+4	3E-5	1E-7	3E-4	3E-3
		W, see <sup>102</sup> Ag	-	1E+5	6E-5	2E-7	-	-
		Y, see <sup>102</sup> Ag	-	1E+5	6E-5	2E-7	-	-
47	Silver-105	D, see <sup>102</sup> Ag	3E+3	1E+3	4E-7	1E-9	4E-5	4E-4
		W, see <sup>102</sup> Ag	-	2E+3	7E-7	2E-9	-	-
		Y, see <sup>102</sup> Ag	-	2E+3	7E-7	2E-9	-	-
47	Silver-106m	D, see <sup>102</sup> Ag	8E+2	7E+2	3E-7	1E-9	1E-5	1E-4
		W, see <sup>102</sup> Ag	-	9E+2	4E-7	1E-9	-	-
		Y, see <sup>102</sup> Ag	-	9E+2	4E-7	1E-9	-	-
47	Silver-106 <sup>2</sup>	D, see <sup>102</sup> Ag	6E+4	2E+5	8E-5	3E-7	-	-
			St. wall (6E+4)	-	-	-	9E-4	9E-3
		W, see <sup>102</sup> Ag	-	2E+5	9E-5	3E-7	-	-
		Y, see <sup>102</sup> Ag	-	2E+5	8E-5	3E-7	-	-
47	Silver-108m	D, see <sup>102</sup> Ag	6E+2	2E+2	8E-8	3E-10	9E-6	9E-5
		W, see <sup>102</sup> Ag	-	3E+2	1E-7	4E-10	-	-
		Y, see <sup>102</sup> Ag	-	2E+1	1E-8	3E-11	-	-
47	Silver-110m	D, see <sup>102</sup> Ag	5E+2	1E+2	5E-8	2E-10	6E-6	6E-5
		W, see <sup>102</sup> Ag	-	2E+2	8E-8	3E-10	-	-
		Y, see <sup>102</sup> Ag	-	9E+1	4E-8	1E-10	-	-
47	Silver-111	D, see <sup>102</sup> Ag	9E+2	2E+3	6E-7	-	-	-
			LLI wall (1E+3)	Liver (2E+3)	-	2E-9	2E-5	2E-4
		W, see <sup>102</sup> Ag	-	9E+2	4E-7	1E-9	-	-
		Y, see <sup>102</sup> Ag	-	9E+2	4E-7	1E-9	-	-
47	Silver-112	D, see <sup>102</sup> Ag	3E+3	8E+3	3E-6	1E-8	4E-5	4E-4
		W, see <sup>102</sup> Ag	-	1E+4	4E-6	1E-8	-	-
		Y, see <sup>102</sup> Ag	-	9E+3	4E-6	1E-8	-	-
47	Silver-115 <sup>2</sup>	D, see <sup>102</sup> Ag	3E+4	9E+4	4E-5	1E-7	-	-
			St wall (3E+4)	-	-	-	4E-4	4E-3
		W, see <sup>102</sup> Ag	-	9E+4	4E-5	1E-7	-	-
		Y, see <sup>102</sup> Ag	-	8E+4	3E-5	1E-7	-	-
48	Cadmium-104 <sup>2</sup>	D, all compounds except those given for W and Y	2E+4	7E+4	3E-5	9E-8	3E-4	3E-3
		W, sulfides, halides, and nitrates	-	1E+5	5E-5	2E-7	-	-
		Y, oxides and hydroxides	-	1E+5	5E-5	2E-7	-	-
48	Cadmium-107	D, see <sup>104</sup> Cd	2E+4	5E+4	2E-5	8E-8	3E-4	3E-3
		W, see <sup>104</sup> Cd	-	6E+4	2E-5	8E-8	-	-
		Y, see <sup>104</sup> Cd	-	5E+4	2E-5	7E-8	-	-
48	Cadmium-109	D, see <sup>104</sup> Cd	3E+2	4E+1	1E-8	-	-	-
			Kidneys (4E+2)	Kidneys (5E+1)	-	7E-11	6E-6	6E-5

		W, see $^{104}\text{Cd}$	-	1E+2 Kidneys	5E-8	-	-	-
		Y, see $^{104}\text{Cd}$	-	(1E+2)	-	2E-10	-	-
48	Cadmium-113m	D, see $^{104}\text{Cd}$	2E+1 Kidneys (4E+1)	2E+0 Kidneys (4E+0)	1E-9	-	-	-
		W, see $^{104}\text{Cd}$	-	8E+0 Kidneys (1E+1)	4E-9	-	5E-12	5E-7 5E-6
		Y, see $^{104}\text{Cd}$	-	1E+1	5E-9	2E-11	-	-
48	Cadmium-113	D, see $^{104}\text{Cd}$	2E+1 Kidneys (3E+1)	2E+0 Kidneys (3E+0)	9E-10	-	-	-
		W, see $^{104}\text{Cd}$	-	8E+0 Kidneys (1E+1)	3E-9	-	5E-12	4E-7 4E-6
		Y, see $^{104}\text{Cd}$	-	1E+1	6E-9	2E-11	-	-
48	Cadmium-115m	D, see $^{104}\text{Cd}$	3E+2	5E+1 Kidneys (8E+1)	2E-8	-	4E-6	4E-5
		W, see $^{104}\text{Cd}$	-	1E+2	5E-8	2E-10	-	-
		Y, see $^{104}\text{Cd}$	-	1E+2	6E-8	2E-10	-	-
48	Cadmium-115	D, see $^{104}\text{Cd}$	9E+2 LLI wall (1E+3)	1E+3	6E-7	2E-9	-	-
		W, see $^{104}\text{Cd}$	-	1E+3	5E-7	2E-9	-	1E-5 1E-4
		Y, see $^{104}\text{Cd}$	-	1E+3	6E-7	2E-9	-	-
48	Cadmium-117m	D, see $^{104}\text{Cd}$	5E+3	1E+4	5E-6	2E-8	6E-5	6E-4
		W, see $^{104}\text{Cd}$	-	2E+4	7E-6	2E-8	-	-
		Y, see $^{104}\text{Cd}$	-	1E+4	6E-6	2E-8	-	-
48	Cadmium-117	D, see $^{104}\text{Cd}$	5E+3	1E+4	5E-6	2E-8	6E-5	6E-4
		W, see $^{104}\text{Cd}$	-	2E+4	7E-6	2E-8	-	-
		Y, see $^{104}\text{Cd}$	-	1E+4	6E-6	2E-8	-	-
49	Indium-109	D, all compounds except those given for W	2E+4	4E+4	2E-5	6E-8	3E-4	3E-3
		W, oxides, hydroxides, halides, and nitrates	-	6E+4	3E-5	9E-8	-	-
49	Indium-110 <sup>2</sup> (69.1 min)	D, see $^{109}\text{In}$	2E+4	4E+4	2E-5	6E-8	2E-4	2E-3
		W, see $^{109}\text{In}$	-	6E+4	2E-5	8E-8	-	-
49	Indium-110 (4.9 h)	D, see $^{109}\text{In}$	5E+3	2E+4	7E-6	2E-8	7E-5	7E-4
		W, see $^{109}\text{In}$	-	2E+4	8E-6	3E-8	-	-
49	Indium-111	D, see $^{109}\text{In}$	4E+3	6E+3	3E-6	9E-9	6E-5	6E-4
		W, see $^{109}\text{In}$	-	6E+3	3E-6	9E-9	-	-
49	Indium-112 <sup>2</sup>	D, see $^{109}\text{In}$	2E+5	6E+5	3E-4	9E-7	2E-3	2E-2
		W, see $^{109}\text{In}$	-	7E+5	3E-4	1E-6	-	-
49	Indium-113m <sup>2</sup>	D, see $^{109}\text{In}$	5E+4	1E+5	6E-5	2E-7	7E-4	7E-3
		W, see $^{109}\text{In}$	-	2E+5	8E-5	3E-7	-	-
49	Indium-114m	D, see $^{109}\text{In}$	3E+2 LLI wall (4E+2)	6E+1	3E-8	9E-11	-	-
		W, see $^{109}\text{In}$	-	1E+2	4E-8	1E-10	5E-6	5E-5
49	Indium-115m	D, see $^{109}\text{In}$	1E+4	4E+4	2E-5	6E-8	2E-4	2E-3
		W, see $^{109}\text{In}$	-	5E+4	2E-5	7E-8	-	-
49	Indium-115	D, see $^{109}\text{In}$	4E+1	1E+0	6E-10	2E-12	5E-7	5E-6
		W, see $^{109}\text{In}$	-	5E+0	2E-9	8E-12	-	-
49	Indium-116m <sup>2</sup>	D, see $^{109}\text{In}$	2E+4	8E+4	3E-5	1E-7	3E-4	3E-3
		W, see $^{109}\text{In}$	-	1E+5	5E-5	2E-7	-	-
49	Indium-117m <sup>2</sup>	D, see $^{109}\text{In}$	1E+4	3E+4	1E-5	5E-8	2E-4	2E-3
		W, see $^{109}\text{In}$	-	4E+4	2E-5	6E-8	-	-
49	Indium-117 <sup>2</sup>	D, see $^{109}\text{In}$	6E+4	2E+5	7E-5	2E-7	8E-4	8E-3
		W, see $^{109}\text{In}$	-	2E+5	9E-5	3E-7	-	-
49	Indium-119m <sup>2</sup>	D, see $^{109}\text{In}$	4E+4 St wall (5E+4)	1E+5	5E-5	2E-7	-	-
			-	-	-	-	7E-4	7E-3

Radiation Protection Standards

246-221-290

		W, see $^{109}\text{In}$	-	1E+5	6E-5	2E-7	-	-
50	Tin-110	D, all compounds except those given for W W, sulfides, oxides, hydroxides, halides, nitrates, and stannic phosphate	4E+3	1E+4	5E-6	2E-8	5E-5	5E-4
50	Tin-111 <sup>2</sup>	D, see $^{110}\text{Sn}$ W, see $^{110}\text{Sn}$	7E+4	2E+5	9E-5	3E-7	1E-3	1E-2
50	Tin-113	D, see $^{110}\text{Sn}$	2E+3	1E+3	5E-7	2E-9	-	-
			LLI wall (2E+3)	-	-	-	3E-5	3E-4
50	Tin-117m	W, see $^{110}\text{Sn}$ D, see $^{110}\text{Sn}$	2E+3	1E+3	5E-7	-	-	-
			LLI wall (2E+3)	Bone surf (2E+3)	-	3E-9	3E-5	3E-4
50	Tin-119m	W, see $^{110}\text{Sn}$ D, see $^{110}\text{Sn}$	-	1E+3	6E-7	2E-9	-	-
			3E+3	2E+3	1E-6	3E-9	-	-
			LLI wall (4E+3)	-	-	-	6E-5	6E-4
50	Tin-121m	W, see $^{110}\text{Sn}$ D, see $^{110}\text{Sn}$	-	1E+3	4E-7	1E-9	-	-
			3E+3	9E+2	4E-7	1E-9	-	-
			LLI wall (4E+3)	-	-	-	5E-5	5E-4
50	Tin-121	W, see $^{110}\text{Sn}$ D, see $^{110}\text{Sn}$	-	5E+2	2E-7	8E-10	-	-
			6E+3	2E+4	6E-6	2E-8	-	-
			LLI wall (6E+3)	-	-	-	8E-5	8E-4
50	Tin-123m <sup>2</sup>	W, see $^{110}\text{Sn}$ D, see $^{110}\text{Sn}$ W, see $^{110}\text{Sn}$	-	1E+4	5E-6	2E-8	-	-
			5E+4	1E+5	5E-5	2E-7	7E-4	7E-3
			-	1E+5	6E-5	2E-7	-	-
50	Tin-123	D, see $^{110}\text{Sn}$	5E+2	6E+2	3E-7	9E-10	-	-
			LLI wall (6E+2)	-	-	-	9E-6	9E-5
50	Tin-125	W, see $^{110}\text{Sn}$ D, see $^{110}\text{Sn}$	-	2E+2	7E-8	2E-10	-	-
			4E+2	9E+2	4E-7	1E-9	-	-
			LLI wall (5E+2)	-	-	-	6E-6	6E-5
50	Tin-126	W, see $^{110}\text{Sn}$ D, see $^{110}\text{Sn}$ W, see $^{110}\text{Sn}$	-	4E+2	1E-7	5E-10	-	-
			3E+2	6E+1	2E-8	8E-11	4E-6	4E-5
			-	7E+1	3E-8	9E-11	-	-
50	Tin-127	D, see $^{110}\text{Sn}$ W, see $^{110}\text{Sn}$	7E+3	2E+4	8E-6	3E-8	9E-5	9E-4
			-	2E+4	8E-6	3E-8	-	-
50	Tin-128 <sup>2</sup>	D, see $^{110}\text{Sn}$ W, see $^{110}\text{Sn}$	9E+3	3E+4	1E-5	4E-8	1E-4	1E-3
			-	4E+4	1E-5	5E-8	-	-
51	Antimony-115 <sup>2</sup>	D, all compounds except those given for W W, oxides, hydroxides, halides, sulfides, sulfates, and nitrates	8E+4	2E+5	1E-4	3E-7	1E-3	1E-2
			-	3E+5	1E-4	4E-7	-	-
51	Antimony-116m <sup>2</sup>	D, see $^{115}\text{Sb}$ W, see $^{115}\text{Sb}$	2E+4	7E+4	3E-5	1E-7	3E-4	3E-3
			-	1E+5	6E-5	2E-7	-	-
51	Antimony-116 <sup>2</sup>	D, see $^{115}\text{Sb}$	7E+4	3E+5	1E-4	4E-7	-	-
			St wall (9E+4)	-	-	-	1E-3	1E-2
		W, see $^{115}\text{Sb}$	-	3E+5	1E-4	5E-7	-	-
51	Antimony-117	D, see $^{115}\text{Sb}$ W, see $^{115}\text{Sb}$	7E+4	2E+5	9E-5	3E-7	9E-4	9E-3
			-	3E+5	1E-4	4E-7	-	-
51	Antimony-118m	D, see $^{115}\text{Sb}$ W, see $^{115}\text{Sb}$	6E+3	2E+4	8E-6	3E-8	7E-5	7E-4
			5E+3	2E+4	9E-6	3E-8	-	-
51	Antimony-119	D, see $^{115}\text{Sb}$ W, see $^{115}\text{Sb}$	2E+4	5E+4	2E-5	6E-8	2E-4	2E-3
			2E+4	3E+4	1E-5	4E-8	-	-



51	Antimony-120 <sup>2</sup> (16 min)	D, see <sup>115</sup> Sb	1E+5 St wall (2E+5)	4E+5	2E-4	6E-7	-	-
		W, see <sup>115</sup> Sb	-	5E+5	2E-4	7E-7	2E-3	2E-2
51	Antimony-120 (5.76 d)	D, see <sup>115</sup> Sb	1E+3	2E+3	9E-7	3E-9	1E-5	1E-4
		W, see <sup>115</sup> Sb	9E+2	1E+3	5E-7	2E-9	-	-
51	Antimony-122	D, see <sup>115</sup> Sb	8E+2 LLI wall (8E+2)	2E+3	1E-6	3E-9	-	-
		W, see <sup>115</sup> Sb	7E+2	1E+3	4E-7	2E-9	1E-5	1E-4
51	Antimony-124m <sup>2</sup>	D, see <sup>115</sup> Sb	3E+5	8E+5	4E-4	1E-6	3E-3	3E-2
		W, see <sup>115</sup> Sb	2E+5	6E+5	2E-4	8E-7	-	-
51	Antimony-124	D, see <sup>115</sup> Sb	6E+2	9E+2	4E-7	1E-9	7E-6	7E-5
		W, see <sup>115</sup> Sb	5E+2	2E+2	1E-7	3E-10	-	-
51	Antimony-125	D, see <sup>115</sup> Sb	2E+3	2E+3	1E-6	3E-9	3E-5	3E-4
		W, see <sup>115</sup> Sb	-	5E+2	2E-7	7E-10	-	-
51	Antimony-126m <sup>2</sup>	D, see <sup>115</sup> Sb	5E+4 St wall (7E+4)	2E+5	8E-5	3E-7	-	-
		W, see <sup>115</sup> Sb	-	2E+5	8E-5	3E-7	9E-4	9E-3
51	Antimony-126	D, see <sup>115</sup> Sb	6E+2	1E+3	5E-7	2E-9	7E-6	7E-5
		W, see <sup>115</sup> Sb	5E+2	5E+2	2E-7	7E-10	-	-
51	Antimony-127	D, see <sup>115</sup> Sb	8E+2 LLI wall (8E+2)	2E+3	9E-7	3E-9	-	-
		W, see <sup>115</sup> Sb	7E+2	9E+2	4E-7	1E-9	1E-5	1E-4
51	Antimony-128 <sup>2</sup> (10.4 min)	D, see <sup>115</sup> Sb	8E+4 St wall (1E+5)	4E+5	2E-4	5E-7	-	-
		W, see <sup>115</sup> Sb	-	4E+5	2E-4	6E-7	1E-3	1E-2
51	Antimony-128 (9.01 h)	D, see <sup>115</sup> Sb	1E+3	4E+3	2E-6	6E-9	2E-5	2E-4
		W, see <sup>115</sup> Sb	-	3E+3	1E-6	5E-9	-	-
51	Antimony-129	D, see <sup>115</sup> Sb	3E+3	9E+3	4E-6	1E-8	4E-5	4E-4
		W, see <sup>115</sup> Sb	-	9E+3	4E-6	1E-8	-	-
51	Antimony-130 <sup>2</sup>	D, see <sup>115</sup> Sb	2E+4	6E+4	3E-5	9E-8	3E-4	3E-3
		W, see <sup>115</sup> Sb	-	8E+4	3E-5	1E-7	-	-
51	Antimony-131 <sup>2</sup>	D, see <sup>115</sup> Sb	1E+4 Thyroid (2E+4)	2E+4 Thyroid (4E+4)	1E-5	-	6E-8	2E-4
		W, see <sup>115</sup> Sb	-	2E+4 Thyroid (4E+4)	1E-5	6E-8	-	2E-3
52	Tellurium-116	D, all compounds except those given for W	8E+3	2E+4	9E-6	3E-8	1E-4	1E-3
		W, oxides, hydroxides, and nitrates	-	3E+4	1E-5	4E-8	-	-
52	Tellurium-121m	D, see <sup>116</sup> Te	5E+2 Bone surf (7E+2)	2E+2 Bone surf (4E+2)	8E-8	-	5E-10	1E-5
		W, see <sup>116</sup> Te	-	4E+2	2E-7	6E-10	-	1E-4
52	Tellurium-121	D, see <sup>116</sup> Te	3E+3	4E+3	2E-6	6E-9	4E-5	4E-4
		W, see <sup>116</sup> Te	-	3E+3	1E-6	4E-9	-	-
52	Tellurium-123m	D, see <sup>116</sup> Te	6E+2 Bone surf (1E+3)	2E+2 Bone surf (5E+2)	9E-8	-	8E-10	1E-5
		W, see <sup>116</sup> Te	-	5E+2	2E-7	8E-10	-	1E-4
52	Tellurium-123	D, see <sup>116</sup> Te	5E+2 Bone surf (1E+3)	2E+2 Bone surf (5E+2)	8E-8	-	7E-10	2E-5
		W, see <sup>116</sup> Te	-	4E+2 Bone surf (1E+3)	2E-7	2E-9	-	2E-4
52	Tellurium-125m	D, see <sup>116</sup> Te	1E+3 Bone surf (1E+3)	4E+2 Bone surf (1E+3)	2E-7	-	1E-9	2E-4

Radiation Protection Standards

246-221-290

		W, see <sup>116</sup> Te	-	7E+2	3E-7	1E-9	-	-
52	Tellurium-127m	D, see <sup>116</sup> Te	6E+2	3E+2	1E-7	-	9E-6	9E-5
				Bone surf (4E+2)	-	6E-10	-	-
		W, see <sup>116</sup> Te	-	3E+2	1E-7	4E-10	-	-
52	Tellurium-127	D, see <sup>116</sup> Te	7E+3	2E+4	9E-6	3E-8	1E-4	1E-3
		W, see <sup>116</sup> Te	-	2E+4	7E-6	2E-8	-	-
52	Tellurium-129m	D, see <sup>116</sup> Te	5E+2	6E+2	3E-7	9E-10	7E-6	7E-5
		W, see <sup>116</sup> Te	-	2E+2	1E-7	3E-10	-	-
52	Tellurium-129 <sup>2</sup>	D, see <sup>116</sup> Te	3E+4	6E+4	3E-5	9E-8	4E-4	4E-3
		W, see <sup>116</sup> Te	-	7E+4	3E-5	1E-7	-	-
52	Tellurium-131m	D, see <sup>116</sup> Te	3E+2	4E+2	2E-7	-	-	-
			Thyroid (6E+2)	Thyroid (1E+3)	-	2E-9	8E-6	8E-5
		W, see <sup>116</sup> Te	-	4E+2	2E-7	-	-	-
			-	Thyroid (9E+2)	-	1E-9	-	-
52	Tellurium-131 <sup>2</sup>	D, see <sup>116</sup> Te	3E+3	5E+3	2E-6	-	-	-
			Thyroid (6E+3)	Thyroid (1E+4)	-	2E-8	8E-5	8E-4
		W, see <sup>116</sup> Te	-	5E+3	2E-6	-	-	-
			-	Thyroid (1E+4)	-	2E-8	-	-
52	Tellurium-132	D, see <sup>116</sup> Te	2E+2	2E+2	9E-8	-	-	-
			Thyroid (7E+2)	Thyroid (8E+2)	-	1E-9	9E-6	9E-5
		W, see <sup>116</sup> Te	-	2E+2	9E-8	-	-	-
			-	Thyroid (6E+2)	-	9E-10	-	-
52	Tellurium-133m <sup>2</sup>	D, see <sup>116</sup> Te	3E+3	5E+3	2E-6	-	-	-
			Thyroid (6E+3)	Thyroid (1E+4)	-	2E-8	9E-5	9E-4
		W, see <sup>116</sup> Te	-	5E+3	2E-6	-	-	-
			-	Thyroid (1E+4)	-	2E-8	-	-
52	Tellurium-133 <sup>2</sup>	D, see <sup>116</sup> Te	1E+4	2E+4	9E-6	-	-	-
			Thyroid (3E+4)	Thyroid (6E+4)	-	8E-8	4E-4	4E-3
		W, see <sup>116</sup> Te	-	2E+4	9E-6	-	-	-
			-	Thyroid (6E+4)	-	8E-8	-	-
52	Tellurium-134 <sup>2</sup>	D, see <sup>116</sup> Te	2E+4	2E+4	1E-5	-	-	-
			Thyroid (2E+4)	Thyroid (5E+4)	-	7E-8	3E-4	3E-3
		W, see <sup>116</sup> Te	-	2E+4	1E-5	-	-	-
			-	Thyroid (5E+4)	-	7E-8	-	-
53	Iodine-120m <sup>2</sup>	D, all compounds	1E+4	2E+4	9E-6	3E-8	-	-
			Thyroid (1E+4)	-	-	-	2E-4	2E-3
53	Iodine-120 <sup>2</sup>	D, all compounds	4E+3	9E+3	4E-6	-	-	-
			Thyroid (8E+3)	Thyroid (1E+4)	-	2E-8	1E-4	1E-3
53	Iodine-121	D, all compounds	1E+4	2E+4	8E-6	-	-	-
			Thyroid (3E+4)	Thyroid (5E+4)	-	7E-8	4E-4	4E-3
53	Iodine-123	D, all compounds	3E+3	6E+3	3E-6	-	-	-
			Thyroid (1E+4)	Thyroid (2E+4)	-	2E-8	1E-4	1E-3
53	Iodine-124	D, all compounds	5E+1	8E+1	3E-8	-	-	-
			Thyroid (2E+2)	Thyroid (3E+2)	-	4E-10	2E-6	2E-5
53	Iodine-125	D, all compounds	4E+1	6E+1	3E-8	-	-	-
			Thyroid (1E+2)	Thyroid (2E+2)	-	3E-10	2E-6	2E-5
53	Iodine-126	D, all compounds	2E+1	4E+1	1E-8	-	-	-

			Thyroid (7E+1)	Thyroid (1E+2)	-	2E-10	1E-6	1E-5
53	Iodine-128 <sup>2</sup>	D, all compounds	4E+4 St wall (6E+4)	1E+5	5E-5	2E-7	-	-
				-	-	-	8E-4	8E-3
53	Iodine-129	D, all compounds	5E+0 Thyroid (2E+1)	9E+0 Thyroid (3E+1)	4E-9	-	-	-
				-	-	4E-11	2E-7	2E-6
53	Iodine-130	D, all compounds	4E+2 Thyroid (1E+3)	7E+2 Thyroid (2E+3)	3E-7	-	-	-
				-	-	3E-9	2E-5	2E-4
53	Iodine-131	D, all compounds	3E+1 Thyroid (9E+1)	5E+1 Thyroid (2E+2)	2E-8	-	-	-
				-	-	2E-10	1E-6	1E-5
53	Iodine-132m <sup>2</sup>	D, all compounds	4E+3 Thyroid (1E+4)	8E+3 Thyroid (2E+4)	4E-6	-	-	-
				-	-	3E-8	1E-4	1E-3
53	Iodine-132	D, all compounds	4E+3 Thyroid (9E+3)	8E+3 Thyroid (1E+4)	3E-6	-	-	-
				-	-	2E-8	1E-4	1E-3
53	Iodine-133	D, all compounds	1E+2 Thyroid (5E+2)	3E+2 Thyroid (9E+2)	1E-7	-	-	-
				-	-	1E-9	7E-6	7E-5
53	Iodine-134 <sup>2</sup>	D, all compounds	2E+4 Thyroid (3E+4)	5E+4	2E-5	6E-8	-	-
				-	-	-	4E-4	4E-3
53	Iodine-135	D, all compounds	8E+2 Thyroid (3E+3)	2E+3 Thyroid (4E+3)	7E-7	-	-	-
				-	-	6E-9	3E-5	3E-4
54	Xenon-120 <sup>2</sup>	Submersion <sup>1</sup>	-	-	1E-5	4E-8	-	-
54	Xenon-121 <sup>2</sup>	Submersion <sup>1</sup>	-	-	2E-6	1E-8	-	-
54	Xenon-122	Submersion <sup>1</sup>	-	-	7E-5	3E-7	-	-
54	Xenon-123	Submersion <sup>1</sup>	-	-	6E-6	3E-8	-	-
54	Xenon-125	Submersion <sup>1</sup>	-	-	2E-5	7E-8	-	-
54	Xenon-127	Submersion <sup>1</sup>	-	-	1E-5	6E-8	-	-
54	Xenon-129m	Submersion <sup>1</sup>	-	-	2E-4	9E-7	-	-
54	Xenon-131m	Submersion <sup>1</sup>	-	-	4E-4	2E-6	-	-
54	Xenon-133m	Submersion <sup>1</sup>	-	-	1E-4	6E-7	-	-
54	Xenon-133	Submersion <sup>1</sup>	-	-	1E-4	5E-7	-	-
54	Xenon-135m <sup>2</sup>	Submersion <sup>1</sup>	-	-	9E-6	4E-8	-	-
54	Xenon-135	Submersion <sup>1</sup>	-	-	1E-5	7E-8	-	-
54	Xenon-138 <sup>2</sup>	Submersion <sup>1</sup>	-	-	4E-6	2E-8	-	-
55	Cesium-125 <sup>2</sup>	D, all compounds	5E+4 St wall (9E+4)	1E+5	6E-5	2E-7	-	-
				-	-	-	1E-3	1E-2
55	Cesium-127	D, all compounds	6E+4	9E+4	4E-5	1E-7	9E-4	9E-3
55	Cesium-129	D, all compounds	2E+4	3E+4	1E-5	5E-8	3E-4	3E-3
55	Cesium-130 <sup>2</sup>	D, all compounds	6E+4 St wall (1E+5)	2E+5	8E-5	3E-7	-	-
				-	-	-	1E-3	1E-2
55	Cesium-131	D, all compounds	2E+4	3E+4	1E-5	4E-8	3E-4	3E-3
55	Cesium-132	D, all compounds	3E+3	4E+3	2E-6	6E-9	4E-5	4E-4
55	Cesium-134m	D, all compounds	1E+5 St wall (1E+5)	1E+5	6E-5	2E-7	-	-
				-	-	-	2E-3	2E-2
55	Cesium-134	D, all compounds	7E+1	1E+2	4E-8	2E-10	9E-7	9E-6
55	Cesium-135m <sup>2</sup>	D, all compounds	1E+5	2E+5	8E-5	3E-7	1E-3	1E-2
55	Cesium-135	D, all compounds	7E+2	1E+3	5E-7	2E-9	1E-5	1E-4

## Radiation Protection Standards

246-221-290

55	Cesium-136	D, all compounds	4E+2	7E+2	3E-7	9E-10	6E-6	6E-5
55	Cesium-137	D, all compounds	1E+2	2E+2	6E-8	2E-10	1E-6	1E-5
55	Cesium-138 <sup>2</sup>	D, all compounds	2E+4	6E+4	2E-5	8E-8	-	-
			St wall (3E+4)	-	-	-	4E-4	4E-3
56	Barium-126 <sup>2</sup>	D, all compounds	6E+3	2E+4	6E-6	2E-8	8E-5	8E-4
56	Barium-128	D, all compounds	5E+2	2E+3	7E-7	2E-9	7E-6	7E-5
56	Barium-131m <sup>2</sup>	D, all compounds	4E+5	1E+6	6E-4	2E-6	-	-
			St wall (5E+5)	-	-	-	7E-3	7E-2
56	Barium-131	D, all compounds	3E+3	8E+3	3E-6	1E-8	4E-5	4E-4
56	Barium-133m	D, all compounds	2E+3	9E+3	4E-6	1E-8	-	-
			LLI wall (3E+3)	-	-	-	4E-5	4E-4
56	Barium-133	D, all compounds	2E+3	7E+2	3E-7	9E-10	2E-5	2E-4
56	Barium-135m	D, all compounds	3E+3	1E+4	5E-6	2E-8	4E-5	4E-4
56	Barium-139 <sup>2</sup>	D, all compounds	1E+4	3E+4	1E-5	4E-8	2E-4	2E-3
56	Barium-140	D, all compounds	5E+2	1E+3	6E-7	2E-9	-	-
			LLI wall (6E+2)	-	-	-	8E-6	8E-5
56	Barium-141 <sup>2</sup>	D, all compounds	2E+4	7E+4	3E-5	1E-7	3E-4	3E-3
56	Barium-142 <sup>2</sup>	D, all compounds	5E+4	1E+5	6E-5	2E-7	7E-4	7E-3
57	Lanthanum-131 <sup>2</sup>	D, all compounds except those given for W	5E+4	1E+5	5E-5	2E-7	6E-4	6E-3
		W, oxides and hydroxides	-	2E+5	7E-5	2E-7	-	-
57	Lanthanum-132	D, see <sup>131</sup> La W, see <sup>131</sup> La	3E+3	1E+4	4E-6	1E-8	4E-5	4E-4
			-	1E+4	5E-6	2E-8	-	-
57	Lanthanum-135	D, see <sup>131</sup> La W, see <sup>131</sup> La	4E+4	1E+5	4E-5	1E-7	5E-4	5E-3
			-	9E+4	4E-5	1E-7	-	-
57	Lanthanum-137	D, see <sup>131</sup> La	1E+4	6E+1	3E-8	-	2E-4	2E-3
			-	Liver (7E+1)	-	1E-10	-	-
		W, see <sup>131</sup> La	-	3E+2	1E-7	-	-	-
			-	Liver (3E+2)	-	4E-10	-	-
57	Lanthanum-138	D, see <sup>131</sup> La W, see <sup>131</sup> La	9E+2	4E+0	1E-9	5E-12	1E-5	1E-4
			-	1E+1	6E-9	2E-11	-	-
57	Lanthanum-140	D, see <sup>131</sup> La W, see <sup>131</sup> La	6E+2	1E+3	6E-7	2E-9	9E-6	9E-5
			-	1E+3	5E-7	2E-9	-	-
57	Lanthanum-141	D, see <sup>131</sup> La W, see <sup>131</sup> La	4E+3	9E+3	4E-6	1E-8	5E-5	5E-4
			-	1E+4	5E-6	2E-8	-	-
57	Lanthanum-142 <sup>2</sup>	D, see <sup>131</sup> La W, see <sup>131</sup> La	8E+3	2E+4	9E-6	3E-8	1E-4	1E-3
			-	3E+4	1E-5	5E-8	-	-
57	Lanthanum-143 <sup>2</sup>	D, see <sup>131</sup> La	4E+4	1E+5	4E-5	1E-7	-	-
			St wall (4E+4)	-	-	-	5E-4	5E-3
		W, see <sup>131</sup> La	-	9E+4	4E-5	1E-7	-	-
58	Cerium-134	W, all compounds except those given for Y	5E+2	7E+2	3E-7	1E-9	-	-
			LLI wall (6E+2)	-	-	-	8E-6	8E-5
		Y, oxides, hydroxides, and fluorides	-	7E+2	3E-7	9E-10	-	-
58	Cerium-135	W, see <sup>134</sup> Ce Y, see <sup>134</sup> Ce	2E+3	4E+3	2E-6	5E-9	2E-5	2E-4
			-	4E+3	1E-6	5E-9	-	-
58	Cerium-137m	W, see <sup>134</sup> Ce	2E+3	4E+3	2E-6	6E-9	-	-
			LLI wall (2E+3)	-	-	-	3E-5	3E-4
		Y, see <sup>134</sup> Ce	-	4E+3	2E-6	5E-9	-	-
58	Cerium-137	W, see <sup>134</sup> Ce Y, see <sup>134</sup> Ce	5E+4	1E+5	6E-5	2E-7	7E-4	7E-3
			-	1E+5	5E-5	2E-7	-	-

58	Cerium-139	W, see <sup>134</sup> Ce Y, see <sup>134</sup> Ce	5E+3 -	8E+2 7E+2	3E-7 3E-7	1E-9 9E-10	7E-5 -	7E-4 -
58	Cerium-141	W, see <sup>134</sup> Ce  Y, see <sup>134</sup> Ce	2E+3 LLI wall (2E+3) -	7E+2 6E+2	3E-7 2E-7	1E-9 8E-10	- 3E-5	- 3E-4
58	Cerium-143	W, see <sup>134</sup> Ce  Y, see <sup>134</sup> Ce	1E+3 LLI wall (1E+3) -	2E+3 2E+3	8E-7 7E-7	3E-9 2E-9	- 2E-5	- 2E-4
58	Cerium-144	W, see <sup>134</sup> Ce  Y, see <sup>134</sup> Ce	2E+2 LLI wall (3E+2) -	3E+1 1E+1	1E-8 6E-9	4E-11 2E-11	- 3E-6	- 3E-5
59	Praseodymium-136 <sup>2</sup>	W, all compounds except those given for Y  Y, oxides, hydroxides, carbides, and fluorides	5E+4 St wall (7E+4) -	2E+5 2E+5	1E-4 -	3E-7 -	- 1E-3	- 1E-2
59	Praseodymium-137 <sup>2</sup>	W, see <sup>136</sup> Pr Y, see <sup>136</sup> Pr	4E+4 -	2E+5 1E+5	6E-5 6E-5	2E-7 2E-7	5E-4 -	5E-3 -
59	Praseodymium-138m	W, see <sup>136</sup> Pr Y, see <sup>136</sup> Pr	1E+4 -	5E+4 4E+4	2E-5 2E-5	8E-8 6E-8	1E-4 -	1E-3 -
59	Praseodymium-139	W, see <sup>136</sup> Pr Y, see <sup>136</sup> Pr	4E+4 -	1E+5 1E+5	5E-5 5E-5	2E-7 2E-7	6E-4 -	6E-3 -
59	Praseodymium-142m <sup>2</sup>	W, see <sup>136</sup> Pr Y, see <sup>136</sup> Pr	8E+4 -	2E+5 1E+5	7E-5 6E-5	2E-7 2E-7	1E-3 -	1E-2 -
59	Praseodymium-142	W, see <sup>136</sup> Pr Y, see <sup>136</sup> Pr	1E+3 -	2E+3 2E+3	9E-7 8E-7	3E-9 3E-9	1E-5 -	1E-4 -
59	Praseodymium-143	W, see <sup>136</sup> Pr  Y, see <sup>136</sup> Pr	9E+2 LLI wall (1E+3) -	8E+2 7E+2	3E-7 3E-7	1E-9 9E-10	- 2E-5	- 2E-4
59	Praseodymium-144 <sup>2</sup>	W, see <sup>136</sup> Pr  Y, see <sup>136</sup> Pr	3E+4 St wall (4E+4) -	1E+5 1E+5	5E-5 5E-5	2E-7 2E-7	- 6E-4	- 6E-3
59	Praseodymium-145	W, see <sup>136</sup> Pr Y, see <sup>136</sup> Pr	3E+3 -	9E+3 8E+3	4E-6 3E-6	1E-8 1E-8	4E-5 -	4E-4 -
59	Praseodymium-147 <sup>2</sup>	W, see <sup>136</sup> Pr  Y, see <sup>136</sup> Pr	5E+4 St wall (8E+4) -	2E+5 2E+5	8E-5 8E-5	3E-7 3E-7	- 1E-3	- 1E-2
60	Neodymium-136 <sup>2</sup>	W, all compounds except those given for Y Y, oxides, hydroxides, carbides, and fluorides	1E+4 -	6E+4 5E+4	2E-5 2E-5	8E-8 8E-8	2E-4 -	2E-3 -
60	Neodymium-138	W, see <sup>136</sup> Nd Y, see <sup>136</sup> Nd	2E+3 -	6E+3 5E+3	3E-6 2E-6	9E-9 7E-9	3E-5 -	3E-4 -
60	Neodymium-139m	W, see <sup>136</sup> Nd Y, see <sup>136</sup> Nd	5E+3 -	2E+4 1E+4	7E-6 6E-6	2E-8 2E-8	7E-5 -	7E-4 -
60	Neodymium-139 <sup>2</sup>	W, see <sup>136</sup> Nd Y, see <sup>136</sup> Nd	9E+4 -	3E+5 3E+5	1E-4 1E-4	5E-7 4E-7	1E-3 -	1E-2 -
60	Neodymium-141	W, see <sup>136</sup> Nd Y, see <sup>136</sup> Nd	2E+5 -	7E+5 6E+5	3E-4 3E-4	1E-6 9E-7	2E-3 -	2E-2 -
60	Neodymium-147	W, see <sup>136</sup> Nd  Y, see <sup>136</sup> Nd	1E+3 LLI wall (1E+3) -	9E+2 8E+2	4E-7 4E-7	1E-9 1E-9	- 2E-5	- 2E-4
60	Neodymium-149 <sup>2</sup>	W, see <sup>136</sup> Nd Y, see <sup>136</sup> Nd	1E+4 -	3E+4 2E+4	1E-5 1E-5	4E-8 3E-8	1E-4 -	1E-3 -
60	Neodymium-151 <sup>2</sup>	W, see <sup>136</sup> Nd Y, see <sup>136</sup> Nd	7E+4 -	2E+5 2E+5	8E-5 8E-5	3E-7 3E-7	9E-4 -	9E-3 -

Radiation Protection Standards

246-221-290

61	Promethium-141 <sup>2</sup>	W, all compounds except those given for Y	5E+4 St wall (6E+4)	2E+5	8E-5	3E-7	-	-
		Y, oxides, hydroxides, carbides, and fluorides	-	2E+5	7E-5	2E-7	8E-4	8E-3
61	Promethium-143	W, see <sup>141</sup> Pm Y, see <sup>141</sup> Pm	5E+3 -	6E+2 7E+2	2E-7 3E-7	8E-10 1E-9	7E-5	7E-4
61	Promethium-144	W, see <sup>141</sup> Pm Y, see <sup>141</sup> Pm	1E+3 -	1E+2 1E+2	5E-8 5E-8	2E-10 2E-10	2E-5	2E-4
61	Promethium-145	W, see <sup>141</sup> Pm	1E+4	2E+2	7E-8	-	1E-4	1E-3
				Bone surf (2E+2)	-	3E-10	-	-
		Y, see <sup>141</sup> Pm	-	2E+2	8E-8	3E-10	-	-
61	Promethium-146	W, see <sup>141</sup> Pm Y, see <sup>141</sup> Pm	2E+3 -	5E+1 4E+1	2E-8 2E-8	7E-11 6E-11	2E-5	2E-4
61	Promethium-147	W, see <sup>141</sup> Pm	4E+3 LLI wall (5E+3)	1E+2 Bone surf (2E+2)	5E-8	-	-	-
		Y, see <sup>141</sup> Pm	-	1E+2	6E-8	3E-10 2E-10	7E-5	7E-4
61	Promethium-148m	W, see <sup>141</sup> Pm Y, see <sup>141</sup> Pm	7E+2 -	3E+2 3E+2	1E-7 1E-7	4E-10 5E-10	1E-5	1E-4
61	Promethium-148	W, see <sup>141</sup> Pm	4E+2 LLI wall (5E+2)	5E+2	2E-7	8E-10	-	-
		Y, see <sup>141</sup> Pm	-	5E+2	2E-7	7E-10	7E-6	7E-5
61	Promethium-149	W, see <sup>141</sup> Pm	1E+3 LLI wall (1E+3)	2E+3	8E-7	3E-9	-	-
		Y, see <sup>141</sup> Pm	-	2E+3	8E-7	2E-9	2E-5	2E-4
61	Promethium-150	W, see <sup>141</sup> Pm Y, see <sup>141</sup> Pm	5E+3 -	2E+4 2E+4	8E-6 7E-6	3E-8 2E-8	7E-5	7E-4
61	Promethium-151	W, see <sup>141</sup> Pm Y, see <sup>141</sup> Pm	2E+3 -	4E+3 3E+3	1E-6 1E-6	5E-9 4E-9	2E-5	2E-4
62	Samarium-141m <sup>2</sup>	W, all compounds	3E+4	1E+5	4E-5	1E-7	4E-4	4E-3
62	Samarium-141 <sup>2</sup>	W, all compounds	5E+4 St wall (6E+4)	2E+5	8E-5	2E-7	-	-
							8E-4	8E-3
62	Samarium-142 <sup>2</sup>	W, all compounds	8E+3	3E+4	1E-5	4E-8	1E-4	1E-3
62	Samarium-145	W, all compounds	6E+3	5E+2	2E-7	7E-10	8E-5	8E-4
62	Samarium-146	W, all compounds	1E+1 Bone surf (3E+1)	4E-2 Bone surf (6E-2)	1E-11	-	-	-
						9E-14	3E-7	3E-6
62	Samarium-147	W, all compounds	2E+1 Bone surf (3E+1)	4E-2 Bone surf (7E-2)	2E-11	-	-	-
						1E-13	4E-7	4E-6
62	Samarium-151	W, all compounds	1E+4 LLI wall (1E+4)	1E+2 Bone surf (2E+2)	4E-8	-	-	-
						2E-10	2E-4	2E-3
62	Samarium-153	W, all compounds	2E+3 LLI wall (2E+3)	3E+3	1E-6	4E-9	-	-
							3E-5	3E-4
62	Samarium-155 <sup>2</sup>	W, all compounds	6E+4 St wall (8E+4)	2E+5	9E-5	3E-7	-	-
							1E-3	1E-2
62	Samarium-156	W, all compounds	5E+3	9E+3	4E-6	1E-8	7E-5	7E-4
63	Europium-145	W, all compounds	2E+3	2E+3	8E-7	3E-9	2E-5	2E-4
63	Europium-146	W, all compounds	1E+3	1E+3	5E-7	2E-9	1E-5	1E-4
63	Europium-147	W, all compounds	3E+3	2E+3	7E-7	2E-9	4E-5	4E-4
63	Europium-148	W, all compounds	1E+3	4E+2	1E-7	5E-10	1E-5	1E-4
63	Europium-149	W, all compounds	1E+4	3E+3	1E-6	4E-9	2E-4	2E-3

63	Europium-150 (12.62 h)	W, all compounds	3E+3	8E+3	4E-6	1E-8	4E-5	4E-4
63	Europium-150 (34.2 y)	W, all compounds	8E+2	2E+1	8E-9	3E-11	1E-5	1E-4
63	Europium-152m	W, all compounds	3E+3	6E+3	3E-6	9E-9	4E-5	4E-4
63	Europium-152	W, all compounds	8E+2	2E+1	1E-8	3E-11	1E-5	1E-4
63	Europium-154	W, all compounds	5E+2	2E+1	8E-9	3E-11	7E-6	7E-5
63	Europium-155	W, all compounds	4E+3	9E+1	4E-8	-	5E-5	5E-4
			-	Bone surf (1E+2)	-	2E-10	-	-
63	Europium-156	W, all compounds	6E+2	5E+2	2E-7	6E-10	8E-6	8E-5
63	Europium-157	W, all compounds	2E+3	5E+3	2E-6	7E-9	3E-5	3E-4
63	Europium-158 <sup>2</sup>	W, all compounds	2E+4	6E+4	2E-5	8E-8	3E-4	3E-3
64	Gadolinium-145 <sup>2</sup>	D, all compounds except those given for W	5E+4	2E+5	6E-5	2E-7	-	-
			St wall (5E+4)	-	-	-	6E-4	6E-3
		W, oxides, hydroxides, and fluorides	-	2E+5	7E-5	2E-7	-	-
64	Gadolinium-146	D, see <sup>145</sup> Gd W, see <sup>145</sup> Gd	1E+3	1E+2	5E-8	2E-10	2E-5	2E-4
			-	3E+2	1E-7	4E-10	-	-
64	Gadolinium-147	D, see <sup>145</sup> Gd W, see <sup>145</sup> Gd	2E+3	4E+3	2E-6	6E-9	3E-5	3E-4
			-	4E+3	1E-6	5E-9	-	-
64	Gadolinium-148	D, see <sup>145</sup> Gd	1E+1	8E+3	3E-12	-	-	-
			Bone surf (2E+1)	Bone surf (2E+2)	-	2E-14	3E-7	3E-6
		W, see <sup>145</sup> Gd	-	3E-2	1E-11	-	-	-
			-	Bone surf (6E-2)	-	8E-14	-	-
64	Gadolinium-149	D, see <sup>145</sup> Gd W, see <sup>145</sup> Gd	3E+3	2E+3	9E-7	3E-9	4E-5	4E-4
			-	2E+3	1E-6	3E-9	-	-
64	Gadolinium-151	D, see <sup>145</sup> Gd	6E+3	4E+2	2E-7	-	9E-5	9E-4
			-	Bone surf (6E+2)	-	9E-10	-	-
		W, see <sup>145</sup> Gd	-	1E+3	5E-7	2E-9	-	-
64	Gadolinium-152	D, see <sup>145</sup> Gd	2E+1	1E-2	4E-12	-	-	-
			Bone surf (3E+1)	Bone surf (2E-2)	-	3E-14	4E-7	4E-6
		W, see <sup>145</sup> Gd	-	4E-2	2E-11	-	-	-
			-	Bone surf (8E-2)	-	1E-13	-	-
64	Gadolinium-153	D, see <sup>145</sup> Gd	5E+3	1E+2	6E-8	-	6E-5	6E-4
			-	Bone surf (2E+2)	-	3E-10	-	-
		W, see <sup>145</sup> Gd	-	6E+2	2E-7	8E-10	-	-
64	Gadolinium-159	D, see <sup>145</sup> Gd W, see <sup>145</sup> Gd	3E+3	8E+3	3E-6	1E-8	4E-5	4E-4
			-	6E+3	2E-6	8E-9	-	-
65	Terbium-147 <sup>2</sup>	W, all compounds	9E+3	3E+4	1E-5	5E-8	1E-4	1E-3
65	Terbium-149	W, all compounds	5E+3	7E+2	3E-7	1E-9	7E-5	7E-4
65	Terbium-150	W, all compounds	5E+3	2E+4	9E-6	3E-8	7E-5	7E-4
65	Terbium-151	W, all compounds	4E+3	9E+3	4E-6	1E-8	5E-5	5E-4
65	Terbium-153	W, all compounds	5E+3	7E+3	3E-6	1E-8	7E-5	7E-4
65	Terbium-154	W, all compounds	2E+3	4E+3	2E-6	6E-9	2E-5	2E-4
65	Terbium-155	W, all compounds	6E+3	8E+3	3E-6	1E-8	8E-5	8E-4
65	Terbium-156m (5.0 h)	W, all compounds	2E+4	3E+4	1E-5	4E-8	2E-4	2E-3
65	Terbium-156m (24.4 h)	W, all compounds	7E+3	8E+3	3E-6	1E-8	1E-4	1E-3
65	Terbium-156	W, all compounds	1E+3	1E+3	6E-7	2E-9	1E-5	1E-4
65	Terbium-157	W, all compounds	5E+4	3E+2	1E-7	-	-	-



## Radiation Protection Standards

246-221-290

			LLI wall (5E+4)	Bone surf (6E+2)		8E-10	7E-4	7E-3
65	Terbium-158	W, all compounds	1E+3	2E+1	8E-9	3E-11	2E-5	2E-4
65	Terbium-160	W, all compounds	8E+2	2E+2	9E-8	3E-10	1E-5	1E-4
65	Terbium-161	W, all compounds	2E+3	2E+3	7E-7	2E-9	-	-
			LLI wall (2E+3)	-	-	-	3E-5	3E-4
66	Dysprosium-155	W, all compounds	9E+3	3E+4	1E-5	4E-8	1E-4	1E-3
66	Dysprosium-157	W, all compounds	2E+4	6E+4	3E-5	9E-8	3E-4	3E-3
66	Dysprosium-159	W, all compounds	1E+4	2E+3	1E-6	3E-9	2E-4	2E-3
66	Dysprosium-165	W, all compounds	1E+4	5E+4	2E-5	6E-8	2E-4	2E-3
66	Dysprosium-166	W, all compounds	6E+2	7E+2	3E-7	1E-9	-	-
			LLI wall (8E+2)	-	-	-	1E-5	1E-4
67	Holmium-155 <sup>2</sup>	W, all compounds	4E+4	2E+5	6E-5	2E-7	6E-4	6E-3
67	Holmium-157 <sup>2</sup>	W, all compounds	3E+5	1E+6	6E-4	2E-6	4E-3	4E-2
67	Holmium-159 <sup>2</sup>	W, all compounds	2E+5	1E+6	4E-4	1E-6	3E-3	3E-2
67	Holmium-161	W, all compounds	1E+5	4E+5	2E-4	6E-7	1E-3	1E-2
67	Holmium-162m <sup>2</sup>	W, all compounds	5E+4	3E+5	1E-4	4E-7	7E-4	7E-3
67	Holmium-162 <sup>2</sup>	W, all compounds	5E+5	2E+6	1E-3	3E-6	-	-
			St wall (8E+5)	-	-	-	1E-2	1E-1
67	Holmium-164m <sup>2</sup>	W, all compounds	1E+5	3E+5	1E-4	4E-7	1E-3	1E-2
67	Holmium-164 <sup>2</sup>	W, all compounds	2E+5	6E+5	3E-4	9E-7	-	-
			St wall (2E+5)	-	-	-	3E-3	3E-2
67	Holmium-166m	W, all compounds	6E+2	7E+0	3E-9	9E-12	9E-6	9E-5
67	Holmium-166	W, all compounds	9E+2	2E+3	7E-7	2E-9	-	-
			LLI wall (9E+2)	-	-	-	1E-5	1E-4
67	Holmium-167	W, all compounds	2E+4	6E+4	2E-5	8E-8	2E-4	2E-3
68	Erbium-161	W, all compounds	2E+4	6E+4	3E-5	9E-8	2E-4	2E-3
68	Erbium-165	W, all compounds	6E+4	2E+5	8E-5	3E-7	9E-4	9E-3
68	Erbium-169	W, all compounds	3E+3	3E+3	1E-6	4E-9	-	-
			LLI wall (4E+3)	-	-	-	5E-5	5E-4
68	Erbium-171	W, all compounds	4E+3	1E+4	4E-6	1E-8	5E-5	5E-4
68	Erbium-172	W, all compounds	1E+3	1E+3	6E-7	2E-9	-	-
			LLI wall (E+3)	-	-	-	2E-5	2E-4
69	Thulium-162 <sup>2</sup>	W, all compounds	7E+4	3E+5	1E-4	4E-7	-	-
			St wall (7E+4)	-	-	-	1E-3	1E-2
69	Thulium-166	W, all compounds	4E+3	1E+4	6E-6	2E-8	6E-5	6E-4
69	Thulium-167	W, all compounds	2E+3	2E+3	8E-7	3E-9	-	-
			LLI wall (2E+3)	-	-	-	3E-5	3E-4
69	Thulium-170	W, all compounds	8E+2	2E+2	9E-8	3E-10	-	-
			LLI wall (1E+3)	-	-	-	1E-5	1E-4
69	Thulium-171	W, all compounds	1E+4	3E+2	1E-7	-	-	-
			LLI wall (1E+4)	Bone surf (6E+2)	-	8E-10	2E-4	2E-3
69	Thulium-172	W, all compounds	7E+2	1E+3	5E-7	2E-9	-	-
			LLI wall (8E+2)	-	-	-	1E-5	1E-4
69	Thulium-173	W, all compounds	4E+3	1E+4	5E-6	2E-8	6E-5	6E-4
69	Thulium-175 <sup>2</sup>	W, all compounds	7E+4	3E+5	1E-4	4E-7	-	-

			St wall (9E+4)	-	-	-	1E-3	1E-2
70	Ytterbium-162 <sup>2</sup>	W, all compounds except those given for Y Y, oxides, hydroxides, and fluorides	7E+4	3E+5	1E-4	4E-7	1E-3	1E-2
			-	3E+5	1E-4	4E-7	-	-
70	Ytterbium-166	W, see 162Yb Y, see 162Yb	1E+3	2E+3	8E-7	3E-9	2E-5	2E-4
			-	2E+3	8E-7	3E-9	-	-
70	Ytterbium-167 <sup>2</sup>	W, see 162Yb Y, see 162Yb	3E+5	8E+5	3E-4	1E-6	4E-3	4E-2
			-	7E+5	3E-4	1E-6	-	-
70	Ytterbium-169	W, see 162Yb Y, see 162Yb	2E+3	8E+2	4E-7	1E-9	2E-5	2E-4
			-	7E+2	3E-7	1E-9	-	-
70	Ytterbium-175	W, see 162Yb	3E+3	4E+3	1E-6	5E-9	-	-
			LLI wall (3E+3)	-	-	-	4E-5	4E-4
		Y, see 162Yb	-	3E+3	1E-6	5E-9	-	-
70	Ytterbium-177 <sup>2</sup>	W, see 162Yb Y, see 162Yb	2E+4	5E+4	2E-5	7E-8	2E-4	2E-3
			-	5E+4	2E-5	6E-8	-	-
70	Ytterbium-178 <sup>2</sup>	W, see 162Yb Y, see 162Yb	1E+4	4E+4	2E-5	6E-8	2E-4	2E-3
			-	4E+4	2E-5	5E-8	-	-
71	Lutetium-169	W, all compounds except those given for Y Y, oxides, hydroxides, and fluorides	3E+3	4E+3	2E-6	6E-9	3E-5	3E-4
			-	4E+3	2E-6	6E-9	-	-
71	Lutetium-170	W, see 169Lu Y, see 169Lu	1E+3	2E+3	9E-7	3E-9	2E-5	2E-4
			-	2E+3	8E-7	3E-9	-	-
71	Lutetium-171	W, see 169Lu Y, see 169Lu	2E+3	2E+3	8E-7	3E-9	3E-5	3E-4
			-	2E+3	8E-7	3E-9	-	-
71	Lutetium-172	W, see 169Lu Y, see 169Lu	1E+3	1E+3	5E-7	2E-9	1E-5	1E-4
			-	1E+3	5E-7	2E-9	-	-
71	Lutetium-173	W, see 169Lu	5E+3	3E+2	1E-7	-	7E-5	7E-4
			-	Bone surf (5E+2)	-	6E-10	-	-
		Y, see 169Lu	-	3E+2	1E-7	4E-10	-	-
71	Lutetium-174m	W, see 169Lu	2E+3	2E+2	1E-7	-	-	-
			LLI wall (3E+3)	Bone surf (3E+2)	-	5E-10	4E-5	4E-4
		Y, see 169Lu	-	2E+2	9E-8	3E-10	-	-
71	Lutetium-174	W, see 169Lu	5E+3	1E+2	5E-8	-	7E-5	7E-4
			-	Bone surf (2E+2)	-	3E-10	-	-
		Y, see 169Lu	-	2E+2	6E-8	2E-10	-	-
71	Lutetium-176m	W, see 169Lu Y, see 169Lu	8E+3	3E+4	1E-5	3E-8	1E-4	1E-3
			-	2E+4	9E-6	3E-8	-	-
71	Lutetium-176	W, see 169Lu	7E+2	5E+0	2E-9	-	1E-5	1E-4
			-	Bone surf (1E+1)	-	2E-11	-	-
		Y, see 169Lu	-	8E+0	3E-9	1E-11	-	-
71	Lutetium-177m	W, see 169Lu	7E+2	1E+2	5E-8	-	1E-5	1E-4
			-	Bone surf (1E+2)	-	2E-10	-	-
		Y, see 169Lu	-	8E+1	3E-8	1E-10	-	-
71	Lutetium-177	W, see 169Lu	2E+3	2E+3	9E-7	3E-9	-	-
			LLI wall (3E+3)	-	-	-	4E-5	4E-4
		Y, see 169Lu	-	2E+3	9E-7	3E-9	-	-
71	Lutetium-178m <sup>2</sup>	W, see 169Lu	5E+4	2E+5	8E-5	3E-7	-	-
			St. wall (6E+4)	-	-	-	8E-4	8E-3
		Y, see 169Lu	-	2E+5	7E-5	2E-7	-	-
71	Lutetium-178 <sup>2</sup>	W, see 169Lu	4E+4	1E+5	5E-5	2E-7	-	-
			St. wall (4E+4)	-	-	-	6E-4	6E-3
		Y, see 169Lu	-	1E+5	5E-5	2E-7	-	-

Radiation Protection Standards

246-221-290

71	Lutetium-179	W, see <sup>169</sup> Lu Y, see <sup>169</sup> Lu	6E+3 -	2E+4 2E+4	8E-6 6E-6	3E-8 3E-8	9E-5 -	9E-4 -
72	Hafnium-170	D, all compounds except those given for W W, oxides, hydroxides, carbides, and nitrates	3E+3 -	6E+3 5E+3	2E-6 2E-6	8E-9 6E-9	4E-5 -	4E-4 -
72	Hafnium-172	D, see <sup>170</sup> Hf  W, see <sup>170</sup> Hf	1E+3 - -	9E+0 Bone surf (2E+1) 4E+1 Bone surf (6E+1)	4E-9 - 2E-8 -	- 3E-11 - 8E-11	2E-5 - -	2E-4 - -
72	Hafnium-173	D, see <sup>170</sup> Hf W, see <sup>170</sup> Hf	5E+3 -	1E+4 1E+4	5E-6 5E-6	2E-8 2E-8	7E-5 -	7E-4 -
72	Hafnium-175	D, see <sup>170</sup> Hf  W, see <sup>170</sup> Hf	3E+3 -	9E+2 1E+3	4E-7 5E-7	- 2E-9	4E-5 -	4E-4 -
72	Hafnium-177m <sup>2</sup>	D, see <sup>170</sup> Hf W, see <sup>170</sup> Hf	2E+4 -	6E+4 9E+4	2E-5 4E-5	8E-8 1E-7	3E-4 -	3E-3 -
72	Hafnium-178m	D, see <sup>170</sup> Hf  W, see <sup>170</sup> Hf	3E+2 - -	1E+0 Bone surf (2E+0) 5E+0 Bone surf (9E+0)	5E-10 - 2E-9 -	- 3E-12 - 1E-11	3E-6 - -	3E-5 - -
72	Hafnium-179m	D, see <sup>170</sup> Hf  W, see <sup>170</sup> Hf	1E+3 -	3E+2 Bone surf (6E+2) 6E+2	1E-7 - 3E-7	- 8E-10 8E-10	1E-5 -	1E-4 -
72	Hafnium-180m	D, see <sup>170</sup> Hf W, see <sup>170</sup> Hf	7E+3 -	2E+4 3E+4	9E-6 1E-5	3E-8 4E-8	1E-4 -	1E-3 -
72	Hafnium-181	D, see <sup>170</sup> Hf  W, see <sup>170</sup> Hf	1E+3 -	2E+2 Bone surf (4E+2) 4E+2	7E-8 - 2E-7	- 6E-10 6E-10	2E-5 -	2E-4 -
72	Hafnium-182m <sup>2</sup>	D, see <sup>170</sup> Hf W, see <sup>170</sup> Hf	4E+4 -	9E+4 1E+5	4E-5 6E-5	1E-7 2E-7	5E-4 -	5E-3 -
72	Hafnium-182	D, see <sup>170</sup> Hf  W, see <sup>170</sup> Hf	2E+2 Bone surf (4E+2) -	8E-1 Bone surf (2E+0) 3E+0 Bone surf (7E+0)	3E-10 - 1E-9 -	- 2E-12 - 1E-11	- 5E-6 -	- 5E-5 -
72	Hafnium-183 <sup>2</sup>	D, see <sup>170</sup> Hf W, see <sup>170</sup> Hf	2E+4 -	5E+4 6E+4	2E-5 2E-5	6E-8 8E-8	3E-4 -	3E-3 -
72	Hafnium-184	D, see <sup>170</sup> Hf W, see <sup>170</sup> Hf	2E+3 -	8E+3 6E+3	3E-6 3E-6	1E-8 9E-9	3E-5 -	3E-4 -
73	Tantalum-172 <sup>2</sup>	W, all compounds except those given for Y Y, elemental Ta, oxides, hydroxides, halides, carbides, nitrates, and nitrides	4E+4 -	1E+5 1E+5	5E-5 4E-5	2E-7 1E-7	5E-4 -	5E-3 -
73	Tantalum-173	W, see <sup>172</sup> Ta Y, see <sup>172</sup> Ta	7E+3 -	2E+4 2E+4	8E-6 7E-6	3E-8 2E-8	9E-5 -	9E-4 -
73	Tantalum-174 <sup>2</sup>	W, see <sup>172</sup> Ta Y, see <sup>172</sup> Ta	3E+4 -	1E+5 9E+4	4E-5 4E-5	1E-7 1E-7	4E-4 -	4E-3 -
73	Tantalum-175	W, see <sup>172</sup> Ta Y, see <sup>172</sup> Ta	6E+3 -	2E+4 1E+4	7E-6 6E-6	2E-8 2E-8	8E-5 -	8E-4 -
73	Tantalum-176	W, see <sup>172</sup> Ta Y, see <sup>172</sup> Ta	4E+3 -	1E+4 1E+4	5E-6 5E-6	2E-8 2E-8	5E-5 -	5E-4 -
73	Tantalum-177	W, see <sup>172</sup> Ta Y, see <sup>172</sup> Ta	1E+4 -	2E+4 2E+4	8E-6 7E-6	3E-8 2E-8	2E-4 -	2E-3 -
73	Tantalum-178	W, see <sup>172</sup> Ta	2E+4	9E+4	4E-5	1E-7	2E-4	2E-3

		Y, see <sup>172</sup> Ta	-	7E+4	3E-5	1E-7	-	-
73	Tantalum-179	W, see <sup>172</sup> Ta	2E+4	5E+3	2E-6	8E-9	3E-4	3E-3
		Y, see <sup>172</sup> Ta	-	9E+2	4E-7	1E-9	-	-
73	Tantalum-180m	W, see <sup>172</sup> Ta	2E+4	7E+4	3E-5	9E-8	3E-4	3E-3
		Y, see <sup>172</sup> Ta	-	6E+4	2E-5	8E-8	-	-
73	Tantalum-180	W, see <sup>172</sup> Ta	1E+3	4E+2	2E-7	6E-10	2E-5	2E-4
		Y, see <sup>172</sup> Ta	-	2E+1	1E-8	3E-11	-	-
73	Tantalum-182m <sup>2</sup>	W, see <sup>172</sup> Ta	2E+5	5E+5	2E-4	8E-7	-	-
			St wall (2E+5)	-	-	-	3E-3	3E-2
		Y, see <sup>172</sup> Ta	-	4E+5	2E-4	6E-7	-	-
73	Tantalum-182	W, see <sup>172</sup> Ta	8E+2	3E+2	1E-7	5E-10	1E-5	1E-4
		Y, see <sup>172</sup> Ta	-	1E+2	6E-8	2E-10	-	-
73	Tantalum-183	W, see <sup>172</sup> Ta	9E+2	1E+3	5E-7	2E-9	-	-
			LLI wall (1E+3)	-	-	-	2E-5	2E-4
		Y, see <sup>172</sup> Ta	-	1E+3	4E-7	1E-9	-	-
73	Tantalum-184	W, see <sup>172</sup> Ta	2E+3	5E+3	2E-6	8E-9	3E-5	3E-4
		Y, see <sup>172</sup> Ta	-	5E+3	2E-6	7E-9	-	-
73	Tantalum-185 <sup>2</sup>	W, see <sup>172</sup> Ta	3E+4	7E+4	3E-5	1E-7	4E-4	4E-3
		Y, see <sup>172</sup> Ta	-	6E+4	3E-5	9E-8	-	-
73	Tantalum-186 <sup>2</sup>	W, see <sup>172</sup> Ta	5E+4	2E+5	1E-4	3E-7	-	-
			St wall (7E+4)	-	-	-	1E-3	1E-2
		Y, see <sup>172</sup> Ta	-	2E+5	9E-5	3E-7	-	-
74	Tungsten-176	D, all compounds	1E+4	5E+4	2E-5	7E-8	1E-4	1E-3
74	Tungsten-177	D, all compounds	2E+4	9E+4	4E-5	1E-7	3E-4	3E-3
74	Tungsten-178	D, all compounds	5E+3	2E+4	8E-6	3E-8	7E-5	7E-4
74	Tungsten-179 <sup>2</sup>	D, all compounds	5E+5	2E+6	7E-4	2E-6	7E-3	7E-2
74	Tungsten-181	D, all compounds	2E+4	3E+4	1E-5	5E-8	2E-4	2E-3
74	Tungsten-185	D, all compounds	2E+3	7E+3	3E-6	9E-9	-	-
			LLI wall (3E+3)	-	-	-	4E-5	4E-4
74	Tungsten-187	D, all compounds	2E+3	9E+3	4E-6	1E-8	3E-5	3E-4
74	Tungsten-188	D, all compounds	4E+2	1E+3	5E-7	2E-9	-	-
			LLI wall (5E+2)	-	-	-	7E-6	7E-5
75	Rhenium-177 <sup>2</sup>	D, all compounds except those given for W	9E+4	3E+5	1E-4	4E-7	-	-
			St wall (1E+5)	-	-	-	2E-3	2E-2
		W, oxides, hydroxides, and nitrates	-	4E+5	1E-4	5E-7	-	-
75	Rhenium-178 <sup>2</sup>	D, see <sup>177</sup> Re	7E+4	3E+5	1E-4	4E-7	-	-
			St wall (1E+5)	-	-	-	1E-3	1E-2
		W, see <sup>177</sup> Re	-	3E+5	1E-4	4E-7	-	-
75	Rhenium-181	D, see <sup>177</sup> Re	5E+3	9E+3	4E-6	1E-8	7E-5	7E-4
		W, see <sup>177</sup> Re	-	9E+3	4E-6	1E-8	-	-
75	Rhenium-182 (12.7 h)	D, see <sup>177</sup> Re	7E+3	1E+4	5E-6	2E-8	9E-5	9E-4
		W, see <sup>177</sup> Re	-	2E+4	6E-6	2E-8	-	-
75	Rhenium-182 (64.0 h)	D, see <sup>177</sup> Re	1E+3	2E+3	1E-6	3E-9	2E-5	2E-4
		W, see <sup>177</sup> Re	-	2E+3	9E-7	3E-9	-	-
75	Rhenium-184m	D, see <sup>177</sup> Re	2E+3	3E+3	1E-6	4E-9	3E-5	3E-4
		W, see <sup>177</sup> Re	-	4E+2	2E-7	6E-10	-	-
75	Rhenium-184	D, see <sup>177</sup> Re	2E+3	4E+3	1E-6	5E-9	3E-5	3E-4
		W, see <sup>177</sup> Re	-	1E+3	6E-7	2E-9	-	-
75	Rhenium-186m	D, see <sup>177</sup> Re	1E+3	2E+3	7E-7	-	-	-
			St wall (2E+3)	St wall (2E+3)	-	3E-9	2E-5	2E-4
		W, see <sup>177</sup> Re	-	2E+2	6E-8	2E-10	-	-

75	Rhenium-186	D, see <sup>177</sup> Re W, see <sup>177</sup> Re	2E+3 -	3E+3 2E+3	1E-6 7E-7	4E-9 2E-9	3E-5 -	3E-4 -
75	Rhenium-187	D, see <sup>177</sup> Re  W, see <sup>177</sup> Re	6E+5 -	8E+5 St wall (9E+5) 1E+5	4E-4 -	- 1E-6 1E-7	8E-3 -	8E-2 -
75	Rhenium-188m <sup>2</sup>	D, see <sup>177</sup> Re W, see <sup>177</sup> Re	8E+4 -	1E+5 1E+5	6E-5 6E-5	2E-7 2E-7	1E-3 -	1E-2 -
75	Rhenium-188	D, see <sup>177</sup> Re W, see <sup>177</sup> Re	2E+3 -	3E+3 3E+3	1E-6 1E-6	4E-9 4E-9	2E-5 -	2E-4 -
75	Rhenium-189	D, see <sup>177</sup> Re W, see <sup>177</sup> Re	3E+3 -	5E+3 4E+3	2E-6 2E-6	7E-9 6E-9	4E-5 -	4E-4 -
76	Osmium-180 <sup>2</sup>	D, all compounds except those given for W and Y W, halides and nitrates Y, oxides and hydroxides	1E+5 - -	4E+5 5E+5 5E+5	2E-4 2E-4 2E-4	5E-7 7E-7 6E-7	1E-3 - -	1E-2 - -
76	Osmium-181 <sup>2</sup>	D, see <sup>180</sup> Os W, see <sup>180</sup> Os Y, see <sup>180</sup> Os	1E+4 - -	4E+4 5E+4 4E+4	2E-5 2E-5 2E-5	6E-8 6E-8 6E-8	2E-4 -	2E-3 -
76	Osmium-182	D, see <sup>180</sup> Os W, see <sup>180</sup> Os Y, see <sup>180</sup> Os	2E+3 - -	6E+3 4E+3 4E+3	2E-6 2E-6 2E-6	8E-9 6E-9 6E-9	3E-5 -	3E-4 -
76	Osmium-185	D, see <sup>180</sup> Os W, see <sup>180</sup> Os Y, see <sup>180</sup> Os	2E+3 - -	5E+2 8E+2 8E+2	2E-7 3E-7 3E-7	7E-10 1E-9 1E-9	3E-5 -	3E-4 -
76	Osmium-189m	D, see <sup>180</sup> Os W, see <sup>180</sup> Os Y, see <sup>180</sup> Os	8E+4 - -	2E+5 2E+5 2E+5	1E-4 9E-5 7E-5	3E-7 3E-7 2E-7	1E-3 -	1E-2 -
76	Osmium-191m	D, see <sup>180</sup> Os W, see <sup>180</sup> Os Y, see <sup>180</sup> Os	1E+4 - -	3E+4 2E+4 2E+4	1E-5 8E-6 7E-6	4E-8 3E-8 2E-8	2E-4 -	2E-3 -
76	Osmium-191	D, see <sup>180</sup> Os  W, see <sup>180</sup> Os Y, see <sup>180</sup> Os	2E+3 LLI wall (3E+3) -	2E+3 - 2E+3 1E+3	9E-7 - 7E-7 6E-7	3E-9 - 2E-9 2E-9	- 3E-5 -	- 3E-4 -
76	Osmium-193	D, see <sup>180</sup> Os  W, see <sup>180</sup> Os Y, see <sup>180</sup> Os	2E+3 LLI wall (2E+3) -	5E+3 - 3E+3 3E+3	2E-6 - 1E-6 1E-6	6E-9 - 4E-9 4E-9	- 2E-5 -	- 2E-4 -
76	Osmium-194	D, see <sup>180</sup> Os  W, see <sup>180</sup> Os Y, see <sup>180</sup> Os	4E+2 LLI wall (6E+2) -	4E+1 - 6E+1 8E+0	2E-8 - 2E-8 3E-9	6E-11 - 8E-11 1E-11	- 8E-6 -	- 8E-5 -
77	Iridium-182 <sup>2</sup>	D, all compounds except those given for W and Y  W, halides, nitrates, and metallic iridium Y, oxides and hydroxides	4E+4 St wall (4E+4) -	1E+5 - 2E+5 1E+5	6E-5 - 6E-5 5E-5	2E-7 - 2E-7 2E-7	- 6E-4 -	- 6E-3 -
77	Iridium-184	D, see <sup>182</sup> Ir W, see <sup>182</sup> Ir Y, see <sup>182</sup> Ir	8E+3 - -	2E+4 3E+4 3E+4	1E-5 1E-5 1E-5	3E-8 5E-8 4E-8	1E-4 -	1E-3 -
77	Iridium-185	D, see <sup>182</sup> Ir W, see <sup>182</sup> Ir Y, see <sup>182</sup> Ir	5E+3 - -	1E+4 1E+4 1E+4	5E-6 5E-6 4E-6	2E-8 2E-8 1E-8	7E-5 -	7E-4 -
77	Iridium-186	D, see <sup>182</sup> Ir W, see <sup>182</sup> Ir Y, see <sup>182</sup> Ir	2E+3 - -	8E+3 6E+3 6E+3	3E-6 3E-6 2E-6	1E-8 9E-9 8E-9	3E-5 -	3E-4 -
77	Iridium-187	D, see <sup>182</sup> Ir W, see <sup>182</sup> Ir Y, see <sup>182</sup> Ir	1E+4 - -	3E+4 3E+4 3E+4	1E-5 1E-5 1E-5	5E-8 4E-8 4E-8	1E-4 -	1E-3 -

77	Iridium-188	D, see <sup>182</sup> Ir W, see <sup>182</sup> Ir Y, see <sup>182</sup> Ir	2E+3 - -	5E+3 4E+3 3E+3	2E-6 1E-6 1E-6	6E-9 5E-9 5E-9	3E-5 - -	3E-4 - -
77	Iridium-189	D, see <sup>182</sup> Ir	5E+3	5E+3	2E-6	7E-9	-	-
			LLI wall (5E+3)	-	-	-	7E-5	7E-4
		W, see <sup>182</sup> Ir Y, see <sup>182</sup> Ir	- -	4E+3 4E+3	2E-6 1E-6	5E-9 5E-9	- -	- -
77	Iridium-190m <sup>2</sup>	D, see <sup>182</sup> Ir W, see <sup>182</sup> Ir Y, see <sup>182</sup> Ir	2E+5 - -	2E+5 2E+5 2E+5	8E-5 9E-5 8E-5	3E-7 3E-7 3E-7	2E-3 - -	2E-2 - -
77	Iridium-190	D, see <sup>182</sup> Ir W, see <sup>182</sup> Ir Y, see <sup>182</sup> Ir	1E+3 - -	9E+2 1E+3 9E+2	4E-7 4E-7 4E-7	1E-9 1E-9 1E-9	1E-5 - -	1E-4 - -
77	Iridium-192m	D, see <sup>182</sup> Ir W, see <sup>182</sup> Ir Y, see <sup>182</sup> Ir	3E+3 - -	9E+1 2E+2 2E+1	4E-8 9E-8 6E-9	1E-10 3E-10 2E-11	4E-5 - -	4E-4 - -
77	Iridium-192	D, see <sup>182</sup> Ir W, see <sup>182</sup> Ir Y, see <sup>182</sup> Ir	9E+2 - -	3E+2 4E+2 2E+2	1E-7 2E-7 9E-8	4E-10 6E-10 3E-10	1E-5 - -	1E-4 - -
77	Iridium-194m	D, see <sup>182</sup> Ir W, see <sup>182</sup> Ir Y, see <sup>182</sup> Ir	6E+2 - -	9E+1 2E+2 1E+2	4E-8 7E-8 4E-8	1E-10 2E-10 1E-10	9E-6 - -	9E-5 - -
77	Iridium-194	D, see <sup>182</sup> Ir W, see <sup>182</sup> Ir Y, see <sup>182</sup> Ir	1E+3 - -	3E+3 2E+3 2E+3	1E-6 9E-7 8E-7	4E-9 3E-9 3E-9	1E-5 - -	1E-4 - -
77	Iridium-195m	D, see <sup>182</sup> Ir W, see <sup>182</sup> Ir Y, see <sup>182</sup> Ir	8E+3 - -	2E+4 3E+4 2E+4	1E-5 1E-5 9E-6	3E-8 4E-8 3E-8	1E-4 - -	1E-3 - -
77	Iridium-195	D, see <sup>182</sup> Ir W, see <sup>182</sup> Ir Y, see <sup>182</sup> Ir	1E+4 - -	4E+4 5E+4 4E+4	2E-5 2E-5 2E-5	6E-8 7E-8 6E-8	2E-4 - -	2E-3 - -
78	Platinum-186	D, all compounds	1E+4	4E+4	2E-5	5E-8	2E-4	2E-3
78	Platinum-188	D, all compounds	2E+3	2E+3	7E-7	2E-9	2E-5	2E-4
78	Platinum-189	D, all compounds	1E+4	3E+4	1E-5	4E-8	1E-4	1E-3
78	Platinum-191	D, all compounds	4E+3	8E+3	4E-6	1E-8	5E-5	5E-4
78	Platinum-193m	D, all compounds	3E+3	6E+3	3E-6	8E-9	-	-
			LLI wall (3E+4)	-	-	-	4E-5	4E-4
78	Platinum-193	D, all compounds	4E+4	2E+4	1E-5	3E-8	-	-
			LLI wall (5E+4)	-	-	-	6E-4	6E-3
78	Platinum-195m	D, all compounds	2E+3	4E+3	2E-6	6E-9	-	-
			LLI wall (2E+3)	-	-	-	3E-5	3E-4
78	Platinum-197m <sup>2</sup>	D, all compounds	2E+4	4E+4	2E-5	6E-8	2E-4	2E-3
78	Platinum-197	D, all compounds	3E+3	1E+4	4E-6	1E-8	4E-5	4E-4
78	Platinum-199 <sup>2</sup>	D, all compounds	5E+4	1E+5	6E-5	2E-7	7E-4	7E-3
78	Platinum-200	D, all compounds	1E+3	3E+3	1E-6	5E-9	2E-5	2E-4
79	Gold-193	D, all compounds except those given for W and Y W, halides and nitrates Y, oxides and hydroxides	9E+3 - -	3E+4 2E+4 2E+4	1E-5 9E-6 8E-6	4E-8 3E-8 3E-8	1E-4 - -	1E-3 - -
79	Gold-194	D, see <sup>193</sup> Au W, see <sup>193</sup> Au Y, see <sup>193</sup> Au	3E+3 - -	8E+3 5E+3 5E+3	3E-6 2E-6 2E-6	1E-8 8E-9 7E-9	4E-5 - -	4E-4 - -
79	Gold-195	D, see <sup>193</sup> Au W, see <sup>193</sup> Au Y, see <sup>193</sup> Au	5E+3 - -	1E+4 1E+3 4E+2	5E-6 6E-7 2E-7	2E-8 2E-9 6E-10	7E-5 - -	7E-4 - -
79	Gold-198m	D, see <sup>193</sup> Au W, see <sup>193</sup> Au Y, see <sup>193</sup> Au	1E+3 - -	3E+3 1E+3 1E+3	1E-6 5E-7 5E-7	4E-9 2E-9 2E-9	1E-5 - -	1E-4 - -

## Radiation Protection Standards

246-221-290

79	Gold-198	D, see <sup>193</sup> Au	1E+3	4E+3	2E-6	5E-9	2E-5	2E-4
		W, see <sup>193</sup> Au	-	2E+3	8E-7	3E-9	-	-
		Y, see <sup>193</sup> Au	-	2E+3	7E-7	2E-9	-	-
79	Gold-199	D, see <sup>193</sup> Au	3E+3	9E+3	4E-6	1E-8	-	-
		W, see <sup>193</sup> Au	-	4E+3	2E-6	6E-9	-	4E-5
		Y, see <sup>193</sup> Au	-	4E+3	2E-6	5E-9	-	4E-4
79	Gold-200m	D, see <sup>193</sup> Au	1E+3	4E+3	1E-6	5E-9	2E-5	2E-4
		W, see <sup>193</sup> Au	-	3E+3	1E-6	4E-9	-	-
		Y, see <sup>193</sup> Au	-	2E+4	1E-6	3E-9	-	-
79	Gold-200 <sup>2</sup>	D, see <sup>193</sup> Au	3E+4	6E+4	3E-5	9E-8	4E-4	4E-3
		W, see <sup>193</sup> Au	-	8E+4	3E-5	1E-7	-	-
		Y, see <sup>193</sup> Au	-	7E+4	3E-5	1E-7	-	-
79	Gold-201 <sup>2</sup>	D, see <sup>193</sup> Au	7E+4	2E+5	9E-5	3E-7	-	-
		W, see <sup>193</sup> Au	-	2E+5	1E-4	3E-7	-	1E-3
		Y, see <sup>193</sup> Au	-	2E+5	9E-5	3E-7	-	1E-2
80	Mercury-193m	Vapor	-	8E+3	4E-6	1E-8	-	-
		Organic D	4E+3	1E+4	5E-6	2E-8	6E-5	6E-4
		D, sulfates	3E+3	9E+3	4E-6	1E-8	4E-5	4E-4
		W, oxides, hydroxides, halides, nitrates, and sulfides	-	8E+3	3E-6	1E-8	-	-
80	Mercury-193	Vapor	-	3E+4	1E-5	4E-8	-	-
		Organic D	2E+4	6E+4	3E-5	9E-8	3E-4	3E-3
		D, see <sup>193m</sup> Hg	2E+4	4E+4	2E-5	6E-8	2E-4	2E-3
		W, see <sup>193m</sup> Hg	-	4E+4	2E-5	6E-8	-	-
80	Mercury-194	Vapor	-	3E+1	1E-8	4E-11	-	-
		Organic D	2E+1	3E+1	1E-8	4E-11	2E-7	2E-6
		D, see <sup>193m</sup> Hg	8E+2	4E+1	2E-8	6E-11	1E-5	1E-4
		W, see <sup>193m</sup> Hg	-	1E+2	5E-8	2E-10	-	-
80	Mercury-195m	Vapor	-	4E+3	2E-6	6E-9	-	-
		Organic D	3E+3	6E+3	3E-6	8E-9	4E-5	4E-4
		D, see <sup>193m</sup> Hg	2E+3	5E+3	2E-6	7E-9	3E-5	3E-4
		W, see <sup>193m</sup> Hg	-	4E+3	2E-6	5E-9	-	-
80	Mercury-195	Vapor	-	3E+4	1E-5	4E-8	-	-
		Organic D	2E+4	5E+4	2E-5	6E-8	2E-4	2E-3
		D, see <sup>193m</sup> Hg	1E+4	4E+4	1E-5	5E-8	2E-4	2E-3
		W, see <sup>193m</sup> Hg	-	3E+4	1E-5	5E-8	-	-
80	Mercury-197m	Vapor	-	5E+3	2E-6	7E-9	-	-
		Organic D	4E+3	9E+3	4E-6	1E-8	5E-5	5E-4
		D, see <sup>193m</sup> Hg	3E+3	7E+3	3E-6	1E-8	4E-5	4E-4
		W, see <sup>193m</sup> Hg	-	5E+3	2E-6	7E-9	-	-
80	Mercury-197	Vapor	-	8E+3	4E-6	1E-8	-	-
		Organic D	7E+3	1E+4	6E-6	2E-8	9E-5	9E-4
		D, see <sup>193m</sup> Hg	6E+3	1E+4	5E-6	2E-8	8E-5	8E-4
		W, see <sup>193m</sup> Hg	-	9E+3	4E-6	1E-8	-	-
80	Mercury-199m <sup>2</sup>	Vapor	-	8E+4	3E-5	1E-7	-	-
		Organic D	6E+4	2E+5	7E-5	2E-7	-	-
		St wall (1E+5)	-	-	-	-	1E-3	1E-2
		D, see <sup>193m</sup> Hg	6E+4	1E+5	6E-5	2E-7	8E-4	8E-3
80	Mercury-203	Vapor	-	8E+2	4E-7	1E-9	-	-
		Organic D	5E+2	8E+2	3E-7	1E-9	7E-6	7E-5
		D, see <sup>193m</sup> Hg	2E+3	1E+3	5E-7	2E-9	3E-5	3E-4
		W, see <sup>193m</sup> Hg	-	1E+3	5E-7	2E-9	-	-
81	Thallium-194m <sup>2</sup>	D, all compounds	5E+4	2E+5	6E-5	2E-7	-	-
81	Thallium-194 <sup>2</sup>	St wall (7E+4)	-	-	-	-	1E-3	1E-2
		D, all compounds	3E+5	6E+5	2E-4	8E-7	-	-
		St wall (3E+5)	-	-	-	-	4E-3	4E-2
81	Thallium-195 <sup>2</sup>	D, all compounds	6E+4	1E+5	5E-5	2E-7	9E-4	9E-3



81	Thallium-197	D, all compounds	7E+4	1E+5	5E-5	2E-7	1E-3	1E-2
81	Thallium-198m <sup>2</sup>	D, all compounds	3E+4	5E+4	2E-5	8E-8	4E-4	4E-3
81	Thallium-198	D, all compounds	2E+4	3E+4	1E-5	5E-8	3E-4	3E-3
81	Thallium-199	D, all compounds	6E+4	8E+4	4E-5	1E-7	9E-4	9E-3
81	Thallium-200	D, all compounds	8E+3	1E+4	5E-6	2E-8	1E-4	1E-3
81	Thallium-201	D, all compounds	2E+4	2E+4	9E-6	3E-8	2E-4	2E-3
81	Thallium-202	D, all compounds	4E+3	5E+3	2E-6	7E-9	5E-5	5E-4
81	Thallium-204	D, all compounds	2E+3	2E+3	9E-7	3E-9	2E-5	2E-4
82	Lead-195m <sup>2</sup>	D, all compounds	6E+4	2E+5	8E-5	3E-7	8E-4	8E-3
82	Lead-198	D, all compounds	3E+4	6E+4	3E-5	9E-8	4E-4	4E-3
82	Lead-199 <sup>2</sup>	D, all compounds	2E+4	7E+4	3E-5	1E-7	3E-4	3E-3
82	Lead-200	D, all compounds	3E+3	6E+3	3E-6	9E-9	4E-5	4E-4
82	Lead-201	D, all compounds	7E+3	2E+4	8E-6	3E-8	1E-4	1E-3
82	Lead-202m	D, all compounds	9E+3	3E+4	1E-5	4E-8	1E-4	1E-3
82	Lead-202	D, all compounds	1E+2	5E+1	2E-8	7E-11	2E-6	2E-5
82	Lead-203	D, all compounds	5E+3	9E+3	4E-6	1E-8	7E-5	7E-4
82	Lead-205	D, all compounds	4E+3	1E+3	6E-7	2E-9	5E-5	5E-4
82	Lead-209	D, all compounds	2E+4	6E+4	2E-5	8E-8	3E-4	3E-3
82	Lead-210	D, all compounds	6E-1	2E-1	1E-10	-	-	-
			Bone surf (1E+0)	Bone surf (4E-1)	-	6E-13	1E-8	1E-7
82	Lead-211 <sup>2</sup>	D, all compounds	1E+4	6E+2	3E-7	9E-10	2E-4	2E-3
82	Lead-212	D, all compounds	8E+1	3E+1	1E-8	5E-11	-	-
			Bone surf (1E+2)	-	-	-	2E-6	2E-5
82	Lead-214 <sup>2</sup>	D, all compounds	9E+3	8E+2	3E-7	1E-9	1E-4	1E-3
83	Bismuth-200 <sup>2</sup>	D, nitrates W, all other compounds	3E+4 -	8E+4 1E+5	4E-5 4E-5	1E-7 1E-7	4E-4 -	4E-3 -
83	Bismuth-201 <sup>2</sup>	D, see <sup>200</sup> Bi W, see <sup>200</sup> Bi	1E+4 -	3E+4 4E+4	1E-5 2E-5	4E-8 5E-8	2E-4 -	2E-3 -
83	Bismuth-202 <sup>2</sup>	D, see <sup>200</sup> Bi W, see <sup>200</sup> Bi	1E+4 -	4E+4 8E+4	2E-5 3E-5	6E-8 1E-7	2E-4 -	2E-3 -
83	Bismuth-203	D, see <sup>200</sup> Bi W, see <sup>200</sup> Bi	2E+3 -	7E+3 6E+3	3E-6 3E-6	9E-9 9E-9	3E-5 -	3E-4 -
83	Bismuth-205	D, see <sup>200</sup> Bi W, see <sup>200</sup> Bi	1E+3 -	3E+3 1E+3	1E-6 5E-7	3E-9 2E-9	2E-5 -	2E-4 -
83	Bismuth-206	D, see <sup>200</sup> Bi W, see <sup>200</sup> Bi	6E+2 -	1E+3 9E+2	6E-7 4E-7	2E-9 1E-9	9E-6 -	9E-5 -
83	Bismuth-207	D, see <sup>200</sup> Bi W, see <sup>200</sup> Bi	1E+3 -	2E+3 4E+2	7E-7 1E-7	2E-9 5E-10	1E-5 -	1E-4 -
83	Bismuth-210m	D, see <sup>200</sup> Bi	4E+1	5E+0	2E-9	-	-	-
			Kidneys (6E+1)	Kidneys (6E+0)	-	9E-12	8E-7	8E-6
		W, see <sup>200</sup> Bi	-	7E-1	3E-10	9E-13	-	-
83	Bismuth-210	D, see <sup>200</sup> Bi	8E+2	2E+2	1E-7	-	1E-5	1E-4
			-	Kidneys (4E+2)	-	5E-10	-	-
		W, see <sup>200</sup> Bi	-	3E+1	1E-8	4E-11	-	-
83	Bismuth-212 <sup>2</sup>	D, see <sup>200</sup> Bi W, see <sup>200</sup> Bi	5E+3 -	2E+2 3E+2	1E-7 1E-7	3E-10 4E-10	7E-5 -	7E-4 -
83	Bismuth-213 <sup>2</sup>	D, see <sup>200</sup> Bi W, see <sup>200</sup> Bi	7E+3 -	3E+2 4E+2	1E-7 1E-7	4E-10 5E-10	1E-4 -	1E-3 -
83	Bismuth-214 <sup>2</sup>	D, see <sup>200</sup> Bi	2E+4	8E+2	3E-7	1E-9	-	-
			St wall (2E+4)	-	-	-	3E-4	3E-3
		W, see <sup>200</sup> Bi	-	9E-2	4E-7	1E-9	-	-
84	Polonium-203 <sup>2</sup>	D, all compounds except	-	-	-	-	-	-

## Radiation Protection Standards

246-221-290

		those given for W	3E+4	6E+4	3E-5	9E-8	3E-4	3E-3
		W, oxides, hydroxides, and nitrates	-	9E+4	4E-5	1E-7	-	-
84	Polonium-205 <sup>2</sup>	D, see <sup>203</sup> Po W, see <sup>203</sup> Po	2E+4 -	4E+4 7E+4	2E-5 3E-5	5E-8 1E-7	3E-4 -	3E-3 -
84	Polonium-207	D, see <sup>203</sup> Po W, see <sup>203</sup> Po	8E+3 -	3E+4 3E+4	1E-5 1E-5	3E-8 4E-8	1E-4 -	1E-3 -
84	Polonium-210	D, see <sup>203</sup> Po W, see <sup>203</sup> Po	3E+0 -	6E-1 6E-1	3E-10 3E-10	9E-13 9E-13	4E-8 -	4E-7 -
85	Astatine-207 <sup>2</sup>	D, halides W	6E+3 -	3E+3 2E+3	1E-6 9E-7	4E-9 3E-9	8E-5 -	8E-4 -
85	Astatine-211	D, halides W	1E+2 -	8E+1 5E+1	3E-8 2E-8	1E-10 8E-11	2E-6 -	2E-5 -
86	Radon-220	With daughters removed With daughters present	- -	2E+4 2E+1 (or 12 working level months)	7E-6 9E-9	2E-8 3E-11 (or 1.0 working level)	- -	- -
86	Radon-222	With daughters removed With daughters present	- -	1E+4 1E+2 (or 4 working level months)	4E-6 3E-8	1E-8 1E-10 (or 0.33 working level)	- -	- -
87	Francium-222 <sup>2</sup>	D, all compounds	2E+3	5E+2	2E-7	6E-10	3E-5	3E-4
87	Francium-223 <sup>2</sup>	D, all compounds	6E+2	8E+2	3E-7	1E-9	8E-6	8E-5
88	Radium-223	W, all compounds	5E+0 Bone surf (9E+0)	7E-1 -	3E-10 -	9E-13 -	- 1E-7	- 1E-6
88	Radium-224	W, all compounds	8E+0 Bone surf (2E+1)	2E+0 -	7E-10 -	2E-12 -	- 2E-7	- 2E-6
88	Radium-225	W, all compounds	8E+0 Bone surf (2E+1)	7E-1 -	3E-10 -	9E-13 -	- 2E-7	- 2E-6
88	Radium-226	W, all compounds	2E+0 Bone surf (5E+0)	6E-1 -	3E-10 -	9E-13 -	- 6E-8	- 6E-7
88	Radium-227 <sup>2</sup>	W, all compounds	2E+4 Bone surf (2E+4)	1E+4 Bone surf (2E+4)	6E-6 -	- 3E-8	- 3E-4	- 3E-3
88	Radium-228	W, all compounds	2E+0 Bone surf (4E+0)	1E+0 -	5E-10 -	2E-12 -	- 6E-8	- 6E-7
89	Actinium-224	D, all compounds except those given for W and Y	2E+3 LLI wall (2E+3)	3E+1 Bone surf (4E+1)	1E-8 -	- 5E-11	- 3E-5	- 3E-4
		W, halides and nitrates Y, oxides and hydroxides	- -	5E+1 5E+1	2E-8 2E-8	7E-11 6E-11	- -	- -
89	Actinium-225	D, see <sup>224</sup> Ac	5E+1 LLI wall (5E+1)	3E-1 Bone surf (5E-1)	1E-10 -	- 7E-13	- 7E-7	- 7E-6
		W, see <sup>224</sup> Ac Y, see <sup>224</sup> Ac	- -	6E-1 6E-1	3E-10 3E-10	9E-13 9E-13	- -	- -
89	Actinium-226	D, see <sup>224</sup> Ac	1E+2 LLI wall (1E+2)	3E+0 Bone surf (4E+0)	1E-9 -	- 5E-12	- 2E-6	- 2E-5
		W, see <sup>224</sup> Ac Y, see <sup>224</sup> Ac	- -	5E+0 5E+0	2E-9 2E-9	7E-12 6E-12	- -	- -



## Radiation Protection Standards

246-221-290

				(6E+1)		8E-11		
	Y, see <sup>227</sup> Pa			6E+1	2E-8			
				Bone surf				
				(7E+1)		1E-10		
91	Protactinium-233	W, see <sup>227</sup> Pa	1E+3	7E+2	3E-7	1E-9		
			LLI wall					
			(2E+3)				2E-5	2E-4
	Y, see <sup>227</sup> Pa			6E+2	2E-7	8E-10		
91	Protactinium-234	W, see <sup>227</sup> Pa	2E+3	8E+3	3E-6	1E-8	3E-5	3E-4
	Y, see <sup>227</sup> Pa			7E+3	3E-6	9E-9		
92	Uranium-230	D, UF <sub>6</sub> , UO <sub>2</sub> F <sub>2</sub> , UO <sub>2</sub> (NO <sub>3</sub> ) <sub>2</sub>	4E+0	4E-1	2E-10			
			Bone surf	Bone surf				
			(6E+0)	(6E-1)		8E-13	8E-8	8E-7
	W, UO <sub>3</sub> , UF <sub>4</sub> , UCl <sub>4</sub>			4E-1	1E-10	5E-13		
	Y, UO <sub>2</sub> , U <sub>3</sub> O <sub>8</sub>			3E-1	1E-10	4E-13		
92	Uranium-231	D, see <sup>230</sup> U	5E+3	8E+3	3E-6	1E-8		
			LLI wall					
			(4E+3)				6E-5	6E-4
	W, see <sup>230</sup> U			6E+3	2E-6	8E-9		
	Y, see <sup>230</sup> U			5E+3	2E-6	6E-9		
92	Uranium-232	D, see <sup>230</sup> U	2E+0	2E-1	9E-11			
			Bone surf	Bone surf				
			(4E+0)	(4E-1)		6E-13	6E-8	6E-7
	W, see <sup>230</sup> U			4E-1	2E-10	5E-13		
	Y, see <sup>230</sup> U			8E-3	3E-12	1E-14		
92	Uranium-233	D, see <sup>230</sup> U	1E+1	1E+0	5E-10			
			Bone surf	Bone surf				
			(2E+1)	(2E+0)		3E-12	3E-7	3E-6
	W, see <sup>230</sup> U			7E-1	3E-10	1E-12		
	Y, see <sup>230</sup> U			4E-2	2E-11	5E-14		
92	Uranium-234 <sup>3</sup>	D, see <sup>230</sup> U	1E+1	1E+0	5E-10			
			Bone surf	Bone surf				
			(2E+1)	(2E+0)		3E-12	3E-7	3E-6
	W, see <sup>230</sup> U			7E-1	3E-10	1E-12		
	Y, see <sup>230</sup> U			4E-2	2E-11	5E-14		
92	Uranium-235 <sup>3</sup>	D, see <sup>230</sup> U	1E+1	1E+0	6E-10			
			Bone surf	Bone surf				
			(2E+1)	(2E+0)		3E-12	3E-7	3E-6
	W, see <sup>230</sup> U			8E-1	3E-10	1E-12		
	Y, see <sup>230</sup> U			4E-2	2E-11	6E-14		
92	Uranium-236	D, see <sup>230</sup> U	1E+1	1E+0	5E-10			
			Bone surf	Bone surf				
			(2E+1)	(2E+0)		3E-12	3E-7	3E-6
	W, see <sup>230</sup> U			8E-1	3E-10	1E-12		
	Y, see <sup>230</sup> U			4E-2	2E-11	6E-14		
92	Uranium-237	D, see <sup>230</sup> U	2E+3	3E+3	1E-6	4E-9		
			LLI wall					
			(2E+3)				3E-5	3E-4
	W, see <sup>230</sup> U			2E+3	7E-7	2E-9		
	Y, see <sup>230</sup> U			2E+3	6E-7	2E-9		
92	Uranium-238 <sup>3</sup>	D, see <sup>230</sup> U	1E+1	1E+0	6E-10			
			Bone surf	Bone surf				
			(2E+1)	(2E+0)		3E-12	3E-7	3E-6
	W, see <sup>230</sup> U			8E-1	3E-10	1E-12		
	Y, see <sup>230</sup> U			4E-2	2E-11	6E-14		
92	Uranium-239 <sup>2</sup>	D, see <sup>230</sup> U	7E+4	2E+5	8E-5	3E-7	9E-4	9E-3
	W, see <sup>230</sup> U			2E+5	7E-5	2E-7		
	Y, see <sup>230</sup> U			2E+5	6E-5	2E-7		
92	Uranium-240	D, see <sup>230</sup> U	1E+3	4E+3	2E-6	5E-9	2E-5	2E-4
	W, see <sup>230</sup> U			3E+3	1E-6	4E-9		
	Y, see <sup>230</sup> U			2E+3	1E-6	3E-9		
92	Uranium-natural <sup>3</sup>	D, see <sup>230</sup> U	1E+1	1E+0	5E-10			
			Bone surf	Bone surf				
			(2E+1)	(2E+0)		3E-12	3E-7	3E-6
	W, see <sup>230</sup> U			8E-1	3E-10	9E-13		
	Y, see <sup>230</sup> U			5E-2	2E-11	9E-14		
93	Neptunium-232 <sup>2</sup>	W, all compounds	1E+5	2E+3	7E-7		2E-3	2E-2

				Bone surf (5E+2)		6E-9		
93	Neptunium-233 <sup>2</sup>	W, all compounds	8E+5	3E+6	1E-3	4E-6	1E-2	1E-1
93	Neptunium-234	W, all compounds	2E+3	3E+3	1E-6	4E-9	3E-5	3E-4
93	Neptunium-235	W, all compounds	2E+4	8E+2	3E-7	-	-	-
			LLI wall (2E+4)	Bone surf (1E+3)	-	2E-9	3E-4	3E-3
93	Neptunium-236 (1.15E+5 y)	W, all compounds	3E+0	2E-2	9E-12	-	-	-
			Bone surf (6E+0)	Bone surf (5E-2)	-	8E-14	9E-8	9E-7
93	Neptunium-236 (22.5 h)	W, all compounds	3E+3	3E+1	1E-8	-	-	-
			Bone surf (4E+3)	Bone surf (7E+1)	-	1E-10	5E-5	5E-4
93	Neptunium-237	W, all compounds	5E-1	4E-3	2E-12	-	-	-
			Bone surf (1E+0)	Bone surf (1E-2)	-	1E-14	2E-8	2E-7
93	Neptunium-238	W, all compounds	1E+3	6E+1	3E-8	-	2E-5	2E-4
			-	Bone surf (2E+2)	-	2E-10	-	-
93	Neptunium-239	W, all compounds	2E+3	2E+3	9E-7	3E-9	-	-
			LLI wall (2E+3)	-	-	-	2E-5	2E-4
93	Neptunium-240 <sup>2</sup>	W, all compounds	2E+4	8E+4	3E-5	1E-7	3E-4	3E-3
94	Plutonium-234	W, all compounds except PuO <sub>2</sub> Y, PuO <sub>2</sub>	8E+3	2E+2	9E-8	3E-10	1E-4	1E-3
			-	2E+2	8E-8	3E-10	-	-
94	Plutonium-235 <sup>2</sup>	W, see <sup>234</sup> Pu Y, see <sup>234</sup> Pu	9E+5	3E+6	1E-3	4E-6	1E-2	1E-1
			-	3E+6	1E-3	3E-6	-	-
94	Plutonium-236	W, see <sup>234</sup> Pu	2E+0	2E-2	8E-12	-	-	-
			Bone surf (4E+0)	Bone surf (4E-2)	-	5E-14	6E-8	6E-7
		Y, see <sup>234</sup> Pu	-	4E-2	2E-11	6E-14	-	-
94	Plutonium-237	W, see <sup>234</sup> Pu Y, see <sup>234</sup> Pu	1E+4	3E+3	1E-6	5E-9	2E-4	2E-3
			-	3E+3	1E-6	4E-9	-	-
94	Plutonium-238	W, see <sup>234</sup> Pu	9E-1	7E-3	3E-12	-	-	-
			Bone surf (2E+0)	Bone surf (1E-2)	-	2E-14	2E-8	2E-7
		Y, see <sup>234</sup> Pu	-	2E-2	8E-12	2E-14	-	-
94	Plutonium-239	W, see <sup>234</sup> Pu	8E-1	6E-3	3E-12	-	-	-
			Bone surf (1E+0)	Bone surf (1E-2)	-	2E-14	2E-8	2E-7
		Y, see <sup>234</sup> Pu	-	2E-2	7E-12	-	-	-
			-	Bone surf (2E-2)	-	2E-14	-	-
94	Plutonium-240	W, see <sup>234</sup> Pu	8E-1	6E-3	3E-12	-	-	-
			Bone surf (1E+0)	Bone surf (1E-2)	-	2E-14	2E-8	2E-7
		Y, see <sup>234</sup> Pu	-	2E-2	7E-12	-	-	-
			-	Bone surf (2E-2)	-	2E-14	-	-
94	Plutonium-241	W, see <sup>234</sup> Pu	4E+1	3E-1	1E-10	-	-	-
			Bone surf (7E+1)	Bone surf (6E-1)	-	8E-13	1E-6	1E-5
		Y, see <sup>234</sup> Pu	-	8E-1	3E-10	-	-	-
			-	Bone surf (1E+0)	-	1E-12	-	-
94	Plutonium-242	W, see <sup>234</sup> Pu	8E-1	7E-3	3E-12	-	-	-
			Bone surf (1E+0)	Bone surf (1E-2)	-	2E-14	2E-8	2E-7
		Y, see <sup>234</sup> Pu	-	2E-2	7E-12	-	-	-
			-	Bone surf (2E-2)	-	2E-14	-	-
94	Plutonium-243	W, see <sup>234</sup> Pu Y, see <sup>234</sup> Pu	2E+4	4E+4	2E-5	5E-8	2E-4	2E-3
			-	4E+4	2E-5	5E-8	-	-
94	Plutonium-244	W, see <sup>234</sup> Pu	8E-1	7E-3	3E-12	-	-	-

		Y, see $^{234}\text{Pu}$	Bone surf (2E+0)	Bone surf (1E-2)	-	2E-14	2E-8	2E-7
			-	2E-2	7E-12	-	-	-
			-	Bone surf (2E-2)	-	2E-14	-	-
94	Plutonium-245	W, see $^{234}\text{Pu}$ Y, see $^{234}\text{Pu}$	2E+3	5E+3	2E-6	6E-9	3E-5	3E-4
			-	4E+3	2E-6	6E-9	-	-
94	Plutonium-246	W, see $^{234}\text{Pu}$	4E+2	3E+2	1E-7	4E-10	-	-
			LLI wall (4E+2)	-	-	-	6E-6	6E-5
		Y, see $^{234}\text{Pu}$	-	3E+2	1E-7	4E-10	-	-
95	Americium-237 <sup>2</sup>	W, all compounds	8E+4	3E+5	1E-4	4E-7	1E-3	1E-2
95	Americium-238 <sup>2</sup>	W, all compounds	4E+4	3E+3	1E-6	-	5E-4	5E-3
			-	Bone surf (6E+3)	-	9E-9	-	-
95	Americium-239	W, all compounds	5E+3	1E+4	5E-6	2E-8	7E-5	7E-4
95	Americium-240	W, all compounds	2E+3	3E+3	1E-6	4E-9	3E-5	3E-4
95	Americium-241	W, all compounds	8E-1	6E-3	3E-12	-	-	-
			Bone surf (1E+0)	Bone surf (1E-2)	-	2E-14	2E-8	2E-7
95	Americium-242m	W, all compounds	8E-1	6E-3	3E-12	-	-	-
			Bone surf (1E+0)	Bone surf (1E-2)	-	2E-14	2E-8	2E-7
95	Americium-242	W, all compounds	4E+3	8E+1	4E-8	-	5E-5	5E-4
			-	Bone surf (9E+1)	-	1E-10	-	-
95	Americium-243	W, all compounds	8E-1	6E-3	3E-12	-	-	-
			Bone surf (1E+0)	Bone surf (1E-2)	-	2E-14	2E-8	2E-7
95	Americium-244m <sup>2</sup>	W, all compounds	6E+4	4E+3	2E-6	-	-	-
			St wall (8E+4)	Bone surf (7E+3)	-	1E-8	1E-3	1E-2
95	Americium-244	W, all compounds	3E+3	2E+2	8E-8	-	4E-5	4E-4
			-	Bone surf (3E+2)	-	4E-10	-	-
95	Americium-245	W, all compounds	3E+4	8E+4	3E-5	1E-7	4E-4	4E-3
95	Americium-246m <sup>2</sup>	W, all compounds	5E+4	2E+5	8E-5	3E-7	-	-
			St wall (6E+4)	-	-	-	8E-4	8E-3
95	Americium-246 <sup>2</sup>	W, all compounds	3E+4	1E+5	4E-5	1E-7	4E-4	4E-3
96	Curium-238	W, all compounds	2E+4	1E+3	5E-7	2E-9	2E-4	2E-3
96	Curium-240	W, all compounds	6E+1	6E-1	2E-10	-	-	-
			Bone surf (8E+1)	Bone surf (6E-1)	-	9E-13	1E-6	1E-5
96	Curium-241	W, all compounds	1E+3	3E+1	1E-8	-	2E-5	2E-4
			-	Bone surf (4E+1)	-	5E-11	-	-
96	Curium-242	W, all compounds	3E+1	3E-1	1E-10	-	-	-
			Bone surf (5E+1)	Bone surf (3E-1)	-	4E-13	7E-7	7E-6
96	Curium-243	W, all compounds	1E+0	9E-3	4E-12	-	-	-
			Bone surf (2E+0)	Bone surf (2E-2)	-	2E-14	3E-8	3E-7
96	Curium-244	W, all compounds	1E+0	1E-2	5E-12	-	-	-
			Bone surf (3E+0)	Bone surf (2E-2)	-	3E-14	3E-8	3E-7
96	Curium-245	W, all compounds	7E-1	6E-3	3E-12	-	-	-
			Bone surf (1E+0)	Bone surf (1E-2)	-	2E-14	2E-8	2E-7
96	Curium-246	W, all compounds	7E-1	6E-3	3E-12	-	-	-
			Bone surf (1E+0)	Bone surf (1E-2)	-	2E-14	2E-8	2E-7

96	Curium-247	W, all compounds	8E-1 Bone surf (1E+0)	6E-3 Bone surf (1E-2)	3E-12 -	- 2E-14	- 2E-8	- 2E-7
96	Curium-248	W, all compounds	2E-1 Bone surf (4E-1)	2E-3 Bone surf (3E-3)	7E-13 -	- 4E-15	- 5E-9	- 5E-8
96	Curium-249 <sup>2</sup>	W, all compounds	5E+4 -	2E+4 Bone surf (3E+4)	7E-6 -	- 4E-8	7E-4 -	7E-3 -
96	Curium-250	W, all compounds	4E-2 Bone surf (6E-2)	3E-4 Bone surf (5E-4)	1E-13 -	- 8E-16	- 9E-10	- 9E-9
97	Berkelium-245	W, all compounds	2E+3	1E+3	5E-7	2E-9	3E-5	3E-4
97	Berkelium-246	W, all compounds	3E+3	3E+3	1E-6	4E-9	4E-5	4E-4
97	Berkelium-247	W, all compounds	5E-1 Bone surf (1E+0)	4E-3 Bone surf (9E-3)	2E-12 -	- 1E-14	- 2E-8	- 2E-7
97	Berkelium-249	W, all compounds	2E+2 Bone surf (5E+2)	2E+0 Bone surf (4E+0)	7E-10 -	- 5E-12	- 6E-6	- 6E-5
97	Berkelium-250	W, all compounds	9E+3 -	3E+2 Bone surf (7E+2)	1E-7 -	- 1E-9	1E-4 -	1E-3 -
98	Californium-244 <sup>2</sup>	W, all compounds except those given for Y	3E+4 St wall (3E+4)	6E+2 -	2E-7 -	8E-10 -	- 4E-4	- 4E-3
		Y, oxides and hydroxides	-	6E+2	2E-7	8E-10	-	-
98	Californium-246	W, see <sup>244</sup> Cf Y, see <sup>244</sup> Cf	4E+2 -	9E+0 9E+0	4E-9 4E-9	1E-11 1E-11	5E-6 -	5E-5 -
98	Californium-248	W, see <sup>244</sup> Cf	8E+0 Bone surf (2E+1)	6E-2 Bone surf (1E-1)	3E-11 -	- 2E-13 1E-13	- 2E-7 -	- 2E-6 -
		Y, see <sup>244</sup> Cf	-	1E-1	4E-11	1E-13	-	-
98	Californium-249	W, see <sup>244</sup> Cf	5E-1 Bone surf (1E+0)	4E-3 Bone surf (9E-3)	2E-12 -	- 1E-14	- 2E-8	- 2E-7
		Y, see <sup>244</sup> Cf	-	1E-2 Bone surf (1E-2)	4E-12 -	- 2E-14	- -	- -
98	Californium-250	W, see <sup>244</sup> Cf	1E+0 Bone surf (2E+0)	9E-3 Bone surf (2E-2)	4E-12 -	- 3E-14 4E-14	- 3E-8 -	- 3E-7 -
		Y, see <sup>244</sup> Cf	-	3E-2	1E-11	4E-14	-	-
98	Californium-251	W, see <sup>244</sup> Cf	5E-1 Bone surf (1E+0)	4E-3 Bone surf (9E-3)	2E-12 -	- 1E-14	- 2E-8	- 2E-7
		Y, see <sup>244</sup> Cf	-	1E-2 Bone surf (1E-2)	4E-12 -	- 2E-14	- -	- -
98	Californium-252	W, see <sup>244</sup> Cf	2E+0 Bone surf (5E+0)	2E-2 Bone surf (4E-2)	8E-12 -	- 5E-14 5E-14	- 7E-8 -	- 7E-7 -
		Y, see <sup>244</sup> Cf	-	3E-2	1E-11	5E-14	-	-
98	Californium-253	W, see <sup>244</sup> Cf	2E+2 Bone surf (4E+2)	2E+0 -	8E-10 -	3E-12 -	- 5E-6	- 5E-5
		Y, see <sup>244</sup> Cf	-	2E+0	7E-10	2E-12	-	-
98	Californium-254	W, see <sup>244</sup> Cf Y, see <sup>244</sup> Cf	2E+0 -	2E-2 2E-2	9E-12 7E-12	3E-14 2E-14	3E-8 -	3E-7 -
99	Einsteinium-250	W, all compounds	4E+4 -	5E+2 Bone surf (1E+3)	2E-7 -	- 2E-9	6E-4 -	6E-3 -
99	Einsteinium-251	W, all compounds	7E+3	9E+2 Bone surf	4E-7	-	1E-4	1E-3



Radiation Protection Standards

246-221-290

				(1E+3)		2E-9		
99	Einsteinium-253	W, all compounds	2E+2	1E+0	6E-10	2E-12	2E-6	2E-5
99	Einsteinium-254m	W, all compounds	3E+2	1E+1	4E-9	1E-11	-	-
			LLI wall (3E+2)	-	-	-	4E-6	4E-5
99	Einsteinium-254	W, all compounds	8E+0	7E-2	3E-11	-	-	-
			Bone surf (2E+1)	Bone surf (1E-1)	-	2E-13	2E-7	2E-6
100	Fermium-252	W, all compounds	5E+2	1E+1	5E-9	2E-11	6E-6	6E-5
100	Fermium-253	W, all compounds	1E+3	1E+1	4E-9	1E-11	1E-5	1E-4
100	Fermium-254	W, all compounds	3E+3	9E+1	4E-8	1E-10	4E-5	4E-4
100	Fermium-255	W, all compounds	5E+2	2E+1	9E-9	3E-11	7E-6	7E-5
100	Fermium-257	W, all compounds	2E+1	2E-1	7E-11	-	-	-
			Bone surf (4E+1)	Bone surf (2E-1)	-	3E-13	5E-7	5E-6
101	Mendelevium-257	W, all compounds	7E+3	8E+1	4E-8	-	1E-4	1E-3
			-	Bone surf (9E+1)	-	1E-10	-	-
101	Mendelevium-258	W, all compounds	3E+1	2E-1	1E-10	-	-	-
			Bone surf (5E+1)	Bone surf (3E-1)	-	5E-13	6E-7	6E-6
-	Any single radionuclide not listed above with decay mode other than alpha emission or spontaneous fission and with radioactive half-life less than 2 hours		Submersion <sup>1</sup>	2E+2	1E-7	1E-9	-	-
-	Any single radionuclide not listed above with decay mode other than alpha emission or spontaneous fission and with radioactive half-life greater than 2 hours		....	2E-1	1E-10	1E-12	1E-8	1E-7
-	Any single radionuclide not listed above that decays by alpha emission or spontaneous fission, or any mixture for which either the identity or the concentration of any radionuclide in the mixture is not known		....	4E-4	2E-13	1E-15	2E-9	2E-8

FOOTNOTES:

<sup>1</sup>"Submersion" means that values given are for submersion in a hemispherical semi-infinite cloud of airborne material.

<sup>2</sup>These radionuclides have radiological half-lives of less than 2 hours. The total effective dose equivalent received during operations with these radionuclides might include a significant contribution from external exposure. The DAC values for all radionuclides, other than those designated Class "Submersion," are based upon the committed effective dose equivalent due to the intake of the radionuclide into the body and do NOT include potentially significant contributions to dose equivalent from external exposures. The licensee may substitute 1E-7 µCi/ml for the listed DAC to account for the submersion dose prospectively, but should use individual monitoring devices or other radiation measuring instruments that measure external exposure to demonstrate compliance with the limits. (See WAC 246-221-015(5).)

<sup>3</sup>For soluble mixtures of U-238, U-234, and U-235 in air, chemical toxicity may be the limiting factor (see WAC 246-221-010(5)). If the percent by weight (enrichment) of U-235 is not greater than 5, the concentration value for a 40-hour workweek is 0.2 milligrams uranium per cubic meter of air average. For any enrichment, the product of the average concentration and time of exposure during a 40-hour workweek shall not exceed 8E-3 (SA) µCi-hr/ml, where SA is the specific activity of the uranium inhaled. The specific activity for natural uranium is 6.77E-7 curies per gram U. The specific activity for other mixtures of U-238, U-235, and U-234, if not known, shall be:

$$SA = 3.6E-7 \text{ curies/gram U, U-depleted}$$

$$SA = [0.4 + 0.38 (\text{enrichment}) + 0.0034 (\text{enrichment})^2] E-6, \text{ enrichment} \geq 0.72$$

where enrichment is the percentage by weight of U-235, expressed as percent.

NOTE:

1. If the identity of each radionuclide in a mixture is known but the concentration of one or more of the radionuclides in the mixture is not known, the DAC for the mixture shall be the most restrictive DAC of any radionuclide in the mixture.
2. If the identity of each radionuclide in the mixture is not known, but it is known that certain radionuclides specified in this appendix are not present in the mixture, the inhalation ALI, DAC, and effluent and sewage concentrations for the mixture are the lowest values specified in this appendix for any radionuclide that is not known to be absent from the mixture; or

If it is known that Ac-227-D and Cm-250-W are not present	-	7E-4	3E-13	-	-	-
If, in addition, it is known that Ac-227-W,Y, Th-229-W,Y, Th-230-W, Th-232-W,Y, Pa-231-W,Y, Np-237-W, Pu-239-W, Pu-240-W, Pu-242-W, Am-241-W, Am-242m-W, Am-243-W, Cm-245-W, Cm-246-W, Cm-247-W, Cm-248-W, Bk-247-W, Cf-249-W, and Cf-251-W are not present	-	7E-3	3E-12	-	-	-
If, in addition, it is known that Sm-146-W, Sm-147-W, Gd-148-D,W, Gd-152-D,W, Th-228-W,Y, Th-230-Y, U-232-Y, U-233-Y, U-234-Y, U-235-Y, U-236-Y, U-238-Y, Np-236-W, Pu-236-W,Y, Pu-238-W,Y, Pu-239-Y, Pu-240-Y, Pu-242-Y, Pu-244-W,Y, Cm-243-W, Cm-244-W, Cf-248-W, Cf-249-Y, Cf-250-W,Y, Cf-251-Y, Cf-252-W,Y, and Cf-254-W,Y are not present	-	7E-2	3E-11	-	-	-
If, in addition, it is known that Pb-210-D, Bi-210m-W, Po-210-D,W, Ra-223-W, Ra-225-W, Ra-226-W, Ac-225-D,W,Y, Th-227-W,Y, U-230-D,W,Y, U-232-D,W, Pu-241-W, Cm-240-W, Cm-242-W, Cf-248-Y, Es-254-W, Fm-257-W, and Md-258-W are not present	-	7E-1	3E-10	-	-	-
If, in addition, it is known that Si-32-Y, Ti-44-Y, Fe-60-D, Sr-90-Y, Zr-93-D, Cd-113m-D, Cd-113-D, In-115-D,W, La-138-D, Lu-176-W, Hf-178m-D,W, Hf-182-D,W, Bi-210m-D, Ra-224-W, Ra-228-W, Ac-226-D,W,Y, Pa-230-W,Y, U-233-D,W, U-234-D,W, U-235-D,W, U-236-D,W, U-238-D,W, Pu-241-Y, Bk-249-W, Cf-253-W,Y, and Es-253-W are not present	-	7E+0	3E-9	-	-	-
If it is known that Ac-227-D,W,Y, Th-229-W,Y, Th-232-W,Y, Pa-231-W,Y, Cm-248-W, and Cm-250-W are not present	-	-	-	-	1E-14	-
If, in addition, it is known that Sm-146-W, Gd-148-D,W, Gd-152-D, Th-228-W,Y, Th-230-W,Y, U-232-Y, U-233-Y, U-234-Y, U-235-Y, U-236-Y, U-238-Y, U-Nat-Y, Np-236-W, Np-237-W, Pu-236-W,Y, Pu-238-W,Y, Pu-239-W,Y, Pu-240-W,Y, Pu-242-W,Y, Pu-244-W,Y, Am-241-W, Am-242m-W, Am-243-W, Cm-243-W, Cm-244-W, Cm-245-W, Cm-246-W, Cm-247-W, Bk-247-W, Cf-249-W,Y, Cf-250-W,Y, Cf-251-W,Y, Cf-252-W,Y, and Cf-254-W,Y are not present	-	-	-	-	1E-13	-
If, in addition, it is known that Sm-147-W, Gd-152-W, Pb-210-D, Bi-210m-W, Po-210-D,W, Ra-223-W, Ra-225-W, Ra-226-W, Ac-225-D,W,Y, Th-227-W,Y, U-230-D,W,Y, U-232-D,W, U-Nat-W, Pu-241-W, Cm-240-W, Cm-242-W, Cf-248-W,Y, Es-254-W, Fm-257-W, and Md-258-W are not present	-	-	-	-	-	1E-12
If, in addition it is known that Fe-60, Sr-90, Cd-113m, Cd-113, In-115, I-129, Cs-134, Sm-145, Sm-147, Gd-148, Gd-152, Hg-194 (organic), Bi-210m, Ra-223, Ra-224, Ra-225, Ac-225, Th-228, Th-230, U-233, U-234, U-235, U-236, U-238, U-Nat, Cm-242, Cf-248, Es-254, Fm-257, and Md-258 are not present	-	-	-	-	1E-6	1E-5

3. If a mixture of radionuclides consists of uranium and its daughters in ore dust (10 µm AMAD particle distribution assumed) prior to chemical separation of the uranium from the ore, the following values may be used for the DAC of the mixture: 6E-11 µCi of gross alpha activity from uranium-238, uranium-234, thorium-230, and radium-226 per milliliter of air; 3E-11 µCi of natural uranium per milliliter of air; or 45 micrograms of natural uranium per cubic meter of air.

4. If the identity and concentration of each radionuclide in a mixture are known, the limiting values should be derived as follows: Determine, for each radionuclide in the mixture, the ratio between the concentration present in the mixture and the concentration otherwise established in this section for the specific radionuclide when not in a mixture. The sum of such ratios for all of the radionuclides in the mixture may not exceed "1" (i.e., "unity").

Example: If radionuclides "A," "B," and "C" are present in concentrations CA, CB, and CC, and if the applicable DACs are DAC<sub>A</sub>, DAC<sub>B</sub>, and DAC<sub>C</sub> respectively, then the concentrations shall be limited so that the following relationship exists:

$$\frac{C_A}{DAC_A} + \frac{C_B}{DAC_B} + \frac{C_C}{DAC_C} \leq 1$$



Californium-252	0.001	Einsteinium-251	100
Californium-253	0.1	Einsteinium-253	0.1
Californium-254	0.001	Einsteinium-254	0.01
Carbon-11	1,000	Einsteinium-254m	1
Carbon-14	1,000	Erbium-161	1,000
Cerium-134	100	Erbium-165	1,000
Cerium-135	100	Erbium-169	100
Cerium-137	1,000	Erbium-171	100
Cerium-137m	100	Erbium-172	100
Cerium-139	100	Europium-145	100
Cerium-141	100	Europium-146	100
Cerium-143	100	Europium-147	100
Cerium-144	1	Europium-148	10
Cesium-125	1,000	Europium-149	100
Cesium-127	1,000	Europium-150 (12.62h)	100
Cesium-129	1,000	Europium-150 (34.2y)	1
Cesium-130	1,000	Europium-152	1
Cesium-131	1,000	Europium-152m	100
Cesium-132	100	Europium-154	1
Cesium-134	10	Europium-155	10
Cesium-134m	1,000	Europium-156	100
Cesium-135	100	Europium-157	100
Cesium-135m	1,000	Europium-158	1,000
Cesium-136	10	Fermium-252	1
Cesium-137	10	Fermium-253	1
Cesium-138	1,000	Fermium-254	10
Chlorine-36	10	Fermium-255	1
Chlorine-38	1,000	Fermium-257	0.01
Chlorine-39	1,000	Fluorine-18	1,000
Chromium-48	1,000	Francium-222	100
Chromium-49	1,000	Francium-223	100
Chromium-51	1,000	Gadolinium-145	1,000
Cobalt-55	100	Gadolinium-146	10
Cobalt-56	10	Gadolinium-147	100
Cobalt-57	100	Gadolinium-148	0.001
Cobalt-58	100	Gadolinium-149	100
Cobalt-58m	1,000	Gadolinium-151	10
Cobalt-60	1	Gadolinium-152	100
Cobalt-60m	1,000	Gadolinium-153	10
Cobalt-61	1,000	Gadolinium-159	100
Cobalt-62m	1,000	Gallium-65	1,000
Copper-60	1,000	Gallium-66	100
Copper-61	1,000	Gallium-67	1,000
Copper-64	1,000	Gallium-68	1,000
Copper-67	1,000	Gallium-70	1,000
Curium-238	100	Gallium-72	100
Curium-240	0.1	Gallium-73	1,000
Curium-241	1	Germanium-66	1,000
Curium-242	0.01	Germanium-67	1,000
Curium-243	0.001	Germanium-68	10
Curium-244	0.001	Germanium-69	1,000
Curium-245	0.001	Germanium-71	1,000
Curium-246	0.001	Germanium-75	1,000
Curium-247	0.001	Germanium-77	1,000
Curium-248	0.001	Germanium-78	1,000
Curium-249	1,000	Gold-193	1,000
Dysprosium-155	1,000	Gold-194	100
Dysprosium-157	1,000	Gold-195	10
Dysprosium-159	100	Gold-198	100
Dysprosium-165	1,000	Gold-198m	100
Dysprosium-166	100	Gold-199	100
Einsteinium-250	100	Gold-200	1,000

## Radiation Protection Standards

246-221-300

Gold-200m	100	Iridium-189	100
Gold-201	1,000	Iridium-190	100
Hafnium-170	100	Iridium-190m	1,000
Hafnium-172	1	Iridium-192 (73.8d)	1
Hafnium-173	1,000	Iridium-192m (1.4min)	10
Hafnium-175	100	Iridium-194	100
Hafnium-177m	1,000	Iridium-194m	10
Hafnium-178m	0.1	Iridium-195	1,000
Hafnium-179m	10	Iridium-195m	1,000
Hafnium-180m	1,000	Iron-52	100
Hafnium-181	10	Iron-55	100
Hafnium-182	0.1	Iron-59	10
Hafnium-182m	1,000	Iron-60	1
Hafnium-183	1,000	Krypton-74	1,000
Hafnium-184	100	Krypton-76	1,000
Holmium-155	1,000	Krypton-77	1,000
Holmium-157	1,000	Krypton-79	1,000
Holmium-159	1,000	Krypton-81	1,000
Holmium-161	1,000	Krypton-83m	1,000
Holmium-162	1,000	Krypton-85	1,000
Holmium-162m	1,000	Krypton-85m	1,000
Holmium-164	1,000	Krypton-87	1,000
Holmium-164m	1,000	Krypton-88	1,000
Holmium-166	100	Lanthanum-131	1,000
Holmium-166m	1	Lanthanum-132	100
Holmium-167	1,000	Lanthanum-135	1,000
Hydrogen-3	1,000	Lanthanum-137	10
Indium-109	1,000	Lanthanum-138	100
Indium-110 (4.9h)	1,000	Lanthanum-140	100
Indium-110m (69.1min)	1,000	Lanthanum-141	100
Indium-111	100	Lanthanum-142	1,000
Indium-112	1,000	Lanthanum-143	1,000
Indium-113m	1,000	Lead-195m	1,000
Indium-114m	10	Lead-198	1,000
Indium-115	100	Lead-199	1,000
Indium-115m	1,000	Lead-200	100
Indium-116m	1,000	Lead-201	1,000
Indium-117	1,000	Lead-202	10
Indium-117m	1,000	Lead-202m	1,000
Indium-119m	1,000	Lead-203	1,000
Iodine-120	100	Lead-205	100
Iodine-120m	1,000	Lead-209	1,000
Iodine-121	1,000	Lead-210	0.01
Iodine-123	100	Lead-211	100
Iodine-124	10	Lead-212	1
Iodine-125	1	Lead-214	100
Iodine-126	1	Lutetium-169	100
Iodine-128	1,000	Lutetium-170	100
Iodine-129	1	Lutetium-171	100
Iodine-130	10	Lutetium-172	100
Iodine-131	1	Lutetium-173	10
Iodine-132	100	Lutetium-174	10
Iodine-132m	100	Lutetium-174m	10
Iodine-133	10	Lutetium-176	100
Iodine-134	1,000	Lutetium-176m	1,000
Iodine-135	100	Lutetium-177	100
Iridium-182	1,000	Lutetium-177m	10
Iridium-184	1,000	Lutetium-178	1,000
Iridium-185	1,000	Lutetium-178m	1,000
Iridium-186	100	Lutetium-179	1,000
Iridium-187	1,000	Magnesium-28	100
Iridium-188	100	Manganese-51	1,000

Manganese-52	100	Osmium-191m	1,000
Manganese-52m	1,000	Osmium-193	100
Manganese-53	1,000	Osmium-194	1
Manganese-54	100	Palladium-100	100
Manganese-56	1,000	Palladium-101	1,000
Mendelevium-257	10	Palladium-103	100
Mendelevium-258	0.01	Palladium-107	10
Mercury-193	1,000	Palladium-109	100
Mercury-193m	100	Phosphorus-32	10
Mercury-194	1	Phosphorus-33	100
Mercury-195	1,000	Platinum-186	1,000
Mercury-195m	100	Platinum-188	100
Mercury-197	1,000	Platinum-189	1,000
Mercury-197m	100	Platinum-191	100
Mercury-199m	1,000	Platinum-193	1,000
Mercury-203	100	Platinum-193m	100
Molybdenum-90	100	Platinum-195m	100
Molybdenum-93	10	Platinum-197	100
Molybdenum-93m	100	Platinum-197m	1,000
Molybdenum-99	100	Platinum-199	1,000
Molybdenum-101	1,000	Platinum-200	100
Neodymium-136	1,000	Plutonium-234	10
Neodymium-138	100	Plutonium-235	1,000
Neodymium-139	1,000	Plutonium-236	0.001
Neodymium-139m	1,000	Plutonium-237	100
Neodymium-141	1,000	Plutonium-238	0.001
Neodymium-147	100	Plutonium-239	0.001
Neodymium-149	1,000	Plutonium-240	0.001
Neodymium-151	1,000	Plutonium-241	0.01
Neptunium-232	100	Plutonium-242	0.001
Neptunium-233	1,000	Plutonium-243	1,000
Neptunium-234	100	Plutonium-244	0.001
Neptunium-235	100	Plutonium-245	100
Neptunium-236 (1.15E+5y)	0.001	Polonium-203	1,000
Neptunium-236 (22.5h)	1	Polonium-205	1,000
Neptunium-237	0.001	Polonium-207	1,000
Neptunium-238	10	Polonium-210	0.1
Neptunium-239	100	Potassium-40	100
Neptunium-240	1,000	Potassium-42	1,000
Nickel-56	100	Potassium-43	1,000
Nickel-57	100	Potassium-44	1,000
Nickel-59	100	Potassium-45	1,000
Nickel-63	100	Praseodymium-136	1,000
Nickel-65	1,000	Praseodymium-137	1,000
Nickel-66	10	Praseodymium-138m	1,000
Niobium-88	1,000	Praseodymium-139	1,000
Niobium-89 (122min)	1,000	Praseodymium-142	100
Niobium-89m (66min)	1,000	Praseodymium-142m	1,000
Niobium-90	100	Praseodymium-143	100
Niobium-93m	10	Praseodymium-144	1,000
Niobium-94	1	Praseodymium-145	100
Niobium-95	100	Praseodymium-147	1,000
Niobium-95m	100	Promethium-141	1,000
Niobium-96	100	Promethium-143	100
Niobium-97	1,000	Promethium-144	10
Niobium-98	1,000	Promethium-145	10
Osmium-180	1,000	Promethium-146	1
Osmium-181	1,000	Promethium-147	10
Osmium-182	100	Promethium-148	10
Osmium-185	100	Promethium-148m	10
Osmium-189m	1,000	Promethium-149	100
Osmium-191	100	Promethium-150	1,000

## Radiation Protection Standards

246-221-300

Promethium-151	100	Samarium-153	100
Protactinium-227	10	Samarium-155	1,000
Protactinium-228	1	Samarium-156	1,000
Protactinium-230	0.1	Scandium-43	1,000
Protactinium-231	0.001	Scandium-44	100
Protactinium-232	1	Scandium-44m	100
Protactinium-233	100	Scandium-46	10
Protactinium-234	100	Scandium-47	100
Radium-223	0.1	Scandium-48	100
Radium-224	0.1	Scandium-49	1,000
Radium-225	0.1	Selenium-70	1,000
Radium-226	0.1	Selenium-73	100
Radium-227	1,000	Selenium-73m	1,000
Radium-228	0.1	Selenium-75	100
Radon-220	1	Selenium-79	100
Radon-222	1	Selenium-81	1,000
Rhenium-177	1,000	Selenium-81m	1,000
Rhenium-178	1,000	Selenium-83	1,000
Rhenium-181	1,000	Silicon-31	1,000
Rhenium-182 (64.0h)	100	Silicon-32	1
Rhenium-182 (12.7h)	1,000	Silver-102	1,000
Rhenium-184	100	Silver-103	1,000
Rhenium-184m	10	Silver-104	1,000
Rhenium-186	100	Silver-104m	1,000
Rhenium-186m	10	Silver-105	100
Rhenium-187	1,000	Silver-106	1,000
Rhenium-188	100	Silver-106m	100
Rhenium-188m	1,000	Silver-108m	1
Rhenium-189	100	Silver-111	100
Rhodium-99	100	Silver-112	100
Rhodium-99m	1,000	Silver-115	1,000
Rhodium-100	100	Silver-110m	10
Rhodium-101	10	Sodium-22	10
Rhodium-101m	1,000	Sodium-24	100
Rhodium-102	10	Strontium-80	100
Rhodium-102m	10	Strontium-81	1,000
Rhodium-103m	1,000	Strontium-83	100
Rhodium-105	100	Strontium-85	100
Rhodium-106m	1,000	Strontium-85m	1,000
Rhodium-107	1,000	Strontium-87m	1,000
Rubidium-79	1,000	Strontium-89	10
Rubidium-81	1,000	Strontium-90	0.1
Rubidium-81m	1,000	Strontium-91	100
Rubidium-82m	1,000	Strontium-92	100
Rubidium-83	100	Sulfur-35	100
Rubidium-84	100	Tantalum-172	1,000
Rubidium-86	100	Tantalum-173	1,000
Rubidium-87	100	Tantalum-174	1,000
Rubidium-88	1,000	Tantalum-175	1,000
Rubidium-89	1,000	Tantalum-176	100
Ruthenium-94	1,000	Tantalum-177	1,000
Ruthenium-97	1,000	Tantalum-178	1,000
Ruthenium-103	100	Tantalum-179	100
Ruthenium-105	1,000	Tantalum-180	100
Ruthenium-106	1	Tantalum-180m	1,000
Samarium-141	1,000	Tantalum-182	10
Samarium-141m	1,000	Tantalum-182m	1,000
Samarium-142	1,000	Tantalum-183	100
Samarium-145	100	Tantalum-184	100
Samarium-146	1	Tantalum-185	1,000
Samarium-147	100	Tantalum-186	1,000
Samarium-151	10	Technetium-93	1,000



Technetium-93m	1,000	Thulium-162	1,000
Technetium-94	1,000	Thulium-166	100
Technetium-94m	1,000	Thulium-167	100
Technetium-96	100	Thulium-170	10
Technetium-96m	1,000	Thulium-171	10
Technetium-97	1,000	Thulium-172	100
Technetium-97m	100	Thulium-173	100
Technetium-98	10	Thulium-175	1,000
Technetium-99	100	Tin-110	100
Technetium-99m	1,000	Tin-111	1,000
Technetium-101	1,000	Tin-113	100
Technetium-104	1,000	Tin-117m	100
Tellurium-116	1,000	Tin-119m	100
Tellurium-121	100	Tin-121	1,000
Tellurium-121m	10	Tin-121m	100
Tellurium-123	100	Tin-123	10
Tellurium-123m	10	Tin-123m	1,000
Tellurium-125m	10	Tin-125	10
Tellurium-127	1,000	Tin-126	10
Tellurium-127m	10	Tin-127	1,000
Tellurium-129	1,000	Tin-128	1,000
Tellurium-129m	10	Titanium-44	1
Tellurium-131	100	Titanium-45	1,000
Tellurium-131m	10	Tungsten-176	1,000
Tellurium-132	10	Tungsten-177	1,000
Tellurium-133	1,000	Tungsten-178	1,000
Tellurium-133m	100	Tungsten-179	1,000
Tellurium-134	1,000	Tungsten-181	1,000
Terbium-147	1,000	Tungsten-185	100
Terbium-149	100	Tungsten-187	100
Terbium-150	1,000	Tungsten-188	10
Terbium-151	100	Uranium-230	0.01
Terbium-153	1,000	Uranium-231	100
Terbium-154	100	Uranium-232	0.001
Terbium-155	1,000	Uranium-233	0.001
Terbium-156	100	Uranium-234	0.001
Terbium-156m (24.4h)	1,000	Uranium-235	0.001
Terbium-156m (5.0h)	1,000	Uranium-236	0.001
Terbium-157	10	Uranium-237	100
Terbium-158	1	Uranium-238	100
Terbium-160	10	Uranium-239	1,000
Terbium-161	100	Uranium-240	100
Thallium-194	1,000	Uranium-natural	100
Thallium-194m	1,000	Vanadium-47	1,000
Thallium-195	1,000	Vanadium-48	100
Thallium-197	1,000	Vanadium-49	1,000
Thallium-198	1,000	Xenon-120	1,000
Thallium-198m	1,000	Xenon-121	1,000
Thallium-199	1,000	Xenon-122	1,000
Thallium-200	1,000	Xenon-123	1,000
Thallium-201	1,000	Xenon-125	1,000
Thallium-202	100	Xenon-127	1,000
Thallium-204	100	Xenon-129m	1,000
Thorium-226	10	Xenon-131m	1,000
Thorium-227	0.01	Xenon-133	1,000
Thorium-228	0.001	Xenon-133m	1,000
Thorium-229	0.001	Xenon-135	1,000
Thorium-230	0.001	Xenon-135m	1,000
Thorium-231	100	Xenon-138	1,000
Thorium-232	100	Ytterbium-162	1,000
Thorium-234	10	Ytterbium-166	100
Thorium-natural	100	Ytterbium-167	1,000

Ytterbium-169	100
Ytterbium-175	100
Ytterbium-177	1,000
Ytterbium-178	1,000
Yttrium-86	100
Yttrium-86m	1,000
Yttrium-87	100
Yttrium-88	10
Yttrium-90	10
Yttrium-90m	1,000
Yttrium-91	10
Yttrium-91m	1,000
Yttrium-92	100
Yttrium-93	100
Yttrium-94	1,000
Yttrium-95	1,000
Zinc-62	100
Zinc-63	1,000
Zinc-65	10
Zinc-69	1,000
Zinc-69m	100
Zinc-71m	1,000
Zinc-72	100
Zirconium-86	100
Zirconium-88	10
Zirconium-89	100
Zirconium-93	1
Zirconium-95	10
Zirconium-97	100
Any alpha-emitting radionuclide not listed above or mixtures of alpha emitters of unknown composition	0.001
Any radionuclide other than alpha-emitting radionuclides not listed above, or mixtures of beta emitters of unknown composition	0.01

NOTE: For purposes of WAC 246-221-120(8), 246-221-130 (7)(a), and 246-221-240(1) where there is involved a combination of radionuclides in known amounts, the limit for the combination shall be derived as follows: Determine, for each radionuclide in the combination, the ratio between the quantity present in the combination and the limit otherwise established for the specific radionuclide when not in combination. The sum of such ratios for all radionuclides in the combination may not exceed "1" — that is, unity.

<sup>1</sup> The quantities listed above were derived by taking 1/10th of the most restrictive ALI listed in Table I, Columns 1 and 2, of WAC 246-221-290, rounding to the nearest factor of 10, and constraining the values listed between 37 Bq and 37 MBq (0.001 and 1,000 µCi). Values of 3.7 MBq (100 µCi) have been assigned for radionuclides having a radioactive half-life in excess of E+9 years, except rhenium, 37 MBq (1,000 µCi), to take into account their low specific activity.

\* To convert µCi to kBq, multiply the µCi value by 37.

[Statutory Authority: RCW 70.98.050. 94-01-073, § 246-221-300, filed 12/9/93, effective 1/9/94. Statutory Authority: RCW 70.98.050 and 70.98.080. 91-15-112 (Order 184), § 246-221-300, filed 7/24/91, effective 8/24/91. Statutory Authority: RCW 43.70.040. 91-02-049 (Order 121), recodified as § 246-221-300, filed 12/27/90, effective 1/31/91. Statutory Authority: RCW 70.98.080. 83-19-050 (Order 2026), § 402-24-230, filed 9/16/83. Statutory Authority: RCW 70.98.050. 81-01-011 (Order 1570), § 402-24-230, filed 12/8/80; Order 1095, § 402-24-230, filed 2/6/76; Order 708, § 402-24-230, filed 8/24/72; Order 1, § 402-24-230, filed 7/2/71; Order 1, § 402-24-230, filed 1/8/69; Rules (part), filed 10/26/66.]

## Chapter 246-222 WAC

## RADIATION PROTECTION—WORKER RIGHTS

## WAC

246-222-001	Purpose and scope.
246-222-020	Posting of notices to workers.
246-222-030	Instructions to workers.
246-222-040	Notifications and reports to individuals.
246-222-050	Presence of representatives of licensees or registrants and workers during inspection.
246-222-060	Consultation with workers during inspections.
246-222-070	Requests by workers for inspections.
246-222-080	Inspections not warranted—Informal review.

**WAC 246-222-001 Purpose and scope.** This chapter establishes requirements for notices, instructions and reports by licensees or registrants to individuals engaged in work under a license or registration and options available to such individuals in connection with department inspections of licensees or registrants to ascertain compliance with the provisions of the act and regulations, orders and licenses issued thereunder regarding radiological working conditions. The regulations in this chapter apply to all persons who receive, possess, use, own or transfer a source of radiation licensed by or registered with the department pursuant to the regulations in chapters 246-224, 246-232, and 246-235 WAC. The definitions contained in WAC 246-220-010 also apply to this chapter.

[Statutory Authority: RCW 70.98.050 and 70.98.080. 91-15-112 (Order 184), § 246-222-001, filed 7/24/91, effective 8/24/91. Statutory Authority: RCW 43.70.040. 91-02-049 (Order 121), recodified as § 246-222-001, filed 12/27/90, effective 1/31/91. Statutory Authority: RCW 70.98.080. 87-01-031 (Order 2450), § 402-48-010, filed 12/11/86. Statutory Authority: RCW 70.98.050. 81-01-011 (Order 1570), § 402-48-010, filed 12/8/80; Order 1084, § 402-48-010, filed 1/14/76.]

**WAC 246-222-020 Posting of notices to workers.**

(1) Each licensee or registrant shall post current copies of the following documents:

(a) The regulations in this chapter and in chapter 246-221 WAC;

(b) The license, conditions or documents incorporated into the license by reference and amendments thereto;

(c) The operating procedures applicable to work under the license or registration;

(d) Any notice of noncompliance involving radiological working conditions, proposed imposition of civil penalty, order issued pursuant to chapter 246-220 WAC, or any response from the licensee or registrant.

(2) If posting of a document specified in subsection (1)(a), (b), or (c) of this section is not practicable, the licensee or registrant may post a notice which describes the document and states where it may be examined.

(3) Each licensee or registrant shall conspicuously post pertinent emergency procedures when emergency procedures are required by the department.

(4) Properly completed department Form RHF-3 "Notice to employees," shall be posted by each licensee or registrant wherever individuals work in or frequent any portion of a restricted area.

(5) Documents, notices or forms posted pursuant to this section shall appear in a sufficient number of places to permit individuals engaged in work under the license or registration to observe them on the way to or from any

Ytterbium-169	100
Ytterbium-175	100
Ytterbium-177	1,000
Ytterbium-178	1,000
Yttrium-86	100
Yttrium-86m	1,000
Yttrium-87	100
Yttrium-88	10
Yttrium-90	10
Yttrium-90m	1,000
Yttrium-91	10
Yttrium-91m	1,000
Yttrium-92	100
Yttrium-93	100
Yttrium-94	1,000
Yttrium-95	1,000
Zinc-62	100
Zinc-63	1,000
Zinc-65	10
Zinc-69	1,000
Zinc-69m	100
Zinc-71m	1,000
Zinc-72	100
Zirconium-86	100
Zirconium-88	10
Zirconium-89	100
Zirconium-93	1
Zirconium-95	10
Zirconium-97	100
Any alpha-emitting radionuclide not listed above or mixtures of alpha emitters of unknown composition	0.001
Any radionuclide other than alpha-emitting radionuclides not listed above, or mixtures of beta emitters of unknown composition	0.01

NOTE: For purposes of WAC 246-221-120(8), 246-221-130 (7)(a), and 246-221-240(1) where there is involved a combination of radionuclides in known amounts, the limit for the combination shall be derived as follows: Determine, for each radionuclide in the combination, the ratio between the quantity present in the combination and the limit otherwise established for the specific radionuclide when not in combination. The sum of such ratios for all radionuclides in the combination may not exceed "1" — that is, unity.

<sup>1</sup> The quantities listed above were derived by taking 1/10th of the most restrictive ALI listed in Table I, Columns 1 and 2, of WAC 246-221-290, rounding to the nearest factor of 10, and constraining the values listed between 37 Bq and 37 MBq (0.001 and 1,000  $\mu$ Ci). Values of 3.7 MBq (100  $\mu$ Ci) have been assigned for radionuclides having a radioactive half-life in excess of E+9 years, except rhenium, 37 MBq (1,000  $\mu$ Ci), to take into account their low specific activity.

\* To convert  $\mu$ Ci to kBq, multiply the  $\mu$ Ci value by 37.

[Statutory Authority: RCW 70.98.050. 94-01-073, § 246-221-300, filed 12/9/93, effective 1/9/94. Statutory Authority: RCW 70.98.050 and 70.98.080. 91-15-112 (Order 184), § 246-221-300, filed 7/24/91, effective 8/24/91. Statutory Authority: RCW 43.70.040. 91-02-049 (Order 121), recodified as § 246-221-300, filed 12/27/90, effective 1/31/91. Statutory Authority: RCW 70.98.080. 83-19-050 (Order 2026), § 402-24-230, filed 9/16/83. Statutory Authority: RCW 70.98.050. 81-01-011 (Order 1570), § 402-24-230, filed 12/8/80; Order 1095, § 402-24-230, filed 2/6/76; Order 708, § 402-24-230, filed 8/24/72; Order 1, § 402-24-230, filed 7/2/71; Order 1, § 402-24-230, filed 1/8/69; Rules (part), filed 10/26/66.]

## Chapter 246-222 WAC

## RADIATION PROTECTION—WORKER RIGHTS

## WAC

246-222-001	Purpose and scope.
246-222-020	Posting of notices to workers.
246-222-030	Instructions to workers.
246-222-040	Notifications and reports to individuals.
246-222-050	Presence of representatives of licensees or registrants and workers during inspection.
246-222-060	Consultation with workers during inspections.
246-222-070	Requests by workers for inspections.
246-222-080	Inspections not warranted—Informal review.

**WAC 246-222-001 Purpose and scope.** This chapter establishes requirements for notices, instructions and reports by licensees or registrants to individuals engaged in work under a license or registration and options available to such individuals in connection with department inspections of licensees or registrants to ascertain compliance with the provisions of the act and regulations, orders and licenses issued thereunder regarding radiological working conditions. The regulations in this chapter apply to all persons who receive, possess, use, own or transfer a source of radiation licensed by or registered with the department pursuant to the regulations in chapters 246-224, 246-232, and 246-235 WAC. The definitions contained in WAC 246-220-010 also apply to this chapter.

[Statutory Authority: RCW 70.98.050 and 70.98.080. 91-15-112 (Order 184), § 246-222-001, filed 7/24/91, effective 8/24/91. Statutory Authority: RCW 43.70.040. 91-02-049 (Order 121), recodified as § 246-222-001, filed 12/27/90, effective 1/31/91. Statutory Authority: RCW 70.98.080. 87-01-031 (Order 2450), § 402-48-010, filed 12/11/86. Statutory Authority: RCW 70.98.050. 81-01-011 (Order 1570), § 402-48-010, filed 12/8/80; Order 1084, § 402-48-010, filed 1/14/76.]

**WAC 246-222-020 Posting of notices to workers.**

(1) Each licensee or registrant shall post current copies of the following documents:

(a) The regulations in this chapter and in chapter 246-221 WAC;

(b) The license, conditions or documents incorporated into the license by reference and amendments thereto;

(c) The operating procedures applicable to work under the license or registration;

(d) Any notice of noncompliance involving radiological working conditions, proposed imposition of civil penalty, order issued pursuant to chapter 246-220 WAC, or any response from the licensee or registrant.

(2) If posting of a document specified in subsection (1)(a), (b), or (c) of this section is not practicable, the licensee or registrant may post a notice which describes the document and states where it may be examined.

(3) Each licensee or registrant shall conspicuously post pertinent emergency procedures when emergency procedures are required by the department.

(4) Properly completed department Form RHF-3 "Notice to employees," shall be posted by each licensee or registrant wherever individuals work in or frequent any portion of a restricted area.

(5) Documents, notices or forms posted pursuant to this section shall appear in a sufficient number of places to permit individuals engaged in work under the license or registration to observe them on the way to or from any

particular work location to which the document applies, shall be conspicuous, and shall be replaced if defaced or altered.

(6) Department documents posted pursuant to subsection (1)(d) of this section shall be posted as specified by subsection (5) of this section within five working days after receipt of the documents from the department; the licensee's or registrant's response, if any, shall be posted within five working days after dispatch from the licensee or registrant. Such documents shall remain posted for a minimum of five working days or until action correcting the item(s) of noncompliance has been completed, whichever is later.

[Statutory Authority: RCW 70.98.050. 94-01-073, § 246-222-020, filed 12/9/93, effective 1/9/94. Statutory Authority: RCW 70.98.050 and 70.98.080. 91-15-112 (Order 184), § 246-222-020, filed 7/24/91, effective 8/24/91. Statutory Authority: RCW 43.70.040. 91-02-049 (Order 121), recodified as § 246-222-020, filed 12/27/90, effective 1/31/91. Statutory Authority: RCW 70.98.080. 87-01-031 (Order 2450), § 402-48-020, filed 12/11/86. Statutory Authority: RCW 70.98.050. 81-01-011 (Order 1570), § 402-48-020, filed 12/8/80; Order 1084, § 402-48-020, filed 1/14/76.]

**WAC 246-222-030 Instructions to workers.** (1) All individuals likely to receive an occupational dose:

(a) Shall be kept informed of the storage, transfer, or use of sources of radiation in the licensee's or registrant's facility;

(b) Shall be instructed in the health protection considerations for the individual and potential offspring associated with exposure to radiation or radioactive material, in precautions or procedures to minimize exposure, and in the purposes and functions of protective devices employed;

(c) Shall be instructed in, and instructed to observe, to the extent within the worker's control, the applicable provisions of these regulations, department form RHF-3 "Notice to employees," and license conditions for the protection of personnel from exposures to radiation or radioactive material;

(d) Shall be instructed that any worker or representative of workers who believes that a violation of the regulations, license conditions, or unnecessary exposure to radiation exists or occurred, may request an inspection by the department by oral or written notification. The notification shall set forth specific grounds for the complaint. Any such notification to the department is confidential;

(e) Shall be instructed of their right to notify the department if the individual suspects improper actions by a licensee/registrant, or conditions which may lead to a violation of these regulations, the license/registration, or unnecessary exposure to radiation or radioactive materials;

(f) Shall be instructed that employment discrimination by a licensee/registrant against an employee because of actions described in this chapter is prohibited;

(g) Shall be instructed as to their responsibility to report promptly to the licensee or registrant any condition which may constitute, lead to, or cause a violation of the act, these regulations, and licenses or unnecessary exposure to radiation or radioactive material;

(h) Shall be instructed in the appropriate response to warnings made in the event of any unusual occurrence or malfunction that may involve exposure to radiation or radioactive material; and

(i) Shall be advised as to the radiation exposure reports which workers shall be furnished pursuant to WAC 246-222-040.

(2) Records of these instructions described in subsection (1) of this section for all individuals working in, or frequenting any portion of, a restricted area shall be maintained for inspection by the department until further notice. These records shall include a copy of this section, or all the information contained in this section, along with a dated verification signature by the employee stating that the individual has received an explanation of the instructions contained in this section.

(3) The extent of these instructions shall be commensurate with potential radiological health protection considerations present in the workplace.

[Statutory Authority: RCW 70.98.050. 94-01-073, § 246-222-030, filed 12/9/93, effective 1/9/94. Statutory Authority: RCW 70.98.050 and 70.98.080. 91-15-112 (Order 184), § 246-222-030, filed 7/24/91, effective 8/24/91. Statutory Authority: RCW 43.70.040. 91-02-049 (Order 121), recodified as § 246-222-030, filed 12/27/90, effective 1/31/91. Statutory Authority: RCW 70.98.080. 83-19-050 (Order 2026), § 402-48-030, filed 9/16/83. Statutory Authority: RCW 70.98.050. 81-01-011 (Order 1570), § 402-48-030, filed 12/8/80; Order 1084, § 402-48-030, filed 1/14/76.]

**WAC 246-222-040 Notifications and reports to individuals.** (1) Radiation exposure data for an individual and the results of any measurements, analyses, and calculations of radioactive material deposited or retained in the body of an individual shall be reported to the individual as specified in this section. The information reported shall include data and results obtained pursuant to these regulations, orders, and license conditions, as shown in records maintained by the licensee or registrant pursuant to these regulations. Each notification and report shall:

(a) Be in writing;

(b) Include appropriate identifying data such as the name of the licensee or registrant, the name of the individual, and the individual's identification number, preferably Social Security number;

(c) Include the individual's exposure information; and

(d) Contain the following statement:

"This report is furnished to you under the provisions of the Washington state department of health, division of radiation protection, rules and regulations for radiation protection. You should preserve this report for further reference."

(2) Each licensee or registrant shall advise each worker annually of the worker's dose as shown in records maintained by the licensee or registrant pursuant to WAC 246-221-090, 246-221-100, and 246-221-230.

(3) At the request of a worker formerly engaged in work controlled by the licensee or the registrant, each licensee or registrant shall furnish to each worker or former worker a report of the worker's dose due to exposure to radiation or radioactive material upon termination. For the purposes of this section, termination means the end of employment with the licensee or the end of a work assignment in the licensee's restricted area(s) in a given calendar quarter without expectation, or specific scheduling, of reentry into such restricted area(s) during the remainder of that calendar quarter. Such report shall be furnished within thirty days from the time the request is made, or within thirty days after

the exposure of the individual has been determined by the licensee or registrant, whichever is later; shall cover, within the period of time specified in the request, the dose record for each year in which the worker's activities involved exposure to radiation from radioactive material licensed by, or radiation machines registered with the department; and shall include the dates and locations of work under the license or registration in which the worker participated during this period.

(4) In addition to the requirements of subsection (3) of this section, at the request of a worker who is terminating employment with the licensee or registrant in work involving radiation exposure, during the current year, each licensee or registrant shall provide at termination to each such worker, or to the worker's designee a written report regarding the radiation dose received by that worker from operations of the licensee or registrant during the current year. If the most recent individual monitoring results are not available at that time, a written estimate of the dose shall be provided together with a clear indication that this is an estimate.

(5) When a licensee or registrant is required pursuant to WAC 246-221-260 to report to the department any exposure of an individual to radiation or radioactive material, the licensee or the registrant shall also provide the individual a written report on the individual's exposure data included therein. Such reports shall be transmitted at a time not later than the transmittal to the department.

[Statutory Authority: RCW 70.98.050. 94-01-073, § 246-222-040, filed 12/9/93, effective 1/9/94. Statutory Authority: RCW 70.98.050 and 70.98.080. 91-15-112 (Order 184), § 246-222-040, filed 7/24/91, effective 8/24/91. Statutory Authority: RCW 43.70.040. 91-02-049 (Order 121), recodified as § 246-222-040, filed 12/27/90, effective 1/31/91. Statutory Authority: RCW 70.98.080. 87-01-031 (Order 2450), § 402-48-040, filed 12/11/86; 83-19-050 (Order 2026), § 402-48-040, filed 9/16/83. Statutory Authority: RCW 70.98.050. 81-01-011 (Order 1570), § 402-48-040, filed 12/8/80; Order 1084, § 402-48-040, filed 1/14/76.]

#### **WAC 246-222-050 Presence of representatives of licensees or registrants and workers during inspection.**

(1) Each licensee or registrant shall afford to the department at all reasonable times opportunity to inspect materials, machines, activities, facilities, premises, and records pursuant to these regulations.

(2) During an inspection, department inspectors may consult privately with workers as specified in WAC 246-222-060. The licensee or registrant may accompany department inspectors during other phases of an inspection.

(3) If, at the time of inspection, an individual has been authorized by the workers to represent them during department inspections, the licensee or registrant shall notify the inspectors of such authorization and shall give the workers' representative an opportunity to accompany the inspectors during the inspection of physical working conditions.

(4) Each workers' representative shall be routinely engaged in work under control of the licensee or registrant and shall have received instructions as specified in WAC 246-222-030.

(5) Different representatives of licensees or registrants and workers may accompany the inspectors during different phases of an inspection if there is no resulting interference with the conduct of the inspection. However, only one workers' representative at a time may accompany the inspectors.

(6) With the approval of the licensee or registrant and the workers' representative an individual who is not routinely engaged in work under control of the licensee or registrant, for example, a consultant to the licensee or registrant or to the workers' representative, shall be afforded the opportunity to accompany department inspectors during the inspection of physical working conditions.

(7) Notwithstanding the other provisions of this section, department inspectors are authorized to refuse to permit accompaniment by any individual who deliberately interferes with a fair and orderly inspection. With regard to any area containing proprietary information, the workers' representative for that area shall be an individual previously authorized by the licensee or registrant to enter that area.

[Statutory Authority: RCW 70.98.050 and 70.98.080. 91-15-112 (Order 184), § 246-222-050, filed 7/24/91, effective 8/24/91. Statutory Authority: RCW 43.70.040. 91-02-049 (Order 121), recodified as § 246-222-050, filed 12/27/90, effective 1/31/91; Order 1084, § 402-48-050, filed 1/14/76.]

#### **WAC 246-222-060 Consultation with workers during inspections.**

(1) Department inspectors may consult privately with workers concerning matters of occupational radiation protection and other matters related to applicable provisions of department regulations and licenses to the extent the inspectors deem necessary for the conduct of an effective and thorough inspection.

(2) During the course of an inspection any worker may bring privately to the attention of the inspectors, either orally or in writing, any past or present condition which the worker has reason to believe may have contributed to or caused any violation of the act, these regulations, or license condition, or any unnecessary exposure of an individual to radiation from licensed radioactive material or a registered radiation machine under the licensee's or registrant's control. Any such notice in writing shall comply with the requirements of WAC 246-222-070(1).

(3) The provisions of subsection (2) of this section shall not be interpreted as authorization to disregard instructions pursuant to WAC 246-222-030.

[Statutory Authority: RCW 70.98.050 and 70.98.080. 91-15-112 (Order 184), § 246-222-060, filed 7/24/91, effective 8/24/91. Statutory Authority: RCW 43.70.040. 91-02-049 (Order 121), recodified as § 246-222-060, filed 12/27/90, effective 1/31/91; Order 1084, § 402-48-060, filed 1/14/76.]

#### **WAC 246-222-070 Requests by workers for inspections.**

(1) Any worker or representative of workers who believes that a violation of the act, of these regulations, or of license conditions exists or has occurred in work under a license or registration with regard to radiological working conditions in which the worker is engaged, may request an inspection by giving notice of the alleged violation to the Washington state department of health, division of radiation protection. Any such notice shall be in writing, shall set forth the specific grounds for the notice, and shall be signed by the worker or representative of the workers. A copy shall be provided to the licensee or registrant by the office of radiation protection no later than at the time of inspection except that, upon the request of the worker giving such notice, his or her name and the name of individuals referred to therein shall not appear in such copy or on any record published, released, or made available by the department, except for good cause shown.

(2) If, upon receipt of such notice, the inspector for the division of radiation protection determines that the complaint meets the requirements set forth in subsection (1) of this section, and that there are reasonable grounds to believe that the alleged violation exists or has occurred, the inspector shall cause an inspection to be made as soon as practicable, to determine if such alleged violation exists or has occurred. Inspections pursuant to this section need not be limited to matters referred to in the complaint.

(3) No licensee or registrant shall discharge or in any manner discriminate against any worker because such worker has filed any complaint or instituted or caused to be instituted any proceeding under these regulations or has testified or is about to testify in any such proceeding or because of the exercise by such worker on behalf of the worker or other workers of any option afforded by this chapter.

[Statutory Authority: RCW 70.98.050. 94-01-073, § 246-222-070, filed 12/9/93, effective 1/9/94. Statutory Authority: RCW 70.98.050 and 70.98.080. 91-15-112 (Order 184), § 246-222-070, filed 7/24/91, effective 8/24/91. Statutory Authority: RCW 43.70.040. 91-02-049 (Order 121), recodified as § 246-222-070, filed 12/27/90, effective 1/31/91. Statutory Authority: RCW 70.98.080. 87-01-031 (Order 2450), § 402-48-070, filed 12/11/86; Order 1084, § 402-48-070, filed 1/14/76.]

**WAC 246-222-080 Inspections not warranted—**  
**Informal review.** (1) If the department of health, division of radiation protection determines, with respect to a complaint under WAC 246-222-070 that an inspection is not warranted because there are no reasonable grounds to believe that a violation exists or has occurred, the division of radiation protection shall notify the complainant in writing of such determination.

(a) If the complaint resulted from activities concerning naturally occurring or accelerator produced radioactive materials and/or radiation producing machines: The complainant may obtain review of such determination by submitting a written statement of position to the Assistant Director, Division of Industrial Safety and Health, P.O. Box 4600, Olympia, Washington 98504-4600. Such request for informal review will be processed according to the provisions of WAC 296-350-460 and the provisions of the interagency agreement between the department of labor and industries and the department of health, division of radiation protection, if any.

(b) If the complaint resulted from activities concerning byproduct material, source material, and/or special nuclear material: The complainant may obtain review of such determination by submitting a written statement of position with the Department of Health, Division of Radiation Protection, P.O. Box 47827, Olympia, Washington 98504-7827 (360/753-3468), who will provide the licensee or registrant with a copy of such statement by certified mail, excluding, at the request of the complainant, the name of the complainant. The licensee or registrant may submit an opposing written statement of position with the department of health, division of radiation protection, who will provide the complainant with a copy of such statement by certified mail. Upon the request of the complainant, the department of health may hold an informal conference in which the complainant and the licensee or registrant may orally present their views. An informal conference may also be held at the request of the licensee or registrant, but disclosure of the

identity of the complainant will be made only following receipt of written authorization from the complainant. After considering all written or oral views presented, the department of health shall affirm, modify, or reverse the determination of the division of radiation protection and furnish the complainant and the licensee or registrant a written notification of the decision and the reason therefor.

(2) If the division of radiation protection determines that an inspection is not warranted because the requirements of WAC 246-222-070(1) have not been met, it shall notify the complainant in writing of such determination. Such determination shall be without prejudice to the filing of a new complaint meeting the requirements of WAC 246-222-070(1).

[Statutory Authority: RCW 70.98.050. 94-01-073, § 246-222-080, filed 12/9/93, effective 1/9/94. Statutory Authority: RCW 70.98.050 and 70.98.080. 91-15-112 (Order 184), § 246-222-080, filed 7/24/91, effective 8/24/91. Statutory Authority: RCW 43.70.040. 91-02-049 (Order 121), recodified as § 246-222-080, filed 12/27/90, effective 1/31/91. Statutory Authority: RCW 70.98.080. 87-01-031 (Order 2450), § 402-48-080, filed 12/11/86; Order 1084, § 402-48-080, filed 1/14/76.]

## Chapter 246-224 WAC

### RADIATION PROTECTION—MACHINE ASSEMBLY AND REGISTRATION

#### WAC

246-224-001	Purpose and scope.
246-224-010	Exemptions.
246-224-020	Application for registration of radiation machine facilities.
246-224-040	Expiration of registration.
246-224-050	Renewal of registration.
246-224-060	Separate locations.
246-224-070	Report of changes.
246-224-080	Approval not implied.
246-224-090	Repair person, assembler, or installer obligation.
246-224-100	Out-of-state radiation machines.

#### DISPOSITION OF SECTIONS FORMERLY CODIFIED IN THIS CHAPTER

246-224-030	Issuance of certificate of registration. [Statutory Authority: RCW 70.98.050 and 70.98.080. 91-15-083 (Order 183), § 246-224-030, filed 7/23/91, effective 8/23/91. Statutory Authority: RCW 43.70.040. 91-02-049 (Order 121), recodified as § 246-224-030, filed 12/27/90, effective 1/31/91. Statutory Authority: RCW 70.98.080. 83-19-050 (Order 2026), § 402-16-232, filed 9/16/83. Statutory Authority: RCW 70.98.050. 81-01-011 (Order 1570), § 402-16-232, filed 12/8/80.] Repealed by 94-01-073, filed 12/9/93, effective 1/9/94. Statutory Authority: RCW 70.98.050.
-------------	---

**WAC 246-224-001 Purpose and scope.** (1) This chapter provides for the registration of radiation machine facilities.

(2) For purposes of chapter 246-224 WAC of these regulations, "facility" means the location at which one or more radiation machines are installed, manufactured, tested, and/or located within one building, vehicle, or in one physical complex.

(3) In addition to the requirements of this chapter, all registrants are subject to the applicable provisions of other parts of these regulations.

[Statutory Authority: RCW 70.98.050 and 70.98.080. 91-15-083 (Order 183), § 246-224-001, filed 7/23/91, effective 8/23/91. Statutory Authority: RCW 43.70.040. 91-02-049 (Order 121), recodified as § 246-224-001, filed 12/27/90, effective 1/31/91. Statutory Authority: RCW 70.98.050. 81-01-011 (Order 1570), § 402-16-210, filed 12/8/80; Order 1084, § 402-16-210, filed 1/14/76. Formerly WAC 402-16-010.]

**WAC 246-224-010 Exemptions.** (1) Electronic equipment that produces radiation incidental to its operation for other purposes is exempt from the registration and notification requirements of this part, providing the dose equivalent rate averaged over an area of 10 square centimeters does not exceed 0.5 mrem per hour at 5 cm from any accessible surface of such equipment.

(2) Radiation machines while in transit or storage incident thereto are exempt from the requirements of this part.

(3) Domestic television receivers are exempt from the requirements of this chapter.

[Statutory Authority: RCW 43.70.040. 91-02-049 (Order 121), recodified as § 246-224-010, filed 12/27/90, effective 1/31/91; Order 1084, § 402-16-220, filed 1/14/76. Formerly WAC 402-16-100.]

**WAC 246-224-020 Application for registration of radiation machine facilities.** Each person having a radiation machine facility shall apply for registration of such facility with the department within fifteen calendar days after the initial operations of a radiation machine facility. Application for registration shall be completed on forms furnished by the department or on similar forms and containing all the information required by the department form and accompanying instructions. Each application shall be accompanied by fees in accordance with WAC 246-254-053.

[Statutory Authority: RCW 70.98.050 and 70.98.080. 91-15-083 (Order 183), § 246-224-020, filed 7/23/91, effective 8/23/91. Statutory Authority: RCW 43.70.040. 91-02-049 (Order 121), recodified as § 246-224-020, filed 12/27/90, effective 1/31/91. Statutory Authority: RCW 70.98.080. 83-19-050 (Order 2026), § 402-16-230, filed 9/16/83. Statutory Authority: RCW 70.98.050. 81-01-011 (Order 1570), § 402-16-230, filed 12/8/80; Order 1084, § 402-16-230, filed 1/14/76. Formerly WAC 402-16-020 and 402-16-040.]

**WAC 246-224-040 Expiration of registration.** Except as provided by WAC 246-224-050(2) each registration shall expire at the end of the day on the date stated therein.

[Statutory Authority: RCW 70.98.050. 94-01-073, § 246-224-040, filed 12/9/93, effective 1/9/94. Statutory Authority: RCW 70.98.050 and 70.98.080. 91-15-083 (Order 183), § 246-224-040, filed 7/23/91, effective 8/23/91. Statutory Authority: RCW 43.70.040. 91-02-049 (Order 121), recodified as § 246-224-040, filed 12/27/90, effective 1/31/91. Statutory Authority: RCW 70.98.080. 83-19-050 (Order 2026), § 402-16-234, filed 9/16/83. Statutory Authority: RCW 70.98.050. 81-01-011 (Order 1570), § 402-16-234, filed 12/8/80.]

**WAC 246-224-050 Renewal of registration.** (1) Application for renewal of registration shall be filed in accordance with WAC 246-224-020 and 246-254-053 at least thirty days prior to the expiration date.

(2) In any case in which a registrant not less than thirty days prior to the expiration of his existing registration has filed an application in proper form for renewal, such existing registration shall not expire until the application status has been determined by the department.

[Statutory Authority: RCW 70.98.050. 94-01-073, § 246-224-050, filed 12/9/93, effective 1/9/94. Statutory Authority: RCW 70.98.050 and 70.98.080. 91-15-083 (Order 183), § 246-224-050, filed 7/23/91, effective 8/23/91. Statutory Authority: RCW 43.70.040. 91-02-049 (Order 121), recodified as § 246-224-050, filed 12/27/90, effective 1/31/91. Statutory Authority: RCW 70.98.080. 83-19-050 (Order 2026), § 402-16-238, filed 9/16/83. Statutory Authority: RCW 70.98.050. 81-01-011 (Order 1570), § 402-16-238, filed 12/8/80.]

**WAC 246-224-060 Separate locations.** Geographically separate facilities must be registered separately and pay full fees as described under WAC 246-254-053, even if these geographically separate facilities are under one administrative control. Where, as a routine part of the normal conduct of business, registrable items are moved between or among such locations, the registrant will so indicate at the time of registration. Each registrant shall name one or more designated persons, preferably one for each location where the registrant is not normally present, who may be contacted by the department with respect to the requirements for registration.

[Statutory Authority: RCW 70.98.050 and 70.98.080. 91-15-083 (Order 183), § 246-224-060, filed 7/23/91, effective 8/23/91. Statutory Authority: RCW 43.70.040. 91-02-049 (Order 121), recodified as § 246-224-060, filed 12/27/90, effective 1/31/91. Statutory Authority: RCW 70.98.080. 83-19-050 (Order 2026), § 402-16-240, filed 9/16/83. Statutory Authority: RCW 70.98.050. 81-01-011 (Order 1570), § 402-16-240, filed 12/8/80; Order 1084, § 402-16-240, filed 1/14/76. Formerly WAC 402-16-050.]

**WAC 246-224-070 Report of changes.** The registrant shall notify the department in writing when making any change which would render the information contained in the application for registration no longer accurate. Notifications shall be sent to X-Ray Control Section, Department of Health, P.O. Box 47827, Olympia, WA 98504-7827. Notification shall be sent no later than thirty days after such change in the registration information.

[Statutory Authority: RCW 70.98.050. 94-01-073, § 246-224-070, filed 12/9/93, effective 1/9/94. Statutory Authority: RCW 70.98.050 and 70.98.080. 91-15-083 (Order 183), § 246-224-070, filed 7/23/91, effective 8/23/91. Statutory Authority: RCW 43.70.040. 91-02-049 (Order 121), recodified as § 246-224-070, filed 12/27/90, effective 1/31/91. Statutory Authority: RCW 70.98.080. 83-19-050 (Order 2026), § 402-16-250, filed 9/16/83. Statutory Authority: RCW 70.98.050. 81-01-011 (Order 1570), § 402-16-250, filed 12/8/80; Order 1084, § 402-16-250, filed 1/14/76. Formerly WAC 402-16-060.]

**WAC 246-224-080 Approval not implied.** A person shall neither refer, in any advertisement, to the fact that a facility is registered with the department pursuant to the provisions of WAC 246-224-020, nor imply that any activity under such registration has been approved by the department.

[Statutory Authority: RCW 70.98.050 and 70.98.080. 91-15-083 (Order 183), § 246-224-080, filed 7/23/91, effective 8/23/91. Statutory Authority: RCW 43.70.040. 91-02-049 (Order 121), recodified as § 246-224-080, filed 12/27/90, effective 1/31/91; Order 1084, § 402-16-260, filed 1/14/76. Formerly WAC 402-16-070.]

**WAC 246-224-090 Repair person, assembler, or installer obligation.** (1) Any person who sells, leases, transfers, lends, disposes, assembles, or installs radiation machines in this state shall notify the department within fifteen calendar days of:

(a) The name and address of persons who have received these machines;



(b) The manufacturer, model, and serial number of the master control of each radiation machine transferred; and

(c) The date of transfer of each radiation machine.

(2) No person shall make or install radiation machines, accessories used in connection with such machines or any components of such machines unless:

(a) Such machines, accessories, or components meet the requirements of these regulations.

(b) The registrant or transferee using such machines, accessories, or components has met the requirements of WAC 246-225-030, when applicable, prior to the date of transfer.

(c) Shielding and/or construction requirements, as determined pursuant to WAC 246-225-030 when applicable, have been completed prior to the date of transfer of such machines, accessories, or components.

(3) When requested by the registrant to make repair on an x-ray system that has malfunctioned in such a manner to have caused, or possibly caused an unintentional radiation exposure to patients, operator or member of the public, the assembler, transferor or installer, is required to notify the department of such work within twenty-four hours, or before repair is effected, whichever comes first. See WAC 246-225-010 for definition of accidental radiation exposure and electronic product defect.

(4) Certified x-ray systems (21 CFR, subchapter J) shall be assembled in such a manner that manufacturer's specifications and intended performance designs are met.

[Statutory Authority: RCW 70.98.050 and 70.98.080. 91-15-083 (Order 183), § 246-224-090, filed 7/23/91, effective 8/23/91. Statutory Authority: RCW 43.70.040. 91-02-049 (Order 121), recodified as § 246-224-090, filed 12/27/90, effective 1/31/91. Statutory Authority: RCW 70.98.080. 83-19-050 (Order 2026), § 402-16-270, filed 9/16/83. Statutory Authority: RCW 70.98.050. 81-01-011 (Order 1570), § 402-16-270, filed 12/8/80; Order 1084, § 402-16-270, filed 1/14/76. Formerly WAC 402-16-090.]

#### **WAC 246-224-100 Out-of-state radiation machines.**

(1) Whenever any radiation machine is to be brought into the state, for any temporary use, the person proposing to bring such machine into the state shall give written notice to the department at least three working days before such machine is to be used in the state. The notice shall include the type of radiation machine; the nature, duration, and scope of use; and the exact location(s) where the radiation machine is to be used. If for a specific case the three working-day period would impose an undue hardship, the person may, upon application to the department, obtain permission to proceed sooner.

(2) In addition the out-of-state person shall:

(a) Comply with all applicable regulations of the department.

(b) Supply the department such other information as the department may reasonably request.

(3) X-ray machines not intended for patient diagnosis and treatment may operate within the state without registration and fee payment if such operation is less than or equal to sixty days per calendar year. If operation in excess of sixty calendar days is desired, standard registration and fee procedures are required (see WAC 246-224-020 and 246-254-053).

(4) Standard registration and fee payment are required for all medical and dental x-ray machine operation within the state regardless of number of days of such operation.

[Statutory Authority: RCW 70.98.050 and 70.98.080. 91-15-083 (Order 183), § 246-224-100, filed 7/23/91, effective 8/23/91. Statutory Authority: RCW 43.70.040. 91-02-049 (Order 121), recodified as § 246-224-100, filed 12/27/90, effective 1/31/91. Statutory Authority: RCW 70.98.050. 81-01-011 (Order 1570), § 402-16-280, filed 12/8/80; Order 1084, § 402-16-280, filed 1/14/76. Formerly WAC 402-16-110.]

### **Chapter 246-225 WAC**

#### **RADIATION PROTECTION—X-RAYS IN THE HEALING ARTS**

##### **WAC**

246-225-001	Purpose and scope.
246-225-010	Definitions.
246-225-020	General requirements—Administrative controls.
246-225-030	General requirements—Plan review.
246-225-040	General requirements for diagnostic x-ray systems.
246-225-050	Fluoroscopic x-ray systems.
246-225-060	Radiographic systems other than fluoroscopic, dental intraoral, or veterinary systems—Beam limitation.
246-225-070	Radiographic systems other than fluoroscopic, dental intraoral, or veterinary systems—Radiation exposure control devices.
246-225-080	Radiographic systems other than fluoroscopic, dental intraoral, or veterinary systems—Source-to-skin or receptor distance.
246-225-090	Radiographic systems other than fluoroscopic and dental intraoral—Exposure reproducibility.
246-225-100	Radiographic systems—Standby radiation from capacitor energy storage equipment.
246-225-110	Intraoral dental radiographic systems.
246-225-120	Therapeutic x-ray installations less than 1 MeV.
246-225-130	X-ray and electron therapy systems with energies of one MeV and above.
246-225-140	Veterinary medicine radiographic installations.
246-225-150	X-ray film developing requirements.
246-225-160	Mammography.
246-225-99910	Appendix I—Good practices.
246-225-99920	Appendix II—Determination of competency.
246-225-99930	Appendix III—Information to be submitted by persons proposing to conduct healing arts screening using ionizing radiation.

**WAC 246-225-001 Purpose and scope.** This chapter establishes requirements, for which a registrant is responsible, for use of x-ray equipment by or under the supervision of an individual authorized by and licensed in accordance with state statutes to engage in the healing arts. The provisions of this chapter are in addition to, and not in substitution for, other applicable provisions of these regulations.

[Statutory Authority: RCW 43.70.040. 91-02-049 (Order 121), recodified as § 246-225-001, filed 12/27/90, effective 1/31/91. Statutory Authority: RCW 70.98.050. 81-01-011 (Order 1570), § 402-28-010, filed 12/8/80; Order 1084, § 402-28-010, filed 1/14/76; Order 1, § 402-28-101 (codified as WAC 402-28-010), filed 1/8/69; Rules (part), filed 10/26/66.]

**WAC 246-225-010 Definitions.** As used in this chapter, the following definitions apply:

(1) "Accessible surface" means the external surface of the enclosure or housing provided by the manufacturer.

(2) "Accidental radiation exposure incident" means an exposure to a patient, an operator, or a member of the public that was unintentional.

(3) "Added filter" means the filter added to the inherent filtration.

(4) "Aluminum equivalent" means the thickness of aluminum (type 1100 alloy) affording the same attenuation, under specified conditions, as the material in question. (The nominal chemical composition of type 1100 aluminum alloy is 99.00 percent minimum aluminum, 0.12 percent copper.)

(5) "Assembler" means any person engaged in the business of assembling, replacing, or installing one or more components into an x-ray system or subsystem. An assembler may be the practitioner, his/her employee, an outside contractor, or an employee of an outside firm.

(6) "Attenuation block" means a block or stack, having dimensions 20 cm by 20 cm by 3.8 cm, of type 1100 aluminum alloy or other aluminum alloys having equivalent attenuation.

(7) "Automatic exposure control" means a device which automatically controls one or more technique factors in order to obtain at a preselected location(s) a required quantity of radiation (see also "phototimer").

(8) "Barrier" (see "protective barrier").

(9) "Beam axis" means a line from the source through the centers of the x-ray fields.

(10) "Beam-limiting device" means a device which provides a means to restrict the dimensions of the x-ray field.

(11) "Beam monitoring system" means a system designed to detect and measure the radiation present in the useful beam.

(12) "C-arm x-ray system" means an x-ray system in which the image receptor and x-ray tube housing assembly are connected by a common mechanical support system in order to maintain a desired spatial relationship. This system is designed to allow a change in the projection of the beam through the patient without a change in the position of the patient.

(13) "Cephalometric device" means a device intended for the radiographic visualization and measurement of the dimensions of the human head.

(14) "Certified components" means components of x-ray systems which have been certified by the manufacturer as meeting the requirements of the federal performance standard for x-ray equipment.

(15) "Certified system" means any x-ray system which has one or more certified component(s).

(16) "Changeable filters" means any filter, exclusive of inherent filtration, which can be removed from the useful beam through any electronic, mechanical or physical process.

(17) "Coefficient of variation (C)" means the ratio of the standard deviation to the mean value of a population of observations. It is estimated using the following equation:

$$C = \frac{s}{\bar{X}} = \frac{1}{\bar{X}} \left[ \frac{\sum_{i=1}^n (X_i - \bar{X})^2}{n-1} \right]^{1/2}$$

where

s = Estimated standard deviation of the population.

X = Mean value of observations in sample.

X(i) = i<sup>th</sup> observation sampled.

n = Number of observations in sample.

(18) "Contact therapy system" means an x-ray system wherein the x-ray tube port is put in contact with or within 5 centimeters of, the surface being treated.

(19) "Control panel" means that part of the x-ray control upon which are mounted the switches, knobs, pushbuttons, and other hardware necessary for manually setting the technique factors.

(20) "Cooling curve" means the graphical relationship between heat units stored and cooling time.

(21) "Date of transfer." See installation date.

(22) "Dead-man switch" means a switch so constructed that a circuit closing contact can be maintained only by continuous pressure on the switch by the operator.

(23) "Department" means the department of health which has been designated as the state radiation control agency.

(24) "Detector" (see "radiation detector").

(25) "Diagnostic source assembly" means the tube housing assembly with a beam-limiting device attached.

(26) "Diagnostic x-ray system" means an x-ray system designed for irradiation of any part of the human or animal body for the purpose of recording or visualization for diagnostic purposes.

(27) "Direct scattered radiation" means that scattered radiation which has been deviated in direction only by materials irradiated by the useful beam (see also "scattered radiation").

(28) "Electronic product defect" means an error in design, manufacture, or performance of an x-ray system such that unintentional radiation exposure to a patient, an operator, or a member of the public has occurred.

(29) "Entrance exposure rate" means the exposure measured free-in-air per unit time where the useful beam enters the patient.

(30) "Equipment" (see "x-ray equipment").

(31) \*"Exposure" means the quotient of dQ divided by dm where dQ is the absolute value of the total charge of the ions of one sign produced in air when all the electrons (negatrons and positrons) liberated by photons in a volume element of air having mass dm are completely stopped in air. (The special unit of exposure is the roentgen.)

Note: \*When the word, exposure, is used in this part to mean one or more irradiations of a person for a healing arts purpose, or in a more general sense, it will not be underlined.

(32) "Field emission equipment" means equipment which uses an x-ray tube in which electron emission from the cathode is due solely to the action of an electric field.

(33) "Filter" means material placed in the useful beam to absorb preferentially selected radiations.

(34) "Fluoroscopic imaging assembly" means a component which comprises a reception system in which x-ray photons produce a fluoroscopic image. It includes equipment housings, electrical interlocks if any, the primary protective barrier, and structural material providing linkage between the image receptor and the diagnostic source assembly.

(35) "Focal spot" means the area on the anode of the x-ray tube bombarded by the electrons accelerated from the cathode, and from which the useful beam originates.

(36) "Full beam detector" means a radiation detector of such size that the total cross section of the maximum size useful beam is intercepted.

(37) "General purpose radiographic x-ray system" means any radiographic x-ray system which, by design, is not limited to radiographic examination of specific anatomical regions.

(38) "Gonad shield" means a protective barrier for the testes or ovaries.

(39) "Half-value layer (HVL)" means the thickness of specified material which attenuates the beam of radiation to an extent such that the exposure rate is reduced to one-half of its original value. In this definition the contribution of all scattered radiation, other than any which might be present initially in the beam concerned, is deemed to be excluded.

(40) "Healing arts screening" means the testing of an asymptomatic population using x-ray machines for the detection or evaluation of health indications when such tests are not specifically and individually ordered by a licensed practitioner of the healing arts legally authorized to prescribe such x-ray tests for the purpose of diagnosis or treatment.

(41) "Heat unit" means a unit of energy equal to the product of the peak kilovoltage, miliamperes, and seconds, i.e., kVp x mA x second.

(42) "Image intensifier" means a device consisting of an image intensifier tube installed in its housing which instantaneously converts an x-ray pattern into a light image of higher energy density.

(43) "Image receptor" means any device, such as a fluorescent screen or radiographic film, which transforms incident x-ray photons either into a visible image or into another form which can be made into a visible image by further transformations.

(44) "Image receptor support" means that part of a mammographic system designed to support the image receptor in a plane perpendicular to the x-ray beam during mammography.

(45) "Inherent filtration" means the filtration of the useful beam provided by the permanently installed components of the tube housing assembly.

(46) "Installation date" means the earliest date that a machine, accessory, or component is able to be used by a registrant or transferee but no later than the date of the first human exposure made using the machine, accessory, or component that has been installed.

(47) "Interlock" means a device arranged or connected such that the occurrence of an event or condition is required before a second event or condition can occur or continue to occur.

(48) "Irradiation" means the exposure of matter to ionizing radiation.

(49) "Kilovolts peak (kVp)" (see "peak tube potential").

(50) "kV" means kilovolts.

(51) "kWs" means kilowatt second which is equal to the product of peak kilovolts, amperes, and seconds or  $10^{-3}$  X kV X mA X sec.

(52) "Lead equivalent" means the thickness of lead affording the same attenuation, under specified conditions, as the material in question.

(53) "Leakage radiation" means radiation emanating from the diagnostic or therapeutic source assembly except for:

(a) The useful beam and

(b) Radiation produced when the exposure switch or timer is not activated.

(54) "Leakage technique factors" means the technique factors associated with the tube housing assembly which are used in measuring leakage radiation. They are defined as follows:

(a) For capacitor energy storage equipment, the maximum rated peak tube potential and the maximum rated number of exposures in an hour for operation at the maximum rated peak tube potential with the quantity of charge per exposure being 10 milliamperes seconds, or the minimum obtainable from the unit, whichever is larger.

(b) For field emission equipment rated for pulsed operation, the maximum rated peak tube potential and the maximum rated number of x-ray pulses in an hour for operation at the maximum rated peak tube potential.

(c) For all other equipment, the maximum rated peak tube potential and the maximum rated continuous tube current for the maximum rated peak tube potential.

(55) "Light field" means that area of the intersection of the light beam from the beam-limiting device and one of the set of planes parallel to and including the plane of the image receptor, whose perimeter is the locus of points at which the illumination is one-fourth of the maximum in the intersection.

(56) "Line-voltage regulation" means the difference between the no-load and the load line potentials expressed as a percent of the load line potential; that is,

$$\text{Percent line-voltage regulation} = 100 (V_n - V_l) / V_l$$

where:

$V_{(n)}$  = No-load line potential

$V_{(l)}$  = Load line potential

(57) "mA" means tube current in milliamperes.

(58) "mAs" means milliamperes second or the product of the tube current in milliamperes and the time of exposure in seconds.

(59) "Maximum line current" means the root mean squared current in the supply line of an x-ray machine operating at its maximum rating.

(60) "Mobile equipment" (see "x-ray equipment").

(61) "Modified installation" means a room, building, office, or facility in which structural parameters which affect radiation safety are being changed; these parameters include such things as reconstruction or moving of walls, replacement of the x-ray machine with one of higher kVp or mA, a change in the direction of the beam, replacement of the control panel so that operator protection is adversely affected, a change in occupancy of adjacent areas, workload changes, etc.

(62) "New installation" means a room, building, office, or facility newly built, or in which previously there has been no radiation machine.

(63) "Peak tube potential" means the maximum value of the potential difference across the x-ray tube during an exposure.

(64) "Phantom" means a volume of material similar to tissue with respect to attenuation and scattering of x-ray photons. This requires that the atomic number (Z) and the density of the material be similar to those of tissue.

(65) "Phototimer" - means a device which controls radiation exposure to the image receptor by detecting the total amount of radiation reaching the device. The radiation monitoring device(s) is part of an electronic circuit which controls the time the tube is activated (see also "automatic exposure control").

(66) "Portable equipment" (see "x-ray equipment").

(67) "Position indicating device (PID)" means a device, on dental x-ray equipment which indicate the beam position and establishes a definite source-surface (skin) distance. The device may or may not incorporate or serve as a beam-limiting device.

(68) "Positive beam limitation" means the automatic or semi-automatic adjustment of an x-ray beam to the selected image receptor size, whereby exposures cannot be made without such adjustment.

(69) "Primary protective barrier" (see "protective barrier").

(70) "Protected area" means a shielded area in which attenuation of x-radiation is sufficient to meet the exposure limits of WAC 246-221-010 and the principles of WAC 246-220-007 and "ALARA" for individuals in that area.

(71) "Protective apron" means an apron made of radiation absorbing materials, used to reduce radiation exposure.

(72) "Protective barrier" means a barrier of radiation absorbing material(s) used to reduce radiation exposure.

(a) "Primary protective barrier" means the material, excluding filters, placed in the useful beam, to protect anyone other than the patient from radiation exposure.

(b) "Secondary protective barrier" means a barrier sufficient to attenuate the stray radiation to the required degree.

(73) "Protective glove" means a glove made of radiation absorbing materials used to reduce radiation exposure.

(74) "Quality assurance" is a program designed to produce high quality radiographs at minimal cost and minimal patient exposure.

(75) "Quality control" is the routine measurement of the performance of the diagnostic x-ray imaging system, from x-ray beam output to the viewing of radiographs, and the continual adjustment of that performance to an optimal and consistent level.

(76) "Radiation detector" means a device which in the presence of radiation provides by either direct or indirect means, a signal or other information suitable for use in measuring one or more quantities of incident radiation.

(77) "Radiation safety" means efforts directed at occupational exposure reduction, patient exposure reduction, image quality improvement, diagnostic imaging system quality assurance, radiation measurements, dose evaluations, compliance with state and federal regulations, and related issues.

(78) "Radiation therapy simulation system" means a fluoroscopic or radiographic x-ray system intended for

localizing the volume to be exposed during radiation therapy and confirming the position and size of the therapeutic irradiation field.

(79) "Radiograph" means an image receptor on which the image is created directly or indirectly by an x-ray pattern and results in a permanent record.

(80) "Radiographic imaging system" means any system whereby a permanent or temporary image is recorded on an image receptor by the action of ionizing radiation.

(81) "Rating" means the operating limits of an x-ray system or subsystem as specified by the component manufacturer.

(82) "Recording" means producing a permanent form of an image resulting from x-ray photons (e.g., film, video tape).

(83) "Response time" means the time required for an instrument system to reach 90 percent of its final reading when the radiation-sensitive volume of the instrument system is exposed to a step change in radiation flux from zero sufficient to provide a steady state midscale reading.

(84) "Scattered radiation" means radiation that, during passage through matter, has been deviated in direction (see also "direct scattered radiation").

(85) "Secondary protective barrier" (see "protective barrier").

(86) "Shutter" means a device attached to the tube housing assembly which can totally intercept the entire cross sectional area of the useful beam and which has a lead equivalency at least that of the tube housing assembly.

(87) "SID" (see "source-image receptor distance").

(88) "Source" means the focal spot of the x-ray tube.

(89) "Source-image receptor distance (SID)" means the distance from the source to the center of the input surface of the image receptor.

(90) "Source-to-skin-distance (SSD)" means the distance between the source and the skin entrance plane of the patient.

(91) "Special purpose x-ray equipment" means that which is designed for radiographic examination of one specific area of the body.

(92) "Spot check" means an abbreviated calibration procedure which is performed to assure that a previous calibration continues to be valid.

(93) "Spot film device" means a device intended to transport and/or position a radiographic image receptor between the x-ray source and fluoroscopic image receptor, including a device intended to hold a cassette over the input end of an image intensifier for the purpose of making a radiograph.

(94) "Spot film" means a radiograph which is made during a fluoroscopic examination to record permanently conditions which exist during that fluoroscopic procedure.

(95) "Stationary equipment" (see "x-ray equipment").

(96) "Stray radiation" means the sum of leakage and scattered radiation.

(97) "Technique factors" means the conditions of operation. They are specified as follows:

(a) For capacitor energy storage equipment, peak tube potential in kV and quantity of charge in mAs.

(b) For field emission equipment rated for pulsed operation, peak tube potential in kV and number of x-ray pulses.

(c) For all other equipment, peak tube potential in kV and:

(i) Either tube current in mA and exposure time in seconds,

(ii) Or the product of tube current and exposure time in mAs.

(98) "Transmission detector" means a radiation detector through which the useful beam or part of the useful beam passes.

(99) "Treatment volume" means the region, in the patient, to which a specified dose is to be delivered.

(100) "Tube" means an x-ray tube, unless otherwise specified.

(101) "Tube housing assembly" means the tube housing with tube installed. It includes high-voltage and/or filament transformers and other appropriate elements when they are contained within the tube housing.

(102) "Tube rating chart" means the set of curves which specify the rated limits of operation of the tube in terms of the technique factors.

(103) "Useful beam" means the radiation which passes through the tube housing port and the aperture of the beam-limiting device when the exposure switch or timer is activated.

(104) "Variable-aperture beam-limiting device" means a beam-limiting device which has capacity for stepless adjustment of the x-ray field size.

(105) "Visible area" means that portion of the input surface of the image receptor over which incident x-ray photons produce a visible image.

(106) "Wedge filter" means an added filter with changing radio-opacities used to achieve more uniform optical densities on the image receptor when a body part of varying absorption characteristics is radiographed.

(107) "X-ray control" means a device which controls input power to the x-ray high-voltage generator and/or the x-ray tube. It includes equipment which controls the technique factors of an x-ray exposure.

(108) "X-ray equipment" means an x-ray system, subsystem, or component thereof. Types of x-ray equipment are as follows:

(a) 'Mobile' means x-ray equipment mounted on a permanent base with wheels and/or casters for moving while completely assembled.

(b) 'Portable' means x-ray equipment designed to be hand-carried.

(c) 'Stationary' means x-ray equipment which is installed in a fixed location.

(109) "X-ray field" means that area of the intersection of the useful beam and any one of the set of planes parallel to and including the plane of the image receptor, whose perimeter is the locus of points at which the exposure rate is one-fourth of the maximum in the intersection.

(110) "X-ray high-voltage generator" means a device which transforms electrical energy from the potential supplied by the x-ray control to the tube operating potential. The device may also include means for transforming alternating current to direct current, filament transformers for the x-ray tube(s), high-voltage switches, electrical protective devices, and other appropriate elements.

(111) "X-ray system" means an assemblage of components for the controlled production of x-rays. It includes

minimally an x-ray high-voltage generator, an x-ray control, a tube housing assembly, a beam-limiting device, and the necessary supporting structures. Additional components which function with the system are considered integral parts of the system.

(112) "X-ray subsystem" means any combination of two or more components of an x-ray system for which there are requirements specified in this part.

(113) "X-ray tube" means any electron tube which is designed to be used primarily for the production of x-rays.

[Statutory Authority: RCW 70.98.050 and 70.98.080. 91-15-083 (Order 183), § 246-225-010, filed 7/23/91, effective 8/23/91. Statutory Authority: RCW 43.70.040. 91-02-049 (Order 121), recodified as § 246-225-010, filed 12/27/90, effective 1/31/91. Statutory Authority: RCW 70.98.080. 83-19-050 (Order 2026), § 402-28-020, filed 9/16/83. Statutory Authority: RCW 70.98.050. 81-01-011 (Order 1570), § 402-28-020, filed 12/8/80; Order 1084, § 402-28-020, filed 1/14/76; Order 1, § 402-28-020, filed 1/8/69; Rules (part), filed 10/26/66.]

**WAC 246-225-020 General requirements—Administrative controls.** (1) No person shall make, sell, lease, transfer, lend, or install x-ray equipment or the accessories used in connection with such equipment unless such accessories and equipment, when properly placed in operation and properly used, shall meet the requirements of this chapter.

(2) The registrant in control of the x-ray machines shall be responsible for directing the operation of the x-ray machines. The registrant or registrant's agent shall assure the following provisions are met in the operation of the x-ray machine or machines:

(a) The registrant shall not operate an x-ray machine for diagnostic or therapeutic purposes when the x-ray machine:

(i) Does not meet the provisions of this chapter; or  
(ii) Is malfunctioning and threatens the health or safety of the patient, operator, or general public.

(b) X-ray machine operator requirements.

(i) Individuals operating the x-ray equipment shall be adequately instructed in safe operating procedures and shall be able to demonstrate competence, upon request from the department, in the correct use of the equipment. Required areas of competence are listed in Appendix II. The department may determine compliance with subsection (2)(b) of this section by observation, interview, or testing;

(ii) A medical x-ray machine operator shall be licensed, certified or registered by the department as either:

(A) A health care practitioner, licensed under Title 18 RCW; or

(B) A diagnostic or therapeutic radiologic technologist certified in accordance with chapter 18.84 RCW; or

(C) An x-ray technician registered in accordance with chapter 18.84 RCW.

(c) At each x-ray system's control panel, a chart shall be provided which specifies for the examinations performed by that system the following information:

(i) Patient's anatomical size versus technique factors utilized;

(ii) Source to image receptor distance used;

(iii) Type and placement of patient shielding used, for example, gonad, thyroid, lap apron;

(iv) If applicable, settings for automatic exposure devices; and

(v) Type and size of film or screen-film combination to be used.

(d) When required by the department, a registrant shall create and provide to operators of the x-ray system, radiation safety procedures which address patient and occupationally-exposed personnel safety. These procedures shall define restrictions of the operating technique required for safe operation of the particular x-ray system;

(e) Except for patients who cannot be moved out of the room and the patient being examined, only the staff and ancillary personnel required for the medical procedure or training shall be present in the room during the radiographic exposure. Other than the patient being examined:

(i) All individuals shall be positioned such that no part of the body including the extremities not protected by 0.5 mm lead equivalent will be struck by the useful beam;

(ii) The x-ray operator, other staff and ancillary personnel shall be protected from the direct scatter radiation by protective aprons or whole body protective barriers of not less than 0.25 mm lead equivalent;

(iii) Patients who cannot be removed from the room shall be:

(A) Protected from the direct scatter radiation by whole body protective barriers of not less than 0.25 mm lead equivalent; or

(B) Positioned so the nearest portion of the body is at least 2 meters from both the tube head and the nearest edge of the image receptor.

(iv) The department may require additional protective devices when a portion of the body of staff or ancillary personnel is potentially subjected to stray radiation which may result in that individual receiving one quarter of the maximum permissible dose defined under WAC 246-221-010.

(f) Gonad shielding of not less than 0.5 mm lead equivalent shall be used for patients of reproductive age during radiographic procedures in which the gonads are in the direct (useful) beam, except for cases when gonad shielding may interfere with the diagnostic procedure;

(g) Persons shall not be exposed to the useful beam except for healing arts purposes. Only a licensed practitioner of the healing arts shall authorize an exposure to the useful beam. This requirement prohibits deliberate exposure for the following purposes:

(i) Exposure of an individual for training, demonstration, or other purposes unless there are also healing arts requirements and proper prescription is provided;

(ii) Except for mammography performed by registered facilities on self-referred patients, the exposure of an individual for the purpose of healing arts screening without prior written approval of the state health officer; and

(iii) Exposure of an individual for the sole purpose of satisfying a third party's prerequisite for reimbursement under any health care plan, except for exposure required under Medicare provisions.

(h) When a patient or film must be provided with auxiliary support during a radiation exposure:

(i) Mechanical holding devices shall be used when the technique permits. The safety rules, when required under subdivision (d) of this subsection, shall list individual projections where holding devices cannot be utilized;

(ii) Written safety procedures, when required under subdivision (d) of this subsection, shall indicate the requirements for selecting a human holder and the procedure the holder shall follow;

(iii) The human holder shall be protected as required under subdivision (e)(i) of this subsection;

(iv) No person shall be used routinely to hold film or patients;

(v) When the patient must hold the film, the portion of the body other than the area of clinical interest struck by the useful beam shall be protected by not less than 0.5 mm lead equivalent material;

(vi) Holding the film or the patient shall be permitted only in very unusual and rare situations.

(i) Personnel dosimetry. All persons associated with the operation of an x-ray system are subject to both the occupational exposure limits and the requirements for the determination of the doses stated under WAC 246-221-020. In addition, when protective clothing or devices are worn on portions of the body and a dosimeter is required, at least one such dosimeter shall be utilized as follows:

(i) When an apron is worn, the monitoring device shall be worn at the collar outside of the apron; and

(ii) The dose to the whole body based on the maximum dose attributed to the most critical organ shall be recorded on the reports required under WAC 246-221-230. If more than one device is used or a record is made of the data, each dose shall be identified with the area where the device was worn on the body.

(iii) Personnel monitoring of an operator shall be required where:

(A) Exposure switch cords are utilized that allow the operator to stand in an unprotected area during exposures; and

(B) Measurements by the department show ten percent of the exposure limits as specified under WAC 246-221-010 may be exceeded.

(iv) All persons involved in the operation of a fluoroscope and working within the fluoroscopy room during its operation shall wear a personnel dosimeter required under WAC 246-221-090 and subsection (2)(i)(i) of this section. If extremities are in or near the primary beam, extremity dosimeters are also required;

(j) Healing arts screening utilizing radiation. Any person proposing to conduct a healing arts screening program, with the exception of a mammography program, shall not initiate such a program without prior approval of the state health officer. When requesting such approval, that person shall submit the information outlined under Appendix III of this part. If information submitted becomes invalid or outdated, the state health officer shall be notified immediately;

(k) When using scatter suppressing grids, the grids shall be:

(i) Clearly labelled with the focal distance for which they are designed to be used; and

(ii) Of the proper focal distance for the source-to-image distances used.

(l) Procedures and auxiliary equipment designed to minimize patient and personnel exposure commensurate with the needed diagnostic information shall be utilized.



(i) Film cassettes without intensifying screens shall not be used for any routine diagnostic radiological imaging.

(ii) Portable or mobile x-ray equipment shall be used only for examinations where it is impractical to transfer the patient(s) to a stationary x-ray installation.

(m) Patient log. A medical x-ray facility (chiropractors, allopathic and osteopathic physicians and hospitals only) shall record for each x-ray diagnosis or treatment the patient's name, type of x-ray procedures performed, and the date. A separate log is not necessary if the required information is retrievable by reference to other records.

[Statutory Authority: RCW 70.98.050. 94-06-017, § 246-225-020, filed 2/22/94, effective 3/25/94. Statutory Authority: RCW 70.98.050 and 70.98.080. 91-15-083 (Order 183), § 246-225-020, filed 7/23/91, effective 8/23/91. Statutory Authority: RCW 43.70.040. 91-02-049 (Order 121), recodified as § 246-225-020, filed 12/27/90, effective 1/31/91. Statutory Authority: RCW 70.98.080. 87-01-031 (Order 2450), § 402-28-031, filed 12/11/86; 83-19-050 (Order 2026), § 402-28-031, filed 9/16/83. Statutory Authority: RCW 70.98.050. 81-01-011 (Order 1570), § 402-28-031, filed 12/8/80; Order 1084, § 402-28-031, filed 1/14/76. Formerly WAC 402-28-030 (part).]

**WAC 246-225-030 General requirements—Plan review.** (1) Before construction, the floor plans and equipment arrangement of medical installations (new or modifications of existing installations) utilizing x-rays for diagnostic or therapeutic purposes shall be submitted to:

(a) A qualified expert for determination of shielding requirements using National Council on Radiation Protection and Measurements Report No. 49, or equivalent; and

(b) The department for subsequent review.

Review shall not imply approval.

(2) The review of such plans shall not preclude the requirement of additional modifications should a subsequent analysis of operating conditions indicate the possibility of an individual receiving a dose in excess of the limits required under WAC 246-221-010, 246-221-050, and 246-221-060.

(3) Diagnostic veterinary, podiatric, and dental facilities shall be exempt from submitting shielding calculations and floor plans.

(4) In order for the department to provide an evaluation, technical advice, and official review of the shielding requirements for a medical radiation installation, a floor plan drawn to scale and the following data are required:

(a) The normal location of the x-ray tube, along with an indication of anode-cathode orientation to the cassette holders;

(b) The limits of the tube travel;

(c) The directions in which the tube is pointed;

(d) Window locations;

(e) The location of the control booth or operator's position;

(f) The exposure switch location;

(g) The position of the viewing window, if any;

(h) The composition and thickness of the walls;

(i) If more than one story, the height floor-to-floor;

(j) If more than one story, the composition and thickness of materials in the ceiling or floor;

(k) The make and model of the x-ray machine;

(l) The maximum kVp and mA;

(m) The types of examinations or treatments (for example, chest, spine, general x-ray, or therapy);

(n) The identification and occupancy of areas adjacent to the x-ray room;

(o) The anticipated x-ray workload expressed in number of patients and exposures per week including:

(i) Technique factors used, or milliamperes-seconds or milliamperes-minutes per week; and

(ii) Estimates of the percentage of the workload expected to occur for a particular beam direction.

(5) For new and modified installations only, the following are minimum design requirements for medical x-ray machine operator booths. These requirements do not apply to dental, podiatry, and veterinary installations. See subsections (6) and (7) of this section for dental panoramic and cephalometric requirements.

(a) The operator shall be allotted 0.7 sq. meters (7.5 sq. ft.) or more of unobstructed floor space in the x-ray booths.

(i) The 0.7 sq. meters (7.5 sq. ft.) of minimum space specified under subsection (5)(a) of this section shall be a geometric configuration where no dimension is less than 61.0 centimeters (2.0 ft.).

(ii) The allotted space shall exclude an encumbrance by the console, such as an overhang, cables, or other similar encroachment.

(iii) An extension of a straight line drawn between any point on the edge of the booth shielding and the nearest vertical edge of a vertical cassette holder, corner of the examination table, or any part of the tube housing assembly shall not impinge on the unobstructed space.

(iv) The booth walls shall be 2.1 meters (7.0 ft.) or more and shall be permanently fixed to the floor or other structure as may be necessary.

(v) When a door or moveable panel is used as the integral part of the booth structure, it must have a permissive device which will prevent an exposure when the door or panel is not closed.

(b) Switch placement. The operator's switch for the radiographic machine shall be fixed within the booth. The switch shall:

(i) Be at least 102 centimeters (forty inches) inside the protected area; and

(ii) Allow the operator to use the available viewing windows.

(c) Viewing system requirements.

(i) Each booth shall have at least one viewing device which shall:

(A) Be placed so the operator can view the patient during exposure; and

(B) Be placed so the operator can have full view of the entries into the room.

(ii) When the viewing system is a window, the following requirements also apply:

(A) The window shall have a visible area of 930 square centimeters (1.0 square foot) or more; and

(B) The glass shall have the same lead equivalence or more as that required in the booth's wall where the glass is mounted.

(iii) When the viewing system is by mirrors, the mirrors shall be located to accomplish the general requirements under subdivision (i) of this subsection.

(iv) When the viewing system is by electronic means (for example, TV):



(A) The camera shall be located to accomplish the general requirements under subdivision (i) of this subsection; and

(B) There shall be an alternate viewing system as a backup for electronic failure.

(d) New or modified facilities shall maintain a copy of the floor plan and shielding calculations required under subsection (1) of this section.

(6) Dimensions of primary beam shielding shall exceed the largest possible beam size by 30.5 centimeters (one foot) or more in every direction. Cephalometric primary beam shielding shall be deemed adequate if, for a maximum workload of twenty films a week, two-pound lead is installed (for occupied areas).

(7) A viewing device shall be present in dental panoramic and cephalometric x-ray installations, so the requirements of subsection (5)(c) of this section are met.

[Statutory Authority: RCW 70.98.050, 94-01-073, § 246-225-030, filed 12/9/93, effective 1/9/94. Statutory Authority: RCW 70.98.050 and 70.98.080, 91-15-083 (Order 183), § 246-225-030, filed 7/23/91, effective 8/23/91. Statutory Authority: RCW 43.70.040, 91-02-049 (Order 121), recodified as § 246-225-030, filed 12/27/90, effective 1/31/91. Statutory Authority: RCW 70.98.080, 87-01-031 (Order 2450), § 402-28-032, filed 12/1/86; 83-19-050 (Order 2026), § 402-28-032, filed 9/16/83; Order 1084, § 402-28-032, filed 1/14/76. Formerly WAC 402-28-030 (part).]

**WAC 246-225-040 General requirements for diagnostic x-ray systems.** In addition to other requirements of this chapter, diagnostic x-ray systems shall meet the following requirements:

(1) *Warning label.* The control panel containing the main power switch shall bear the warning statement, legible and accessible to view: "WARNING: This x-ray unit may be dangerous to patient and operator unless safe exposure factors and operating instructions are observed."

(2) *Battery charge indicator.* On battery-powered generators, visual means shall be provided on the control panel to indicate the battery is in a state of charge adequate for proper operation.

(3) *Leakage radiation from the diagnostic source assembly.* The leakage radiation from the diagnostic source assembly, measured at a distance of 1 meter in any direction from the source, shall not exceed  $2.58 \times 10^{-5}$  coulombs per kilogram (100 milliroentgens) in one hour when the x-ray tube is operated at its leakage technique factors. Compliance shall be determined by measurements averaged over an area of one hundred square centimeters with no linear dimension greater than twenty centimeters.

(4) *Radiation from components other than the diagnostic source assembly.* The radiation emitted by a component other than the diagnostic source assembly shall not exceed  $5.16 \times 10^{-7}$  coulombs per kilogram (2 milliroentgens) in one hour at 5 centimeters from an accessible surface of the component when it is operated in an assembled x-ray system under conditions for which it was designed. Compliance shall be determined by measurements averaged over an area of 100 square centimeters with no linear dimension greater than 20 centimeters.

(5) *Beam quality.*

(a) The half-value layer (HVL) of the useful beam for a given x-ray tube potential shall not be less than the values shown in this section, Table I. If it is necessary to deter-

mine such half-value layer at an x-ray tube potential which is not listed in Table I, linear interpolation or extrapolation shall be made.

WAC 246-225-040 TABLE I

Design operating range (kilovolts peak)	Measured potential (kilovolts peak)	Half-value layer (millimeters of aluminum equivalent)	Half-value layer (millimeter of aluminum equivalent for dental units)
Below 51—	30	0.3	N/A
	40	0.4	N/A
	50	0.5	1.5
51 to 70—	51	1.2	1.5
	60	1.3	1.5
	70	1.5	1.5
Above 70—	71	2.1	2.1
	80	2.3	2.3
	90	2.5	2.5
	100	2.7	2.7
	110	3.0	3.0
	120	3.2	3.2
	130	3.5	3.5
140	3.8	3.8	
150	4.1	4.1	

(b) For capacitor energy storage equipment, compliance shall be determined with the system fully charged and a setting of at least 10 mAs for each exposure.

(c) The required minimal half-value layer shall include the filtration contributed by materials permanently in position between the focal spot of the tube and the patient. (For example, a table top when the tube is mounted "under the table" and inherent filtration of the tube)

(d) *Filtration control.* For x-ray systems with variable kVp and variable filtration for the useful beam, a device shall link the kVp selector with the filters and shall prevent an exposure unless the minimum amount of filtration required by subdivision (a) of this subsection is in the useful beam for the selected kVp.

(6) *Multiple tubes.* Where two or more radiographic tubes are controlled by one exposure switch, the tube or tubes selected shall be clearly indicated prior to initiation of the exposure. Such indication shall be both on the x-ray control panel and near or on the selected tube housing assembly.

(7) *Mechanical support of tube head.* The tube housing assembly supports shall be adjusted such that the tube housing assembly remains stable during an exposure unless the tube housing movement during exposure is a designed function of the x-ray system.

(8) *Technique indicators.*

(a) The technique factors used during an exposure shall be indicated before the exposure begins, except when automatic exposure controls are used, in which case the technique factors set prior to the exposure shall be indicated.

(b) On equipment having fixed technique factors, the requirement, under subdivision (a) of this subsection may be met by permanent markings. Indication of technique factors shall be visible from the operator's position except in the case of spot films made by the fluoroscopist.

(9) Certified units. All diagnostic x-ray systems certified to comply with 21 CFR 1020 shall meet the requirements of that certification.

(10) Linearity. The difference between the ratio of exposure to mAs at one mA or mAs setting and the ratio at another mA or mAs setting shall not exceed 0.10 times the sum of the ratios. This is written as:

$$X_1 - X_2 \leq 0.10 (X_1 + X_2)$$

Where  $X_1$  and  $X_2$  are the ratios (mR/mAs) for each mA or mAs station.

The test shall be performed at any selections of mA or mAs without regard to focal spot size, provided neither focal spot size is less than 0.45 millimeter.

(11) kVp accuracy. The difference between the indicated and actual kVp of an x-ray machine shall not be greater than ten percent of the indicated kVp, or, alternatively, if available, the accuracy specifications of the control panel manufacturer must be met.

[Statutory Authority: RCW 70.98.050. 94-01-073, § 246-225-040, filed 12/9/93, effective 1/9/94. Statutory Authority: RCW 70.98.050 and 70.98.080. 91-15-083 (Order 183), § 246-225-040, filed 7/23/91, effective 8/23/91. Statutory Authority: RCW 43.70.040. 91-02-049 (Order 121), recodified as § 246-225-040, filed 12/27/90, effective 1/31/91. Statutory Authority: RCW 70.98.080. 87-01-031 (Order 2450), § 402-28-035, filed 12/11/86; 83-19-050 (Order 2026), § 402-28-035, filed 9/16/83. Statutory Authority: RCW 70.98.050. 81-01-011 (Order 1570), § 402-28-035, filed 12/8/80; Order 1084, § 402-28-035, filed 1/14/76. Formerly WAC 402-28-030 (part).]

#### WAC 246-225-050 Fluoroscopic x-ray systems.

Fluoroscopic x-ray systems shall meet the following requirements:

(1) Limitation of useful beam.

(a) The fluoroscopic tube shall not produce x-rays unless the primary barrier is in position to intercept the entire useful beam at all times.

(b) The entire cross section of the useful beam shall be intercepted by the primary protective barrier of the fluoroscopic image assembly at any source-to-image-distance (SID).

(c) Nonimage-intensified fluoroscopic equipment shall not be used.

(d) For fluoroscopic equipment without a spot film device, neither the length nor the width of the fluoroscopic x-ray field in the plane of the image receptor shall exceed that of the visible area of the image receptor by more than three percent of the SID. The sum of the excess length and the excess width shall be no greater than four percent of the SID. Measurements shall be made at the minimum SID available but at no less than 20 centimeters (8 inches) table top to image receptor distance.

(e) For uncertified fluoroscopic equipment with a spot film device, the fluoroscopic x-ray beam with the shutters wide open (during either fluoroscopy itself or spot films) shall be no larger than the dimensions of the largest spot film size for which the device is designed. Measurements shall be made at the minimum SID available, but at no less than 20 centimeters (8 inches) table top to the film plane distance.

(f) For certified (21 CFR 1020) fluoroscopic equipment with a spot film device, neither the length nor the width of

the fluoroscopic x-ray field in the plane of the image receptor shall exceed that of the visible area of the image receptor by more than three percent of the SID. The sum of the excess length and width shall be no greater than four percent of the SID. Measurements shall be made at the minimum SID available, but at no less than 20 centimeters (8 inches) table top to film plane distance.

(g) Fluoroscopic equipment beam limitation:

(i) Means shall be provided to reduce the beam size at the plane of the image receptor to 125 square centimeters or less; and

(ii) The minimum field size at the greatest SID shall be equal to or less than 5 centimeters by 5 centimeters.

(2) *Activation of the fluoroscopic tube.* X-ray production in the fluoroscopic mode shall be controlled by a deadman switch.

(3) *Entrance exposure rate allowable limits.*

(a) For equipment with or without automatic brightness control, the exposure rate measured at the point where the center of the useful beam enters the patient shall not exceed  $2.58 \times 10^{-3}$  coulombs per kilogram per minute (ten roentgens per minute), except during film recording of fluoroscopic images or when an optional high level control (HLC) is activated.

(b) For equipment provided with HLC, the equipment shall not be operable at a combination of tube potential and current which will result in an exposure rate in excess of  $1.29 \times 10^{-3}$  coulombs per kilogram per minute (5 roentgens per minute) at the point where the center of the useful beam enters the patient, unless the HLC is activated.

(i) Special means of activation of high level controls, such as additional pressure applied continuously by the operator, shall be required to avoid accidental use.

(ii) A continuous signal audible to the fluoroscopist shall indicate the high level control is employed.

(c) Measuring compliance of entrance exposure rate limits. Compliance with subsection (3) of this section shall be determined as follows:

(i) Movable grids and compression devices shall be removed from the useful beam during the measurement;

(ii) If the source is below the table, exposure rate shall be measured 1 centimeter above the table top or cradle;

(iii) If the source is above the table, the exposure rate shall be measured at 30 centimeters above the table top with the end of the beam-limiting device or spacer positioned as closely as possible to the point of measurement;

(iv) In a C-arm type of fluoroscope, the exposure rate shall be measured 30 centimeters from the input surface of the fluoroscopic imaging assembly, with the source positioned at any available SID, provided the end of the beam-limiting device or spacer is no closer than 30 centimeters from the input surface of fluoroscopic imaging assembly; and

(v) In a lateral-type fluoroscope, the exposure rate shall be measured at a point 15 centimeters from the center line of the x-ray table with the end of the beam-limiting device or spacer positioned as closely as possible to the point of measurement. If the table top is movable, the table top shall be positioned as closely as possible to the lateral x-ray source, with the end of the beam-limiting device or spacer no closer than 15 centimeters to the center line of the x-ray table.

(d) Periodic measurement of entrance exposure rate limits.

(i) Periodic measurements of the exposure rate shall be made. An adequate period for such measurements shall be annually or after maintenance of the system affecting the exposure rate.

(ii) Results of exposure rate measurements shall be available where the fluoroscopist has ready access to the measurements while using that fluoroscope. Results of the measurements shall include:

(A) The maximum possible coulombs per kilogram per minute (R/minute), as well as the technique factors associated with it;

(B) The name of the person performing the measurements;

(C) The last date the measurements were performed; and

(D) The type of device used in making the measurements.

(iii) Conditions of measurement:

(A) The kVp shall be adjusted to that which will produce the maximum entrance exposure rate;

(B) The high level control, if present, shall not be activated;

(C) The x-ray systems that incorporate automatic exposure rate control (automatic brightness control) shall have sufficient material, for example, lead or lead equivalence, placed in the useful beam to produce the maximum output of the x-ray system; and

(D) X-ray systems not incorporating automatic exposure rate control shall utilize whatever combination of kVp, mA, and other selectable parameters that will generate the highest exposure rate of the x-ray system. Materials, for example, an attenuation block, may be placed in the useful beam to protect the imaging system, as long as the material does not affect the measurement of the exposure rate.

(4) *Barrier transmitted radiation rate limits.*

(a) The exposure rate due to transmission through the primary protective barrier with the attenuation block in the useful beam, combined with radiation from the image intensifier, if provided, shall not exceed  $5.16 \times 10^{-7}$  coulombs per kilogram per hour (2 milliroentgens per hour) for each  $2.58 \times 10^{-4}$  coulombs per kilogram per minute (roentgen per minute) of entrance exposure rate. The barrier transmission measurement shall be made at 10 centimeters from an accessible surface of the fluoroscopic imaging assembly beyond the plane of the image receptor.

(b) Measuring compliance of barrier transmission.

(i) The exposure rate due to transmission through the primary protective barrier combined with radiation from the image intensifier shall be determined by measurements averaged over an area of 100 square centimeters with no linear dimension greater than 20 centimeters.

(ii) If the source is below the table top, the measurement shall be made with the input surface of the fluoroscopic imaging assembly positioned 30 centimeters above the table top.

(iii) If the source is above the table top and the SID is variable, the measurement shall be made with the end of the beam-limiting device or spacer as close to the table top as it can be placed, provided the beam-limiting device or spacer shall not be closer than 30 centimeters.

(iv) Movable grids and compression devices shall be removed from the useful beam during the measurement.

(5) *Indication of potential and current.* During fluoroscopy and cinefluorography, x-ray tube potential and current shall be continuously indicated.

(6) *Source-skin distance (SSD).* The source to skin distance shall not be less than:

(a) 38 centimeters on stationary fluoroscopes;

(b) 30 centimeters on mobile fluoroscopes; and

(c) 20 centimeters for image intensified fluoroscopes used for specific surgical application. The user must provide precautionary measures for the use of the fluoroscope due to its short SSD.

(7) *Fluoroscopic timer.*

(a) Means shall be provided to preset the cumulative on-time of the fluoroscopic tube. The maximum cumulative time of the timing device shall not exceed five minutes without resetting.

(b) A signal audible to the fluoroscopist shall indicate the completion of a preset cumulative on-time. Such signal shall continue to sound while x-rays are produced until the timing device is reset. Alternatively, the timing device may terminate exposures at the end of the preset time.

(c) Total fluoroscopic on-time for each patient shall be recorded, either in patient's chart or in a separate log.

(8) *Control of scattered radiation.*

(a) Fluoroscopic table designs when combined with normal operating procedures shall be such that no unprotected part of staff or ancillary person's body shall be exposed to unattenuated scattered radiation which originates from under the table. The attenuation required shall be not less than 0.25 mm lead equivalent.

(b) Equipment configuration when combined with procedures shall be such that no portion of staff or ancillary person's body, except the extremities, shall be exposed to the unattenuated scattered radiation emanating from above the table top unless:

(i) The radiation has passed through not less than 0.25 mm lead equivalent material, for example, drapes, Bucky-slot cover-sliding or folding panel, or self-supporting curtains, in addition to lead equivalency provided by the protective apron referred to under WAC 246-225-020 (2)(e); and

(ii) Exceptions to subdivision (b) of this subsection may be made in some special procedures where a sterile field will not permit the use of the normal protective barriers. Where the use of prefitted sterilized covers for the barriers is practical, the department shall not permit such exception.

(9) *Radiation therapy simulation systems.* Radiation therapy simulation systems shall be exempt from the requirements of subsection (3) of this section. In addition, these systems shall be exempt from:

(a) Subsections (1) and (4) of this section provided such systems are designed and used in such a manner that no individual other than the patient is in the x-ray room when the system is producing x-rays; and

(b) Subsection (7) of this section if such systems are provided with a means of indicating the cumulative time that an individual patient has been exposed to x-rays.

[Statutory Authority: RCW 70.98.050. 94-01-073, § 246-225-050, filed 12/9/93, effective 1/9/94. Statutory Authority: RCW 70.98.050 and 70.98.080. 91-15-083 (Order 183), § 246-225-050, filed 7/23/91, effective

8/23/91. Statutory Authority: RCW 43.70.040, 91-02-049 (Order 121), recodified as § 246-225-050, filed 12/27/90, effective 1/31/91. Statutory Authority: RCW 70.98.080, 87-01-031 (Order 2450), § 402-28-040, filed 12/11/86; 83-19-050 (Order 2026), § 402-28-040, filed 9/16/83. Statutory Authority: RCW 70.98.050, 81-01-011 (Order 1570), § 402-28-040, filed 12/8/80; Order 1084, § 402-28-040, filed 1/14/76; Order 1, § 402-28-040, filed 1/8/69; Rules (part), filed 10/26/66.]

**WAC 246-225-060 Radiographic systems other than fluoroscopic, dental intraoral, or veterinary systems—Beam limitation.** The useful beam shall be limited to the area of clinical interest and show evidence of collimation. This shall be deemed to have been met if a positive beam limiting device has been properly used or if evidence of collimation is shown on at least three sides or three corners of the film, (for example, projections from the shutters of the collimator, cone cutting at the corners or a border at the film's edge).

(1) *General purpose stationary and mobile x-ray systems.*

(a) There shall be provided a means for stepless adjustment of the size of the x-ray field such that at least two dimensions of the x-ray field are independently variable. The minimum field size at a SID of 100 centimeters shall be equal to or less than ten by ten centimeters.

(b) Adequate means shall be provided for visually defining the perimeter of the x-ray field. The total misalignment of the edges of the visually defined field with the respective edges of the x-ray field along either the length or width of the visually defined field shall not exceed 2 percent of the distance from the source to the center of the visually defined field when the surface upon which it appears is perpendicular to the central axis of the x-ray beam.

(2) *In addition to the requirements of WAC 246-225-060(1) above all stationary x-ray systems shall meet the following requirements:*

(a) Means shall be provided to indicate when the axis of the x-ray beam is perpendicular to the plane of the image receptor and to align the center of the x-ray field with respect to the center of the image receptor to within 2 percent (5 percent for equipment manufactured prior to August 1974) of the SID. Dental lateral jaw examinations shall be excluded from this requirement;

(b) The beam-limiting device shall numerically indicate the field size in the plane of the image receptor to which it is adjusted;

(c) Indication of field size dimensions and SID's shall be specified in inches and/or centimeters;

(d) Indication of field size dimensions shall be such that aperture adjustments result in x-ray field dimensions in the plane of the image receptor to within 2 percent of the SID when the beam axis is perpendicular to the plane of the image receptor.

(3) *Radiographic equipment designed for only one image receptor size at a fixed SID shall be provided with means to limit the field at the plane of the image receptor to dimensions no greater than those of the image receptor, and to align the center of the x-ray field with the center of the image receptor to within 2 percent of the SID.*

(4) *Special purpose x-ray systems.*

(a) These systems shall be provided with means to limit the x-ray field in the plane of the image receptor so that such field does not exceed each dimension of the image

receptor by more than 2 percent of the SID when the axis of the x-ray beam is perpendicular to the plane of the image receptor.

(b) These systems shall be provided with means to align the center of the x-ray field with the center of the image receptor to within 2 percent (5 percent for equipment manufactured prior to August 1974) of the SID.

(c) The above WAC 246-225-060 (4)(a) and 246-225-060 (4)(b) may be met with a system that meets the requirements for a general purpose x-ray system as specified in WAC 246-225-060(1) or, when alignment means are also provided, may be met with either:

(i) An assortment of removable, fixed-aperture, beam-limiting devices sufficient to meet the requirement for each combination of image receptor size and SID for which the unit is designed (each such device shall have clear and permanent markings to indicate the image receptor size and SID for which it is designed); or

(ii) A beam-limiting device having multiple fixed apertures sufficient to meet the requirement for each combination of image receptor size and SID for which the unit is designed. Permanent, clearly legible markings shall indicate the image receptor size and SID for which each aperture is designed and shall indicate which aperture is in position for use.

[Statutory Authority: RCW 70.98.050 and 70.98.080, 91-15-083 (Order 183), § 246-225-060, filed 7/23/91, effective 8/23/91. Statutory Authority: RCW 43.70.040, 91-02-049 (Order 121), recodified as § 246-225-060, filed 12/27/90, effective 1/31/91. Statutory Authority: RCW 70.98.080, 83-19-050 (Order 2026), § 402-28-051, filed 9/16/83. Statutory Authority: RCW 70.98.050, 81-01-011 (Order 1570), § 402-28-051, filed 12/8/80; Order 1084, § 402-28-051, filed 1/14/76. Formerly WAC 402-28-050 (part).]

**WAC 246-225-070 Radiographic systems other than fluoroscopic, dental intraoral, or veterinary systems—Radiation exposure control devices.** (1) *Timers.* Means shall be provided to terminate the exposure at a preset time interval, preset product of current and time, a preset number of pulses, or a preset radiation exposure to the image receptor. In addition, it shall be impossible to make an exposure when the timer is set to a zero or off position if either position is provided.

(2) *X-ray control (exposure switch):*

(a) A control which shall be the equivalent of a dead-man switch, shall be incorporated into each x-ray system such that an exposure can be terminated at any time except for:

(i) Exposure of one-half second or less, or

(ii) During serial radiography when means shall be provided to permit completion of any single exposure of the series in process.

(b) Each x-ray control shall be located in such a way as to meet the following requirements:

(i) Stationary x-ray systems shall be required to have the x-ray exposure switch permanently mounted in a protected area so that the operator has no choice but to remain in that protected area during the entire exposure;

(ii) Mobile and portable x-ray systems shall have:

(A) An exposure cord which can extend for a minimum of 12 feet from the patient; or

(B) A protective barrier of 0.25 millimeter lead equivalent between the patient and the operator.

(c) Each x-ray control shall provide visual evidence to the operator that x-rays are being produced and an audible signal that the exposure has terminated.

(3) *Automatic exposure controls (phototimers)*. When an automatic exposure control is provided:

(a) Indication shall be made on the control panel when this mode of operation is selected;

(b) When the x-ray tube potential is equal to or greater than 50 kVp, the minimum exposure time for field emission equipment rated for pulsed operation shall be equal to or less than the interval equivalent to two pulses;

(c) The minimum exposure time for all equipment other than that specified in WAC 246-225-070 (3)(b) shall be equal to or less than 1/60 second or a time interval required to deliver 5 mAs, whichever is greater.

(4) *Timer reproducibility*. With a timer setting of 0.5 seconds or less, the difference between the maximum exposure time (Tmax) and the minimum exposure time (Tmin) shall be less than or equal to 10% of the average exposure time (T), when four timer tests are performed:

$$(T_{\max} - T_{\min}) \leq 0.1T$$

[Statutory Authority: RCW 70.98.050 and 70.98.080. 91-15-083 (Order 183), § 246-225-070, filed 7/23/91, effective 8/23/91. Statutory Authority: RCW 43.70.040. 91-02-049 (Order 121), recodified as § 246-225-070, filed 12/27/90, effective 1/31/91. Statutory Authority: RCW 70.98.080. 83-19-050 (Order 2026), § 402-28-052, filed 9/16/83. Statutory Authority: RCW 70.98.050. 81-01-011 (Order 1570), § 402-28-052, filed 12/8/80; Order 1084, § 402-28-052, filed 1/14/76. Formerly WAC 402-28-050 (part).]

**WAC 246-225-080 Radiographic systems other than fluoroscopic, dental intraoral, or veterinary systems—Source-to-skin or receptor distance.** (1) *Limitation*. All radiographic systems shall be provided with a durable, securely fastened means to limit the source-to-skin distance to not less than 23 centimeters. The requirement can be met when the collimator or cone provides the required limits.

(2) *Source to receptor distance measuring device*. All radiographic systems shall be provided with a device or reference, other than a collimator light localizer, which will indicate the selected source to image receptor distance (SID) to within 2 percent of the indicated SID.

[Statutory Authority: RCW 43.70.040. 91-02-049 (Order 121), recodified as § 246-225-080, filed 12/27/90, effective 1/31/91. Statutory Authority: RCW 70.98.080. 83-19-050 (Order 2026), § 402-28-053, filed 9/16/83. Statutory Authority: RCW 70.98.050. 81-01-011 (Order 1570), § 402-28-053, filed 12/8/80; Order 1084, § 402-28-053, filed 1/14/76. Formerly WAC 402-28-050 (part).]

**WAC 246-225-090 Radiographic systems other than fluoroscopic and dental intraoral—Exposure reproducibility.** The exposure produced shall be reproducible to within the following criterion: When all technique factors are held constant, the coefficient of variation shall not exceed 0.05.

(1) For manual exposure control mode, this shall be deemed to have been met if when four exposures at identical technique factors are made, the difference between the maximum exposure value (Emax) and the minimum exposure value (Emin) shall be less than or equal to 10% of the average exposure (E):

$$(E_{\max}) - (E_{\min}) \leq 0.10E$$

(2) For phototimed exposure control mode, this shall be deemed to have been met if when four exposures at identical technique factors are made, the difference between the maximum exposure value (Emax) and the minimum exposure value (Emin) shall be less than or equal to 10% of the average exposure (E):

$$(E_{\max}) - (E_{\min}) \leq 0.1E$$

The four exposures are to be made under the following conditions in phototimed mode:

(a) The kV is held constant.

(b) The mA, if selectable, is held constant.

(c) The selected density, if selectable, is held constant.

(d) Selection of phototimer radiation detectors (single or multiple detectors selected), if available, is varied for each of the four exposures.

(e) The same attenuator is placed in the x-ray field between the selected phototimer radiation detectors (photocells) and the radiation detector used to determine the four exposure values.

(f) The selected phototimer radiation detectors (photocells) are within the x-ray field during each exposure measurement and are covered completely by the attenuator.

(3) Systems employing deliberately mismatched phototimed cells are permitted, providing written specifications for the mismatch are available for inspection.

[Statutory Authority: RCW 70.98.050 and 70.98.080. 91-15-083 (Order 183), § 246-225-090, filed 7/23/91, effective 8/23/91. Statutory Authority: RCW 43.70.040. 91-02-049 (Order 121), recodified as § 246-225-090, filed 12/27/90, effective 1/31/91. Statutory Authority: RCW 70.98.080. 83-19-050 (Order 2026), § 402-28-054, filed 9/16/83. Statutory Authority: RCW 70.98.050. 81-01-011 (Order 1570), § 402-28-054, filed 12/8/80; Order 1084, § 402-28-054, filed 1/14/76. Formerly WAC 402-28-050 (part).]

**WAC 246-225-100 Radiographic systems—Standby radiation from capacitor energy storage equipment.** Radiation emitted from the x-ray tube when the exposure switch or timer is not activated shall not exceed a rate of 2 milliroentgens per hour at 5 centimeters from any accessible surface of the diagnostic source assembly, with the beam-limiting device fully open.

[Statutory Authority: RCW 43.70.040. 91-02-049 (Order 121), recodified as § 246-225-100, filed 12/27/90, effective 1/31/91. Statutory Authority: RCW 70.98.050. 81-01-011 (Order 1570), § 402-28-055, filed 12/8/80; Order 1084, § 402-28-055, filed 1/14/76. Formerly WAC 402-28-050 (part).]

**WAC 246-225-110 Intraoral dental radiographic systems.** In addition to the provisions of WAC 246-225-020, 246-225-030, and 246-225-040 the requirements of this section apply to x-ray equipment and associated facilities used for dental radiography. Criteria for extraoral dental radiographic systems are covered in WAC 246-225-060, 246-225-070, and 246-225-080.

(1) *Source-to-skin distance (SSD)*. X-ray systems designed for use with an intraoral image receptor shall be provided with means to limit source-to-skin distance to not less than:

(a) 18 centimeters if operable above 50 kilovolts peak, or

(b) 10 centimeters if operable only at 50 kilovolts peak.  
(2) *Field limitation*.

(a) Radiographic systems designed for use with an intraoral image receptor shall be provided with means to limit the x-ray beam such that:

(i) If the minimum source-to-skin distance (SSD) is 18 centimeters or more, the x-ray field, at the minimum SSD, shall be containable in a circle having a diameter of no more than 7 centimeters; and

(ii) If the minimum SSD is less than 18 centimeters, the x-ray field, at the minimum SSD, shall be containable in a circle having a diameter of no more than 6 centimeters.

(b) An open ended position indicating device shall be used. The shielding shall be equivalent to that required for the diagnostic source assembly (WAC 246-225-040(3)).

(3) *Timers.* Means shall be provided to terminate the exposure at a preset time interval, preset product of current and time, a preset number of pulses, or a preset radiation exposure to the image receptor. In addition,

(a) Termination of exposure shall cause automatic resetting of the timer to its initial setting or to zero.

(b) It shall not be possible to make an exposure when the timer is set to a zero or off position if either position is provided.

(4) *X-ray control exposure switch:*

(a) A control, which shall be the equivalent of a dead-man switch, shall be incorporated into each x-ray system.

(b) Each x-ray control shall be located in such a way as to meet the following criterion:

(i) For stationary x-ray systems it shall be required that the control switch be permanently mounted in a protected area (e.g., corridor outside the room) so that the operator has no choice but to remain in that protected area during the entire exposure.

(ii) Permanently mounted in a protected area shall be interpreted as meaning that the exposure switch is fixed in position no less than 36 inches from access to the direct scatter radiation field.

(c) The x-ray control shall provide a visual or audible indication of x-ray production or termination at the operator's protected position.

(5) *Exposure reproducibility.* The co-efficient of variation shall not exceed 0.05 when all technique factors are held constant. This requirement shall be deemed to have been met if, when four exposures are made at identical technique factors, the difference between the maximum exposure ( $E_{max}$ ) and the minimum exposure ( $E_{min}$ ) shall be less than or equal to 10% of the average exposure ( $E$ ):

$$(E_{max} - E_{min}) < 0.1E$$

(6) No diagnostic dental x-ray machine with a fixed, nominal kVp of less than 50 shall be permitted.

(7) *Operating controls.*

(a) Patient and film holding devices shall be used when the techniques permit.

(b) Neither the tube housing nor the position indicating device shall be hand held during an exposure. The tube housing shall remain stable during exposure.

(c) The x-ray system shall be arranged and operated in such a manner that the useful beam at the patient's skin does not exceed the dimensions specified in WAC 246-225-110 (2)(a).

(d) Dental fluoroscopy without image intensification shall be prohibited.

[Statutory Authority: RCW 70.98.050 and 70.98.080. 91-15-083 (Order 183), § 246-225-110, filed 7/23/91, effective 8/23/91. Statutory Authority: RCW 43.70.040. 91-02-049 (Order 121), recodified as § 246-225-110, filed 12/27/90, effective 1/31/91. Statutory Authority: RCW 70.98.080. 83-19-050 (Order 2026), § 402-28-080, filed 9/16/83. Statutory Authority: RCW 70.98.050. 81-01-011 (Order 1570), § 402-28-080, filed 12/8/80; Order 1084, § 402-28-080, filed 1/14/76; Order 1, § 402-28-080, filed 1/8/69; Rules (part), filed 10/26/66.]

#### **WAC 246-225-120 Therapeutic x-ray installations less than 1 MeV. (1) Equipment requirements.**

(a) *Leakage radiation.* When the tube is operated at its leakage technique factors, the leakage radiation shall not exceed the value specified at the distance specified for the classification of that x-ray system:

(i) Contact therapy systems. Leakage radiation shall not exceed 100 milliroentgens per hour at five centimeters from the surface of the tube housing assembly;

(ii) Zero to one hundred fifty kVp systems. Systems shall have a leakage radiation which does not exceed one roentgen in one hour at one meter from the source;

(iii) One hundred fifty-one to nine hundred ninety-nine kVp systems. The leakage radiation shall not exceed one roentgen in one hour at one meter from the source except systems that operate in excess of 500 kVp may have a leakage radiation at one meter from the source equivalent to the exposure within one hour of the useful beam at one meter from the source multiplied by a factor of 0.001.

(b) *Permanent beam limiting devices.* Permanent fixed diaphragms or cones used for limiting the useful beam shall provide the same or higher degree of protection as that required by the tube housing assembly.

(c) *Removable and adjustable beam limiting devices.*

(i) Removable beam limiting devices shall, for the portion of the useful beam to be blocked by these devices, transmit not more than one percent of the original x-ray beam at the maximum kilovoltage and maximum treatment filter;

(ii) Adjustable beam limiting devices installed after the effective date of this section shall meet the requirements of (c)(i) of this subsection;

(iii) Adjustable beam limiting devices installed before the effective date of this section shall, for the portion of the x-ray beam to be blocked by these devices, transmit not more than five percent of the original x-ray beam at the maximum kilovoltage and maximum treatment filter.

(d) *Filter and wedge systems.* Filter systems shall meet the following requirements:

(i) Filters cannot be accidentally displaced from the useful beam at any possible tube orientation;

(ii) Each filter is marked as to its material of construction and its thickness or wedge angle for wedge filters;

(iii) It shall be possible for the operator to determine the presence or absence of each filter in the useful beam when the operator is at the control panel, either by display at the control panel or by direct observation; and

(iv) The filter insertion slot opening shall be covered with an attenuator equivalent to four-pound lead under operating conditions.

(e) *Tube immobilization.* The tube housing assembly shall be capable of being immobilized during stationary treatments.



(f) *Focal spot marking.* The tube housing assembly shall be so marked that it is possible to determine the location of the focal spot to within five millimeters, and such marking shall be readily accessible for use during calibration procedures.

(g) *Timer.*

(i) A timer shall be provided which has a display at the treatment control panel. The timer shall be graduated in minutes and fractions of minutes. The timer shall have a preset time selector and a means of determining elapsed time;

(ii) The timer shall be a cumulative timer which activates with radiation and retains its reading after irradiation is interrupted or terminated;

(iii) The timer shall terminate irradiation when a preselected time has elapsed;

(iv) The timer shall permit accurate presetting and determination of exposure times as short as 1 second;

(v) The timer shall terminate irradiation when set to zero;

(vi) The timer shall not activate until the shutter is opened, when patient irradiation is controlled by a shutter mechanism.

(h) *Control panel functions.* The control panel, in addition to the displays required in other provisions of this chapter, shall have:

(i) An indication of whether x-rays are being produced;

(ii) Means for indicating kV and x-ray tube current;

(iii) The means for terminating an exposure at any time;

(iv) A locking device which will prevent unauthorized use of the x-ray system; and

(v) For x-ray equipment manufactured after the effective date of this section, a positive display of specific filter(s) in the beam.

(i) *Source-to-patient distance.* There shall be means of determining the source-to-patient distance to within five millimeters.

(j) *Shutters.* Unless it is possible to bring the x-ray output to the prescribed exposure parameters within five seconds, the entire useful beam shall be automatically attenuated by a shutter having a lead equivalency not less than that of the tube housing assembly. In addition:

(i) After the unit is at operating parameters, the shutter shall be controlled electrically by the operator from the control panel;

(ii) An indication of shutter position shall appear at the control panel.

(k) *Low filtration x-ray tubes.* Each x-ray system equipped with a beryllium or other low-filtration window shall be clearly labeled as such upon the tube housing assembly and at the control panel;

(1) *Alignment.* When the therapy x-ray system is equipped with a light field indicating the x-ray field, the misalignment of one field edge to the other shall not exceed one percent of any source-to-treatment distance.

(2) *Facility design requirements for systems capable of operating above 50 kVp.*

In addition to shielding adequate to meet requirements of chapters 246-235 and 246-221 WAC and the shielding plan review provisions of WAC 246-225-030, the treatment room shall meet the following design requirements:

(a) *Warning lights.* Treatment rooms to which access is possible through more than one entrance shall be provided with warning lights, in a readily observable position near the outside of all access doors, which will indicate when the useful beam is "on." Or, as an alternative, entrances other than the main one shall be equipped with interior locks, activated for the period of exposure, and the main entrance shall be under control of the operator.

(b) *Voice communication.* Provision shall be made for two-way aural communication between the patient and the operator at the control panel; however, where excessive noise levels make aural communication impractical, other methods of communication shall be used.

(c) *Viewing systems.* Windows, mirrors, closed-circuit television, or an equivalent system shall be provided to permit continuous observation of the patient during irradiation and shall be so located that the operator can observe the patient from the control panel. When the primary viewing system is by electronic means (e.g., television), an alternate viewing system shall be available for use in the event of electronic failure or treatment must be discontinued until repair is made. If treatment is to be discontinued, this policy shall be included in the written safety procedures. A copy of the safety procedures shall be provided to the operator.

(d) *Additional requirements.* Treatment rooms which contain an x-ray system capable of operating above 150 kVp shall meet the following additional requirements:

(i) All necessary shielding, except for any beam interceptor, shall be provided by fixed barriers;

(ii) The control panel shall be outside the treatment room;

(iii) All doors of the treatment room shall be electronically connected to the control panel such that x-ray production cannot occur unless all doors are closed;

(iv) When the doors referred to in (d)(iii) of this subsection are opened while the x-ray tube is activated:

(A) X-ray production shall terminate within one second; or

(B) The radiation at a distance of one meter from the source shall be reduced to less than 100 milliroentgens per hour within one second.

(v) After the radiation output of the x-ray tube has been affected by the opening of any door referred to in (d)(iii) of this subsection, it shall be possible to restore the x-ray system to full operation only upon:

(A) Closing the door; and subsequently

(B) Reinitiating the exposure at the control panel.

(e) *Calibrations.*

(i) The calibration of an x-ray system shall be performed at intervals not to exceed one year and after any change or replacement of components which could cause a change in the radiation output.

(ii) The calibration of the radiation output of the x-ray system shall be performed by a qualified expert who is physically present at the facility during such calibration.

(iii) Calibration of the radiation output of an x-ray system shall be performed with a calibrated instrument. The calibration of such instrument shall be traceable to a national standard. The instrument shall have been calibrated within the preceding two years.



(iv) The calibrations made pursuant to (e)(i) of this subsection shall be such that the dose at a reference point in soft tissue can be calculated to within  $\pm$  five percent.

(v) The calibration of the x-ray system shall include, but not be limited to, the following determinations:

(A) The exposure rates for each combination of field size, technique factors, filter, and treatment distance used;

(B) The degree of alignment between the radiation field and the field indicated by the localizing device if such device is present; and

(C) An evaluation of the uniformity of the radiation field symmetry for the field sizes used and any dependence upon tube housing assembly orientation.

(vi) Records of calibration performed pursuant to (e) of this subsection shall be maintained by the registrant for two years after completion of the calibration.

(vii) A copy of the most recent x-ray system calibration shall be available for use by the operator at the control panel.

(f) *Operating procedures.*

(i) When a patient must be held in position for radiation therapy, mechanical supporting or restraining devices shall be used;

(ii) The tube housing assembly shall not be held by an individual during exposures;

(iii) No individual other than the patient shall be in the treatment room unless such individual is protected by a barrier sufficient to meet the requirements of chapter 246-221 WAC. No individual other than the patient shall be in the treatment room during exposures when the kVp exceeds 150;

(iv) The x-ray system shall not be used in the administration of radiation therapy unless the requirements of (e) of this subsection have been met.

[Statutory Authority: RCW 70.98.050 and 70.98.080. 91-15-083 (Order 183), § 246-225-120, filed 7/23/91, effective 8/23/91. Statutory Authority: RCW 43.70.040. 91-02-049 (Order 121), recodified as § 246-225-120, filed 12/27/90, effective 1/31/91. Statutory Authority: RCW 70.98.080. 87-01-031 (Order 2450), § 402-28-091, filed 12/11/86; 83-19-050 (Order 2026), § 402-28-091, filed 9/16/83. Statutory Authority: RCW 70.98.050. 81-01-011 (Order 1570), § 402-28-091, filed 12/8/80.]

**WAC 246-225-130 X-ray and electron therapy systems with energies of one MeV and above.** Chapter 246-229 WAC except WAC 246-229-100 (3) and (4) shall apply to medical facilities using therapy systems with energies 1 MeV and above.

(1) *Definitions.* In addition to the definitions provided in WAC 246-225-010, the following definitions shall be applicable to this section.

(a) "Applicator" means a structure which indicates the extent of the treatment field at a given distance from the nominal source and which may or may not incorporate an additional beam-limiting device.

(b) "Beam scattering foil" means a device which scatters and flattens a beam of electrons.

(c) "Central axis of the beam" means a line passing through the origin of the source and the center of the plane figure formed by the edge of the secondary collimating jaws when in a symmetric mode.

(d) "Dose monitoring system" means a system of devices for the detection and display of quantities of radiation.

(e) "Dose monitor unit" means a unit from which the absorbed dose can be calculated.

(f) "Existing equipment" means therapy systems subject to this section which were manufactured on or before the effective date of these regulations.

(g) "Field flattening device" means an absorber used to homogenize the dose rate over the area of a useful beam of x-rays.

(h) "Field size" means the dimensions of an area in a plane perpendicular to the specified direction of the beam of incident radiation at a maximum dose depth. Determine dimensions by fifty percent decrement lines.

(i) "Gantry" means that part of the system supporting and allowing possible movements of the radiation head.

(j) "Interruption of irradiation" means the stopping of irradiation with the possibility of continuing irradiation without resetting of the operating conditions at the control panel.

(k) "Isocenter" means a fixed point in space located at the intersection of the rotation axes of the principal movements of the therapy system.

(l) "Moving beam therapy" means radiation therapy with relative displacement of the useful beam and the patient during irradiation.

(m) "New equipment" means systems subject to this section which were manufactured after effective date of these regulations.

(n) "Nominal source" means a point from which radiation originates.

(o) "Normal treatment distance" means the distance between the virtual source and a reference point on the central axis of the beam. The reference is located at a position on the central axis at a specified distance from the nominal source.

(p) "Patient" means an individual subjected to examination and treatment.

(q) "Phantom" means a volume of material behaving in a manner similar to tissue with respect to the attenuation and scattering of radiation.

(r) "Primary dose monitoring system" means a system which will monitor the quantity of radiation produced during irradiation and which will terminate irradiation when a preselected number of dose monitor units have been acquired.

(s) "Radiation treatment prescription" means the absorbed dose which is intended to be delivered to the treatment volume.

(t) "Radiation head" means the structure from which the useful beam emerges.

(u) "Redundant dose monitoring combination" means a combination of two dose monitoring systems in which both systems are arranged to terminate irradiation in accordance with a preselected number of dose monitor units.

(v) "Secondary dose monitoring system" means a system which will terminate irradiation in the event of failure of the primary system.

(w) "Shadow tray" means a device attached to the radiation head to support auxiliary beam limiting material.

(x) "Stationary beam therapy" means radiation therapy without relative displacement of the useful beam and the patient during irradiation.

(y) "Target" means that part of a radiation source which intercepts a beam of accelerated particles with subsequent emission of other radiation.

(z) "Termination of irradiation" means the stopping of irradiation in a fashion which will not permit continuance of irradiation without the resetting of operating conditions at the control panel.

(aa) "Treatment field" means the cross-sectional area of the patient's tissue which is to be irradiated.

(bb) "Treatment volume" means that portion of the patient's body which is to be irradiated.

(2) *Requirements for equipment.*

(a) *Leakage radiation to the patient area.*

(i) New equipment shall meet the following requirements:

(A) For all operating conditions, the dose equivalent in rem due to leakage radiation, including x-ray and electrons, but excluding neutrons, at any point in a circular plane of two meters radius centered on and perpendicular to the central axis of the beam at the normal treatment distance and outside the maximum useful beam, shall not exceed 0.1 percent of the maximum dose equivalent in rem of the unattenuated useful beam measured at the point of intersection of the central axis of the beam and the plane surface. Measurements shall be averaged over an area up to but not exceeding one hundred square centimeters at the positions specified; and

(B) For each system the registrant shall determine, or obtain from the manufacturer, the leakage radiation existing at the positions specified in (a)(i)(A) of this subsection for specified operating conditions. Records for leakage radiation shall be maintained at the installation for inspection by the department.

(ii) Existing equipment (that installed prior to the effective date of the regulations) shall meet the following requirements:

(A) The leakage radiation, excluding neutrons, at any point in the area specified by (a)(i)(A) of this subsection, where such area intercepts the central axis of the beam one meter from the nominal source, shall not exceed 0.1 percent of the maximum dose equivalent in rems of the unattenuated useful beam measured at the point of intersection of the central axis of the beam and the surface of the reference circular plane. Measurements shall be averaged over an area up to but not exceeding one hundred square centimeters at the positions specified.

(B) For each system, the registrant shall determine, or obtain from the manufacturer, the leakage radiation existing at the positions specified in (a)(ii)(A) of this subsection for specified operating conditions. Records for radiation leakage shall be maintained at the installation for inspection by the department.

(b) *Leakage radiation outside the patient area.*

(i) The dose equivalent in rem due to leakage radiation, except in the area specified in (a) of this subsection, when measured at any point one meter from the path of the charged particle, before the charged particle strikes the target or window, shall not exceed 0.1 percent for x-ray leakage of the maximum dose equivalent in rems of the unattenuated

useful beam measured at the point of intersection of the central axis of the beam and the circular plane specified in (a) of this subsection.

(ii) The registrant shall determine, or obtain from the manufacturer, the actual leakage radiation existing at the positions specified in (a) of this subsection for specified operating conditions. Measurements shall be averaged over an area up to but not exceeding one hundred square centimeters at the positions specified.

(c) *Beam-limiting devices.* Secondary beam-limiting devices shall be provided and such devices shall transmit no more than two percent of the useful beam for the portion of the useful beam attenuated by the beam-limiting device. The neutron component of the useful beam shall not be included in this requirement.

(d) *Beam-modifying devices.*

(i) When the absorbed dose rate information required by subsection (2)(q) of this section is dependent on operation with a beam-flattening or beam-scattering device in place, the device shall be removable from the machine only by the use of tools.

(ii) In systems using interchangeable beam-flattening devices or beam-scattering foils:

(A) Irradiation shall not be possible until a selection of beam-modifying device is made and verified at the treatment control panel;

(B) An interlock system shall be provided to prevent irradiation when the beam-modifying device selected is not in the correct position; and

(C) A display at the control panel shall indicate what beam-modifying device is selected.

(e) *Wedges.*

(i) Presence of wedges in the beam shall be indicated at the control panel, by direct observation or by electronic means.

(ii) Each wedge removable from the system shall be clearly identified as to that wedge's material of construction, thickness, and wedge angle.

(iii) An interlock shall be provided to prevent irradiation when a wedge selection carried out in the treatment room does not agree with the wedge selection indicated at the control panel.

(f) *Beam quality.* The registrant shall obtain from the therapy x-ray system manufacturer, and have available, the following information:

(i) At various beam energies, the x-ray absorbed dose expressed as a fraction of maximum absorbed dose;

(ii) At various beam energies, the absorbed dose at the surface of the skin as a fraction of the maximum absorbed dose; and

(iii) The maximum percentage absorbed dose due to stray neutrons in the useful beam at specified operating conditions.

(g) *Beam monitors.* Therapy systems shall be provided with radiation detectors in the radiation head.

(i) New equipment shall be provided with two or more radiation detectors. The detectors shall be incorporated into two monitoring systems arranged either as a primary/primary combination or as a primary/secondary combination.

(ii) Existing equipment shall be provided with one or more radiation detectors. The detector shall be incorporated into a primary system.

(iii) The detectors and system where the detector is incorporated shall meet the following requirements:

(A) Each primary system shall have a detector which is a transmission full-beam detector placed on the patient side of beam-modifying devices;

(B) The detectors shall be removable only with tools and shall be interlocked to prevent incorrect positioning;

(C) Each detector shall be capable of independently monitoring and controlling the useful beam;

(D) Each detector shall form part of a dose-monitoring system from whose readings in dose monitor units the absorbed dose, at a reference point in the treatment volume can be calculated;

(E) For new equipment, the design of the dose-monitoring systems of subsection (2)(i) of this section shall assure the malfunctioning of one system shall not affect the correct functioning of the second system. In addition, the failure of an element common to both systems shall terminate irradiation.

(F) Each dose monitoring system shall have a legible display at the treatment control panel. Each display shall:

(I) Maintain a reading until intentionally reset to zero;

(II) Have only one scale and no scale multiplying factors in new equipment; and

(III) Utilize a design so increasing dose is displayed by increasing numbers and shall be designed so, in the event of an overdosage of radiation, the absorbed dose may be accurately determined under normal conditions of use or foreseeable failures.

(G) In the event of power failure, the dose-monitoring information required in subsection (2)(i) of this section displayed at the control panel at the time of failure shall be retrievable in one or more systems.

(h) *Beam symmetry.*

(i) A therapy machine installed after the effective date of these regulations shall have the capability of comparing the dose rates in each of the four quadrants of the central eighty percent of the useful beam.

(ii) Beam symmetry information shall be displayed at the treatment control panel making possible the following differential between quadrants:

(A) Five percent for straight-through accelerators; and

(B) Three percent for bending-magnet accelerators.

(iii) Beam asymmetry in excess of a ten percent quadrant differential shall cause treatment to terminate, or shall prevent irradiation.

(i) *Selection and display of dose monitor units.*

(i) Irradiation shall not be possible until a selection of a number of dose monitor units is made at the treatment control panel.

(ii) After useful beam termination, it shall be necessary manually to reset the preselected dose monitor units before treatment is reinitiated.

(iii) The preselected number of dose monitor units shall be displayed at the treatment control panel until reset manually for the next irradiation.

(j) *Termination of irradiation by the dose monitoring system.*

(i) Each of the required monitoring systems shall be capable of independently terminating an irradiation. Provision shall be made to test the correct operation of each system.

(ii) Each primary system shall terminate irradiation when the preselected number of dose monitor units is detected by the system.

(iii) Each secondary system shall terminate irradiation when a maximum of the preselected number of dose monitor units plus forty is detected by the system.

(iv) For new equipment, indicators on the control panel shall show which monitoring system terminated the beam.

(k) *Interruption switches.* It shall be possible to interrupt irradiation and equipment movements at any time from the operator's position at the treatment control panel. Following any interruption, it shall be possible to restart irradiation by operator action without any reselection of operating conditions. If any change is made of a preselected value during an interruption, the equipment shall go to termination condition.

(l) *Termination switches.* It shall be possible to terminate irradiation and equipment movements, or go from an interruption condition to termination conditions, at any time from the operator's position at the treatment control panel.

(m) *Timer.*

(i) A timer shall be provided which has a display at the treatment control panel. The timer shall be graduated in minutes and decimals of minutes. The timer shall have a preset time selector and an elapsed time indicator.

(ii) The timer shall be a cumulative timer which switches on and off with the radiation and retains its reading after irradiation is interrupted or terminated. It shall be necessary to zero and subsequently reset the elapsed time indicator and the preset time selector after irradiation is terminated before irradiation shall again be possible.

(iii) The timer shall terminate irradiation when a preselected time has elapsed if the dose monitoring systems fail to terminate irradiation.

(n) *Selection of radiation type.* Equipment capable of both x-ray therapy and electron therapy shall meet the following requirements:

(i) Irradiation shall not be possible until a selection of radiation type is made at the treatment control panel;

(ii) An interlock system shall be provided to insure that the equipment can emit only the selected radiation type;

(iii) An interlock system shall be provided to prevent irradiation if selected operations carried out in the treatment room do not agree with the selected operations carried out in the treatment control panel;

(iv) With the exception of a specified number of dose monitor units for the purpose of portal film exposures, an interlock system shall be provided to prevent irradiation with x-rays when electron applicators are in place and to prevent irradiation with electrons when accessories for x-ray therapy are in place; and

(v) The radiation type selected shall be displayed at the treatment control panel before and during irradiation.

(o) *Selection of energy.* Equipment capable of generating radiation beams of different energies shall meet the following requirements:

(i) Irradiation shall not be possible until a selection of energy is made at the treatment control panel;

(ii) An interlock system shall be provided to insure the equipment can emit only the energy of selected radiation;

(iii) An interlock system shall be provided to prevent irradiation if selected operations carried out in the treatment

room do not agree with the selected operations carried out at the treatment control panel; and

(iv) The energy selected shall be displayed at the treatment control panel before and during irradiation.

(p) *Selection of stationary beam therapy or moving beam therapy.* Equipment capable of both stationary beam therapy and moving beam therapy shall meet the following requirements:

(i) Irradiation shall not be possible until a selection of stationary beam therapy or moving beam therapy is made at the treatment control panel;

(ii) An interlock system shall be provided to insure the equipment can operate only in the selected mode;

(iii) An interlock system shall be provided to prevent irradiation when any selected operations carried out in the treatment room do not agree with the selected operations carried out at the treatment control panel;

(iv) An interlock system shall be provided to terminate irradiation when the movement stops during moving beam therapy;

(v) Moving beam therapy shall be controlled so the required relationship between the number of dose monitor units and movement is obtained; and

(vi) The mode of operation shall be displayed at the treatment control panel.

(q) *Absorbed dose rate.* For new equipment, a system shall be provided from whose readings the absorbed dose rate at a reference point in the treatment volume can be calculated.<sup>3</sup> In addition:

(i) The quotient of the number of dose monitor units by time shall be displayed at the treatment control panel; and

(ii) If the equipment can deliver, under any conditions, an absorbed dose rate at the normal treatment distance more than twice the maximum value specified by the manufacturer's anticipated dose rate for any machine parameters utilized, a device shall be provided which terminates irradiation when the absorbed dose rate exceeds a value twice the specified maximum. The value at which the irradiation is terminated shall be in a registrant-maintained record.

(r) *Location of focal spot and beam orientation.* The registrant shall determine, or obtain from the manufacturer, the location with reference to an accessible point on the radiation head of:

(i) The x-ray target or the virtual source of x-rays;

(ii) The electron window or the scattering foil;

(iii) All possible orientations of the useful beam.

(s) *System interlock checks.* Capabilities shall be provided to check radiation safety interlocks. When preselection of operating conditions requires action in the treatment room and at the treatment control panel, selection at one location shall not give a display at the other location until the requisite selected operations in both locations are completed.

(t) *Facility and shielding requirements.* In addition to chapter 246-221 WAC, the following design requirements shall apply:

(i) Except for entrance doors or beam interceptors, required barriers shall be fixed barriers;

(ii) The treatment control panel shall be located outside the treatment room;

(iii) Windows, mirrors, closed-circuit television, or other equivalent viewing systems shall be provided to permit

continuous observation of the patient during irradiation and shall be located so the operator may observe the patient from the treatment control panel. When the viewing system is by electronic means, for example, by television, an alternate viewing system shall be provided for use in the event of the primary system failure, or, alternatively, treatments shall be discontinued until the viewing system is again functional;

(iv) Provision shall be made for two-way aural communication between the patient and the operator at the treatment control panel. However, where excessive noise levels make aural communications impractical, other methods of communication shall be used;

(v) Treatment rooms to which access is possible through two entrances or more shall be provided with warning lights and shall indicate when the useful beam is "on" in a readily observable position near the outside of all access doors; and

(vi) Interlocks shall be provided so entrance doors shall be closed before treatment is initiated or continued. When the radiation beam is interrupted by any door opening, it shall be possible to restore the machine to operation only by closing the door and reinitiating exposure by manual action at the control panel.

(u) *Surveys, calibrations, spot checks and operating procedures.*

(i) Survey.

(A) New facilities, and existing facilities not previously surveyed, shall have a survey made by, or under the direction of, a qualified expert. Such surveys shall also be done after a change in the facility or equipment causing a significant increase in radiation hazard.

(B) The registrant shall obtain a written report of the survey from the qualified expert and the registrant shall transmit a copy of the report to the department.

(C) The report shall indicate instances where the installation, in the opinion of the qualified expert, is in violation of applicable regulations and shall cite the section violated.

(ii) Calibrations.

(A) The calibration of systems subject to this section shall be performed before the system is first used for irradiation of patient and thereafter at time intervals which do not exceed twelve months and after any change which significantly alters the calibration, spatial distribution, or other characteristics of the therapy beam.

(B) The calibration shall be performed by a qualified expert.

(C) Calibration of the dose equivalent of the therapy beam shall be performed with a measurement instrument of which the calibration is traceable to national standards of exposure or absorbed dose and which shall have been calibrated within the preceding two years.

(D) Calibrations made under subsection (2)(u)(ii) of this section shall require the dose at a reference point in soft tissue be calculated within  $\pm 5$  percent.

(E) The calibration of the therapy beam shall include, but not be limited to, the following determinations:

(I) Verification that the equipment is operating in compliance with the design specifications concerning the light localizer, the side light and back-pointer alignment with the isocenter, when applicable, variation in the axis of rotation for the table, gantry and jaw system, and beam flatness and symmetry at specified depths;

(II) The output factors in terms of dose per monitor unit or dose per minute at a specific depth in a phantom for the range of field sizes used, for each effective energy, and for each treatment distance used for radiation therapy;

(III) The congruence between the radiation field and the field indicated by the localizing device; and

(IV) The uniformity of the radiation field and its dependency upon the direction of the useful beam.

(F) Records of the calibration performed under subsection (2)(u)(ii) of this section shall be maintained by the registrant for two years after completion of the calibration.

(G) A copy of the latest calibration performed under subsection (2)(u)(ii) of this section shall be available for operator use.

(iii) Spot checks. Spot checks shall be performed on the system subject to this section. Such spot checks shall meet the following requirements:

(A) A qualified expert shall develop, in writing, spot check procedures;

(B) The measurements taken during spot checks shall demonstrate the degree of consistency of the operating characteristics affecting the radiation output of the system or the radiation delivered to a patient during a therapy procedure;

(C) The spot check procedures shall specify the frequency of tests or measurements performed;

(D) For systems where beam quality can vary significantly, spot checks shall include quality checks;

(E) Where a system has built-in devices which provide a self-check of any parameter during irradiation, the spot check procedures shall require the parameter be independently verified at specific time intervals;

(F) Erratic spot checks or inconsistent spot checks of calibration data shall be promptly investigated and corrected before the system is used for patient irradiation;

(G) When a spot check indicates a significant change in the operating characteristics of a system, as specified in the qualified expert's spot check procedures, the system shall be recalibrated as required under subsection (2)(u)(ii) of this section;

(H) Records of spot check measurements performed under subsection (2)(u)(iii) of this section shall be maintained by the registrant for a period of one year or for twice as long as the spot check cycle, whichever is greater;

(I) Operating procedures.

(I) No individual other than the patient shall be in the treatment room during treatment of a patient.

(II) If a patient must be held in position during treatment, mechanical supporting or restraining devices shall be used.

(III) The system shall not be used in the administration of radiation therapy unless subsection (2)(u)(i), (ii), and (iii) of this section are met.

<sup>3</sup>The radiation detectors specified under subsection (2)(g) of this section may form part of this system.

[Statutory Authority: RCW 70.98.050 and 70.98.080. 91-15-083 (Order 183), § 246-225-130, filed 7/23/91, effective 8/23/91. Statutory Authority: RCW 43.70.040. 91-02-049 (Order 121), recodified as § 246-225-130, filed 12/27/90, effective 1/31/91. Statutory Authority: RCW 70.98.080. 87-01-031 (Order 2450), § 402-28-101, filed 12/11/86. Statutory Authority: RCW 70.98.050. 81-01-011 (Order 1570), § 402-28-101, filed 12/8/80.]

**WAC 246-225-140 Veterinary medicine radiographic installations. (1) Equipment.**

(a) The protective tube housing shall be of diagnostic type.

See WAC 246-225-040(4).

(b) Diaphragms, cones, or a stepless adjustable collimator shall be used for collimating the useful beam to the area of clinical interest and shall provide the same degree of protection as is required of the housing. Cones or diaphragms, if used, shall be marked with their field size and the distance at which they are to be used.

(c) The half-value layer (HVL) of the useful beam shall not be less than as shown in the following table:

Measured Potential (kilovolts peak)	Half-value Layer (millimeters of aluminum equivalent)
70 and below	1.5
71	2.1
80	2.3
90	2.5
100	2.7
110	3.0
120	3.2

(d) A device shall be provided to terminate the exposure after a preset time or exposure. It must not be possible for the device to allow an exposure when preset at "zero" or "off."

(e) A dead-man type of exposure switch shall be provided, together with an electrical cord of sufficient length, so that the operator can stand out of the useful beam and at least two meters from the animal during all x-ray exposures.

(f) Reproducibility requirements as described under WAC 246-225-090.

(2) *Structural shielding.* All wall, ceiling, and floor areas shall be equivalent to or provided with applicable protective barriers as required in WAC 246-225-030(1).

(3) *Operating procedures.*

(a) In any application in which the operator is not located behind a protective barrier, clothing consisting of a protective apron having a lead-equivalent of not less than 0.25 millimeters shall be worn by the operator and any other individuals in the room during exposures.

(b) No individual other than the operator shall be in the x-ray room while exposures are being made unless such individual's assistance is required.

(c) When an animal or film must be held in position during radiography, mechanical supporting or restraining devices should be used. If the animal must be held by an individual, that individual shall be protected with appropriate shielding devices, such as protective gloves and apron, and that individual shall be so positioned that no part of that individual's body will be struck by the useful beam. The requirements of WAC 246-221-090, Personnel monitoring, and WAC 246-225-020 (2)(h)(iv) apply to such individuals.

[Statutory Authority: RCW 70.98.050 and 70.98.080. 91-15-083 (Order 183), § 246-225-140, filed 7/23/91, effective 8/23/91. Statutory Authority: RCW 43.70.040. 91-02-049 (Order 121), recodified as § 246-225-140, filed 12/27/90, effective 1/31/91. Statutory Authority: RCW 70.98.080. 83-19-050 (Order 2026), § 402-28-110, filed 9/16/83. Statutory Authority: RCW

70.98.050. 81-01-011 (Order 1570), § 402-28-110, filed 12/8/80; Order 1084, § 402-28-110, filed 1/14/76; Order 1, § 402-28-110, filed 1/8/69; Rules (part), filed 10/26/66.]

**WAC 246-225-150 X-ray film developing requirements.** Compliance with this section is required of healing arts registrants and is designed to ensure the patient and operator exposure is minimized, and to produce optimum image quality and diagnostic information.

(1) Manual processing of films:

(a) The following relationship between temperature of the developer and development time must be used (standard chemistry only):

THERMOMETER READINGS (DEGREES)		MINIMUM DEVELOPING TIMES (MINUTES)
C	F	
27 -	80	2
	79	2
	78	2 1/2
	77	2 1/2
24 -	76	3
	75	3
	74	3 1/2
	73	3 1/2
22 -	72	4
	71	4
	70	4 1/2
	69	4 1/2
20 -	68	5
	67	5 1/2
	66	5 1/2
	65	6
18 -	64	6 1/2
	63	7
	62	8
	61	8 1/2
16 -	60	9 1/2

(b) *Processing of film.* All films shall be processed to achieve adequate sensitometric performance. This criterion shall be adjudged met if:

(i) Film manufacturer's published recommendations for time and temperature are followed; or

(ii) Each film is developed in accordance with the time-temperature chart as required under subdivision (a) of this subsection.

(c) Devices shall be available giving:

(i) The actual temperature of the developer; and

(ii) An audible or visible signal indicating the termination of a preset time (in minutes).

(d) Chemical-film processing control.

(i) Chemicals shall be mixed in accordance with the chemical manufacturer's recommendations.

(ii) Developer replenisher shall be periodically added to the developer tank based on the recommendations of the chemical or film manufacturer. Solution may be removed from the tank to permit the addition of an adequate volume of replenisher.

(iii) All processing chemicals shall be completely replaced at least every two months.

(2) Automatic film processors shall be set up and maintained so radiographic density and contrast are optimal. This criterion shall be adjudged met if:

(a) Film manufacturer's published specifications for time and temperature are followed. In the absence of such specifications, the film shall be developed using the following chart:

MINIMAL REQUIRED DEVELOPER TEMPERATURE		PROCESSOR DEVELOPER IMMERSION TIME*
°C	°F	Seconds
35	95	20
34.5	94	21
34	93	22
33.5	92	23
33	91	24
32	90	25
31.5	89	26
31	88	27
30.5	87	28
30	86	29
29.5	85	30

\*Immersion time only, no cross-over time included.

The specified developer temperature and immersion time shall be posted in the dark room or on the automatic processor; and

(b) Replenishment of the developer chemistry is optimal:

(i) The processor shall deliver an adequate rate of developer replenishment; and

(ii) For facilities with a low x-ray workload, standby replenishment, flood replenishment, or periodically sending prefixed films through the processor may be necessary.

(c) Sensitometric tests of processor performance demonstrate the processor is achieving radiographic density and contrast equal to other processor models operating at equivalent developer immersion time and developer temperatures and using comparable chemistry.

(3) *Darkrooms.* Darkrooms shall be constructed so film being processed, handled, or stored will be exposed only to light passed through a safelight filter. The filter shall be of the type specified by the film manufacturer. Bulb wattage in the safelight shall be no greater than fifteen watts. The safelight shall be mounted at least 1.2 meters (four feet) above work areas.

(4) The department shall make x-ray film development and darkroom tests as necessary to determine compliance with this section.

[Statutory Authority: RCW 70.98.050. 94-01-073, § 246-225-150, filed 12/9/93, effective 1/9/94. Statutory Authority: RCW 70.98.050 and 70.98.080. 91-15-083 (Order 183), § 246-225-150, filed 7/23/91, effective 8/23/91. Statutory Authority: RCW 43.70.040. 91-02-049 (Order 121), recodified as § 246-225-150, filed 12/27/90, effective 1/31/91. Statutory Authority: RCW 70.98.080. 83-19-050 (Order 2026), § 402-28-990, filed 9/16/83; Order 1084, Appendix C (codified as WAC 402-28-990), filed 1/14/76.]

**WAC 246-225-160 Mammography.** (1) The use of a special purpose x-ray machine designed and used solely for mammography is required. Exempted from this requirement



shall be x-ray equipment using xerography for evaluation of breast implant integrity.

(2) All mammographic calibration, evaluation, service, and quality control actions shall be documented in writing and maintained at the facility for a three-year period. Records must be easily accessible to operators of these x-ray units.

(3) All tests requiring the use of a breast phantom shall employ a phantom similar to or identical to the one required by the American College of Radiology for its mammography accreditation program.

(4) Machine requirements:

(a) Mammography x-ray machines must be evaluated upon any major component change and on a yearly basis by a qualified medical physicist. Evaluation shall document (but is not limited to) half-value layer (HVL), kVP accuracy, reproducibility, timer accuracy, resolution achieved with film in use at the facility, focal spot size, mA linearity, light versus x-ray field alignment, and patient exposures (glandular tissue dose) following the measurement protocol in NCRP Report No. 85 (using a breast phantom). This requirement shall include initial acceptance testing upon the x-ray system's installation prior to human use.

(b) The half-value layer (HVL) for film/screen mammography shall be between the values of measured kVp/100 and measured kVp/100 + 0.1 millimeters aluminum. The half-value layer for xerography shall be at least 1.2 mm but no greater than 1.6 mm of aluminum as measured at 50 kVP. The HVL shall include the contribution to filtration made by the compression device.

(c) Exposure reproducibility: Manual techniques. See WAC 246-225-090.

(d) Exposure reproducibility: Photo-timed techniques. Mammographic systems in the AEC mode shall be able to maintain constant film density to within an optical density of  $\pm 0.3$  of the average optical density over the range of clinically used kVps, using BR-12 or other breast equivalent material phantom thicknesses of 2 centimeters to 6 centimeters. If the facility has established a technique chart that utilizes varying technical factors for different breast thicknesses, those adjustments in technique may be used when complying with this requirement.

(e) Radiographic timers. See WAC 246-225-070.

(f) kVP accuracy: The kVP accuracy published by the x-ray machine manufacturer shall be maintained at the specified level. For determination of actual versus indicated kVP, the manufacturer's recommendations for testing shall be followed.

(g) mA linearity. See WAC 246-225-040(10).

(h) All special purpose x-ray machines designed solely for mammography and installed after January 1, 1992, shall be equipped with a milli-ampere-second (mAs) read-out device, registering after each phototimed exposure. Alternatively, a means of determining mAs after each exposure shall be provided.

(i) Beam limitation:

(i) Mammographic systems shall be provided with means to limit the useful beam such that the x-ray field at the plane of the image receptor does not extend beyond any edge of the image receptor at any designed SID except the edge of the image receptor designed to be adjacent to the

chest wall where the x-ray field may not extend beyond such edge by more than two percent of the SID.

(ii) Beam limiting devices consisting of an assortment of fixed, removable cones sufficient to meet the requirement for each combination of image receptor size and SID for which the unit is designed shall have clear and permanent markings to indicate the image receptor size and SID for which it is designed.

(iii) When the beam limiting device and image receptor support device are designed to be used to immobilize the breast during a mammographic procedure and the SID may vary, the SID indication specified in WAC 246-225-060 (4)(c)(i) and (ii) shall be the maximum SID for which the beam limiting device or aperture is designed.

(iv) In the absence of a visually defined x-ray field each image receptor support shall have clear and permanent markings to indicate the maximum image receptor size for which it is designed.

(j) The combination of source-to-image distance, magnification, and focal spot size shall result in a radiographic resolution of at least 12 line pairs per millimeter. This standard applies to the mammographic, single emulsion film being used at the facility.

(k) The x-ray machine shall be equipped with a means of immobilizing and compressing the breast with a force of at least twenty-five pounds but no greater than forty pounds.

(l) Dedicated mammographic x-ray units are exempted from the requirements of WAC 246-225-030 (5)(b)(i) provided that appropriate operator shielding is employed (as defined by NCRP Report 49).

(m) *Transmission limit for image receptor supporting devices used for mammography.* For x-ray systems manufactured after September 5, 1978, which are designed only for mammography, the transmission of the primary beam through any image receptor support provided with the system shall be limited such that the exposure 5 centimeters from any accessible surface beyond the plane of the image receptor supporting device does not exceed 25.8 nanocoulombs per kilogram (0.1 milliroentgen) for each activation of the tube. Exposure shall be measured with the system operated at the minimum SID for which it is designed. Compliance shall be determined at the maximum rated peak tube potential for the system and at the maximum rated product of tube current and exposure time (mAs) for that peak tube potential. Compliance shall be determined by measurements averaged over an area of 100 square centimeters with no linear dimension greater than 20 centimeters.

(n) Maximum glandular doses. Glandular tissue dose for a cranio-caudal view of a 4.5 cm compressed breast using dose calculation methods found in NCRP Report # 85 shall not exceed the following:

Screen-film:

No grid = 1.5 milliGray (100

millirads)/projection

Grid = 2.5 milliGray (300 millirads)/projection

Xerox = 4.0 milliGray (400 millirads)/projection

(5) A quality control program shall be written and implemented for all mammographic facilities. This shall include (but shall not be limited to) tests performed, testing frequency, testing protocol, control limits for each test, corrective actions taken, and equipment maintenance/service. Program requirements include:



(a) Daily tests:

Film processor control charts using a sensitometric/densitometric based measurement system shall be required for each day the mammographic machine is in operation. Single emulsion mammographic film shall be used for this evaluation. The sensitometer shall be one with a 21-step optical attenuator.

Parameters in daily film processor tests shall include:

(i) Speed index (mid-density):

Control limits  $\pm 0.15$  optical density

(ii) Contrast index (density difference):

Control limits  $\pm 0.15$  optical density

(iii) Base + fog:

Maximum density shall not exceed 0.20 optical density.

(iv) Solution temperatures, using a digital thermometer that reads out in tenths of a degree and that is accurate to within  $\pm 0.5^\circ\text{F}$ .

Control limits  $\pm 1.0\text{ F}$

(b) Monthly tests:

(i) Chemical replenishment rates.

(ii) Image quality evaluation. The mammographic system shall be capable of providing an image of a 0.75 mm fiber, 0.32 mm speck group, and a 0.75 mm mass from an ACR, or equivalent, phantom on the standard mammographic image receptor system in use at the facility. Mammograms shall not be taken on patients if this minimum is not met. Any fibers, speck groups or masses larger than those specified shall also be imaged.

(c) Quarterly tests:

(i) Film/screen contact for all cassettes, using a 40-mesh copper screen.

(ii) Analyses of reject/repeat films.

(iii) Fixer retention in processed film.

(d) Semi-annual tests:

(i) Darkroom fog.

(ii) Compression device force.

(e) Yearly tests: See WAC 246-225-160 (4)(a).

(f) Cassette screens must be cleaned at least weekly.

(g) Records shall be maintained for quality control test equipment which requires calibration, and such calibrations shall be performed in accordance with recommendations of the manufacturer of the test equipment.

(h) Film processing. See WAC 246-225-150. A film processor that cannot be consistently made to operate within the control limits specified in (a) of this subsection shall not be used to process mammographic films.

(6) Operator competency:

(a) A mammographic machine operator shall be licensed, certified, or registered by the department as either:

(i) A health care practitioner, licensed under Title 18 RCW, if performing mammography is within the person's authorized scope of practice; or

(ii) A diagnostic radiologic technologist certified in accordance with chapter 18.84 RCW; or

(iii) An x-ray technician registered in accordance with chapter 18.84 RCW, with two or more years' experience in performing mammography and satisfactory completion of at least sixteen hours of training in mammographic positioning, mammographic quality assurance, and/or other related areas subject to approval by the department.

(b) A mammographic machine operator shall complete the equivalent of at least eight hours of training every twelve

months covering such areas as mammographic positioning, mammographic quality assurance and other related areas subject to approval by the department.

(c) A mammographic machine operator shall meet the requirements of WAC 246-225-020 (2)(b) and 246-225-99920.

(7) Masking devices shall be made available to block extraneous light from the viewer's eye when the illuminated surface of the viewbox is larger than the exposed area on the film.

(8) Additional requirement for mobile mammography services:

The daily film processor performance testing required in subsection (5)(a) of this section shall apply to all film processors used by the mobile service. No processor shall be used unless it meets the control limits specified by subsection (5)(a)(i) through (iv) of this section.

[Statutory Authority: RCW 70.98.050. 94-01-073, § 246-225-160, filed 12/9/93, effective 1/9/94; 92-05-011 (Order 240), § 246-225-160, filed 2/7/92, effective 3/9/92.]

**WAC 246-225-99910 Appendix I—Good practices.**

The following are included in this handbook of regulations as suggested good practices and are not intended to be a regulation. The topics presented in these good practices may, however, become incorporated into the Washington Administrative Code at a future date.

(1) Exchange of information. Because patient exposure to diagnostic x-rays is the most predominant source of exposure to artificially produced ionizing radiation, radiographs should be exchanged among the practitioners of the various healing arts. Such exchange can only benefit patients by reducing the unnecessary repeated exposures of patients who are referred to, or change to, other practitioners.

(2) Patient exposure guidelines. The following patient exposure values should be achievable with high speed image receptor systems, proper filtration, a reasonable radiographic density preference, proper choice of technique factors, and proper film development. State radiation safety surveyors can provide registrants with results of measurements of patient exposure values upon request.

**Dental Bitewing (D-Speed Film)\***

KVP Range Utilized	Upper Limit of Skin Entrance Exposure, mR
50 - 64	350
65 - 70	300
71 - 80	250
81 - 90	200

**Medical (400 Speed Imaging System)\***

Exam*	Upper Limit of Skin Entrance Exposure, mR
Abdomen (AP)	300
Lumbar spine (AP)	350
Cervical spine (AP)	95
Full spine (AP)	150
Skull (LAT)	70

Chest (PA) 10 (Nongrid),  
15 (Grid)

\*On average-size adult patients

[Statutory Authority: RCW 70.98.050, 94-01-073, § 246-225-99910, filed 12/9/93, effective 1/9/94. Statutory Authority: RCW 70.98.050 and 70.98.080, 91-15-083 (Order 183), § 246-225-99910, filed 7/23/91, effective 8/23/91. Statutory Authority: RCW 43.70.040, 91-02-049 (Order 121), recodified as § 246-225-99910, filed 12/27/90, effective 1/31/91. Statutory Authority: RCW 70.98.080, 83-19-050 (Order 2026), § 402-28-99001, filed 9/16/83; Order 1084, Appendix D (codified as WAC 402-28-99001), filed 1/14/76.]

**WAC 246-225-99920 Appendix II—Determination of competency.** The following are areas in which the department considers it important that an individual have expertise for the competent operation of x-ray equipment.

- (1) *Familiarization with equipment.*
  - (a) Identification of controls.
  - (b) Function of each control.
  - (c) The use of a technique chart.
- (2) *Radiation protection.*
  - (a) Collimation.
  - (b) Filtration.
  - (c) Gonad shielding and other patient protection devices.
  - (d) Restriction of x-ray tube radiation to the image receptor.
    - (e) Personnel protection.
    - (f) Grids.
- (3) *Film processing.*
  - (a) Film speed as relates to patient exposure.
  - (b) Film processing parameters.
  - (c) Quality assurance and quality control.
- (4) *Emergency procedures.*

Termination of exposure in event of automatic timing device failure.

  - (5) *Proper use of personnel dosimetry, if required.*
  - (6) *Understanding units of radiation.*

[Statutory Authority: RCW 70.98.050 and 70.98.080, 91-15-083 (Order 183), § 246-225-99920, filed 7/23/91, effective 8/23/91. Statutory Authority: RCW 43.70.040, 91-02-049 (Order 121), recodified as § 246-225-99920, filed 12/27/90, effective 1/31/91. Statutory Authority: RCW 70.98.080, 83-19-050 (Order 2026), § 402-28-99003, filed 9/16/83; Order 1084, Appendix F (codified as WAC 402-28-99003), filed 1/14/76.]

**WAC 246-225-99930 Appendix III—Information to be submitted by persons proposing to conduct healing arts screening using ionizing radiation.** Persons requesting that the department approve a healing arts screening program shall submit the following information and evaluation:

- (1) Name and address of the applicant and, where applicable, the names and addresses of agents within this state.
- (2) Diseases or conditions and frequency for which the x-ray examinations are to be used.
- (3) Description in detail of the x-ray examinations proposed in the screening program.
- (4) Description of the population to be examined in the screening program, i.e., age, sex, physical condition, and other appropriate information.
- (5) An evaluation of any known alternate methods not involving ionizing radiation which could achieve the goals of the screening program and why these methods are not used in preference to the x-ray examinations.

[Title 246 WAC—page 246]

(6) An evaluation by a qualified expert of the x-ray system(s) to be used in the screening program. The evaluation by the qualified expert shall show that such system(s) satisfy all requirements of these regulations. The evaluation shall include a measurement of patient exposures from the x-ray examinations to be performed.

(7) A description of the diagnostic film quality control program.

(8) A copy of the technique chart for the x-ray examination procedures to be used.

(9) The qualifications of each individual who will be operating the x-ray system(s).

(10) The qualifications of the individual who will be supervising the operators of the x-ray system(s). The extent of supervision and the method of work performance evaluation shall be specified.

(11) The name and address of the individual who will interpret the radiograph(s).

(12) A description of the procedure to be used in advising the individuals screened and their private practitioners of the healing arts of the results of the screening procedure and any further medical needs indicated.

(13) A description of the procedures for the retention or disposition of the radiographs and other records pertaining to the x-ray examinations.

(14) An indication of the frequency of screening and the duration of the entire screening program.

[Statutory Authority: RCW 70.98.050 and 70.98.080, 91-15-083 (Order 183), § 246-225-99930, filed 7/23/91, effective 8/23/91. Statutory Authority: RCW 43.70.040, 91-02-049 (Order 121), recodified as § 246-225-99930, filed 12/27/90, effective 1/31/91. Statutory Authority: RCW 70.98.080, 83-19-050 (Order 2026), § 402-28-99004, filed 9/16/83. Statutory Authority: RCW 70.98.050, 81-01-011 (Order 1570), § 402-28-99004, filed 12/8/80.]

## Chapter 246-227 WAC

### RADIATION PROTECTION—INDUSTRIAL X-RAY

#### WAC

246-227-001	Purpose.
246-227-010	Scope.
246-227-020	Definitions.
246-227-040	Radiation survey instruments.
246-227-050	Utilization and survey records.
246-227-060	Limitations—Personal radiation safety requirements for radiographers and radiographer's assistants.
246-227-070	Operating and emergency procedures.
246-227-080	Personnel monitoring control.
246-227-090	Security—Precautionary procedures in radiographic operations.
246-227-095	Posting.
246-227-120	Other records required.
246-227-130	Special requirements for enclosed radiography.
246-227-150	Special requirements for permanent radiographic installation.
246-227-170	Appendix A—Minimum subjects to be covered in training radiographers.

**WAC 246-227-001 Purpose.** The regulations in this chapter establish radiation safety requirements for persons utilizing x-ray machines for industrial radiography. The requirements of this part are in addition to and not in substitution for the other requirements of these regulations.

[Statutory Authority: RCW 70.98.050. 94-01-073, § 246-227-001, filed 12/9/93, effective 1/9/94.]

**WAC 246-227-010 Scope.** The regulations in this chapter apply to all registrants who use x-ray machines for industrial radiography: *Provided, however,* That nothing in this part shall apply to the use of sources of radiation in the healing arts.

[Statutory Authority: RCW 70.98.050. 94-01-073, § 246-227-010, filed 12/9/93, effective 1/9/94.]

**WAC 246-227-020 Definitions.** As used in this part:

(1) "Enclosed radiography" means industrial radiography employing radiation machines conducted in an enclosed cabinet or room and includes cabinet radiography and shielded room radiography.

(a) "Cabinet radiography" means industrial radiography employing radiation machines conducted in an enclosure or cabinet so shielded that every location at the exterior of the enclosure or cabinet meets the condition specified in WAC 246-221-060.

"Cabinet x-ray system" means an x-ray system with the x-ray tube installed in an enclosure (hereinafter termed "cabinet") which, independently of existing architectural structure except the floor on which it may be placed, is intended to contain at least that portion of a material being irradiated, provide radiation attenuation, and exclude personnel from its interior during generation of x-radiation. Included are all x-ray systems designed primarily for the inspection of carry-on baggage at airline, railroad, and bus terminals, and in similar facilities. An x-ray tube used within a shielded part of a building, or x-ray equipment which may temporarily or occasionally incorporate portable shielding is not considered a cabinet x-ray system.

(b) "Shielded-room radiography" means industrial radiography conducted in a room so shielded that every location on the exterior of the room meets the conditions specified in WAC 246-221-060.

(2) "Industrial radiography" means the examination of the macroscopic structure of materials by nondestructive methods utilizing x-ray machines. Industrial radiography as used in this chapter does not include well logging operations.

(3) "Permanent radiographic installation" means an installation in which the shielding is an integral part to the building structure, such that the radiographic operations conducted there are not mobile and not temporary.

(4) "Personal supervision" means supervision by a radiographer such that the radiographer is physically present at the radiography site and in such proximity that communication can be maintained and immediate assistance given as required.

(5) "Radiographer" means any individual who performs or who, in attendance at the site where x-ray machines are being used, personally supervises industrial radiographic operations and who is responsible to the registrant for assuring compliance with the requirements of these regulations.

(6) "Radiographer's assistant" means any individual who, under the personal supervision of a radiographer, uses radiation machines, or radiation survey instruments in industrial radiography.

[Statutory Authority: RCW 70.98.050. 94-01-073, § 246-227-020, filed 12/9/93, effective 1/9/94.]

**WAC 246-227-040 Radiation survey instruments.**

(1) The registrant shall maintain sufficient calibrated and operable radiation survey instruments to make physical radiation surveys as required by this part and chapter 246-221 WAC. Instrumentation required by this section shall have a range such that two milliroentgens per hour through one roentgen per hour can be measured.

(2) Each radiation survey instrument shall be calibrated:

(a) At energies appropriate for use and at intervals not to exceed three months and after each instrument servicing;

(b) Such that accuracy within  $\pm$  twenty percent traceable to a national standard can be demonstrated; and

(c) At two or more widely separated points, other than zero, on each scale.

(3) Records of these calibrations shall be maintained for three years after the most recent calibration date.

(4) The requirements of this section do not apply to registrants using only radiation machines in enclosed radiographic systems.

[Statutory Authority: RCW 70.98.050. 94-01-073, § 246-227-040, filed 12/9/93, effective 1/9/94.]

**WAC 246-227-050 Utilization and survey records.**

(1) Each registrant shall maintain records of the following information for three years after the date of each radiographic operation and shall maintain these records for inspection by the department:

(a) A description (or make and model number) of the radiation machine used along with the techniques utilized for each job;

(b) The identity of the radiographer and radiographer's assistant performing the work;

(c) Locations where used and dates of use;

(d) A physical radiation survey made of the boundary of the restricted area during radiographic operations. The maximum reading at the boundary shall be recorded. The records shall indicate approximate distance from source to boundaries and any occupied areas with exposure levels greater than 2 mR in any hour during radiographic operations; and

(e) The model and serial number of the survey meter used in (d) of this subsection.

(2) The requirements of subsection (1) of this section shall not apply in industrial radiography utilizing radiation machines in enclosed interlocked cabinets or rooms which are not occupied during radiographic operations, which are equipped with interlocks such that the radiation machine will not operate unless all openings are securely closed and which is so shielded that every location on the exterior meets conditions for an unrestricted area, as specified in WAC 246-221-060.

[Statutory Authority: RCW 70.98.050. 94-01-073, § 246-227-050, filed 12/9/93, effective 1/9/94.]

**WAC 246-227-060 Limitations—Personal radiation safety requirements for radiographers and radiographer's assistants.** (1) No registrant shall permit any

individual to act as a radiographer as defined in this chapter until such individual:

(a) Has been instructed in the subjects outlined in WAC 246-227-170;

(b) Has received copies of and instruction in the regulations contained in chapters 246-220, 246-222, 246-221 and 246-227 WAC, and the registrant's operating and emergency procedures, and shall have demonstrated understanding thereof;

(c) Has demonstrated competence to use the radiation machine and the radiation survey instruments which will be employed in the individual's assignment; and

(d) Has demonstrated understanding of the instructions in this paragraph by successful completion of written test or oral test on the subjects covered.

(2) No registrant shall permit any individual to act as a radiographer's assistant as defined in this part until such individual:

(a) Has received copies of an instruction in the registrant's operating and emergency procedures;

(b) Has demonstrated competence to use, under the personal supervision of the radiographer, the radiation survey instruments which will be employed in the individual's assignment;

(c) Has demonstrated understanding of the instructions in this paragraph by successfully completing a written or oral test.

(3) Each registrant shall maintain records of training and testing which demonstrate that the requirements of subsections (1) and (2) of this section are met. These records shall be retained for at least one year following termination of employment.

(4) When a radiographer's assistant is using an x-ray machine, the radiographer shall maintain direct surveillance.

[Statutory Authority: RCW 70.98.050. 94-01-073, § 246-227-060, filed 12/9/93, effective 1/9/94.]

**WAC 246-227-070 Operating and emergency procedures.** The registrant's operating and emergency procedures shall include instructions in at least the following:

(1) The handling and use of radiation machines to be employed such that no individual is likely to be exposed to radiation doses in excess of the limits established in chapter 246-221 WAC;

(2) Methods and occasions for conducting radiation surveys;

(3) Methods for controlling access to radiographic areas;

(4) Methods and occasions for locking or securing radiation machines;

(5) Personnel monitoring and the use of personnel monitoring equipment including steps that must be taken immediately by radiography personnel in the event a pocket dosimeter is found to be off-scale;

(6) The procedure for notifying proper personnel in the event of a theft, loss, overexposure or accident involving a radiation machine; and

(7) Maintenance of records.

[Statutory Authority: RCW 70.98.050. 94-01-073, § 246-227-070, filed 12/9/93, effective 1/9/94.]

**WAC 246-227-080 Personnel monitoring control.**

(1) No registrant shall permit any individual to act as a radiographer or as a radiographer's assistant unless, at all times during radiographic operations, each such individual shall wear a film or TLD badge and a direct reading pocket dosimeter. Pocket dosimeters shall be capable of measuring exposures from zero to at least two hundred milliroentgens: A film or TLD badge shall be assigned to and worn by only one individual.

(2) Pocket dosimeters shall be read and doses recorded daily. Pocket dosimeters shall be charged at the beginning of each working day. Pocket dosimeters shall be checked at least annually for correct response to radiation. Acceptable dosimeters shall read within  $\pm$  thirty percent of the true radiation exposure. A film or TLD badge shall be immediately processed if a pocket dosimeter is discharged beyond its range during normal use. The film or TLD badge reports received from the film or TLD badge processor and records of pocket dosimeter readings shall be maintained until the department authorizes their disposal.

(3) The requirements for use of pocket dosimeter or pocket chamber shall not apply in industrial radiography utilizing radiation machines in enclosed interlocked cabinets or rooms which are not occupied during radiographic operations, which are equipped with interlocks such that the radiation machine will not operate unless all openings are securely closed and which are so shielded that every location on the exterior meets conditions for an unrestricted area, as specified in WAC 246-221-060.

(4) The requirement for film badges or TLDs do not apply to those users of cabinet x-ray systems which do not allow human access and which meet the requirements of WAC 246-227-130.

[Statutory Authority: RCW 70.98.050. 94-01-073, § 246-227-080, filed 12/9/93, effective 1/9/94.]

**WAC 246-227-090 Security—Precautionary procedures in radiographic operations.** (1) During each radiographic operation, the radiographer or radiographer's assistant shall maintain a direct surveillance of the operation to protect against unauthorized entry into a high radiation area, as defined in chapter 246-220 WAC except:

(a) Where the high radiation area is equipped with a control device or alarm system as described in WAC 246-221-120 (1)(e)(ii); or

(b) Where the high radiation area is locked to protect against unauthorized or accidental entry.

(2) When not in operation or when not under direct surveillance, radiation machines shall be secured to prevent use by unauthorized personnel.

[Statutory Authority: RCW 70.98.050. 94-01-073, § 246-227-090, filed 12/9/93, effective 1/9/94.]

**WAC 246-227-095 Posting.** Notwithstanding any provisions in WAC 246-221-130, areas in which radiography is being performed shall be conspicuously posted and access to the area shall be controlled as required by WAC 246-221-120. This requirement shall not apply to areas using enclosed radiography systems (cabinets) which do not allow human access and in which the requirements of WAC 246-221-060 are met at the surface of the cabinet.

[Statutory Authority: RCW 70.98.050. 94-01-073, § 246-227-095, filed 12/9/93, effective 1/9/94.]

**WAC 246-227-120 Other records required.** Each registrant conducting industrial radiography shall have the following documents, where applicable, available on site for inspection by the department:

- (1) Operating and emergency procedures;
- (2) Applicable regulations;
- (3) Survey records required pursuant to WAC 246-227-050;
- (4) Daily pocket dosimeter records for the period of operation at the site pursuant to WAC 246-227-080; and
- (5) Proof of the latest calibration for specific instruments in use at the site pursuant to WAC 246-227-040.

[Statutory Authority: RCW 70.98.050. 94-01-073, § 246-227-120, filed 12/9/93, effective 1/9/94.]

**WAC 246-227-130 Special requirements for enclosed radiography.** (1) Shielded room radiography systems and cabinet systems shall:

- (a) Comply with all applicable requirements of this chapter and WAC 246-221-060;
- (b) Be interlocked such that the exposure will terminate if a door or port accessible to individuals is opened during the exposure, except for those systems employing conveyor belts or sample ports; and
- (c) Be tested for the proper operation of interlocks, high radiation area control devices or alarm systems, where applicable, at the beginning of each day of use. The results of these tests shall be recorded and maintained for three years.

(2) The registrant shall perform an evaluation, at intervals not to exceed one year, to determine conformance with this chapter and WAC 246-221-060. Records of each evaluation shall be maintained for three years.

[Statutory Authority: RCW 70.98.050. 94-01-073, § 246-227-130, filed 12/9/93, effective 1/9/94.]

**WAC 246-227-150 Special requirements for permanent radiographic installation.** Permanent radiographic installations having high radiation area entrance controls of the types described in WAC 246-221-102(1) or where the high radiation area is locked to protect against unauthorized or accidental entry, shall also meet the following special requirements:

(1) Each entrance that is used for personnel access to the high radiation area in a permanent radiographic installation to which this section applies shall have both visible and audible warning signals to warn of the presence of radiation. The visible signal shall be actuated by radiation whenever the x-rays are exposed. The audible signal shall be actuated when an attempt is made to enter the installation while x-rays are being generated.

(2) Both visible and audible alarm systems are required and shall be tested prior to the first use of a source in the installation and thereafter at intervals not to exceed three months. Records of the tests shall be kept for three years.

(3) The department shall review and approve, in advance of construction, plans for permanent radiographic installations whose construction had not commenced by the

effective date of these regulations. Construction of the permanent facility shall be in accordance with the plans approved by the department.

(4) A physical radiation survey shall be conducted and results recorded following construction or major modification of the facility to be used in the installation. Radiography shall not be conducted if exposure levels in unrestricted areas are greater than 2mR in any hour. Any increase in output capability of radiation machines will require resurvey of the installation prior to the conduct of industrial radiography.

[Statutory Authority: RCW 70.98.050. 94-01-073, § 246-227-150, filed 12/9/93, effective 1/9/94.]

**WAC 246-227-170 Appendix A—Minimum subjects to be covered in training radiographers.** (1) Fundamentals of radiation safety:

- (a) Characteristics of ionizing radiation;
- (b) Units of radiation dose (mrem) and quantity of radioactivity (curie);
- (c) Hazards of exposure to radiation:
  - (i) Radiation protection standards;
  - (ii) Biological effects of radiation dose;
  - (d) Levels of radiation from x-ray machines;
  - (e) Methods of controlling radiation dose:
    - (i) Working time;
    - (ii) Working distances;
    - (iii) Shielding.
- (2) Radiation detection instrumentation to be used:
  - (a) Use of radiation survey instruments:
    - (i) Operation;
    - (ii) Calibration;
    - (iii) Limitations;
  - (b) Survey techniques;
  - (c) Use of personnel monitoring equipment:
    - (i) Film badges;
    - (ii) Pocket dosimeters;
    - (iii) Thermoluminescent dosimeters.
- (3) Operation and control of x-ray equipment.
- (4) The requirements of pertinent federal and state regulations.
- (5) The registrant's written operating and emergency procedures.
- (6) Case histories of radiography accidents.

[Statutory Authority: RCW 70.98.050. 94-01-073, § 246-227-170, filed 12/9/93, effective 1/9/94.]

### Chapter 246-228 WAC

## RADIATION PROTECTION—ANALYTICAL X-RAY EQUIPMENT

### WAC

246-228-001	Purpose and scope.
246-228-010	Definitions.
246-228-020	Equipment requirements.
246-228-030	Facility requirements.
246-228-040	Operating requirements.
246-228-050	Personnel requirements.

**WAC 246-228-001 Purpose and scope.** This chapter provides special requirements for analytical x-ray equipment.

The requirements of this chapter are in addition to, and not in substitution for, applicable requirements in other chapters of these regulations.

[Statutory Authority: RCW 43.70.040, 91-02-049 (Order 121), recodified as § 246-228-001, filed 12/27/90, effective 1/31/91; Order 1084, § 402-40-010, filed 1/14/76.]

**WAC 246-228-010 Definitions.** (1) "Analytical x-ray equipment" means equipment used for x-ray diffraction or fluorescence analysis.

(2) "Analytical x-ray system" means a group of components utilizing x-rays to determine the elemental composition or to examine the microstructure of materials.

(3) "Fail-safe characteristics" mean a design feature which causes beam port shutters to close, or otherwise prevents emergence of the primary beam, upon the failure of a safety or warning device.

(4) "Local components" mean parts of an analytical x-ray system and include areas that are struck by x-rays such as radiation source housings, ports and shutter assemblies, collimators, sample holders, cameras, goniometers, detectors, and shielding, but do not include power supplies, transformers, readout devices, and control panels.

(5) "Normal operating procedures" mean step-by-step instructions necessary to accomplish the analysis. These procedures shall include sample insertion and manipulation, equipment alignment, routine maintenance by the registrant, and data recording procedures which are related to radiation safety.

(6) "Open-beam configuration" means a mode of operation of an analytical x-ray system in which an individual could accidentally place some part of their body into the primary beam during normal operation if no further safety devices are incorporated.

(7) "Primary beam" means ionizing radiation which passes through an aperture of the source housing via a direct path from the x-ray tube located in the radiation source housing.

[Statutory Authority: RCW 43.70.040, 91-02-049 (Order 121), recodified as § 246-228-010, filed 12/27/90, effective 1/31/91. Statutory Authority: RCW 70.98.050, 81-01-011 (Order 1570), § 402-40-020, filed 12/8/80; Order 1084, § 402-40-020, filed 1/14/76.]

**WAC 246-228-020 Equipment requirements.** (1) *Safety device.* A device which prevents the entry of any portion of an individual's body into the primary x-ray beam path, or which causes the beam to be shut off upon entry into its path, shall be provided for all open-beam configurations. A registrant or licensee may apply to the department for an exemption from the requirement of a safety device. Such application shall include:

(a) A description of the various safety devices that have been evaluated;

(b) The reason each of these devices cannot be used; and

(c) A description of the alternative methods that will be employed to minimize the possibility of an accidental exposure, including procedures to assure that operators and others in the area will be informed of the absence of safety devices.

(2) *Warning devices.* Open-beam configurations shall be provided with a readily discernible indication of:

[Title 246 WAC—page 250]

(a) X-ray tube status (ON-OFF) located near the radiation source housing, if the primary beam is controlled in this manner and at or near the port and/or

(b) Shutter status (OPEN-CLOSED) located near each port on the radiation source housing, if the primary beam is controlled in this manner.

(c) Warning devices shall be labeled so that their purpose is easily identified and the devices shall be conspicuous at the beam port. On new equipment installed after January 1, 1976, warning devices shall have fail-safe characteristics.

(3) *Ports.* Unused ports on radiation source housings shall be secured in the closed position in a manner which will prevent casual opening. Such security requirement will be deemed met if the beam port cannot be opened without the use of tools not part of the closure for units installed after January 1, 1981.

(4) *Labeling.* All analytical x-ray equipment shall be labeled with a readily discernible sign or signs bearing the radiation symbol and the words:

(a) "CAUTION - HIGH INTENSITY X-RAY BEAM," or words having a similar intent, on the x-ray source housing; and

(b) "CAUTION RADIATION - THIS EQUIPMENT PRODUCES RADIATION WHEN ENERGIZED," or words having a similar intent, near any switch that energizes an x-ray tube if the radiation source is an x-ray tube; or

(c) "CAUTION - RADIOACTIVE MATERIAL," or words having a similar intent, on the source housing if the radiation source is a radionuclide.

(5) *Shutters.* On new equipment employing open-beam configurations installed after January 1, 1981, each port on the radiation source housing shall be equipped with a shutter that cannot be opened unless a collimator or a coupling has been connected to the port.

(6) *Warning lights.* An easily visible warning light labeled with the words "X-RAY ON," or words having a similar intent, shall be located:

(a) Near any switch that energizes an x-ray tube and near any x-ray port and shall be illuminated only when the tube is energized; or

(b) In the case of a radioactive source, near any switch that opens a housing shutter, and shall be illuminated only when the shutter is open.

(c) On equipment installed after January 1, 1981, warning lights shall have fail-safe characteristics.

(7) *Radiation source housing.* Each x-ray tube housing shall be so constructed that with all shutters closed the leakage radiation measured at a distance of 5 cm from its surface is not capable of producing a dose equivalent in excess of 2.5 mrem in one hour at any specified tube rating. If radioactive sources are used, corresponding dose limits shall not exceed 2.5 mrem per hour.

(8) *Generator cabinet.* Each x-ray generator shall be supplied with a protective cabinet which limits leakage radiation measured at a distance of 5 cm from its surface such that it is not capable of producing a dose equivalent in excess of 0.25 mrem in one hour.

[Statutory Authority: RCW 43.70.040, 91-02-049 (Order 121), recodified as § 246-228-020, filed 12/27/90, effective 1/31/91. Statutory Authority: RCW 70.98.050, 81-01-011 (Order 1570), § 402-40-030, filed 12/8/80; Order 1084, § 402-40-030, filed 1/14/76.]



**WAC 246-228-030 Facility requirements.** (1) *Radiation levels.* The local components of an analytical x-ray system shall be located and arranged and shall include sufficient shielding or access control such that no radiation levels exist in any area surrounding the local component group which could result in a dose to an individual present therein in excess of the dose equivalent limits given in WAC 246-221-060 of these regulations. For systems utilizing x-ray tubes, these levels shall be met at any specified tube rating.

(2) *Surveys.* Radiation surveys, as required by WAC 246-221-110 of all analytical x-ray systems, sufficient to show compliance with WAC 246-228-030(1), shall be performed:

(a) Upon installation of the equipment, and at least once every twelve months thereafter;

(b) Following any change in the initial arrangement, number, or type of local components in the system;

(c) Following any maintenance requiring the disassembly or removal of a local component in the system;

(d) During the performance of maintenance and alignment procedures if the procedures require the presence of a primary x-ray beam when any local component in the system is disassembled or removed;

(e) Any time a visual inspection of the local components in the system reveals an abnormal condition; and

(f) Whenever personnel monitoring devices required in WAC 246-228-050(2) show a significant increase over the previous monitoring period or the readings are approaching 1/10 of the hands and forearm limit specified in WAC 246-221-010.

(g) Radiation survey measurements shall not be required if a registrant or licensee can demonstrate compliance to the satisfaction of the department with WAC 246-228-030(1) in some other manner.

(3) *Posting.* Each area or room containing analytical x-ray equipment shall be conspicuously posted with a sign or signs bearing the radiation symbol and the words "CAUTION - X-RAY EQUIPMENT," or words having a similar intent.

(4) *Documentation of instruction.* Each facility shall maintain written documentation showing that compliance with WAC 246-228-050 has been met, and shall make such documentation available to the department upon request.

[Statutory Authority: RCW 70.98.050 and 70.98.080. 91-15-083 (Order 183), § 246-228-030, filed 7/23/91, effective 8/23/91. Statutory Authority: RCW 43.70.040. 91-02-049 (Order 121), recodified as § 246-228-030, filed 12/27/90, effective 1/31/91. Statutory Authority: RCW 70.98.050. 81-01-011 (Order 1570), § 402-40-040, filed 12/8/80; Order 1084, § 402-40-040, filed 1/14/76.]

**WAC 246-228-040 Operating requirements.** (1) *Procedures.* Routine operating procedures shall be written and available to all analytical x-ray equipment workers. No person shall be permitted to operate analytical x-ray equipment in any manner other than that specified in the procedures unless such person has obtained written approval of the radiation safety officer.

(2) *Bypassing.* No person shall bypass a safety device unless such person has obtained the written approval of the radiation safety officer. Such approval shall be for a specified period of time. When a safety device has been bypassed, a readily discernible sign bearing the words

"SAFETY DEVICE NOT WORKING," or words having a similar intent, shall be placed on the radiation source housing. The requirements set forth in WAC 246-228-020(1) shall also be met.

[Statutory Authority: RCW 70.98.050 and 70.98.080. 91-15-083 (Order 183), § 246-228-040, filed 7/23/91, effective 8/23/91. Statutory Authority: RCW 43.70.040. 91-02-049 (Order 121), recodified as § 246-228-040, filed 12/27/90, effective 1/31/91. Statutory Authority: RCW 70.98.050. 81-01-011 (Order 1570), § 402-40-050, filed 12/8/80; Order 1084, § 402-40-050, filed 1/14/76.]

**WAC 246-228-050 Personnel requirements.** (1) *Instruction.* No person shall be permitted to operate or maintain analytical x-ray equipment unless such person has received instruction in and demonstrated competence as to:

(a) Identification of radiation hazards associated with the use of the equipment;

(b) Significance of the various radiation warning and safety devices incorporated into the equipment, or the reasons they have not been installed on certain pieces of equipment and the extra precautions required in such cases;

(c) Proper operating procedures for the equipment;

(d) Symptoms of an acute localized exposure; and

(e) Proper procedures for reporting an actual or suspected exposure.

(2) *Personnel monitoring.* Finger or wrist dosimetric devices shall be provided to and shall be used by:

(a) Analytical x-ray equipment workers using systems having an open-beam configuration and not equipped with a safety device; and

(b) Personnel maintaining analytical x-ray equipment if the maintenance procedures require the presence of a primary x-ray beam when any local component in the analytical x-ray system is disassembled or removed.

(c) Reported dose values shall not be used for the purpose of determining compliance with WAC 246-221-010 of these regulations unless evaluated by a qualified expert.

[Statutory Authority: RCW 70.98.050 and 70.98.080. 91-15-083 (Order 183), § 246-228-050, filed 7/23/91, effective 8/23/91. Statutory Authority: RCW 43.70.040. 91-02-049 (Order 121), recodified as § 246-228-050, filed 12/27/90, effective 1/31/91; Order 1084, § 402-40-060, filed 1/14/76.]

## Chapter 246-229 WAC

### RADIATION PROTECTION—PARTICLE ACCELERATORS

#### WAC

246-229-001	Purpose and scope.
246-229-010	Registration requirements.
246-229-020	General requirements for the issuance of a registration for particle accelerators.
246-229-030	Human use of particle accelerators.
246-229-040	General provisions.
246-229-050	Limitations.
246-229-060	Shielding and safety design requirements.
246-229-070	Particle accelerator controls and interlock systems.
246-229-080	Warning devices.
246-229-090	Operating procedures.
246-229-100	Radiation monitoring requirements.
246-229-110	Ventilation systems.

**WAC 246-229-001 Purpose and scope.** (1) This chapter establishes procedures for the registration and the use of particle accelerators.



(2) In addition to the requirements of this chapter, all registrants are subject to the requirements of chapters 246-220, 246-224, 246-221, and 246-222 WAC. Registrants engaged in industrial radiographic operations are also subject to the requirements of chapter 246-243 WAC and registrants engaged in the healing arts are also subject to the requirements of chapter 246-225 WAC and/or chapter 246-240 WAC of these regulations. Registrants engaged in the production of radioactive material are also subject to the requirements of chapters 246-232 and 246-235 WAC.

[Statutory Authority: RCW 70.98.050 and 70.98.080. 91-15-083 (Order 183), § 246-229-001, filed 7/23/91, effective 8/23/91. Statutory Authority: RCW 43.70.040. 91-02-049 (Order 121), recodified as § 246-229-001, filed 12/27/90, effective 1/31/91. Statutory Authority: RCW 70.98.050. 81-01-011 (Order 1570), § 402-44-010, filed 12/8/80; Order 1084, § 402-44-010, filed 1/14/76.]

**WAC 246-229-010 Registration requirements.** No person shall receive, possess, use, transfer, own, or acquire a particle accelerator except as authorized in a registration issued pursuant to these regulations or as otherwise provided for in these regulations. The general procedures for registration of particle accelerator facilities are included in chapter 246-224 WAC of these regulations.

[Statutory Authority: RCW 70.98.050 and 70.98.080. 91-15-083 (Order 183), § 246-229-010, filed 7/23/91, effective 8/23/91. Statutory Authority: RCW 43.70.040. 91-02-049 (Order 121), recodified as § 246-229-010, filed 12/27/90, effective 1/31/91; Order 1084, § 402-44-020, filed 1/14/76.]

**WAC 246-229-020 General requirements for the issuance of a registration for particle accelerators.** (Refer to chapter 246-224 WAC.) In addition to the requirement of chapter 246-224 WAC a registration application for use of a particle accelerator will be approved only if the department determines that:

(1) The applicant is qualified by reason of training and experience to use the accelerator in question for the purpose requested in accordance with this chapter in such a manner as to minimize danger to public health and safety or property;

(2) The applicant's proposed equipment, facilities, operating and emergency procedures are adequate to protect health and minimize danger to public health and safety or property;

(3) The issuance of the registration will not be inimical to the health and safety of the public, and the applicant satisfies any applicable special requirement in WAC 246-229-030;

(4) The applicant has appointed a qualified radiation safety officer;

(5) The applicant and/or the staff has substantial experience in the use of particle accelerators and training sufficient for the intended uses;

(6) The applicant has established a radiation safety committee to approve, in advance, proposals for uses of particle accelerators, whenever deemed necessary by the department; and

(7) The applicant has an adequate training program for particle accelerator operators.

[Statutory Authority: RCW 70.98.050 and 70.98.080. 91-15-083 (Order 183), § 246-229-020, filed 7/23/91, effective 8/23/91. Statutory Authority: RCW 43.70.040. 91-02-049 (Order 121), recodified as § 246-229-020, filed

12/27/90, effective 1/31/91. Statutory Authority: RCW 70.98.050. 81-01-011 (Order 1570), § 402-44-030, filed 12/8/80; Order 1084, § 402-44-030, filed 1/14/76.]

**WAC 246-229-030 Human use of particle accelerators.** In addition to the requirements set forth in chapter 246-224 WAC a certificate of registration for use of a particle accelerator in the healing arts will be issued only if:

(1) Whenever deemed necessary by the department, the applicant has appointed a medical committee of at least three members to evaluate all proposals for research, diagnostic, and therapeutic use of a particle accelerator. Membership of the committee should include physicians expert in internal medicine, hematology, therapeutic radiology, and a person experienced in depth dose calculations and protection against radiation;

(2) The individuals designated on the application as the users have substantial training and experience in deep therapy techniques or in the use of particle accelerators to treat humans; and

(3) The individual designated on the application as the user must be a physician.

[Statutory Authority: RCW 70.98.050 and 70.98.080. 91-15-083 (Order 183), § 246-229-030, filed 7/23/91, effective 8/23/91. Statutory Authority: RCW 43.70.040. 91-02-049 (Order 121), recodified as § 246-229-030, filed 12/27/90, effective 1/31/91. Statutory Authority: RCW 70.98.050. 81-01-011 (Order 1570), § 402-44-040, filed 12/8/80; Order 1084, § 402-44-040, filed 1/14/76.]

**WAC 246-229-040 General provisions.** (1) This section establishes radiation safety requirements for the use of particle accelerators. The provisions of this section are in addition to, and not in substitution for, other applicable provisions of the regulations.

(2) The registrant shall be responsible for assuring that all requirements of this chapter are met.

[Statutory Authority: RCW 43.70.040. 91-02-049 (Order 121), recodified as § 246-229-040, filed 12/27/90, effective 1/31/91. Statutory Authority: RCW 70.98.050. 81-01-011 (Order 1570), § 402-44-050, filed 12/8/80; Order 1084, § 402-44-050, filed 1/14/76.]

**WAC 246-229-050 Limitations.** (1) No registrant shall permit any person to act as a particle accelerator operator until such person:

(a) Has been instructed in radiation safety and shall have demonstrated an understanding thereof;

(b) Has received copies of and instruction in this chapter and the applicable requirements of chapters 246-221 and 246-222 WAC, pertinent registration conditions and the registrant's operating and emergency procedures, and shall have demonstrated understanding thereof;

(c) Has demonstrated competence to use the particle accelerator, related equipment, and survey instruments which will be employed in the individual's assignment; and

(2) The registrant shall maintain records which demonstrate compliance with the requirements of WAC 246-229-050(1).

(3) Either the radiation safety committee or the radiation safety officer shall have the authority to terminate the operations at a particle accelerator facility if such action is deemed necessary to protect health and minimize danger to public health and safety or property.

[Statutory Authority: RCW 70.98.050 and 70.98.080. 91-15-083 (Order 183), § 246-229-050, filed 7/23/91, effective 8/23/91. Statutory Authority: RCW 43.70.040. 91-02-049 (Order 121), recodified as § 246-229-050, filed 12/27/90, effective 1/31/91. Statutory Authority: RCW 70.98.050. 81-01-011 (Order 1570), § 402-44-060, filed 12/8/80; Order 1084, § 402-44-060, filed 1/14/76.]

**WAC 246-229-060 Shielding and safety design requirements.** (1) A qualified expert, specifically accepted by the department, shall be consulted in the design of a particle accelerator installation and called upon to perform a radiation survey when the accelerator is first capable of producing radiation.

(2) Each particle accelerator installation shall be provided with such primary and/or secondary barriers as are necessary to assure compliance with WAC 246-221-010 and 246-221-060.

[Statutory Authority: RCW 70.98.050 and 70.98.080. 91-15-083 (Order 183), § 246-229-060, filed 7/23/91, effective 8/23/91. Statutory Authority: RCW 43.70.040. 91-02-049 (Order 121), recodified as § 246-229-060, filed 12/27/90, effective 1/31/91. Statutory Authority: RCW 70.98.050. 81-01-011 (Order 1570), § 402-44-070, filed 12/8/80; Order 1084, § 402-44-070, filed 1/14/76.]

**WAC 246-229-070 Particle accelerator controls and interlock systems.** (1) Instrumentation, readouts and controls on the particle accelerator control console shall be clearly identified and easily discernible.

(2) All entrances into a target room or other high radiation area shall be provided with interlocks that shut down the machine under conditions of barrier penetration.

(3) When a radiation safety interlock system has been tripped, it shall only be possible to resume operation of the accelerator by manually resetting controls at the position where the interlock has been tripped, and lastly at the main control console.

(4) Each safety interlock shall be on a circuit which shall allow its operation independently of all other safety interlocks.

(5) All safety interlocks shall be fail safe, i.e., designed so that any defect or component failure in the interlock system prevents operation of the accelerator.

(6) A "scram" button or other emergency power cutoff switch shall be located and easily identifiable in all high radiation areas. Such a cutoff switch shall include a manual reset so that the accelerator cannot be restarted from the accelerator control console without resetting the cutoff switch.

[Statutory Authority: RCW 43.70.040. 91-02-049 (Order 121), recodified as § 246-229-070, filed 12/27/90, effective 1/31/91. Statutory Authority: RCW 70.98.050. 81-01-011 (Order 1570), § 402-44-080, filed 12/8/80; Order 1084, § 402-44-080, filed 1/14/76.]

**WAC 246-229-080 Warning devices.** (1) All locations designated as high radiation areas (except inside treatment rooms designed for human exposure) and entrances to all locations designated as high radiation areas shall be equipped with easily observable flashing or rotating warning lights that operate when, and only when, radiation is being produced.

(2) Except in facilities designed for human exposure, each high radiation area shall have an audible warning device which shall be activated for 15 seconds prior to the

possible creation of such high radiation area. Such warning device shall be clearly discernible in all high radiation areas. The registrant shall instruct all personnel in the vicinity of the particle accelerator as to the meaning of this audible warning signal.

(3) Barriers, temporary or otherwise, and pathways leading to high radiation areas shall be identified in accordance with WAC 246-221-120.

[Statutory Authority: RCW 70.98.050 and 70.98.080. 91-15-083 (Order 183), § 246-229-080, filed 7/23/91, effective 8/23/91. Statutory Authority: RCW 43.70.040. 91-02-049 (Order 121), recodified as § 246-229-080, filed 12/27/90, effective 1/31/91. Statutory Authority: RCW 70.98.050. 81-01-011 (Order 1570), § 402-44-090, filed 12/8/80; Order 1084, § 402-44-090, filed 1/14/76.]

**WAC 246-229-090 Operating procedures.** (1) Particle accelerators, when not in operation, shall be secured to prevent unauthorized use.

(2) Only a switch on the accelerator control console shall be routinely used to turn the accelerator beam off and on. The safety interlock system shall not be used to turn off the accelerator beam except in an emergency, or as required in WAC 246-229-090(3).

(3) All safety and warning devices, including interlocks, shall be checked for proper operation at intervals not to exceed three months and after maintenance on such safety and warning devices. Results of such tests shall be maintained for inspection at the accelerator facility.

(4) Electrical circuit diagrams of the accelerator, and the associated interlock systems, shall be kept current and maintained for inspection by the department and available to the operator at each accelerator facility.

(5) If, for any reason, it is necessary to bypass a safety interlock or interlocks intentionally, such action shall be:

(a) Authorized by the radiation safety committee and/or radiation safety officer;

(b) Recorded in a permanent log and a notice posted at the accelerator control console; and

(c) Terminated as soon as possible.

(6) A copy of the current operating and the emergency procedures shall be maintained at the accelerator control panel.

[Statutory Authority: RCW 70.98.050 and 70.98.080. 91-15-083 (Order 183), § 246-229-090, filed 7/23/91, effective 8/23/91. Statutory Authority: RCW 43.70.040. 91-02-049 (Order 121), recodified as § 246-229-090, filed 12/27/90, effective 1/31/91. Statutory Authority: RCW 70.98.050. 81-01-011 (Order 1570), § 402-44-100, filed 12/8/80; Order 1084, § 402-44-100, filed 1/14/76.]

**WAC 246-229-100 Radiation monitoring requirements.** (1) There shall be available at each particle accelerator facility, appropriate portable monitoring equipment which is operable and has been calibrated for the appropriate radiations being produced at the facility. Such equipment shall be tested for proper operation daily and calibrated at intervals not to exceed six months, and after each servicing and repair.

(2) A radiation protection survey shall be performed and documented by a qualified expert specifically approved by the department when changes have been made in shielding, operation, equipment, or occupancy of adjacent areas.

(3) Except for facilities designed for human exposure, radiation levels in all high radiation areas shall be continuously monitored. The monitoring devices shall be electrically independent of the accelerator control and interlock systems and capable of providing a remote and local readout with visual and/or audible alarms at both the control panel and at entrance to high radiation areas, and other appropriate locations, so that people entering or present become aware of the existence of the hazard.

(4) All area monitors shall be calibrated at intervals not to exceed six months, and after each servicing and repair. Records of calibration shall be maintained by the facility for a minimum of two years.

(5) Whenever applicable, periodic surveys shall be made to determine the amount of airborne particulate radioactivity present in areas of airborne hazards.

(6) Whenever applicable, periodic smear surveys shall be made to determine the degree of contamination in target and other pertinent areas.

(7) All area surveys shall be made in accordance with the written procedures established by a qualified expert, or the radiation safety officer of the particle accelerator facility.

(8) Records of all radiation protection surveys, calibration results, instrumentation tests, and smear results shall be kept current and on file at each accelerator facility.

[Statutory Authority: RCW 43.70.040. 91-02-049 (Order 121), recodified as § 246-229-100, filed 12/27/90, effective 1/31/91. Statutory Authority: RCW 70.98.050. 81-01-011 (Order 1570), § 402-44-110, filed 12/8/80; Order 1084, § 402-44-110, filed 1/14/76.]

**WAC 246-229-110 Ventilation systems.** (1) Means shall be provided to ensure that personnel are not exposed to airborne radioactive materials in excess of those limits specified in WAC 246-221-040, for restricted areas and WAC 246-221-070, for unrestricted areas.

(2) A registrant as required by WAC 246-221-070 shall not vent, release or otherwise discharge airborne radioactive material to an uncontrolled area which exceeds the limits specified in WAC 246-247-040 or 246-221-290 Appendix A - Table II, except as authorized pursuant to WAC 246-221-180 or 246-221-070(2). For purposes of this paragraph, concentrations may be averaged over a period not greater than one year. Every reasonable effort should be made to maintain releases of radioactive material to uncontrolled areas, as far below these limits as practicable.

[Statutory Authority: RCW 70.98.050 and 70.98.080. 91-15-083 (Order 183), § 246-229-110, filed 7/23/91, effective 8/23/91. Statutory Authority: RCW 43.70.040. 91-02-049 (Order 121), recodified as § 246-229-110, filed 12/27/90, effective 1/31/91. Statutory Authority: RCW 70.98.080. 87-01-031 (Order 2450), § 402-44-120, filed 12/11/86. Statutory Authority: RCW 70.98.050. 81-01-011 (Order 1570), § 402-44-120, filed 12/8/80; Order 1084, § 402-44-120, filed 1/14/76.]

**Chapter 246-232 WAC**

**RADIOACTIVE MATERIAL—LICENSING  
APPLICABILITY**

**WAC**

- 246-232-001 Purpose and scope.
- 246-232-010 Exemptions.
- 246-232-020 Types of licenses.
- 246-232-030 Prelicensing inspection.
- 246-232-040 Reciprocal recognition of licenses.

- 246-232-050 Terms and conditions of licenses.
- 246-232-060 Termination of licenses.
- 246-232-070 Modification and revocation of licenses.
- 246-232-080 Transfer of material.
- 246-232-090 Transportation.
- 246-232-120 Schedule B, exempt quantities of radioactive materials.
- 246-232-130 Schedule C, exempt concentrations.
- 246-232-140 Schedule D.
- 246-232-990 Fees.

**DISPOSITION OF SECTIONS FORMERLY  
CODIFIED IN THIS CHAPTER**

- 246-232-100 Requirements for users of the Washington commercial low-level waste disposal site. [Statutory Authority: RCW 43.70.040. 91-02-049 (Order 121), recodified as § 246-232-100, filed 12/27/90, effective 1/31/91. Statutory Authority: RCW 70.98.080 and chapter 70.121 RCW. 86-17-027 (Order 2406), § 402-19-530, filed 8/13/86. Statutory Authority: RCW 70.98.080. 83-19-050 (Order 2026), § 402-19-530, filed 9/16/83. Statutory Authority: RCW 70.98.050. 81-01-011 (Order 1570), § 402-19-530, filed 12/8/80. Statutory Authority: RCW 70.98.080. 80-02-080 (Order 1481), § 402-19-530, filed 1/21/80.] Repealed by 91-15-112 (Order 184), filed 7/24/91, effective 8/24/91. Statutory Authority: RCW 70.98.050 and 70.98.080.
- 246-232-110 Large volumes of naturally occurring material. [Statutory Authority: RCW 43.70.040. 91-02-049 (Order 121), recodified as § 246-232-110, filed 12/27/90, effective 1/31/91. Statutory Authority: RCW 70.98.080 and chapter 70.121 RCW. 86-17-027 (Order 2406), § 402-19-540, filed 8/13/86.] Repealed by 91-15-112 (Order 184), filed 7/24/91, effective 8/24/91. Statutory Authority: RCW 70.98.050 and 70.98.080.

**WAC 246-232-001 Purpose and scope.** (1) This chapter prescribes rules governing licensing of radioactive material. No person shall receive, possess, use, transfer, own or acquire radioactive material except as authorized in a specific or general license issued pursuant to chapters 246-233 or 246-235 WAC or as otherwise provided in this chapter.

(2) In addition to the requirements of this chapter, or chapters 246-233 or 246-235 WAC, all licensees are subject to the requirements of chapters 246-220, 246-221, 246-222, 246-247, and 246-254 WAC. Licensees engaged in the practice of nuclear medicine are subject to the requirements of chapter 246-239 WAC, licensees engaged in industrial radiographic operations are subject to the requirements of chapter 246-243 WAC, licensees using sealed sources in the healing arts are subject to the requirements of chapter 246-240 WAC, licensees using radioactive material in well logging and subsurface tracer studies are subject to the requirements of chapter 246-244 WAC, licensees engaged in land disposal of radioactive waste are subject to the requirements of chapter 246-250 WAC, and licensees owning or operating uranium or thorium mills and associated mill tailings are subject to the requirements of chapter 246-252 WAC.

[Statutory Authority: RCW 70.98.050 and 70.98.080. 91-15-112 (Order 184), § 246-232-001, filed 7/24/91, effective 8/24/91. Statutory Authority: RCW 43.70.040. 91-02-049 (Order 121), recodified as § 246-232-001, filed 12/27/90, effective 1/31/91. Statutory Authority: RCW 70.98.080. 83-19-050 (Order 2026), § 402-19-010, filed 9/16/83; 79-12-073 (Order 1459), § 402-19-010, filed 11/30/79, effective 1/1/80. Formerly chapter 402-20 WAC.]

**WAC 246-232-010 Exemptions.** (1) *Source material.*

(a) Any person is exempt from this chapter and chapters 246-233 and 246-235 WAC to the extent that such person receives, possesses, uses, owns, or transfers source material in any chemical mixture, compound, solution or alloy in which the source material is by weight less than 1/20 of one percent (0.05 percent) of the mixture, compound, solution, or alloy.

(b) Any person is exempt from this chapter and chapters 246-233 and 246-235 WAC to the extent that such person receives, possesses, uses or transfers unrefined and unprocessed ore containing source material: *Provided*, That, except as authorized in a specific license, such person shall not refine or process such ore.

(c) Any person is exempt from this chapter and chapters 246-233 and 246-235 WAC to the extent that such person receives, possesses, uses or transfers:

(i) Any quantities of thorium contained in:

(A) Incandescent gas mantles;

(B) Vacuum tubes;

(C) Welding rods;

(D) Electric lamps for illuminating purposes provided that each lamp does not contain more than fifty milligrams of thorium;

(E) Germicidal lamps, sunlamps and lamps for outdoor or industrial lighting provided that each lamp does not contain more than two grams of thorium;

(F) Rare earth metals and compounds, mixtures, and products containing not more than 0.25 percent by weight thorium, uranium, or any combination of these; or

(G) Personnel neutron dosimeters, provided each dosimeter does not contain more than 50 milligrams of thorium;

(ii) Source material contained in the following products:

(A) Glazed ceramic tableware: *Provided*, That the glaze contains not more than twenty percent by weight source material; and

(B) Piezoelectric ceramic containing not more than two percent by weight source material;

(iii) Photographic film, negatives and prints containing uranium or thorium;

(iv) Any finished product or part fabricated of, or containing, tungsten-thorium or magnesium-thorium alloys: *Provided*, That the thorium content of the alloy does not exceed four percent by weight and that the exemption contained in this subparagraph shall not be deemed to authorize the chemical, physical or metallurgical treatment or processing of any such product or part;

(v) Depleted uranium contained in counterweights installed in aircraft, rockets, projectiles and missiles, or stored or handled in connection with installation or removal of such counterweights, provided that:

(A) The counterweights are manufactured in accordance with a specific license issued by the United States Nuclear Regulatory Commission authorizing distribution by the licensee pursuant to 10 CFR Part 40;

(B) Each counterweight has been impressed with the following legend clearly legible through any plating or other covering: "DEPLETED URANIUM"\*;

(C) Each counterweight is durably and legibly labeled or marked with the identification of the manufacturer and the

statement: "UNAUTHORIZED ALTERATIONS PROHIBITED"\*; and

(D) The exemption contained in this subparagraph shall not be deemed to authorize the chemical, physical or metallurgical treatment or processing of any such counterweight other than repair or restoration of any plating or other covering;

\*Note: The requirements specified in (c)(v)(B) and (C) of this subsection need not be met by counterweights manufactured prior to December 31, 1969: *Provided*, That such counterweights are impressed with the legend, "CAUTION - RADIOACTIVE MATERIAL - URANIUM," as previously required by the regulations.

(vi) Depleted uranium used as shielding constituting part of any shipping container which is conspicuously and legibly impressed with the legend "CAUTION - RADIOACTIVE SHIELDING - URANIUM" and the uranium metal is encased in mild steel or in an equally fire resistant metal of a minimum wall thickness of 3.2 millimeters.

(vii) Thorium contained in finished optical lenses: *Provided*, That each lens does not contain more than thirty percent by weight of thorium, and that the exemption contained in this subparagraph shall not be deemed to authorize either:

(A) The shaping, grinding or polishing of such lens or manufacturing processes other than the assembly of such lens into optical systems and devices without alteration of the lens; or

(B) The receipt, possession, use or transfer of thorium contained in contact lenses, or in spectacles, or in eyepieces in binoculars or other optical instruments;

(viii) Uranium contained in detector heads for use in fire detection units: *Provided*, That each detector head contains not more than 0.005 microcuries of uranium; or

(ix) Thorium contained in any finished aircraft engine part containing nickel-thoria alloy, provided that:

(A) The thorium is dispersed in the nickel-thoria alloy in the form of finely divided thoria (thorium dioxide); and

(B) The thorium content in the nickel-thoria alloy does not exceed four percent by weight.

(d) The exemptions in (c) of this subsection do not authorize the manufacture of any of the products described.

(2) *Radioactive material other than source material.*

(a) Exempt concentrations.

(i) Except as provided in (a)(ii) of this subsection any person is exempt from this chapter and chapters 246-233 and 246-235 WAC to the extent that such person receives, possesses, uses, transfers, owns or acquires products or materials containing radioactive material in concentrations not in excess of those listed in WAC 246-232-130, Schedule C.

(ii) No person may introduce radioactive material into a product or material, knowing or having reason to believe, that it will be transferred to persons exempt under (a)(i) of this subsection or equivalent regulations of the United States Nuclear Regulatory Commission, any agreement state or licensing state, except in accordance with a specific license issued pursuant to WAC 246-235-100(1) or the general license provided in WAC 246-232-040.

(b) Exempt quantities.

(i) Except as provided in (b)(ii) and (iii) of this subsection any person is exempt from these regulations to the extent that such person receives, possesses, uses, transfers,

owns or acquires radioactive material in individual quantities each of which does not exceed the applicable quantity set forth in WAC 246-232-120, Schedule B.

(ii) This paragraph, WAC 246-232-010 (2)(b), does not authorize the production, packaging or repackaging of radioactive material for purposes of commercial distribution, or the incorporation of radioactive material into products intended for commercial distribution.

(iii) No person may, for purposes of commercial distribution, transfer radioactive material in the individual quantities set forth in WAC 246-232-120, Schedule B, knowing or having reason to believe that such quantities of radioactive material will be transferred to persons exempt under (b) of this subsection or equivalent regulations of the United States Nuclear Regulatory Commission or any agreement state or licensing state, except in accordance with a specific license issued by the United States Nuclear Regulatory Commission, pursuant to Section 32.18 of 10 CFR Part 32 or by the department pursuant to WAC 246-235-100(2) which license states that the radioactive material may be transferred by the licensee to persons exempt under (b) of this subsection or the equivalent regulations of the United States Nuclear Regulatory Commission or any agreement state or licensing state.

(c) Exempt items.

(i) Certain items containing radioactive material. Except for persons who apply radioactive material to, or persons who incorporate radioactive material into the following products, any person is exempt from these regulations to the extent that person receives, possesses, uses, transfers, owns or acquires the following products:\*

\*Note: Authority to transfer possession or control by the manufacturer, processor, or producer of any equipment, device, commodity, or other product containing source material or byproduct material whose subsequent possession, use, transfer and disposal by all other persons who are exempted from regulatory requirements may be obtained only from the United States Nuclear Regulatory Commission, Washington, D.C. 20555.

(A) Timepieces or hands or dials containing not more than the following specified quantities of radioactive material and not exceeding the following specified levels of radiation:

- 25 millicuries of tritium per timepiece;
- 5 millicuries of tritium per hand;
- 15 millicuries of tritium per dial (bezels when used shall be considered as part of the dial);
- 100 microcuries of promethium - 147 per watch or 200 microcuries of promethium - 147 per any other timepiece;
- 20 microcuries of promethium - 147 per watch hand or 40 microcuries of promethium - 147 per other timepiece hand;
- 60 microcuries of promethium - 147 per watch dial or 120 microcuries of promethium - 147 per other timepiece dial (bezels when used shall be considered as part of the dial);

The levels of radiation from hands and dials containing promethium - 147 will not exceed, when measured through 50 milligrams per square centimeter of absorber:

For wrist watches, 0.1 millirad per hour at 1 centimeter from any surface;

For pocket watches, 0.1 millirad per hour at 1 centimeter from any surface;

For any other timepiece, 0.2 millirad per hour at 10 centimeters from any surface.

One microcurie of radium-226 per timepiece in timepieces manufactured prior to the effective date of these regulations.

(B) Lock illuminators containing not more than 15 millicuries of tritium or not more than 2 millicuries of promethium - 147 installed in automobile locks. The levels of radiation from each lock illuminator containing promethium - 147 will not exceed 1 millirad per hour at 1 centimeter from any surface when measured through 50 milligrams per square centimeter of absorber.

(C) Precision balances containing not more than 1 millicurie of tritium per balance or not more than 0.5 millicurie of tritium per balance part.

(D) Automobile shift quadrants containing not more than 25 millicuries of tritium.

(E) Marine compasses containing not more than 750 millicuries of tritium gas and other marine navigational instruments containing not more than 250 millicuries of tritium gas.

(F) Thermostat dials and pointers containing not more than 25 millicuries of tritium per thermostat.

(G) Electron tubes: *Provided*, That each tube does not contain more than one of the following specified quantities of radioactive material:

(aa) 150 millicuries of tritium per microwave receiver protector tube or 10 millicuries of tritium per any other electron tube;

(bb) 1 microcurie of cobalt-60;

(cc) 5 microcuries of nickel-63;

(dd) 30 microcuries of krypton-85;

(ee) 5 microcuries of cesium-137;

(ff) 30 microcuries of promethium-147;

(gg) 1 microcurie of radium-226;

*And provided further*, That the levels of radiation from each electron tube containing radioactive material does not exceed 1 millirad per hour at 1 centimeter from any surface when measured through 7 milligrams per square centimeter of absorber.\*

\*Note: For purposes of this subdivision, "electron tubes" include spark gap tubes, power tubes, gas tubes including glow lamps, receiving tubes, microwave tubes, indicator tubes, pick-up tubes, radiation detection tubes, and any other completely sealed tube that is designed to conduct or control electrical currents.

(H) Ionizing radiation measuring instruments containing, for purposes of internal calibration or standardization, a source of radioactive material not exceeding 0.05 microcuries of americium-241 or the applicable quantity set forth in WAC 246-232-120, Schedule B.

(I) Spark gap irradiators containing not more than 1 microcurie of cobalt-60 per spark gap irradiator for use in electrically ignited fuel oil burners having a firing rate of at least three gallons (11.4 liters) per hour.

(ii) Self-luminous products containing radioactive material(s).

(A) Tritium, krypton-85 or promethium-147. Except for persons who manufacture, process or produce self-luminous products containing tritium, krypton-85 or promethium-147,

any person is exempt from these regulations to the extent that such person receives, possesses, uses, transfers, owns or acquires tritium, krypton-85 or promethium-147 in self-luminous products manufactured, processed, produced, imported or transferred in accordance with a specific license issued by the United States Nuclear Regulatory Commission pursuant to Section 32.22 of 10 CFR Part 32, which license authorizes the transfer of the product to persons who are exempt from regulatory requirements. The exemption in (c)(ii) of this subsection does not apply to tritium, krypton-85 or promethium-147 used in products for frivolous purposes or in toys or adornments.

(B) Radium-226. Any person is exempt from these regulations to the extent that such person receives, possesses, uses, transfers or owns articles containing less than 0.1 microcurie of radium-226 which were manufactured prior to October 1983.

(iii) Gas and aerosol detectors containing radioactive material.

(A) Except for persons who manufacture, process or produce gas and aerosol detectors containing radioactive material, any person is exempt from these regulations to the extent that such person receives, possesses, uses, transfers, owns or acquires radioactive material in gas and aerosol detectors designed to protect life or property from fires and airborne hazards: *Provided*, That detectors containing radioactive material shall have been manufactured, imported, or transferred in accordance with a specific license issued by the United States Nuclear Regulatory Commission\* or an agreement state, pursuant to Section 32.26 of 10 CFR Part 32, or licensing state pursuant to WAC 246-235-100(3), which authorizes the transfer of the detectors to persons who are exempt from regulatory requirements.

\*Note: Authority to transfer possession or control by the manufacturer, processor, or producer of any equipment, device, commodity, or other product containing source material or byproduct material whose subsequent possession, use, transfer and disposal by all other persons are exempted from regulatory requirements may be obtained only from the United States Nuclear Regulatory Commission, Washington, D.C. 20555.

(B) Gas and aerosol detectors previously manufactured and distributed to general licensees in accordance with a specific license issued by an agreement state shall be considered exempt under (c)(iii)(A) of this subsection: *Provided*, That the device is labeled in accordance with the specific license authorizing distribution of the generally licensed device: *And provided further*, That they meet the requirements of WAC 246-235-100(3).

(C) Gas and aerosol detectors containing naturally occurring and accelerator-produced radioactive material (NARM) previously manufactured and distributed in accordance with a specific license issued by a licensing state shall be considered exempt under (c)(iii)(A) of this subsection: *Provided*, That the device is labeled in accordance with the specific license authorizing distribution of the generally licensed device, and provided further that they meet the requirements of WAC 246-235-100(3).

(iv) Resins containing scandium-46 and designed for sand consolidation in oil wells. Any person is exempt from these regulations to the extent that such person receives, possesses, uses, transfers, owns or acquires synthetic plastic resins containing scandium-46 which are designed for sand

consolidation in oil wells. Such resins shall have been manufactured or imported in accordance with a specific license issued by the United States Nuclear Regulatory Commission or shall have been manufactured in accordance with the specifications contained in a specific license issued by the department or any agreement state to the manufacturer of such resins pursuant to licensing requirements equivalent to those in Sections 32.16 and 32.17 of 10 CFR Part 32 of the regulations of the United States Nuclear Regulatory Commission. This exemption does not authorize the manufacture of any resins containing scandium-46.

[Statutory Authority: RCW 70.98.050 and 70.98.080. 91-15-112 (Order 184), § 246-232-010, filed 7/24/91, effective 8/24/91. Statutory Authority: RCW 43.70.040. 91-02-049 (Order 121), recodified as § 246-232-010, filed 12/27/90, effective 1/31/91. Statutory Authority: RCW 70.98.080. 87-01-031 (Order 2450), § 402-19-190, filed 12/11/86; 83-19-050 (Order 2026), § 402-19-190, filed 9/16/83. Statutory Authority: RCW 70.98.050. 81-01-011 (Order 1570), § 402-19-190, filed 12/8/80. Statutory Authority: RCW 70.98.080. 79-12-073 (Order 1459), § 402-19-190, filed 11/30/79, effective 1/1/80. Formerly WAC 402-20-190.]

**WAC 246-232-020 Types of licenses.** Licenses for radioactive materials are of two types: General and specific.

(1) General licenses provided in chapter 246-233 WAC are effective without the filing of applications with the department or the issuance of licensing documents to the particular persons, although the filing of a certificate with the department may be required by the particular general license. The general licensee is subject to all other applicable portions of these regulations and any limitations of the general license.

(2) Specific licenses require the submission of an application to the department and the issuance of a licensing document by the department. The licensee is subject to all applicable portions of these regulations as well as any limitations specified in the licensing document. (See chapter 246-235 WAC.)

[Statutory Authority: RCW 70.98.050 and 70.98.080. 91-15-112 (Order 184), § 246-232-020, filed 7/24/91, effective 8/24/91. Statutory Authority: RCW 43.70.040. 91-02-049 (Order 121), recodified as § 246-232-020, filed 12/27/90, effective 1/31/91. Statutory Authority: RCW 70.98.080. 79-12-073 (Order 1459), § 402-19-220, filed 11/30/79, effective 1/1/80. Formerly WAC 402-20-020.]

**WAC 246-232-030 Prelicensing inspection.** The department may verify information contained in applications and secure additional information deemed necessary to make a reasonable determination as to whether to issue a license and whether any special conditions should be attached thereto by visiting the facility or location where radioactive materials would be possessed or used, and by discussing details of the proposed possession or use of the radioactive materials with the applicant or representatives designated by the applicant. Such visits may be made by the department or its duly authorized representatives.

[Statutory Authority: RCW 43.70.040. 91-02-049 (Order 121), recodified as § 246-232-030, filed 12/27/90, effective 1/31/91. Statutory Authority: RCW 70.98.080. 79-12-073 (Order 1459), § 402-19-240, filed 11/30/79, effective 1/1/80. Formerly WAC 402-20-200.]

**WAC 246-232-040 Reciprocal recognition of licenses.** (1) Subject to these regulations, any person who holds a specific license from the United States Nuclear



Regulatory Commission or any agreement state or licensing state, and issued by the agency having jurisdiction where the licensee maintains an office for directing the licensed activity and at which radiation safety records are normally maintained, is hereby granted a general license to conduct the activities authorized in such licensing document within this state for a period not in excess of one hundred eighty days in that twelve month period which commences the date approval is granted, and the appropriate fee received, by the department provided that:

(a) The licensing document does not limit the activity authorized by such document to specified installations or locations;

(b) The out-of-state licensee notifies the department in writing and pays or has paid the appropriate fee (refer to chapter 246-254 WAC), at least three days prior to each entry to the state to engage in such activity. The written notification must be sent to the Radioactive Materials Section, Department of Health, Mailstop LE-13, Olympia, Washington 98504 and the fee should be sent to Washington State Department of Health, Revenue Accounting, P.O. Box 1099, Olympia, Washington 98504. Such notification shall indicate the location, period, and type of proposed possession and use within the state, and shall be accompanied by copies of the pertinent licensing documents. If, for a specific case, the three-day period would impose an undue hardship on the out-of-state licensee, the licensee may, upon telephone application to the department (360-753-4481), obtain permission to proceed sooner. The department may waive the requirement for filing additional written notifications during the remainder of the twelve months following the receipt of the initial notification from a person engaging in activities under the general license provided in this subsection;

(c) The out-of-state licensee complies with all applicable regulations of the department and with all the terms and conditions of the licensing document, except any such terms and conditions which may be inconsistent with applicable regulations of the department;

(d) The out-of-state licensee supplies such other information as the department may request; and

(e) The out-of-state licensee shall not transfer or dispose of radioactive material possessed or used under the general license provided in this subsection except by transfer to a person:

(i) Specifically licensed by the department or by the United States Nuclear Regulatory Commission, an agreement state or a licensing state to receive such material; or

(ii) Exempt from the requirements for a license for such material under WAC 246-232-010 (2)(a).

(2) Notwithstanding the provisions of subsection (1) of this section, any person who holds a specific license issued by the United States Nuclear Regulatory Commission, an agreement state or a licensing state authorizing the holder to manufacture, transfer, install, or service a device described in WAC 246-233-020(4) within the areas subject to the jurisdiction of the licensing body is hereby granted a general license to install, transfer, demonstrate or service a device in this state provided that:

(a) Such person shall file a report with the department within thirty days after the end of each calendar quarter in which any device is transferred to or installed in this state.

Each such report shall identify each general licensee to whom such device is transferred by name and address, the type of device transferred, and the quantity and type of radioactive material contained in the device;

(b) The device has been manufactured, labeled, installed, and serviced in accordance with applicable provisions of the specific license issued to such person by the United States Nuclear Regulatory Commission, an agreement state or a licensing state;

(c) Such person shall assure that any labels required to be affixed to the device under regulations of the authority which licensed manufacture of the device bear a statement that "Removal of this label is prohibited"; and

(d) The holder of the specific license shall furnish to each general licensee to whom such device is transferred or on whose premises such device is installed a copy of the general license contained in WAC 246-233-020(4).

(3) The department may withdraw, limit, or qualify its acceptance of any specific license or equivalent licensing document issued by another agency, or any product distributed pursuant to such licensing document, upon determining that such action is necessary in order to prevent undue hazard to public health and safety or property.

[Statutory Authority: RCW 70.98.050 and 70.98.080. 91-15-112 (Order 184), § 246-232-040, filed 7/24/91, effective 8/24/91. Statutory Authority: RCW 43.70.040. 91-02-049 (Order 121), recodified as § 246-232-040, filed 12/27/90, effective 1/31/91. Statutory Authority: RCW 70.98.080. 87-01-031 (Order 2450), § 402-19-250, filed 12/11/86; 83-19-050 (Order 2026), § 402-19-250, filed 9/16/83. Statutory Authority: RCW 70.98.050. 81-01-011 (Order 1570), § 402-19-250, filed 12/8/80. Statutory Authority: RCW 70.98.080. 79-12-073 (Order 1459), § 402-19-250, filed 11/30/79, effective 1/1/80. Formerly WAC 402-20-210.]

#### **WAC 246-232-050 Terms and conditions of licenses.**

(1) Each license issued pursuant to this part shall be subject to all the provisions of the act, as now or hereafter in effect, and to all rules, regulations, and orders of the department.

(2) No license issued or granted under chapters 246-233 and 246-235 WAC and no right to possess or utilize radioactive material granted by any license issued pursuant to chapters 246-233 and 246-235 WAC shall be transferred, assigned, or in any manner disposed, either voluntarily or involuntarily, directly or indirectly, through transfer of control of any license to any person unless the department shall, after securing full information find that the transfer is in accordance with the provisions of the act, and shall give its consent in writing.

(3) Each person licensed by the department pursuant to chapters 246-233 and 246-235 WAC shall confine use and possession of the material licensed to the locations and purposes authorized by the license.

(4) Approval of licensee's procedures by the department does not release the licensee from responsibility if adherence to these procedures results in undue exposure to individuals or loss of control of radioactive material.

(5) Each licensee shall notify the department of health, division of radiation protection, in writing, within five working days following the filing of a voluntary or involuntary petition for bankruptcy by or against:

(a) The licensee;

(b) A person controlling the licensee or listing the license or licensee as property of the estate; or

(c) An affiliate of the licensee.



(6) This notification must include:

(a) The bankruptcy court in which the petition for bankruptcy was filed;

(b) The date of the filing of the petition;

(c) A complete and detailed inventory of all radioactive material possessed under the license including nuclide, form, activity and planned disposition;

(d) An estimation of the type and quantities of radioactive material the licensee plans to continue to receive and/or use on a routine basis;

(e) A description of security and storage for the radioactive material currently possessed;

(f) A plan for radioactive waste disposal, the estimated completion date(s), and the cost;

(g) An evaluation of facility and equipment contamination, estimate of clean up costs, and a decontamination plan which includes a thorough description of how the clean up will be funded and how it will be accomplished;

(h) An organizational chart specifying sole owners, partnerships, or officers in the corporation who have legal and fiscal responsibilities for the licensee;

(i) A description of any other changes affecting the terms and conditions of the radioactive materials license.

(7) Each licensee shall notify the department within five working days if any items in subsection (6) of this section change during bankruptcy proceedings.

(8) The department will consider clean up costs as part of the licensee's administrative costs if decontamination is necessary to comply with these regulations;

(9) For the purposes of this section, "affiliate" means:

(a) A person as defined in WAC 246-220-010 that directly or indirectly owns, controls, or holds with power to vote, twenty percent or more of the outstanding voting securities of the licensee (unless that person holds such securities (i) in a fiduciary or agency capacity without sole discretionary power to vote such securities, or (ii) solely to secure a debt, if such person has not in fact exercised such power to vote);

(b) A corporation, twenty percent or more of whose outstanding voting securities are directly or indirectly owned, controlled, or held with power to vote, by the licensee;

(c) A person whose business is operated under a lease or operating agreement by a licensee, or person substantially all of whose property is operated under an operating agreement with the licensee; or

(d) A person that operates the business or substantially all of the property of the licensee under a lease or operating agreement.

[Statutory Authority: RCW 70.98.050 and 70.98.080. 92-06-008 (Order 245), § 246-232-050, filed 2/21/92, effective 3/23/92. Statutory Authority: RCW 43.70.040. 91-02-049 (Order 121), recodified as § 246-232-050, filed 12/27/90, effective 1/31/91. Statutory Authority: RCW 70.98.080. 87-01-031 (Order 2450), § 402-19-300, filed 12/11/86; 83-19-050 (Order 2026), § 402-19-300, filed 9/16/83. Statutory Authority: RCW 70.98.050. 81-01-011 (Order 1570), § 402-19-300, filed 12/8/80. Statutory Authority: RCW 70.98.080. 79-12-073 (Order 1459), § 402-19-300, filed 11/30/79, effective 1/1/80.]

#### **WAC 246-232-060 Termination of licenses.** (1)

Each specific licensee shall immediately notify the department in writing when the licensee decides to permanently discontinue all activities involving materials authorized under the license and request termination of the license. This

(1997 Ed.)

notification and request for termination of the license must include the reports and information specified in subsection (3) (c) and (d) of this section. The licensee is subject to the provisions of subsections (3) and (4) of this section, as applicable.

(2) No less than thirty days before the expiration date specified in a specific license, the licensee shall either:

(a) Submit an application for license renewal under WAC 246-235-050; or

(b) Notify the department in writing if the licensee decides not to renew the license.

(3) If a licensee does not submit an application for license renewal under WAC 246-235-050, the licensee shall on or before the expiration date specified in the license:

(a) Terminate use of byproduct material;

(b) Properly dispose of byproduct material;

(c) Submit a completed departmental form "Certificate of disposition of radioactive material"; and

(d) Submit a radiation survey report to confirm the absence of radioactive materials or establish the levels of radioactive contamination, unless the department determines a radiation survey report is not necessary.

(i) If no radioactive contamination attributable to activities conducted under the license is detected, the licensee shall submit a certification that no detectable radioactive contamination was found. If the information submitted under this paragraph and subsection (3) (c) and (d) of this section is adequate, the department will notify the licensee in writing that the license is terminated.

(ii) If detectable levels of radioactive contamination attributable to activities conducted under the license are found, the license continues in effect beyond the expiration date, if necessary, with respect to possession of residual radioactive material present as contamination until the department notifies the licensee in writing that the license is terminated. During this time, the licensee is subject to the provisions of subsection (4) of this section. In addition to the information submitted under subsection (3)(c) and (d) of this section, the licensee shall submit a plan for decontamination, if necessary.

(4) Each licensee who possesses residual byproduct material under subsection (3)(d)(ii) of this section, following the expiration of the facility and/or equipment date specified in the license, shall:

(a) Be limited to actions, involving radioactive material related to decontamination and preparation for release for unrestricted use; and

(b) Continue to control entry to restricted areas until they are suitable for release for unrestricted use and the department notifies the licensee in writing that the license is terminated. The guidance contained in WAC 246-232-140, Schedule D, shall be used in making this determination.

(5) Each general licensee licensed under the provisions of WAC 246-233-020(8), shall immediately notify the department in writing when the licensee decides to discontinue all activities involving radioactive materials authorized under the general license. Such notification shall include a description of how the generally licensed material was disposed and the results of facility surveys, if applicable, to confirm the absence of radioactive materials.

[Statutory Authority: RCW 70.98.050 and 70.98.080. 91-15-112 (Order 184), § 246-232-060, filed 7/24/91, effective 8/24/91. Statutory Authority:

[Title 246 WAC—page 259]

RCW 43.70.040. 91-02-049 (Order 121), recodified as § 246-232-060, filed 12/27/90, effective 1/31/91. Statutory Authority: RCW 70.98.080. 83-19-050 (Order 2026), § 402-19-330, filed 9/16/83.]

**WAC 246-232-070 Modification and revocation of licenses.** (1) The terms and conditions of all licenses shall be subject to amendment, revision, or modification, or the license may be suspended or revoked by reason of amendments to the act, or by reason of rules, regulations, and orders issued by the department.

(2) Any license may be revoked, suspended, or modified, in whole or in part, for any material false statement in the application or any statement of fact required under provisions of the act, or because of conditions revealed by such application or statement of fact or any report, record, or inspection or other means which would warrant the department to refuse to grant a license on an original application, or for violation of, or failure to observe any of the terms and conditions of the act, or of the license, or of any rule, regulation, or order of the department.

(3) Except in cases of willful disregard for the regulations or applicable license conditions or those in which the public health, interest, or safety requires otherwise, no license shall be modified, suspended, or revoked unless, prior to the institution of proceedings therefore, facts or conduct which may warrant such action shall have been called to the attention of the licensee in writing and the licensee shall have been accorded an opportunity to demonstrate or achieve compliance with all lawful requirements.

[Statutory Authority: RCW 43.70.040. 91-02-049 (Order 121), recodified as § 246-232-070, filed 12/27/90, effective 1/31/91. Statutory Authority: RCW 70.98.080. 87-01-031 (Order 2450), § 402-19-350, filed 12/11/86; 83-19-050 (Order 2026), § 402-19-350, filed 9/16/83; 79-12-073 (Order 1459), § 402-19-350, filed 11/30/79, effective 1/1/80. Formerly WAC 402-20-180.]

**WAC 246-232-080 Transfer of material.** (1) No licensee shall transfer radioactive material except as authorized pursuant to this section.

(2) Except as otherwise provided in the license and subject to the provisions of this section, any licensee may transfer radioactive material:

(a) To the department. A licensee may transfer material to the department only after receiving prior approval from the department;

(b) To the United States Department of Energy;

(c) To any person exempt from the regulations in this part to the extent permitted under such exemption;

(d) To any person authorized to receive such material under terms of a general license or its equivalent, or a specific license or equivalent licensing document, issued by the department, the United States Nuclear Regulatory Commission, any agreement state or any licensing state, or to any person otherwise authorized to receive such material by the federal government or any agency thereof, the department, any agreement state or any licensing state; or

(e) As otherwise authorized by the department in writing.

(3) Before transferring radioactive material to a specific licensee of the department, the United States Nuclear Regulatory Commission, an agreement state or a licensing state, or to a general licensee who is required to register with

the department, the United States Nuclear Regulatory Commission, an agreement state or a licensing state prior to receipt of the radioactive material, the licensee transferring the material shall verify that the transferee's license authorizes the receipt of the type, form, and quantity of radioactive material to be transferred.

(4) The following methods for the verification required by subsection (3) of this section are acceptable:

(a) The transferor may obtain for possession, and read, a current copy of the transferee's specific license or registration certificate;

(b) The transferor may obtain for possession a written certification from the transferee that the transferee is authorized by license or registration certificate to receive the type, form, and quantity of radioactive material to be transferred, specifying the license or registration certificate number, issuing agency, and expiration date;

(c) For emergency shipments the transferor may accept oral certification by the transferee that the transferee is authorized by license or registration certificate to receive the type, form, and quantity of radioactive material to be transferred, specifying the license or registration certificate number, issuing agency, and expiration date: *Provided*, That the oral certification is confirmed in writing within ten days;

(d) The transferor may obtain other sources of information compiled by a reporting service from official records of the department, the United States Nuclear Regulatory Commission, the licensing agency of an agreement state or a licensing state as to the identity of licensees and the scope and expiration dates of licenses and registration; or

(e) When none of the methods of verification described in subsection (4) of this section are readily available or when a transferor desires to verify that information received by one of such methods is correct or up-to-date, the transferor may obtain and record confirmation from the department, the United States Nuclear Regulatory Commission, or the licensing agency of an agreement state or a licensing state that the transferee is licensed to receive the radioactive material.

(5) Preparation for shipment and transport of radioactive material shall be in accordance with the provisions of WAC 246-232-090.

(6) The requirements of subsection (4) of this section notwithstanding, no verification is required when returning used, unused or decayed sources of radiation to the original manufacturer, (e.g., industrial radiography sources, teletherapy sources, portable moisture/density gauge sources, fixed gauge sources, and Mo-99/Tc-99m generators).

[Statutory Authority: RCW 70.98.050 and 70.98.080. 91-15-112 (Order 184), § 246-232-080, filed 7/24/91, effective 8/24/91. Statutory Authority: RCW 43.70.040. 91-02-049 (Order 121), recodified as § 246-232-080, filed 12/27/90, effective 1/31/91. Statutory Authority: RCW 70.98.080. 87-01-031 (Order 2450), § 402-19-400, filed 12/11/86. Statutory Authority: RCW 70.98.050. 81-01-011 (Order 1570), § 402-19-400, filed 12/8/80. Statutory Authority: RCW 70.98.080. 79-12-073 (Order 1459), § 402-19-400, filed 11/30/79, effective 1/1/80. Formerly WAC 402-20-170.]

**WAC 246-232-090 Transportation.** (1) *Transportation of radioactive material.* No person shall deliver radioactive material to a carrier for transport or transport radioactive material except as authorized in a general or

specific license issued by the department or as exempted in subsection (2) of this section.

(2) *Exemptions.*

(a) Common and contract carriers, freight forwarders, and warehousemen who are subject to the rules and regulations of the United States Department of Transportation (49 CFR Parts 170 through 189) or the United States Postal Service (Domestic Mail Manual, Section 124.3 incorporated by reference, 39 CFR 111.11 (1974)) are exempt from this section to the extent that they transport or store radioactive material in the regular course of their carriage for another or storage incident thereto. Common and contract carriers who are not subject to the rules and regulations of the United States Department of Transportation or United States Postal Service are subject to subsection (1) of this section and other applicable sections of these regulations.

(b) Physicians, as defined in WAC 246-220-010, are exempt from the requirements of this section only to the extent that they transport radioactive material for emergency use in the practice of medicine.

(c) Specific licensees are exempt from this section to the extent that they deliver to a carrier for transport packages each of which contains no radioactive material having a specific activity in excess of 0.002 microcurie per gram.

(d) Any licensee who delivers radioactive material to a carrier for transport, where such transport is subject to the regulations of the United States Postal Service, is exempt from the provisions of subsection (1) of this section.

(3) *General licenses for carriers.*

(a) A general license is hereby issued to any common or contract carrier not exempted under subsection (2) of this section to receive, possess, transport and store radioactive material in the regular course of their carriage for another or storage incident thereto, provided the transportation and storage is in accordance with the applicable requirements of the regulations, appropriate to the mode of transport, of the United States Department of Transportation.

(b) A general license is hereby issued to any private carrier to transport radioactive material, provided the transportation is in accordance with the applicable requirements of the regulations, appropriate to the mode of transport, of the United States Department of Transportation insofar as such regulations relate to the loading and storage of packages, placarding of the transporting vehicle, shipping papers, and incident reporting.<sup>1</sup>

(c) Persons who transport radioactive material pursuant to the general licenses in (a) or (b) of this subsection are exempt from the requirements of chapters 246-221 and 246-222 WAC of these regulations to the extent that they transport radioactive material.

(4) *Preparation of radioactive material for transport.*

A general license is hereby issued to deliver radioactive material to a carrier<sup>2</sup> for transport provided that:

(a) The licensee complies with the applicable requirements of the regulations, appropriate to the mode of transport, of the United States Department of Transportation insofar as such regulations relate to the packaging of radioactive material, to shipping papers, and to the monitoring, marking and labeling of those packages.

(b) The licensee has established procedures for opening and closing packages in which radioactive material is transported to provide safety and to assure that, prior to the

delivery to a carrier for transport, each package is properly closed for transport.

(c) Prior to delivery of a package to a carrier for transport, the licensee shall assure that any special instructions needed to safely open the package are sent to or have been made [made] available to the consignee.

(d) In addition to the requirements of the United States Department of Transportation, each package of Type A or Type B quantity radioactive material prepared for shipment must have the innermost container labeled as to the isotope, chemical form, number of curies or subunits thereof, and date of determination of activity and each innermost container shall be tested to assure that the container is properly sealed and that contamination which would cause undue hazard to public health and safety or property is not present prior to transportation. This requirement does not apply to properly packaged shipments of radioactive waste consigned to a commercial low level waste burial facility.

(5) *Transport of nuclear waste—Advance notification requirement.* Prior to the transport of any nuclear waste outside of the confines of the licensee's plant or other place of use or storage, or prior to the delivery of any nuclear waste to a carrier for transport, each licensee shall comply with the procedures in this subsection for advance notification to the governor of a state or the governor's designee for the transport of nuclear waste to, through, or across the boundary of the state.

(a) Where, when, and how advance notification must be sent. The notification required by subsection (5) of this section must be made in writing to the office of each appropriate governor or governor's designee and to the director of the appropriate Nuclear Regulatory Commission Regional Office. A notification delivered by mail must be postmarked at least seven days before the beginning of the seven-day period during which departure of the shipment is estimated to occur. A notification delivered by messenger must reach the office of the governor or of the governor's designee at least four days before the beginning of the seven-day period during which departure of the shipment is estimated to occur. A list of the mailing addresses of the governors and governors' designees is available upon request from the Director, Office of State Programs, U.S. Nuclear Regulatory Commission, Washington, D.C. 20555. A copy of the notification shall be retained by the licensee as a record for one year.

(b) Information to be furnished in advance notification of shipment. Each advance notification of shipments of nuclear waste must contain the following information:

(i) The name, address, and telephone number of the shipper, carrier, and receiver of the nuclear waste shipment;

(ii) A description of the nuclear waste contained in the shipment as required by the regulations of the U.S. Department of Transportation in 49 CFR §§ 172.202 and 172.203(d);

(iii) The point of origin of the shipment, and the seven-day period during which departure of the shipment is estimated to occur;

(iv) The seven-day period during which arrival of the shipment at state boundaries is estimated to occur;

(v) The destination of the shipment, and the seven-day period during which arrival of the shipment is estimated to occur; and

(vi) A point of contact with a telephone number for current shipment information.

(c) Revision notice. A licensee who finds that schedule information previously furnished to a governor or governor's designee in accordance with (a) and (b) of this subsection will not be met, shall telephone a responsible individual in the office of the governor of the state or of the governor's designee and inform that individual of the extent of the delay relative to the schedule originally reported in writing under the provisions of (a) and (b) of this subsection. The licensee shall maintain a record of the name of the individual contacted for one year.

(d) Cancellation notice. Each licensee who cancels a nuclear waste shipment for which advance notification has been sent as required by this subsection shall send a cancellation notice to the governor of each state or the governor's designee previously notified and to the director of the appropriate Nuclear Regulatory Commission Inspection and Enforcement Regional Office. The notice shall state that it is a cancellation and shall identify the advance notification which is being cancelled. A copy of the notice shall be retained by the licensee as a record for one year.

<sup>1</sup>Any notification of incidents referred to in those requirements shall be filed with, or made to, the department.

<sup>2</sup>For the purpose of this regulation, licensees who transport their own licensed material as private carriers are considered to have delivered such material to a carrier for transport.

[Statutory Authority: RCW 70.98.050 and 70.98.080. 91-15-112 (Order 184), § 246-232-090, filed 7/24/91, effective 8/24/91. Statutory Authority: RCW 43.70.040. 91-02-049 (Order 121), recodified as § 246-232-090, filed 12/27/90, effective 1/31/91. Statutory Authority: RCW 70.98.080. 83-19-050 (Order 2026), § 402-19-500, filed 9/16/83. Statutory Authority: RCW 70.98.050. 81-01-011 (Order 1570), § 402-19-500, filed 12/8/80. Statutory Authority: RCW 70.98.080. 79-12-073 (Order 1459), § 402-19-500, filed 11/30/79, effective 1/1/80. Formerly WAC 402-20-220.]

**WAC 246-232-120 Schedule B, exempt quantities of radioactive materials.** (See also WAC 246-232-010 (2)(b).)

Radioactive Material	Microcuries
Antimony-122 (Sb-122)	100
Antimony-124 (Sb-124)	10
Antimony-125 (Sb-125)	10
Arsenic-73 (As-73)	100
Arsenic-74 (As-74)	10
Arsenic-76 (As-76)	10
Arsenic-77 (As-77)	100
Barium-131 (Ba-131)	10
Barium-133 (Ba-133)	10
Barium-140 (Ba-140)	10
Bismuth-210 (Bi-210)	1
Bromine-82 (Br-82)	10
Cadmium-109 (Cd-109)	10
Cadmium-115m (Cd-115m)	10
Cadmium-115 (Cd-115)	100
Calcium-45 (Ca-45)	10
Calcium-47 (Ca-47)	10
Carbon-14 (C-14)	100
Cerium-141 (Ce-141)	100
Cerium-143 (Ce-143)	100
Cerium-144 (Ce-144)	1
Cesium-129 (Cs-129)	100

Cesium-131 (Cs-131)	1,000
Cesium-134m (Cs-134m)	100
Cesium-134 (Cs-134)	1
Cesium-135 (Cs-135)	10
Cesium-136 (Cs-136)	10
Cesium-137 (Cs-137)	10
Chlorine-36 (Cl-36)	10
Chlorine-38 (Cl-38)	10
Chromium-51 (Cr-51)	1,000
Cobalt-57 (Co-57)	100
Cobalt-58m (Co-58m)	10
Cobalt-58 (Co-58)	10
Cobalt-60 (Co-60)	1
Copper-64 (Cu-64)	100
Dysprosium-165 (Dy-165)	10
Dysprosium-166 (Dy-166)	100
Erbium-169 (Er-169)	100
Erbium-171 (Er-171)	100
Europium-152 (Eu-152) 9.2h	100
Europium-152 (Eu-152) 13 yr	1
Europium-154 (Eu-154)	1
Europium-155 (Eu-155)	10
Fluorine-18 (F-18)	1,000
Gadolinium-153 (Gd-153)	10
Gadolinium-159 (Gd-159)	100
Gallium-67 (Ga-67)	100
Gallium-72 (Ga-72)	10
Germanium-71 (Ge-71)	100
Gold-198 (Au-198)	100
Gold-199 (Au-199)	100
Hafnium-181 (Hf-181)	10
Holmium-166 (Ho-166)	100
Hydrogen-3 (H-3)	1,000
Indium-111 (In-111)	100
Indium-113m (In-113m)	100
Indium-114m (In-114m)	10
Indium-115m (In-115m)	100
Indium-115 (In-115)	10
Iodine-123 (I-123)	100
Iodine-125 (I-125)	1
Iodine-126 (I-126)	1
Iodine-129 (I-129)	0.1
Iodine-131 (I-131)	1
Iodine-132 (I-132)	10
Iodine-133 (I-133)	1
Iodine-134 (I-134)	10
Iodine-135 (I-135)	10
Iridium-192 (Ir-192)	10
Iridium-194 (Ir-194)	100
Iron-52 (Fe-52)	10
Iron-55 (Fe-55)	100
Iron-59 (Fe-59)	10
Krypton-85 (Kr-85)	100
Krypton-87 (Kr-87)	10
Lanthanum-140 (La-140)	10
Lutetium-177 (Lu-177)	100
Manganese-52 (Mn-52)	10
Manganese-54 (Mn-54)	10
Manganese-56 (Mn-56)	10
Mercury-197m (Hg-197m)	100
Mercury-197 (Hg-197)	100
Mercury-203 (Hg-203)	10

Molybdenum-99 (Mo-99)	100
Neodymium-147 (Nd-147)	100
Neodymium-149 (Nd-149)	100
Nickel-59 (Ni-59)	100
Nickel-63 (Ni-63)	10
Nickel-65 (Ni-65)	100
Niobium-93m (Nb-93m)	10
Niobium-95 (Nb-95)	10
Niobium-97 (Nb-97)	10
Osmium-185 (Os-185)	10
Osmium-191m (Os-191m)	100
Osmium-191 (Os-191)	100
Osmium-193 (Os-193)	100
Palladium-103 (Pd-103)	100
Palladium-109 (Pd-109)	100
Phosphorus-32 (P-32)	10
Platinum-191 (Pt-191)	100
Platinum-193m (Pt-193m)	100
Platinum-193 (Pt-193)	100
Platinum-197m (Pt-197m)	100
Platinum-197 (Pt-197)	100
Polonium-210 (Po-210)	0.1
Potassium-42 (K-42)	10
Potassium-43 (K-43)	10
Praseodymium-142 (Pr-142)	100
Praseodymium-143 (Pr-143)	100
Promethium-147 (Pm-147)	10
Promethium-149 (Pm-149)	10
Radium-226 (Ra-226)	0.1
Rhenium-186 (Re-186)	100
Rhenium-188 (Re-188)	100
Rhodium-103m (Rh-103m)	100
Rhodium-105 (Rh-105)	100
Rubidium-81 (Rb-81)	10
Rubidium-86 (Rb-86)	10
Rubidium-87 (Rb-87)	10
Ruthenium-97 (Ru-97)	100
Ruthenium-103 (Ru-103)	10
Ruthenium-105 (Ru-105)	10
Ruthenium-106 (Ru-106)	1
Samarium-151 (Sm-151)	10
Samarium-153 (Sm-153)	100
Scandium-46 (Sc-46)	10
Scandium-47 (Sc-47)	100
Scandium-48 (Sc-48)	10
Selenium-75 (Se-75)	10
Silicon-31 (Si-31)	100
Silver-105 (Ag-105)	10
Silver-110m (Ag-110m)	1
Silver-111 (Ag-111)	100
Sodium-22 (Na-22)	10
Sodium-24 (Na-24)	10
Strontium-85 (Sr-85)	10
Strontium-89 (Sr-89)	1
Strontium-90 (Sr-90)	0.1
Strontium-91 (Sr-91)	10
Strontium-92 (Sr-92)	10
Sulphur-35 (S-35)	100
Tantalum-182 (Ta-182)	10
Technetium-96 (Tc-96)	10
Technetium-97m (Tc-97m)	100
Technetium-97 (Tc-97)	100

Technetium-99m (Tc-99m)	100
Technetium-99 (Tc-99)	10
Tellurium-125m (Te-125m)	10
Tellurium-127m (Te-127m)	10
Tellurium-127 (Te-127)	100
Tellurium-129m (Te-129m)	10
Tellurium-129 (Te-129)	100
Tellurium-131m (Te-131m)	10
Tellurium-132 (Te-132)	10
Terbium-160 (Tb-160)	10
Thallium-200 (Tl-200)	100
Thallium-201 (Tl-201)	100
Thallium-202 (Tl-202)	100
Thallium-204 (Tl-204)	10
Thulium-170 (Tm-170)	10
Thulium-171 (Tm-171)	10
Tin-113 (Sn-113)	10
Tin-125 (Sn-125)	10
Tungsten-181 (W-181)	10
Tungsten-185 (W-185)	10
Tungsten-187 (W-187)	100
Vanadium-48 (V-48)	10
Xenon-131m (Xe-131m)	1,000
Xenon-133 (Xe-133)	100
Xenon-135 (Xe-135)	100
Ytterbium-169 (Yb-169)	10
Ytterbium-175 (Yb-175)	100
Yttrium-87 (Y-87)	10
Yttrium-90 (Y-90)	10
Yttrium-91 (Y-91)	10
Yttrium-92 (Y-92)	100
Yttrium-93 (Y-93)	100
Zinc-65 (Zn-65)	10
Zinc-69m (Zn-69m)	100
Zinc-69 (Zn-69)	1,000
Zirconium-93 (Zr-93)	10
Zirconium-95 (Zr-95)	10
Zirconium-97 (Zr-97)	10

Any radioactive material not listed above other than alpha emitting radioactive material 0.1

[Statutory Authority: RCW 70.98.050 and 70.98.080. 91-15-112 (Order 184), § 246-232-120, filed 7/24/91, effective 8/24/91. Statutory Authority: RCW 43.70.040. 91-02-049 (Order 121), recodified as § 246-232-120, filed 12/27/90, effective 1/31/91. Statutory Authority: RCW 70.98.080. 83-19-050 (Order 2026), § 402-19-550, filed 9/16/83; 79-12-073 (Order 1459), § 402-19-550, filed 11/30/79, effective 1/1/80. Formerly WAC 402-20-240.]

**WAC 246-232-130 Schedule C, exempt concentrations. (See WAC 246-232-010 (2)(a).)**

Element (atomic number)	Isotope	Column I	Column II
		Gas concentration $\mu\text{Ci/ml}^1$	Liquid and solid concentration $\mu\text{Ci/ml}^2$
Antimony (51)	Sb-122		$3 \times 10^{-4}$
	Sb-124		$2 \times 10^{-3}$
	Sb-125		$1 \times 10^{-3}$
Argon (18)	Ar-37	$1 \times 10^{-3}$	
	Ar-41	$4 \times 10^{-7}$	
Arsenic (33)	As-73		$5 \times 10^{-3}$
	As-74		$5 \times 10^{-4}$
	As-76		$2 \times 10^{-4}$
	As-77		$8 \times 10^{-4}$

Barium (56)	Ba-131		2x10 <sup>-3</sup>	Promethium (61)	Pm-147		2x10 <sup>-3</sup>
	Ba-140		3x10 <sup>-4</sup>		Pm-149		4x10 <sup>-4</sup>
Beryllium (4)	Be-7		2x10 <sup>-2</sup>	Radium (88)	Ra-226		1x10 <sup>-7</sup>
Bismuth (83)	Bi-206		4x10 <sup>-4</sup>		Ra-228		3x10 <sup>-7</sup>
Bromine (35)	Br-82	4x10 <sup>-7</sup>	3x10 <sup>-3</sup>	Rhenium (75)	Re-183		6x10 <sup>-3</sup>
Cadmium (48)	Cd-109		2x10 <sup>-3</sup>		Re-186		9x10 <sup>-4</sup>
	Cd-115m		3x10 <sup>-4</sup>		Re-188		6x10 <sup>-4</sup>
	Cd-115		3x10 <sup>-5</sup>	Rhodium (45)	Rh-103m		1x10 <sup>-1</sup>
Calcium (20)	Ca-45		9x10 <sup>-5</sup>		Rh-105		1x10 <sup>-3</sup>
	Ca-47		5x10 <sup>-4</sup>	Rubidium	Rb-86		7x10 <sup>-4</sup>
Carbon (6)	C-14	1x10 <sup>-6</sup>	8x10 <sup>-3</sup>	Ruthenium (44)	Ru-97		4x10 <sup>-3</sup>
Cerium (58)	Ce-141		9x10 <sup>-4</sup>		Ru-103		8x10 <sup>-4</sup>
	Ce-143		4x10 <sup>-4</sup>		Ru-105		1x10 <sup>-3</sup>
	Ce-144		1x10 <sup>-2</sup>		Ru-106		1x10 <sup>-4</sup>
Cesium (55)	Cs-131		2x10 <sup>-2</sup>	Samarium (62)	Sm-153		8x10 <sup>-4</sup>
	Cs-134m		6x10 <sup>-5</sup>	Scandium (21)	Sc-46		4x10 <sup>-4</sup>
	Cs-134		9x10 <sup>-3</sup>		Sc-47		9x10 <sup>-4</sup>
Chlorine (17)	Cl-38	9x10 <sup>-7</sup>	4x10 <sup>-2</sup>		Sc-48		3x10 <sup>-4</sup>
Chromium (24)	Cr-51		2x10 <sup>-2</sup>	Selenium (34)	Se-75		3x10 <sup>-3</sup>
Cobalt (27)	Co-57		5x10 <sup>-3</sup>	Silicon (14)	Si-31		9x10 <sup>-3</sup>
	Co-58		1x10 <sup>-3</sup>	Silver (47)	Ag-105		1x10 <sup>-3</sup>
	Co-60		5x10 <sup>-4</sup>		Ag-110m		3x10 <sup>-4</sup>
Copper (29)	Cu-64		3x10 <sup>-3</sup>		Ag-111		4x10 <sup>-3</sup>
Dysprosium (66)	Dy-165		4x10 <sup>-3</sup>	Sodium (11)	Na-24		2x10 <sup>-3</sup>
	Dy-166		4x10 <sup>-4</sup>	Strontium (38)	Sr-85		1x10 <sup>-3</sup>
Erbium (68)	Er-169		9x10 <sup>-3</sup>		Sr-89		1x10 <sup>-4</sup>
	Er-171		1x10 <sup>-4</sup>		Sr-91		7x10 <sup>-4</sup>
Europium (63)	Eu-152		6x10 <sup>-4</sup>		Sr-92		7x10 <sup>-4</sup>
	(9.2 h)			Sulfur (16)	S-35	9x10 <sup>-8</sup>	6x10 <sup>-4</sup>
	Eu-155		2x10 <sup>-3</sup>	Tantalum (73)	Ta-182		4x10 <sup>-4</sup>
Fluorine (9)	F-18	2x10 <sup>-6</sup>	8x10 <sup>-3</sup>	Technetium (43)	Tc-96m		1x10 <sup>-1</sup>
Gadolinium (64)	Gd-153		2x10 <sup>-4</sup>		Tc-96		1x10 <sup>-3</sup>
	Gd-159		8x10 <sup>-4</sup>	Tellurium (52)	Te-125m		2x10 <sup>-3</sup>
Gallium (31)	Ga-72		4x10 <sup>-2</sup>		Te-127m		6x10 <sup>-4</sup>
Germanium (32)	Ge-71		2x10 <sup>-3</sup>		Te-127		3x10 <sup>-3</sup>
Gold (79)	Au-196		2x10 <sup>-3</sup>		Te-129m		3x10 <sup>-4</sup>
	Au-198		5x10 <sup>-4</sup>		Te-131m		6x10 <sup>-4</sup>
	Au-199		2x10 <sup>-3</sup>		Te-132		3x10 <sup>-4</sup>
Hafnium (72)	Hf-181		7x10 <sup>-2</sup>	Terbium (65)	Tb-160		4x10 <sup>-3</sup>
Hydrogen (1)	H-3	5x10 <sup>-6</sup>	3x10 <sup>-2</sup>	Thallium (81)	Tl-200		4x10 <sup>-3</sup>
Indium (49)	In-113m		1x10 <sup>-4</sup>		Tl-201		3x10 <sup>-3</sup>
	In-114m		2x10 <sup>-4</sup>		Tl-202		1x10 <sup>-3</sup>
Iodine (53)	I-125	3x10 <sup>-9</sup>	2x10 <sup>-5</sup>		Tl-204		1x10 <sup>-3</sup>
	I-126	3x10 <sup>-9</sup>	2x10 <sup>-5</sup>	Thulium (69)	Tm-170		5x10 <sup>-4</sup>
	I-131	3x10 <sup>-9</sup>	2x10 <sup>-5</sup>		Tm-171		5x10 <sup>-4</sup>
	I-132	8x10 <sup>-8</sup>	6x10 <sup>-4</sup>	Tin (50)	Sn-113		9x10 <sup>-4</sup>
	I-133	1x10 <sup>-8</sup>	7x10 <sup>-3</sup>		Sn-125		2x10 <sup>-4</sup>
	I-134	2x10 <sup>-7</sup>	1x10 <sup>-3</sup>	Tungsten			
Iridium (77)	Ir-190		2x10 <sup>-3</sup>	(Wolfram) (74)	W-181		4x10 <sup>-3</sup>
	Ir-192		4x10 <sup>-4</sup>		W-187		7x10 <sup>-4</sup>
	Ir-194		3x10 <sup>-3</sup>	Vanadium (23)	V-48		3x10 <sup>-4</sup>
Iron (26)	Fe-55		8x10 <sup>-3</sup>	Xenon (54)	Xe-131m	4x10 <sup>-6</sup>	
	Fe-59		6x10 <sup>-4</sup>		Xe-133	3x10 <sup>-6</sup>	
Krypton (36)	Kr-85m	1x10 <sup>-6</sup>			Xe-135	1x10 <sup>-6</sup>	
	Kr-85		3x10 <sup>-6</sup>	Ytterbium (70)	Yb-175		1x10 <sup>-3</sup>
Lanthanum (57)	La-140		2x10 <sup>-3</sup>	Yttrium (39)	Y-90		2x10 <sup>-4</sup>
Lead (82)	Pb-203		4x10 <sup>-3</sup>		Y-91m		3x10 <sup>-2</sup>
Lutetium (71)	Lu-177		1x10 <sup>-3</sup>		Y-91		3x10 <sup>-4</sup>
Manganese (25)	Mn-52		3x10 <sup>-3</sup>		Y-92		6x10 <sup>-4</sup>
	Mn-54		1x10 <sup>-3</sup>		Y-93		3x10 <sup>-3</sup>
	Mn-56		1x10 <sup>-3</sup>	Zinc (30)	Zn-65		1x10 <sup>-3</sup>
Mercury (80)	Hg-197m		2x10 <sup>-3</sup>		Zn-69m		7x10 <sup>-4</sup>
	Hg-197		3x10 <sup>-3</sup>		Zn-69		2x10 <sup>-2</sup>
	Hg-203		2x10 <sup>-4</sup>	Zirconium (40)	Zr-95		6x10 <sup>-4</sup>
Molybdenum (42)	Mo-99		2x10 <sup>-3</sup>		Zr-97		2x10 <sup>-4</sup>
Neodymium (60)	Nd-147		6x10 <sup>-3</sup>				
	Nd-149		3x10 <sup>-3</sup>	Beta and/or gamma emitting			
Nickel (28)	Ni-65		1x10 <sup>-3</sup>	radioactive material not			
Niobium				listed above with half-life			
(Columbium)(41)	Nb-95		1x10 <sup>-3</sup>	less than 3 years		1x10 <sup>-10</sup>	1x10 <sup>-6</sup>
	Nb-97		9x10 <sup>-3</sup>				
Osmium (76)	Os-185		7x10 <sup>-2</sup>	Notes:			
	Os-191m		3x10 <sup>-2</sup>	1 Values are given in Column I only for those materials normally used			
	Os-191		2x10 <sup>-4</sup>	as gases			
	Os-193		6x10 <sup>-3</sup>	2 μCi/gm for solids			
Palladium (46)	Pd-103		3x10 <sup>-3</sup>	Note 1: Many radioisotopes disintegrate into isotopes which are also			
	Pd-109		9x10 <sup>-4</sup>	radioactive. In expressing the concentrations in Schedule C the			
Phosphorus (15)	P-32		2x10 <sup>-3</sup>	activity stated is that of the parent isotope and takes into			
Platinum (78)	Pt-191		1x10 <sup>-3</sup>	account the daughters.			
	Pt-193m		1x10 <sup>-2</sup>	Note 2: For purposes of WAC 246-232-010(2) where there is involved			
	Pt-197m		1x10 <sup>-2</sup>	a combination of isotopes, the limit for the combination should			
	Pt-197		1x10 <sup>-3</sup>				
Potassium (19)	K-42		3x10 <sup>-3</sup>				
Praseodymium (59)	Pr-142		3x10 <sup>-4</sup>				
	Pr-143		5x10 <sup>-4</sup>				

be derived as follows: Determine for each isotope in the product the ratio between the concentration present in the product and the exempt concentration established in Schedule C for the specific isotope when not in combination. The sum of such ratios may not exceed "1" (i.e., unity).

Example:

$$\frac{\text{Concentration of Isotope A in Product}}{\text{Exempt concentration of Isotope A}} + \frac{\text{Concentration of Isotope B in Product}}{\text{Exempt concentration of Isotope B}} \leq 1$$

Note 3: For the purpose of determining concentration in a product or device, the total quantity of radioactive material present is divided by only that weight or volume of the discrete part or component throughout which the radioactive material is relatively uniformly distributed. If the weight or volume of this part or component cannot be determined then the product or device should be evaluated on the basis of the total quantity of radioactive material present.

[Statutory Authority: RCW 70.98.050 and 70.98.080, 91-15-112 (Order 184), § 246-232-130, filed 7/24/91, effective 8/24/91. Statutory Authority: RCW 43.70.040, 91-02-049 (Order 121), recodified as § 246-232-130, filed 12/27/90, effective 1/31/91. Statutory Authority: RCW 70.98.080, 87-01-031 (Order 2450), § 402-19-580, filed 12/11/86; 83-19-050 (Order 2026), § 402-19-580, filed 9/16/83; 79-12-073 (Order 1459), § 402-19-580, filed 11/30/79, effective 1/1/80. Formerly WAC 402-20-250.]

WAC 246-232-140 Schedule D.

ACCEPTABLE SURFACE CONTAMINATION LEVELS

NUCLIDES A	AVERAGE B C F	MAXIMUM B D F	REMOVABLE B E F WIPE LIMITS
U-nat, U-235, U-238, and associated decay products	5,000 dpm α/100 cm <sup>2</sup>	15,000 dpm α/100 cm <sup>2</sup>	1,000 dpm α/100 cm <sup>2</sup>
Transuranics, Ra-226, Ra-228, Th-230, Th-228, Pa-231, Ac-227, I-125, I-129	100 dpm/100 cm <sup>2</sup>	300 dpm/100 cm <sup>2</sup>	20 dpm/100 cm <sup>2</sup>
Th-nat, Th-232, Sr-90, Ra-223, Ra-224, U-232, I-126, I-131, I-133	1000 dpm/100 cm <sup>2</sup>	3000 dpm/100 cm <sup>2</sup>	200 dpm/100 cm <sup>2</sup>
Beta-gamma emitters (nuclides with decay modes other than alpha emission or spontaneous fission) except SR-90 and others noted above	5000 dpm βγ/100 cm <sup>2</sup>	15,000 dpm βγ/100 cm <sup>2</sup>	1000 dpm βγ/100 cm <sup>2</sup>

- A Where surface contamination by both alpha- and beta-gamma-emitting nuclides exists, the limits established for alpha- and beta-gamma-emitting nuclides should apply independently.
- B As used in this table, dpm (disintegrations per minute) means the rate of emission by radioactive material as determined by correcting the counts per minute observed by an appropriate detector for background, efficiency, and geometric factors associated with the instrumentation.
- C Measurements of average contaminant should not be averaged over more than 1 square meter. For objects of less surface area, the average should be derived for each such object.
- D The maximum contamination level applies to an area of not more than 100 cm<sup>2</sup>.
- E The amount of removable radioactive material per 100 cm<sup>2</sup> of surface area should be determined by wiping that area with dry filter or soft absorbent paper, applying moderate pressure, and assessing the amount of radioactive material on the wipe with an appropriate instrument of known efficiency. When removable contamination on objects of less surface area is determined, the pertinent levels should be reduced proportionally and the entire surface should be wiped.
- F The average and maximum radiation levels associated with surface contamination resulting from beta-gamma emitters should not exceed 0.2 mrad/hr at 1 cm and 1.0 mrad/hr at 1 cm, respectively, measured through not more than 7 milligrams per square centimeter of total absorber.

[Statutory Authority: RCW 43.70.040, 91-02-049 (Order 121), recodified as § 246-232-140, filed 12/27/90, effective 1/31/91. Statutory Authority: RCW 70.98.080, 87-01-031 (Order 2450), § 402-19-590, filed 12/11/86; 83-19-050 (Order 2026), § 402-19-590, filed 9/16/83.]

**WAC 246-232-990 Fees.** Fees are required from all applicants, licensees, or registrants. Chapter 246-254 WAC specifies fees for users of radiation subject to regulation under chapters 246-220 through 246-255 WAC.

[Statutory Authority: RCW 70.98.050 and 70.98.080, 91-15-112 (Order 184), § 246-232-990, filed 7/24/91, effective 8/24/91. Statutory Authority: RCW 43.70.040, 91-02-049 (Order 121), recodified as § 246-232-990, filed 12/27/90, effective 1/31/91. Statutory Authority: RCW 70.98.080, 83-19-050 (Order 2026), § 402-19-370, filed 9/16/83; 79-12-073 (Order 1459), § 402-19-370, filed 11/30/79, effective 1/1/80.]

**Chapter 246-233 WAC  
RADIOACTIVE MATERIALS—GENERAL  
LICENSES**

<b>WAC</b>	
246-233-001	Purpose and scope.
246-233-010	General licenses—Source material.
246-233-020	General licenses—Radioactive material other than source material.

**WAC 246-233-001 Purpose and scope.** This chapter establishes general licenses for the possession and use of radioactive material contained in certain items and a general license for ownership of radioactive material. Chapter 246-



232 WAC also contains provisions applicable to the subject matter of this part.

[Statutory Authority: RCW 70.98.050 and 70.98.080. 91-15-112 (Order 184), § 246-233-001, filed 7/24/91, effective 8/24/91. Statutory Authority: RCW 43.70.040. 91-02-049 (Order 121), recodified as § 246-233-001, filed 12/27/90, effective 1/31/91. Statutory Authority: RCW 70.98.080. 79-12-073 (Order 1459), § 402-21-010, filed 11/30/79, effective 1/1/80. Formerly chapter 402-20 WAC.]

**WAC 246-233-010 General licenses—Source material.** (1) A general license is hereby issued authorizing use, possession, and transfer of not more than fifteen pounds of source material at any one time by persons in the following categories:

(a) Pharmacists using the source material solely for the preparation of medicinal compounds;

(b) Physicians using the source material for medicinal purposes;

(c) Persons receiving possession of source material from pharmacists and physicians in the form of medicinals or drugs;

(d) Commercial and industrial firms, and research, educational, and medical institutions, and state and local government agencies for research, development, educational, operational, or commercial purposes: *And provided*, That no such person shall, pursuant to this general license, receive more than a total of one hundred fifty pounds of source material in any one calendar year.

(2) Persons who receive, possess, use, or transfer source material pursuant to the general license issued in subsection (1) of this section are exempt from the provisions of chapters 246-221 and 246-222 WAC to the extent that such receipt, possession, use, or transfer is within the terms of such general license: *Provided, however*, That this exemption shall not be deemed to apply to any such person who is also in possession of source material under a specific license issued pursuant to chapter 246-235 WAC.

(3) A general license is hereby issued authorizing the receipt of title to source material without regard to quantity. This general license does not authorize any person to receive, possess, use, or transfer source material.

(4) Depleted uranium in industrial products and devices.

(a) A general license is hereby issued to receive, acquire, possess, use, or transfer, in accordance with the provisions of paragraphs (4)(b), (c), (d), and (e) of this section, depleted uranium contained in industrial products or devices for the purpose of providing a concentrated mass in a small volume of the product or device.

(b) The general license in paragraph (4)(a) of this section applies only to industrial products or devices which have been manufactured either in accordance with a specific license issued to the manufacturer of the products or devices pursuant to WAC 246-235-100(13) or in accordance with a specific license issued to the manufacturer by the United States Nuclear Regulatory Commission or an agreement state which authorizes manufacture of the products or devices for distribution to persons generally licensed by the United States Nuclear Regulatory Commission or an agreement state.

(c)(i) Persons who receive, acquire, possess, or use depleted uranium pursuant to the general license established by paragraph (4)(a) of this section shall file department form

RHF-20 "Registration certificate - Use of depleted uranium under general license," with the department. The form shall be submitted within thirty days after the first receipt or acquisition of such depleted uranium. The registrant shall furnish on department form RHF-20 the following information and such other information as may be required by that form:

(A) Name and address of the registrant;

(B) A statement that the registrant has developed and will maintain procedures designed to establish physical control over the depleted uranium described in paragraph (4)(a) of this section and designed to prevent transfer of such depleted uranium in any form, including metal scrap, to persons not authorized to receive the depleted uranium; and

(C) Name and/or title, address, and telephone number of the individual duly authorized to act for and on behalf of the registrant in supervising the procedures identified in item (4)(c)(i)(B) of this section.

(ii) The registrant possessing or using depleted uranium under the general license established by paragraph (4)(a) of this section shall report in writing to the department any changes in information previously furnished on the "Registration certificate - Use of depleted uranium under general license." The report shall be submitted within thirty days after the effective date of such change.

(d) A person who receives, acquires, possesses, or uses depleted uranium pursuant to the general license established by paragraph (4)(a) of this section:

(i) Shall not introduce such depleted uranium, in any form, into a chemical, physical, or metallurgical treatment or process, except a treatment or process for repair or restoration of any plating or other covering of the depleted uranium.

(ii) Shall not abandon such depleted uranium.

(iii) Shall transfer or dispose of such depleted uranium only by transfer in accordance with the provision of chapter 246-232 WAC. In the case where the transferee receives the depleted uranium pursuant to the general license established by paragraph (4)(a) of this section the transferor shall furnish the transferee a copy of this regulation and a copy of department form RHF-20.

In the case where the transferee receives the depleted uranium pursuant to a general license contained in the United States Nuclear Regulatory Commission's or agreement state's regulation equivalent to paragraph (4)(a) of this section the transferor shall furnish the transferee a copy of this regulation and a copy of department form RHF-20 accompanied by a note explaining that use of the product or device is regulated by the United States Nuclear Regulatory Commission or agreement state under requirements substantially the same as those in this regulation.

(iv) Shall maintain and make available to the department upon request the name and address of the person receiving the depleted uranium pursuant to such transfer.

(v) Shall not export such depleted uranium except in accordance with a license issued by the United States Nuclear Regulatory Commission pursuant to 10 CFR Part 110.

(e) Any person receiving, acquiring, possessing, using, or transferring depleted uranium pursuant to the general license established by paragraph (4)(a) of this section is exempt from the requirements of chapters 246-221 and 246-

222 WAC of these regulations with respect to the depleted uranium covered by that general license.

[Statutory Authority: RCW 70.98.050 and 70.98.080. 91-15-112 (Order 184), § 246-233-010, filed 7/24/91, effective 8/24/91. Statutory Authority: RCW 43.70.040. 91-02-049 (Order 121), recodified as § 246-233-010, filed 12/27/90, effective 1/31/91. Statutory Authority: RCW 70.98.050. 81-01-011 (Order 1570), § 402-21-030, filed 12/8/80. Statutory Authority: RCW 70.98.080. 79-12-073 (Order 1459), § 402-21-030, filed 11/30/79, effective 1/1/80. Formerly WAC 402-20-030.]

**WAC 246-233-020 General licenses\*—Radioactive material other than source material.**

\*Note: Different general licenses are issued in this section, each of which has its own specific conditions and requirements.

(1) *Certain devices and equipment.* A general license is hereby issued to transfer, receive, acquire, own, possess, and use radioactive material incorporated in the following devices or equipment which have been manufactured, tested and labeled by the manufacturer in accordance with a specific license issued to the manufacturer by the United States Nuclear Regulatory Commission for use pursuant to Section 31.3 of 10 CFR Part 31. This general license is subject to the provisions of WAC 246-220-020, 246-220-030, 246-220-040, 246-220-050, 246-220-060, 246-220-070, chapters 246-232, 246-221\*\* and 246-222 WAC.

(a) *Static elimination device.* Devices designed for use as static eliminators which contain, as a sealed source or sources, radioactive material consisting of a total of not more than 500 microcuries of Polonium-210 per device.

(b) *Ion generating tube.* Devices designed for ionization of air which contain, as a sealed source or sources, radioactive material consisting of a total of not more than 500 microcuries of Polonium-210 per device or a total of not more than 50 millicuries of Hydrogen-3 (tritium) per device.

\*\* Attention is directed particularly to the provisions of chapter 246-221 WAC of these regulations which relate to the labeling of containers.

(2) Reserved.

(3) Reserved.

(4) *Certain measuring, gauging or controlling devices.*

(a) A general license is hereby issued to commercial and industrial firms and research, educational and medical institutions, individuals in the conduct of their business, and state or local government agencies to own, acquire, receive, possess, use or transfer, in accordance with the provisions of (b), (c), and (d) of this subsection, radioactive material excluding special nuclear material contained in devices designed and manufactured for the purpose of detecting, measuring, gauging or controlling thickness, density, level, interface location, radiation, leakage, or qualitative or quantitative chemical composition, or for producing light or an ionized atmosphere.

(b) The general license in (a) of this subsection applies only to radioactive material contained in devices which have been manufactured and labeled in accordance with the specifications contained in a specific license issued by the department pursuant to WAC 246-235-100(4) or in accordance with the Nuclear Regulatory Commission, an agreement state or a licensing state, which authorizes distribution of devices to persons generally licensed by the United States Nuclear Regulatory Commission, an agreement state or licensing state\*\*.

\*Note: Regulations under the Federal Food, Drug, and Cosmetic Act authorizing the use of radioactive control devices in food production require certain additional labeling thereon which is found in Section 179.21 of 21 CFR Part 179.

(c) Any person who owns, acquires, receives, possesses, uses or transfers radioactive material in a device pursuant to the general license in (a) of this subsection:

(i) Shall assure that all labels affixed to the device at the time of receipt and bearing a statement that removal of the label is prohibited are maintained thereon and shall comply with all instructions and precautions provided by such labels;

(ii) Shall assure that the device is tested for leakage of radioactive material and proper operation of the on-off mechanism and indicator, if any, at no longer than six-month intervals or at such other intervals as are specified in the label, however:

(A) Devices containing only krypton need not be tested for leakage of radioactive material; and

(B) Devices containing only tritium or not more than 100 microcuries of other beta and/or gamma emitting material or 10 microcuries of alpha emitting material need not be tested for any purpose. Devices held in storage in the original shipping container prior to initial installation need not be tested until immediately prior to use;

(iii) Shall assure that the tests required by (c)(ii) of this subsection and other testing, installing, servicing, and removing from installation involving the radioactive materials, its shielding or containment, are performed:

(A) In accordance with the instructions provided by the labels; or

(B) By a person holding a specific license from the department or from the United States Nuclear Regulatory Commission or from any agreement state or from a licensing state to perform such activities;

(iv) Shall maintain records showing compliance with the requirements of (c)(ii) and (iii) of this subsection. The records shall show the results of tests. The records also shall show the dates of performance and the names of persons performing, testing, installing, servicing, and removing from installation concerning the radioactive material, its shielding or containment. Records of tests for leakage of radioactive material required by (c)(ii) of this subsection shall be maintained for one year after the next required leak test is performed or the sealed source is transferred or disposed. Records of tests of the on/off mechanism and indicator required by (c)(ii) of this subsection shall be maintained for one year after the next required test of the on/off mechanism and indicator is performed or the sealed source is transferred or disposed. Records of other testing, installation, servicing, and removal from installation required by (c)(iii) of this subsection shall be maintained for a period of two years from the date of the recorded event or until the device is transferred or disposed;

(v) Upon the occurrence of a failure of or damage to, or any indication of a possible failure of or damage to, the shielding of the radioactive material or the on/off mechanism or indicator, or upon the detection of 0.005 microcuries or more removable radioactive material, shall immediately suspend operation of the device until it has been repaired by the manufacturer or other person holding a specific license from the department, the United States Nuclear Regulatory Commission, or from an agreement state or a licensing state

to repair such devices, or disposed by transfer to a person authorized by a specific license to receive the radioactive material contained in the device and, within thirty days, furnish to the department a written report containing a brief description of the event and the remedial action taken;

(vi) Shall not abandon the device containing radioactive material;

(vii) Except as provided in (c)(viii) of this subsection, shall transfer or dispose the device containing radioactive material only by transfer to a person holding a specific license of the department, the United States Nuclear Regulatory Commission, or an agreement state, or a licensing state whose specific license authorizes the person to receive the device and within thirty days after transfer of a device to a specific licensee shall furnish to the department a report containing identification of the device by manufacturer's name, model number and the name and address of the person receiving the device. No report is required if the device is transferred to the specific licensee in order to obtain a replacement device;

(viii) Shall transfer the device to another general licensee only:

(A) Where the device remains in use at a particular location. In such case, the transferor shall give the transferee a copy of this subsection and any safety documents identified in the label of the device and within thirty days of the transfer, report to the department the manufacturer's name, model number of device transferred, the name and address of the transferee, and the name and/or position of an individual who may constitute a point of contact between the department and the transferee; or

(B) Where the device is held in storage in the original shipping container at its intended location of use prior to initial use by a general licensee:

(ix) Shall comply with the provisions of WAC 246-221-240 and 246-221-250 for reporting radiation incidents, theft or loss of licensed material, but shall be exempt from the other requirements of chapters 246-221 and 246-222 WAC.

(d) The general license in (a) of this subsection does not authorize the manufacture, import or export of devices containing radioactive material.

(e) The general license provided in this subsection is subject to the provisions of WAC 246-220-020, 246-220-030, 246-220-040, 246-220-060, 246-220-070, 246-220-100, 246-232-050, 246-232-070, 246-232-080, and 246-232-090.

**(5) Luminous safety devices for aircraft.**

(a) A general license is hereby issued to own, receive, acquire, possess and use tritium or Promethium-147 contained in luminous safety devices for use in aircraft, provided:

(i) Each device contains not more than 10 curies of tritium or 300 millicuries of Promethium-147; and

(ii) Each device has been manufactured, assembled or imported in accordance with a specific license issued by the United States Nuclear Regulatory Commission, or each device has been manufactured or assembled in accordance with the specifications contained in a specific license issued by the department or any agreement state to the manufacturer or assembler of such device pursuant to licensing requirements equivalent to those in Section 32.53 of 10 CFR Part 32 of the regulations of the United States Nuclear Regulatory Commission.

(b) Persons who own, receive, acquire, possess or use luminous safety devices pursuant to the general license in this subsection are exempt from the requirements of chapters 246-221 and 246-222 WAC except that they shall comply with the provisions of WAC 246-221-240 and 246-221-250.

(c) This general license does not authorize the manufacture, assembly, or repair of luminous safety devices containing tritium or Promethium-147.

(d) This general license does not authorize the ownership, receipt, acquisition, possession or use of Promethium-147 contained in instrument dials.

(e) This general license is subject to the provisions of WAC 246-220-020, 246-220-030, 246-220-040, 246-220-050, 246-220-060, 246-220-070, 246-220-100, 246-232-050, 246-232-070, 246-232-080, and 246-232-090.

(6) **Ownership of radioactive material.** A general license is hereby issued to own radioactive material without regard to quantity. Notwithstanding any other provisions of this chapter, this general license does not authorize the manufacture, production, transfer, receipt, possession or use of radioactive material.

**(7) Calibration and reference sources.**

(a) A general license is hereby issued to those persons listed below to own, receive, acquire, possess, use and transfer, in accordance with the provisions of (d) and (e) of this subsection, Americium-241 in the form of calibration or reference sources:

(i) Any person who holds a specific license issued by the department which authorizes that person to receive, possess, use and transfer radioactive material; or

(ii) Any person who holds a specific license issued by the United States Nuclear Regulatory Commission which authorizes that person to receive, possess, use and transfer special nuclear material.

(b) A general license is hereby issued to own, receive, possess, use and transfer plutonium in the form of calibration or reference sources in accordance with the provisions of (d) and (e) of this subsection to any person who holds a specific license issued by the department which authorizes that person to receive, possess, use and transfer radioactive material.

(c) A general license is hereby issued to own, receive, possess, use and transfer Radium-226 in the form of calibration or reference sources in accordance with the provisions of (d) and (e) of this subsection to any person who holds a specific license issued by the department which authorizes that person to receive, possess, use and transfer radioactive material.

(d) The general licenses in (a), (b) and (c) of this subsection apply only to calibration or reference sources which have been manufactured in accordance with the specifications contained in a specific license issued to the manufacturer or importer of the sources by the United States Nuclear Regulatory Commission pursuant to Section 32.57 of 10 CFR Part 32 or Section 70.39 of 10 CFR Part 70 or which have been manufactured in accordance with the specifications contained in a specific license issued to the manufacturer by the department or any agreement state or licensing state pursuant to licensing requirements equivalent to those contained in Section 32.57 of 10 CFR Part 32 or Section 70.39 of 10 CFR Part 70 of the regulations of the United States Nuclear Regulatory Commission.

(e) The general licenses provided in (a), (b) and (c) of this subsection are subject to the provisions of WAC 246-220-020, 246-220-030, 246-220-040, 246-220-060, 246-220-070, 246-220-100, 246-232-050, 246-232-070, 246-232-080, 246-232-090, chapters 246-221 and 246-222 WAC.

In addition, persons who own, receive, acquire, possess, use or transfer one or more calibration or reference sources pursuant to these general licenses:

(i) Shall not possess at any one time, at any one location of storage or use, more than 5 microcuries of Americium-241 and 5 microcuries of plutonium and 5 microcuries of Radium-226 in such sources;

(ii) Shall not receive, possess, use or transfer such source unless the source, or the storage container, bears a label which includes one of the following statements or a substantially similar statement which contains the information called for in the following statement:

(A) The receipt, possession, use and transfer of this source, Model . . . . ., Serial No. . . . ., are subject to a general license and the regulations of the United States Nuclear Regulatory Commission or of a state with which the commission has entered into an agreement for the exercise of regulatory authority. Do not remove this label.

CAUTION - RADIOACTIVE MATERIAL - THIS SOURCE CONTAINS (AMERICIUM-241). (PLUTONIUM)\*. DO NOT TOUCH RADIOACTIVE PORTION OF THIS SOURCE

.....  
Name of manufacturer or importer

\*Note: Showing only the name of the appropriate material.

(B) The receipt, possession, use and transfer of this source, Model . . . . ., Serial No. . . . ., are subject to a general license and the regulations of any licensing state. Do not remove this label.

CAUTION - RADIOACTIVE MATERIAL - THIS SOURCE CONTAINS RADIUM-226. DO NOT TOUCH RADIOACTIVE PORTION OF THIS SOURCE.

.....  
Name of manufacturer or importer

(iii) Shall not transfer, abandon, or dispose of such source except by transfer to a person authorized by a license from the department, the United States Nuclear Regulatory Commission, or an agreement state or licensing state to receive the source;

(iv) Shall store such source, except when the source is being used, in a closed container adequately designed and constructed to contain Americium-241, Plutonium, or Radium-226/Radon-222 which might otherwise escape during storage; and

(v) Shall not use such source for any purpose other than the calibration of radiation detectors or the standardization of other sources.

(f) These general licenses do not authorize the manufacture of calibration or reference sources containing Americium-241, Plutonium, or Radium-226.

(8) *General license for use of radioactive material for certain in vitro clinical or laboratory testing.\**

(a) A general license is hereby issued to any physician, veterinarian, clinical laboratory or hospital to receive, acquire, possess, transfer or use, for any of the following stated tests, in accordance with the provisions of or use, for any of the following stated tests, in accordance with the provisions of (b), (c), (d), (e), and (f) of this subsection the following radioactive materials in prepackaged units:

(i) Iodine-125, in units not exceeding 10 microcuries each for use in *in vitro* clinical or laboratory tests not involving internal or external administration of radioactive material, or the radiation therefrom, to human beings or animals.

(ii) Iodine-131, in units not exceeding 10 microcuries each for use in *in vitro* clinical or laboratory tests not involving internal or external administration of radioactive material, or the radiation therefrom, to human beings or animals.

(iii) Carbon-14, in units not exceeding 10 microcuries each for use in *in vitro* clinical or laboratory tests not involving internal or external administration of radioactive material, or the radiation therefrom, to human beings or animals.

(iv) Hydrogen-3 (tritium), in units not exceeding 50 microcuries each for use in *in vitro* clinical or laboratory tests not involving internal or external administration of radioactive material, or the radiation therefrom, to human beings or animals.

(v) Iron-59, in units not exceeding 20 microcuries each for use in *in vitro* clinical or laboratory tests not involving internal or external administration of radioactive material, or the radiation therefrom, to human beings or animals.

(vi) Cobalt-57, in units not exceeding 10 microcuries each for use in *in vitro* clinical or laboratory tests not involving internal or external administration of radioactive material, or the radiation therefrom, to human beings or animals.

(vii) Selenium-75, in units not to exceed 10 microcuries each for use in *in vitro* clinical or laboratory tests not involving internal or external administration of radioactive material, or the radiation therefrom, to human beings or animals.

(viii) Mock Iodine-125 reference or calibration sources, in units not exceeding 0.05 microcurie of Iodine-129 and 0.005 microcurie of Americium-241 each for use in *in vitro* clinical or laboratory tests not involving internal or external administration of radioactive material, or the radiation therefrom, to human beings or animals.

\*Note: The new drug provisions of the Federal Food, Drug and Cosmetic Act also govern the availability and use of any specific diagnostic drugs in interstate commerce.

(b) No person shall receive, acquire, possess, use or transfer radioactive material pursuant to the general license established by (a) of this subsection until that person has received a validated copy of department Form RHF-15 "Certificate-in vitro testing with radioactive material under general license." Annual validation requires resubmittal of revised department Form RHF-15 and submittal of the annual fee to the department. The physician, veterinarian, clinical laboratory or hospital shall furnish on department Form RHF-15 the following information and such other information as may be required by that form:

(i) Name and address of the physician, veterinarian, clinical laboratory or hospital;

(ii) The location of use; and

(iii) A statement that the physician, veterinarian, clinical laboratory or hospital has appropriate radiation measuring instruments to carry out *in vitro* clinical or laboratory tests with radioactive material as authorized under the general license in (a) of this subsection and that such tests will be performed only by personnel competent in the use of such instruments and in the handling of the radioactive material.

(c) A person who receives, acquires, possesses or uses radioactive material pursuant to the general license established by (a) of this subsection shall comply with the following:

(i) The general licensee shall not possess at any one time, pursuant to the general license in (a) of this subsection at any one location of storage or use, a total amount of Iodine-125, Iodine-131, Selenium-75, Iron-59, and/or Cobalt-57 in excess of 200 microcuries.

(ii) The general licensee shall store the radioactive material, until used, in the original shipping container or in a container providing equivalent radiation protection.

(iii) The general licensee shall use the radioactive material only for the uses authorized by (a) of this subsection.

(iv) The general licensee shall not transfer the radioactive material to a person who is not authorized to receive it pursuant to a license issued by the department, the United States Nuclear Regulatory Commission, any agreement state or licensing state, nor transfer the radioactive material in any manner other than in the unopened, labeled shipping container as received from the supplier.

(v) The general licensee shall dispose of the Mock Iodine-125 reference or calibration sources described in (a)(viii) of this subsection as required by WAC 246-221-170.

(d) The general licensee shall not receive, acquire, possess, or use radioactive material pursuant to (a) of this subsection:

(i) Except as prepackaged units which are labeled in accordance with the provision of an applicable specific license issued pursuant to WAC 246-235-100(8) or in accordance with the provisions of a specific license issued by the United States Nuclear Regulatory Commission, or any agreement state or licensing state which authorizes the manufacture and distribution of Iodine-125, Iodine-131, Carbon-14, Hydrogen-3 (tritium), Iron-59, Selenium-75, Cobalt-57, or Mock Iodine-125 to persons generally licensed under this subsection or its equivalent; and

(ii) Unless one of the following statements, as appropriate, or a substantially similar statement which contains the information called for in one of the following statements, appears on a label affixed to each prepackaged unit or appears in a leaflet or brochure which accompanies the package:

This radioactive material shall be received, acquired, possessed and used only by physicians, veterinarians, clinical laboratories or hospitals and only for *in vitro* clinical or laboratory tests not involving internal or external administration of the material, or the radiation therefrom, to human beings or animals. Its receipt, acquisition, posses-

sion, use and transfer are subject to the regulations and a general license of the United States Nuclear Regulatory Commission or of a state with which the commission has entered into an agreement for the exercise of regulatory authority.

.....  
Name of manufacturer

This radioactive material shall be received, acquired, possessed and used only by physicians, veterinarians, clinical laboratories or hospitals and only for *in vitro* clinical or laboratory tests not involving internal or external administration of the material, or the radiation therefrom, to human beings or animals. Its receipt, acquisition, possession, use and transfer are subject to the regulations and a general license of a licensing state.

.....  
Name of manufacturer

(e) The physician, veterinarian, clinical laboratory or hospital possessing or using radioactive material under the general license of (a) of this subsection shall report in writing to the department, any changes in the information previously furnished in the "Certificate - *in vitro* testing with radioactive material under general license," department Form RHF-15. The report shall be furnished within thirty days after the effective date of such change.

(f) This general license is subject to the provisions of WAC 246-220-020, 246-220-030, 246-220-040, 246-220-060, 246-220-070, 246-220-090 and 246-220-100. In addition, any person using radioactive material pursuant to the general license of (a) of this subsection is exempt from the requirements of chapters 246-221 and 246-222 WAC with respect to radioactive material covered by that general license, except that such persons using the Mock Iodine-125 described in (a)(viii) of this subsection shall comply with the provisions of WAC 246-221-170, 246-221-240, and 246-221-250 and of these regulations.

(9) **Ice detection devices.**

(a) A general license is hereby issued to own, receive, acquire, possess, use and transfer Strontium-90 contained in ice detection devices, provided each device contains not more than 50 microcuries of Strontium-90 and each device has been manufactured or imported in accordance with a specific license issued by the United States Nuclear Regulatory Commission or each device has been manufactured in accordance with the specifications contained in a specific license issued by the department or any agreement state to the manufacturer of such device pursuant to licensing requirements equivalent to those in Section 32.61 of 10 CFR Part 32 of the regulations of the United States Nuclear Regulatory Commission.

(b) Persons who own, receive, acquire, possess, use or transfer Strontium-90 contained in ice detection devices pursuant to the general license in (a) of this subsection:

(i) Shall, upon occurrence of visually observable damage, such as a bend or crack or discoloration from overheating to the device, discontinue use of the device until it has been inspected, tested for leakage and repaired by a person holding a specific license from the United States Nuclear Regulatory Commission or an agreement state to

manufacture or service such devices; or shall dispose of the device pursuant to the provisions of these regulations;

(ii) Shall assure that all labels affixed to the device at the time of receipt, and which bear a statement which prohibits removal of the labels, are maintained thereon; and

(iii) Are exempt from the requirements of chapters 246-221 and 246-222 WAC except that such persons shall comply with the provisions of WAC 246-221-170, 246-221-240, and 246-221-250.

(c) This general license does not authorize the manufacture, assembly, disassembly or repair of Strontium-90 sources in ice detection devices.

(d) This general license is subject to the provisions of WAC 246-220-020, 246-220-030, 246-220-040, 246-220-060, 246-220-070, 246-220-100, 246-232-050, 246-232-070, 246-232-080, and 246-232-090.

[Statutory Authority: RCW 70.98.050 and 70.98.080. 91-15-112 (Order 184), § 246-233-020, filed 7/24/91, effective 8/24/91. Statutory Authority: RCW 43.70.040. 91-02-049 (Order 121), recodified as § 246-233-020, filed 12/27/90, effective 1/31/91. Statutory Authority: RCW 70.98.080. 87-01-031 (Order 2450), § 402-21-050, filed 12/11/86; 83-19-050 (Order 2026), § 402-21-050, filed 9/16/83. Statutory Authority: RCW 70.98.050. 81-01-011 (Order 1570), § 402-21-050, filed 12/8/80. Statutory Authority: RCW 70.98.080. 79-12-073 (Order 1459), § 402-21-050, filed 11/30/79, effective 1/1/80. Formerly WAC 402-20-040.]

**Chapter 246-235 WAC  
RADIOACTIVE MATERIALS—SPECIFIC  
LICENSES**

**WAC**

246-235-001	Purpose and scope.
246-235-010	Filing application for specific licenses.
246-235-020	General requirements for the issuance of specific licenses.
246-235-030	Issuance of specific licenses.
246-235-040	Expiration of licenses.
246-235-050	Renewal of license.
246-235-055	Precedence of license condition over regulation.
246-235-060	Amendment of licenses at request of licensee.
246-235-070	Agency action on applications to renew or amend.
246-235-075	Financial assurance and recordkeeping for decommissioning.
246-235-077	Special requirements for emergency planning.
246-235-080	Special requirements for issuance of certain specific licenses for radioactive material.
246-235-090	Special requirements for specific licenses of broad scope.
246-235-100	Special requirements for a specific license to manufacture, assemble, repair, or distribute commodities, products, or devices which contain radioactive material.
246-235-110	Special requirements for issuance of specific licenses for source material milling.
246-235-120	Schedule A groups of medical uses of radioactive material (ref. WAC 246-235-080(3) and 246-235-100(9)).
246-235-130	Appendix—General laboratory rules for safe use of unsealed sources.
246-235-140	Schedule B, limits for broad licenses.
246-235-150	Schedule C—Quantities of radioactive materials requiring consideration of the need for an emergency plan for responding to a release.

**WAC 246-235-001 Purpose and scope.** (1) This chapter prescribes requirements for the issuance of specific licenses.

(2) The provisions and requirements of this chapter are in addition to, and not in substitution for, other requirements of these regulations. In particular the provisions of chapter 246-232 WAC apply to applications and licenses subject to this chapter.

[Statutory Authority: RCW 70.98.050 and 70.98.080. 91-15-112 (Order 184), § 246-235-001, filed 7/24/91, effective 8/24/91. Statutory Authority: RCW 43.70.040. 91-02-049 (Order 121), recodified as § 246-235-001, filed 12/27/90, effective 1/31/91. Statutory Authority: RCW 70.98.080. 79-12-073 (Order 1459), § 402-22-010, filed 11/30/79, effective 1/1/80. Formerly chapter 402-20 WAC.]

**WAC 246-235-010 Filing application for specific licenses.** (1) Applications for specific licenses shall be filed on department form RHF-1.

(2) The department may at any time after the filing of the original application, and before the expiration of the license, require further statements in order to enable the department to determine whether the application should be granted or denied or whether a license should be modified or revoked.

(3) Each application shall be signed by the applicant or licensee or a person duly authorized to act for and on the applicant's behalf.

(4) An application for a license may include a request for a license authorizing one or more activities.

(5) In the application, the applicant may incorporate by reference information contained in previous applications, statements, or reports filed with the department provided such references are clear and specific.

(6) Applications and documents submitted to the department may be made available for public inspection except that the department may withhold any document or part thereof from public inspection if disclosure of its content is not required in the public interest and would adversely affect the interest of a person concerned.

[Statutory Authority: RCW 43.70.040. 91-02-049 (Order 121), recodified as § 246-235-010, filed 12/27/90, effective 1/31/91. Statutory Authority: RCW 70.98.080. 79-12-073 (Order 1459), § 402-22-020, filed 11/30/79, effective 1/1/80. Formerly WAC 402-20-050.]

**WAC 246-235-020 General requirements for the issuance of specific licenses.** A license application will be approved if the department determines that:

(1) The applicant is qualified by reason of training and experience to use the material in question for the purpose requested in accordance with these regulations in such a manner as to minimize danger to public health and safety or property;

(2) The applicant's proposed equipment, facilities, and procedures are adequate to minimize danger to public health and safety or property;

(3) The issuance of the license will not be inimical to the health and safety of the public; and

(4) The applicant satisfies any applicable special requirements in WAC 246-235-080, 246-235-090, 246-235-095, 246-235-100, and 246-247-050.

(5) In the case of an application for a license to receive and possess radioactive material for commercial waste disposal by land burial, source material milling, or for the conduct of any other activity which the agency determines will significantly affect the quality of the environment, the



department, before commencement of construction of the plant or facility in which the activity will be conducted, has concluded, after independently weighing the environmental, economic, technical and other benefits against environmental costs and considering available alternatives, that the action called for is the issuance of the proposed license, with any appropriate conditions to protect environmental values. Commencement of construction prior to such conclusion shall be grounds for denial of a license to receive and possess radioactive material in such plant or facility. As used in this paragraph the term "commencement of construction" means any clearing of land, excavation, or other substantial action that would adversely affect the environment of a site. The term does not mean site exploration, necessary borings to determine foundation conditions, or other preconstruction monitoring or testing to establish background information related to the suitability of the site or the protection of environmental values.

[Statutory Authority: RCW 70.98.050 and 70.98.080. 91-15-112 (Order 184), § 246-235-020, filed 7/24/91, effective 8/24/91. Statutory Authority: RCW 43.70.040. 91-02-049 (Order 121), recodified as § 246-235-020, filed 12/27/90, effective 1/31/91. Statutory Authority: RCW 70.98.080. 87-01-031 (Order 2450), § 402-22-040, filed 12/11/86. Statutory Authority: Chapter 70.121 RCW. 81-16-031 (Order 1683), § 402-22-040, filed 7/28/81. Statutory Authority: RCW 70.98.080. 79-12-073 (Order 1459), § 402-22-040, filed 11/30/79, effective 1/1/80. Formerly WAC 402-20-060.]

#### **WAC 246-235-030 Issuance of specific licenses. (1)**

Upon a determination that an application meets the requirements of the act and the regulations of the department the department will issue a specific license authorizing the proposed activity in such form and containing such conditions and limitations as it deems appropriate or necessary.

(2) The department may incorporate in any license at the time of issuance, or thereafter by appropriate rule, regulation, or order, such additional requirements and conditions with respect to the licensee's receipt, possession, use, storage, and transfer of radioactive material subject to this part as it deems appropriate or necessary in order to:

(a) Minimize danger to public health and safety or property;

(b) Require such reports and the keeping of such records, and to provide for such inspections of activities under the license as may be appropriate or necessary; and

(c) Prevent loss or theft of material subject to this part.

[Statutory Authority: RCW 43.70.040. 91-02-049 (Order 121), recodified as § 246-235-030, filed 12/27/90, effective 1/31/91. Statutory Authority: RCW 70.98.080. 87-01-031 (Order 2450), § 402-22-045, filed 12/11/86; 79-12-073 (Order 1459), § 402-22-045, filed 11/30/79, effective 1/1/80. Formerly WAC 402-20-080.]

**WAC 246-235-040 Expiration of licenses.** Except as provided in WAC 246-235-050(2), each specific license shall expire at the end of the day, in the month and year stated therein.

[Statutory Authority: RCW 70.98.050 and 70.98.080. 91-15-112 (Order 184), § 246-235-040, filed 7/24/91, effective 8/24/91. Statutory Authority: RCW 43.70.040. 91-02-049 (Order 121), recodified as § 246-235-040, filed 12/27/90, effective 1/31/91. Statutory Authority: RCW 70.98.080. 79-12-073 (Order 1459), § 402-22-050, filed 11/30/79, effective 1/1/80. Formerly WAC 402-20-100.]

**WAC 246-235-050 Renewal of license.** (1) Applications for renewal of specific licenses shall be filed in accordance with WAC 246-235-010.

(2) In any case in which a licensee, not less than thirty days prior to expiration of the existing license, has filed an application in proper form for renewal or for a new license authorizing the same activities, such existing license shall not expire until the application has been finally determined by the department.

[Statutory Authority: RCW 70.98.050 and 70.98.080. 91-15-112 (Order 184), § 246-235-050, filed 7/24/91, effective 8/24/91. Statutory Authority: RCW 43.70.040. 91-02-049 (Order 121), recodified as § 246-235-050, filed 12/27/90, effective 1/31/91. Statutory Authority: RCW 70.98.080. 79-12-073 (Order 1459), § 402-22-055, filed 11/30/79, effective 1/1/80. Formerly WAC 402-20-110.]

**WAC 246-235-055 Precedence of license condition over regulation.** (1) A license condition may be used to specifically modify any regulation pertaining to the possession, use, storage, transfer, or disposal of radioactive material. Any license condition used to modify an existing regulation shall set forth the title, chapter, section, and, where applicable, any subsection and paragraph numbers for the regulation being modified, and fully define the nature and extent of the modification.

(2) In the event a regulation is changed, an existing license condition that is more restrictive than the new regulation remains in force until there is an amendment or renewal of the license that removes or modifies the license condition.

[Statutory Authority: RCW 70.98.050. 94-01-073, § 246-235-055, filed 12/9/93, effective 1/9/94.]

**WAC 246-235-060 Amendment of licenses at request of licensee.** Applications for amendment of a license shall be filed in accordance with WAC 246-235-010 and shall specify the respects in which the licensee desires the license to be amended and the grounds for such amendment.

[Statutory Authority: RCW 70.98.050 and 70.98.080. 91-15-112 (Order 184), § 246-235-060, filed 7/24/91, effective 8/24/91. Statutory Authority: RCW 43.70.040. 91-02-049 (Order 121), recodified as § 246-235-060, filed 12/27/90, effective 1/31/91. Statutory Authority: RCW 70.98.080. 83-19-050 (Order 2026), § 402-22-060, filed 9/16/83; 79-12-073 (Order 1459), § 402-22-060, filed 11/30/79, effective 1/1/80. Formerly WAC 402-20-120.]

**WAC 246-235-070 Agency action on applications to renew or amend.** In considering an application by a licensee to renew or amend the license, the department will apply the criteria set forth in this chapter, as applicable.

[Statutory Authority: RCW 43.70.040. 91-02-049 (Order 121), recodified as § 246-235-070, filed 12/27/90, effective 1/31/91. Statutory Authority: RCW 70.98.080. 87-01-031 (Order 2450), § 402-22-065, filed 12/11/86; 79-12-073 (Order 1459), § 402-22-065, filed 11/30/79, effective 1/1/80. Formerly WAC 402-20-130.]

**WAC 246-235-075 Financial assurance and record-keeping for decommissioning.** (1) Each applicant for one of the following licenses shall submit a decommissioning funding plan as described in this section:



(a) A specific license authorizing receipt of radioactive waste for the purpose of volume reduction, repackaging or interim storage.

(b) Receipt of contaminated articles, scrap material, equipment, or clothing to be decontaminated at the licensee's facility.

(c) A specific license authorizing the possession and use of radioactive material of half-life greater than one hundred twenty days and in quantities for unsealed material exceeding  $10^3$  times and for sealed forms exceeding  $10^{10}$  times the applicable quantities set forth in WAC 246-221-300 Appendix B (for a combination of isotopes the unity rule applies. A decommissioning funding plan will be required if R is greater than 1, where R is defined as the sum of the ratios of the quantity for sealed and unsealed forms of each isotope compared to the applicable value derived from WAC 246-221-300).

(d) A specific license authorizing possession and use of source material in readily dispersible form and in quantities greater than 10 millicuries.

(2) Each decommissioning funding plan shall contain:

(a) A cost estimate for decommissioning facilities impacted by the activities authorized in the specific license.

(b) A description of the method of assuring funds for decommissioning.

(c) A schedule for adjusting cost estimates and associated funding levels periodically over the life of the facility or facilities.

(d) A description of methods and general procedures for performing facility decontamination, maintaining security, and performing a final radiation survey.

(e) A commitment to clean up accidental spills promptly and to begin decommissioning of the facility or facilities within twelve months of ceasing operation involving radioactive material.

(3) Each cost estimate for decommissioning shall include:

(a) A description of the facility and areas within the facility likely to require decommissioning as a result of routine operation.

(b) Anticipated labor, equipment and material costs.

(c) Anticipated waste volume.

(d) Anticipated packaging, transportation and waste disposal costs.

(e) An assessment of costs associated with an accident involving licensed material.

(4) Financial assurance for decommissioning shall be provided by one or more of the following methods:

(a) Prepayment. Prepayment is the deposit of sufficient funds to pay decommissioning costs. Funds shall be deposited prior to the start of operation into an account segregated from licensee assets and outside the licensee's administrative control. Prepayment may be in the form of a trust, escrow account, government fund, certificate of deposit, or deposit of government securities.

(b) A surety method, insurance, or other guarantee method. These methods guarantee that decommissioning costs will be paid should the licensee default. A surety method may be in the form of a surety bond, letter of credit, or line of credit. Any surety method or insurance used to provide financial assurance for decommissioning must contain the following conditions:

(i) The surety method or insurance shall be open-ended or, if written for a specified term, such as five years, shall be renewed automatically unless ninety days or more prior to the renewal date, the issuer notifies the department, the beneficiary, and the licensee of its intention not to renew. The surety method or insurance shall also provide that the full face amount be paid to the beneficiary automatically prior to the expiration without proof of forfeiture if the licensee fails to provide a replacement acceptable to the department within thirty days after receipt of notification of cancellation.

(ii) The surety method or insurance shall be payable to a trust established for decommissioning costs. The trustee and trust shall be acceptable to the department. Acceptable trustees include an appropriate state or federal government agency or an entity which has the authority to act as a trustee and whose trust operations are regulated and examined by a federal or state agency.

(iii) The surety method or insurance must remain in effect until the department has terminated the license.

(c) An external sinking fund in which deposits are made at least annually, coupled with a surety method or insurance, the value of which may decrease by the amount being accumulated in the sinking fund. An external sinking fund is a fund established and maintained by setting aside funds periodically in an account segregated from licensee assets and outside the licensee's administrative control. The total amount of funds in the external sinking fund shall be sufficient to pay decommissioning costs at the time termination of operation is expected. An external sinking fund may be in the form of a trust, escrow account, government fund, certificate of deposit, or deposit of government securities. The surety or insurance provisions shall be as stated in subsection (4)(b) of this section.

(d) In the case of state or local government licensees, a statement of intent containing a cost estimate for decommissioning and indicating that funds for decommissioning will be obtained when necessary.

(e) Other methods of financial assurance as approved by the department. The department may approve other financial mechanisms submitted by the applicant or licensee provided the alternate method meets, at a minimum, the requirements of 10 C.F.R. 30.35 and associated U.S. Nuclear Regulatory Commission guidance.

(5)(a) The department shall review each decommissioning funding plan prior to license issuance and prior to license renewal.

(b) The applicant or licensee shall incorporate department comments into its cost estimate and shall revise its financial surety accordingly.

(c) Applicants shall obtain the appropriate financial assurance as approved by the department prior to receipt of licensed material. The department may issue a new license if the applicant agrees to comply with the decommissioning funding plan as approved.

(d) Holders of licenses issued on or before the effective date of this rule shall submit a decommissioning funding plan to the department by April 1, 1993. Licensees shall implement the financial assurance requirements within thirty days of receiving department approval of the decommissioning funding plan. Licensees shall submit copies of the

financial surety within thirty days of securing the surety and annually thereafter.

(6) Each person licensed under this chapter shall keep records of information important to the safe and effective decommissioning of the facility in an identified location until the license is terminated by the department. If records of relevant information are kept for other purposes, reference to these records and their locations may be used. Information the department considers important to decommissioning consists of:

(a) Records of spills or other unusual occurrences involving the spread of contamination in and around the facility, equipment, or site. These records may be limited to instances when contamination remains after any cleanup procedures or when there is reasonable likelihood that contaminants may have spread to inaccessible areas as in the case of possible seepage into porous materials such as concrete. These records shall include any known information on identification of involved nuclides, quantities, forms, and concentrations.

(b) As-built drawings and modifications of structures and equipment in restricted areas where radioactive materials are used and/or stored, and of locations of possible inaccessible contamination such as buried pipes which may be subject to contamination. If required drawings are referenced, each relevant document need not be indexed individually. If drawings are not available, the licensee shall substitute appropriate records of available information concerning these areas and locations.

(c) Records of the cost estimate performed for the decommissioning funding plan or of the amount certified for decommissioning, and records of the funding method used for assuring funds if either a funding plan or certification is used.

[Statutory Authority: RCW 70.98.050 and 70.98.080. 92-06-008 (Order 245), § 246-235-075, filed 2/21/92, effective 3/23/92.]

**WAC 246-235-077 Special requirements for emergency planning.** (1) Each application to possess radioactive materials in unsealed form, on foils or plated sources, or sealed in glass in excess of the quantities in WAC 246-235-150, "Schedule C—Quantities of radioactive materials requiring consideration of the need for an emergency plan for responding to a release," must contain either:

(a) An evaluation showing that the maximum dose to a member of the public offsite due to a release of radioactive materials would not exceed 1 rem effective dose equivalent or 5 rems to the thyroid or an intake of 2 milligrams of soluble uranium; or

(b) An emergency plan for responding to the radiological hazards of an accidental release of radioactive material and to the chemical hazards associated with uranium hexafluoride, when present.

(2) One or more of the following factors may be used to support an evaluation submitted under subsection (1)(a) of this section:

(a) The radioactive material is physically separated so that only a portion could be involved in an accident;

(b) All or part of the radioactive material is not subject to release during an accident because of the way it is stored or packaged;

(c) The release fraction in the respirable size range would be lower than the release fraction listed in WAC 246-235-150 Schedule C due to the chemical or physical form of the material;

(d) The solubility of the radioactive material would reduce the dose received;

(e) Facility design or engineered safety features in the facility would cause the release fraction to be lower than listed in WAC 246-235-150 Schedule C;

(f) Operating restrictions or procedures would prevent a release fraction as large as that listed in WAC 246-235-150 Schedule C; or

(g) Other factors appropriate for the specific facility.

(3) An emergency plan for responding to a release of radioactive material submitted under subsection (1)(b) of this section must include the following information:

(a) Facility description. A brief description of the licensee's facility and area near the site.

(b) Types of accidents. An identification of each type of radioactive materials accident for which protective actions may be needed.

(c) Classification of accidents. A system for classifying accidents as alerts or site area emergencies.

(d) Detection of accidents. Identification of the means of detecting each type of accident in a timely manner.

(e) Mitigation of consequences. A brief description of the means and equipment for mitigating the consequences of each type of accident, including those provided to protect workers onsite, and a description of the program for maintaining the equipment.

(f) Assessment of releases. A brief description of the methods and equipment to assess releases of radioactive materials.

(g) Responsibilities. A brief description of the responsibilities of licensee personnel should an accident occur, including identification of personnel responsible for promptly notifying offsite response organizations and the department; also responsibilities for developing, maintaining, and updating the plan.

(h) Notification and coordination. A commitment, and a brief description of the means available, promptly to notify offsite response organizations and request offsite assistance, including medical assistance for the treatment of contaminated injured onsite workers when appropriate. A control point must be established. The notification and coordination must be planned so that unavailability of some personnel, parts of the facility, and some equipment will not prevent the notification and coordination. The licensee shall also commit to notify the department immediately after notification of the appropriate offsite response organizations and not later than one hour after the licensee declares an emergency. These reporting requirements do not supersede or release licensees from complying with the requirements under the Emergency Planning and Community Right-to-Know Act of 1986, Title III, Pub. L. 99-499 or other state or federal reporting requirements.

(i) Information to be communicated. A brief description of the types of information on facility status, radioactive releases, and recommended protective actions, if necessary, to be given to offsite response organizations and to the department.

(j) Training. A brief description of the frequency, performance objectives and plans for the training that the licensee will provide workers on how to respond to an emergency including any special instructions and orientation tours the licensee would offer to fire, police, medical and other emergency personnel. The training shall familiarize personnel with site-specific emergency procedures. Also, the training shall thoroughly prepare site personnel for their responsibilities in the event of accident scenarios postulated as most probable for the specific site, including the use of team training for such scenarios.

(k) Safe shutdown. A brief description of the means of restoring the facility to a safe condition after an accident.

(l) Exercises. Provisions for conducting quarterly communications checks with offsite response organizations and biennial onsite exercises to test response to simulated emergencies. Quarterly communications checks with offsite response organizations must include the check and update of all necessary telephone numbers. The licensee shall invite offsite response organizations to participate in the biennial exercises. Participation of offsite response organizations in biennial exercises although recommended is not required. Exercises must use accident scenarios postulated as most probable for the specific site and the scenarios shall not be known to most exercise participants. The licensee shall critique each exercise using individuals not having direct implementation responsibility for the plan. Critiques of exercises must evaluate the appropriateness of the plan, emergency procedures, facilities, equipment, training of personnel, and overall effectiveness of the response. Deficiencies found by the critiques must be corrected.

(m) Hazardous chemicals. A certification that the licensee or applicant has met its responsibilities under the Emergency Planning and Community Right-to-Know Act of 1986, Title III, Pub. L. 99-499, if applicable to the licensee's or applicant's activities at the proposed place of use of the radioactive material.

(4) The licensee shall allow the offsite response organizations expected to respond in case of an accident sixty days to comment on the licensee's emergency plan before submitting it to the department. The licensee shall provide any comments received within the sixty days to the department with the emergency plan.

[Statutory Authority: RCW 70.98.050, 95-01-108, § 246-235-077, filed 12/21/94, effective 1/21/95.]

**WAC 246-235-080 Special requirements for issuance of certain specific licenses for radioactive material.**

(1) *Human use of radioactive material in institutions.* In addition to the requirements set forth in WAC 246-235-020 a specific license for human use of radioactive material in institutions will be issued if:

(a) The applicant has appointed a radiation safety committee to coordinate the use of radioactive material throughout that institution and to maintain surveillance over the institution's radiation safety program. Membership of the committee should include a specialist (where applicable a physician) from each department where radioactive material is used, a representative of the institution's management, a representative of the nursing staff, and a person trained in radiation safety. The radiation safety committee

shall meet at intervals not to exceed six months. Minutes shall be taken and maintained for two years for inspection by the department;

(b) The applicant possesses adequate facilities for the clinical care of patients. The applicant is advised that construction of new radioisotope facilities and modification of existing facilities must also comply with the requirements of WAC 246-318-660 of the construction review section of the department;

(c) The physician(s) designated on the application as the individual user(s) has (or have) substantial experience in the handling and administration of radioactive material and, where applicable, the clinical management of radioactive patients; and

(d) If the application is for a license to use unspecified quantities or multiple types of radioactive material, the applicant's staff has substantial experience in the use of a variety of radioactive materials for a variety of human uses.

(2) *Licensing of individual physicians for human use of radioactive material.* In addition to the requirements set forth in WAC 246-235-020 a specific license for the human use of radioactive material will be issued to an individual physician if:

(a) The applicant has access to a hospital possessing adequate facilities to hospitalize and monitor the applicant's radioactive patients whenever it is advisable;

(b) The applicant has extensive experience in the handling and administration of radioactive material and, where applicable, the clinical management of radioactive patients;

(c) The application is for use in the applicant's practice in an office outside a medical institution; and

(d) The department will approve an application by an individual physician or group of physicians for a specific license to receive, possess or use radioactive material on the premises of a medical institution only if:

(i) The use of radioactive material is limited to the:

(A) Administration of radiopharmaceuticals for diagnostic or therapeutic purposes;

(B) Performance of diagnostic studies on patients to whom a radiopharmaceutical has been administered;

(C) Performance of in vitro diagnostic studies; or

(D) Calibration and quality control checks of radioactive assay instrumentation, radiation safety instrumentation and diagnostic instrumentation;

(ii) The physician brings the radioactive material with him or her and removes the radioactive material when he or she departs. (The institution cannot receive, possess or store radioactive material other than the amount of material remaining in the patient); and

(iii) The medical institution does not hold a radioactive material license issued pursuant to the provisions of subsection (1) of this section.

(3) *Specific licenses for certain groups of medical uses of radioactive material.*

(a) Subject to the provisions of (b), (c) and (d) of this subsection an application for a specific license pursuant to subsection (1), (2) or (4) of this section, or for any medical use or uses of radioactive material specified in one or more of Groups I to VI, inclusive, of WAC 246-235-120, Schedule A, will be approved for all of the uses within the group

or groups which include the use or uses specified in the application if:

(i) The applicant satisfies the requirements of subsection (1), (2) or (4) of this section;

(ii) The applicant, or the physician designated in the application as the individual user, has adequate clinical experience in the types of uses included in the group or groups;

(iii) The applicant, or the physicians and all other personnel who will be involved in the preparation and use of the radioactive material, have adequate training and experience in the handling of radioactive material appropriate to their participation in the uses included in the group or groups;

(iv) The applicant's radiation detection and measuring instrumentation is adequate for conducting the procedures involved in the uses included in the group or groups, specifically:

(A) For Groups I through V, applicant must possess and use a calibrated and operable low-range survey instrument with a thin window (less than 7 mg/cm<sup>2</sup>) capable of detecting radiation levels of 0.05 milliroentgen per hour up to at least 20 milliroentgens per hour;

(B) For Groups III, V, and VI, applicant must possess a calibrated and operable high-range survey instrument capable of detecting radiation levels up to at least one Roentgen per hour;

(v) The applicant's radiation safety operating procedures are adequate for handling and disposal of the radioactive material involved in the uses included in the group or groups.

(b) Any licensee or registrant who is authorized to use radioactive material pursuant to one or more groups in (a) of this subsection and WAC 246-235-120, Schedule A, is subject to the following conditions:

(i) For Groups I, II, IV, and V, no licensee or registrant shall receive, possess or use radioactive material except as a radiopharmaceutical manufactured in the form to be administered to the patient, labeled, packaged and distributed in accordance with a specific license issued by the department pursuant to WAC 246-235-100(10), a specific license issued by the United States Nuclear Regulatory Commission pursuant to Section 32.72 of 10 CFR Part 32, or a specific license issued by an agreement state or a licensing state pursuant to equivalent regulations.

(ii) For Group III, no licensee or registrant shall receive, possess or use generators or reagent kits containing radioactive material or shall use reagent kits that do not contain radioactive material to prepare radiopharmaceuticals containing radioactive material, except:

(A) Reagent kits not containing radioactive material that are approved by the department, the United States Nuclear Regulatory Commission, an agreement state or a licensing state for use by persons licensed pursuant to this subsection and WAC 246-235-120, Schedule A, or equivalent regulations; or

(B) Generators or reagent kits containing radioactive material that are manufactured, labeled, packaged and distributed in accordance with a specific license issued by the department pursuant to WAC 246-235-100(11), a specific license issued by the United States Nuclear Regulatory Commission pursuant to Section 32.73 of 10 CFR Part 32,

or a specific license issued by an agreement state or a licensing state pursuant to equivalent regulations.

(iii) For Group VI, no licensee or registrant shall receive, possess or use radioactive material except as contained in a source or device that has been manufactured, labeled, packaged and distributed in accordance with a specific license issued by the department pursuant to WAC 246-235-100(12), a specific license issued by the United States Nuclear Regulatory Commission pursuant to Section 32.74 of 10 CFR Part 32, or a specific license issued to the manufacturer by an agreement state or a licensing state pursuant to equivalent regulations.

(iv) For Group III, any licensee or registrant who uses generators or reagent kits shall elute the generator or process radioactive material with the reagent kit in accordance with instructions which are approved by the department, the United States Nuclear Regulatory Commission, an agreement state or a licensing state and are furnished by the manufacturer on the label attached to or in the leaflet or brochure which accompanies the generator or reagent kit.

(v) For Groups I, II and III any licensee using byproduct material for clinical procedures other than those specified in the product labeling (package insert) shall comply with the product labeling regarding:

(A) Chemical and physical form;

(B) Route of administration; and

(C) Dosage range.

(c) Any licensee who is licensed pursuant to (a) of this subsection for one or more of the medical use groups in WAC 246-235-120, Schedule A, also is authorized, subject to the provisions of (c) and (d) of this subsection to receive, possess and use for calibration and reference standards:

(i) Any radioactive material authorized for use in IND/NDA products under Group I, Group II, or Group III of WAC 246-235-120, Schedule A, with a half-life not longer than one hundred days, in amounts not to exceed 15 millicuries total;

(ii) Any radioactive material authorized for use in IND/NDA products under Group I, Group II, or Group III of WAC 246-235-120, Schedule A, with half-life greater than one hundred days in amounts not to exceed 200 microcuries total;

(iii) Technetium-99m in amounts not to exceed 30 millicuries;

(iv) Any radioactive material excluding Radium-226, in amounts not to exceed three millicuries per source (except Cobalt-57, which may be possessed in amounts not to exceed 5.5 millicuries), contained in calibration or reference sources that have been manufactured, labeled, packaged, and distributed in accordance with a specific license issued by the department pursuant to WAC 246-235-100(11), a specific license issued by the United States Nuclear Regulatory Commission pursuant to Section 32.74 of 10 CFR Part 32, or a specific license issued to the manufacturer by an agreement state or a licensing state pursuant to equivalent regulations.

(d) Leak tests.

(i) Any licensee or registrant who possesses sealed sources as calibration or reference sources pursuant to (c) of this subsection shall cause each sealed source containing radioactive material, other than Hydrogen-3, with a half-life greater than thirty days in any form other than gas to be

tested for leakage and/or contamination at intervals not to exceed six months. In the absence of a certificate from a transferor indicating that a test has been made within six months prior to the transfer, the sealed sources shall not be used until tested: *Provided, however,* That no leak tests are required when:

(A) The source contains 100 microcuries or less of beta and/or gamma emitting material or 10 microcuries or less of alpha emitting material;

(B) The sealed source is stored and is not being used: *Provided,* That a physical inventory of the source and wipe surveys of the storage area or storage container are conducted.

(ii) The leak test shall be capable of detecting the presence of 0.005 microcurie of radioactive material on the test sample. The test sample shall be taken from the sealed source or from the surfaces of the device in which the sealed source is mounted or stored on which contamination might be expected to accumulate. Records of leak test results shall be kept in units of microcuries and maintained for inspection by the department.

(iii) If the leak test reveals the presence of 0.005 microcurie or more of removable contamination, the licensee or registrant shall immediately withdraw the sealed source from use and shall cause it to be decontaminated and repaired or to be disposed of in accordance with chapters 246-235 and 246-221 WAC. A report shall be filed within five days of the test with the department describing the equipment involved, the test results, and the corrective action taken.

(e) Any licensee or registrant who possesses and uses calibration and reference sources pursuant to (c)(iv) of this subsection shall:

(i) Follow the radiation safety and handling instructions approved by the department, the United States Nuclear Regulatory Commission, an agreement state or a licensing state and furnished by the manufacturer on the label attached to the source, or permanent container thereof, or in the leaflet or brochure that accompanies the source, and maintain such instruction in a legible and conveniently available form; and

(ii) Conduct a quarterly physical inventory to account for all sources received and possessed. Records of the inventories shall be maintained for inspection by the department and shall include at a minimum the quantities and kinds of radioactive material, location of sources, name of person performing the inventory, and the date of the inventory.

(4) *Human use of sealed sources.* In addition to the requirements set forth in WAC 246-235-020, a specific license for human use of sealed sources will be issued only if the applicant or, if the application is made by an institution, the individual user:

(a) Has specialized training in the diagnostic or therapeutic use of the sealed source considered, or has experience equivalent to such training; and

(b) Is a physician.

(5) *Use of sealed sources in industrial radiography.* In addition to the requirements set forth in WAC 246-235-020, a specific license for use of sealed sources in industrial radiography will be issued if:

(a) The applicant will have an adequate program for training radiographers and radiographer's assistants and

submits to the department a schedule or description of such program which specifies the:

(i) Initial training;

(ii) Periodic training;

(iii) On-the-job training;

(iv) Means to be used by the licensee to determine the radiographer's knowledge and understanding of and ability to comply with department regulations and licensing requirements, and the operating and emergency procedures of the applicant; and

(v) Means to be used by the licensee to determine the radiographer's assistant's knowledge and understanding of and ability to comply with the operating and emergency procedures of the applicant;

(b) The applicant submits to the department and complies with satisfactory written operating and emergency procedures (described in WAC 246-243-140);

(c) The applicant will have a quarterly internal inspection system, to assure that license provisions, regulations, and the applicant's operating and emergency procedures are followed by radiographers and radiographer's assistants. Records of this management control program shall be maintained for two years;

(d) The applicant submits to the department a description of the applicant's overall organizational structure pertaining to the industrial radiography program, including specified delegations of authority and responsibility for operation of the program;

(e) The applicant who desires to conduct leak tests has established adequate procedures to be followed in leak testing sealed sources for possible leakage and contamination and submits to the department a description of such procedures including:

(i) Instrumentation to be used;

(ii) Method of performing tests, e.g., points on equipment to be smeared and method of taking smear; and

(iii) Pertinent experience of the person who will perform the tests;

(f) The licensee shall conduct a program for inspection and maintenance of radiographic exposure devices and storage containers to assure proper functioning of components important to safety.

(6) *Environmentally significant licensing actions.* In addition to the requirements set forth in WAC 246-235-020, a specific license for any activity within the licensing authority of the department which the department determines will significantly affect the radiological quality of the human environment, including those specified in WAC 197-11-845(1) and 246-03-030 (1)(a)(ii) (i.e., licenses to operate low level waste burial facilities or licenses to operate or expand beyond the design capacity, mineral processing facilities or their tailings areas, whose products, or byproducts, have concentrations of naturally occurring radioactive material in excess of exempt concentrations as specified in WAC 246-232-130, Schedule C), will be issued if the following conditions are met:

(a) Environmental impact statement.

(i) The application for a license or license amendment (other than administrative amendments) is accompanied or preceded by a final environmental impact statement or final declaration of nonsignificance completed in accordance with the State Environmental Policy Act (SEPA) procedures and

guidelines specified in chapters 197-11 and 246-03 WAC. For any uranium or thorium mill in operation on or before the effective date of this regulation for which an environmental impact statement has not been prepared previously, an application for license renewal must be accompanied or preceded by a final environmental impact statement or final declaration of nonsignificance completed in accordance with SEPA guidelines.

**Note:** No construction shall be commenced until the license has been issued or unless an emergency exemption from SEPA requirements is granted in accordance with WAC 197-11-880. For the purposes of this subsection, the term "commencement of construction" means any clearing of land, excavation or other substantial action related to a proposed activity for specific licensing that would adversely affect the natural environment of a site; this term does not include changes desirable for the temporary use of the land for public recreational use, limited borings to determine site characteristics as necessary for environmental assessment, or other preconstruction monitoring to establish background information related to suitability of a site or to the protection of environmental values. In the case where an exemption is granted, the applicant shall assume all financial risk for construction activity; waive any claim of entitlement to the issuance of a license based solely upon the grant of the exemption or the commencement of construction pursuant thereto; and furnish, if the circumstances warrant and the department so requires, a financial surety arrangement to insure the protection of the public health, safety and the environment in the event of abandonment, default, or inability of the license applicant to meet the requirements of the act or these regulations.

(ii) In addition to the information required in chapter 197-11 WAC, the following additional areas shall be addressed in the final environmental impact statement:

(A) Alternative sites to those chosen by the applicant shall include all alternative sites, whether or not those sites are under the control or ownership of the applicant.

(B) Long term impacts shall include, but not be limited to, decommissioning, decontamination, reclamation impacts and material management associated with the proposed activities.

(C) Environmental reviews, dose assessments, ecology, construction effects on biota, impact on the environment from the use of chemicals, and socioeconomic effects shall be addressed.

(D) Alternative disposal sites and techniques for disposal shall be evaluated to determine if a site or technique is clearly superior.

(b) For uranium or thorium milling operations, a bond made payable to the department of health or other acceptable government agency, and in an amount specified by the department, shall be posted to ensure the protection of the public health and safety in the event of abandonment, default or other inability of the licensee to meet the requirements for reclamation and disposal of tailings and for decommissioning the site. The bond, or a copy thereof when the bond is made payable to another government agency, shall be received by the department prior to issuance of the license, or prior to license renewal for mills in operation on or before the effective date of this regulation. Other acceptable surety arrangements in addition to surety bonding include cash deposits, certificates of deposit, deposits of government securities, letters or lines of credit or combinations of the foregoing. The amount and mechanism of the surety arrangement may be reviewed by the department preceding

each license renewal and adjustments may be required of the licensee prior to such renewal.

(c) The owner of the proposed uranium or thorium mill and tailings site(s) agrees to transfer or revert to the appropriate state or federal agency upon termination of the license, all lands, buildings and grounds, and any interest therein, necessary to fulfill the purposes of this subsection, except where the lands are held in trust for, or are owned by any Indian tribe. For any uranium or thorium mill in operation on or before the effective date of this regulation, such an agreement will be required prior to license renewal.

(d) For all uranium and thorium milling operations, the owner or operator shall arrange to pay to the department or its designee a fee in accordance with WAC 246-254-150 for a special security fund for the further maintenance, surveillance or care which may be required after a licensee has ceased to operate.

A minimum fund of two hundred fifty thousand dollars shall be provided by the licensee payable to the state. If a shortfall exists between the amount of money in the special security fund and the two hundred fifty thousand dollars minimum amount, a surety bond, or other acceptable surety instrument as defined above shall be arranged.

(e) The application for a license includes a description of an appropriate program for effluent monitoring, environmental monitoring and data reporting. Such description shall encompass locations, frequency, and types of sampling, analytical plans and procedures, minimum detection levels, sampling equipment and quality assurance programs.

(f) All licensees or registrants required to meet the additional requirements set forth in this subsection shall establish environmental monitoring programs adequate to determine the impact of their activity on the natural environment around the site of their environmentally significant activity. The established environmental and effluent monitoring program shall address all environmentally significant radionuclide releases and external radiation sources caused or threatened to be caused by the licensee's activities.

(i) Effluent and environmental monitoring results shall include the following minimum information as pertinent:

(A) Information as to flow rates, total volume of effluent, peak concentration, concentration of each radionuclide in the effluent averaged over a period of one year at the point where the effluent leaves a stack, tube, pipe, or similar conduit;

(B) A description of the properties of the effluents, including:

(I) Chemical composition;

(II) Physical characteristics, including suspended solids content in liquid effluents, and nature of gas aerosol for air effluents;

(III) The hydrogen ion concentrations (pH) of liquid effluents; and

(IV) The size range of particulates in effluent released into air;

(C) A description of the anticipated human occupancy in the unrestricted area where the highest concentration of radioactive material from the effluent is expected, and, in the case of a river stream a description of water uses downstream from the point of release of the effluent.



(D) Information as to the highest concentration of each radionuclide in an unrestricted area, including anticipated concentrations averaged over a period of one year:

(I) In air at any point of human occupancy; or

(II) In water at points of use downstream from the point of release of the effluent;

(E) The background concentration of radionuclides in the receiving river or stream prior to the release of liquid effluent;

(F) A description of the waste treatment facilities and procedures used to reduce the concentration of radionuclides in effluents prior to their release;

(G) A written description of sampling techniques and sample analysis methods;

(H) A written description of how all calculated results were obtained from sample analysis data. This explanation shall include example calculations and estimates of the precision and sensitivity of monitoring results;

(I) A written description of the licensee's quality control program including specification of control samples and standard samples used.

(ii) The licensee shall submit in writing to the department within sixty days after January 1 and July 1 of each year, reports specifying the quantities of each of the principle radionuclides released to unrestricted areas in liquid and in gaseous effluent during the previous six months of operations. This data shall be reported in a manner that will permit the department to confirm the potential annual radiation doses to the public. All data from the radiological and nonradiological environmental monitoring program will also be submitted for the same time period and frequency as specified above. The data shall be reported in a manner which will allow the department to confirm the potential annual radiation doses to the public.

(g) For land disposal of radioactive material, the provisions of chapter 246-250 WAC must also be met.

(h) For operation of mineral processing facilities, the provisions of chapter 246-252 WAC must also be met.

[Statutory Authority: RCW 70.98.050 and 70.98.080. 91-15-112 (Order 184), § 246-235-080, filed 7/24/91, effective 8/24/91. Statutory Authority: RCW 43.70.040. 91-02-049 (Order 121), recodified as § 246-235-080, filed 12/27/90, effective 1/31/91. Statutory Authority: RCW 70.98.080. 87-01-031 (Order 2450), § 402-22-070, filed 12/11/86; 83-19-050 (Order 2026), § 402-22-070, filed 9/16/83. Statutory Authority: RCW 70.98.050. 81-01-011 (Order 1570), § 402-22-070, filed 12/8/80. Statutory Authority: RCW 70.98.080. 79-12-073 (Order 1459), § 402-22-070, filed 11/30/79, effective 1/1/80. Formerly WAC 402-20-070.]

**WAC 246-235-090 Special requirements for specific licenses of broad scope.** This section prescribes requirements for the issuance of specific licenses of broad scope for radioactive material ("broad licenses") and certain regulations governing holders of such licenses.\*

\*Note: Authority to transfer possession or control by the manufacturer, processor, or producer of any equipment, device, commodity or other product containing source material or byproduct material whose subsequent possession, use, transfer and disposal by all other persons who are exempted from regulatory requirements may be obtained only from the United States Nuclear Regulatory Commission, Washington, D.C. 20555.

(1) *The different types of broad licenses are set forth below:*

(a) A "Type A specific license of broad scope" is a specific license authorizing receipt, acquisition, ownership, possession, use and transfer of any chemical or physical form of the radioactive material specified in the license, but not exceeding quantities specified in the license, for any authorized purpose. The quantities specified are usually in the multicurie range.

(b) A "Type B specific license of broad scope" is a specific license authorizing receipt, acquisition, ownership, possession, use and transfer of any chemical or physical form of radioactive material specified in WAC 246-235-140 Schedule B, for any authorized purpose. The possession limit for a Type B broad license, if only one radionuclide is possessed thereunder, is the quantity specified for that radionuclide in WAC 246-235-140 Schedule B, Column I. If two or more radionuclides are possessed thereunder, the possession limit for each is determined as follows: For each radionuclide, determine the ratio of the quantity possessed to the applicable quantity specified in WAC 246-235-140 Schedule B, Column I, for that radionuclide. The sum of the ratios for all radionuclides possessed under the license shall not exceed unity.

(c) A "Type C specific license of broad scope" is a specific license authorizing receipt, acquisition, ownership, possession, use and transfer of any chemical or physical form of radioactive material specified in WAC 246-235-140 Schedule B, for any authorized purpose. The possession limit for a Type C broad license, if only one radionuclide is possessed thereunder, is the quantity specified for that radionuclide in WAC 246-235-140 Schedule B, Column II. If two or more radionuclides are possessed thereunder, the possession limit is determined for each as follows: For each radionuclide determine the ratio of the quantity possessed to the applicable quantity specified in WAC 246-235-140 Schedule B, Column II, for that radionuclide. The sum of the ratios for all radionuclides possessed under the license shall not exceed unity.

(2) *An application for a Type A specific license of broad scope will be approved if:*

(a) The applicant satisfies the general requirements specified in WAC 246-235-020.

(b) The applicant has engaged in a reasonable number of activities involving the use of radioactive material; and

(c) The applicant has established administrative controls and provisions relating to organization and management, procedures, recordkeeping, material control and accounting, and management review that are necessary to assure safe operations, including:

(i) The establishment of a radiation safety committee composed of such persons as a radiation safety officer, a representative of management, and persons trained and experienced in the safe use of radioactive material;

(ii) The appointment of a radiation safety officer who is qualified by training and experience in radiation protection, and who is available for advice and assistance on radiation safety matters; and

(iii) The establishment of appropriate administrative procedures to assure:

(A) Control of procurement and use of radioactive material;

(B) Completion of safety evaluation of proposed uses of radioactive material which take into consideration such



matters as the adequacy of facilities and equipment, training and experience of the user, and the operating or handling procedures; and

(C) Review, approval, and recording by the radiation safety committee of safety evaluation of proposed uses prepared in accordance with item (2)(c)(iii)(B) of this section prior to use of the radioactive material.

(3) *An application for a Type B specific license of broad scope will be approved if:*

(a) The applicant satisfies the general requirements specified in WAC 246-235-020; and

(b) The applicant has established administrative controls and provisions relating to organization and management, procedures, recordkeeping, material control and accounting, and management review that are necessary to assure safe operations, including:

(i) The appointment of a radiation safety officer who is qualified by training and experience in radiation protection, and who is available for advice and assistance on radiation safety matters; and

(ii) The establishment of appropriate administrative procedures to assure:

(A) Control of procurement and use of radioactive material;

(B) Completion of safety evaluations of proposed uses of radioactive material which take into consideration such matters as the adequacy of facilities and equipment, training and experience of the user, and the operating or handling procedures; and

(C) Review, approval, and recording by the radiation safety officer of safety evaluations of proposed uses prepared in accordance with item (3)(b)(ii)(B) of this section prior to use of the radioactive material.

(4) *An application for a Type C specific license of broad scope will be approved if:*

(a) The applicant satisfies the general requirements specified in WAC 246-235-020.

(b) The applicant submits a statement that radioactive material will be used only by, or under the direct supervision of individuals, who have received:

(i) A college degree at the bachelor level, or equivalent training and experience, in the physical or biological sciences or in engineering; and

(ii) At least forty hours of training and experience in the safe handling of radioactive material, and in the characteristics of ionizing radiation, units of radiation dose and quantities, radiation detection instrumentation, and biological hazards of exposure to radiation appropriate to the type and forms of radioactive material to be used; and

(c) The applicant has established administrative controls and provisions relating to procurement of radioactive material, procedures, recordkeeping, material control and accounting, and management review necessary to assure safe operations.

(5) *Specific licenses of broad scope are subject to the following conditions:*

(a) Unless specifically authorized by the department, persons licensed pursuant to this section shall not:

(i) Conduct tracer studies in the environment involving direct release of radioactive material;

(ii) Receive, acquire, own, possess, use or transfer devices containing 100,000 curies or more of radioactive material in sealed sources used for irradiation of materials;

(iii) Conduct activities for which a specific license issued by the department under WAC 246-235-080 or 246-235-100 is required; or

(iv) Add or cause the addition of radioactive material to any food, beverage, cosmetic, drug or other product designed for ingestion or inhalation by, or application to, a human being.

(b) Each Type A specific license of broad scope issued under this part shall be subject to the condition that radioactive material possessed under the license may only be used by, or under the direct supervision of, individuals approved by the licensee's radiation safety committee.

(c) Each Type B specific license of broad scope issued under this part shall be subject to the condition that radioactive material possessed under the license may only be used by, or under the direct supervision of, individuals approved by the licensee's radiation safety officer.

(d) Each Type C specific license of broad scope issued under this part shall be subject to the condition that radioactive material possessed under the license may only be used by, or under the direct supervision of, individuals who satisfy the requirements of subsection (4) of this section.

[Statutory Authority: RCW 70.98.050 and 70.98.080. 91-15-112 (Order 184), § 246-235-090, filed 7/24/91, effective 8/24/91. Statutory Authority: RCW 43.70.040. 91-02-049 (Order 121), recodified as § 246-235-090, filed 12/27/90, effective 1/31/91. Statutory Authority: RCW 70.98.080. 79-12-073 (Order 1459), § 402-22-090, filed 11/30/79, effective 1/1/80. Formerly WAC 402-20-073.]

**WAC 246-235-100 Special requirements for a specific license to manufacture, assemble, repair, or distribute commodities, products, or devices which contain radioactive material.** (1) *Licensing the introduction of radioactive material into products in exempt concentrations.*

In addition to the requirements set forth in WAC 246-235-020, a specific license authorizing the introduction of radioactive material into a product or material owned by or in the possession of the licensee or another to be transferred to persons exempt under WAC 246-232-010 (2)(a) will be issued if:

(a) The applicant submits a description of the product or material into which the radioactive material will be introduced, intended use of the radioactive material and the product or material into which it is introduced, method of introduction, initial concentration of the radioactive material in the product or material, control methods to assure that no more than the specified concentration is introduced into the product or material, estimated time interval between introduction and transfer of the product or material, and estimated concentration of the radioactive material in the product or material at the time of transfer; and

(b) The applicant provides reasonable assurance that the concentrations of radioactive material at the time of transfer will not exceed the concentrations in WAC 246-232-130, Schedule C, that reconstruction of the radioactive material in concentrations exceeding those in WAC 246-232-130, Schedule C, is not likely, that use of lower concentrations is not feasible, and that the product or material is not likely to be incorporated in any food, beverage, cosmetic, drug or

other commodity or product designed for ingestion or inhalation by, or application to a human being.

(c) Each person licensed under subsection (1) of this section shall file an annual report with the department which shall identify the type and quantity of each product or material into which radioactive material has been introduced during the reporting period; name and address of the person who owned or possessed the product and material, into which radioactive material has been introduced, at the time of introduction; the type and quantity of radionuclide introduced into each such product or material; and the initial concentrations of the radionuclide in the product or material at time of transfer of the radioactive material by the licensee. If no transfers of radioactive material have been made pursuant to subsection (1) of this section during the reporting period, the report shall so indicate. The report shall cover the year ending June 30, and shall be filed within thirty days thereafter.

(2) *Licensing the distribution of radioactive material in exempt quantities.\**

\*Note: Authority to transfer possession or control by the manufacturer, processor or producer of any equipment, device, commodity or other product containing source material or byproduct material whose subsequent possession, use, transfer and disposal by all other persons who are exempted from regulatory requirements may be obtained only from the United States Nuclear Regulatory Commission, Washington, D.C. 20555.

(a) An application for a specific license to distribute naturally occurring and accelerator-produced radioactive material (NARM) to persons exempted from these regulations pursuant to WAC 246-232-010 (2)(b) will be approved if:

(i) The radioactive material is not contained in any food, beverage, cosmetic, drug or other commodity designed for ingestion or inhalation by, or application to, a human being;

(ii) The radioactive material is in the form of processed chemical elements, compounds, or mixtures, tissue samples, bioassay samples, counting standards, plated or encapsulated sources, or similar substances, identified as radioactive and to be used for its radioactive properties, but is not incorporated into any manufactured or assembled commodity, product, or device intended for commercial distribution; and

(iii) The applicant submits copies of prototype labels and brochures and the department approves such labels and brochures.

(b) The license issued under paragraph (2)(a) of this section is subject to the following conditions:

(i) No more than ten exempt quantities shall be sold or transferred in any single transaction. However, an exempt quantity may be composed of fractional parts of one or more of the exempt quantity provided the sum of the fractions shall not exceed unity.

(ii) Each exempt quantity shall be separately and individually packaged. No more than ten such packaged exempt quantities shall be contained in any outer package for transfer to persons exempt pursuant to WAC 246-232-010 (2)(b). The outer package shall be such that the dose rate at the external surface of the package does not exceed 0.5 millirem per hour.

(iii) The immediate container of each quantity or separately packaged fractional quantity of radioactive material shall bear a durable, legible label which:

(A) Identifies the radionuclide and the quantity of radioactivity; and

(B) Bears the words "radioactive material."

(iv) In addition to the labeling information required by item (2)(b)(iii) of this section, the label affixed to the immediate container, or an accompanying brochure, shall:

(A) State that the contents are exempt from licensing state requirements;

(B) Bear the words "Radioactive material—Not for human use—Introduction into foods, beverages, cosmetics, drugs, or medicinals, or into products manufactured for commercial distribution is prohibited—Exempt quantities should not be combined"; and

(C) Set forth appropriate additional radiation safety precautions and instructions relating to the handling, use, storage and disposal of the radioactive material.

(c) Each person licensed under paragraph (2)(a) of this section shall maintain records identifying, by name and address, each person to whom radioactive material is transferred for use under WAC 246-232-010 (2)(b) or the equivalent regulations of a licensing state, and stating the kinds and quantities of radioactive material transferred. An annual summary report stating the total quantity of each radionuclide transferred under the specific license shall be filed with the department. Each report shall cover the year ending June 30, and shall be filed within thirty days thereafter. If no transfers of radioactive material have been made pursuant to subsection (2) of this section during the reporting period, the report shall so indicate.

(3) *Licensing the incorporation of naturally occurring and accelerator-produced radioactive material into gas and aerosol detectors.* An application for a specific license authorizing the incorporation of NARM into gas and aerosol detectors to be distributed to persons exempt under WAC 246-232-010 (2)(c)(iii) will be approved if the application satisfies requirements equivalent to those contained in Section 32.26 of 10 CFR Part 32.

(4) *Licensing the manufacture and distribution of devices to person generally licensed under WAC 246-233-020(4).*

(a) An application for a specific license to manufacture or distribute devices containing radioactive material, excluding special nuclear material, to persons generally licensed under WAC 246-233-020(4) or equivalent regulations of the United States Nuclear Regulatory Commission, an agreement state or a licensing state will be approved if:

(i) The applicant satisfies the general requirements of WAC 246-235-020;

(ii) The applicant submits sufficient information relating to the design, manufacture, prototype testing, quality control, labels, proposed uses, installation, servicing, leak testing, operating and safety instructions, and potential hazards of the device to provide reasonable assurance that:

(A) The device can be safely operated by persons not having training in radiological protection;

(B) Under ordinary conditions of handling, storage and use of the device, the radioactive material contained in the device will not be released or inadvertently removed from the device, and it is unlikely that any person will receive in any period of one calendar quarter a dose in excess of ten percent of the limits specified in the table in WAC 246-221-010(1); and

(C) Under accident conditions (such as fire and explosion) associated with handling, storage and use of the device, it is unlikely that any person would receive an external radiation dose or dose commitment in excess of the following organ doses:

- Whole body; head and trunk; active blood-forming organs; gonads; or lens of eye 15 rems
- Hands and forearms; feet and ankles; localized areas of skin averaged over areas no larger than one square centimeter 200 rems
- Other organs 50 rems

(iii) Each device bears a durable, legible, clearly visible label or labels approved by the department, which contain in a clearly identified and separate statement:

(A) Instructions and precautions necessary to assure safe installation, operation and servicing of the device (documents such as operating and service manuals may be identified in the label and used to provide this information);

(B) The requirement, or lack of requirement, for leak testing, or for testing any on-off mechanism and indicator, including the maximum time interval for such testing, and the identification of radioactive material by isotope, quantity of radioactivity, and date of determination of the quantity; and

(C) The information called for in one of the following statements, as appropriate, in the same or substantially similar form:

(aa) The receipt, possession, use and transfer of this device, Model . . . . ., Serial No. . . . . Note\*, are subject to a general license or the equivalent, and the regulations of the United States Nuclear Regulatory Commission or a state with which the United States Nuclear Regulatory Commission has entered into an agreement for the exercise of regulatory authority. This label shall be maintained on the device in a legible condition. Removal of this label is prohibited.

CAUTION - RADIOACTIVE MATERIAL

.....  
(Name of manufacturer or distributor)\*

(bb) The receipt, possession, use and transfer of this device, Model . . . . ., Serial No. . . . . Note\*, are subject to a general license or the equivalent, and the regulations of a licensing state. This label shall be maintained on the device in a legible condition. Removal of this label is prohibited.

CAUTION - RADIOACTIVE MATERIAL

.....  
(Name of manufacturer or distributor)\*

\*Note: The model, serial number, and name of the manufacturer or distributor may be omitted from this label provided the information is elsewhere specified in labeling affixed to the device.

(b) In the event the applicant desires that the device be required to be tested at intervals longer than six months, either for proper operation of the on-off mechanism and

indicator, if any, or for leakage of radioactive material or for both, the applicant shall include in the application sufficient information to demonstrate that such longer interval is justified by performance characteristics of the device or similar devices and by design features which have a significant bearing on the probability or consequences of leakage of radioactive material from the device or failure of the on-off mechanism and indicator. In determining the acceptable interval for the test for leakage of radioactive material, the department will consider information which includes, but is not limited to:

- (i) Primary containment (source capsule);
- (ii) Protection of primary containment;
- (iii) Method of sealing containment;
- (iv) Containment construction materials;
- (v) Form of contained radioactive material;
- (vi) Maximum temperature withstood during prototype tests;
- (vii) Maximum pressure withstood during prototype tests;
- (viii) Maximum quantity of contained radioactive material;
- (ix) Radiotoxicity of contained radioactive material;
- (x) Operating experience with identical devices or similarly designed and constructed devices.

(c) In the event the applicant desires that the general licensee under WAC 246-233-020(4), or under equivalent regulations of the United States Nuclear Regulatory Commission, an agreement state or a licensing state be authorized to install the device, collect the sample to be analyzed by a specific licensee for leakage of radioactive material, service the device, test the on-off mechanism and indicator, or remove the device from installation, the applicant shall include in the application written instructions to be followed by the general licensee, estimated calendar quarter doses associated with such activity or activities, and bases for such estimates. The submitted information shall demonstrate that performance of such activity or activities by an individual untrained in radiological protection, in addition to other handling, storage, and use of devices under the general license, is unlikely to cause that individual to receive a calendar quarter dose in excess of ten percent of the limits specified in the table in WAC 246-221-010(1).

(d) Each person licensed under paragraph (4)(a) of this section to distribute devices to generally licensed persons shall:

(i) Furnish a copy of the general license contained in WAC 246-233-020(4) to each person to whom the person directly or through an intermediate person transfers radioactive material in a device for use pursuant to the general license contained in WAC 246-233-020(4);

(ii) Furnish a copy of the general license contained in the United States Nuclear Regulatory Commission's, agreement state's, or licensing state's regulation equivalent to WAC 246-233-020(4), or alternatively, furnish a copy of the general license contained in WAC 246-233-020(4) to each person to whom, directly or through an intermediate person, is transferred radioactive material in a device for use pursuant to the general license of the United States Nuclear Regulatory Commission, the agreement state or the licensing state. If a copy of the general license in WAC 246-233-020(4) is furnished to such a person, it shall be accompanied

by a note explaining that the use of the device is regulated by the United States Nuclear Regulatory Commission, agreement state or licensing state under requirements substantially the same as those in WAC 246-233-020(4);

(iii) Report to the department all transfers of such devices to persons for use under the general license in WAC 246-233-020(4). Such report shall identify each general licensee by name and address, an individual by name and/or position who may constitute a point of contact between the department and the general licensee, the type and model number of device transferred, and the quantity and type of radioactive material contained in the device. If one or more intermediate persons will temporarily possess the device at the intended place of use prior to its possession by the user, the report shall include identification of each intermediate person by name, address, contact, and relationship to the intended user. If no transfers have been made to persons generally licensed under WAC 246-233-020(4) during the reporting period, the report shall so indicate. The report shall cover each calendar quarter and shall be filed within thirty days thereafter.

(iv) Reports to other departments.

(A) Report to the United States Nuclear Regulatory Commission all transfers of such devices to persons for use under the United States Nuclear Regulatory Commission general license in Section 31.5 of 10 CFR Part 31.

(B) Report to the responsible department all transfers of devices manufactured and distributed pursuant to subsection (4) of this section for use under a general license in that state's regulations equivalent to WAC 246-233-020(4).

(C) Such reports shall identify each general licensee by name and address, an individual by name and/or position who may constitute a point of contact between the department and the general licensee, the type and model of the device transferred, and the quantity and type of radioactive material contained in the device. If one or more intermediate persons will temporarily possess the device at the intended place of use prior to its possession by the user, the report shall include identification of each intermediate person by name, address, contact, and relationship to the intended user. The report shall be submitted within thirty days after the end of each calendar quarter in which such a device is transferred to the generally licensed person.

(D) If no transfers have been made to United States Nuclear Regulatory Commission licensees during the reporting period, this information shall be reported to the United States Nuclear Regulatory Commission.

(E) If no transfers have been made to general licensees within a particular state during the reporting period, this information shall be reported to the responsible department upon request of the department.

(v) Keep records showing the name, address and the point of contact for each general licensee to whom the person directly or through an intermediate person transfers radioactive material in devices for use pursuant to the general license provided in WAC 246-233-020(4), or equivalent regulations of the United States Nuclear Regulatory Commission, an agreement state or a licensing state. The records shall show the date of each transfer, the radionuclide and the quantity of radioactivity in each device transferred, the identity of any intermediate person, and compliance with the report requirements of paragraph (4)(d) of this section.

(5) *Special requirements for the manufacture, assembly or repair of luminous safety devices for use in aircraft.* An application for a specific license to manufacture, assemble or repair luminous safety devices containing tritium or promethium-147 for use in aircraft for distribution to persons generally licensed under WAC 246-233-020(5) will be approved subject to the following conditions:

(a) The applicant satisfies the general requirements specified in WAC 246-235-020; and

(b) The applicant satisfies the requirements of Sections 32.53, 32.54, 32.55, 32.56, 32.101 of 10 CFR Part 32 or their equivalent.

(6) *Special requirements for license to manufacture calibration sources containing americium-241, plutonium or radium-226 for distribution to persons generally licensed under WAC 246-233-020(7).* An application for a specific license to manufacture calibration and reference sources containing americium-241, plutonium or radium-226 to persons generally licensed under WAC 246-233-020(7) will be approved subject to the following conditions:

(a) The applicant satisfies the general requirement of WAC 246-235-020; and

(b) The applicant satisfies the requirements of Sections 32.57, 32.58, 32.59, 32.102 of 10 CFR Part 32 and Section 70.39 of 10 CFR Part 70 or their equivalent.

(7) *Manufacture and distribution of radioactive material for certain in vitro clinical or laboratory testing under general license.* An application for a specific license to manufacture or distribute radioactive material for use under the general license of WAC 246-233-020(8) will be approved if:

(a) The applicant satisfies the general requirements specified in WAC 246-235-020;

(b) The radioactive material is to be prepared for distribution in prepackaged units of:

(i) Iodine-125 in units not exceeding 10 microcuries each;

(ii) Iodine-131 in units not exceeding 10 microcuries each;

(iii) Carbon-14 in units not exceeding 10 microcuries each;

(iv) Hydrogen-3 (tritium) in units not exceeding 50 microcuries each;

(v) Iron-59 in units not exceeding 20 microcuries each;

(vi) Cobalt-57 in units not exceeding 10 microcuries each;

(vii) Selenium-75 in units not exceeding 10 microcuries each;

(viii) Mock Iodine-125 in units not exceeding 0.05 microcurie of iodine-129 and 0.005 microcurie of americium-241 each.

(c) Each prepackaged unit bears a durable, clearly visible label:

(i) Identifying the radioactive contents as to chemical form and radionuclide, and indicating that the amount of radioactivity does not exceed 10 microcuries of iodine-125, iodine-131, carbon-14, cobalt-57, or selenium-75; 50 microcuries of hydrogen-3 (tritium); 20 microcuries of iron-59; or Mock Iodine-125 in units not exceeding 0.05 microcurie of iodine-129 and 0.005 microcurie of americium-241 each; and

(ii) Displaying the radiation caution symbol described in WAC 246-221-120 (1)(a) and the words, "CAUTION, RADIOACTIVE MATERIAL," and "Not for internal or external use in humans or animals."

(d) One of the following statements, as appropriate, or a substantially similar statement which contains the information called for in one of the following statements, appears on a label affixed to each prepackaged unit or appears in a leaflet or brochure which accompanies the package:

(i) This radioactive material may be received, acquired, possessed and used only by physicians, veterinarians, clinical laboratories or hospitals and only for *in vitro* clinical or laboratory tests not involving internal or external administration of the material, or the radiation therefrom, to human beings or animals. Its receipt, acquisition, possession, use and transfer are subject to the regulations and a general license of the United States Nuclear Regulatory Commission or of a state with which the commission has entered into an agreement for the exercise of regulatory authority.

.....  
Name of manufacturer

(ii) This radioactive material may be received, acquired, possessed and used only by physicians, veterinarians, clinical laboratories or hospitals and only for *in vitro* clinical or laboratory tests not involving internal or external administration of the material, or the radiation therefrom, to human beings or animals. Its receipt, acquisition, possession, use and transfer are subject to the regulations and a general license of a licensing state.

.....  
Name of manufacturer

(e) The label affixed to the unit, or the leaflet or brochure which accompanies the package, contains adequate information as to the precautions to be observed in handling and storing such radioactive material. In the case of the Mock Iodine-125 reference or calibration source, the information accompanying the source must also contain directions to the licensee regarding the waste disposal requirements set out in WAC 246-221-170 of these regulations.

(8) *Licensing the manufacture and distribution of ice detection devices.* An application for a specific license to manufacture and distribute ice detection devices to persons generally licensed under WAC 246-233-020(9) will be approved subject to the following conditions:

(a) The applicant satisfies the general requirements of WAC 246-235-020; and

(b) The criteria of Sections 32.61, 32.62, 32.103 of 10 CFR Part 32 are met.

(9) *Manufacture and distribution of radiopharmaceuticals containing radioactive material for medical use under group licenses.* An application for a specific license to manufacture and distribute radiopharmaceuticals containing radioactive material for use by persons licensed pursuant to WAC 246-235-080(3) for the uses listed in Group I, Group II, Group IV, or Group V of WAC 246-235-120, Schedule A, will be approved if:

(a) The applicant satisfies the general requirements specified in WAC 246-235-020 of this part;

(b) The applicant submits evidence that:

(i) The radiopharmaceutical containing radioactive material will be manufactured, labeled and packaged in accordance with the Federal Food, Drug and Cosmetic Act or the Public Health Service Act, such as a new drug application (NDA) approved by the United States Food and Drug Administration (FDA), a biologic product license issued by FDA or a "notice of claimed investigational exemption for a new drug" (IND) that has been accepted by the FDA; or

(ii) The manufacture, compounding and distribution of the radiopharmaceutical containing radioactive material is not subject to the Federal Food, Drug and Cosmetic Act and the Public Health Service Act;

(c) The applicant submits information on the radionuclide, chemical and physical form, packaging including maximum activity per package, and shielding provided by the packaging of the radioactive material which is appropriate for safe handling and storage of radiopharmaceuticals by group licensees; and

(d) The label affixed to each package of the radiopharmaceutical contains information on the radionuclide, quantity and date of assay, and the label affixed to each package, or the leaflet or brochure which accompanies each package, contains a statement that the radiopharmaceutical is licensed by the department for distribution to persons licensed pursuant to WAC 246-235-080(3) and 246-235-120 Schedule A, Group I, Group II, Group IV, and Group V, as appropriate, or under equivalent regulations of the United States Nuclear Regulatory Commission, an agreement state or a licensing state. The labels, leaflets or brochures required by subsection (9) of this section are in addition to the labeling required by the Food and Drug Administration (FDA) and they may be separate from or, with the approval of FDA, may be combined with the labeling required by FDA.

(10) *Manufacture and distribution of generators or reagent kits for preparation of radiopharmaceuticals containing radioactive material.* An application for a specific license to manufacture and distribute generators or reagent kits containing radioactive material for preparation of radiopharmaceuticals by persons licensed pursuant to WAC 246-235-080(3) for the uses listed in Group III of WAC 246-235-120, Schedule A will be approved if:

(a) The applicant satisfies the general requirements specified in WAC 246-235-020;

(b) The applicant submits evidence that:

(i) The generator or reagent kit is to be manufactured, labeled and packaged in accordance with the Federal Food, Drug and Cosmetic Act or the Public Health Service Act, such as a new drug application (NDA) approved by the Food and Drug Administration (FDA), a biologic product license issued by FDA, or a "Notice of claimed investigational exemption for a new drug" (IND) that has been accepted by the FDA; or

(ii) The manufacture and distribution of the generator or reagent kit are not subject to the Federal Food, Drug and Cosmetic Act and the Public Health Service Act;

(c) The applicant submits information on the radionuclide, chemical and physical form, packaging including maximum activity per package, and shielding provided by

the packaging of the radioactive material contained in the generator or reagent kit;

(d) The label affixed to the generator or reagent kit contains information on the radionuclide, quantity, and date of assay; and

(e) The label affixed to the generator or reagent kit, or the leaflet or brochure which accompanies the generator or reagent kit; contains:

(i) Adequate information, from a radiation safety standpoint, on the procedures to be followed and the equipment and shielding to be used in eluting the generator or processing radioactive material with the reagent kit; and

(ii) A statement that this generator or reagent kit (as appropriate) is approved for use by persons licensed by the department pursuant to WAC 246-235-080(3) and Group III of WAC 246-235-120, Schedule A, or under equivalent regulations of the United States Nuclear Regulatory Commission, an agreement state or a licensing state. The labels, leaflets or brochures required by subsection (10) of this section are in addition to the labeling required by FDA and they may be separate from or, with the approval of FDA, may be combined with the labeling required by FDA.

Note: Although the department does not regulate the manufacture and distribution of reagent kits that do not contain radioactive material, it does regulate the use of such reagent kits for the preparation of radiopharmaceuticals containing radioactive material as part of its licensing and regulation of the users of radioactive material. Any manufacturer of reagent kits that do not contain radioactive material who desires to have reagent kits approved by the department for use by persons licensed pursuant to WAC 246-235-080(3) and Group III of WAC 246-235-120 Schedule A may submit the pertinent information specified in subsection (10) of this section.

(11) *Manufacture and distribution of sources or devices containing radioactive material for medical use.* An application for a specific license to manufacture and distribute sources and devices containing radioactive material to persons licensed pursuant to WAC 246-235-080(3) for use as a calibration or reference source or for the uses listed in Group VI of WAC 246-235-120 Schedule A of this part will be approved if:

(a) The applicant satisfies the general requirements in WAC 246-235-020 of this part;

(b) The applicant submits sufficient information regarding each type of source or device pertinent to an evaluation of its radiation safety, including:

(i) The radioactive material contained, its chemical and physical form and amount;

(ii) Details of design and construction of the source or device;

(iii) Procedures for, and results of, prototype tests to demonstrate that the source or device will maintain its integrity under stresses likely to be encountered in normal use and accidents;

(iv) For devices containing radioactive material, the radiation profile of a prototype device;

(v) Details of quality control procedures to assure that production sources and devices meet the standards of the design and prototype tests;

(vi) Procedures and standards for calibrating sources and devices;

(vii) Legend and methods for labeling sources and devices as to their radioactive content; and

(viii) Instructions for handling and storing the source or device from the radiation safety standpoint, these instructions are to be included on a durable label attached to the source or device or attached to a permanent storage container for the source or device: *Provided*, That instructions which are too lengthy for such label may be summarized on the label and printed in detail on a brochure which is referenced on the label.

(c) The label affixed to the source or device, or to the permanent storage container for the source or device, contains information on the radionuclide, quantity and date of assay, and a statement that the named source or device is licensed by the department for distribution to persons licensed pursuant to WAC 246-235-080(3) and Group VI of WAC 246-235-120 Schedule A or under equivalent regulations of the United States Nuclear Regulatory Commission, an agreement state or a licensing state: *Provided*, That such labeling for sources which do not require long term storage (e.g., gold-198 seeds) may be on a leaflet or brochure which accompanies the source.

(d) In the event the applicant desires that the source or device be required to be tested for leakage of radioactive material at intervals longer than six months, the applicant shall include in the application sufficient information to demonstrate that such longer interval is justified by performance characteristics of the source or device or similar sources or devices and by design features that have a significant bearing on the probability or consequences of leakage of radioactive material from the source.

(e) In determining the acceptable interval for test of leakage of radioactive material, the department will consider information that includes, but is not limited to:

(i) Primary containment (source capsule);

(ii) Protection of primary containment;

(iii) Method of sealing containment;

(iv) Containment construction materials;

(v) Form of contained radioactive material;

(vi) Maximum temperature withstood during prototype tests;

(vii) Maximum pressure withstood during prototype tests;

(viii) Maximum quantity of contained radioactive material;

(ix) Radiotoxicity of contained radioactive material; and

(x) Operating experience with identical sources or devices or similarly designed and constructed sources or devices.

(12) *Requirements for license to manufacture and distribute industrial products containing depleted uranium for mass-volume applications.*

(a) An application for a specific license to manufacture industrial products and devices containing depleted uranium for use pursuant to WAC 246-233-010(4) or equivalent regulations of the United States Nuclear Regulatory Commission or an agreement state will be approved if:

(i) The applicant satisfies the general requirements specified in WAC 246-235-020;

(ii) The applicant submits sufficient information relating to the design, manufacture, prototype testing, quality control procedures, labeling or marking, proposed uses and potential hazards of the industrial product or device to provide reasonable assurance that possession, use or transfer of the



depleted uranium in the product or device is not likely to cause any individual to receive in any period of one calendar quarter a radiation dose in excess of ten percent of the limits specified in WAC 246-221-010(1); and

(iii) The applicant submits sufficient information regarding the industrial product or device and the presence of depleted uranium for a mass-volume application in the product or device to provide reasonable assurance that unique benefits will accrue to the public because of the usefulness of the product or device.

(b) In the case of an industrial product or device whose unique benefits are questionable, the department will approve an application for a specific license under subsection (12) of this section only if the product or device is found to combine a high degree of utility and low probability of uncontrolled disposal and dispersal of significant quantities of depleted uranium into the environment.

(c) The department may deny any application for a specific license under subsection (12) of this section if the end use(s) of the industrial product or device cannot be reasonably foreseen.

(d) Each person licensed pursuant to paragraph (12)(a) of this section shall:

(i) Maintain the level of quality control required by the license in the manufacture of the industrial product or device, and in the installation of the depleted uranium into the product or device;

(ii) Label or mark each unit to:

(A) Identify the manufacturer of the product or device and the number of the license under which the product or device was manufactured, the fact that the product or device contains depleted uranium, and the quantity of depleted uranium in each product or device; and

(B) State that the receipt, possession, use and transfer of the product or device are subject to a general license or the equivalent and the regulations of the United States Nuclear Regulatory Commission or of an agreement state;

(iii) Assure that the depleted uranium before being installed in each product or device has been impressed with the following legend clearly legible through any plating or other covering: "Depleted uranium";

(iv) Furnish to each person to whom depleted uranium in a product or device is transferred for use pursuant to the general license contained in WAC 246-233-010(4) or its equivalent:

(A) A copy of the general license contained in WAC 246-233-010(4) and a copy of department Form RHF-20; or

(B) A copy of the general license contained in the United States Nuclear Regulatory Commission's or agreement state's regulation equivalent to WAC 246-233-010(4) and a copy of the United States Nuclear Regulatory Commission's or agreement state's certificate, or alternatively, furnish a copy of the general license contained in WAC 246-233-010(4) and a copy of department Form RHF-20 with a note explaining that use of the product or device is regulated by the United States Nuclear Regulatory Commission or an agreement state under requirements substantially the same as those in WAC 246-233-010(4).

(v) Report to the department all transfers of industrial products or devices to persons for use under the general license in WAC 246-233-010(4). Such report shall identify each general licensee by name and address, an individual by

name and/or position who may constitute a point of contact between the department and the general licensee, the type and model number of device transferred, and the quantity of depleted uranium contained in the product or device. The report shall be submitted within thirty days after the end of each calendar quarter in which such a product or device is transferred to the generally licensed person. If no transfers have been made to persons generally licensed under chapter 246-233 WAC during the reporting period, the report shall so indicate;

(vi) Provide certain other reports as follows:

(A) Report to the United States Nuclear Regulatory Commission all transfers of industrial products or devices to persons for use under the United States Nuclear Regulatory Commission general license in Section 40.25 of 10 CFR Part 40;

(B) Report to the responsible department all transfers of devices manufactured and distributed pursuant to subsection (12) of this section for use under a general license in that state's regulations equivalent to WAC 246-233-010(4);

(C) Such report shall identify each general licensee by name and address, an individual by name and/or position who may constitute a point of contact between the department and the general licensee, the type and model number of the device transferred, and the quantity of depleted uranium contained in the product or device. The report shall be submitted within thirty days after the end of each calendar quarter in which such product or device is transferred to the generally licensed person;

(D) If no transfers have been made to United States Nuclear Regulatory Commission licensees during the reporting period, this information shall be reported to the United States Nuclear Regulatory Commission;

(E) If no transfers have been made to general licensees within a particular agreement state during the reporting period, this information shall be reported to the responsible department; and

(vii) Keep records showing the name, address and point of contact for each general licensee to whom the person transfers depleted uranium in industrial products or devices for use pursuant to the general license provided in WAC 246-233-010(4) or equivalent regulations of the United States Nuclear Regulatory Commission or of an agreement state. The records shall be maintained for a period of two years and shall show the date of each transfer, the quantity of depleted uranium in each product or device transferred, and compliance with the report requirements of this section.

[Statutory Authority: RCW 70.98.050 and 70.98.080. 91-15-112 (Order 184), § 246-235-100, filed 7/24/91, effective 8/24/91. Statutory Authority: RCW 43.70.040. 91-02-049 (Order 121), recodified as § 246-235-100, filed 12/27/90, effective 1/31/91. Statutory Authority: RCW 70.98.050. 81-01-011 (Order 1570), § 402-22-110, filed 12/8/80. Statutory Authority: RCW 70.98.080. 79-12-073 (Order 1459), § 402-22-110, filed 11/30/79, effective 1/1/80. Formerly WAC 402-20-076.]

**WAC 246-235-110 Special requirements for issuance of specific licenses for source material milling.** In addition to the requirements set forth in WAC 246-235-020, a specific license for source material milling will be issued if the applicant submits to the department a satisfactory application as described herein and meets the other conditions specified below:



(1) An application for a license to receive title to, receive, possess, and use source material for milling or byproduct material as defined in WAC 246-220-010 shall address the following:

- (a) Description of the proposed project or action.
- (b) Area/site characteristics including geology, demography, topography, hydrology and meteorology.
- (c) Radiological and nonradiological impacts of the proposed project or action, including waterway and ground-water impacts.
- (d) Environmental effects of accidents.
- (e) Tailings disposal and decommissioning.
- (f) Site and project alternatives.
- (g) Description of how the provisions of chapter 246-252 WAC shall be met.

(2) Pursuant to WAC 246-235-080(6)(a)(i) the applicant shall not commence construction of the project until the department has weighed the environmental, economic, technical, and other benefits against the environmental costs and has concluded that the issuance of the license is appropriate.

(3) Prior to issuance of a license, a public hearing shall be held. The scope shall extend to the question of license issuance and the adequacy of the reclamation, disposal, decommissioning, and decontamination plans.

(4) At least one full year prior to any major site construction, a preoperational monitoring program shall be conducted to provide complete baseline data on a milling site and its environs. Throughout the construction and operating phases of the mill, an operational monitoring program shall be conducted to measure or evaluate compliance with applicable standards and regulations; to evaluate performance of control systems and procedures; to evaluate environmental impacts of operation; and to detect potential long-term effects.

(5) Prior to issuance of the license, the mill operator shall establish financial surety arrangements consistent with the requirements of WAC 246-252-030.

(6) The applicant shall provide procedures describing the means employed to meet the following requirements during the operational phase of any project.

(a) Milling operations shall be conducted so that all effluent releases are reduced to as low as is reasonably achievable below the limits of chapter 246-221 WAC.

(b) The mill operator shall conduct at least daily inspection of any tailings or waste retention systems. Records of such inspections shall be maintained for review by the department.

(c) The mill operator shall immediately notify the department of the following:

(i) Any failure in a tailings or waste retention system which results in a release of tailings or waste into unrestricted areas; and

(ii) Any unusual conditions (conditions not contemplated in the design of the retention system) which if not corrected could lead to failure of the system and result in a release of tailings or waste into unrestricted areas.

(7) An application for a license to own, receive, possess and use byproduct material as defined in WAC 246-220-010 shall contain proposed specifications relating to the emissions control and disposition of the byproduct material to

achieve the requirements and objectives set forth in the criteria listed in WAC 246-252-030.

[Statutory Authority: RCW 70.98.050 and 70.98.080. 91-15-112 (Order 184), § 246-235-110, filed 7/24/91, effective 8/24/91. Statutory Authority: RCW 43.70.040. 91-02-049 (Order 121), recodified as § 246-235-110, filed 12/27/90, effective 1/31/91. Statutory Authority: RCW 70.98.080. 87-01-031 (Order 2450), § 402-22-150, filed 12/11/86. Statutory Authority: Chapter 70.121 RCW. 81-16-031 (Order 1683), § 402-22-150, filed 7/28/81.]

**WAC 246-235-120 Schedule A groups of medical uses of radioactive material (ref. WAC 246-235-080(3) and 246-235-100(9)).** (1) *Group I.* Use of prepared radiopharmaceuticals for certain diagnostic studies involving measurements of uptake, dilution and excretion. This group does not include imaging or localization studies.

(a) Any radioactive material in a radiopharmaceutical and for a diagnostic use involving measurements of uptake, dilution or excretion for which a "Notice of claimed investigational exemption for a new drug" (IND) has been accepted by the Food and Drug Administration (FDA) or for which a "New drug application" (NDA) is in effect.

(b) The provisions of (a) of this subsection notwithstanding, no radioactive material in gaseous form or for use as an aerosol is permitted by this subsection except as specifically authorized in a license.

(2) *Group II.* Use of prepared radiopharmaceuticals for diagnostic imaging and localization studies.

(a) Any radioactive material in a radiopharmaceutical and for a diagnostic use involving imaging or localizing for which a "Notice of claimed investigational exemption for a new drug" (IND) has been accepted by the Food and Drug Administration (FDA) or for which a "New drug application" (NDA) is in effect;

(b) The provisions of (a) of this subsection notwithstanding, no radioactive material in gaseous form or for use as an aerosol is permitted by this subsection except as specifically authorized by a license or subsection (3)(b) of this section.

(3) *Group III.* Use of generators and reagent kits for the preparation and use of radiopharmaceuticals containing radioactive material for diagnostic imaging and localization studies.

(a) Any generator or reagent kit for preparation and diagnostic use of a radiopharmaceutical containing radioactive material for which generator or reagent kit a "Notice of claimed investigational exemption of a new drug" (IND) has been accepted by the Food and Drug Administration (FDA) or for which a "New drug application" (NDA) is in effect.

(b) The provisions of (a) of this subsection notwithstanding, no generator or reagent kit is authorized for preparation of any gaseous form or aerosol of a radioactive material, except Technetium-99m as sodium pentetate as an aerosol for pulmonary function studies when used only with an approved and shielded delivery system, and disposed in accordance with applicable requirements, or as specifically authorized in a license.

(4) *Group IV.* Use of prepared radiopharmaceuticals for certain therapeutic uses that do not normally require hospitalization for purposes of radiation safety.

(a) Iodine-131 as iodide for treatment of hyperthyroidism and cardiac dysfunction;

(b) Phosphorus-32 as soluble phosphate for treatment of polycythemia vera, leukemia and bone metastases;

(c) Phosphorus-32 as colloidal chromic phosphate for intracavitary treatment of malignant effusions;

(d) Any radioactive material in a radiopharmaceutical and for a therapeutic use not normally requiring hospitalization for purposes of radiation safety for which a "Notice of claimed investigational exemption for a new drug" (IND) has been accepted by the Food and Drug Administration (FDA) or for which a "New drug application" (NDA) is in effect.

(5) *Group V.* Use of prepared radiopharmaceuticals for certain therapeutic uses that normally require hospitalization for purposes of radiation safety.

(a) Gold-198 as colloid for intracavitary treatment of malignant effusions;

(b) Iodine-131 as iodide for treatment of thyroid carcinoma;

(c) Any radioactive material in a radiopharmaceutical and for a therapeutic use normally requiring hospitalization for radiation safety reasons for which a "Notice of claimed investigational exemption for a new drug" (IND) has been accepted by the Food and Drug Administration (FDA) or for which a "New drug application" (NDA) is in effect.

(6) *Group VI.* Use of sources and devices containing radioactive material for certain medical uses.

(a) Americium-241 as a sealed source in a device for bone mineral analysis;

(b) Cesium-137 encased in needles and applicator cells for topical, interstitial, and intracavitary treatment of cancer;

(c) Cobalt-60 encased in needles and applicator cells for topical, interstitial, and intracavitary treatment of cancer;

(d) Gold-198 as seeds for interstitial treatment of cancer;

(e) Iodine-125 as a sealed source in a device for bone mineral analysis;

(f) Gadolinium-153 as a sealed source in a device for bone mineral analysis;

(g) Iridium-192 as seeds encased in nylon ribbon for interstitial treatment of cancer;

(h) Strontium-90 sealed in an applicator for treatment of superficial eye conditions; and

(i) Iodine-125 as seeds for interstitial treatment of cancer.

[Statutory Authority: RCW 70.98.050 and 70.98.080. 91-15-112 (Order 184), § 246-235-120, filed 7/24/91, effective 8/24/91. Statutory Authority: RCW 43.70.040. 91-02-049 (Order 121), recodified as § 246-235-120, filed 12/27/90, effective 1/31/91. Statutory Authority: RCW 70.98.080. 87-01-031 (Order 2450), § 402-22-200, filed 12/11/86. Statutory Authority: RCW 70.98.050. 81-01-011 (Order 1570), § 402-22-200, filed 12/8/80. Statutory Authority: RCW 70.98.080. 79-12-073 (Order 1459), § 402-22-200, filed 11/30/79, effective 1/1/80. Formerly WAC 402-20-260.]

**WAC 246-235-130 Appendix—General laboratory rules for safe use of unsealed sources.** (1) In addition to the requirements set forth in WAC 246-235-020, a specific licensee who uses unsealed, unplated and/or liquid sources shall possess adequate facilities including ventilation systems which are compatible with the proposed uses: and,

(2) Possess, use, and store, radioactive materials in accordance with, but not limited to, the following:

(a) Receive, handle, and store radioactive materials only at specifically designated locations within the applicant's

facility. Vessels containing radioactive material must be labeled as required by chapter 246-221 WAC.

(b) Wear disposable gloves at all times when handling dispersible radioactive material or potentially contaminated items.

(c) Wear personnel monitoring devices (film badge and/or TLD), when required, at all times when working with, or in the vicinity of, radioactive materials. Extremity doses shall be considered in evaluating the need for separate extremity dosimeters. Extremity dosimetry should be worn when working with millicurie or greater quantities of material (excluding low energy beta emitters and pure alpha emitters). Monitoring devices, when not in use, shall be stored only in a designated low-background area. Calculations based on whole body badge results for photon emitters may be used in lieu of separate extremity dosimeters.

(d) Use remote tools, lead shields, lead-glass shields, and/or plexiglass shields as appropriate.

(e) Prohibit eating, chewing, drinking, smoking, and application of cosmetics in any area where radioactive material is used or stored.

(f) Do not store food, drink or personal effects in any area, container, or refrigerator designated for radioactive materials use or storage.

(g) Do not pipette radioactive materials or perform any similar operation by employing mouth suction.

(h) Use disposable absorbent material with impervious backing to cover work surfaces where spillage is possible.

(i) Properly dress and protect open wounds on exposed body surfaces before working with radioactive materials.

(j) Wear laboratory coats when working with radioactive material. Potentially contaminated laboratory coats shall not be worn outside the immediate work area.

(k) Nuclides in gaseous or volatile form, or with a high potential for volatilization shall be used only in areas with adequate ventilation systems.

[Statutory Authority: RCW 70.98.050. 94-01-073, § 246-235-130, filed 12/9/93, effective 1/9/94. Statutory Authority: RCW 70.98.050 and 70.98.080. 91-15-112 (Order 184), § 246-235-130, filed 7/24/91, effective 8/24/91. Statutory Authority: RCW 43.70.040. 91-02-049 (Order 121), recodified as § 246-235-130, filed 12/27/90, effective 1/31/91. Statutory Authority: RCW 70.98.080. 87-01-031 (Order 2450), § 402-22-240, filed 12/11/86; 83-19-050 (Order 2026), § 402-22-240, filed 9/16/83.]

**WAC 246-235-140 Schedule B, limits for broad licenses.** (See also WAC 246-235-090)

Radioactive Material	Col. I curies	Col. II curies
Antimony-122	1	0.01
Antimony-124	1	0.01
Antimony-125	1	0.01
Arsenic-73	10	0.1
Arsenic-74	1	0.01
Arsenic-76	1	0.01
Arsenic-77	10	0.1
Barium-131	10	0.1
Barium-140	1	0.01
Beryllium-7	10	0.1
Bismuth-210	0.1	0.001
Bromine-82	10	0.1
Cadmium-109	1	0.01
Cadmium-115m	1	0.01
Cadmium-115	10	0.1
Calcium-45	1	0.01
Calcium-47	10	0.1

## Radioactive Materials—Specific Licenses

246-235-140

Carbon-14	100	1.	Palladium-109	10	0.1
Cerium-141	10	0.1	Phosphorus-32	1	0.01
Cerium-143	10	0.1	Platinum-191	10	0.1
Cerium-144	0.1	0.001	Platinum-193m	100	1.
Cesium-131	100	1.	Platinum-193	10	0.1
Cesium-134m	100	1.	Platinum-197m	100	1.
Cesium-134	0.1	0.001	Platinum-197	10	0.1
Cesium-135	1	0.01	Polonium-210	0.01	0.0001
Cesium-136	10	0.1	Potassium-42	1	0.01
Cesium-137	0.1	0.001	Praseodymium-142	10	0.1
Chlorine-36	1	0.01	Praseodymium-143	10	0.1
Chlorine-38	100	1.	Promethium-147	1	0.01
Chromium-51	100	1.	Promethium-149	10	0.1
Cobalt-57	10	0.1	Radium-226	0.01	0.0001
Cobalt-58m	100	1.	Rhenium-186	10	0.1
Cobalt-58	1	0.01	Rhenium-188	10	0.1
Cobalt-60	0.1	0.001	Rhodium-103m	1,000	10.
Copper-64	10	0.1	Rhodium-105	10	0.1
Dysprosium-165	100	1.	Rubidium-86	1	0.01
Dysprosium-166	10	0.1	Rubidium-87	1	0.01
Erbium-169	10	0.1	Ruthenium-97	100	1.
Erbium-171	10	0.1	Ruthenium-103	1	0.01
Europium-152 (9.2h)	10	0.1	Ruthenium-105	10	0.1
Europium-152 (13 y)	0.1	0.001	Ruthenium-106	0.1	0.001
Europium-154	0.1	0.001	Samarium-151	1	0.01
Europium-155	1	0.01	Samarium-153	10	0.1
Fluorine-18	100	1.	Scandium-46	1	0.01
Gadolinium-153	1	0.01	Scandium-47	10	0.1
Gadolinium-159	10	0.1	Scandium-48	1	0.01
Gallium-72	10	0.1	Selenium-75	1	0.01
Germanium-71	100	1.	Silicon-31	10	0.1
Gold-198	10	0.1	Silver-105	1	0.01
Gold-199	10	0.1	Silver-110m	0.1	0.001
Hafnium-181	1	0.01	Silver-111	10	0.1
Holmium-166	10	0.1	Sodium-22	0.1	0.001
Hydrogen-3	100	1.	Sodium-24	1	0.01
Indium-113m	100	1.	Strontium-85m	1,000	10.
Indium-114m	1	0.01	Strontium-85	1	0.01
Indium-115m	100	1.	Strontium-89	1	0.01
Indium-115	1	0.01	Strontium-90	0.01	0.0001
Iodine-125	0.1	0.001	Strontium-91	10	0.1
Iodine-126	0.1	0.001	Strontium-92	10	0.1
Iodine-129	0.1	0.001	Sulphur-35	10	0.1
Iodine-131	0.1	0.001	Tantalum-182	1	0.01
Iodine-132	10	0.1	Technetium-96	10	0.1
Iodine-133	1	0.01	Technetium-97m	10	0.1
Iodine-134	10	0.1	Technetium-97	10	0.1
Iodine-135	1	0.01	Technetium-99m	100	1.
Iridium-192	1	0.01	Technetium-99	1	0.01
Iridium-194	10	0.1	Tellurium-125m	1	0.01
Iron-55	10	0.1	Tellurium-127m	1	0.01
Iron-59	1	0.01	Tellurium-127	10	0.1
Krypton-85	100	1.	Tellurium-129m	1	0.01
Krypton-87	10	0.1	Tellurium-129	100	1.
Lanthanum-140	1	0.01	Tellurium-131m	10	0.1
Lutetium-177	10	0.1	Tellurium-132	1	0.01
Manganese-52	1	0.01	Terbium-160	1	0.01
Manganese-54	1	0.01	Thallium-200	10	0.1
Manganese-56	10	0.1	Thallium-201	10	0.1
Mercury-197m	10	0.1	Thallium-202	10	0.1
Mercury-197	10	0.1	Thallium-204	1	0.01
Mercury-203	1	0.01	Thulium-170	1	0.01
Molybdenum-99	10	0.1	Thulium-171	1	0.01
Neodymium-147	10	0.1	Tin-113	1	0.01
Neodymium-149	10	0.1	Tin-125	1	0.01
Nickel-59	10	0.1	Tungsten-181	1	0.01
Nickel-63	1	0.01	Tungsten-185	1	0.01
Nickel-65	10	0.1	Tungsten-187	10	0.1
Niobium-93m	1	0.01	Vanadium-48	1	0.01
Niobium-95	1	0.01	Xenon-131m	1,000	10.
Niobium-97	100	1.	Xenon-133	100	1.
Osmium-185	1	0.01	Xenon-135	100	1.
Osmium-191m	100	1.	Ytterbium-175	10	0.1
Osmium-191	10	0.1	Yttrium-90	1	0.01
Osmium-193	10	0.1	Yttrium-91	1	0.01
Palladium-103	10	0.1	Yttrium-92	10	0.1

(1997 Ed.)

[Title 246 WAC—page 289]

Yttrium-93	1	0.01	Hydrogen-3	.5	20,000
Zinc-65	1	0.01	Iodine-125	.5	10
Zinc-69m	10	0.1	Iodine-131	.5	10
Zinc-69	100	1.	Indium-114m	.01	1,000
Zirconium-93	1	0.01	Iridium-192	.001	40,000
Zirconium-95	1	0.01	Iron-55	.01	40,000
Zirconium-97	1	0.01	Iron-59	.01	7,000
Any radioactive material other than source material, special nuclear material, or alpha emitting radioactive material not listed above.	0.1	0.001	Krypton-85	1.0	6,000,000
			Lead-210	.01	8
			Manganese-56	.01	60,000
			Mercury-203	.01	10,000
			Molybdenum-99	.01	30,000
			Neptunium-237	.001	2
			Nickel-63	.01	20,000
			Niobium-94	.01	300
			Phosphorus-32	.5	100
			Phosphorus-33	.5	1,000
			Polonium-210	.01	10
			Potassium-42	.01	9,000
			Promethium-145	.01	4,000
			Promethium-147	.01	4,000
			Ruthenium-106	.01	200
			Samarium-151	.01	4,000
			Scandium-46	.01	3,000
			Selenium-75	.01	10,000
			Silver-110m	.01	1,000
			Sodium-22	.01	9,000
			Sodium-24	.01	10,000
			Strontium-89	.01	3,000
			Strontium-90	.01	90
			Sulfur-35	.5	900
			Technetium-99	.01	10,000
			Technetium-99m	.01	400,000
			Tellurium-127m	.01	5,000
			Tellurium-129m	.01	5,000
			Terbium-160	.01	4,000
			Thulium-170	.01	4,000
			Tin-113	.01	10,000
			Tin-123	.01	3,000
			Tin-126	.01	1,000
			Titanium-44	.01	100
			Uranium Hexafluoride	.001	Note <sup>4</sup>
			Vanadium-48	.01	7,000
			Xenon-133	1.0	900,000
			Yttrium-91	.01	2,000
			Zinc-65	.01	5,000
			Zirconium-93	.01	400
			Zirconium-95	.01	5,000
			Any other beta-gamma emitter	.01	10,000
			Mixed fission products	.01	1,000
			Mixed corrosion products	.01	10,000
			Contaminated equipment beta-gamma	.001	10,000
			Irradiated material, any form other than solid noncombustible	.01	1,000
			Irradiated material, solid noncombustible	.001	10,000
			Mixed radioactive waste, beta-gamma	.01	1,000
			Packaged mixed waste, beta-gamma <sup>5</sup>	.001	10,000

[Statutory Authority: RCW 70.98.050 and 70.98.080. 91-15-112 (Order 184), § 246-235-140, filed 7/24/91, effective 8/24/91. Statutory Authority: RCW 43.70.040. 91-02-049 (Order 121), recodified as § 246-235-140, filed 12/27/90, effective 1/31/91. Statutory Authority: RCW 70.98.080. 79-12-073 (Order 1459), § 402-22-250, filed 11/30/79, effective 1/1/80. Formerly WAC 402-20-270.]

**WAC 246-235-150 Schedule C—Quantities of radioactive materials requiring consideration of the need for an emergency plan for responding to a release.**

Radioactive material <sup>1</sup>	Release fraction	Possession limit (curies)			
Actinium-228	0.001	4,000	Sodium-22	.01	9,000
Americium-241	.001	2	Sodium-24	.01	10,000
Americium-242	.001	2	Strontium-89	.01	3,000
Americium-243	.001	2	Strontium-90	.01	90
Antimony-124	.01	4,000	Sulfur-35	.5	900
Antimony-126	.01	6,000	Technetium-99	.01	10,000
Barium-133	.01	10,000	Technetium-99m	.01	400,000
Barium-140	.01	30,000	Tellurium-127m	.01	5,000
Bismuth-207	.01	5,000	Tellurium-129m	.01	5,000
Bismuth-210	.01	600	Terbium-160	.01	4,000
Cadmium-109	.01	1,000	Thulium-170	.01	4,000
Cadmium-113	.01	80	Tin-113	.01	10,000
Calcium-45	.01	20,000	Tin-123	.01	3,000
Californium-252 <sup>2</sup>	.001	9	Tin-126	.01	1,000
Carbon-14 <sup>3</sup>	.01	50,000	Titanium-44	.01	100
Cerium-141	.01	10,000	Uranium Hexafluoride	.001	Note <sup>4</sup>
Cerium-144	.01	300	Vanadium-48	.01	7,000
Cesium-134	.01	2,000	Xenon-133	1.0	900,000
Cesium-137	.01	3,000	Yttrium-91	.01	2,000
Chlorine-36	.5	100	Zinc-65	.01	5,000
Chromium-51	.01	300,000	Zirconium-93	.01	400
Cobalt-60	.001	5,000	Zirconium-95	.01	5,000
Copper-64	.01	200,000	Any other beta-gamma emitter	.01	10,000
Curium-242	.001	60	Mixed fission products	.01	1,000
Curium-243	.001	3	Mixed corrosion products	.01	10,000
Curium-244	.001	4	Contaminated equipment beta-gamma	.001	10,000
Curium-245	.001	2	Irradiated material, any form other than solid noncombustible	.01	1,000
Europium-152	.01	500	Irradiated material, solid noncombustible	.001	10,000
Europium-154	.01	400	Mixed radioactive waste, beta-gamma	.01	1,000
Europium-155	.01	3,000	Packaged mixed waste, beta-gamma <sup>5</sup>	.001	10,000
Germanium-68	.01	2,000			
Gadolinium-153	.01	5,000			
Gold-198	.01	30,000			
Hafnium-172	.01	400			
Hafnium-181	.01	7,000			
Holmium-166m	.01	100			

Any other alpha emitter	.001	2
Contaminated equipment, alpha	.0001	20
Packaged waste, alpha <sup>5</sup>	.0001	20
Combinations of radioactive materials listed above <sup>1</sup>		

- <sup>1</sup> For combinations of radioactive materials, consideration of the need for an emergency plan is required if the sum of the ratios of the quantity of each radioactive material authorized to the quantity listed for that material in Schedule C exceeds one.
- <sup>2</sup> For Californium-252, the quantity may also be expressed as 20 milligrams.
- <sup>3</sup> Excludes Carbon-14 as carbon dioxide.
- <sup>4</sup> For uranium hexafluoride, the quantity is 50 kilograms in a single container or 1,000 kilograms total.
- <sup>5</sup> Waste packaged in Type B containers does not require an emergency plan.

[Statutory Authority: RCW 70.98.050, 95-01-108, § 246-235-150, filed 12/21/94, effective 1/21/95.]

### Chapter 246-239 WAC RADIATION PROTECTION—NUCLEAR MEDICINE

#### WAC

246-239-001	Purpose and scope.
246-239-010	Definitions.
246-239-020	Radiation safety committee.
246-239-022	Policy and procedures for radiopharmaceutical administration.
246-239-025	Notifications, records, and reports of radiopharmaceutical misadministrations.
246-239-030	Personnel monitoring.
246-239-035	Bioassay.
246-239-040	Radiopharmaceuticals.
246-239-050	Radionuclide generators.
246-239-060	Laboratory safety.
246-239-070	Surveys.
246-239-080	Calibration and reference sources.
246-239-090	Instrumentation.
246-239-100	Radioactive gases.

**WAC 246-239-001 Purpose and scope.** The provisions of this chapter apply to all licensees utilizing radioactive materials in the practice of nuclear medicine and establish radiation safety requirements for those licensees. These provisions are in addition to, and not in substitution for, other applicable provisions of these regulations.

[Statutory Authority: RCW 43.70.040, 91-02-049 (Order 121), recodified as § 246-239-001, filed 12/27/90, effective 1/31/91. Statutory Authority: RCW 70.98.080, 83-19-050 (Order 2026), § 402-34-010, filed 9/16/83.]

**WAC 246-239-010 Definitions.** (1) "Diagnostic clinical procedures manual" means a collection of written procedures that describes each method (and other instructions and precautions) by which the licensee performs diagnostic clinical procedures; where each diagnostic clinical procedure has been approved by the authorized user and includes the radiopharmaceutical, dosage, and route of administration.

(2) "Nuclear medicine" means the intentional internal or external administration of unsealed radioactive material to human beings.

(3) "Nuclear medicine technologist" means any individual who performs nuclear medical procedures under the

supervision of a physician licensed pursuant to chapter 246-235 WAC.

(4) "Prescribed dosage" means the quantity of radiopharmaceutical activity as documented:

(a) In a written directive; or

(b) Either in the diagnostic clinical procedures manual or in any appropriate record in accordance with the directions of the authorized user for diagnostic procedures.

(5) "Radiopharmaceutical misadministration" means the administration of:

(a) A radiopharmaceutical dosage greater than 30 microcuries of sodium iodide I-125 or I-131:

(i) Involving the wrong patient or wrong radiopharmaceutical; or

(ii) When both the administered dosage differs from the prescribed dosage by more than twenty percent of the prescribed dosage, and the difference between the administered dosage and prescribed dosage exceeds 30 microcuries;

(b) A therapeutic radiopharmaceutical dosage, other than sodium iodide I-125 or I-131:

(i) Involving the wrong patient, wrong radiopharmaceutical, or wrong route of administration; or

(ii) When the administered dosage differs from the prescribed dosage by more than twenty percent of the prescribed dosage;

(c) A diagnostic radiopharmaceutical dosage, other than quantities greater than 30 microcuries of sodium iodide I-125 or I-131, both:

(i) Involving the wrong patient, wrong radiopharmaceutical, wrong route of administration, or when the administered dosage differs from the prescribed dosage; and

(ii) When the dose to the patient exceeds 5 rems effective dose equivalent or 50 rems dose equivalent to any individual organ.

(6) "Training" means instruction or experience acquired under the direct supervision of a physician, a certified/registered nuclear medicine technologist, and/or a qualified expert who has the necessary knowledge and training to advise personnel on radiation protection.

(7) "Written directive" means an order in writing for a specific patient, dated and signed by an authorized user prior to the administration of a radiopharmaceutical, containing the following information:

(a) For any administration of quantities greater than 30 microcuries of sodium iodide I-125 or I-131: The dosage;

(b) For a therapeutic administration of a radiopharmaceutical other than sodium iodide I-125 or I-131: The radiopharmaceutical, dosage, and route of administration.

[Statutory Authority: RCW 70.98.050 and 70.98.080, 92-06-008 (Order 245), § 246-239-010, filed 2/21/92, effective 3/23/92; 91-15-112 (Order 184), § 246-239-010, filed 7/24/91, effective 8/24/91. Statutory Authority: RCW 43.70.040, 91-02-049 (Order 121), recodified as § 246-239-010, filed 12/27/90, effective 1/31/91. Statutory Authority: RCW 70.98.080, 83-19-050 (Order 2026), § 402-34-030, filed 9/16/83.]

**WAC 246-239-020 Radiation safety committee.** (1) Where required by license condition or pursuant to WAC 246-235-080(1), the radiation safety committee, shall meet at least once every calendar quarter. Such meetings shall be documented by written minutes and those minutes shall be maintained for inspection by the department for at least two years.

(2) Evaluation of the adequacy of the licensee's radiation safety program for radiation safety, for adherence to the policy and procedures for radiopharmaceutical administration program, and adherence to the ALARA concept shall be conducted at least once each calendar year with an interval of no more than five calendar quarters between each evaluation. Such evaluations may be performed by the radiation safety officer, a competent outside agent, or by qualified personnel at the licensee's own facility. These evaluations shall be documented, maintained for inspection by the department, and presented in a timely manner to the radiation safety committee for review and approval and, where necessary, recommend timely corrective action to the licensee's management.

[Statutory Authority: RCW 70.98.050. 94-06-017, § 246-239-020, filed 2/22/94, effective 3/25/94. Statutory Authority: RCW 70.98.050 and 70.98.080. 91-15-112 (Order 184), § 246-239-020, filed 7/24/91, effective 8/24/91. Statutory Authority: RCW 43.70.040. 91-02-049 (Order 121), recodified as § 246-239-020, filed 12/27/90, effective 1/31/91. Statutory Authority: RCW 70.98.080. 83-19-050 (Order 2026), § 402-34-050, filed 9/16/83.]

**WAC 246-239-022 Policy and procedures for radiopharmaceutical administration.** (1) Each licensee shall establish and maintain a written program to provide assurance that radioactive material or radiation from radioactive material will be administered as directed by the authorized user ordering the administration. The program must include written policies and procedures to meet the following specific objectives:

(a) That, prior to administration, a written directive is prepared for:

(i) Any administration of quantities greater than 30 microcuries of sodium iodide I-131; or

(ii) Any therapeutic administration of a radiopharmaceutical, other than sodium iodide I-131. A written revision to an existing written directive may be made for any diagnostic or therapeutic procedure provided the revision is dated and signed by the authorized user prior to the administration of the radiopharmaceutical or radiobiologic dosage. If a delay would jeopardize the patient's health, and the authorized user is not personally assaying and administering the dose, an oral directive or revision to an existing written directive will be acceptable, provided the oral revision is documented immediately in the patient's chart or record, and the revised written directive is signed by the authorized user within forty-eight hours of the oral revision;

Note: A written directive is not required when an authorized user personally assays and administers a dosage provided the pertinent facts are documented as otherwise required.

(b) That, prior to each administration, the patient's identity is verified by more than one method as the individual named in the written directive;

(c) That each administration is in accordance with the written directive; and

(d) That any unintended deviation from the written directive is identified and evaluated, and appropriate action is taken.

(2) The licensee shall evaluate and respond, within thirty days after discovery of the recordable event, to each recordable event by:

(a) Assembling the relevant facts including the cause;

(b) Identifying what, if any, corrective action is required to prevent recurrence; and

(c) Retaining a record, in an auditable form, for three years, of the relevant facts and what corrective action, if any, was taken.

(3) The licensee shall retain:

(a) Each written directive (provided, however, that such written directive is not required if the dose is both personally assayed and administered by the authorized user); and

(b) A record of each administered radiation dose or radiopharmaceutical dosage where a written directive is required in subsection (1)(a) of this section, in an auditable form, for three years after the date of administration.

(4) The licensee may make modifications to the program to increase the program's efficiency provided the program's effectiveness is not decreased.

[Statutory Authority: RCW 70.98.050. 94-06-017, § 246-239-022, filed 2/22/94, effective 3/25/94.]

**WAC 246-239-025 Notifications, records, and reports of radiopharmaceutical misadministrations.** (1) The licensee shall notify the department by telephone at (206) 682-5327 no later than the next calendar day after the discovery of a radiopharmaceutical misadministration.

(2) The licensee also shall notify the referring physician and the patient or the patient's responsible relative or guardian (hereinafter referred to as "the patient") of the radiopharmaceutical misadministration not later than twenty-four hours after its discovery, unless the referring physician personally informs the licensee either that the physician will inform the patient or that, based on medical judgment, telling the patient would be harmful. The licensee is not required to notify the patient without first consulting the referring physician. If the referring physician or patient cannot be reached within twenty-four hours, the licensee shall notify the patient as soon as possible thereafter. The licensee may not delay any appropriate medical care for the patient, including any necessary remedial care as a result of the radiopharmaceutical misadministration, because of any delay in notification.

(3) The licensee shall submit a written report to the department within fifteen days after discovery of the radiopharmaceutical misadministration. The written report must include the licensee's name; the prescribing physician's name; a brief description of the event; why the event occurred; the effect on the patient; what improvements are needed to prevent recurrence; actions taken to prevent recurrence; whether the licensee notified the patient, and if not, why not, and if the patient was notified, what information was provided to the patient. The report shall not include the patient's name or other identifying information.

(4) If the patient was notified, the licensee shall also furnish, within fifteen days after discovery of the radiopharmaceutical misadministration, a written report to the patient by sending either:

(a) A copy of the report that was submitted to the department; or

(b) A brief description of both the radiopharmaceutical misadministration and the consequences, as they may affect the patient, and a statement informing the patient that the

report submitted to the department can be obtained from the licensee.

(5) Each licensee shall retain a record of each radiopharmaceutical misadministration for five years. The record shall contain the names of all individuals involved (including the physician, allied health personnel, the patient, and the patient's referring physician), the patient's Social Security number or identification number if one has been assigned, a brief description of the radiopharmaceutical misadministration, why it occurred, the effect on the patient, what improvements are needed to prevent recurrence, and the actions taken to prevent recurrence.

(6) Aside from the notification requirement, nothing in this section affects any rights or duties of licensees and physicians in relation to each other, patients, or the patient's responsible relatives or guardians.

[Statutory Authority: RCW 70.98.050 and 70.98.080. 92-06-008 (Order 245), § 246-239-025, filed 2/21/92, effective 3/23/92.]

**WAC 246-239-030 Personnel monitoring.** In addition to the requirements of WAC 246-221-090 and the conditions of the license, extremity monitoring (such as TLD ring badges) shall be provided and used on a monthly exchange basis for those personnel who routinely inject radiopharmaceuticals and/or elute Tc 99<sup>m</sup>/Mo 99 generators.

[Statutory Authority: RCW 70.98.050. 94-06-017, § 246-239-030, filed 2/22/94, effective 3/25/94. Statutory Authority: RCW 70.98.050 and 70.98.080. 91-15-112 (Order 184), § 246-239-030, filed 7/24/91, effective 8/24/91. Statutory Authority: RCW 43.70.040. 91-02-049 (Order 121), recodified as § 246-239-030, filed 12/27/90, effective 1/31/91. Statutory Authority: RCW 70.98.080. 83-19-050 (Order 2026), § 402-34-090, filed 9/16/83.]

**WAC 246-239-035 Bioassay.** Each licensee who uses Iodine 131 for diagnostic or therapeutic purposes shall conduct a radioiodine bioassay program in accordance with the criteria set forth in Washington State Regulatory Guide 8.20, "Bioassay Program Criteria for I-125 and I-131." When radioiodine capsules are used exclusively, bioassay is required only when capsules are opened, breached, or crushed.

[Statutory Authority: RCW 70.98.050. 94-06-017, § 246-239-035, filed 2/22/94, effective 3/25/94.]

**WAC 246-239-040 Radiopharmaceuticals.** (1) Radioactive material to be administered to humans shall be the subject of an FDA-approved "new drug application" (NDA) or an FDA-accepted "notice of claimed investigational exemption for a new drug" (IND), unless otherwise stated in the license.

(2) Any licensee using radioactive material for clinical procedures other than those specified in the product labeling (package insert) shall comply with the product labeling regarding:

- (a) Chemical and physical form;
- (b) Route of administration; and
- (c) Dosage range.

(3) No licensee shall receive, possess, or use radioactive material as a radiopharmaceutical except when it has been:

(a) Manufactured in the form to be administered to the patient, and labeled, packaged, and distributed, in accordance with a specific license; or

(b) Prepared from reagent kits and/or radionuclide generators approved in accordance with WAC 246-235-080 (3)(b) and 246-235-100(10).

(4) The provisions of this part notwithstanding:

(a) No radioactive material in gaseous form or for use as an aerosol is permitted except Technetium-99m pentetate used as an aerosol for lung function studies, or as specifically authorized by license condition. Radioactive aerosols must be administered with a closed, shielded system that either is vented to the outside atmosphere through an air exhaust or provides for collection and disposal of the aerosol; and

(b) No generator or reagent kit is authorized for preparation of any gaseous form or aerosol of the radioactive material, except as specifically authorized by license condition.

(5) Radioactive material to be administered to humans shall be assayed for activity to determine the dose within ten percent accuracy of the prescribed dose prior to being administered to patients.

(a) In the absence of a certificate from a supplier which specifies the activity of each dose, the license shall establish written procedures for the personnel to perform assays to an accuracy of ten percent of the prescribed dose prior to being administered to patients.

(b) The licensee shall maintain for inspection by the department, records of the results of each assay performed to determine the activity of each dose administered to a patient. Records shall be maintained for two years following performance of each assay.

[Statutory Authority: RCW 70.98.050 and 70.98.080. 91-15-112 (Order 184), § 246-239-040, filed 7/24/91, effective 8/24/91. Statutory Authority: RCW 43.70.040. 91-02-049 (Order 121), recodified as § 246-239-040, filed 12/27/90, effective 1/31/91. Statutory Authority: RCW 70.98.080. 83-19-050 (Order 2026), § 402-34-100, filed 9/16/83.]

**WAC 246-239-050 Radionuclide generators.** (1) Any licensee who uses generators and reagent kits shall elute the generator or process radioactive material with the reagent kit in accordance with instructions which are approved by the department, the United States Nuclear Regulatory Commission, an agreement state, or a licensing state, and are furnished by the manufacturer on the label attached to, or in the leaflet or brochure, which accompanies the generator or reagent kit.

(2) Tc-99m separated from Molybdenum 99 either by elution of a Molybdenum 99/Tc-99m generator or by an extraction process shall be tested to detect, and quantify Molybdenum 99 activity prior to administration to patients. The licensee shall not administer to patients Tc-99m containing more than 0.15 microcurie (5550 becquerels) of Molybdenum 99 per mCi (37 megabecquerels) of Tc-99m. The limits for Molybdenum 99 contamination represent maximum values and Molybdenum 99 contamination should be kept as low as reasonably achievable below these limits.

(a) In the absence of a certificate from the supplier of Tc-99m which specifies the quantity of Molybdenum 99, the licensee shall establish written procedures for personnel performing tests to detect and quantify Molybdenum 99 contamination. These procedures shall include all necessary calculations and steps to be taken if activities of Molybdenum 99 in excess of the limits specified in this part are detected.



(b) Personnel performing tests to detect and quantify Molybdenum 99 contamination shall be given specific training in performing these tests prior to conducting such tests.

(c) The licensee shall maintain for inspection by the department, records of the results of each test performed to detect and quantify Molybdenum 99 contamination and records of training given to personnel performing these tests. Records shall be maintained for two years following the performance of each test and the training of personnel.

[Statutory Authority: RCW 70.98.050. 94-06-017, § 246-239-050, filed 2/22/94, effective 3/25/94. Statutory Authority: RCW 43.70.040. 91-02-049 (Order 121), recodified as § 246-239-050, filed 12/27/90, effective 1/31/91. Statutory Authority: RCW 70.98.080. 83-19-050 (Order 2026), § 402-34-120, filed 9/16/83.]

**WAC 246-239-060 Laboratory safety.** In addition to those requirements found in WAC 246-235-130, the licensee shall utilize syringe shields or other shielding devices for all manipulations. Syringe shields should be used for injections whenever practicable.

[Statutory Authority: RCW 70.98.050 and 70.98.080. 91-15-112 (Order 184), § 246-239-060, filed 7/24/91, effective 8/24/91. Statutory Authority: RCW 43.70.040. 91-02-049 (Order 121), recodified as § 246-239-060, filed 12/27/90, effective 1/31/91. Statutory Authority: RCW 70.98.080. 87-01-031 (Order 2450), § 402-34-140, filed 12/11/86; 83-19-050 (Order 2026), § 402-34-140, filed 9/16/83.]

**WAC 246-239-070 Surveys.** In addition to applicable requirements found elsewhere in these regulations, and the license, each licensee shall:

(1) Monitor hands and clothing for contamination after each procedure, or before leaving the work area;

(2) Survey the laboratory preparation and injection areas for contamination after each procedure, or at the end of the day using instrumentation capable of measuring nanocurie or becquerel amounts of activity. Survey documentation shall include an area diagram or a description of the area or article and the instrumentation used, the background levels in CPM, CPS, DPS, or DPM, the date of the survey, and the initials or name of the surveyor. Such documentation shall be maintained for inspection by the department for two years.

[Statutory Authority: RCW 70.98.050. 94-06-017, § 246-239-070, filed 2/22/94, effective 3/25/94. Statutory Authority: RCW 43.70.040. 91-02-049 (Order 121), recodified as § 246-239-070, filed 12/27/90, effective 1/31/91. Statutory Authority: RCW 70.98.080. 83-19-050 (Order 2026), § 402-34-150, filed 9/16/83.]

**WAC 246-239-080 Calibration and reference sources.** (1) Any licensee who owns, receives, acquires, possesses, uses, or transfers calibration reference sources pursuant to the general license authorized in WAC 246-233-020(7) shall:

(a) Maintain a file or log identifying such sources, including nuclide, activity, model and serial numbers, manufacturer, date of receipt, date of transfer, and to whom transferred (where applicable);

(b) Possess at any one time, and at any one location of storage or use, no more than five uCi (0.185 megabecquerels) of Am-241 and five uCi (0.185 megabecquerels) of Pu and five uCi (0.185 megabecquerels) of Ra-226 in such sources;

(c) Store such source(s), except when the source(s) is being used, in a closed container adequately designed and constructed to contain Americium-241, Plutonium, or Radium 226 which might otherwise escape during storage; and

(d) Not use such source(s) for any purpose other than the calibration of radiation detectors or the standardization of other sources.

(2) Any licensee who receives, possesses, or uses calibration and reference standards pursuant to the group licensing provisions of WAC 246-235-080 (3)(c):

(a) Shall conduct leak tests in accordance with WAC 246-235-080 (3)(d);

(b) Shall follow the radiation safety and handling instructions approved by the department, the United States Nuclear Regulatory Commission, and agreement state or a licensing state and furnished by the manufacturer on the label attached to the source, or permanent container thereof, or in the leaflet or brochure that accompanies the source, and maintain such instruction in a legible and conveniently available form; and

(c) Shall conduct a quarterly physical inventory to account for all sources received and possessed. Records of the inventory shall be maintained for inspection by the department, and shall include, but not be limited to, the quantities and kinds of radioactive material, the serial number of each source, location of sources, the initials or name of the person performing the inventory, and the date of inventory.

(3) Any licensee authorized for medical Group I, II, or III is also authorized to receive, use, possess, store, transfer and/or dispose of sealed sources containing Cobalt-57 in amounts not exceeding 22 millicuries (814 megabecquerels) per source which are designed, intended, and used solely for required imaging system or dose calibrator quality assurance tests.

[Statutory Authority: RCW 70.98.050. 94-06-017, § 246-239-080, filed 2/22/94, effective 3/25/94. Statutory Authority: RCW 70.98.050 and 70.98.080. 91-15-112 (Order 184), § 246-239-080, filed 7/24/91, effective 8/24/91. Statutory Authority: RCW 43.70.040. 91-02-049 (Order 121), recodified as § 246-239-080, filed 12/27/90, effective 1/31/91. Statutory Authority: RCW 70.98.080. 83-19-050 (Order 2026), § 402-34-170, filed 9/16/83.]

**WAC 246-239-090 Instrumentation.** (1) Instrumentation used to conduct surveys shall be appropriate for the nuclide(s) and radiation levels present.

(2) Portable and stationary survey instruments shall be calibrated at least annually, with intervals not to exceed five calendar quarters, and after any repair. Calibrations shall be done using either the licensee's procedures approved by the department or by a facility specifically licensed to perform the appropriate dose rate or contamination instrument calibrations. Records shall be maintained for inspection by the department.

(3) An operational check utilizing an appropriate check source shall be conducted daily when instruments are used.

(4) Imaging systems shall have a flood performed daily when the system is used. In addition, mobile nuclear medicine services employing imaging systems which are moved from one facility to another shall perform a flood prior to use at each location. Bar phantoms shall be per-

formed weekly. Records of such quality assurance for imaging systems, shall be maintained for inspection by the departments.

(5) Appropriate source(s) for calibration and standardization of dose calibrators shall be used. Dose calibrators shall receive:

- (a) Daily constancy checks;
- (b) Quarterly linearity tests;

(c) Annual tests for accuracy; accuracy test results which show a variation greater than ten percent from the expected or calculated value shall cause the instrument to be repaired and recalibrated prior to use for assay of patient doses; and

(d) Geometry tests upon installation and following major repair.

(6) The licensee is responsible for proper and timely performance of required quality assurance procedures and tests.

[Statutory Authority: RCW 70.98.050. 94-06-017, § 246-239-090, filed 2/22/94, effective 3/25/94. Statutory Authority: RCW 70.98.050 and 70.98.080. 91-15-112 (Order 184), § 246-239-090, filed 7/24/91, effective 8/24/91. Statutory Authority: RCW 43.70.040. 91-02-049 (Order 121), recodified as § 246-239-090, filed 12/27/90, effective 1/31/91. Statutory Authority: RCW 70.98.080. 83-19-050 (Order 2026), § 402-34-190, filed 9/16/83.]

**WAC 246-239-100 Radioactive gases.** (1) Licensees utilizing radioactive gases, such as Xenon-133 or Krypton-81m, shall have and use a ventilation system adequate for such use, including an approved trap. Radioactive gas shall be disposed only as specifically authorized by the license.

(2) Licensees utilizing radioactive gases shall maintain emissions in accordance with limits specified in chapters 246-221 and 246-247 WAC. Verification shall be documented. Such verification may be made by calculation, air samples, or the use of constant monitoring instrumentation.

(3) Licensees utilizing radioactive gas without benefit of negative air pressure in the use area shall utilize an approved and shielded delivery system and trap. Such traps shall be tested for trapping efficiency at intervals not to exceed those recommended by the trap manufacturer and replaced as recommended by the manufacturer.

[Statutory Authority: RCW 70.98.050. 94-06-017, § 246-239-100, filed 2/22/94, effective 3/25/94. Statutory Authority: RCW 70.98.050 and 70.98.080. 91-15-112 (Order 184), § 246-239-100, filed 7/24/91, effective 8/24/91. Statutory Authority: RCW 43.70.040. 91-02-049 (Order 121), recodified as § 246-239-100, filed 12/27/90, effective 1/31/91. Statutory Authority: RCW 70.98.080. 87-01-031 (Order 2450), § 402-34-210, filed 12/11/86; 83-19-050 (Order 2026), § 402-34-210, filed 9/16/83.]

## Chapter 246-240 WAC

### RADIATION PROTECTION—MEDICAL THERAPY

#### WAC

246-240-001	Scope.
246-240-010	Definitions.
246-240-015	Policy and procedures for therapy administration.
246-240-020	Interstitial, intracavitary and superficial applications.
246-240-030	Teletherapy.
246-240-040	Special requirements for teletherapy licensees.
246-240-050	Notifications, records, and reports of therapy misadministrations.

**WAC 246-240-001 Scope.** The provisions of this chapter apply to all licensees who use sealed sources in the healing arts and are in addition to, and not in substitution for, other applicable provisions of these regulations.

[Statutory Authority: RCW 43.70.040. 91-02-049 (Order 121), recodified as § 246-240-001, filed 12/27/90, effective 1/31/91; Order 1084, § 402-32-010, filed 1/14/76; Order 1, § 402-32-010, filed 1/8/69; Rules (part), filed 10/26/66.]

**WAC 246-240-010 Definitions.** As used in this chapter, the following definitions apply:

(1) "Brachytherapy" means a method of radiation therapy in which sealed sources are utilized to deliver a radiation dose at a distance of up to a few centimeters, by surface, intracavitary, or interstitial application.

(2) "Prescribed dose" means:

(a) For gamma stereotactic radiosurgery, the total dose as documented in the written directive;

(b) For teletherapy, the total dose and dose per fraction as documented in the written directive; or

(c) For brachytherapy, either the total source strength and exposure time, or the total dose, as documented in the written directive.

(3) "Teletherapy" means therapeutic irradiation in which the source of radiation is at a distance from the body.

(4) "Therapy misadministration" means the administration of:

(a) A gamma stereotactic radiosurgery radiation dose;

(i) Involving the wrong patient or wrong treatment site; or

(ii) When the calculated total administered dose differs from the total prescribed dose by more than ten percent of the total prescribed dose;

(b) A teletherapy radiation dose:

(i) Involving the wrong patient, wrong mode of treatment, or wrong treatment site;

(ii) When the treatment consists of three or fewer fractions and the calculated total administered dose differs from the total prescribed dose by more than ten percent of the total prescribed dose;

(iii) When the calculated weekly administered dose is thirty percent greater than the weekly prescribed dose; or

(iv) When the calculated total administered dose differs from the total prescribed dose by more than twenty percent of the total prescribed dose;

(c) A brachytherapy radiation dose:

(i) Involving the wrong patient, wrong radioisotope, or wrong treatment site (excluding, for permanent implants, seeds that were implanted in the correct site but migrated outside the treatment site);

(ii) Involving a sealed source that is leaking;

(iii) When, for a temporary implant, one or more sealed sources are not removed upon completion of the procedure; or

(iv) When the calculated administered dose to the treatment site differs from the prescribed dose by more than twenty percent of the prescribed dose.

(5) "Written directive" means an order in writing for a specific patient, dated and signed by an authorized user prior to the administration of radiation, except as specified in (d) of this subsection, containing the following information:

- (a) For gamma stereotactic radiosurgery: Target coordinates, collimator size, plug pattern, and total dose;
- (b) For teletherapy: The total dose, dose per fraction, treatment site, and overall treatment period;
- (c) For high-dose-rate remote after loading brachytherapy: The radioisotope, treatment site, and total dose; or
- (d) For all other brachytherapy, (i) prior to implantation: The radioisotope, number of sources, and source strengths; and (ii) after implantation but prior to completion of the procedure: The radioisotope, treatment site, and total source strength and exposure time (or, equivalently, the total dose).

[Statutory Authority: RCW 70.98.050 and 70.98.080. 92-06-008 (Order 245), § 246-240-010, filed 2/21/92, effective 3/23/92.]

**WAC 246-240-015 Policy and procedures for therapy administration.** (1) Each licensee shall establish and maintain a written program to provide assurance that radioactive material or radiation from radioactive material will be administered as directed by the authorized user. The program must include written policies and procedures to meet the following specific objectives:

(a) That, prior to administration, a written directive is prepared for:

- (i) Any teletherapy radiation dose;
- (ii) Any gamma stereotactic radiosurgery radiation dose;

or

(iii) Any brachytherapy radiation dose. A written revision to an existing written directive may be made for any therapeutic procedure provided the revision is dated and signed by the authorized user prior to the administration of radioactive material or radiation from radioactive material for that therapeutic use. If a delay would jeopardize the patient's health, and the authorized user is not personally present to administer the dose, an oral directive or oral revision to an existing written directive by the authorized user will be acceptable provided the oral directive or oral revision is documented immediately in the patient's chart or record, and the revised written directive is signed by the authorized user within forty-eight hours of the oral revision. Note: A written directive is not required when an authorized user personally assays and administers a dosage, provided the pertinent facts are documented as otherwise required;

(b) That, prior to each administration, the patient's identity is verified by more than one method as the individual named in the written directive;

(c) That final plans of treatment and related calculations for brachytherapy, teletherapy, and gamma stereotactic radiosurgery are in accordance with the respective written directives;

(d) That each administration is in accordance with the written directive; and

(e) That any unintended deviation from the written directive is identified and evaluated, and appropriate action is taken.

(2) The licensee shall evaluate and respond, within thirty days after the discovery of the recordable event, to each recordable event by:

(a) Assembling the relevant facts including the cause;

(b) Identifying what, if any, corrective action is required to prevent recurrence; and

(c) Retaining a record, in an auditable form, for three years, of the relevant facts and what corrective action, if any, was taken.

(3) The licensee shall retain:

(a) Each written directive (provided, however, that such written directive is not required if the dose is both personally assayed and administered by the authorized user); and

(b) A record of each administered radiation dose where a written directive is required in subsection (1)(a) of this section, in an auditable form for three years after the date of the administration.

(4) The licensee may make modifications to the program to increase the program's efficiency provided the program's effectiveness is not decreased.

[Statutory Authority: RCW 70.98.050. 95-01-108, § 246-240-015, filed 12/21/94, effective 1/21/95.]

**WAC 246-240-020 Interstitial, intracavitary and superficial applications.** (1) **Accountability, storage, and handling.**

(a) Except as otherwise specifically authorized by the department, each licensee shall provide accountability of sealed sources and shall keep a record of the issue and return of all sealed sources to their place of storage.

(b) Each licensee shall conduct a quarterly physical inventory to account for all sources and devices received and possessed. Records of the inventories shall be maintained for inspection by the department and shall include the activities, radionuclide(s), and serial numbers of radioactive sources, location of sources and devices, the date of the inventory, and the initials or name of the person performing the inventory.

(c) Each licensee shall follow the radiation safety and handling instructions approved by the department, the United States Nuclear Regulatory Commission, an agreement state or a licensing state and furnished by the manufacturer on the label attached to the source, device or permanent container thereof, or in the leaflet or brochure which accompanies the source or device, and maintain such instruction in a legible and conveniently available form.

(d) Each licensee shall assure that sealed therapy sources are not opened/breached, or physically modified while in the licensee's possession unless specifically authorized by license condition.

(2) **Testing sealed sources for leakage and contamination.**

(a) All sealed sources containing more than 100 microcuries (3.7 megabecquerels) of radioactive material with a half-life greater than thirty days, except Iridium-192 seeds encased in nylon ribbon, shall be tested for contamination and/or leakage at intervals not to exceed six months or at such other intervals as are approved by the department, the United States Nuclear Regulatory Commission, an agreement state or a licensing state and described by the manufacturer on the label attached to the source, device, or permanent container thereof, or in the leaflet or brochure which accompanies the source or device. Each source or device shall be so tested prior to its first use unless the supplier furnishes a certificate that the source or device has been so tested within six months prior to the transfer.

(b) Leak tests shall be capable of detecting the presence of 0.005 microcurie (185 becquerels) of radioactive material on the test sample or in the case of radium, the escape of radon at the rate of 0.001 microcurie (37 becquerels) per twenty-four hours. The test sample shall be taken from the source or from the surfaces of the device in which the source is permanently or semipermanently mounted or stored on which one might expect contamination to accumulate. Records of leak test results shall be kept in units of microcuries or becquerels and maintained for inspection by the department.

(c) Any leak test conducted pursuant to (a) of this subsection which reveals the presence of 0.005 microcurie (185 becquerels) or more of removable contamination or in the case of radium, the escape of radon at the rate of 0.001 microcurie (37 becquerels) per twenty-four hours, shall be considered evidence that the sealed source is leaking. The licensee shall immediately withdraw the source from use and cause it to be decontaminated and repaired or to be disposed of in accordance with department regulations. A report shall be filed within five days of the test with the department, describing the equipment involved, the test results, and the corrective action taken.

### (3) Radiation surveys.

(a) The maximum exposure rate radiation level at a distance of one meter from the patient in whom brachytherapy sources have been inserted shall be determined by measurement or calculation. This radiation level shall be entered on the patient's chart and other signs as required under subsection (4) of this section.

(b) The exposure rate radiation levels in the patient's room and the surrounding area shall be determined, recorded, and maintained for inspection by the department.

(c) The licensee shall assure that patients treated with Cobalt-60, Cesium-137, Iridium-192, Radium-226, or any other nonpermanent implants, including High Dose Rate (HDR), Medium Dose Rate (MDR), or Low Dose Rate (LDR) therapy systems used on an in-patient or out-patient basis, remain hospitalized until a source count and a radiation survey of the patient and the patient's room confirm that all implants have been removed and are accounted for.

(d) Patients administered any therapeutic radiopharmaceutical shall remain hospitalized until the residual activity is 30 millicuries (1110 megabecquerels) or less, OR the measured dose rate from the unshielded patient is less than 5.0 millirem (50 microsieverts) per hour at a distance of one meter.

### (4) Signs and records.

(a) In addition to the requirements of WAC 246-221-120, the bed, cubicle, or room of the hospital brachytherapy patient shall be marked with a sign indicating the presence of brachytherapy sources. This sign shall incorporate the radiation symbol and specify the radionuclide, the activity, date, and the individual(s) to contact for radiation safety instructions.

(b) The following information shall be included for the duration of the patient's treatment in the patient's official hospital medical record/chart:

(i) The radionuclide administered, number of sources, activity in millicuries or becquerels and time and date of administration;

(ii) The exposure rate at one meter, the time the determination was made, and by whom;

(iii) The radiation symbol; and

(iv) The precautionary instructions necessary to assure that the exposure of individuals does not exceed that permitted under WAC 246-221-010.

(c) Information required by subsection (4)(b)(i) and (ii) of this section shall be retained for review by the department.

[Statutory Authority: RCW 70.98.050. 94-06-017, § 246-240-020, filed 2/22/94, effective 3/25/94. Statutory Authority: RCW 70.98.050 and 70.98.080. 91-15-112 (Order 184), § 246-240-020, filed 7/24/91, effective 8/24/91. Statutory Authority: RCW 43.70.040. 91-02-049 (Order 121), recodified as § 246-240-020, filed 12/27/90, effective 1/31/91. Statutory Authority: RCW 70.98.080. 87-01-031 (Order 2450), § 402-32-020, filed 12/11/86; 83-19-050 (Order 2026), § 402-32-020, filed 9/16/83. Statutory Authority: RCW 70.98.050. 81-01-011 (Order 1570), § 402-32-020, filed 12/8/80; Order 1084, § 402-32-020, filed 1/14/76; Order 1, § 402-32-020, filed 1/8/69; Rules (part), filed 10/26/66.]

### WAC 246-240-030 Teletherapy. (1) Equipment.

(a) The housing shall be so constructed that, at one meter from the source, the maximum exposure rate does not exceed ten milliroentgens per hour when the beam control mechanism is in the "off" position. The average exposure rate measured at a representative number of points about the housing, each one meter from the source, shall not exceed two milliroentgens per hour.

(b) For teletherapy equipment installed after the effective date of these regulations, the leakage radiation measured at one meter from the source when the beam control mechanism is in the "on" position shall not exceed 0.1 percent of the useful beam exposure rate.

(c) Adjustable or removable beam-defining diaphragms shall allow transmission of not more than five percent of the useful beam exposure rate.

(d) The beam control mechanism shall be of a positive design capable of acting in any orientation of the housing for which it is designed to be used. In addition to an automatic closing device, the mechanism shall be designed so that it can be manually returned to the "off" position with a minimum risk of exposure.

(e) The closing device shall be so designed as to return automatically to the "off" position in the event of any breakdown or interruption of the activating force and shall stay in the "off" position until activated from the control panel.

(f) Beam control mechanisms.

(i) When any door to the treatment room is opened, the beam control mechanism shall automatically and rapidly restore the unit to the "off" position and cause it to remain there until the unit is reactivated from the control panel.

(ii) Beam control mechanisms shall be tested at intervals not to exceed three months for proper function. Records of these tests shall be maintained for inspection by the department.

(g) There shall be at the housing and at the control panel a warning device that plainly indicates whether the beam is on or off.

(h) The equipment shall be provided with a locking device to prevent unauthorized use.

(i) The control panel shall be provided with a timer that automatically terminates the exposure after a pre-set time.

(j) Provision shall be made to permit continuous observation of patients during irradiation.

(k) The treatment room shall be equipped with a permanent radiation monitor which shall:

(i) Continuously monitor the condition of the teletherapy beam;

(ii) Provide a continuous visible signal to the teletherapy unit operator and any person entering the treatment room, of a unit malfunction;

(iii) Each radiation monitor must be equipped with an emergency power supply separate from the power supply to the teletherapy unit. This emergency power supply may be a battery system;

(iv) Each radiation monitor must be tested for proper operation each day before the teletherapy unit is used for treatment of patients; and

(v) If a radiation monitor is inoperable for any reason, any person entering the teletherapy room shall use a properly operating portable survey instrument or audible alarm personal dosimeter to monitor for any malfunction of the source exposure mechanism that may have resulted in an exposed or partially exposed source. Survey instruments or dosimeters must be tested daily before use.

(2) **Operation.** Except in the emergency condition when a source fails to retract, no individual shall be in the treatment room during irradiation unless that individual is the patient. Mechanical restraining or supporting devices shall be used for positioning the patient, if necessary.

(3) **Testing for leakage and contamination.** Teletherapy sources shall be tested for leakage and contamination in accordance with the procedures described in WAC 246-240-020(2). Tests of leakage may be made by wiping accessible surfaces of the housing port or collimator while the source is in the "off" position and measuring these wipes for transferred contamination.

[Statutory Authority: RCW 70.98.050 and 70.98.080. 91-15-112 (Order 184), § 246-240-030, filed 7/24/91, effective 8/24/91. Statutory Authority: RCW 43.70.040. 91-02-049 (Order 121), recodified as § 246-240-030, filed 12/27/90, effective 1/31/91. Statutory Authority: RCW 70.98.080. 83-19-050 (Order 2026), § 402-32-030, filed 9/16/83. Statutory Authority: RCW 70.98.050. 81-01-011 (Order 1570), § 402-32-030, filed 12/8/80; Order 1084, § 402-32-030, filed 1/14/76; Order 1, § 402-32-030, filed 1/8/69; Rules (part), filed 10/26/66.]

**WAC 246-240-040 Special requirements for teletherapy licensees. (1) Requirement to perform full calibration requirements of teletherapy units.**

(a) Any licensee authorized under WAC 246-235-080 to use teletherapy units for treating humans shall cause full calibration measurements to be performed on each teletherapy unit:

(i) Prior to the first use of the unit for treating humans:

(A) Whenever spot-check measurements indicate that the output value differs by more than five percent from the value obtained at the last full calibration corrected mathematically for physical decay;

(B) Following replacement of the radiation source or following reinstallation of the teletherapy unit in a new location;

(C) Following any repair of the teletherapy unit that includes removal of the source or major repair of the

components associated with the source exposure assembly; and

(D) At intervals not exceeding one year.

(b) Full calibration measurements required by (a) of this subsection shall include determination of:

(i) The exposure rate or dose rate to an accuracy within  $\pm 3$  percent for the range of field sizes and for the range of distances (or for the axis distance) used in radiation therapy;

(ii) The congruence between the radiation field and the field indicated by the light beam localizing device;

(iii) The uniformity of the radiation field and its dependence upon the orientation of the useful beam;

(iv) Timer accuracy; and

(v) The accuracy of all distance measuring devices used for treating humans.

(c) Full calibration measurements shall be made in accordance with the procedures recommended by the Scientific Committee on Radiation Dosimetry of the American Association of Physicists in Medicine (Physics in Medicine and Biology, Vol. 16, No. 3, 1971, pp. 379-386).<sup>1</sup>

(d) The exposure rate or dose rate values determined in (b)(i) of this subsection shall be corrected mathematically for physical decay for intervals not exceeding one month for units employing a Cobalt-60 source and six months for units employing a Cesium-137 source.

(e) Full calibration measurements required by (a) of this subsection and physical decay corrections required by (d) of this subsection shall be performed by an expert qualified by training and experience in accordance with subsection (4) of this section.

**(2) Requirement to perform periodic spot-check measurements of teletherapy units.**

(a) Any licensee authorized under WAC 246-235-080(4) to use teletherapy units for treating humans shall cause spot-check measurements to be performed on each teletherapy unit at intervals not exceeding one month.

(b) Spot-check measurements required by (a) of this subsection shall include determination of:

(i) Timer accuracy;

(ii) The congruence between the radiation field and the field indicated by the light beam localizing device;

(iii) The accuracy of all distance measuring devices used for treating humans;

(iv) The exposure rate, dose rate, or a quantity related in a known manner to these rates for one typical set of operating conditions; and

(v) The difference between the measurement made in (b) of this subsection and the anticipated output, expressed as a percentage of the anticipated output (i.e., the value obtained at last full calibration corrected mathematically for physical decay).

(c) Spot-check measurements required by (a) of this subsection shall be performed in accordance with procedures established by an expert qualified by training and experience in accordance with subsection (4) of this section. (A qualified expert need not actually perform the spot-check measurements.) If a qualified expert does not perform the spot-check measurements, the results of the spot-check measurements shall be reviewed by a qualified expert within fifteen days.

**(3) Requirement to calibrate instruments used for full calibration and spot-check measurements.**

(a) Full calibration measurements required by subsection (1) of this section shall be performed using a dosimetry system that has been calibrated by the National Bureau of Standards or by a Regional Calibration Laboratory accredited by the American Association of Physicists in Medicine. The dosimetry system shall have been calibrated within the previous two years and after any servicing that may have affected system calibration.

(b) Spot-check measurements required by subsection (2) of this section shall be performed using a dosimetry system that has been calibrated in accordance with (a) of this subsection. Alternatively, a dosimetry system used solely for spot-check measurements may be calibrated by direct intercomparison with a system that has been calibrated in accordance with (a) of this subsection. This alternative calibration method shall have been performed within the previous one year and after each servicing that may have affected system calibration. Dosimetry systems calibrated by this alternative method shall not be used for full calibration measurements. The use of thermoluminescent dosimeter does not satisfy the requirements of this section.

(4) **Qualified expert.** The licensee shall determine if a person is an expert qualified by training and experience to calibrate a teletherapy unit and establish procedures for (and review the results of) spot-check measurements. The licensee shall determine that the qualified expert:

(a) Is certified by the American Board of Radiology in Therapeutic Radiological Physics, Radiological Physics, Roentgen-Ray and Osmin-Ray Physics, or X-ray and Radium Physics; or

(b) Has the following minimum training and experience:

(i) A master's or doctor's degree in physics, biophysics, radiological physics or health physics;

(ii) One year of full-time training in therapeutic radiological physics; and

(iii) One year of full-time experience in a radiotherapy facility including personal calibration and spot-check of at least one teletherapy unit.

Note: The requirements of subsection (4) of this section are in addition to those set forth under "Qualified expert" in WAC 246-220-010.

**(5) Records.**

The licensee shall maintain, for inspection by the department, records of the measurements, tests, corrective actions, and instrument calibrations made under subsections (1) and (2) of this section and records of the licensee's evaluation of the qualified expert's training and experience made under subsection (4) of this section.

(a) Records of (i) full calibration measurements and (ii) calibration of instruments used to make these measurements shall be preserved for five years after completion of the full calibration.

(b) Records of (i) spot-check measurements and corrective actions and (ii) calibration of instruments used to make spot-check measurements shall be preserved for two years after completion of the spot-check measurements and corrective actions.

(c) Records of the licensee's evaluation of the qualified expert's training and experience shall be preserved for five years after the qualified expert's last performance of a full calibration of the licensee's teletherapy unit.

**(6) Inspection and servicing of the source exposure mechanism.**

(a) Each teletherapy machine shall be fully inspected and serviced during source replacement or at intervals not to exceed five years, whichever comes first, to assure proper function of the source exposure mechanism. This inspection and servicing must be performed by persons specifically authorized to do so by the department, the United States Nuclear Regulatory Commission, or an agreement state, and a complete written report of the inspection and servicing must be kept on file for review by the department.

(b) The following shall be performed only by persons specifically authorized by the department, the United States Nuclear Regulatory Commission, or an agreement state to perform such services:

(i) Installation, inspection, servicing, relocation, or removal of teletherapy units containing sources.

(ii) Source exchange.

(iii) Any maintenance or repair operations on a teletherapy unit involving work on the source drawer, the shutter, or other mechanism that could expose the source, reduce the shielding around the source or compromise the safety of the unit and result in increased radiation levels.

<sup>1</sup> Licensees that have their teletherapy units calibrated by persons who do not meet these criteria for minimum training and experience may require a license amendment excepting them from the requirements of subsection (4) of this section. The request should include the name of the proposed qualified expert, a description of his or her training and experience including information similar to that specified by subsection (4) of this section and a report of at least one calibration and spot-check program based on measurements personally made by the proposed expert within the last ten years and written endorsement of the technical qualifications of the proposed expert from personal knowledge by a physicist certified by the American Board of Radiology in one of the specialties listed therein.

[Statutory Authority: RCW 70.98.050 and 70.98.080. 91-15-112 (Order 184), § 246-240-040, filed 7/24/91, effective 8/24/91. Statutory Authority: RCW 43.70.040. 91-02-049 (Order 121), recodified as § 246-240-040, filed 12/27/90, effective 1/31/91. Statutory Authority: RCW 70.98.080. 87-01-031 (Order 2450), § 402-32-100, filed 12/11/86; 83-19-050 (Order 2026), § 402-32-100, filed 9/16/83. Statutory Authority: RCW 70.98.050. 81-01-011 (Order 1570), § 402-32-100, filed 12/8/80.]

**WAC 246-240-050 Notifications, records, and reports of therapy misadministrations.** (1) The licensee shall notify by telephone the division of radiation protection at (206) 682-5327 no later than the next calendar day after the discovery of a therapy misadministration.

(2) The licensee also shall notify the referring physician and the patient or the patient's responsible relative or guardian (hereinafter referred to as "the patient") of the therapy misadministration not later than twenty-four hours after its discovery, unless the referring physician personally informs the licensee either that the physician will inform the patient or that, based on medical judgment, telling the patient would be harmful. The licensee is not required to notify the patient without first consulting the referring physician. If the referring physician or patient cannot be reached within twenty-four hours, the licensee shall notify the patient as soon as possible thereafter. The licensee may not delay any appropriate medical care for the patient, including any necessary remedial care as a result of the therapy misadministration, because of any delay in notification.



(3) The licensee shall submit a written report to the department within fifteen days after discovery of the therapy misadministration. The written report must include the licensee's name; the prescribing physician's name; a brief description of the therapy misadministration; why it occurred; the effect on the patient; what improvements are needed to prevent recurrence; actions taken to prevent recurrence; whether the licensee notified the patient, and if not, why not, and if the patient was notified, what information was provided to the patient. The report shall not include the patient's name or other identifying information.

(4) If the patient was notified, the licensee shall also furnish, within fifteen days after discovery of the therapy misadministration, a written report to the patient by sending either:

(a) A copy of the report that was submitted to the department; or

(b) A brief description of both the therapy misadministration and the consequences, as they may affect the patient, and a statement informing the patient that the report submitted to the department can be obtained from the licensee.

(5) Each licensee shall retain a record of each therapy misadministration for five years. The record must contain the names of all individuals involved (including the physician, allied health personnel, the patient, and the patient's referring physician), the patient's Social Security number or identification number if one has been assigned, a brief description of the therapy misadministration, why it occurred, the effect on the patient, what improvements are needed to prevent recurrence, and the actions taken to prevent recurrence.

(6) Aside from the notification requirement, nothing in this section affects any rights or duties of licensees and physicians in relation to each other, patients, or the patient's responsible relatives or guardians.

[Statutory Authority: RCW 70.98.050 and 70.98.080. 92-06-008 (Order 245), § 246-240-050, filed 2/21/92, effective 3/23/92.]

### Chapter 246-243 WAC

## RADIATION PROTECTION—INDUSTRIAL RADIOGRAPHY

### WAC

246-243-001	Purpose.
246-243-010	Scope.
246-243-020	Definitions.
246-243-030	Offshore operations.
246-243-040	Equipment control.
246-243-050	Internal audit and training.
246-243-060	Locking of radiographic exposure devices.
246-243-070	Storage precautions.
246-243-080	Radiation survey instruments.
246-243-090	Leak testing, repair, tagging, opening, modification, and replacement of sealed sources.
246-243-100	Quarterly inventory.
246-243-110	Utilization logs.
246-243-120	Inspection and maintenance of radiographic exposure devices, control cables, storage containers and source changers.
246-243-130	Limitations—Personal radiation safety requirements for radiographers and radiographers' assistants.
246-243-140	Operating and emergency procedures.
246-243-150	Personnel monitoring control.
246-243-160	Supervision of radiographers' assistants.

246-243-170	Security—Precautionary procedures in radiographic operations.
246-243-180	Posting.
246-243-190	Radiation surveys and survey records.
246-243-195	Reporting.
246-243-200	Records required at temporary job sites.
246-243-205	Temporary job site notification.
246-243-210	Special requirements for enclosed radiography.
246-243-220	Special requirements for permanent radiographic installation.
246-243-230	Appendix A—Minimum subjects to be covered in training radiographers.
246-243-240	Appendix B—General guidelines for inspection of radiography equipment.

**WAC 246-243-001 Purpose.** The regulations in this chapter establish radiation safety requirements for persons utilizing sources of radiation for industrial radiography. The requirements of this part are in addition to and not in substitution for the other requirements of these regulations.

[Statutory Authority: RCW 43.70.040. 91-02-049 (Order 121), recodified as § 246-243-001, filed 12/27/90, effective 1/31/91; Order 1084, § 402-36-010, filed 1/14/76; Order 1, § 402-36-010, filed 1/8/69; Rules (part), filed 10/26/66.]

**WAC 246-243-010 Scope.** The regulations in this chapter apply to all licensees who use sources of radiation for industrial radiography: *Provided, however,* That nothing in this part shall apply to the use of sources of radiation in the healing arts.

[Statutory Authority: RCW 70.98.050. 94-01-073, § 246-243-010, filed 12/9/93, effective 1/9/94. Statutory Authority: RCW 43.70.040. 91-02-049 (Order 121), recodified as § 246-243-010, filed 12/27/90, effective 1/31/91; Order 1084, § 402-36-020, filed 1/14/76; Order 1, § 402-36-020, filed 1/8/69; Rules (part), filed 10/26/66.]

**WAC 246-243-020 Definitions.** As used in this part:

(1) "Enclosed radiography" means industrial radiography employing radiographic exposure devices conducted in an enclosed cabinet or room and includes cabinet radiography and shielded room radiography.

(a) "Cabinet radiography" means industrial radiography employing radiographic exposure devices conducted in an enclosure or cabinet so shielded that every location at the exterior meets the conditions specified in WAC 246-221-060 of these regulations.

(b) "Shielded-room radiography" means industrial radiography conducted in a room so shielded that every location on the exterior meets the conditions specified in WAC 246-221-060 of these regulations.

(2) "Industrial radiography" means the examination of the macroscopic structure of materials by nondestructive methods utilizing sources of radiation. Industrial radiography as used in this chapter does not include well logging operations.

(3) "Permanent radiographic installation" means a shielded installation or structure designed or intended for radiography employing a radiographic exposure device and in which radiography is regularly performed, regardless of ownership.

(4) "Personal supervision" means supervision by a radiographer such that the radiographer is physically present at the radiography site and in such proximity that communication can be maintained and immediate assistance given as



required. When a radiographer's assistant is using or handling sources of radiation, the radiographer must maintain direct surveillance.

(5) "Radiographer" means any individual who performs or who, in attendance at the site where sources of radiation are being used, personally supervises industrial radiographic operations and who is responsible to the licensee for assuring compliance with the requirements of these regulations and all license conditions.

(6) "Radiographer's assistant" means any individual who, under the personal supervision of a radiographer, uses sources of radiation, related handling tools, or radiation survey instruments in industrial radiography.

(7) "Radiographic exposure device" means any instrument containing a sealed source fastened or contained therein, in which the sealed source or shielding thereof may be moved, or otherwise changed, from a shielded to unshielded position for purposes of making a radiographic exposure.

(8) "Shielded position" means the location within the radiographic exposure device or storage container which, by manufacturer's design, is the proper location for storage of the sealed source.

(9) "Source changer" means a device designed and used for replacement of sealed sources in radiographic exposure devices, including those also used for transporting and storage of sealed sources.

(10) "Storage container" means a device in which sealed sources are transported or stored.

(11) Temporary job site refers to any location which is not specifically authorized and described in a license.

[Statutory Authority: RCW 70.98.050. 94-01-073, § 246-243-020, filed 12/9/93, effective 1/9/94. Statutory Authority: RCW 70.98.050 and 70.98.080. 91-15-112 (Order 184), § 246-243-020, filed 7/24/91, effective 8/24/91. Statutory Authority: RCW 43.70.040. 91-02-049 (Order 121), recodified as § 246-243-020, filed 12/27/90, effective 1/31/91. Statutory Authority: RCW 70.98.080. 83-19-050 (Order 2026), § 402-36-025, filed 9/16/83. Statutory Authority: RCW 70.98.050. 81-01-011 (Order 1570), § 402-36-025, filed 12/8/80; Order 1084, § 402-36-025, filed 1/14/76.]

**WAC 246-243-030 Offshore operations.** Offshore and/or underwater radiography shall be performed only by licensees whose license specifically authorizes such activity. Such operations fall under the jurisdiction of the United States Nuclear Regulatory Commission when conducted outside of the territorial waters of the state of Washington.

[Statutory Authority: RCW 43.70.040. 91-02-049 (Order 121), recodified as § 246-243-030, filed 12/27/90, effective 1/31/91. Statutory Authority: RCW 70.98.080. 83-19-050 (Order 2026), § 402-36-027, filed 9/16/83.]

**WAC 246-243-040 Equipment control.** (1) Equipment used in industrial radiography operations must meet the following criteria, the following requirements apply to radiographic exposure devices and associated equipment that allow the source to be moved out of the device for routine operation:

(a) The coupling between the source assembly and the control cable must be designed in such a manner that the source assembly will not become disconnected if cranked outside the guide tube. The coupling must be such that it can not be unintentionally disconnected under normal and reasonably foreseeable abnormal conditions.

(b) The device must automatically secure the source assembly when it is cranked back into the fully shielded position within the device. The securing system may only be released by means of a deliberate operation on the exposure device.

(c) The outlet fittings, lock box, and drive cable fitting on each radiographic exposure device must be equipped with safety plugs or covers which must be installed during storage and transportation to protect the source assembly from water, mud, sand, or other foreign matter.

(d) The guide tube must have passed the crushing tests for the control tube as specified in ANSI N432 and a kinking resistance test that closely approximates the kinking forces likely to be encountered during use.

(e) Guide tubes or exposure heads connected directly to the device must be used when moving the source out of the device.

(f) An exposure head or similar device designed to protect the source assembly from passing out of the end of the guide tube must be attached to the outermost end of the guide tube during radiographic operations. The guide tube exposure head connection must be able to withstand the tensile test for control units specified in ANSI N432.

(g) Source changers must provide a system for assuring that the source will not be accidentally withdrawn from the changer when connecting or disconnecting the drive cable to or from a source assembly.

(h) All newly manufactured radiographic exposure devices and associated equipment acquired by licenses after January 1, 1995, must comply with the requirements of this section.

(i) All radiographic exposure devices and associated equipment in use after January 1, 1998, must comply with the requirements of this section.

(2) Limits on levels of radiation for radiographic exposure devices and storage containers:

(a) Radiographic exposure devices measuring less than four inches from the sealed source storage position to any exterior surface of the device shall have no radiation level in excess of fifty milliroentgens per hour (50mR/hr) at six inches from any exterior surface of the device.

(b) Radiographic exposure devices measuring a minimum of four inches from the sealed source storage position to any exterior surface of the device, and all storage containers for sealed sources or outer containers for radiographic exposure devices, shall have no radiation level in excess of two hundred milliroentgens per hour (200mR/hr) at any exterior surface, and ten milliroentgens per hour (10mR/hr) at one meter from any exterior surface.

(c) The radiation levels specified are with the sealed source in the shielded (i.e., "off") position.

[Statutory Authority: RCW 70.98.050. 94-01-073, § 246-243-040, filed 12/9/93, effective 1/9/94. Statutory Authority: RCW 43.70.040. 91-02-049 (Order 121), recodified as § 246-243-040, filed 12/27/90, effective 1/31/91. Statutory Authority: RCW 70.98.050. 81-01-011 (Order 1570), § 402-36-030, filed 12/8/80; Order 1084, § 402-36-030, filed 1/14/76; Order 1, § 402-36-030, filed 1/8/69; Rules (part), filed 10/26/66.]

**WAC 246-243-050 Internal audit and training.** (1) Each licensee shall conduct the internal audit required by WAC 246-235-080 (5)(c) at intervals not to exceed three months. The audit should be done by management or the

radiation safety officer and shall cover a review or spot checks of the records required by WAC 246-220-020, 246-221-110, 246-221-160, 246-221-230, 246-243-080, 246-243-090, 246-243-100, 246-243-110, 246-243-120, 246-243-130, 246-243-150, 246-243-190, 246-243-200, and 246-243-220, and conditions of the license.

(2) Each individual performing radiography shall be audited at intervals not to exceed three months during the performance of radiography, to assure that the license provisions, regulations, and the licensees operating and emergency procedures are followed by radiographers and radiographer's assistants. If a radiographer or a radiographer's assistant has not participated in a radiographic operation for more than three months since the last audit, that individual's performance must be observed and recorded the next time the individual participates in a radiographic operation. This audit shall be performed by the radiation safety officer, management, or the most experienced radiographers available. Results of this audit shall be recorded.

(3) Records of the internal audits required by subsections (1) and (2) of this section shall be maintained for three years.

(4) Training required by WAC 246-235-080 (5)(a) shall be conducted in accordance with the conditions of the license and subject to the following criteria:

(a) Initial training must be completed before a person can act as a radiographer or radiographer's assistant;

(b) Periodic retraining must be conducted at least annually;

(c) Records showing compliance with these training requirements must be maintained for at least one year following termination of employment.

[Statutory Authority: RCW 70.98.050 and 70.98.080. 92-06-008 (Order 245), § 246-243-050, filed 2/21/92, effective 3/23/92. Statutory Authority: RCW 43.70.040. 91-02-049 (Order 121), recodified as § 246-243-050, filed 12/27/90, effective 1/31/91. Statutory Authority: RCW 70.98.080. 83-19-050 (Order 2026), § 402-36-035, filed 9/16/83.]

**WAC 246-243-060 Locking of radiographic exposure devices.** (1) Each radiographic exposure device shall be provided with a lock or outerlocked container designed to prevent unauthorized or accidental production of radiation or removal or exposure of a sealed source and shall be locked when returned to the shielded position at all times. In addition, during radiographic operations the sealed source assembly shall be locked in the shielded position each time the source is returned to that position.

(2) Each sealed source storage container and source changer shall have a lock or outer locked container designed to prevent unauthorized or accidental removal of the sealed source from its shielded position. Storage containers and source changers shall be kept locked when containing sealed sources except when under the direct surveillance of a radiographer or a radiographer's assistant.

(3) Radiographic exposure devices, source changers, and storage containers, prior to being moved from one location to another and also prior to being secured at a given location, shall be locked and surveyed to assure that the sealed source is in the shielded position.

[Statutory Authority: RCW 70.98.050 and 70.98.080. 91-15-112 (Order 184), § 246-243-060, filed 7/24/91, effective 8/24/91. Statutory Authority: RCW 43.70.040. 91-02-049 (Order 121), recodified as § 246-243-060, filed

12/27/90, effective 1/31/91. Statutory Authority: RCW 70.98.050. 81-01-011 (Order 1570), § 402-36-040, filed 12/8/80; Order 1084, § 402-36-040, filed 1/14/76; Order 1, § 402-36-040, filed 1/8/69; Rules (part), filed 10/26/66.]

**WAC 246-243-070 Storage precautions.** (1) Locked radiographic exposure devices and storage containers shall be physically secured to prevent tampering or removal by unauthorized personnel.

(2) At least one calibrated and operable radiation survey instrument shall be available at the storage area whenever a radiographic exposure device, a storage container, or source is being placed in storage.

[Statutory Authority: RCW 70.98.050. 94-01-073, § 246-243-070, filed 12/9/93, effective 1/9/94. Statutory Authority: RCW 43.70.040. 91-02-049 (Order 121), recodified as § 246-243-070, filed 12/27/90, effective 1/31/91. Statutory Authority: RCW 70.98.050. 81-01-011 (Order 1570), § 402-36-050, filed 12/8/80; Order 1084, § 402-36-050, filed 1/14/76; Order 1, § 402-36-050, filed 1/8/69; Rules (part), filed 10/26/66.]

**WAC 246-243-080 Radiation survey instruments.**

(1) The licensee shall maintain sufficient calibrated and operable radiation survey instruments to make physical radiation surveys as required by this part and chapter 246-221 WAC. Instrumentation required by this section shall have a range such that two milliroentgens per hour through one roentgen per hour can be measured.

(2) Each radiation survey instrument shall be calibrated:

(a) At energies appropriate for use and at intervals not to exceed three months and after each instrument servicing;

(b) Such that accuracy within  $\pm 20$  percent traceable to a national standard can be demonstrated; and

(c) At two or more widely separated points, other than zero,

on each scale.

(3) Records shall be maintained of these calibrations for three years after the calibration date for inspection by the department.

[Statutory Authority: RCW 70.98.050. 94-01-073, § 246-243-080, filed 12/9/93, effective 1/9/94. Statutory Authority: RCW 70.98.050 and 70.98.080. 91-15-112 (Order 184), § 246-243-080, filed 7/24/91, effective 8/24/91. Statutory Authority: RCW 43.70.040. 91-02-049 (Order 121), recodified as § 246-243-080, filed 12/27/90, effective 1/31/91. Statutory Authority: RCW 70.98.080. 83-19-050 (Order 2026), § 402-36-060, filed 9/16/83. Statutory Authority: RCW 70.98.050. 81-01-011 (Order 1570), § 402-36-060, filed 12/8/80; Order 1084, § 402-36-060, filed 1/14/76; Order 1, § 402-36-060, filed 1/8/69; Rules (part), filed 10/26/66.]

**WAC 246-243-090 Leak testing, repair, tagging, opening, modification, and replacement of sealed sources.**

(1) The replacement of any sealed source fastened to or contained in a radiographic exposure device and leak testing, repair, tagging, opening, or any other modification of any sealed source shall be performed only by persons specifically authorized to do so by the department, the United States Nuclear Regulatory Commission, or any agreement state.

(2) Each sealed source shall be tested for leakage at intervals not to exceed six months. In the absence of a certificate from a transferor that a test has been made within the six-month period prior to the transfer, the sealed source shall not be put into use until tested and results obtained.

(3) The leak test shall be capable of detecting the presence of 185 becquerels (0.005 microcurie) of removable contamination on the sealed source. An acceptable leak test

for sealed sources in the possession of a radiography licensee would be to test at the nearest accessible point to the sealed source storage position, or other appropriate measuring point, by a procedure specifically approved in a license condition. Records of leak test results shall be kept in units of microcuries and maintained for inspection by the department for three years after the leak test is performed.

(4) Any test conducted pursuant to subsections (2) and (3) of this section which reveals the presence of 185 becquerels (0.005 microcurie) or more of removable radioactive material shall be considered evidence that the sealed source is leaking. The licensee shall immediately withdraw the equipment involved from use and shall cause it to be decontaminated and repaired or to be disposed in accordance with regulations of the department. Within five days after obtaining results of the test, the licensee shall file a report with the department describing the involved equipment, the test results, and the corrective action taken.

(5) A sealed source which is not fastened to or contained in a radiographic exposure device shall have permanently attached to it a durable tag at least one inch square bearing the prescribed radiation caution symbol in conventional colors magenta or purple on a yellow background, and at least the instructions: "Danger - Radioactive Material - Do not handle - Notify civil authorities if found."

(6) Each radiographic exposure device shall have permanently and conspicuously attached to it a durable label at least two inches square bearing the prescribed radiation caution symbol in conventional colors (magenta or purple on a yellow background), and at a minimum the instructions, "Danger - Radioactive Material - Do not handle - Notify civil authorities if found."

(7) Each radiographic exposure device must have attached to it by the user, a durable, legible, clearly visible label bearing the following:

- (a) Chemical symbol and mass number of the radionuclide in the device;
- (b) Activity and the date on which this activity was last measured;
- (c) Model number and serial number of the sealed source;
- (d) Manufacturer of the sealed source; and
- (e) Licensee's name, address, and telephone number.

[Statutory Authority: RCW 70.98.050. 94-01-073, § 246-243-090, filed 12/9/93, effective 1/9/94. Statutory Authority: RCW 70.98.050 and 70.98.080. 91-15-112 (Order 184), § 246-243-090, filed 7/24/91, effective 8/24/91. Statutory Authority: RCW 43.70.040. 91-02-049 (Order 121), recodified as § 246-243-090, filed 12/27/90, effective 1/31/91. Statutory Authority: RCW 70.98.080. 87-01-031 (Order 2450), § 402-36-070, filed 12/11/86; 83-19-050 (Order 2026), § 402-36-070, filed 9/16/83. Statutory Authority: RCW 70.98.050. 81-01-011 (Order 1570), § 402-36-070, filed 12/8/80; Order 1084, § 402-36-070, filed 1/14/76; Order 1, § 402-36-070, filed 1/8/69; Rules (part), filed 10/26/66.]

**WAC 246-243-100 Quarterly inventory.** Each licensee shall conduct a quarterly physical inventory to account for all sealed sources received or possessed. The records of the inventories shall be maintained for three years from the date of inventory for inspection by the department and shall include:

- (1) Exposure device or source changer make, model, and serial number;
- (2) Sealed source serial number and manufacturer;

- (3) Radionuclide and current activity;
- (4) Location of device/changer;
- (5) Date of inventory;
- (6) Name of person who performed inventory.

[Statutory Authority: RCW 70.98.050. 94-01-073, § 246-243-100, filed 12/9/93, effective 1/9/94. Statutory Authority: RCW 43.70.040. 91-02-049 (Order 121), recodified as § 246-243-100, filed 12/27/90, effective 1/31/91. Statutory Authority: RCW 70.98.080. 83-19-050 (Order 2026), § 402-36-080, filed 9/16/83. Statutory Authority: RCW 70.98.050. 81-01-011 (Order 1570), § 402-36-080, filed 12/8/80; Order 1084, § 402-36-080, filed 1/14/76; Order 1, § 402-36-080, filed 1/8/69; Rules (part), filed 10/26/66.]

**WAC 246-243-110 Utilization logs.** (1) Each licensee shall maintain current logs, which shall be kept available for inspection by the department for three years from the date of the recorded event, at the address specified in the license showing for each radiation exposure device the following information:

(a) A description (or make and model number) of each radiation exposure device or storage container in which the sealed source is located;

(b) The identity of the radiographer to whom assigned; and

(c) Locations where used and dates of use.

(2) A separately identified utilization log is not required if the equivalent information is available in records of the licensee and available at the address specified in the license.

[Statutory Authority: RCW 70.98.050. 94-01-073, § 246-243-110, filed 12/9/93, effective 1/9/94. Statutory Authority: RCW 70.98.050 and 70.98.080. 91-15-112 (Order 184), § 246-243-110, filed 7/24/91, effective 8/24/91. Statutory Authority: RCW 43.70.040. 91-02-049 (Order 121), recodified as § 246-243-110, filed 12/27/90, effective 1/31/91. Statutory Authority: RCW 70.98.050. 81-01-011 (Order 1570), § 402-36-090, filed 12/8/80; Order 1084, § 402-36-090, filed 1/14/76; Order 1, § 402-36-090, filed 1/8/69; Rules (part), filed 10/26/66.]

**WAC 246-243-120 Inspection and maintenance of radiographic exposure devices, control cables, storage containers and source changers.** (1) The licensee shall conduct a program for inspection and maintenance of radiographic exposure devices, storage containers, control units (to include cables), and source changers at intervals, not to exceed three months or prior to first use thereafter to assure proper functioning of components important to safety. Records of these inspections and maintenance shall be kept for three years.

(2) The licensee shall check for obvious defects in radiographic exposure devices, storage containers, control assemblies, and source changers prior to use each day the equipment is used.

(3) The licensee's program shall include a thorough visual inspection for corrosion, and specific maintenance procedures that address corrosion removal and prevention.

(4) If any inspection conducted pursuant to subsections (1) or (2) of this section reveals damage to components critical to radiation safety, the device shall be removed from service until proper repairs have been made.

(5) Any maintenance performed on radiographic exposure devices and accessories shall be in accordance with the manufacturer's specifications.

[Statutory Authority: RCW 70.98.050. 94-01-073, § 246-243-120, filed 12/9/93, effective 1/9/94. Statutory Authority: RCW 70.98.050 and 70.98.080. 91-15-112 (Order 184), § 246-243-120, filed 7/24/91, effective

8/24/91. Statutory Authority: RCW 43.70.040. 91-02-049 (Order 121), recodified as § 246-243-120, filed 12/27/90, effective 1/31/91. Statutory Authority: RCW 70.98.080. 83-19-050 (Order 2026), § 402-36-095, filed 9/16/83. Statutory Authority: RCW 70.98.050. 81-01-011 (Order 1570), § 402-36-095, filed 12/8/80; Order 1084, § 402-36-095, filed 1/14/76.]

**WAC 246-243-130 Limitations—Personal radiation safety requirements for radiographers and radiographers' assistants.** (1) No licensee shall permit any individual to act as a radiographer as defined in this chapter until such individual:

(a) Has been instructed in the subjects outlined in WAC 246-243-230;

(b) Has received copies of and instruction in the regulations contained in chapters 246-220, 246-222, 246-221, and 246-243 WAC and the applicable sections of appropriate license(s), and the licensee's operating and emergency procedures, and shall have demonstrated understanding thereof;

(c) Has demonstrated competence to use the source of radiation, related handling tools, and radiation survey instruments which will be employed in the individual's assignment; and

(d) Has demonstrated understanding of the instructions in this paragraph by successful completion of written test and a field examination on the subjects covered.

(2) No licensee shall permit any individual to act as a radiographer's assistant as defined in this part until such individual:

(a) Has received copies of and instruction in the licensee's operating and emergency procedures;

(b) Has demonstrated competence to use under the personal supervision of the radiographer the sources of radiation, related handling tools, and radiation survey instruments which will be employed in the individual's assignment;

(c) Has demonstrated understanding of the instructions in this paragraph by successfully completing a written or oral test and a field examination on the subjects covered; and

(d) Records of the above training including copies of written tests and dates of oral tests and field examinations shall be maintained for at least one year following termination of employment.

(3) Each licensee shall maintain, for inspection by the department, records of training and testing which demonstrate that the requirements of subsections (1) and (2) of this section and WAC 246-235-080 (5)(a) are met.

[Statutory Authority: RCW 70.98.050. 94-01-073, § 246-243-130, filed 12/9/93, effective 1/9/94. Statutory Authority: RCW 70.98.050 and 70.98.080. 91-15-112 (Order 184), § 246-243-130, filed 7/24/91, effective 8/24/91. Statutory Authority: RCW 43.70.040. 91-02-049 (Order 121), recodified as § 246-243-130, filed 12/27/90, effective 1/31/91. Statutory Authority: RCW 70.98.080. 83-19-050 (Order 2026), § 402-36-100, filed 9/16/83. Statutory Authority: RCW 70.98.050. 81-01-011 (Order 1570), § 402-36-100, filed 12/8/80; Order 1084, § 402-36-100, filed 1/14/76; Order 1, § 402-36-100, filed 1/8/69; Rules (part), filed 10/26/66.]

**WAC 246-243-140 Operating and emergency procedures.** The licensee's operating and emergency procedures shall include instructions in at least the following:

(1) The handling and use of sources of radiation to be employed such that no individual is likely to be exposed to

radiation doses in excess of the limits established in chapter 246-221 WAC Standards for protection against radiation;

(2) Methods and occasions for conducting radiation surveys;

(3) Methods for controlling access to radiographic areas;

(4) Methods and occasions for locking and securing sources of radiation;

(5) Personnel monitoring and the use of personnel monitoring equipment including steps that must be taken immediately by radiography personnel in the event a pocket dosimeter is found to be off-scale;

(6) Transportation to field locations, including packing of sources of radiation in the vehicles, posting of vehicles, and control of sources of radiation during transportation;

(7) Minimizing exposure of individuals in the event of an accident;

(8) Notifying proper personnel in the event of a theft, loss, overexposure or accident involving sources of radiation;

(9) Maintenance of records;

(10) The inspection and maintenance of radiographic exposure devices and storage containers; and

(11) Identifying and reporting defects and noncompliance as required by these regulations.

[Statutory Authority: RCW 70.98.050. 94-01-073, § 246-243-140, filed 12/9/93, effective 1/9/94. Statutory Authority: RCW 70.98.050 and 70.98.080. 91-15-112 (Order 184), § 246-243-140, filed 7/24/91, effective 8/24/91. Statutory Authority: RCW 43.70.040. 91-02-049 (Order 121), recodified as § 246-243-140, filed 12/27/90, effective 1/31/91. Statutory Authority: RCW 70.98.080. 83-19-050 (Order 2026), § 402-36-110, filed 9/16/83. Statutory Authority: RCW 70.98.050. 81-01-011 (Order 1570), § 402-36-110, filed 12/8/80; Order 1084, § 402-36-110, filed 1/14/76; Order 708, § 402-36-110, filed 8/24/72; Order 1, § 402-36-110, filed 7/2/71; Order 1, § 402-36-110, filed 1/8/69; Rules (part), filed 10/26/66.]

**WAC 246-243-150 Personnel monitoring control.**

(1) No licensee shall permit any individual to act as a radiographer or as a radiographer's assistant unless, at all times during radiographic operations, each such individual shall wear a film or TLD badge, a direct reading pocket dosimeter, and an alarming rate meter. In permanent facilities where other appropriate alarming or warning devices are in routine use, the wearing of an alarming rate meter is not required. Pocket dosimeters shall be capable of measuring exposures from zero to at least 200 milliroentgens. A film or TLD badge shall be assigned to and worn by only one individual.

(2)(a) Pocket dosimeters shall be read and exposures recorded daily. Pocket dosimeters shall be charged at the beginning of each working day. Pocket dosimeters shall be checked annually at periods not to exceed thirteen months for correct response to radiation. Acceptable dosimeters shall read within plus or minus twenty percent of the true radiation exposure.

(b) Each alarming rate meter must:

(i) Be checked to ensure that the alarm functions properly (sounds) prior to use at the start of each shift;

(ii) Be set to give an alarm signal at a maximum preset rate of 500 mR/hr.;

(iii) Require special means to change the preset alarm functions; and

(iv) Be calibrated annually at periods not to exceed thirteen months for correct response to radiation: Acceptable

rate meters must alarm within plus or minus twenty percent of the true radiation exposure rate.

(c) A film or TLD badge shall be immediately processed if a pocket dosimeter is discharged beyond its range during normal use. The film or TLD badge reports received from the film or TLD badge processor and records of pocket dosimeter readings shall be maintained for inspection by the department until it authorizes their disposal.

[Statutory Authority: RCW 70.98.050. 94-01-073, § 246-243-150, filed 12/9/93, effective 1/9/94. Statutory Authority: RCW 70.98.050 and 70.98.080. 91-15-112 (Order 184), § 246-243-150, filed 7/24/91, effective 8/24/91. Statutory Authority: RCW 43.70.040. 91-02-049 (Order 121), recodified as § 246-243-150, filed 12/27/90, effective 1/31/91. Statutory Authority: RCW 70.98.080. 83-19-050 (Order 2026), § 402-36-120, filed 9/16/83. Statutory Authority: RCW 70.98.050. 81-01-011 (Order 1570), § 402-36-120, filed 12/8/80; Order 1084, § 402-36-120, filed 1/14/76; Order 1, § 402-36-120, filed 1/8/69; Rules (part), filed 10/26/66.]

**WAC 246-243-160 Supervision of radiographers' assistants.** Whenever a radiographer's assistant uses radiographic exposure devices, uses sealed sources or related source handling tools, or conducts radiation surveys required by WAC 246-243-190 (2), (3), (4), or (5) to determine that the sealed source has returned to the shielded position after an exposure, he or she shall be under the personal supervision of a radiographer, as defined in WAC 246-243-020. Personal supervision shall include (1) the radiographer's personal presence at the site where the sealed sources are being used, (2) the ability of the radiographer to communicate and give immediate assistance if required, and (3) the radiographer's ability to observe the performance of his/her assistant during the operations referred to in this section.

[Statutory Authority: RCW 70.98.050. 94-01-073, § 246-243-160, filed 12/9/93, effective 1/9/94. Statutory Authority: RCW 70.98.050 and 70.98.080. 91-15-112 (Order 184), § 246-243-160, filed 7/24/91, effective 8/24/91. Statutory Authority: RCW 43.70.040. 91-02-049 (Order 121), recodified as § 246-243-160, filed 12/27/90, effective 1/31/91. Statutory Authority: RCW 70.98.080. 83-19-050 (Order 2026), § 402-36-125, filed 9/16/83. Statutory Authority: RCW 70.98.050. 81-01-011 (Order 1570), § 402-36-125, filed 12/8/80.]

**WAC 246-243-170 Security—Precautionary procedures in radiographic operations.** (1) During each radiographic operation, the radiographer or radiographer's assistant shall maintain a direct surveillance of the operation to protect against unauthorized entry into a high radiation area, as defined in chapter 246-220 WAC except:

(a) Where the high radiation area is equipped with a control device or alarm system as described in WAC 246-221-102(1); or

(b) Where the high radiation area is locked to protect against unauthorized or accidental entry.

(2) When not in operation or when not under direct surveillance, portable radiation exposure devices shall be physically secured to prevent removal by unauthorized personnel.

[Statutory Authority: RCW 70.98.050. 94-01-073, § 246-243-170, filed 12/9/93, effective 1/9/94. Statutory Authority: RCW 70.98.050 and 70.98.080. 91-15-112 (Order 184), § 246-243-170, filed 7/24/91, effective 8/24/91. Statutory Authority: RCW 43.70.040. 91-02-049 (Order 121), recodified as § 246-243-170, filed 12/27/90, effective 1/31/91. Statutory Authority: RCW 70.98.050. 81-01-011 (Order 1570), § 402-36-130, filed 12/8/80; Order 1084, § 402-36-130, filed 1/14/76; Order 1, § 402-36-130, filed 1/8/69; Rules (part), filed 10/26/66.]

**WAC 246-243-180 Posting.** Notwithstanding any provisions in paragraph WAC 246-221-130 areas in which radiography is being performed or in which a radiographic exposure device is being stored shall be conspicuously posted and access to the area shall be controlled as required by WAC 246-221-120 and 246-221-102(1).

(1) All potential radiation areas where industrial radiographic operations are to be performed shall be posted based on calculated or estimated exposure rates before industrial radiography operations begin.

(2) Each time the exposure device is relocated and/or the exposed position of the sealed source is changed, the requirements of subsection (1) of this section shall be met.

[Statutory Authority: RCW 70.98.050. 94-01-073, § 246-243-180, filed 12/9/93, effective 1/9/94. Statutory Authority: RCW 70.98.050 and 70.98.080. 91-15-112 (Order 184), § 246-243-180, filed 7/24/91, effective 8/24/91. Statutory Authority: RCW 43.70.040. 91-02-049 (Order 121), recodified as § 246-243-180, filed 12/27/90, effective 1/31/91. Statutory Authority: RCW 70.98.050. 81-01-011 (Order 1570), § 402-36-140, filed 12/8/80; Order 1084, § 402-36-140, filed 1/14/76; Order 1, § 402-36-140, filed 1/8/69; Rules (part), filed 10/26/66.]

**WAC 246-243-190 Radiation surveys and survey records.** (1) No radiographic operation shall be conducted unless calibrated and operable radiation survey instrumentation as described in WAC 246-243-080 is available and used at each site where radiographic operations are being performed and at the storage area whenever a radiographic exposure device, a storage container, or source is being placed in storage.

(2) A physical radiation survey shall be made after each radiographic exposure utilizing radiographic exposure devices or sealed sources of radioactive material to determine that the sealed source has been returned to its shielded position. The horizontal circumference of the radiographic exposure device shall be surveyed. If the radiographic exposure device has a source guide tube, the survey shall include the guide tube.

(3) A physical radiation survey shall be made to determine that each sealed source is in its shielded condition prior to securing the radiographic exposure device or storage container as specified in WAC 246-243-060. The horizontal circumference of the radiographic exposure device shall be surveyed. If the radiographic exposure device has a source guide tube, the survey shall include the guide tube.

(4) A physical radiation survey shall be made of the boundary of the restricted area during radiographic operations not employing shielded room radiography. The maximum survey reading at the boundary shall be recorded. The records shall indicate approximate distance from source to boundaries, whether or not the exposed source is collimated and any occupied areas with exposure levels greater than 2 mR in any hour during radiographic operations.

(5) A survey with a calibrated and operable survey instrument shall be made any time a radiographic exposure device is placed into the storage area to ensure that the sealed source is in its shielded position. The horizontal circumference of the radiographic exposure device with emphasis on the source exit port must be surveyed.

(6) Records required by subsections (3), (4), and (5) of this section shall include the model and serial number of the

survey meter used and shall be maintained for inspection by the department for three years after completion of the survey. If the survey was used to determine an individual's exposure, however, the records of the survey shall be maintained until the department authorizes their disposition.

[Statutory Authority: RCW 70.98.050. 94-01-073, § 246-243-190, filed 12/9/93, effective 1/9/94. Statutory Authority: RCW 70.98.050 and 70.98.080. 92-06-008 (Order 245), § 246-243-190, filed 2/21/92, effective 3/23/92. Statutory Authority: RCW 43.70.040. 91-02-049 (Order 121), recodified as § 246-243-190, filed 12/27/90, effective 1/31/91. Statutory Authority: RCW 70.98.080. 83-19-050 (Order 2026), § 402-36-150, filed 9/16/83. Statutory Authority: RCW 70.98.050. 81-01-011 (Order 1570), § 402-36-150, filed 12/8/80; Order 1084, § 402-36-150, filed 1/14/76; Order 1, § 402-36-150, filed 1/8/69; Rules (part), filed 10/26/66.]

**WAC 246-243-195 Reporting.** (1) In addition to the reporting requirements specified in other sections of the regulations, each licensee shall provide a written report to the department within thirty days of the occurrence of any of the following incidents involving radiographic equipment:

(a) Unintentional disconnection of the source assembly from the control cable.

(b) Inability to retract the source assembly to its fully shielded position and secure it in this position.

(c) Failure of any component (critical to safe operation of the device) to properly perform its intended function.

(2) The licensee shall include the following information in each report submitted under subsection (1) of the section.

(a) A description of the equipment problem;

(b) Cause of each incident, if known;

(c) Manufacturer and model number of equipment involved in the incident;

(d) Place, time, and date of incident;

(e) Actions taken to reestablish normal operations;

(f) Corrective actions taken or planned to prevent recurrence;

(g) Qualifications of personnel involved in the incident.

(3) Reports of overexposure submitted under WAC 246-221-260 which involve failure of safety components of radiographic equipment must also include the information specified in subsection (2) of this section.

[Statutory Authority: RCW 70.98.050. 94-01-073, § 246-243-195, filed 12/9/93, effective 1/9/94.]

**WAC 246-243-200 Records required at temporary job sites.** Each licensee conducting radiographic operations at a temporary site shall have the following records available at that site for inspection by the department:

(1) Appropriate license;

(2) Operating and emergency procedures;

(3) Applicable regulations;

(4) Survey records required pursuant to WAC 246-243-190 for the period of operation at the site;

(5) Daily pocket dosimeter records for the period of operation at the site;

(6) The latest instrument calibration and leak test record for specific devices in use at the site.

[Statutory Authority: RCW 70.98.050. 94-01-073, § 246-243-200, filed 12/9/93, effective 1/9/94. Statutory Authority: RCW 70.98.050 and 70.98.080. 91-15-112 (Order 184), § 246-243-200, filed 7/24/91, effective 8/24/91. Statutory Authority: RCW 43.70.040. 91-02-049 (Order 121), recodified as § 246-243-200, filed 12/27/90, effective 1/31/91. Statutory

Authority: RCW 70.98.050. 81-01-011 (Order 1570), § 402-36-153, filed 12/8/80.]

**WAC 246-243-205 Temporary job site notification.**

(1) Each licensee shall provide notification to the department as required by the department, preferably twenty-four hours but no later than two hours, prior to beginning radiographic operations at a temporary job site. The notification will be given by using the prescribed 1-800 telephone notification system. The notification shall include:

(a) Name and office telephone number of the licensee;

(b) Radioactive materials license number;

(c) Address or directions to the temporary job site;

(d) Specific date(s), time(s), and duration of expected radiographic operations;

(e) Names of radiographers and, if applicable, radiographer assistants taking part in the radiographic operations; and

(f) Name and telephone number of a contact person at the temporary job site.

(2) In the event that operations at a temporary job site continue for longer than thirty days, the licensee will renotify the department, as required by subsection (1) of this section, each succeeding month.

[Statutory Authority: RCW 70.98.050. 94-01-073, § 246-243-205, filed 12/9/93, effective 1/9/94.]

**WAC 246-243-210 Special requirements for enclosed radiography.** (1) Radiographic exposure device systems designed to exclude individuals during radiography are exempt from the requirements of chapter 246-243 WAC except that:

(a) Operating personnel must be provided with either a film badge or a thermoluminescent dosimeter and reports of the results must be maintained for inspection by the department.

(b) No licensee shall permit any individual to operate radiographic exposure device systems until such individual has received a copy of and instruction in the operating procedures for the unit and has demonstrated competence in its use. Records which demonstrate compliance with this subparagraph shall be maintained for inspection by the department until disposition is authorized by the department.

(c) Tests for proper operation of high radiation area control devices or alarm systems, where applicable, must be conducted at the beginning of each day of use and recorded.

(d) The licensee shall perform an evaluation, at intervals not to exceed one year, to determine conformance with WAC 246-221-060 of these regulations.

Records of these evaluations shall be maintained for inspection by the department for a period of three years after the evaluation.

[Statutory Authority: RCW 70.98.050. 94-01-073, § 246-243-210, filed 12/9/93, effective 1/9/94. Statutory Authority: RCW 70.98.050 and 70.98.080. 91-15-112 (Order 184), § 246-243-210, filed 7/24/91, effective 8/24/91. Statutory Authority: RCW 43.70.040. 91-02-049 (Order 121), recodified as § 246-243-210, filed 12/27/90, effective 1/31/91. Statutory Authority: RCW 70.98.080. 83-19-050 (Order 2026), § 402-36-155, filed 9/16/83. Statutory Authority: RCW 70.98.050. 81-01-011 (Order 1570), § 402-36-155, filed 12/8/80; Order 1084, § 402-36-155, filed 1/14/76.]

**WAC 246-243-220 Special requirements for permanent radiographic installation.** Permanent radiographic



installations having high radiation area entrance controls of the types described in WAC 246-221-102(1) or where the high radiation area is locked to protect against unauthorized or accidental entry, shall also meet the following special requirements.

(1) Each entrance that is used for personnel access to the high radiation area in a permanent radiographic installation to which this section applies shall have both visible and audible warning signals to warn of the presence of radiation. The visible signal shall be actuated by radiation whenever the source is exposed. The audible signal shall be actuated when an attempt is made to enter the installation while the source is exposed.

(2) Both visible and audible alarm systems are required and shall be tested prior to the first use of a source in the installation and thereafter at intervals not to exceed three months. Records of the tests shall be kept for three years.

(3) The department shall review and approve, in advance of construction, plans for permanent radiographic installations whose construction had not commenced by the effective date of these regulations. Construction of the permanent facility shall be in accordance with the plans approved by the department.

(4) A physical radiation survey shall be conducted and results recorded following construction or major modification of the facility to be used in the installation. Radiography shall not be conducted if exposure levels in unrestricted areas are greater than 2 mR in any hour. Any increase in source strength will require resurvey of the installation prior to the conduct of industrial radiography.

[Statutory Authority: RCW 70.98.050. 94-01-073, § 246-243-220, filed 12/9/93, effective 1/9/94. Statutory Authority: RCW 70.98.050 and 70.98.080. 91-15-112 (Order 184), § 246-243-220, filed 7/24/91, effective 8/24/91. Statutory Authority: RCW 43.70.040. 91-02-049 (Order 121), recodified as § 246-243-220, filed 12/27/90, effective 1/31/91. Statutory Authority: RCW 70.98.080. 83-19-050 (Order 2026), § 402-36-157, filed 9/16/83. Statutory Authority: RCW 70.98.050. 81-01-011 (Order 1570), § 402-36-157, filed 12/8/80.]

**WAC 246-243-230 Appendix A—Minimum subjects to be covered in training radiographers.** (1) *Fundamentals of radiation safety*

(a) Characteristics of ionizing radiation  
(b) Units of radiation dose (mrem) and quantity of radioactivity (curie)

(c) Hazards of exposure to radiation  
(i) Radiation protection standards  
(ii) Biological effects of radiation dose  
(d) Levels of radiation from sources of radiation  
(e) Methods of controlling radiation dose  
(i) Working time  
(ii) Working distances  
(iii) Shielding

(2) *Radiation detection instrumentation to be used*

(a) Use of radiation survey instruments  
(i) Operation  
(ii) Calibration  
(iii) Limitations  
(b) Survey techniques  
(c) Use of personnel monitoring equipment  
(i) Film badges  
(ii) Pocket dosimeters

(iii) Thermoluminescent dosimeters

(iv) Alarming rate meters

(3) *Radiographic equipment to be used*

(a) Remote handling equipment

(b) Radiographic exposure devices and sealed sources

(c) Storage containers

(4) *The requirements of pertinent federal and state regulations*

(5) *The licensee's written operating and emergency procedures*

(6) *Case histories of radiography accidents.*

[Statutory Authority: RCW 70.98.050. 94-01-073, § 246-243-230, filed 12/9/93, effective 1/9/94. Statutory Authority: RCW 43.70.040. 91-02-049 (Order 121), recodified as § 246-243-230, filed 12/27/90, effective 1/31/91. Statutory Authority: RCW 70.98.050. 81-01-011 (Order 1570), § 402-36-160, filed 12/8/80; Order 1084, § 402-36-160, filed 1/14/76; Order 1, § 402-36-160, filed 1/8/69; Rules (part), filed 10/26/66.]

**WAC 246-243-240 Appendix B—General guidelines for inspection of radiography equipment.** (1) Panoramic devices (devices in which the source is physically removed from shielded container during exposure) should be inspected for:

(a) Radiographic exposure unit;

(i) Abnormal surface radiation levels anywhere on camera;

(ii) Condition of safety plugs;

(iii) Proper operation of locking mechanism;

(iv) Condition of pigtail connector;

(v) Alignment of "S" tube with exit port;

(vi) Condition of carrying device (straps, handle, etc.);

(vii) Proper labeling;

(b) Source tube;

(i) Rust, corrosion, dirt, or sludge buildup inside the source tube;

(ii) Condition of source tube connector;

(iii) Condition of source stop;

(iv) Kinks or damage that could prevent proper operation;

(c) Control cables and drive mechanism;

(i) Proper drive mechanism for this camera, if appropriate;

(ii) Changes in general operating characteristics;

(iii) Condition of connector on drive cable;

(iv) Drive cable flexibility, wear, and rust;

(v) Excessive wear or damage to crank assembly parts;

(vi) Damage to drive cable conduit that could prevent the cable from moving freely;

(vii) Connection of the control cable connector with the pigtail connector for proper mating;

(viii) Proper operation of source position indicator, if applicable.

(2) Directional beam devices should be inspected for:

(a) Abnormal surface radiation;

(b) Changes in the general operating characteristics of the unit;

(c) Proper operation of shutter mechanism;

(d) Chafing or binding of shutter mechanism;

(e) Damage to the device which might impair its operation;

(f) Proper operation of locking mechanism;



- (g) Proper drive mechanism with this camera, if appropriate;
- (h) Condition of carrying device (strap, handle, etc.);
- (i) Proper labeling.

[Statutory Authority: RCW 70.98.050, 94-01-073, § 246-243-240, filed 12/9/93, effective 1/9/94. Statutory Authority: RCW 43.70.040, 91-02-049 (Order 121), recodified as § 246-243-240, filed 12/27/90, effective 1/31/91. Statutory Authority: RCW 70.98.080, 83-19-050 (Order 2026), § 402-36-165, filed 9/16/83.]

### Chapter 246-244 WAC RADIATION PROTECTION—WIRELINE SERVICES

#### WAC

246-244-001	Purpose.
246-244-010	Scope.
246-244-020	Definitions.
246-244-030	Prohibitions.
246-244-040	Limits on levels of radiation.
246-244-050	Storage precautions.
246-244-060	Transport precautions.
246-244-070	Radiation survey instruments.
246-244-080	Leak testing of sealed sources.
246-244-090	Inventories.
246-244-100	Utilization logs/records.
246-244-110	Design, performance, and certification criteria for sealed sources used in downhole operations.
246-244-120	Labeling.
246-244-130	Inspection and maintenance.
246-244-140	Training requirements.
246-244-150	Operating and emergency procedures.
246-244-160	Personnel monitoring.
246-244-170	Radioactive contamination control.
246-244-180	Security.
246-244-190	Handling tools.
246-244-200	Subsurface tracer studies.
246-244-210	Radiation surveys.
246-244-220	Documents and records required at field stations.
246-244-230	Documents and records required at temporary job sites.
246-244-240	Notification of incidents, abandonment, and lost sources.

**WAC 246-244-001 Purpose.** This chapter establishes radiation safety requirements for persons using sources of radiation for wireline service operations including mineral logging, radioactive markers, and/or subsurface tracers studies. The requirements of this chapter are in addition to, and not in substitution for, requirements of chapters 246-220, 246-221, 246-222, 246-232, and 246-235 WAC.

[Statutory Authority: RCW 70.98.050 and 70.98.080, 91-15-112 (Order 184), § 246-244-001, filed 7/24/91, effective 8/24/91. Statutory Authority: RCW 43.70.040, 91-02-049 (Order 121), recodified as § 246-244-001, filed 12/27/90, effective 1/31/91. Statutory Authority: RCW 70.98.080, 87-01-031 (Order 2450), § 402-38-010, filed 12/11/86.]

**WAC 246-244-010 Scope.** The regulations in this chapter apply to all licensees who use sources of radiation for wireline service operations, including mineral logging, radioactive markers, uranium sinker bars, or subsurface tracer studies.

[Statutory Authority: RCW 43.70.040, 91-02-049 (Order 121), recodified as § 246-244-010, filed 12/27/90, effective 1/31/91. Statutory Authority: RCW 70.98.080, 87-01-031 (Order 2450), § 402-38-025, filed 12/11/86.]

**WAC 246-244-020 Definitions.** As used in this chapter, the following definitions apply:

(1) "Casing" means a metal pipe or tube used as a lining for oil or gas wells to prevent collapse of the well-bore.

(2) "Field station" means a facility where radioactive sources may be stored or used and from which equipment is dispatched to temporary job sites.

(3) "Fresh water aquifer" means a geological formation that is capable of yielding a significant amount of fresh water to a well or spring.

(4) "Injection tool" means a device used for controlled subsurface injection of radioactive tracer material.

(5) "Irretrievable well-logging source" means any sealed source containing licensed material that is pulled off or not connected to the wireline that suspends the source in the well and for which all reasonable effort at recovery has been expended.

(6) "Logging assistant" means an individual who assists the logging supervisor in performing the well-logging operations.

(7) "Logging supervisor" means an individual who provides personal supervision of the use of licensed material at the temporary job site and who is responsible to the licensee for assuring compliance with requirements of the department's regulations and the conditions of the license.

(8) "Logging tool" means a device used subsurface to perform well-logging.

(9) "Mineral logging" means any logging performed for the purpose of mineral (including water) exploration other than oil or gas.

(10) "Personal supervision" means guidance and instruction by the supervisor who is physically present at the job site and watching the performance of the operation in such proximity that contact is maintained and immediate assistance given as required.

(11) "Radioactive marker" means licensed material used for the purpose of depth determination or direction orientation. This term includes radioactive collar markers and radioactive iron nails.

(12) "Sealed source" means any licensed material that is encased in a capsule designed to prevent leakage or escape of the radioactive material.

(13) "Source holder" means the housing or assembly into which a radioactive source is placed for the purpose of facilitating the handling and use of such source in well-logging operations.

(14) "Subsurface tracer study" means, for the purpose of this chapter, the release of unsealed licensed material or a substance labeled with licensed material in a single well or multiple wells for the purpose of tracing the movement or position of the material or substance in the well-bore or adjacent formation(s) (this term does not include the use of licensed material in field flooding studies).

(15) "Surface casing" means a pipe or tube used as a lining in a well to isolate the fresh water zone from the well.

(16) "Temporary job site" means any location to which radioactive materials have been dispatched or taken to perform wireline service operations or subsurface tracer studies.

(17) "Uranium sinker bar" means a weight containing depleted uranium used for the purpose of providing addition-

al force to pull a logging tool down toward the bottom of a well.

(18) "Well-bore" means any drilled hole in which wireline service operations and/or subsurface tracer studies are performed.

(19) "Well-logging" means the lowering and raising of measuring devices or tools which contain sources of radiation into well-bores or cavities (salt domes, etc.) for the purpose of obtaining information about the well and/or adjacent formations which may be used in oil, gas, mineral or geological explorations.

(20) "Well-logging operation" means any activity involving licensed material performed in a well, including well-logging, mineral logging, subsurface tracer studies, use of radioactive markers, radioactive iron nails, uranium sinker bars, and radioactive sands, and transportation or storage of same.

(21) "Wireline" means a cable containing one or more electrical conductors which is used to lower and raise logging tools in the well-bore.

(22) "Wireline service operation" means any evaluation or mechanical service which is performed in the well-bore using devices containing radioactive material on a wireline.

[Statutory Authority: RCW 43.70.040. 91-02-049 (Order 121), recodified as § 246-244-020, filed 12/27/90, effective 1/31/91. Statutory Authority: RCW 70.98.080. 87-01-031 (Order 2450), § 402-38-030, filed 12/11/86.]

**WAC 246-244-030 Prohibitions.** No licensee shall perform wireline service operations with a sealed source(s) or conduct subsurface tracer studies with sources of radiation unless, prior to commencement of the operation, the licensee has a written agreement with the well operator, well owner, drilling contractor, or land owner that:

(1) In the event a sealed source is lodged downhole every reasonable effort at recovery will be made;

(2) Potentially contaminated equipment or areas will not be released until an acceptable and documented survey is performed;

(3) Specific types of recovery operations which could endanger the integrity of the sealed source encapsulation will not be permitted or conducted; and

(4) In the event a decision is made to abandon the sealed source downhole, requirements of WAC 246-244-240 shall be met.

[Statutory Authority: RCW 70.98.050 and 70.98.080. 91-15-112 (Order 184), § 246-244-030, filed 7/24/91, effective 8/24/91. Statutory Authority: RCW 43.70.040. 91-02-049 (Order 121), recodified as § 246-244-030, filed 12/27/90, effective 1/31/91. Statutory Authority: RCW 70.98.080. 87-01-031 (Order 2450), § 402-38-040, filed 12/11/86.]

**WAC 246-244-040 Limits on levels of radiation.** Sources of radiation shall be used, stored, and transported in such a manner that the transportation requirements of WAC 246-232-090 and the dose limitation requirements of chapter 246-221 WAC are met.

[Statutory Authority: RCW 70.98.050 and 70.98.080. 91-15-112 (Order 184), § 246-244-040, filed 7/24/91, effective 8/24/91. Statutory Authority: RCW 43.70.040. 91-02-049 (Order 121), recodified as § 246-244-040, filed 12/27/90, effective 1/31/91. Statutory Authority: RCW 70.98.080. 87-01-031 (Order 2450), § 402-38-060, filed 12/11/86.]

**WAC 246-244-050 Storage precautions.** (1) Each source of radiation, except accelerators, shall be provided with a storage and/or transport container. Such containers shall be utilized. The container shall be provided with a lock (or tamper seal, for calibration sources) to prevent unauthorized removal of, or exposure to, the source(s) of radiation. Such locks shall be used each time the source of radiation is placed in the storage/transport container.

(2) Sources of radiation shall be stored in a manner which will minimize danger from explosion and/or fire.

[Statutory Authority: RCW 43.70.040. 91-02-049 (Order 121), recodified as § 246-244-050, filed 12/27/90, effective 1/31/91. Statutory Authority: RCW 70.98.080. 87-01-031 (Order 2450), § 402-38-080, filed 12/11/86.]

**WAC 246-244-060 Transport precautions.** (1) Transport containers shall be physically secured to the transporting vehicle to prevent accidental loss, tampering, or unauthorized removal.

(2) Transport of radioactive material shall be in accordance with applicable provisions of the United States Department of Transportation, as required by WAC 246-232-090.

[Statutory Authority: RCW 70.98.050 and 70.98.080. 91-15-112 (Order 184), § 246-244-060, filed 7/24/91, effective 8/24/91. Statutory Authority: RCW 43.70.040. 91-02-049 (Order 121), recodified as § 246-244-060, filed 12/27/90, effective 1/31/91. Statutory Authority: RCW 70.98.080. 87-01-031 (Order 2450), § 402-38-100, filed 12/11/86.]

**WAC 246-244-070 Radiation survey instruments.**

(1) The licensee or registrant shall maintain and use sufficient calibrated and operable radiation survey instruments at each field station and temporary job site to make physical radiation surveys as required. Instrumentation shall be capable of measuring 0.1 milliroentgen per hour through at least 100 milliroentgens per hour.

(2) Each radiation survey instrument shall be calibrated:

(a) At intervals not to exceed six months and after each instrument servicing;

(b) At energies and radiation levels appropriate for use;

(c) At two points located approximately one-third and two-thirds at full scale on each scale (for logarithmic scale, at midrange of each decade, and at two points of at least one decade); and

(d) Such that accuracy within  $\pm 20$  percent of the true radiation levels can be demonstrated on each scale.

(3) Each licensee shall have available additional calibrated and operable radiation detection instruments capable of detecting radiation and contamination levels that could be encountered during well-logging operations or during the event of an accident, e.g., an alpha meter in case of Am-241 source rupture, a contamination meter and probe, and a high level meter capable of detecting radiation levels up to at least one roentgen per hour. The licensee may own such instruments or may make prior arrangements to obtain them expeditiously from a second party as necessary.

(4) Calibration records shall be maintained for a period of at least three years for inspection by the department.

[Statutory Authority: RCW 43.70.040. 91-02-049 (Order 121), recodified as § 246-244-070, filed 12/27/90, effective 1/31/91. Statutory Authority: RCW 70.98.080. 87-01-031 (Order 2450), § 402-38-120, filed 12/11/86.]

**WAC 246-244-080 Leak testing of sealed sources.** Each licensee utilizing sealed sources of radioactive material shall have the sources tested for leakage and/or contamination in accordance with WAC 246-221-080.

[Statutory Authority: RCW 70.98.050 and 70.98.080. 91-15-112 (Order 184), § 246-244-080, filed 7/24/91, effective 8/24/91. Statutory Authority: RCW 43.70.040. 91-02-049 (Order 121), recodified as § 246-244-080, filed 12/27/90, effective 1/31/91. Statutory Authority: RCW 70.98.080. 87-01-031 (Order 2450), § 402-38-140, filed 12/11/86.]

**WAC 246-244-090 Inventories.** (1) Each licensee shall conduct a physical inventory at intervals not to exceed three months to account for all sources of radiation received and possessed. Records of such inventories shall be maintained for at least two years from the date of the inventory for inspection by the department and shall include the quantities, kinds, and serial numbers of sources of radiation, the location where such sources of radiation are assigned and/or stored, the date of the inventory, and the name of the individual conducting the inventory.

(2) Spotmarkers containing radioactive material shall be inventoried prior to arrival at a field site and prior to departure. Records of such inventories shall include the quantity and kinds of radioactive material, serial numbers where appropriate, the date and name of the person performing the inventory, and shall be maintained for inspection by the department.

[Statutory Authority: RCW 43.70.040. 91-02-049 (Order 121), recodified as § 246-244-090, filed 12/27/90, effective 1/31/91. Statutory Authority: RCW 70.98.080. 87-01-031 (Order 2450), § 402-38-160, filed 12/11/86.]

**WAC 246-244-100 Utilization logs/records.** Each licensee shall maintain current records, which shall be kept available for inspection by the department for two years from the date of recorded event, showing the following information for each source of radiation:

- (1) Make, model, and serial number of each source of radiation used;
- (2) The identity of the well-logging supervisor and logging assistants to whom assigned;
- (3) The locations where used and dates of use; and
- (4) In the case of tracer materials and/or radioactive markers, the utilization records shall also indicate the radionuclide and quantity of activity used in a particular well.

[Statutory Authority: RCW 43.70.040. 91-02-049 (Order 121), recodified as § 246-244-100, filed 12/27/90, effective 1/31/91. Statutory Authority: RCW 70.98.080. 87-01-031 (Order 2450), § 402-38-180, filed 12/11/86.]

**WAC 246-244-110 Design, performance, and certification criteria for sealed sources used in downhole operations.** (1) Each sealed source, except those containing radioactive material in gaseous form, used in downhole operations shall be certified by the manufacturer, or other testing organization acceptable to the department, to meet the following minimum criteria:

- (a) Be of doubly encapsulated construction;
- (b) Contain radioactive material whose chemical and physical forms are as insoluble and nondispersible, respectively, as practical; and

(c) Has been individually pressure tested to at least 24,656 pounds per square inch absolute ( $170 \text{ MN/m}^2$ ) without leakage or failure.

(2) Except those containing radioactive material in gaseous form, in the absence of a certificate from a transferor certifying that an individual sealed source meets the requirements of subsections (1) and (3) of this section, the sealed source shall not be put into use until such determinations and testings have been performed and acceptable documented results obtained.

(3) Each sealed source, except those containing a radioactive material in gaseous form, used in downhole operations shall be certified by the manufacturer, or other testing organization acceptable to the department, to meet the sealed source performance requirements for oil well-logging as contained in the January 1986 or most current American National Standard N542, *Sealed Radioactive Sources, Classification*.

(4) Certification documents shall be maintained for inspection by the department for a period of three years after source disposal. If a source is abandoned downhole, the certification documents shall be maintained until the department authorizes disposition.

[Statutory Authority: RCW 43.70.040. 91-02-049 (Order 121), recodified as § 246-244-110, filed 12/27/90, effective 1/31/91. Statutory Authority: RCW 70.98.080. 87-01-031 (Order 2450), § 402-38-200, filed 12/11/86.]

**WAC 246-244-120 Labeling.** (1) Each source, source holder, and logging tool containing radioactive material shall bear a durable, legible, and clearly visible marking or label which has, at a minimum, the standard radiation caution symbol, with or without the conventional color requirement, and the following wording: "DANGER (OR CAUTION) RADIOACTIVE MATERIAL." This labeling shall be on the smallest component transported as a separate piece of equipment.

(2) Each transport container shall have permanently attached to it a durable, legible, and clearly visible label which has, at a minimum, the standard radiation caution symbol and colors and the following wording: "DANGER (OR CAUTION) RADIOACTIVE MATERIAL, NOTIFY CIVIL AUTHORITIES IF FOUND."

(3) The licensee may not use a uranium sinker bar in well-logging operations after December 31, 1987, unless it is clearly and legibly impressed with the words "CAUTION-RADIOACTIVE DEPLETED URANIUM" and "NOTIFY CIVIL AUTHORITIES IF FOUND."

[Statutory Authority: RCW 43.70.040. 91-02-049 (Order 121), recodified as § 246-244-120, filed 12/27/90, effective 1/31/91. Statutory Authority: RCW 70.98.080. 87-01-031 (Order 2450), § 402-38-220, filed 12/11/86.]

**WAC 246-244-130 Inspection and maintenance.** (1) Each licensee shall conduct a program of visual inspection and maintenance of source holders, logging tools, source handling tools, storage containers, transport containers, injection tools, and sinker bars to ensure that the required labeling is legible and that visual physical damage is absent. The licensee shall perform the visual inspection and maintenance at least every three months. Such inspection and maintenance shall follow the manufacturers recommendations for the equipment involved. Licensees shall maintain

records of inspections and maintenance for three years for inspection by the department.

(2) Each licensee shall maintain appropriate copies of manufacturer's operating and maintenance instructions at those locations where such inspection and maintenance is performed.

(3) Each licensee shall inspect the source holders, logging tools, and source handling tools for obvious defects before the equipment is used each day to ensure that the equipment is in good working condition.

(4) If any inspection conducted pursuant to this section reveals damage to the labeling or to components critical for radiation safety, the licensee shall remove the item from service until authorized repairs are made.

(5) Removal of a sealed source from a source holder, and maintenance on sealed sources, holders, or pressure housings in which sealed sources are placed, or on other equipment containing a sealed source may not be performed unless a written instruction for the particular operation in question has been approved by the department as part of the license application.

(6) If a sealed source is stuck in a source holder or logging tool, the licensee may not perform any operations such as drilling, cutting, or chiseling on the source holder or logging tool, unless it is specifically licensed by the department to perform this operation.

(7) The repair, opening, or modification of any sealed source must be performed only by persons specifically licensed to do so by the department, the United States Nuclear Regulatory Commission, an agreement state, or a licensing state.

[Statutory Authority: RCW 43.70.040, 91-02-049 (Order 121), recodified as § 246-244-130, filed 12/27/90, effective 1/31/91. Statutory Authority: RCW 70.98.080, 87-01-031 (Order 2450), § 402-38-240, filed 12/11/86.]

**WAC 246-244-140 Training requirements.** (1) The licensee may not permit an individual to act as a logging supervisor until that person:

(a) Has completed at least forty hours of formal training in a course recognized by the department, the United States Nuclear Regulatory Commission, an agreement state, or a licensing state covering the subjects outlined in subsection (5) of this section;

(b) Has received copies of and instruction in:

(i) Washington state regulations contained in this chapter and in the applicable chapters 246-220, 246-221, and 246-222 WAC or their equivalent;

(ii) The license under which the logging supervisor will perform well-logging operations; and

(iii) The licensee's operating, recordkeeping, and emergency procedures.

(c) Has completed three months of on-the-job training and demonstrated competence in the use of licensed materials, remote handling tools, and radiation survey instruments by a field evaluation; and

(d) Has demonstrated understanding of the requirements in (a) and (b) of this subsection by successfully completing a closed book written test.

(2) The licensee may not permit an individual to act as a logging assistant until that person:

(a) Has received copies of and instruction in the licensee's operating and emergency procedures;

(b) Has demonstrated understanding of the materials listed in subsection (1)(a) and (b) of this section by successfully completing a closed book written test; and

(c) Has received instructions in the use, under the personal supervision of the logging supervisor, of tracer material, sealed sources, remote handling tools, and radiation survey instruments, as appropriate.

(3) Each licensee shall provide for documented refresher training of logging supervisors and logging assistants at intervals not to exceed twelve months.

(4) Each licensee shall maintain a record of each logging supervisor's and logging assistant's training, including copies and dates of written tests for a minimum of three years following the termination of employment.

(5) Each licensee shall include the following subjects in the formal training required by this chapter:

(a) **Fundamentals of radiation safety:**

(i) Characteristics of radiation;

(ii) Units of radiation dose and quantity of radioactivity;

(iii) Hazards of exposure to radiation;

(iv) Levels of radiation from licensed material;

(v) Methods of controlling radiation dose:

(A) Working time;

(B) Working distances;

(C) Shielding;

(D) Radiation safety practices, including prevention and contamination and methods of decontamination;

(b) **Radiation detection instrumentation to be used:**

(i) Use of radiation survey instruments:

(A) Operation;

(B) Calibration;

(C) Limitations;

(ii) Survey techniques;

(iii) Use of personnel monitoring equipment;

(c) **Equipment to be used:**

(i) Handling equipment and remote handling tools;

(ii) Licensed materials;

(iii) Storage, control, and disposal of equipment and licensed material;

(iv) Operation and control of equipment and licensed materials;

(v) Maintenance of equipment;

(d) Requirements of pertinent state and federal regulations;

(e) Case histories and potential consequences of accidents in well-logging operations.

[Statutory Authority: RCW 70.98.050 and 70.98.080, 91-15-112 (Order 184), § 246-244-140, filed 7/24/91, effective 8/24/91. Statutory Authority: RCW 43.70.040, 91-02-049 (Order 121), recodified as § 246-244-140, filed 12/27/90, effective 1/31/91. Statutory Authority: RCW 70.98.080, 87-01-031 (Order 2450), § 402-38-260, filed 12/11/86.]

**WAC 246-244-150 Operating and emergency procedures.** The licensee's operating and emergency procedures shall include instruction in at least the following:

(1) Handling and use of sources of radiation to be employed such that no individual is likely to be exposed to radiation doses in excess of the standards established in chapter 246-221 WAC;

(2) Methods and occasions for conducting radiation surveys;

(3) Methods and occasions for locking and securing sources of radiation;

(4) Personnel monitoring and the use and care of personnel monitoring equipment;

(5) Transportation of sources of radiation to temporary job sites and field stations, including the marking, labeling, packaging, and placing of sources of radiation in vehicles, shipping papers, placarding of vehicles, and physical securing of sources of radiation to transport vehicles during transportation to prevent accidental loss, tampering, or unauthorized removal;

(6) Minimizing personnel exposure, including that from inhalation and ingestion of licensed material, during well-logging operations and in the event of an accident;

(7) Procedure for notifying proper personnel in the event of an accident;

(8) Maintenance of records;

(9) Inspection and maintenance of source holders, logging tools, source handling tools, storage containers, transport containers, and injection tools;

(10) Procedures to be followed in the event a sealed source is lodged downhole or ruptured;

(11) Procedures to be used for picking up, receiving, and opening packages containing radioactive material;

(12) The procedure and the use of tools for remote handling of sealed sources and radioactive tracer material, except low activity calibration sources;

(13) The procedure to use for detecting contamination and for preventing the spread of contamination; and

(14) The procedure to be used to decontaminate the environment, equipment, and/or personnel if any or all are contaminated.

[Statutory Authority: RCW 70.98.050 and 70.98.080. 91-15-112 (Order 184), § 246-244-150, filed 7/24/91, effective 8/24/91. Statutory Authority: RCW 43.70.040. 91-02-049 (Order 121), recodified as § 246-244-150, filed 12/27/90, effective 1/31/91. Statutory Authority: RCW 70.98.080. 87-01-031 (Order 2450), § 402-38-280, filed 12/11/86.]

**WAC 246-244-160 Personnel monitoring.** (1) The licensee may not permit an individual to act as a logging supervisor or logging assistant unless that person wears, at all times during well-logging operations, either a film badge or thermoluminescent dosimeter (TLD). Each film badge or TLD must be assigned to and worn by only one individual. The film badge must be exchanged and analyzed at least monthly and TLD badges exchanged and analyzed at least every three months. The licensee shall have each badge or TLD processed in a timely fashion.

(2) The licensee shall provide appropriate bioassay services to individuals using licensed materials for subsurface tracer studies.

(3) The licensee shall keep reports received from the badge or TLD processor and from the bioassay service laboratory for inspection until the department authorizes disposition or terminates the license.

(4) Personnel monitoring devices and equipment shall monitor for beta, gamma, and neutron radiation as appropriate.

(5) Each licensee shall adhere to the requirements of the department's Regulatory Guide 8.20 *Bioassay Program Criteria for I-125 and I-131*.

[Statutory Authority: RCW 70.98.050 and 70.98.080. 91-15-112 (Order 184), § 246-244-160, filed 7/24/91, effective 8/24/91. Statutory Authority: RCW 43.70.040. 91-02-049 (Order 121), recodified as § 246-244-160, filed 12/27/90, effective 1/31/91. Statutory Authority: RCW 70.98.080. 87-01-031 (Order 2450), § 402-38-300, filed 12/11/86.]

**WAC 246-244-170 Radioactive contamination control.** (1) During efforts to recover a sealed source lodged in the well, the licensee shall continuously monitor, with an appropriate radiation detection instrument, the circulating fluids from the well to check for contamination resulting from damage to the sealed source.

(2) If the licensee detects evidence that the sealed source has ruptured or licensed materials have caused contamination, it shall initiate required emergency procedures.

(3) If contamination results from the use of licensed material in well-logging operations, the licensee shall decontaminate all work areas, equipment, and unrestricted areas to levels deemed appropriate by the department.

[Statutory Authority: RCW 43.70.040. 91-02-049 (Order 121), recodified as § 246-244-170, filed 12/27/90, effective 1/31/91. Statutory Authority: RCW 70.98.080. 87-01-031 (Order 2450), § 402-38-320, filed 12/11/86.]

**WAC 246-244-180 Security.** During each logging or tracer application, the logging supervisor or other designated employee shall maintain direct surveillance of the operation to protect against unauthorized and/or unnecessary entry into the restricted area (as defined in WAC 246-220-010).

[Statutory Authority: RCW 70.98.050 and 70.98.080. 91-15-112 (Order 184), § 246-244-180, filed 7/24/91, effective 8/24/91. Statutory Authority: RCW 43.70.040. 91-02-049 (Order 121), recodified as § 246-244-180, filed 12/27/90, effective 1/31/91. Statutory Authority: RCW 70.98.080. 87-01-031 (Order 2450), § 402-38-340, filed 12/11/86.]

**WAC 246-244-190 Handling tools.** The licensee shall provide and require the use of tools that will assure remote handling of sealed sources other than low activity calibration sources.

[Statutory Authority: RCW 43.70.040. 91-02-049 (Order 121), recodified as § 246-244-190, filed 12/27/90, effective 1/31/91. Statutory Authority: RCW 70.98.080. 87-01-031 (Order 2450), § 402-38-360, filed 12/11/86.]

**WAC 246-244-200 Subsurface tracer studies.** (1) Protective gloves and other appropriate protective clothing and equipment shall be used by all personnel handling radioactive tracer material. Adequate precautions shall be taken to avoid ingestion or inhalation of radioactive material, and to avoid contamination of field site stations and temporary job sites.

(2) No licensee shall cause the injection or administration of radioactive material into fresh water aquifers without prior written authorization from the department and any other appropriate state agency.

[Statutory Authority: RCW 43.70.040. 91-02-049 (Order 121), recodified as § 246-244-200, filed 12/27/90, effective 1/31/91. Statutory Authority: RCW 70.98.080. 87-01-031 (Order 2450), § 402-38-380, filed 12/11/86.]

**WAC 246-244-210 Radiation surveys.** (1) Radiation surveys shall be made and recorded for each area where radioactive materials are stored at intervals not to exceed six months. In those cases where neutron sources are involved, calculations for dose rate may be substituted for direct measurement.

(2) Radiation surveys shall be made and recorded for the radiation levels in occupied positions and on the exterior of each vehicle used to transport radioactive material. Such surveys shall include each and every source of radiation or combination of sources to be transported in the vehicle. In those cases where neutron sources are involved, calculations for dose rate may be substituted for direct measurement.

(3) After removal of the sealed source from the logging tool and before departing the job site, the logging tool detector shall be energized and/or a survey meter used to assure that the logging tool and all related equipment are free of contamination.

(4) Radiation surveys shall be made and recorded at the job site or well head for each tracer operation, except those using Hydrogen-3, Carbon-14, or Sulfur-35. Such surveys shall include measurements of radiation levels immediately before and after each operation.

(5) If the licensee suspects that, as a result of operations involving a sealed source, the encapsulation of the sealed source could have been damaged by the operation, it shall conduct a radiation survey, including a contamination survey, during and after the operation.

(6) The licensee shall make a radiation survey at the temporary job site for each subsurface tracer study. The survey must include measurement of radiation levels before and after the operation, and measurement of contamination levels after the subsurface tracer study.

(7) Records of surveys required pursuant to this section shall include the dates, the identification of individuals making the survey, the identification of survey instruments used including make, model, serial number and calibration date, and an exact description of the location of the survey with diagram. Records of these surveys shall be maintained for inspection by the department for at least two years after completion of the survey.

[Statutory Authority: RCW 43.70.040, 91-02-049 (Order 121), recodified as § 246-244-210, filed 12/27/90, effective 1/31/91. Statutory Authority: RCW 70.98.080, 87-01-031 (Order 2450), § 402-38-400, filed 12/11/86.]

**WAC 246-244-220 Documents and records required at field stations.** Each licensee shall maintain for inspection by the department the following documents and records for the specific devices and sources at the field station:

- (1) Appropriate license or equivalent documents;
- (2) Operating and emergency procedures;
- (3) Applicable regulations;
- (4) Records of the latest survey instrument calibrations required pursuant to WAC 246-244-070;
- (5) Records of the latest leak test results required pursuant to WAC 246-244-080;
- (6) Records of inventories required pursuant to WAC 246-244-090;
- (7) Utilization records required pursuant to WAC 246-244-100;

(8) Records of inspection and maintenance required pursuant to WAC 246-244-130;

(9) Survey records required pursuant to WAC 246-244-210; and

(10) Training records required pursuant to WAC 246-244-140.

[Statutory Authority: RCW 70.98.050 and 70.98.080, 91-15-112 (Order 184), § 246-244-220, filed 7/24/91, effective 8/24/91. Statutory Authority: RCW 43.70.040, 91-02-049 (Order 121), recodified as § 246-244-220, filed 12/27/90, effective 1/31/91. Statutory Authority: RCW 70.98.080, 87-01-031 (Order 2450), § 402-38-420, filed 12/11/86.]

**WAC 246-244-230 Documents and records required at temporary job sites.** Each licensee conducting operations at a temporary job site shall have the following documents and records available at all times at that site for inspection by the department:

(1) Current operating and emergency procedure(s);

(2) Survey records required pursuant to WAC 246-244-210 for the period of operation at the site;

(3) Actual current calibration certificates (or photocopies) for the radiation survey instruments used at the site;

(4) When operating in the state of Washington under reciprocity, a copy of the appropriate license, and the Washington state rules and regulations for radiation protection;

(5) Records of current leak tests for all sealed sources which require such tests at the job site;

(6) Use logs required pursuant to WAC 246-244-100;

(7) Current United States Department of Transportation shipping papers and transport container certifications for the material transported; and

(8) Records of spotmarker inventories made prior to arrival required pursuant to WAC 246-244-090.

[Statutory Authority: RCW 70.98.050 and 70.98.080, 91-15-112 (Order 184), § 246-244-230, filed 7/24/91, effective 8/24/91. Statutory Authority: RCW 43.70.040, 91-02-049 (Order 121), recodified as § 246-244-230, filed 12/27/90, effective 1/31/91. Statutory Authority: RCW 70.98.080, 87-01-031 (Order 2450), § 402-38-440, filed 12/11/86.]

**WAC 246-244-240 Notification of incidents, abandonment, and lost sources.** (1) Notification of incidents and sources lost in other than downhole logging operations shall be made in accordance with appropriate provisions of chapter 246-221 WAC.

(2) The licensee shall immediately notify the state of Washington division of radiation protection by telephone (360/753-3468) and subsequently within five days by confirmatory letter if:

(a) Licensed material has been lost in or near a fresh water aquifer; or

(b) A sealed source has been ruptured. This notice must designate the well or other location and describe the magnitude and extent of licensed materials, assess the consequences of the loss or rupture, and explain efforts planned or being taken to mitigate these consequences.

(3) Whenever a sealed source or device containing radioactive material is lodged downhole, the licensee shall:

(a) Monitor the surface for the presence of radioactive contamination with an appropriate radiation survey instrument (not the logging tool itself) during logging tool recovery operations; and



(b) Notify the department immediately by telephone if radioactive contamination is detected at the surface or if the source appears to be damaged.

(4) When it becomes apparent that efforts to recover the radioactive source will not be successful, the licensee shall:

(a) Advise the well operator or owner, as appropriate, of the regulations of the state of Washington regarding abandonment, and an appropriate method of abandonment. The licensee shall ensure that such abandonment procedures are implemented within thirty days after the sealed source has been classified as irretrievable. Such abandonment procedures shall include:

(i) Immobilization and sealing in place of the radioactive source with a cement plug;

(ii) The setting of a whipstock or deflection device; and

(iii) The mounting of a permanent identification plaque at the surface of the well, containing the appropriate information required by subsection (5) of this section;

(b) Immediately notify the department by telephone (360/753-3468), giving the circumstances of the loss, and request and receive approval of the proposed abandonment procedures; and

(c) File a written report with the department within thirty days of the abandonment, setting forth the following information:

(i) Date and time of occurrence and a brief description of attempts to recover the source;

(ii) A description of the radioactive source(s) involved, including radionuclide, quantity, make, model and serial number, and chemical and physical form;

(iii) Surface location and identification of well;

(iv) Results of efforts to immobilize and seal the source in place;

(v) Depth of the radioactive source in meters or feet;

(vi) Depth to the top of cement plug in meters or feet;

(vii) Depth of the well in meters or feet; and

(viii) Information contained on the permanent identification plaque.

(5) Whenever a sealed source containing radioactive material is not recovered and is abandoned downhole, the licensee shall provide a permanent plaque at least eighteen centimeters square for posting the well or well bore (see Appendix A). This plaque shall:

(a) Be constructed of long lasting material, such as stainless steel or monel; and

(b) Contain the following information permanently and conspicuously engraved on its face:

(i) The word "CAUTION (or DANGER)";

(ii) The radiation symbol(s) with or without the conventional color requirement;

(iii) The date of abandonment (month/day/year);

(iv) The name of the well operator or well owner;

(v) The well name and well identification number(s) or other designation;

(vi) The sealed source(s) by radionuclide and quantity of activity (if more than one source is involved, information for each source shall be included);

(vii) The source depth and the depth to the top of the plug in meters or feet; and

(viii) An appropriate warning, depending on the specific circumstances of each abandonment.<sup>1</sup>

(6) The department may, at its own discretion, impose such other requirements as it may deem necessary.

<sup>1</sup> An example of a suggested plaque is shown in Appendix A of this section. Appropriate warnings may include:  
 (a) "Do not drill below plug back depth";  
 (b) "Do not enlarge casing"; and/or  
 (c) "Do not reenter the hole before contacting the state of Washington division of radiation protection."

#### APPENDIX A

#### Example of Plaque for Identifying Wells Containing Sealed Sources Containing Radioactive Material Abandoned Downhole

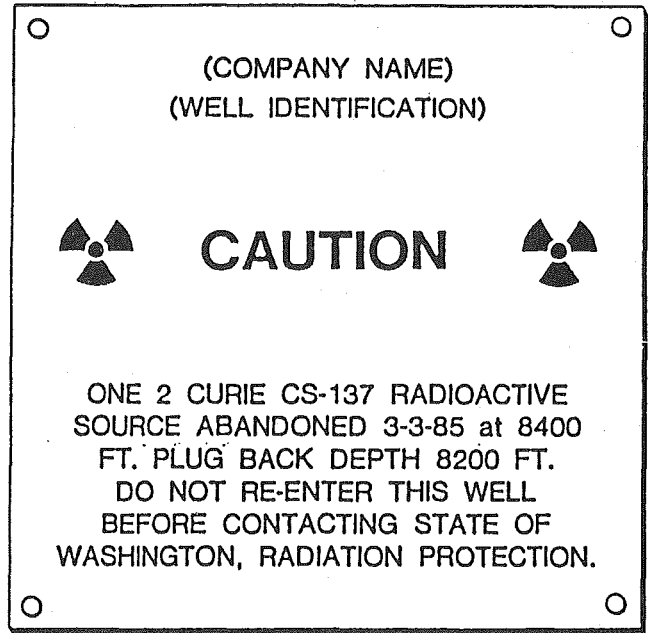

The size of the plaque should be convenient for use on active or inactive wells, and shall be at least eighteen centimeters square. Letter size of the word "CAUTION" or "DANGER" shall be approximately twice the letter size of the rest of the information, e.g., one-half inch and one-fourth inch letter size, respectively.

[Statutory Authority: RCW 70.98.050 and 70.98.080. 91-15-112 (Order 184), § 246-244-240, filed 7/24/91, effective 8/24/91. Statutory Authority: RCW 43.70.040. 91-02-049 (Order 121), recodified as § 246-244-240, filed 12/27/90, effective 1/31/91. Statutory Authority: RCW 70.98.080. 87-01-031 (Order 2450), § 402-38-500, filed 12/11/86.]

#### Chapter 246-247 WAC

#### RADIATION PROTECTION—AIR EMISSIONS

##### WAC

246-247-001	Purpose.
246-247-002	Authority.
246-247-010	Applicability.
246-247-020	Exemptions.
246-247-030	Definitions.
246-247-040	Standards.
246-247-060	Applications, registration and licensing.
246-247-065	Fees.
246-247-075	Monitoring, testing and quality assurance.
246-247-080	Inspections, reporting, and recordkeeping.
246-247-085	Compliance determination for existing emission units and facilities.



246-247-100	Enforcement actions.
246-247-110	Appendix A—Application information requirements.
246-247-120	Appendix B—BARCT compliance demonstration.
246-247-130	Appendix C—ALARACT compliance demonstration.

**DISPOSITION OF SECTIONS FORMERLY  
CODIFIED IN THIS CHAPTER**

246-247-050	Registration. [Statutory Authority: RCW 43.70.040, 91-02-049 (Order 121), recodified as § 246-247-050, filed 12/27/90, effective 1/31/91. Statutory Authority: Chapter 70.98 RCW, 88-17-060 (Order 2671), § 402-80-060, filed 8/17/88. Statutory Authority: RCW 70.98.080, 87-01-031 (Order 2450), § 402-80-060, filed 12/11/86.] Repealed by 94-07-010, filed 3/4/94, effective 4/4/94. Statutory Authority: Chapters 70.98 and 70.94 RCW and chapter 173-480 WAC.
246-247-070	New and modified sources. [Statutory Authority: RCW 43.70.040, 91-02-049 (Order 121), recodified as § 246-247-070, filed 12/27/90, effective 1/31/91. Statutory Authority: RCW 70.98.080, 87-01-031 (Order 2450), § 402-80-070, filed 12/11/86.] Repealed by 94-07-010, filed 3/4/94, effective 4/4/94. Statutory Authority: Chapters 70.98 and 70.94 RCW and chapter 173-480 WAC.
246-247-090	Special reports. [Statutory Authority: RCW 43.70.040, 91-02-049 (Order 121), recodified as § 246-247-090, filed 12/27/90, effective 1/31/91. Statutory Authority: RCW 70.98.080, 87-01-031 (Order 2450), § 402-80-090, filed 12/11/86.] Repealed by 94-07-010, filed 3/4/94, effective 4/4/94. Statutory Authority: Chapters 70.98 and 70.94 RCW and chapter 173-480 WAC.

**WAC 246-247-001 Purpose.** The purpose of this chapter is to establish application requirements and procedures for the issuance of a radioactive air emissions license and for the regulation of those emissions by the department of health (hereinafter referred to as "the department") to assure compliance with the standards for radioactive air emissions set by the department of ecology pursuant to RCW 70.94.331, promulgated in chapter 173-480 WAC, and with the rules and regulations of this chapter.

[Statutory Authority: Chapters 70.98 and 70.94 RCW and chapter 173-480 WAC, 94-07-010, § 246-247-001, filed 3/4/94, effective 4/4/94. Statutory Authority: RCW 43.70.040, 91-02-049 (Order 121), recodified as § 246-247-001, filed 12/27/90, effective 1/31/91. Statutory Authority: RCW 70.98.080, 87-01-031 (Order 2450), § 402-80-010, filed 12/11/86.]

**WAC 246-247-002 Authority.** (1) Rules and regulations set forth herein are adopted and enforced by the department pursuant to the provisions of chapter 70.98 RCW which:

(a) Designate the department as the state's radiation control agency having sole responsibility for the administration of the regulatory, licensing, and radiation control provisions of chapter 70.98 RCW;

(b) Vest in the department the authority to formulate, adopt, promulgate, and repeal codes, rules, and regulations related to the control of sources of ionizing radiation;

(c) Authorize the department to implement an independent state-wide program to monitor radioactive air emissions from sources within the state;

(d) Authorize the department to conduct inspections of facilities, both private and public, to determine whether or not there is compliance with or violation of the provisions of chapter 70.98 RCW and rules and regulations issued thereunder; and

(e) Authorize the department to require registration of sources of ionizing radiation.

(2) In addition, RCW 70.94.422 (Washington Clean Air Act) grants to the department the enforcement powers contained in that chapter.

[Statutory Authority: Chapters 70.98 and 70.94 RCW and chapter 173-480 WAC, 94-07-010, § 246-247-002, filed 3/4/94, effective 4/4/94.]

**WAC 246-247-010 Applicability.** (1) The standards and requirements of this chapter apply state-wide at the following types of facilities that emit radionuclides to the air:

(a) Facilities licensed by the department or by the United States Nuclear Regulatory Commission (NRC);

(b) United States Department of Energy (DOE) facilities;

(c) Non-DOE federal facilities;

(d) Uranium fuel cycle facilities;

(e) Uranium mills that are processing material; and

(f) Any other facility that the department determines emits or has the potential to emit radionuclides to the ambient air.

(2) The standards and requirements of this chapter apply to point sources, nonpoint sources, and fugitive emissions.

(3) The standards and requirements of this chapter apply to stationary and mobile emission units, whether temporary or permanent.

(4) The control technology standards and requirements of this chapter apply to the abatement technology and indication devices of facilities and emission units subject to this chapter. Control technology requirements apply from entry of radionuclides into the ventilated vapor space to the point of release to the environment.

(5) In accordance with RCW 70.94.161(10), air operating permits issued under chapter 173-401 WAC shall incorporate all applicable requirements of this chapter. Therefore, all facilities listed in subsection (1) of this section that are also subject to the operating permit regulations in chapter 173-401 WAC shall be considered in compliance with the requirements of this chapter if they comply with all the applicable requirements of the air operating permit issued under chapter 173-401 WAC. These applicable requirements shall be contained in the radioactive air emissions license which shall be incorporated as part of the air operating permit. In accordance with RCW 70.94.422(1), the department shall enforce all the requirements contained in the radioactive air emissions license.

(6) Should any of the federal regulations that have been adopted by reference in this chapter be rescinded, the affected facilities shall nonetheless comply with all other applicable requirements of this chapter.

(7) An applicant may obtain a copy of any document referenced in this chapter by contacting the department's division of radiation protection, air emissions and defense wastes section at (360) 586-5504. Mail reports, applications, and other written correspondence to the Air Emissions and Defense Wastes Section at Airdustrial Park, Building 5, P.O. Box 47827, Olympia, Washington, 98504-7827.

[Statutory Authority: Chapters 70.98 and 70.94 RCW and chapter 173-480 WAC, 94-07-010, § 246-247-010, filed 3/4/94, effective 4/4/94. Statutory Authority: RCW 43.70.040, 91-02-049 (Order 121), recodified as § 246-247-010, filed 12/27/90, effective 1/31/91. Statutory Authority: RCW 70.98.080, 87-01-031 (Order 2450), § 402-80-020, filed 12/11/86.]

**WAC 246-247-020 Exemptions.** (1) The following types of facilities or sources of radiation are exempt from the requirements of this chapter because they release no airborne radioactivity, or they prima facie comply with the standards in WAC 246-247-040, or they are already adequately regulated under other requirements:

- (a) Users of only sealed sources;
- (b) Sealed sources;
- (c) Accelerators less than 200 MeV;
- (d) Nuclear-powered vessels underway or moored dockside unless under a maintenance condition with a potential-to-emit;
- (e) Uranium mill tailings piles disposed of under 40 CFR Part 192.

(2) Exemption determinations.

(a) Any exemptions shall be consistent with 40 CFR 61. No exemptions from the standards in WAC 246-247-040 will be granted.

(b) A nonfederal facility may request exemption from some of the requirements of WAC 246-247-060 and 246-247-075 if the potential-to-emit, for the emission unit(s) under consideration, results in compliance at level I of the COMPLY computer code or level I of the NCRP's Commentary No. 3, or equivalent as approved by the department.

(c) A federal facility may request exemption from some of the requirements of WAC 246-247-060 and 246-247-075 if the potential-to-emit, for the emission unit(s) under consideration, results in a TEDE to the MEI from all pathways less than 0.1 mrem/yr.

(d) The facility shall submit all the data necessary to make the exemption determinations of (b) and (c) of this subsection. The department shall determine if any exemptions apply.

(e) Commercial nuclear power plants may request exemption from some of the requirements of this chapter in order to minimize dual regulation with the NRC.

(3) The department may require a facility with exempt emission units to submit a radioactive air emissions report to confirm compliance with applicable standards. The department reserves the right to conduct inspections and audits of the facility to confirm the status of its exempt emission units.

(4) Naturally occurring airborne radionuclides are exempt from the requirements of this chapter unless the concentrations or rates of emissions have been enhanced by industrial processes.

[Statutory Authority: Chapters 70.98 and 70.94 RCW and chapter 173-480 WAC. 94-07-010, § 246-247-020, filed 3/4/94, effective 4/4/94. Statutory Authority: RCW 43.70.040. 91-02-049 (Order 121), recodified as § 246-247-020, filed 12/27/90, effective 1/31/91. Statutory Authority: RCW 70.98.080. 87-01-031 (Order 2450), § 402-80-030, filed 12/11/86.]

**WAC 246-247-030 Definitions.** Terms used in this chapter have the definitions set forth below with reference to radioactive air emissions.

(1) "Abatement technology" means any mechanism, process or method that has the potential to reduce public exposure to radioactive air emissions. Abatement control features include automatic mechanisms and administrative controls used in the operation and control of abatement technology from entry of radionuclides into the ventilated vapor space to release to the environment.

(2) "Administrative control" means any policy or procedure that limits the emission of radionuclides.

(3) "ALARA" means as low as reasonably achievable making every reasonable effort to maintain exposures to radiation as far below the dose standards in this chapter as is practical, consistent with the purpose for which the licensed activity is undertaken, taking into account the state of technology, the economics of improvements in relation to the state of technology, the economics of improvements in relation to benefits to the public health and safety, and other socioeconomic considerations, and in relation to the utilization of nuclear energy, ionizing radiation, and radioactive materials in the public interest. See WAC 246-220-007.

(4) "As low as reasonably achievable control technology" (ALARACT) means the use of radionuclide emission control technology that achieves emission levels that are consistent with the philosophy of ALARA. ALARACT compliance is demonstrated by evaluating the existing control system and proposed nonsignificant modifications in relation to applicable technology standards and other control technologies operated successfully in similar applications. In no event shall application of ALARACT result in emissions of radionuclides that could cause exceedance of the applicable standards of WAC 246-247-040. See the definition of ALARA in this section. Note that ALARACT is equivalent to, but replaces, RACT in the May 7, 1986, version of chapter 173-480 WAC.

(5) "Annual possession quantity" means the sum of the quantity of a radionuclide on hand at the beginning of the calendar year and the quantity of that radionuclide received or produced during the calendar year.

(6) "Best available radionuclide control technology" (BARCT) means technology that will result in a radionuclide emission limitation based on the maximum degree of reduction for radionuclides from any proposed newly constructed or significantly modified emission units that the licensing authority determines is achievable on a case-by-case basis. A BARCT compliance demonstration must consider energy, environmental, and economic impacts, and other costs through examination of production processes, and available methods, systems, and techniques for the control of radionuclide emissions. A BARCT compliance demonstration is the conclusion of an evaluative process that results in the selection of the most effective control technology from all known feasible alternatives. In no event shall application of BARCT result in emissions of radionuclides that could exceed the applicable standards of WAC 246-247-040. Control technology that meets BARCT requirements also meets ALARACT requirements. See WAC 173-480-030 and 246-247-120.

(7) "Committed effective dose equivalent" (CEDE) means the sum of the products of absorbed dose from internally deposited radionuclides and appropriate factors to account for differences in biological effectiveness due to the quality of radiation and its distribution in the body of reference man over a fifty-year period.

(8) "Construction" means fabrication, erection, or installation of a new building, structure, plant, process, or operation within a facility that has the potential to emit airborne radionuclides. Construction includes activities of a permanent nature aimed at completion of the emission unit, such as pouring concrete, putting in a foundation, or install-

ing utilities directly related to the emission unit. It does not include preliminary activities such as tests to determine site suitability, equipment procurement and storage, site clearing and grading, and the construction of ancillary buildings.

(9) "Decommissioning" means actions taken to reduce or eliminate the potential public health and safety impacts of a building, structure, or plant that has permanently ceased operations, including, but not limited to, actions such as decontamination, demolition, and disposition.

(10) "Emission unit" means any single location that emits or has the potential to emit airborne radioactive material. This may be a point source, nonpoint source, or source of fugitive emissions.

(11) "Facility" means all buildings, structures, plants, processes, and operations on one contiguous site under control of the same owner or operator.

(12) "Fugitive emissions" are radioactive air emissions which do not and could not reasonably pass through a stack, vent, or other functionally equivalent structure, and which are not feasible to directly measure and quantify.

(13) "Indication device" means any method or apparatus used to monitor, or to enable monitoring, the operation of abatement controls or the potential or actual radioactive air emissions.

(14) "License" means a radioactive air emissions license, either issued by the department or incorporated by the department as an applicable portion of an air operating permit issued by the department of ecology or a local air pollution control authority, with requirements and limitations listed therein to which the licensed or permitted party must comply. Compliance with the license requirements shall be determined and enforced by the department.

(15) "Maximally exposed individual" (MEI) means any member of the public (real or hypothetical) who abides or resides in an unrestricted area, and may receive the highest TEDE from the emission unit(s) under consideration, taking into account all exposure pathways affected by the radioactive air emissions.

(16) "Modification" means any physical change in, or change in the method of operation of, an emission unit that could increase the amount of radioactive materials emitted or may result in the emission of any radionuclide not previously emitted. This definition includes the cleanup of land contaminated with radioactive material, the decommissioning of buildings, structures, or plants where radioactive contamination exists, and changes that will cause an increase in the emission unit's operating design capacity. This definition excludes routine maintenance, routine repair, replacement-in-kind, any increases in the production rate or hours of operation, provided the emission unit does not exceed the release quantities specified in the license application or the operating design capacity approved by the department, addition of abatement technology as long as it is not less environmentally beneficial than existing, approved controls, and changes that result in an increase in the quantity of emissions of an existing radionuclide that will be offset by an equal or greater decrease in the quantity of emissions of another radionuclide that is deemed at least as hazardous with regard to its TEDE to the MEI.

(17) "Monitoring" means the measurement of radioactive material released to the ambient air by means of an in-line radiation detector, and/or by the withdrawal of represen-

tative samples from the effluent stream. Ambient air measurements may be acceptable for nonpoint sources and fugitive emissions.

(18) "Nonpoint source" is a location at which radioactive air emissions originate from an area, such as contaminated ground above a near-surface waste disposal unit, whose extent may or may not be well-defined.

(19) "Notice of construction" (NOC) is an application submitted to the department by an applicant that contains information required by WAC 246-247-060 for proposed construction or modification of a registered emission unit(s), or for modification of an existing, unregistered emission unit(s).

(20) "Point source" is a discrete, well-defined location from which radioactive air emissions originate, such as a stack, vent, or other functionally equivalent structure.

(21) "Potential-to-emit" means the rate of release of radionuclides from an emission unit based on the actual or potential discharge of the effluent stream that would result if all abatement control equipment did not exist, but operations are otherwise normal. Determine the potential-to-emit by one of the following methods:

(a) Multiply the annual possession quantity of each radionuclide by the release fraction for that radionuclide, depending on its physical state. Use the following release fractions:

- (i) 1 for gases;
- (ii)  $10^{-3}$  for liquids or particulate solids; and
- (iii)  $10^{-6}$  for solids.

Determine the physical state for each radionuclide by considering its chemical form and the highest temperature to which it is subjected. Use a release fraction of one if the radionuclide is subjected to temperatures at or above its boiling point; use a release fraction of  $10^{-3}$  if the radionuclide is subjected to temperatures at or above its melting point, but below its boiling point. If the chemical form is not known, use a release fraction of one for any radionuclide that is heated to a temperature of one hundred degrees Celsius or more, boils at a temperature of one hundred degrees Celsius or less, or is intentionally dispersed into the environment. Other release fractions may be used only with the department's approval; or

(b) Perform a back-calculation using measured emission rates and *in situ* measurements of the control equipment efficiencies, as approved by the department; or

(c) Measure the quantities of radionuclides captured in each control device, coupled with *in situ* measurements of the control equipment efficiencies, as approved by the department; or

(d) Sample the effluent upstream from all control devices, as approved by the department; or

(e) Use an alternative method approved by the department.

(22) "Replacement-in-kind" means the substitution of existing systems, equipment, components, or devices of an emission unit's control technology with systems, equipment, components, or devices with equivalent, or better, performance specifications that will perform the same function(s).

(23) "Routine" means:

(a) Maintenance, repair, or replacement-in-kind performed on systems, equipment, components, or devices of an emission unit's abatement technology as a planned part of an

established inspection, maintenance, or quality assurance program that does not increase the emission unit's operating design capacity; or

(b) Normal, day-to-day operations of a facility.

(24) "Sealed source" means radioactive material that is permanently bonded or fixed in a capsule or matrix, or radioactive material in airtight containers, designed to prevent release and dispersal of the radioactive material under the most severe conditions encountered in normal use and handling.

(25) "Significant" means the potential-to-emit airborne radioactivity at a rate that could increase the TEDE to the MEI by at least 1.0 mrem/yr as a result of a proposed modification.

(26) "Total effective dose equivalent" (TEDE) means the sum of the dose equivalent due to external exposures and the CEDE due to internal exposures.

(27) "Uranium fuel cycle" means the operations of milling uranium ore, chemical conversion of uranium, isotopic enrichment of uranium, fabrication of uranium fuel, generation of electricity in a nuclear power plant that uses uranium fuel, and reprocessing of spent uranium fuel, to the extent that these operations solely support the production of electrical power for public use. Excluded are mining operations, waste disposal sites, transportation of any radioactive material, and the reuse of recovered nonuranium special nuclear and by-product materials from the cycle.

[Statutory Authority: Chapters 70.98 and 70.94 RCW and chapter 173-480 WAC. 94-07-010, § 246-247-030, filed 3/4/94, effective 4/4/94. Statutory Authority: RCW 43.70.040. 91-02-049 (Order 121), recodified as § 246-247-030, filed 12/27/90, effective 1/31/91. Statutory Authority: Chapter 70.98 RCW. 88-17-060 (Order 2671), § 402-80-040, filed 8/17/88. Statutory Authority: RCW 70.98.080. 87-01-031 (Order 2450), § 402-80-040, filed 12/11/86.]

**WAC 246-247-040 Standards.** (1) Standards for radioactive air emissions in the state of Washington are contained in WAC 173-480-040, 173-480-050, and 173-480-060 and in 40 CFR Part 61, subparts H and I published in the *Federal Register* on December 15, 1989. In accordance with WAC 173-480-050(3), the department shall enforce the most stringent standard in effect, notwithstanding any agreement between EPA and any other agency, including those agreements made pursuant to 42 USC 7412(d)(9).

(2) In addition to the radioactive air emission standards of subsection (1) of this section, the department's radioactive materials licensees shall comply with the limitations on radioactive air emissions contained in WAC 246-221-070.

(3) All new construction and significant modifications of emission units commenced after August 10, 1988 (the date this chapter originally became effective) shall utilize BARCT (see Appendix B).

(4) All existing emission units and nonsignificant modifications shall utilize ALARACT (see Appendix C).

(5) In order to implement these standards, the department may set limits on emission rates for specific radionuclides from specific emission units and/or set requirements and limitations on the operation of the emission unit(s) as specified in a license.

(6) All emissions of radionuclides, including those due to emergency conditions resulting from startup, shutdown, maintenance activities, or process upsets are subject to the

standards of this section and, therefore, subject to the enforcement actions of WAC 246-247-100.

[Statutory Authority: Chapters 70.98 and 70.94 RCW and chapter 173-480 WAC. 94-07-010, § 246-247-040, filed 3/4/94, effective 4/4/94. Statutory Authority: RCW 43.70.040. 91-02-049 (Order 121), recodified as § 246-247-040, filed 12/27/90, effective 1/31/91. Statutory Authority: RCW 70.98.080. 87-01-031 (Order 2450), § 402-80-050, filed 12/11/86.]

**WAC 246-247-060 Applications, registration and licensing.** This section describes the information requirements for approval to construct, modify, and operate an emission unit. Any notice of construction (NOC) requires the submittal of the information listed in Appendix A. Complex projects may require additional information. The applicant should contact the department early in the conceptual design phase for guidance on applicable control technologies to consider.

Appendices B and C outline the procedures to demonstrate compliance with the BARCT and ALARACT standards. Based on the Appendix A information provided, the department may advise the applicant which subset of technologies to consider as candidates for meeting BARCT or ALARACT requirements.

For those facilities subject to the operating permit regulations in chapter 173-401 WAC, the radioactive air emissions license will be incorporated as an applicable portion of the air operating permit issued by the department of ecology or a local air pollution control authority. The department will be responsible for determining the facility's compliance with and enforcing the requirements of the radioactive air emissions license.

(1) Requirements for new construction or modification of emission units.

(a) Early in the design phase, the applicant shall submit a NOC containing the information required in Appendix A.

(b) Within thirty days of receipt of the NOC, the department shall inform the applicant if additional information is required. The department may determine, on the basis of the information submitted, that the requirements of BARCT or ALARACT have been met, or may require the applicant to submit a BARCT or ALARACT demonstration compatible with Appendix B or C, respectively.

(c) Within sixty days of receipt of all required information, the department shall issue an approval or denial to construct. The department may require changes to the final proposed control technology.

(d) The applicant may request a phased approval process by so stating and submitting a limited application. The department may grant a conditional approval to construct for such activities as would not preclude the construction or installation of any control or monitoring equipment required after review of the completed application.

(e) The department shall issue a license, or amend an existing license, authorizing operation of the emission unit(s) when the proposed new construction or modification is complete. For facilities subject to the air operating permit requirements of chapter 173-401 WAC, the license shall become part of the air operating permit issued by the department of ecology or a local air pollution control authority. For new construction, this action shall constitute registration of the emission unit(s).

(2) Requirements for modification of unregistered emission units that are not exempt from these regulations.

(a) The applicant shall submit an application containing the information required in Appendix A.

(b) Within thirty days of receipt of the application, the department shall inform the applicant if additional information is required. The department may determine, on the basis of the information submitted, that the requirements of BARCT or ALARACT have been met, or may require the applicant to submit a BARCT or ALARACT demonstration compatible with Appendix B or C, respectively.

(c) Within sixty days of receipt of all required information, the department shall issue or amend the license. For facilities subject to the air operating permit requirements of chapter 173-401 WAC, the license shall become part of the air operating permit issued by the department of ecology or a local air pollution control authority. This action shall constitute registration of the emission unit(s). A determination of noncompliance may result in the issuance of a notice of violation.

(d) The department reserves the right to require the owner of an existing, unregistered emission unit to make modifications necessary to comply with the applicable standards of WAC 246-247-040.

(3) If an emission unit is in violation of any standards contained in WAC 246-247-040, the facility shall either submit a compliance plan which describes how it intends to achieve compliance with the standards, and/or cease operation of the emission unit(s). The facility shall submit the compliance plan within forty-five days of the notice of violation. The cessation of operation of the emission unit(s) shall not necessarily exempt the facility from the requirements of this chapter if active or passive ventilation and radioactive air emission controls will still be required. The department reserves the right to take further enforcement action, if necessary, in accordance with WAC 246-247-100.

(4) The facility shall notify the department at least seven calendar days prior to any planned preoperational tests of new or modified emission units that involve emissions control, monitoring, or containment systems of the emission unit(s). The department reserves the right to witness or require preoperational tests involving the emissions control, monitoring, or containment systems of the emission unit(s).

(5) The license shall specify the requirements and limitations of operation to assure compliance with this chapter. The facility shall comply with the requirements and limitations of the license.

(6) All radioactive air emissions licenses issued by the department, except those issued to radioactive materials licensees, shall have an expiration date of five years from date of issuance or as specified in the air operating permit. For radioactive material licensees, the requirements and limitations for the operation of emission units shall be incorporated into their radioactive materials license, and shall expire when the radioactive materials license expires.

(7) Each federal facility that comes under the authority of this chapter shall hold one license for each site, base, or installation. When applicable, the license shall be part of the facility's air operating permit.

(8) Facilities may request a single categorical license which identifies limits and conditions of operation for similar multipurpose temporary and/or portable emission units.

When applicable, the license shall be part of the facility's air operating permit.

(9) All facilities with licensed emission units, except for radioactive materials licensees, shall submit a request to the department for renewal of their radioactive air emissions license at least sixty days prior to expiration of the license or as required by the air operating permit. All renewal requests shall include a summary of the operational status of all emission units, the status of facility compliance with the standards of WAC 246-247-040, and the status of any corrective actions necessary to achieve compliance with the requirements of this chapter. Facilities with licensed emission units that also hold a radioactive materials license issued by the department shall submit this information along with their radioactive material license renewal submittal. If the department is unable to renew a radioactive air emissions license before its expiration date, the existing license, with all of its requirements and limitations, remains in force until the department either renews or revokes the license.

(10) For commercial nuclear power plants or any other thermal energy facility subject to chapter 80.50 RCW and to the requirements of this chapter, the radioactive air emissions license and amendments thereto shall be issued pursuant to a memorandum of agreement between the energy facility site evaluation council (EFSEC) and the department.

[Statutory Authority: Chapters 70.98 and 70.94 RCW and chapter 173-480 WAC. 94-07-010, § 246-247-060, filed 3/4/94, effective 4/4/94. Statutory Authority: RCW 43.70.040. 91-02-049 (Order 121), recodified as § 246-247-060, filed 12/27/90, effective 1/31/91. Statutory Authority: Chapter 70.98 RCW. 88-17-060 (Order 2671), § 402-80-065, filed 8/17/88.]

**WAC 246-247-065 Fees.** (1) All facilities under the authority of this chapter shall submit fees in accordance with WAC 246-254-160.

(2) Those facilities required by WAC 246-254-160(2) to submit an application fee, shall submit the fee with the application.

[Statutory Authority: Chapters 70.98 and 70.94 RCW and chapter 173-480 WAC. 94-07-010, § 246-247-065, filed 3/4/94, effective 4/4/94.]

**WAC 246-247-075 Monitoring, testing and quality assurance.** (1) All radioactive air emissions monitoring, testing, and quality assurance requirements of 40 CFR 61, Subparts H and I published in the *Federal Register* on December 15, 1989, are adopted by reference, as applicable as specified by the referenced subparts.

(2) Equipment and procedures used for the continuous monitoring of radioactive air emissions shall conform, as applicable, to the guidance contained in ANSI N13.1, ANSI N42.18, ANSI N323, ANSI N317, reference methods 1, 1A, 2, 2A, 2C, 2D, 4, 5, and 17 of 40 CFR Part 60, Appendix A, 40 CFR Part 52, Appendix E, and any other methods approved by the department.

(3) The operator of an emission unit with a potential-to-emit of less than 0.1 mrem/yr TEDE to the MEI may estimate those radionuclide emissions, in lieu of monitoring, in accordance with 40 CFR 61 Appendix D, or other procedure approved by the department. The department may require periodic confirmatory measurements (e.g., grab samples) during routine operations to verify the low emissions. Methods to implement periodic confirmatory monitoring shall be approved by the department.

(4) The department may allow a facility to use alternative monitoring procedures or methods if continuous monitoring is not a feasible or reasonable requirement.

(5) The following types of facilities shall determine radionuclide emissions in accordance with either a methodology referenced in subsections (1) through (4) of this section or the respective document referenced below:

(a) Nuclear power reactors licensed by the NRC: Offsite Dose Calculation Manual;

(b) Fuel fabrication plants licensed by the NRC: NRC's Regulatory Guide 4.16, dated December 1985;

(c) Uranium mills that are processing material: NRC's Regulatory Guide 4.14, dated April 1980.

(6) Licensed facilities shall conduct and document a quality assurance program. Except for those types of facilities specified in subsection (5) of this section, the quality assurance program shall be compatible with applicable national standards such as ANSI/ASME NQA-1-1988, ANSI/ASME NQA-2-1986, QAMS-004, and QAMS-005.

(7) Those types of facilities specified in subsection (5) of this section shall conduct and document a quality assurance program compatible with either the applicable national standards referenced in subsection (6) of this section or the NRC's Regulatory Guide 4.15, dated February 1979.

(8) Facilities shall monitor nonpoint and fugitive emissions of radioactive material.

(9) The department may conduct an environmental surveillance program to ensure that radiation doses to the public from emission units are in compliance with applicable standards. The department may require the operator of any emission unit to conduct stack sampling, ambient air monitoring, or other testing as necessary to demonstrate compliance with the standards in WAC 246-247-040.

(10) The department may require the owner or operator of an emission unit to make provision, at existing emission unit sampling stations, for the department to take split or collocated samples of the emissions.

(11) The planning for any proposed new construction or significant modification of the emission unit must address accidental releases with a probability of occurrence during the expected life of the emission unit of greater than one percent.

(12) All facilities must be able to demonstrate that appropriate supervisors and workers are adequately trained in the use and maintenance of emission control and monitoring systems, and in the performance of associated test and emergency response procedures.

(13) All facilities must be able to demonstrate the reliability and accuracy of the radioactive air emissions monitoring data.

[Statutory Authority: Chapters 70.98 and 70.94 RCW and chapter 173-480 WAC. 94-07-010, § 246-247-075, filed 3/4/94, effective 4/4/94.]

**WAC 246-247-080 Inspections, reporting, and recordkeeping.** (1) The department reserves the right to inspect and audit all construction activities, equipment, operations, documents, data, and other records related to compliance with the requirements of this chapter. The department may require a demonstration of ALARACT at any time.

(2) All reporting and recordkeeping requirements of 40 CFR 61, Subparts H and I published in the *Federal Register* on December 15, 1989, are adopted by reference, as applicable as specified by the referenced subparts.

(3) The facility shall annually submit to the department the information requirements adopted in subsection (2) of this section, as applicable, along with the following additional information, as applicable:

(a) The results of emission measurements for those emission units subject only to periodic confirmatory measurements;

(b) Wind rose or joint frequency table;

(c) Annual average ambient temperature;

(d) Annual average emission unit gas temperature, if available;

(e) Annual total rainfall;

(f) Annual average emission unit flow rate and total volume of air released during the calendar year.

If this additional information is available in another annual report, the facility may instead provide a copy of that report along with the information requirements in this subsection. Annual reports are due by June 30 for the previous calendar year's operations.

(4) Any report or application that contains proprietary or procurement-sensitive information shall be submitted to the department with those portions so designated. The department shall hold this information confidential, unless required to release the information pursuant to laws, regulations, or court order.

(5) The facility shall notify the department within twenty-four hours of any shutdown, or of any transient abnormal condition lasting more than four hours or other change in facility operations which, if allowed to persist, would result in emissions of radioactive material in excess of applicable standards or license requirements. If requested by the department, the facility shall submit a written report within ten days including known causes, corrective actions taken, and any preventive measures taken or planned to minimize or eliminate the chance of recurrence.

(6) The facility shall file a report of closure with the department whenever operations producing emissions of radioactive material are permanently ceased at any emission unit (except temporary emission units) regulated under this chapter. The closure report shall indicate whether, despite cessation of operations, there is still a potential for radioactive air emissions and a need for an active or passive ventilation system with emission control and/or monitoring devices. If decommissioning is planned and will constitute a modification, a NOC is required, as applicable, in accordance with WAC 246-247-060.

(7) The facility shall maintain a log for each emission unit that has received categorical approval under WAC 246-247-060(8). The log shall contain records of important operations parameters including the date, location, and duration of the release, measured or calculated radionuclide concentrations, the type of emissions (liquid, gaseous, solid), and the type of emission control and monitoring equipment.

(8) The facility shall maintain readily retrievable storage areas for all records and documents related to, and which may help establish compliance with, the requirements of this chapter. The facility shall keep these records available for department inspection for at least five years.



(9) The facility shall ensure all emission units are fully accessible to department inspectors. In the event the hazards associated with accessibility to a unit require training and/or restrictions or requirements for entry, the facility owner or operator shall inform the department, prior to arrival, of those restrictions or requirements. The owner or operator shall be responsible for providing the necessary training, escorts, and support services to allow the department to inspect the facility.

(10) The facility shall make available, in a timely manner, all documents requested by the department for review. The facility shall allow the department to review documents in advance of an inspection. The facility shall allow access to classified documents by representatives of the department with the appropriate security clearance and a demonstrable need-to-know.

(11) The facility shall respond in writing in a timely manner, or within a time limit set by the department, to inspection results which require the facility to implement corrective actions or any other actions so directed by the department.

[Statutory Authority: Chapters 70.98 and 70.94 RCW and chapter 173-480 WAC. 94-07-010, § 246-247-080, filed 3/4/94, effective 4/4/94. Statutory Authority: RCW 43.70.040. 91-02-049 (Order 121), recodified as § 246-247-080, filed 12/27/90, effective 1/31/91. Statutory Authority: RCW 70.98.080. 87-01-031 (Order 2450), § 402-80-080, filed 12/11/86.]

**WAC 246-247-085 Compliance determination for existing emission units and facilities.** (1) All procedures for determining compliance with the dose equivalent standards of 40 CFR 61, Subparts H and I published in the *Federal Register* on December 15, 1989, are adopted by reference, as applicable as specified by the referenced subparts.

(2) Facilities subject to 40 CFR 61 shall use computer codes or procedures approved by the EPA to determine the TEDE to the MEI; all other facilities shall use computer codes or procedures approved by the department.

(3) The determination of compliance with the dose equivalent standard of WAC 246-247-040 shall include all radioactive air emissions resulting from routine and nonroutine operations for the past calendar year.

[Statutory Authority: Chapters 70.98 and 70.94 RCW and chapter 173-480 WAC. 94-07-010, § 246-247-085, filed 3/4/94, effective 4/4/94.]

**WAC 246-247-100 Enforcement actions.** (1) In accordance with RCW 70.94.422, the department may take any of the following actions to enforce compliance with the provisions of this chapter:

(a) Notice of violation and compliance order (RCW 70.94.332).

(b) Restraining order or temporary or permanent injunction (RCW 70.94.425; also RCW 70.98.140).

(c) Penalty: Fine and/or imprisonment (RCW 70.94.430).

(d) Civil penalty: Up to ten thousand dollars for each day of continued noncompliance (RCW 70.94.431 (1) through (7)).

(e) Assurance of discontinuance (RCW 70.94.435).

(2) The department, in accordance with RCW 70.98.050(4)(1), may issue subpoenas in order to compel attendance of witnesses and/or production of records or

documents in connection with any adjudicative or other administrative proceeding.

(3) The department, in accordance with RCW 70.98.160, may impound sources of ionizing radiation.

(4) The secretary of the department, in accordance with RCW 43.70.190, is authorized to bring an action to prohibit a violation or a threatened violation of any department rules or regulation, or to bring any legal proceeding authorized by law to a county superior court.

(5) Any party, against which an enforcement action is brought by the department, has the right to submit an application for the adjudicative process in accordance with chapter 246-10 WAC and chapter 34.05 RCW.

[Statutory Authority: Chapters 70.98 and 70.94 RCW and chapter 173-480 WAC. 94-07-010, § 246-247-100, filed 3/4/94, effective 4/4/94. Statutory Authority: RCW 43.70.040. 91-02-049 (Order 121), recodified as § 246-247-100, filed 12/27/90, effective 1/31/91. Statutory Authority: RCW 70.98.080. 87-01-031 (Order 2450), § 402-80-100, filed 12/11/86.]

**WAC 246-247-110 Appendix A—Application information requirements.** (1) Name and address of the facility, and location (latitude and longitude) of the emission unit(s).

(2) Name, title, address, and phone number of the responsible manager.

(3) Identify the type of proposed action for which this application is submitted:

(a) Construction of new emission unit(s);

(b) Modification of existing emission unit(s); identify whether this is a significant modification;

(c) Modification of existing unit(s), unregistered.

(4) If this project is subject to the requirements of the State Environmental Policy Act (SEPA) contained in chapter 197-11 WAC, provide the name of the lead agency, lead agency contact person, and their phone number.

(5) Describe the chemical and physical processes upstream of the emission unit(s).

(6) Describe the existing and proposed (as applicable) abatement technology. Describe the basis for the use of the proposed system. Include expected efficiency of each control device, and the annual average volumetric flow rate(s) in meters<sup>3</sup>/sec for the emission unit(s).

(7) Provide conceptual drawings showing all applicable control technology components from the point of entry of radionuclides into the vapor space to release to the environment.

(8) Identify each radionuclide that could contribute greater than ten percent of the potential-to-emit TEDE to the MEI, or greater than 0.1 mrem/yr potential-to-emit TEDE to the MEI.

(9) Describe the effluent monitoring system for the proposed control system. Describe each piece of monitoring equipment and its monitoring capability, including detection limits, for each radionuclide that could contribute greater than ten percent of the potential-to-emit TEDE to the MEI, or greater than 0.1 mrem/yr potential-to-emit TEDE to the MEI, or greater than twenty-five percent of the TEDE to the MEI, after controls. Describe the method for monitoring or calculating those radionuclide emissions. Describe the method with detail sufficient to demonstrate compliance with the applicable requirements.



(10) Indicate the annual possession quantity for each radionuclide.

(11) Indicate the physical form of each radionuclide in inventory: Solid, particulate solids, liquid, or gas.

(12) Indicate the release form of each radionuclide in inventory: Particulate solids, vapor, or gas. Give the chemical form and ICRP 30 solubility class, if known.

(13) Release rates.

(a) New emission unit(s): Give predicted release rates without any emissions control equipment (the potential-to-emit) and with the proposed control equipment using the efficiencies described in subsection (6) of this section.

(b) Modified emission unit(s): Give predicted release rates without any emissions control equipment (the potential-to-emit) and with the existing and proposed control equipment using the efficiencies described in subsection (6) of this section. Provide the latest year's emissions data or emissions estimates.

In all cases, indicate whether the emission unit is operating in a batch or continuous mode.

(14) Identify the MEI by distance and direction from the emission unit(s). The MEI is determined by considering distance, windrose data, presence of vegetable gardens, and meat or milk producing animals at unrestricted areas surrounding the emission unit.

(15) Calculate the TEDE to the MEI using an approved procedure (see WAC 246-247-085). For each radionuclide identified in subsection (8) of this section, determine the TEDE to the MEI for existing and proposed emission controls, and without any emission controls (the potential-to-emit) using the release rates from subsection (13) of this section. Provide all input data used in the calculations.

(16) Provide cost factors for construction, operation, and maintenance of the proposed control technology components and system, if a BARCT or ALARACT demonstration is not submitted with the NOC.

(17) Provide an estimate of the lifetime for the facility process with the emission rates provided in this application.

(18) Indicate which of the following control technology standards have been considered and will be complied with in the design and operation of the emission unit(s) described in this application:

**ASME/ANSI AG-1**, Code on Nuclear Air and Gas Treatment (where there are conflicts in standards with the other listed references, this standard shall take precedence)

**ASME/ANSI N509**, Nuclear Power Plant Air-Cleaning Units and Components

**ASME/ANSI N510**, Testing of Nuclear Air Treatment Systems

**ANSI/ASME NQA-1**, Quality Assurance Program Requirements for Nuclear Facilities

**40 CFR 60, Appendix A**, Methods 1, 1A, 2, 2A, 2C, 2D, 4, 5, and 17

**ANSI N13.1**, Guide to Sampling Airborne Radioactive Materials in Nuclear Facilities

For each standard not so indicated, give reason(s) to support adequacy of the design and operation of the emission unit(s) as proposed.

[Statutory Authority: Chapters 70.98 and 70.94 RCW and chapter 173-480 WAC. 94-07-010, § 246-247-110, filed 3/4/94, effective 4/4/94.]

**WAC 246-247-120 Appendix B—BARCT compliance demonstration. Purpose.** A BARCT demonstration is used to choose control technologies for the mitigation of emissions of radioactive material from new emission units or significant modifications to emission units. The bases for the BARCT demonstration requirements are the BARCT standard given in WAC 246-247-040, and the definition of BARCT given in WAC 246-247-030. This procedure incorporates certain implementing criteria that enable the department to evaluate a facility's compliance with the BARCT standard. It is the applicant's responsibility to demonstrate the effectiveness of their BARCT determination to the department. The facility should contact the department at the conceptual design phase for guidance on the BARCT demonstration requirements. The department may adjust this demonstration procedure on a case-by-case basis, as needed, to ensure compliance with the substantive standard.

**Scope.** The BARCT demonstration includes the abatement technology and indication devices that demonstrate the effectiveness of the abatement technology from entry of radionuclides into the ventilated vapor space to release to the environment. The applicant shall evaluate all available control technologies that can reduce the level of radionuclide emissions.

**Technology Standards.** The BARCT demonstration and the emission unit design and construction must meet, as applicable, the technology standards shown below if the unit's potential-to-emit exceeds 0.1 mrem/yr TEDE to the MEI. If the potential-to-emit is below this value, the standards must be met only to the extent justified by a cost/benefit evaluation.

**ASME/ANSI AG-1**, Code on Nuclear Air and Gas Treatment (where there are conflicts in standards with the other listed references, this standard shall take precedence)

**ASME/ANSI N509**, Nuclear Power Plant Air-Cleaning Units and Components

**ASME/ANSI N510**, Testing of Nuclear Air Treatment Systems

**ANSI/ASME NQA-1**, Quality Assurance Program Requirements for Nuclear Facilities

**40 CFR 60, Appendix A**, Methods 1, 1A, 2, 2A, 2C, 2D, 4, 5, and 17

**ANSI N13.1**, Guide to Sampling Airborne Radioactive Materials in Nuclear Facilities

The following standards and references are recommended as guidance only:

**ANSI/ASME NQA-2**, Quality Assurance Requirements for Nuclear Facilities

**ANSI N42.18**, Specification and Performance of On-Site Instrumentation for Continuously Monitoring Radioactivity in Effluents

**ERDA 76-21**, Nuclear Air Cleaning Handbook

**ACGIH 1988**, Industrial Ventilation, A Manual of Recommended Practice, 20th ed., American Conference of Governmental Industrial Hygienists

**BARCT Demonstration Procedure.**

**Step 1. Define facility process variables.** Describe the physical and chemical process. Include the potential radionuclide release rates (by isotope, in units of curies/year), process variables (such as flow rate, temperature, humidity, chemical composition), and other technical

considerations. Base the radionuclide release rate on the potential-to-emit.

Radionuclides selected for consideration in the BARCT demonstration shall include those which contribute more than ten percent of the potential TEDE to the MEI or more than 0.1 mrem/yr, and any others which the department determines are necessary.

**Step 2. Gather information on all available control technologies.** Search for all available technologies that can reduce the emissions levels for the radionuclides selected in Step 1. Sources of information shall include previous BARCT demonstrations, regulatory authorities, industry or regulatory agency data bases, literature searches, information from technology vendors, research and development reports, and any other means necessary to identify all available technologies. "Available technology" includes any technology that is commercially available. Recently completed searches may be used with department approval.

**Step 3. Determine technical feasibility.** Determine technical feasibility by evaluating vendor specifications for available control technologies identified in Step 2 with respect to the process variables identified in Step 1. Evaluate combinations of abatement technology and control devices by component, and the system as a whole.

If a control technology has poor safety, reliability, or control effectiveness as achieved in practice under the proposed process conditions, or the technology is not applicable to the emission unit under consideration, the technology may be eliminated with supporting documentation of the technical infeasibility.

**Step 4. List all feasible control technologies in order of effectiveness.** Evaluate feasible control technologies for efficiency (effectiveness) in reducing the TEDE to the MEI. List them in order, with the most effective first. If the most effective feasible technology is proposed as BARCT, the demonstration is complete at this step.

**Step 5. Evaluate the environmental, energy, and economic impacts.** Evaluate each control technology in succession, beginning with the most effective. Present an objective evaluation considering both beneficial and adverse impacts. Quantify the data where possible. Impact cost and effectiveness evaluations are incremental and include only that portion of the facility which comes under the authority of this chapter. Evaluate at least the following impacts:

**Environmental impact** - Determine the incremental environmental impact, both beneficial and adverse. Evaluate the beneficial impact of reduction in the TEDE to the surrounding population or, at a minimum, to the MEI due to the abatement of radioactive air emissions. Consider the adverse impacts from waste generation (radioactive and nonradioactive, air and nonair), disposal and stabilization, construction of control equipment, and the health and safety to both radiation workers and the general public.

**Energy impact** - Determine the incremental energy impact. Include the impact of any resulting need for new services such as energy distribution systems.

**Economic impact** - Determine the incremental economic impact. Determine capital and expense costs including design, development, procurement, construction, operation, maintenance, taxes, waste disposal, and any other applicable financial components. Base all costs on the expected

lifetime of the emission unit and reduce to an annualized cost for evaluation and comparison.

The adverse economic impact compared to the beneficial impact, including reduction in TEDE to the surrounding population or the MEI, is a measure of the cost versus benefit for the control technology evaluated.

The most effective technology may be eliminated from consideration if the applicant can demonstrate to the department's satisfaction that the technology has unacceptable impacts. State clearly the basis for this conclusion and proceed to the next most effective control technology. If the next most effective technology is proposed as BARCT, the demonstration is complete; otherwise, evaluate the control technology for impacts in accordance with this step.

If the control technology cannot be eliminated on the basis of its impacts, it is proposed as BARCT.

**Reporting.** Prepare a BARCT compliance demonstration report for department review. Provide sufficient information such that the department can validate essential results. If no control technology is feasible, and/or emissions are unacceptable, the department reserves the right to prohibit the construction and operation of the emission unit(s).

[Statutory Authority: Chapters 70.98 and 70.94 RCW and chapter 173-480 WAC. 94-07-010, § 246-247-120, filed 3/4/94, effective 4/4/94.]

**WAC 246-247-130 Appendix C—ALARACT compliance demonstration. Purpose.** An ALARACT demonstration is used for inspection or audit purposes, and to demonstrate compliance with the substantive ALARACT technology standard as required by this chapter. An ALARACT demonstration is used to evaluate the adequacy of control technology on existing emission units and to choose control technologies for proposed nonsignificant modifications of emission units. The bases for the ALARACT demonstration requirements are the ALARACT standards given in WAC 246-247-040 and the definition of ALARACT given in WAC 246-247-030. It is the applicant's responsibility to demonstrate the effectiveness of their ALARACT determination to the department. The department may adjust this demonstration procedure on a case-by-case basis, as needed, to ensure compliance with the substantive standard.

**Scope.** The ALARACT demonstration includes the abatement technology and indication devices, from entry of radionuclides into the ventilated vapor space to release to the environment. The facility shall evaluate the existing control system in relation to applicable technology standards, and other control technologies that have been successfully operated for similar applications.

**Technology Standards.** The ALARACT demonstration and the emission unit design and construction must meet, as applicable, the technology standards shown below if the unit's potential-to-emit exceeds 0.1 mrem/yr TEDE to the MEI. If the potential-to-emit is below this value, the standards must be met only to the extent justified by a cost/benefit evaluation.

**ASME/ANSI AG-1, Code on Nuclear Air and Gas Treatment** (where there are conflicts in standards with the other listed references, this standard shall take precedence)

ASME/ANSI N509, Nuclear Power Plant Air-Cleaning Units and Components

ASME/ANSI N510, Testing of Nuclear Air Treatment Systems

ANSI/ASME NQA-1, Quality Assurance Program Requirements for Nuclear Facilities

40 CFR 60, Appendix A, Methods 1, 1A, 2, 2A, 2C, 2D, 4, 5, and 17

ANSI N13.1, Guide to Sampling Airborne Radioactive Materials in Nuclear Facilities

The following standards and references are recommended as guidance only:

ANSI/ASME NQA-2, Quality Assurance Requirements for Nuclear Facilities

ANSI N42.18, Specification and Performance of On-Site Instrumentation for Continuously Monitoring Radioactivity in Effluents

ERDA 76-21, Nuclear Air Cleaning Handbook

ACGIH 1988, Industrial Ventilation, A Manual of Recommended Practice, 20th ed., American Conference of Governmental Industrial Hygienists

ALARA References. "Health Physics Manual of Good Practice for Reducing Radiation Exposure to Levels that are As Low As Reasonably Achievable (ALARA)", PNL-6577, June, 1988; prepared for the USDOE by Pacific Northwest Laboratories (Battelle Memorial Institute).

"A Guide to Reducing Radiation Exposure to As Low As Reasonably Achievable (ALARA)", DOE/EV/1830-T5, April, 1980, R.L. Kathren and J.M. Selby; prepared for the USDOE by Pacific Northwest Laboratories (Battelle Memorial Institute).

"A Practical Method of Performing Cost-Benefit Analysis of Occupational and Environmental Protective Measures", WHC-SA-0484-FP, March, 1989, G.F. Boothe and D.E. Webb; prepared for the USDOE by Westinghouse Hanford Company.

[Statutory Authority: Chapters 70.98 and 70.94 RCW and chapter 173-480 WAC. 94-07-010, § 246-247-130, filed 3/4/94, effective 4/4/94.]

## Chapter 246-249 WAC

### RADIOACTIVE WASTE—USE OF THE COMMERCIAL DISPOSAL SITE

#### WAC

246-249-001	Purpose and scope.
246-249-010	Definitions.
246-249-020	Site use permit.
246-249-030	Waste shipment certification.
246-249-040	Classification of radioactive waste for near-surface disposal.
246-249-050	Acceptable radioactive waste forms and packaging.
246-249-060	Labeling.
246-249-070	Variations.
246-249-080	Naturally occurring and accelerator produced radioactive material (NARM), excluding source material.
246-249-090	Transfer for disposal and manifests.

**WAC 246-249-001 Purpose and scope.** This chapter provides rules governing generators and brokers of low-level radioactive waste seeking to dispose of such waste at any commercial disposal facility in the state of Washington. These rules are in addition to applicable requirements of the United States Nuclear Regulatory Commission (NRC), the

[Title 246 WAC—page 324]

United States Department of Transportation (DOT), and other requirements of Title 246 WAC, the requirements of the department of ecology, Title 173 WAC, and conditions of the license issued to the disposal site operator(s).

[Statutory Authority: RCW 70.98.050 and 70.98.080. 91-16-109 (Order 187), § 246-249-001, filed 8/7/91, effective 9/7/91. Statutory Authority: RCW 43.70.040. 91-02-049 (Order 121), recodified as § 246-249-001, filed 12/27/90, effective 1/31/91. Statutory Authority: RCW 70.98.080. 87-01-031 (Order 2450), § 402-62-010, filed 12/11/86.]

**WAC 246-249-010 Definitions.** As used in this chapter, the following definitions apply:

(1) "Low-level radioactive waste" has the same meaning as in the Low-Level Radioactive Waste Policy Amendments Act of 1985, Public Law 99-240, that is, radioactive waste not classified as high-level radioactive waste, spent nuclear fuel, or by-product material as defined in section 11e.(2) of the Atomic Energy Act.

(2) "Broker" means a person who performs one or more of the following functions for a low-level radioactive waste generator:

(a) Arranges for transportation of the low-level radioactive waste;

(b) Collects and/or consolidates shipments of such low-level radioactive waste;

(c) Processes such low-level radioactive waste in some manner; provided it shall not mean a carrier whose sole function is to transport such low-level radioactive waste.

(3) "Shipper" or "consignor" means the last licensee to possess the low-level radioactive waste prior to transportation to the low-level radioactive waste disposal site, normally the generator when no broker is involved; otherwise, the broker.

(4) "Generator" means the last person who puts radioactive material to practical use, and who then declares it to be no longer of use or value.

(5) "Motor vehicle" means any vehicle, truck, tractor, semi-trailer, or trailer (or any permitted combination of these), driven by mechanical power and used upon the highways to carry property.

(6) "Motor common carrier" means a person holding itself out to the general public to provide motor vehicle transportation for compensation over regular or irregular routes, or both.

(7) "Motor contract carrier" means a person other than a common carrier providing motor vehicle transportation of property for compensation under continuing agreements with one or more persons.

(8) "Motor private carrier" means a person, other than a motor carrier, transporting property by motor vehicle when the person is the owner, lessee, or bailee of the property being transported; and the property is being transported for sale, lease, rent, or bailment, or to further a commercial enterprise.

(9) "Motor carrier" means a motor common carrier and a motor contract carrier.

(10) "Shipment" means the total low-level radioactive waste material transported in one motor vehicle.

(11) "Transuranic waste" means material contaminated with elements that have an atomic number greater than 92.

[Statutory Authority: RCW 70.98.050 and 70.98.080. 91-16-109 (Order 187), § 246-249-010, filed 8/7/91, effective 9/7/91. Statutory Authority:

RCW 43.70.040. 91-02-049 (Order 121), recodified as § 246-249-010, filed 12/27/90, effective 1/31/91. Statutory Authority: RCW 70.98.080. 87-01-031 (Order 2450), § 402-62-020, filed 12/11/86.]

**WAC 246-249-020 Site use permit.** (1) Each generator and each broker of radioactive waste shall possess a valid and unencumbered site use permit prior to the shipment of such waste to, or the disposal of such waste at any commercial disposal facility in the state of Washington and shall have complied with the permit requirements of the department of ecology.

(2) Suspension or revocation of permit.

(a) The failure of one or more packages in a shipment of waste to be in compliance with one or more of the requirements of the license issued to the commercial low-level radioactive waste disposal site operator, Title 246 WAC, the United States Nuclear Regulatory Commission, the United States Department of Transportation, or conditions of the disposal site operator's radioactive materials license may cause the suspension of the site use permit of the responsible generator and/or broker.

(b) The site use permit of a generator and/or broker may be suspended or revoked if any other licensed commercial low-level radioactive waste disposal site in the United States has refused to accept waste from that generator or broker.

(c) A suspended site use permit may be reinstated provided:

(i) The generator and/or broker submits a quality assurance procedure designed to correct previous problems and to achieve and maintain compliance with all applicable requirements; and

(ii) A point-of-origin inspection by the state of Washington, of the generator's and/or broker's waste management activities, indicates compliance with all applicable requirements and regulations.

(3) Brokered shipments.

(a) It is the broker's responsibility to assure that a generator of waste has a valid unencumbered site use permit prior to shipment of waste for disposal.

(b) A broker, as consignor, assumes coresponsibility with a generator for all aspects of that generator's waste until it can be documented to the department's satisfaction that the broker's sphere of responsibility was limited.

[Statutory Authority: Chapter 70.98 RCW. 95-13-094, § 246-249-020, filed 6/21/95, effective 7/22/95. Statutory Authority: RCW 70.98.050 and 70.98.080. 91-16-109 (Order 187), § 246-249-020, filed 8/7/91, effective 9/7/91. Statutory Authority: RCW 43.70.040. 91-02-049 (Order 121), recodified as § 246-249-020, filed 12/27/90, effective 1/31/91. Statutory Authority: RCW 70.98.080. 87-01-031 (Order 2450), § 402-62-030, filed 12/11/86.]

**WAC 246-249-030 Waste shipment certification.**

(1) A low-level radioactive waste shipment certification, Form RHF-31, must accompany each shipment of radioactive waste to a licensed low-level radioactive waste burial site. All three sections of the form must be completed. The certification shall be submitted at the disposal site to the department of health or its designee, and must be judged to be properly executed prior to the acceptance of the waste by the site operator. If a broker is involved, the broker's and carrier's sections must bear original signatures. The generator's signature need not be an original signature. If a broker is acting as the processor and/or packager of the

waste, the broker may act as the agent of the generator and may sign the certification statement for the generator, provided the name and site use permit number of the original generator are identified. If no broker is involved, the generator shall so signify by entry in the broker's section of the form that no broker was involved, e.g., "no broker," and the generator and carrier's section must bear original signatures.

(2) In the case of brokered shipments from more than a single generator, information on each generator's certification shall include data clearly identifying, without reference to other documentation, each package transferred from that generator to the broker. The data shall be compatible with package identifications on the shipment manifest (RSR) from the broker, and with identification markings on the packages.

[Statutory Authority: RCW 70.98.050 and 70.98.080. 91-16-109 (Order 187), § 246-249-030, filed 8/7/91, effective 9/7/91. Statutory Authority: RCW 43.70.040. 91-02-049 (Order 121), recodified as § 246-249-030, filed 12/27/90, effective 1/31/91. Statutory Authority: RCW 70.98.080. 87-01-031 (Order 2450), § 402-62-040, filed 12/11/86.]

**WAC 246-249-040 Classification of radioactive waste for near-surface disposal.** (1) **Considerations.**

Determination of the classification of waste involves two considerations. First, consideration must be given to the concentration of long-lived radionuclides (and their shorter-lived precursors) whose potential hazard will persist long after such precautions as institutional controls, improved waste form, and deeper disposal have ceased to be effective. These precautions delay the time when long-lived radionuclides could cause exposures. In addition, the magnitude of the potential dose is limited by the concentration and availability of the radionuclide at the time of exposure. Second, consideration must be given to the concentration of shorter-lived radionuclides for which requirements on institutional controls, waste form, and disposal methods are effective.

(2) **Classes of waste.**

(a) Class A waste is waste that is usually segregated from other waste classes at the disposal site. The physical form and characteristics of Class A waste must meet the minimum requirements set forth in WAC 246-249-050(1). If Class A waste also meets the stability requirements set forth in WAC 246-249-050(2), it is not necessary to segregate the waste for disposal.

(b) Class B waste is waste that must meet more rigorous requirements on waste form to ensure stability after disposal. The physical form and characteristics of Class B waste must meet both the minimum and stability requirements set forth in WAC 246-249-050.

(c) Class C waste is waste that not only must meet more rigorous requirements on waste form to ensure stability but also requires additional measures at the disposal facility to protect against inadvertent intrusion. The physical form and characteristics of Class C waste must meet both the minimum and stability requirements set forth in WAC 246-249-050.

(3) **Classification determined by long-lived radionuclides.** If the waste contains only radionuclides listed in Table 1, classification shall be determined as follows:

(a) If the concentration does not exceed 0.1 times the value in Table 1, the waste is Class A.

(b) If the concentration exceeds 0.1 times the value in Table 1, but does not exceed the value in Table 1, the waste is Class C.

(c) If the concentration exceeds the value in Table 1, the waste is not generally acceptable for near-surface disposal.

(d) For waste containing mixtures of radionuclides listed in Table 1, the total concentration shall be determined by the sum of fractions rule described in subsection (7) of this section.

Table 1

Radionuclide	Concentration Curies/Cubic Meter
C-14	8
C-14 in activated metal	80
Ni-59 in activated metal	220
Nb-94 in activated metal	0.2
Tc-99	3
I-129	0,08
Alpha emitting transuranic radionuclides with half-life greater than five years	100 <sup>1</sup>
Pu-241	3,500 <sup>1</sup>
Cm-242	20,000 <sup>1</sup>
Ra-226	100 <sup>1</sup>

<sup>1</sup> Units are nanocuries per gram, to convert to becquerels (Bq) per gram multiply by 37, to convert from curies to gigabecquerels (GBq) multiply by 37. Specific approval of the department is required for disposal of these radionuclides if their concentration is greater than ten percent of the Table 1 value.

(4) **Classification determined by short-lived radionuclides.** If the waste does not contain any of the radionuclides listed in Table 1, classification shall be determined based on the concentrations shown in Table 2. If the radioactive waste does not contain any radionuclides listed in either Table 1 or 2, it is Class A.

(a) If the concentration does not exceed the value of Column 1, the waste is Class A.

(b) If the concentration exceeds the value in Column 1, but does not exceed the value in Column 2, the waste is Class B.

(c) If the concentration exceeds the value in Column 2, but does not exceed the value in Column 3, the waste is Class C.

(d) If the concentration exceeds the value in Column 3, the waste is not generally acceptable for near-surface disposal.

(e) For wastes containing mixtures of the radionuclides listed in Table 2, the total concentration shall be determined by the sum of fractions rule described in subsection (7) of this section.

Table 2

Radionuclide	Concentration, Curies/ Cubic Meter		
	Column 1	Column 2	Column 3
Total of all radionuclides with less than 5-year half-life	700	(*)	(*)
H-3	40	(*)	(*)
Co-60	700	(*)	(*)
Ni-63	3.5	70	700
Ni-63 in activated metal	35	700	7,000
Sr-90	0.04	150	7,000
Cs-137	1	44	4,600

(\*) There are no limits established for these radionuclides in Class B or C wastes. Practical consideration such as the effects of external radiation and internal heat generation on transportation, handling, and disposal will limit the concentrations for these wastes. These wastes shall be Class B unless the concentrations of other radionuclides in Table 2 determine the waste to be Class C independent of these radionuclides. Specific approval of the department is required prior to packaging of Class B tritium waste.

(5) **Classification determined by both long-lived and short-lived radionuclides.** If the waste contains a mixture of radionuclides, some of which are listed in Table 1, and some of which are listed in Table 2, classification shall be determined as follows:

(a) If the concentration of a radionuclide listed in Table 1 is less than 0.1 times the value listed in Table 1, the class shall be that determined by the concentration of radionuclides listed in Table 2.

(b) If the concentration of a radionuclide listed in Table 1 exceeds 0.1 times the value listed in Table 1, the waste shall be Class C, provided the concentration of radionuclides listed in Table 2 does not exceed the value shown in Column 3 of Table 2.

(6) **Classification of waste with radionuclides other than those listed in Tables 1 and 2.** If the waste does not contain any radionuclides listed in either Table 1 or 2, it is Class A.

(7) **The sum of fractions rule for mixtures of radionuclides.** For determining classification for waste that contains a mixture of radionuclides, it is necessary to determine the sum of fractions by dividing each radionuclide's concentration by the appropriate limit and adding the resulting values. The appropriate limits must all be taken from the same column of the same table. The sum of the fractions for the column must be less than or equal to 1.0 if the waste class is to be determined by that column. Example: A waste contains Sr-90 in a concentration of 50 Ci/m<sup>3</sup> and Cs-137 in a concentration of 22 Ci/m<sup>3</sup>. Since the concentrations both exceed the values in Column 1, Table 2, they must be compared to Column 2 values. For Sr-90 fraction, 50/150 = 0.33; for Cs-137 fraction, 22/44 = 0.5; the sum of the fractions = 0.83. Since the sum is less than 1.0, the waste is Class B.

(8) **Determination of concentration in wastes.** The concentration of a radionuclide may be determined by indirect methods such as use of scaling factors which relate to the inferred concentration of one radionuclide to another that is measured, or radionuclide material accountability, if there is reasonable assurance that the indirect methods can

be correlated with actual measurement. The concentration of a radionuclide may be averaged over the volume of the waste, or weight of the waste if the units are expressed as nanocuries per gram.

[Statutory Authority: RCW 70.98.050 and 70.98.080. 91-16-109 (Order 187), § 246-249-040, filed 8/7/91, effective 9/7/91. Statutory Authority: RCW 43.70.040. 91-02-049 (Order 121), recodified as § 246-249-040, filed 12/27/90, effective 1/31/91. Statutory Authority: RCW 70.98.080. 87-01-031 (Order 2450), § 402-62-050, filed 12/11/86.]

**WAC 246-249-050 Acceptable radioactive waste forms and packaging.** (1) Packaging.

(a) Wastes shall be packaged in conformance with the conditions of the license issued to the site operator to which the waste will be shipped. Where the conditions of the site license are more restrictive than the provisions of the site regulations, the site license condition shall govern. As a minimum, radioactive waste must be packaged in such a manner that waste containers received at the facility do not show:

- (i) Significant deformation;
- (ii) Loss or dispersal of contents;
- (iii) An increase in the external radiation levels recorded on the manifest, within instrument tolerances; or
- (iv) Significant containment degradation due to rust or other chemical actions.

(b) Wastes shall not be packaged for disposal in cardboard or fiberboard. Wood boxes are prohibited after February 28, 1987.

(c) A process control program shall be used which validates the following:

(i) Liquid waste shall be packaged in sufficient approved absorbent material to absorb twice the volume of the liquid, solidified using an approved solidification agent, or stabilized using an approved stabilization agent.

(ii) Solid wastes containing liquid shall contain as little free-standing and noncorrosive liquid as is reasonably achievable, but in no case shall the liquid exceed one percent of the volume.

(d) Waste shall not be readily capable of detonation or of explosive decomposition or reaction at normal pressures and temperatures, or of explosive reaction with water.

(e) Waste shall not contain, or be capable of generating quantities of toxic gases, vapors, or fumes harmful to persons transporting, handling, or disposing of the waste. This does not apply to radioactive gaseous waste packaged in accordance with (g) of this subsection.

(f) Pyrophoric materials contained in wastes shall be treated, prepared, and packaged to be nonflammable.

(g) Waste in gaseous form must be packaged at a pressure that does not exceed 1.5 atmospheres at 20°C. Total activity shall not exceed 100 curies ( $3.7 \times 10^{12}$  Bqs) per container. Class A gaseous waste shall be contained within United States Department of Transportation specification cylinders. Specific approval of the department is required if the gaseous waste is Class B or C.

(h) Wastes containing hazardous, biological, pathogenic, or infectious material shall be treated to reduce the maximum extent practicable the potential hazard from the nonradiological materials. Wastes subject to regulation under Resource Conservation and Recovery Act (RCRA) are not allowed at the disposal site.

(i) Radioactive consumer products, the use and disposal of which is exempt from licensing control, may be received without regard to concentration limits of WAC 246-249-040 Table 2 provided the entire unit is received and is packaged with sufficient sorbent material so as to preclude breakage and rupture of its contents. This subsection allows the disposal of such consumer products as intact household or industrial smoke detector units containing Americium-241 foils and radium or radioactive materials incorporated into self-luminous devices and electron tubes.

(2) The following requirements are intended to provide stability of the waste. Stability is intended to ensure that the waste does not degrade and affect overall stability of the site through slumping, collapse, or other failure of the disposal unit and thereby lead to water infiltration. Stability is also a factor in limiting exposure to an inadvertent intruder, since it provides a recognizable and nondispersible waste form.

(a) Classes B, C, and A stable waste shall have structural stability. A structurally stable waste form will generally maintain its physical dimensions and its form, under the expected disposal conditions such as weight of overburden and compaction equipment, the presence of moisture, and microbial activity, and internal factors such as radiation effects and chemical changes. Structural stability can be provided by the waste form itself, processing the waste to a stable form, or placing the waste in a disposal container or structure that provides stability after disposal.

(b) Notwithstanding the provisions in subsection (1)(c) and (d) of this section, liquid waste, or waste containing liquid, shall be converted into a form that contains as little free-standing and noncorrosive liquid as is reasonably achievable, but in no case shall the liquid exceed one percent of the volume of the waste when the waste is in a disposal container designed to ensure stability, or 0.5 percent of the volume of the waste for waste processed to a stable form.

(c) Void spaces within the radioactive waste and between the waste and its package shall be reduced to the extent practicable. Unless specifically approved by the department, void spaces in Class A stable, Class B, and Class C waste packages shall be less than 15 percent of the total volume of the disposal package, provided the disposal package is not a high integrity container nor contains activated metals that are too large to put into high integrity containers. For Class B and Class C waste packages containing activated metals, voids shall be reduced to the extent practicable, and shall be demonstrated to be structurally stable by any of the methods discussed in (a) of this subsection.

[Statutory Authority: RCW 70.98.050 and 70.98.080. 91-16-109 (Order 187), § 246-249-050, filed 8/7/91, effective 9/7/91. Statutory Authority: RCW 43.70.040. 91-02-049 (Order 121), recodified as § 246-249-050, filed 12/27/90, effective 1/31/91. Statutory Authority: RCW 70.98.080. 87-01-031 (Order 2450), § 402-62-060, filed 12/11/86.]

**WAC 246-249-060 Labeling.** Each package of waste must be clearly labeled to identify whether it is Class A waste, Class B waste, or Class C waste in accordance with WAC 246-249-040. This marking is in addition to any transportation markings or labeling required by the United States Nuclear Regulatory Commission or the United States Department of Transportation and shall consist of lettering one-half inch high or greater in a durable contrasting color



with the background surrounding the lettering. The classification marking shall be visible on the same side as the radioactive marking or label and in close proximity (within six inches). Waste packages marked "Radioactive," "Limited Quantity" or "Radioactive LSA" need only one classification marking whereas waste packages labeled White I, Yellow II, or Yellow III shall have classification markings in close proximity (within six inches) to each label.

[Statutory Authority: RCW 70.98.050 and 70.98.080. 91-16-109 (Order 187), § 246-249-060, filed 8/7/91, effective 9/7/91. Statutory Authority: RCW 43.70.040. 91-02-049 (Order 121), recodified as § 246-249-060, filed 12/27/90, effective 1/31/91. Statutory Authority: RCW 70.98.080. 87-01-031 (Order 2450), § 402-62-070, filed 12/11/86.]

**WAC 246-249-070 Variances.** It is inevitable that a small portion of wastes cannot be treated to fully comply with the waste form requirements of this chapter consistent with the ALARA philosophy of chapter 246-220 WAC. A waste disposal site operator may apply to the department for a variance provided:

- (1) The variance requested is not for a continuing process or waste stream;
- (2) An equivalent or greater degree of protection is provided by the proposed alternative; and
- (3) All reasonable methods of complying with the existing requirement have been considered.

[Statutory Authority: RCW 70.98.050 and 70.98.080. 91-16-109 (Order 187), § 246-249-070, filed 8/7/91, effective 9/7/91. Statutory Authority: RCW 43.70.040. 91-02-049 (Order 121), recodified as § 246-249-070, filed 12/27/90, effective 1/31/91. Statutory Authority: RCW 70.98.080. 87-01-031 (Order 2450), § 402-62-080, filed 12/11/86.]

**WAC 246-249-080 Naturally occurring and accelerator produced radioactive material (NARM), excluding source material.** (1) In addition to requirements for a disposal site use permit contained in WAC 246-249-020, single generators of radioactive wastes shall obtain the specific approval of the department prior to offering naturally occurring or accelerator produced radioactive material, wastes for disposal.

(2) Applications for specific departmental approval shall describe:

- (a) The chemical processes which produce or have produced the waste;
  - (b) The volume of waste to be disposed; and
  - (c) The radionuclides in the waste.
- (3) A request for specific approval may be approved if the department finds the material to be:

- (a) In conformance with conditions of all licenses and permits issued to the disposal site operator; and
- (b) Consistent with protection of the public health, safety and environment.

(4) Naturally occurring and accelerator produced radioactive material, excluding source material, shall be limited to a total site volume of no more than eight thousand six hundred cubic feet per calendar year, and individual generators shall be limited to an annual total volume of one thousand cubic feet per calendar year, provided that there shall be no annual site limit or individual generator volume limit for:

- (a) Accelerator produced radioactive material excluding decommissioning waste; and

(b) Discrete sealed sources. For purposes of this section, sealed sources means any device containing naturally occurring radioactive material or accelerator produced radioactive material to be used as a source of radiation which has been constructed in such a manner as to prevent the escape of any radioactive material.

(5) Emergency provision. If the annual total site volume limit or an individual generator's annual total volume limit has been met, and an emergency situation occurs, single generators of NARM may seek emergency approval from the secretary to dispose of NARM excluding source materials in excess of volume limitations. The secretary may approve emergency disposal if he or she finds that an emergency exists based upon the circumstances described by the applicant, the real or potential impact on the public health and safety as determined by the department and that approval of such additional disposal is consistent with protecting the public health and safety of the citizens of the state of Washington.

(6) The department shall review subsection (4)(a) and (b) of this section, every five years, beginning five years from the effective date of this regulation, to determine if volume limits should be set.

(7) Denial by the department of a request for specific approval shall not be interpreted as an approval to dispose of naturally occurring or accelerator produced radioactive material without regard to its radioactivity.

[Statutory Authority: Chapter 70.98 RCW. 95-13-094, § 246-249-080, filed 6/21/95, effective 7/22/95. Statutory Authority: RCW 70.98.050 and 70.98.080. 91-16-109 (Order 187), § 246-249-080, filed 8/7/91, effective 9/7/91. Statutory Authority: RCW 43.70.040. 91-02-049 (Order 121), recodified as § 246-249-080, filed 12/27/90, effective 1/31/91. Statutory Authority: RCW 70.98.080. 87-01-031 (Order 2450), § 402-62-090, filed 12/11/86.]

**WAC 246-249-090 Transfer for disposal and manifests.** (1) Each shipment of waste to a licensed land disposal facility shall be accompanied by a shipment manifest that contains the name, address, and telephone number of the person generating the waste. The manifest shall also include the name, address, and telephone number of the person transporting the waste to the land disposal facility. The manifest shall also indicate as completely as practicable: A physical description of the waste; the waste volume; radionuclide identity and quantity; the total radioactivity; and the principal chemical form. The solidification, stabilization, or sorption agent shall be specified. Wastes containing more than 0.1 percent chelating agents by weight shall be identified and the weight percentage of the chelating agent estimated. Wastes classified as Class A, Class B, or Class C in WAC 246-249-040 shall be clearly identified as such in the manifest unless transferred to a waste processor who treats or repackages wastes. The total quantity of the radionuclides H-3, C-14, Tc-99 and I-129 must be shown.

(2) The manifest required in subsection (1) of this section may be shipping papers used to meet United States Department of Transportation or United States Environmental Protection Agency regulations or requirements of the receiver, provided all of the required information is included. Copies of manifests required by this section may be legible carbon copies or legible photocopies.



(3) Each manifest shall include a certification by the waste generator that the transported materials are properly classified, described, packaged, marked, and labeled and are in proper condition for transportation according to the applicable regulations of the United States Department of Transportation and the agency. An authorized representative of the waste generator shall sign and date the manifest.

(4) Any generator licensee who transfers waste to a land disposal facility or a licensed waste collector shall comply with the following requirements. Any licensee who transfers waste to a licensed waste processor who treats or repackages waste shall comply with the requirements of (d) through (h) of this subsection. A licensee shall:

(a) Prepare all wastes so the waste is classified according to WAC 246-249-040 and meets the waste characteristics requirements in WAC 246-249-050.

(b) Label each package of waste to identify whether it is a Class A waste, Class B waste or Class C waste, in accordance with WAC 246-249-040;

(c) Conduct a quality control program to assure compliance with WAC 246-249-040 and 246-249-050; the program must include management evaluation of audits;

(d) Prepare shipping manifests to meet the requirements of subsections (1), (2), and (3) of this section;

(e) Forward a copy of the manifest to the intended recipient, at the time of shipment; or, deliver to a broker at the time the waste is collected, obtaining acknowledgement of receipt in the form of a signed copy of the manifest from the broker;

(f) Include one copy of the manifest with the shipment;

(g) Retain a copy of the manifest with documentation of acknowledgement of receipt as the record of transfer of licensed material as required by these regulations;

(h) For any shipments or any part of a shipment for which acknowledgement of receipt has not been received within the times set forth in this section, conduct an investigation in accordance with subsection (8) of this section.

(5) Any waste broker licensee who handles prepackaged waste shall:

(a) Acknowledge receipt of the waste from the generator within one week of receipt by returning a signed copy of the manifest.

(b) Prepare a new manifest to reflect consolidated shipments; the new manifest shall serve as a listing or index for the detailed generator manifests. Copies of the generator manifests shall be a part of the new manifest.

The waste broker may prepare a new manifest without attaching the generator manifests, provided the new manifest contains for each package the information specified in subsection (1) of this section. The broker licensee shall certify that nothing has been done to the waste which would invalidate the generator's certification.

(c) Forward a copy of the new manifest to the land disposal facility operator at the time of shipment;

(d) Include the new manifest with the shipment to the disposal site.

(e) Retain a copy of the manifest with documentation of acknowledgement of receipt as the record of transfer of licensed material as required by these regulations, and retain information from generator manifests as required by these regulations, and retain information from generator manifests until disposition is authorized by the agency; and

(f) For any shipments or any part of a shipment for which acknowledgement of receipt is not received within the times set forth in this section, conduct an investigation in accordance with subsection (8) of this section.

(6) Any licensed waste processor who treats or repackages wastes shall:

(a) Acknowledge receipt of the waste from the generator within one week of receipt by returning a signed copy of the manifest.

(b) Prepare a new manifest that meets the requirements of subsections (1), (2), and (3) of this section. Preparation of the new manifest reflects that the processor is responsible for the waste;

(c) Prepare all wastes so that the waste is classified according to WAC 246-249-040 and meets the waste characteristics requirement in WAC 246-249-050.

(d) Label each package of waste to identify whether it is Class A waste, Class B waste, or Class C waste, in accordance with WAC 246-249-040 and 246-249-060.

(e) A quality control program shall be conducted to assure compliance with WAC 246-249-040 and 246-249-050. The program shall include management evaluation of audits;

(f) Forward a copy of the new manifest to the disposal site operator or waste broker at the time of shipment, or deliver to a broker at the time the waste is collected, obtaining acknowledgement of receipt in the form of a signed copy of the manifest by the broker.

(g) Include the new manifest with the shipment;

(h) Retain copies of the original manifests and new manifests with documentation of acknowledgement of receipt as the record of transfer of licensed material required by these regulations.

(i) For any shipment or part of a shipment for which acknowledgement is not received within the times set forth in this section, conduct an investigation in accordance with subsection (8) of this section.

(7) The land disposal facility operator shall:

(a) Acknowledge receipt of the waste within one week of receipt by returning a signed copy of the manifest to the shipper. The shipper to be notified is the licensee who last possessed the waste and transferred the waste to the operator. The returned copy of the manifest shall indicate any discrepancies between materials listed on the manifest and materials received;

(b) Maintain copies of all completed manifests until the agency authorizes their disposition; and

(c) Notify the shipper (i.e., the generator or the broker) and the agency when any shipment or part of a shipment has not arrived within sixty days after the advanced manifest was received.

(8) Any shipment or part of a shipment for which acknowledgement is not received within the time set forth in this section must:

(a) Be investigated by the shipper if the shipper has not received notification of receipt within twenty days after transfer; and

(b) Be traced and reported. The investigation shall include tracing the shipment and filing a report with the agency. Each licensee who conducts a trace investigation shall file a written report with the agency within two weeks of completion of the investigation.

[Statutory Authority: RCW 70.98.050 and 70.98.080. 97-02-014, § 246-249-090, filed 12/20/96, effective 1/20/97; 91-16-109 (Order 187), § 246-249-090, filed 8/7/91, effective 9/7/91.]

**Chapter 246-250 WAC**  
**RADIOACTIVE WASTE—LICENSING LAND**  
**DISPOSAL**

## WAC

## GENERAL PROVISIONS

246-250-001	Purpose and scope.
246-250-010	Definitions.
246-250-020	License required.
246-250-030	Content of application.
246-250-040	General information.
246-250-050	Specific technical information.
246-250-060	Technical analyses.
246-250-070	Institutional information.
246-250-080	Financial information.
246-250-090	Requirements for issuance of a license.
246-250-100	Conditions of licenses.
246-250-110	Application for renewal or closure.
246-250-120	Contents of application for site closure and stabilization.
246-250-130	Postclosure observation and maintenance.
246-250-140	Transfer of license.
246-250-150	Termination of license.
246-250-160	General requirement.
246-250-170	Protection of the general population from releases of radioactivity.
246-250-180	Protection of individuals from inadvertent intrusion.
246-250-190	Protection of individuals during operations.
246-250-200	Stability of the disposal site after closure.

## TECHNICAL REQUIREMENTS FOR LAND DISPOSAL FACILITIES

246-250-300	Disposal site suitability requirements for land disposal.
246-250-320	Disposal site design for land disposal.
246-250-330	Land disposal facility operation and disposal site closure.
246-250-340	Environmental monitoring.
246-250-350	Alternative requirements for design and operations.
246-250-360	Institutional requirements.
246-250-370	Alternative requirements for waste classification and characteristics.

## FINANCIAL ASSURANCES

246-250-500	Applicant qualifications and assurances.
246-250-520	Funding for disposal site closure and stabilization.
246-250-530	Financial assurances for institutional controls.

## RECORDS, REPORTS, TESTS, AND INSPECTIONS

246-250-600	Maintenance of records, reports, and transfers.
246-250-620	Tests on land disposal facilities.

## LAND DISPOSAL OF RADIOACTIVE WASTE

246-250-700	Agency inspections of land disposal facilities.
-------------	---

## GENERAL PROVISIONS

**WAC 246-250-001 Purpose and scope.** (1) The regulations in this chapter establish procedures, criteria, and terms and conditions upon which the department issues licenses for land disposal of low-level radioactive wastes received from other persons. (Applicability of the requirements in this chapter to department licenses for waste disposal facilities in effect on the effective date of this regulation will be determined on a case-by-case basis and implemented through terms and conditions of the license or by orders issued by the department.) The requirements of this chapter are in addition to, and not in substitution for,

other applicable requirements of these regulations or other state regulations.

(2) The regulations in this chapter do not apply to disposal of tailings or wastes produced by the extraction or concentration of uranium or thorium from any ore where the tailings or wastes result in quantities greater than 10,000 kilograms and containing more than 185 mega becquerels (five millicuries) of radium 226, or disposal of waste provided in WAC 246-221-070, 246-221-190, or 246-221-200.

(3) This chapter establishes procedural requirements and performance objectives applicable to any method of land disposal. It establishes specific technical requirements for near-surface disposal of radioactive waste which involves disposal in the uppermost portion of the earth, approximately 30 meters. Near-surface disposal includes disposal in engineered facilities which may be built totally or partially above-grade provided that such facilities have protective earthen covers. Near-surface disposal does not include disposal facilities which are partially or fully above-grade with no protective earthen cover, which are referred to as "above-ground disposal." Burial deeper than 30 meters may also be satisfactory. Technical requirements for alternative methods may be added in the future.

[Statutory Authority: RCW 70.98.050 and 70.98.080. 97-02-014, § 246-250-001, filed 12/20/96, effective 1/20/97. Statutory Authority: RCW 70.98.050. 94-01-073, § 246-250-001, filed 12/9/93, effective 1/9/94. Statutory Authority: RCW 70.98.050 and 70.98.080. 91-16-109 (Order 187), § 246-250-001, filed 8/7/91, effective 9/7/91. Statutory Authority: RCW 43.70.040. 91-02-049 (Order 121), recodified as § 246-250-001, filed 12/27/90, effective 1/31/91. Statutory Authority: RCW 70.98.080. 87-01-031 (Order 2450), § 402-61-010, filed 12/11/86.]

**WAC 246-250-010 Definitions.** As used in this chapter, the following definitions apply:

(1) "Active maintenance" means any significant activity needed during the period of institutional control to maintain a reasonable assurance that the performance objectives of WAC 246-250-170 and 246-250-180 are met. Such active maintenance includes ongoing activities such as the pumping and treatment of water from a disposal unit or one-time measures such as replacement of a disposal unit cover. Active maintenance does not include custodial activities such as repair of fencing, repair or replacement of monitoring equipment, revegetation, minor additions to soil cover, minor repair of disposal unit covers, and general disposal site upkeep such as mowing grass.

(2) "Buffer zone" means a portion of the disposal site that is controlled by the licensee or by the United States Department of Energy and that lies under the disposal units and between the disposal units and the boundary of the site.

(3) "Chelating agent" means amine polycarboxylic acids, hydroxy-carboxylic acids, gluconic acid, and polycarboxylic acids.

(4) "Commencement of construction" means any clearing of land, excavation, or other substantial action that would adversely affect the environment of a land disposal facility. The term does not mean disposal site exploration, necessary roads for disposal site exploration, borings to determine foundation conditions, or other preconstruction monitoring or testing to establish background information

related to the suitability of the disposal site or the protection of environmental values.

(5) "Custodial agency" means an agency of the government designated to act on behalf of the government owner of the disposal site.

(6) "Disposal" means the isolation of wastes from the biosphere inhabited by man and his food chains by emplacement in a land disposal facility.

(7) "Disposal site" means that portion of a land disposal facility which is used for disposal of waste. It consists of disposal units and a buffer zone.

(8) "Disposal unit" means a discrete portion of the disposal site into which waste is placed for disposal. For near-surface disposal, the unit is usually a trench.

(9) "Engineered barrier" means a man-made structure or device that is intended to improve the land disposal facility's ability to meet the performance objectives in this chapter.

(10) "Explosive material" means any chemical compound, mixture, or device which produces a substantial instantaneous release of gas and heat spontaneously or by contact with sparks or flame.

(11) "Hazardous waste" means those wastes designated as hazardous by United States Environmental Protection Agency regulations in 40 CFR Part 261.

(12) "Hydrogeologic unit" means any soil or rock unit or zone which by virtue of its porosity or permeability, or lack thereof, has a distinct influence on the storage or movement of groundwater.

(13) "Inadvertent intruder" means a person who might occupy the disposal site after closure and engage in normal activities, such as agriculture, dwelling construction, or other pursuits in which an individual might be unknowingly exposed to radiation from the waste.

(14) "Intruder barrier" means a sufficient depth of cover over the waste that inhibits contact with waste and helps to ensure that radiation exposures to an inadvertent intruder will meet the performance objectives set forth in this chapter, or engineered structures that provide equivalent protection to the inadvertent intruder.

(15) "Land disposal facility" means the land, buildings, and equipment which are intended to be used for the disposal of wastes into the subsurface of the land. For purposes of this chapter, a land disposal facility does not include a geologic repository.

(16) "Monitoring" means observing and making measurements to provide data to evaluate the performance and characteristics of the disposal site.

(17) "Near-surface disposal facility" means a land disposal facility in which waste is disposed within approximately the upper thirty meters of the earth's surface.

(18) "Pyrophoric liquid" means any liquid that ignites spontaneously in dry or moist air at or below 130°F (54.4°C).

(19) "Pyrophoric solid" means any solid material, other than one classed as an explosive, which under normal conditions, is liable to cause fires through friction, retained heat from manufacturing or processing, or which can be ignited readily and, when ignited, burns so vigorously and persistently as to create a serious transportation, handling, or disposal hazard. Included are spontaneously combustible and water-reactive materials.

(20) "Site closure and stabilization" means those actions that are taken upon completion of operations that prepare the disposal site for custodial care and that assure that the disposal site will remain stable and will not need ongoing active maintenance.

(21) "Stability" means structural stability.

(22) "Surveillance" means monitoring and observation of the disposal site for purposes of visual detection of need for maintenance, custodial care, evidence of intrusion, and compliance with other license and regulatory requirements.

(23) "Waste" means those low-level radioactive wastes that are acceptable for disposal in a land disposal facility. For the purposes of this definition, low-level waste has the same meaning as in the Low-Level Radioactive Waste Policy Amendments Act of 1985, Public Law 99-240, that is, radioactive waste not classified as high-level radioactive waste, spent nuclear fuel, or by-product material as defined in section 11 e.(2) of the Atomic Energy Act (uranium or thorium tailings and waste).

[Statutory Authority: RCW 70.98.050 and 70.98.080. 97-02-014, § 246-250-010, filed 12/20/96, effective 1/20/97; 91-16-109 (Order 187), § 246-250-010, filed 8/7/91, effective 9/7/91. Statutory Authority: RCW 43.70.040. 91-02-049 (Order 121), recodified as § 246-250-010, filed 12/27/90, effective 1/31/91. Statutory Authority: RCW 70.98.080. 87-01-031 (Order 2450), § 402-61-020, filed 12/11/86.]

**WAC 246-250-020 License required.** (1) No person may receive, possess, or dispose of waste received from other persons at a land disposal facility unless authorized by a license issued by the department pursuant to this chapter, and chapter 246-235 WAC.

(2) Each person shall file an application with the department pursuant to chapter 246-235 WAC and obtain a license as provided in this chapter before commencement of construction of a land disposal facility. Failure to comply with this requirement may be grounds for denial of a license.

[Statutory Authority: RCW 70.98.050 and 70.98.080. 91-16-109 (Order 187), § 246-250-020, filed 8/7/91, effective 9/7/91. Statutory Authority: RCW 43.70.040. 91-02-049 (Order 121), recodified as § 246-250-020, filed 12/27/90, effective 1/31/91. Statutory Authority: RCW 70.98.080. 87-01-031 (Order 2450), § 402-61-030, filed 12/11/86.]

**WAC 246-250-030 Content of application.** In addition to the requirements set forth in chapter 246-235 WAC, an application to receive from others, possess, and dispose of wastes shall consist of general information, specific technical information, institutional information, and financial information as set forth in WAC 246-250-040 through 246-250-080.

[Statutory Authority: RCW 70.98.050 and 70.98.080. 91-16-109 (Order 187), § 246-250-030, filed 8/7/91, effective 9/7/91. Statutory Authority: RCW 43.70.040. 91-02-049 (Order 121), recodified as § 246-250-030, filed 12/27/90, effective 1/31/91. Statutory Authority: RCW 70.98.080. 87-01-031 (Order 2450), § 402-61-040, filed 12/11/86.]

**WAC 246-250-040 General information.** The general information shall include each of the following:

(1) Identity of the applicant including:

(a) The full name, address, telephone number, and description of the business or occupation of the applicant;

(b) If the applicant is a partnership, the name and address of each partner and the principal location where the partnership does business;

(c) If the applicant is a corporation or an unincorporated association, (i) the state where it is incorporated or organized and the principal location where it does business, and (ii) the names and addresses of its directors and principal officers; and

(d) If the applicant is acting as an agent or representative of another person in filing the application, all information required under this subsection must be supplied with respect to the other person.

(2) Qualifications of the applicant:

(a) The organizational structure of the applicant, both offsite and onsite, including a description of lines of authority and assignments of responsibilities, whether in the form of administrative directives, contract provisions, or otherwise;

(b) The technical qualifications, including training and experience, of the applicant and members of the applicant's staff to engage in the proposed activities. Minimum training and experience requirements for personnel filling key positions described in (a) of this subsection must be provided.

(c) A description of the applicant's personnel training program; and

(d) The plan to maintain an adequate complement of trained personnel to carry out waste receipt, handling, and disposal operations in a safe manner.

(3) A description of:

(a) The location of the proposed disposal site;

(b) The general character of the proposed activities;

(c) The types and quantities of waste to be received, possessed, and disposed of;

(d) Plans for use of the land disposal facility for purposes other than disposal of wastes; and

(e) The proposed facilities and equipment.

(4) Proposed schedules for construction, receipt of waste, and first emplacement of waste at the proposed land disposal facility.

[Statutory Authority: RCW 43.70.040, 91-02-049 (Order 121), recodified as § 246-250-040, filed 12/27/90, effective 1/31/91. Statutory Authority: RCW 70.98.080, 87-01-031 (Order 2450), § 402-61-050, filed 12/11/86.]

**WAC 246-250-050 Specific technical information.**

The specific technical information shall include the following information needed for demonstration that the performance objectives and the applicable technical requirements of this chapter will be met. The specific technical information shall be in the form of an environmental report which the department can use to independently evaluate the project under the provisions of the State Environmental Policy Act (SEPA):

(1) A description of the natural and demographic disposal site characteristics as determined by disposal site selection and characterization activities. The description shall include geologic, geochemical, geotechnical, hydrologic, ecologic, archaeological, meteorologic, climatologic, and biotic features of the disposal site and vicinity.

(2) A description of the design features of the land disposal facility and the disposal units. For near-surface disposal, the description shall include those design features related to infiltration of water; integrity of covers for disposal units; structural stability of backfill, wastes, and covers; contact of wastes with standing water; disposal site

drainage; disposal site closure and stabilization; elimination to the extent practicable of long-term disposal site maintenance; inadvertent intrusion; occupational exposures; disposal site monitoring; and adequacy of the size of the buffer zone for monitoring and potential mitigative measures.

(3) A description of the principal design criteria and their relationship to the performance objectives.

(4) A description of the design basis natural events or phenomena and their relationship to the principal design criteria.

(5) A description of codes and standards which the applicant has applied to the design and which will apply to construction of the land disposal facilities.

(6) A description of the construction and operation of the land disposal facility. The description shall include as a minimum the methods of construction of disposal units; waste emplacement; the procedures for and areas of waste segregation; types of intruder barriers; onsite traffic and drainage systems; survey control program; methods and areas of waste storage; and methods to control surface water and groundwater access to the wastes. The description shall also include a description of the methods to be employed in the handling and disposal of wastes containing chelating agents or other nonradiological substances that might affect meeting the performance objectives of this chapter.

(7) A description of the disposal site closure plan, including those design features which are intended to facilitate disposal site closure and to eliminate the need for ongoing active maintenance.

(8) An identification of the known natural resources at the disposal site, whose exploitation could result in inadvertent intrusion into the wastes after removal of active institutional control.

(9) A description of the kind, amount, classification, and specifications of the radioactive material proposed to be received, possessed, and disposed of at the land disposal facility.

(10) A description of the quality assurance program tailored to low-level radioactive waste disposal, developed and applied by the applicant for the determination of natural disposal site characteristics and for quality assurance during the design, construction, operation, and closure of the land disposal facility and the receipt, handling, and emplacement of waste. Audits and managerial controls must be included.

(11) A description of the radiation safety program for control and monitoring of radioactive effluents to ensure compliance with the performance objective in WAC 246-250-170 and occupational radiation exposure to ensure compliance with the requirements of chapter 246-221 WAC and to control contamination of personnel, vehicles, equipment, buildings, and the disposal site. Both routine operations and accidents shall be addressed. The program description must include procedures, instrumentation, facilities, and equipment.

(12) A description of the environmental monitoring program to provide data to evaluate potential health and environmental impacts and the plan for taking corrective measures if migration is indicated.

(13) A description of the administrative procedures that the applicant will apply to control activities at the land disposal facility.

(14) A description of the facility electronic record-keeping system.

[Statutory Authority: RCW 70.98.050 and 70.98.080. 97-02-014, § 246-250-050, filed 12/20/96, effective 1/20/97; 91-16-109 (Order 187), § 246-250-050, filed 8/7/91, effective 9/7/91. Statutory Authority: RCW 43.70.040. 91-02-049 (Order 121), recodified as § 246-250-050, filed 12/27/90, effective 1/31/91. Statutory Authority: RCW 70.98.080. 87-01-031 (Order 2450), § 402-61-060, filed 12/11/86.]

**WAC 246-250-060 Technical analyses.** The specific technical information shall also include the following analyses needed to demonstrate that the performance objectives of this chapter will be met:

(1) Pathways analyzed in demonstrating protection of the general population from releases of radioactivity shall include air, soil, groundwater, surface water, plant uptake, and exhumation by burrowing animals. The analyses shall clearly identify and differentiate between the roles performed by the natural disposal site characteristics and design features in isolating and segregating the wastes. The analyses shall clearly demonstrate that there is reasonable assurance that the exposures to humans from the release of radioactivity will not exceed the limits set forth in WAC 246-250-170.

(2) Analyses of the protection of individuals from inadvertent intrusion shall include demonstration that there is reasonable assurance the waste classification and segregation requirements will be met and that adequate barriers to inadvertent intrusion will be provided.

(3) Analyses of the protection of individuals during operations shall include assessments of expected exposures due to routine operations and likely accidents during handling, storage, and disposal of waste. The analyses shall provide reasonable assurance that exposures will be controlled to meet the requirements of chapter 246-221 WAC.

(4) Analyses of the long-term stability of the disposal site and the need for ongoing active maintenance after closure shall be based upon analyses of active natural processes such as erosion, mass wasting, slope failure, settlement of wastes and backfill, infiltration through covers over disposal areas and adjacent soils, and surface drainage of the disposal site. The analyses shall provide reasonable assurance that there will not be a need for ongoing active maintenance of the disposal site following closure.

[Statutory Authority: RCW 70.98.050 and 70.98.080. 91-16-109 (Order 187), § 246-250-060, filed 8/7/91, effective 9/7/91. Statutory Authority: RCW 43.70.040. 91-02-049 (Order 121), recodified as § 246-250-060, filed 12/27/90, effective 1/31/91. Statutory Authority: RCW 70.98.080. 87-01-031 (Order 2450), § 402-61-070, filed 12/11/86.]

**WAC 246-250-070 Institutional information.** The institutional information submitted by the applicant shall include:

(1) A certification by the federal or state agency which owns the disposal site that the federal or state agency is prepared to accept transfer of the license when the provisions of WAC 246-250-140 are met and will assume responsibility for institutional control after site closure and postclosure observation and maintenance.

(2) Where the proposed disposal site is on land not owned by the federal or state government, the applicant shall submit evidence that arrangements have been made for

assumption of ownership in fee by the federal or state agency before the department issues a license.

[Statutory Authority: RCW 70.98.050 and 70.98.080. 91-16-109 (Order 187), § 246-250-070, filed 8/7/91, effective 9/7/91. Statutory Authority: RCW 43.70.040. 91-02-049 (Order 121), recodified as § 246-250-070, filed 12/27/90, effective 1/31/91. Statutory Authority: RCW 70.98.080. 87-01-031 (Order 2450), § 402-61-080, filed 12/11/86.]

**WAC 246-250-080 Financial information.** The financial information shall be sufficient to demonstrate that the financial qualifications of the applicant are adequate to carry out the activities for which the license is sought and meet other financial assurance requirements of this chapter.

[Statutory Authority: RCW 43.70.040. 91-02-049 (Order 121), recodified as § 246-250-080, filed 12/27/90, effective 1/31/91. Statutory Authority: RCW 70.98.080. 87-01-031 (Order 2450), § 402-61-090, filed 12/11/86.]

**WAC 246-250-090 Requirements for issuance of a license.** A license for the receipt, possession, and disposal of waste containing or contaminated with radioactive material will be issued by the department upon finding that:

(1) The issuance of the license will not constitute an unreasonable risk to the health and safety of the public;

(2) The applicant is qualified by reason of training and experience to carry out the disposal operations requested in a manner that protects health and minimizes danger to life or property;

(3) The applicant's proposed disposal site, disposal design, land disposal facility operations, including equipment, facilities, and procedures, disposal site closure, and postclosure institutional control are adequate to protect the public health and safety in that they provide reasonable assurance that the general population will be protected from releases of radioactivity as specified in the performance objective in WAC 246-250-170.

(4) The applicant's proposed disposal site, disposal site design, land disposal facility operations (including equipment, facilities, and procedures), disposal site closure, and postclosure institutional control are adequate to protect the public health and safety in that they will provide reasonable assurance that individual inadvertent intruders are protected in accordance with the performance objective in WAC 246-250-180.

(5) The applicant's proposed land disposal facility operations (including equipment, facilities, and procedures), are adequate to protect the public health and safety in that they will provide reasonable assurance that the standards for radiation protection set out in chapter 246-221 WAC will be met;

(6) The applicant's proposed disposal site, disposal site design, land disposal facility operations, disposal site closure, and postclosure institutional control are adequate to protect the public health and safety in that they will provide reasonable assurance that long-term stability of the disposed waste and the disposal site will be achieved and will eliminate to the extent practicable the need for ongoing active maintenance of the disposal site following closure;

(7) The applicant's demonstration provides reasonable assurance that the applicable technical requirements of this chapter will be met;

(8) The applicant's proposal for institutional control provides reasonable assurance that such control will be

provided for the length of time found necessary to ensure the findings in subsections (3) through (6) of this section and that the institutional control meets the requirements of WAC 246-250-360.

(9) The financial or surety arrangements meet the requirements of this chapter.

(10) The provisions of the State Environmental Policy Act have been met.

[Statutory Authority: RCW 70.98.050 and 70.98.080. 91-16-109 (Order 187), § 246-250-090, filed 8/7/91, effective 9/7/91. Statutory Authority: RCW 43.70.040. 91-02-049 (Order 121), recodified as § 246-250-090, filed 12/27/90, effective 1/31/91. Statutory Authority: RCW 70.98.080. 87-01-031 (Order 2450), § 402-61-100, filed 12/11/86.]

**WAC 246-250-100 Conditions of licenses.** (1) A license issued under this chapter, or any right thereunder, may be transferred, assigned, or in any manner disposed of, either voluntarily or involuntarily, directly or indirectly, through transfer of control of the license to any person, only if the department finds, after securing full information, that the transfer is in accordance with the provisions of the act and gives its consent in writing in the form of a license amendment.

(2) The licensee shall submit written statements under oath upon request of the department, at any time before termination of the license, to enable the department to determine whether the license should be modified, suspended, or revoked.

(3) The license will be terminated only on the full implementation of the final closure plan as approved by the department, including postclosure observation and maintenance.

(4) The licensee shall be subject to the provisions of the act, now or hereafter in effect, and to all rules, regulations, and orders of the department. The terms and conditions of the license are subject to amendment, revision, or modification, by reason of amendments to, or by reason of rules, regulations, and orders issued in accordance with the terms of the act.

(5) Each person licensed by the department pursuant to the regulations in this chapter shall confine possession and use of materials to the locations and purposes authorized in the license.

(6) The licensee shall not dispose of waste until the department has inspected the land disposal facility and has found it to be in conformance with the description, design, and construction described in the application for a license.

(7) The department may incorporate in any license at the time of issuance, or thereafter, by appropriate rule, regulation, or order, additional requirements and conditions with respect to the licensee's receipt, possession, and disposal of waste as it deems appropriate or necessary in order to:

(a) Protect health or to minimize danger to life or property;

(b) Require reports and the keeping of records, and to provide for inspections of activities under the license that may be necessary or appropriate to effectuate the purposes of the act and regulations thereunder.

(8) The authority to dispose of wastes expires on the date stated in the license. Any expiration date on a license applies only to the above ground activities and to the

authority to dispose of waste. Failure to renew the license shall not relieve the licensee of responsibility for implementing site closure, postclosure observation, and transfer of the license to the site owner.

[Statutory Authority: RCW 43.70.040. 91-02-049 (Order 121), recodified as § 246-250-100, filed 12/27/90, effective 1/31/91. Statutory Authority: RCW 70.98.080. 87-01-031 (Order 2450), § 402-61-110, filed 12/11/86.]

**WAC 246-250-110 Application for renewal or closure.** (1) An application for renewal must be filed at least ninety days prior to license expiration.

(2) An application for closure under WAC 246-250-120 must be filed at least one year prior to proposed closure.

(3) Applications for renewal of a license must be filed in accordance with WAC 246-250-030 through 246-250-080. Applications for closure must be filed in accordance with WAC 246-250-120. Information contained in previous applications, statements, or reports filed with the department under the license may be incorporated by reference if the references are clear, specific, and remain pertinent.

(4) In any case in which a licensee has filed an application in proper form for renewal of a license, the license shall not expire until the department has taken final action on the application for renewal.

(5) In determining whether a license will be renewed, the department will apply the criteria set forth in WAC 246-250-090.

[Statutory Authority: RCW 70.98.050 and 70.98.080. 91-16-109 (Order 187), § 246-250-110, filed 8/7/91, effective 9/7/91. Statutory Authority: RCW 43.70.040. 91-02-049 (Order 121), recodified as § 246-250-110, filed 12/27/90, effective 1/31/91. Statutory Authority: RCW 70.98.080. 87-01-031 (Order 2450), § 402-61-120, filed 12/11/86.]

**WAC 246-250-120 Contents of application for site closure and stabilization.** (1) Prior to final closure of the disposal site, or as otherwise directed by the department, the applicant shall submit an application to amend the license for closure. This closure application shall include a final revision and specific details of the disposal site closure plan included as part of the license application submitted under WAC 246-250-050(7) that includes each of the following:

(a) Any additional geologic, hydrologic, or other data pertinent to the long-term containment of emplaced wastes obtained during the operational period.

(b) The results of tests, experiments, or any other analyses relating to backfill of excavated areas, closure and sealing, waste migration and interaction with emplacement media, or any other tests, experiments, or analysis pertinent to the long-term containment of emplaced waste within the disposal site.

(c) Any proposed revision of plans for:

(i) Decontamination and/or dismantlement of surface facilities;

(ii) Backfilling of excavated areas; or

(iii) Stabilization of the disposal site for postclosure care.

(d) Any significant new information regarding the environmental impact of closure activities and long-term performance of the disposal site.

(2) Upon review and consideration of an application to amend the license for closure submitted in accordance with subsection (1) of this section, the department shall issue an



amendment authorizing closure if there is reasonable assurance that the long-term performance objectives of this chapter will be met.

[Statutory Authority: RCW 70.98.050 and 70.98.080. 91-16-109 (Order 187), § 246-250-120, filed 8/7/91, effective 9/7/91. Statutory Authority: RCW 43.70.040. 91-02-049 (Order 121), recodified as § 246-250-120, filed 12/27/90, effective 1/31/91. Statutory Authority: RCW 70.98.080. 87-01-031 (Order 2450), § 402-61-130, filed 12/11/86.]

**WAC 246-250-130 Postclosure observation and maintenance.** The licensee shall observe, monitor, and carry out necessary maintenance and repairs at the disposal site until the site closure is complete and the license is transferred by the department in accordance with WAC 246-250-140. Responsibility for the disposal site must be maintained by the licensee for five years. A shorter or longer time period for postclosure observation and maintenance may be established and approved as part of the site closure plan, based on site-specific conditions.

[Statutory Authority: RCW 70.98.050 and 70.98.080. 91-16-109 (Order 187), § 246-250-130, filed 8/7/91, effective 9/7/91. Statutory Authority: RCW 43.70.040. 91-02-049 (Order 121), recodified as § 246-250-130, filed 12/27/90, effective 1/31/91. Statutory Authority: RCW 70.98.080. 87-01-031 (Order 2450), § 402-61-140, filed 12/11/86.]

**WAC 246-250-140 Transfer of license.** Following closure and the period of postclosure observation and maintenance, the licensee may apply for an amendment to transfer the license to the disposal site owner. The license shall be transferred when the department finds:

(1) That the closure of the disposal site has been made in conformance with the licensee's disposal site closure plan, as amended and approved as part of the license;

(2) That reasonable assurance has been provided by the licensee that the performance objectives of this chapter are met;

(3) That any funds and necessary records for care will be transferred to the disposal site owner;

(4) That the postclosure monitoring program is operational for implementation by the disposal site owner; and

(5) That the federal or state agency which will assume responsibility for institutional control of the disposal site is prepared to assume responsibility and ensure that the institutional requirements found necessary under WAC 246-250-090(8) will be met.

[Statutory Authority: RCW 70.98.050 and 70.98.080. 91-16-109 (Order 187), § 246-250-140, filed 8/7/91, effective 9/7/91. Statutory Authority: RCW 43.70.040. 91-02-049 (Order 121), recodified as § 246-250-140, filed 12/27/90, effective 1/31/91. Statutory Authority: RCW 70.98.080. 87-01-031 (Order 2450), § 402-61-150, filed 12/11/86.]

**WAC 246-250-150 Termination of license.** (1) Following any period of institutional control needed to meet the requirements found necessary under WAC 246-250-090, the licensee may apply for an amendment to terminate the license.

(2) This application will be reviewed in accordance with the provisions of chapter 246-235 WAC.

(3) A license shall be terminated only when the department finds:

(a) That the institutional control requirements found necessary under WAC 246-250-090(8) have been met;

(b) That any additional requirements resulting from new information developed during the institutional control period have been met; and

(c) That permanent monuments or markers warning against intrusion have been installed.

[Statutory Authority: RCW 70.98.050 and 70.98.080. 91-16-109 (Order 187), § 246-250-150, filed 8/7/91, effective 9/7/91. Statutory Authority: RCW 43.70.040. 91-02-049 (Order 121), recodified as § 246-250-150, filed 12/27/90, effective 1/31/91. Statutory Authority: RCW 70.98.080. 87-01-031 (Order 2450), § 402-61-160, filed 12/11/86.]

**WAC 246-250-160 General requirement.** Land disposal facilities shall be sited, designed, operated, closed, and controlled after closure so that reasonable assurance exists that exposures to individuals are within the requirements established in the performance objectives in WAC 246-250-170 through 246-250-200.

[Statutory Authority: RCW 70.98.050 and 70.98.080. 91-16-109 (Order 187), § 246-250-160, filed 8/7/91, effective 9/7/91. Statutory Authority: RCW 43.70.040. 91-02-049 (Order 121), recodified as § 246-250-160, filed 12/27/90, effective 1/31/91. Statutory Authority: RCW 70.98.080. 87-01-031 (Order 2450), § 402-61-170, filed 12/11/86.]

**WAC 246-250-170 Protection of the general population from releases of radioactivity.** Concentrations of radioactive material which may be released to the general environment in groundwater, surface water, air, soil, plants, or animals shall not result in an annual dose exceeding an equivalent of twenty-five millirems (0.25 mSv) to the whole body, seventy-five millirems (0.75 mSv) to the thyroid, and twenty-five millirems (0.25 mSv) to any other organ of any member of the public. Reasonable effort should be made to maintain releases of radioactivity in effluents to the general environment as low as is reasonably achievable.

[Statutory Authority: RCW 43.70.040. 91-02-049 (Order 121), recodified as § 246-250-170, filed 12/27/90, effective 1/31/91. Statutory Authority: RCW 70.98.080. 87-01-031 (Order 2450), § 402-61-180, filed 12/11/86.]

**WAC 246-250-180 Protection of individuals from inadvertent intrusion.** Design, operation, and closure of the land disposal facility shall ensure protection of any individual inadvertently intruding into the disposal site and occupying the site or contacting the waste at any time after active institutional controls over the disposal site are removed.

[Statutory Authority: RCW 43.70.040. 91-02-049 (Order 121), recodified as § 246-250-180, filed 12/27/90, effective 1/31/91. Statutory Authority: RCW 70.98.080. 87-01-031 (Order 2450), § 402-61-190, filed 12/11/86.]

**WAC 246-250-190 Protection of individuals during operations.** After the effective date of these regulations, operations at the land disposal facility shall be conducted in compliance with the standards for radiation protection set out in chapter 246-221 WAC, except for releases of radioactivity in effluents from the land disposal facility, which shall be governed by WAC 246-250-170. Every reasonable effort should be made to maintain radiation exposures as low as is reasonably achievable.

[Statutory Authority: RCW 70.98.050 and 70.98.080. 91-16-109 (Order 187), § 246-250-190, filed 8/7/91, effective 9/7/91. Statutory Authority: RCW 43.70.040. 91-02-049 (Order 121), recodified as § 246-250-190, filed 12/27/90, effective 1/31/91. Statutory Authority: RCW 70.98.080. 87-01-031 (Order 2450), § 402-61-200, filed 12/11/86.]



**WAC 246-250-200 Stability of the disposal site after closure.** The disposal facility shall be sited, designed, used, operated, and closed to achieve long-term stability of the disposal site and to eliminate, to the extent practicable, the need for ongoing active maintenance of the disposal site following closure so that only surveillance, monitoring, or minor custodial care is required.

[Statutory Authority: RCW 43.70.040. 91-02-049 (Order 121), recodified as § 246-250-200, filed 12/27/90, effective 1/31/91. Statutory Authority: RCW 70.98.080. 87-01-031 (Order 2450), § 402-61-210, filed 12/11/86.]

### TECHNICAL REQUIREMENTS FOR LAND DISPOSAL FACILITIES

**WAC 246-250-300 Disposal site suitability requirements for land disposal.** (1) Disposal site suitability for near-surface disposal. The primary emphasis in disposal site suitability is given to isolation of wastes, and to disposal site features that ensure that the long-term performance objectives are met.

(a) The disposal site shall be capable of being characterized, modeled, analyzed, and monitored.

(b) Within the region where the facility is to be located, a disposal site should be selected so that projected population growth and future developments are not likely to affect the ability of the disposal facility to meet the performance objectives of this chapter.

(c) Areas shall be avoided having known natural resources which, if exploited, would result in failure to meet the performance objectives of this chapter.

(d) The disposal site shall be generally well drained and free of areas of flooding or frequent ponding. Waste disposal shall not take place in a one hundred-year flood plain, coastal high-hazard area or wetland, as defined in Executive Order 11988, "Flood Plain Management Guidelines."

(e) Upstream drainage areas shall be minimized to decrease the amount of runoff which could erode or inundate waste disposal units.

(f) The disposal site shall provide sufficient depth to the water table that groundwater intrusion, perennial or otherwise, into the waste will not occur. The department will consider an exception to this requirement to allow disposal below the water table if it can be conclusively shown that disposal site characteristics will result in molecular diffusion being the predominant means of radionuclide movement and the rate of movement will result in the performance objectives being met. In no case will waste disposal be permitted in the zone of fluctuation of the water table.

(g) The hydrogeologic unit used for disposal shall not discharge groundwater to the surface, except for groundwater monitoring operations.

(h) Areas shall be avoided where tectonic processes such as faulting, folding, seismic activity, or vulcanism may occur with such frequency and extent to significantly affect the ability of the disposal site to meet the performance objectives of this chapter or may preclude defensible modeling and prediction of long-term impacts.

(i) Areas shall be avoided where surface geologic processes such as mass wasting, erosion, slumping,

landsliding, or weathering occur with such frequency and extent to significantly affect the ability of the disposal site to meet the performance objectives of this chapter, or may preclude defensible modeling and prediction of long-term impacts.

(j) An existing disposal site may be located where nearby facilities or activities could adversely impact the ability of the site to meet the performance objectives of this chapter or significantly mask the environmental monitoring program, provided an extensive environmental monitoring program exists which is designed to differentiate, to the maximum extent practicable, between contributions from the disposal site and other nearby facilities.

(2) (Reserved.)

[Statutory Authority: RCW 43.70.040. 91-02-049 (Order 121), recodified as § 246-250-300, filed 12/27/90, effective 1/31/91. Statutory Authority: RCW 70.98.080. 87-01-031 (Order 2450), § 402-61-220, filed 12/11/86.]

**WAC 246-250-320 Disposal site design for land disposal.** (1) Disposal site design for near-surface disposal.

(a) Site design features shall be directed toward long-term isolation and avoidance of the need for continuing active maintenance after site closure.

(b) The disposal site design and operation shall be compatible with the disposal site closure and stabilization plan and lead to disposal site closure that provides reasonable assurance that the performance objectives will be met.

(c) The disposal site shall be designed to complement and improve, where appropriate, the ability of the disposal site's natural characteristics to assure that the performance objectives will be met.

(d) Covers shall be designed to minimize to the extent practicable water infiltration, to direct percolating or surface water away from the disposed waste, and to resist degradation by surface geologic processes and biotic activity.

(e) Surface features shall direct surface water drainage away from disposal units at velocities and gradients which will not result in erosion that will require ongoing active maintenance in the future.

(f) The disposal site shall be designed to minimize to the extent practicable the contact of water with waste during storage, the contact of standing water with waste during disposal, and the contact of percolating or standing water with wastes after disposal.

(2) (Reserved.)

[Statutory Authority: RCW 43.70.040. 91-02-049 (Order 121), recodified as § 246-250-320, filed 12/27/90, effective 1/31/91. Statutory Authority: RCW 70.98.080. 87-01-031 (Order 2450), § 402-61-230, filed 12/11/86.]

**WAC 246-250-330 Land disposal facility operation and disposal site closure.** (1) Near-surface disposal facility operation and disposal site closure.

(a) Wastes designated as Class A pursuant to chapter 246-249 WAC shall be segregated from other wastes by placing in disposal units which are sufficiently separated from disposal units for the other waste classes so that any interaction between Class A wastes and other wastes will not result in the failure to meet the performance objectives of this chapter. This segregation is not necessary for Class A wastes if they meet the stability requirements in chapter 246-249 WAC.

(b) Wastes designated as Class C pursuant to chapter 246-249 WAC shall be disposed of so that the top of the waste is a minimum of five meters below the top surface of the cover or must be disposed of with intruder barriers that are designed to protect against an inadvertent intrusion for at least five hundred years.

(c) Except as provided in (l) of this subsection, only waste classified as Class A, B, or C shall be acceptable for near-surface disposal. All waste shall be disposed of in accordance with the requirements of (d) through (k) of this subsection.

(d) Wastes shall be emplaced in a manner that maintains the package integrity during emplacement, minimizes the void spaces between packages, and permits the void spaces to be filled.

(e) Void spaces between waste packages shall be filled with earth or other material to reduce future subsidence within the fill.

(f) Waste shall be placed and covered in a manner that limits the radiation dose rate at the surface of the cover to levels that at a minimum will permit the licensee to comply with all provisions of chapter 246-221 WAC at the time the license is transferred pursuant to WAC 246-250-140.

(g) The boundaries and locations of each disposal unit shall be accurately located and mapped by means of a land survey. Near-surface disposal units shall be marked in such a way that the boundaries of each unit can be easily defined. Three permanent survey marker control points, referenced to United States Geological Survey (USGS) or National Geodetic Survey (NGS) survey control stations, shall be established on the site to facilitate surveys. The USGS or NGS control stations shall provide horizontal and vertical controls as checked against USGS or NGS record files.

(h) A buffer zone of land shall be maintained between any buried waste and the disposal site boundary and beneath the disposed waste. The buffer zone shall be of adequate dimensions to carry out environmental monitoring activities specified in WAC 246-250-340(4) and take mitigative measures if needed.

(i) Closure and stabilization measures as set forth in the approved site closure plan shall be carried out as each disposal unit is filled and covered.

(j) Active waste disposal operations shall not have an adverse effect on completed closure and stabilization measures.

(k) Only wastes containing or contaminated with radioactive material shall be disposed of at the disposal site.

(l) Proposals for disposal of waste that is not generally acceptable for near-surface disposal because the waste form and disposal methods must be different and, in general, more stringent than those specified for Class C waste, may be submitted to the department for approval.

(2) (Reserved.)

[Statutory Authority: RCW 70.98.050 and 70.98.080. 91-16-109 (Order 187), § 246-250-330, filed 8/7/91, effective 9/7/91. Statutory Authority: RCW 43.70.040. 91-02-049 (Order 121), recodified as § 246-250-330, filed 12/27/90, effective 1/31/91. Statutory Authority: RCW 70.98.080. 87-01-031 (Order 2450), § 402-61-240, filed 12/11/86.]

#### **WAC 246-250-340 Environmental monitoring. (1)**

At the time a new license application is submitted, the applicant shall have conducted a preoperational monitoring

program to provide basic environmental data on the disposal site characteristics. The applicant shall obtain information about the ecology, meteorology, climate, hydrology, geology, geochemistry, and seismology of the disposal site. For those characteristics that are subject to seasonal variation, data must cover at least a twelve-month period.

(2) During the land disposal facility site construction and operation, the licensee shall maintain an environmental monitoring program. Measurements and observations must be made and recorded to provide data to evaluate the potential health and environmental impacts during both the construction and the operation of the facility and to enable the evaluation of long-term effects and the need for mitigative measures. The monitoring system must be capable of providing early warning of releases of waste from the disposal site before they leave the site boundary.

(3) After the disposal site is closed, the licensee responsible for postoperational surveillance of the disposal site shall maintain a monitoring system based on the operating history and the closure and stabilization of the disposal site. The monitoring system must be capable of providing early warning of releases of waste from the disposal site before they leave the site boundary.

(4) The licensee shall have plans for taking corrective measures if the environmental monitoring program detects migration of waste which would indicate that the performance objectives may not be met.

[Statutory Authority: RCW 43.70.040. 91-02-049 (Order 121), recodified as § 246-250-340, filed 12/27/90, effective 1/31/91. Statutory Authority: RCW 70.98.080. 87-01-031 (Order 2450), § 402-61-250, filed 12/11/86.]

**WAC 246-250-350 Alternative requirements for design and operations.** The department may, upon request or on its own initiative, authorize provisions other than those set forth in WAC 246-250-300 through 246-250-340 for the segregation and disposal of waste and for the design and operation of a land disposal facility on a specific basis, if it finds reasonable assurance of compliance with the performance objectives of this chapter.

[Statutory Authority: RCW 70.98.050 and 70.98.080. 91-16-109 (Order 187), § 246-250-350, filed 8/7/91, effective 9/7/91. Statutory Authority: RCW 43.70.040. 91-02-049 (Order 121), recodified as § 246-250-350, filed 12/27/90, effective 1/31/91. Statutory Authority: RCW 70.98.080. 87-01-031 (Order 2450), § 402-61-260, filed 12/11/86.]

**WAC 246-250-360 Institutional requirements. (1)** Land ownership. Disposal of waste received from other persons may be permitted only on land owned in fee by the federal or state government.

(2) Institutional control. The land owner or custodial agency shall conduct an institutional control program to physically control access to the disposal site following transfer of control of the disposal site from the disposal site operator. The institutional control program shall also include, but not be limited to, conducting an environmental monitoring program at the disposal site, periodic surveillance, minor custodial care, and other requirements as determined by the department; and administration of funds to cover the costs for these activities. The period of institutional controls will be determined by the department, but controls may not be relied upon for more than one hundred

years following transfer of institutional control of the disposal site to the owner.

[Statutory Authority: RCW 43.70.040, 91-02-049 (Order 121), recodified as § 246-250-360, filed 12/27/90, effective 1/31/91. Statutory Authority: RCW 70.98.080, 87-01-031 (Order 2450), § 402-61-270, filed 12/11/86.]

**WAC 246-250-370 Alternative requirements for waste classification and characteristics.** The department may, upon request or on its own initiative, authorize other provisions for the classification and characteristics of waste on a specific basis, if, after evaluation of the specific characteristics of the waste, disposal site, and method of disposal, it finds reasonable assurance of compliance with the performance objectives specified in this chapter.

[Statutory Authority: RCW 43.70.040, 91-02-049 (Order 121), recodified as § 246-250-370, filed 12/27/90, effective 1/31/91. Statutory Authority: RCW 70.98.080, 87-01-031 (Order 2450), § 402-61-280, filed 12/11/86.]

## FINANCIAL ASSURANCES

**WAC 246-250-500 Applicant qualifications and assurances.** Each applicant shall show that it either possesses the necessary funds or has reasonable assurance of obtaining the necessary funds, or by a combination of the two, to cover the estimated costs of conducting all licensed activities over the planned operating life of the project, including costs of construction and disposal.

[Statutory Authority: RCW 43.70.040, 91-02-049 (Order 121), recodified as § 246-250-500, filed 12/27/90, effective 1/31/91. Statutory Authority: RCW 70.98.080, 87-01-031 (Order 2450), § 402-61-290, filed 12/11/86.]

**WAC 246-250-520 Funding for disposal site closure and stabilization.** (1) The applicant shall provide assurances prior to the commencement of operations that sufficient funds will be available to carry out disposal site closure and stabilization, including: (a) Decontamination or dismantlement of land disposal facility structures; and (b) closure and stabilization of the disposal site so that following transfer of the disposal site to the site owner, the need for ongoing active maintenance is eliminated to the extent practicable and only minor custodial care, surveillance and monitoring are required. These assurances shall be based on department-approved cost estimates reflecting the department-approved plan for disposal site closure and stabilization. The applicant's cost estimates must take into account total costs that would be incurred if an independent contractor were hired to perform the closure and stabilization work.

(2) In order to avoid unnecessary duplication and expense, the department will accept financial sureties that have been consolidated with earmarked financial or surety arrangements established to meet requirements of federal or other state agencies for such decontamination, closure, and stabilization. The department will accept these arrangements only if they are considered adequate to satisfy the requirements of this section and that the portion of the surety which covers the closure of the disposal site is clearly identified and committed for use in accomplishing these activities.

(3) The licensee's financial or surety arrangement shall be submitted annually for review by the department to assure that sufficient funds will be available for completion of the closure plan.

(4) The amount of the licensee's financial or surety arrangement shall change in accordance with changes in the predicted costs of closure and stabilization. Factors affecting closure and stabilization cost estimates include inflation, increases in the amount of disturbed land, changes in engineering plans, closure and stabilization that has already been accomplished, and any other conditions affecting costs. The financial or surety arrangement shall be sufficient at all times to cover the costs of closure and stabilization of the disposal units that are expected to be used before the next license renewal.

(5) The financial or surety arrangement shall be written for a specified period of time and shall be automatically renewed unless the person who issues the surety notifies the department, the beneficiary (the site owner), and the principal (the licensee) not less than ninety days prior to the renewal date of its intention not to renew. In such a situation, the licensee must submit a replacement surety within thirty days after notification of cancellation. If the licensee fails to provide a replacement surety acceptable to the department, the beneficiary may collect on the original surety.

(6) Proof of forfeiture shall not be necessary to collect the surety so that, in the event that the licensee could not provide an acceptable replacement surety within the required time, the surety shall be automatically collected prior to its expiration. The conditions described above shall be clearly stated on any surety instrument.

(7) Financial or surety arrangements generally acceptable to the department include surety bonds, cash deposits, certificates of deposit, deposits of government securities, escrow accounts, irrevocable letters or lines of credit, trust funds, and combinations of the above or such other types of arrangements as may be approved by the department. Self-insurance, or any arrangement which essentially constitutes self-insurance, will not satisfy the surety requirement for private sector applicants.

(8) The licensee's financial or surety arrangement shall remain in effect until the closure and stabilization program has been completed and approved by the department, and the license has been transferred to the site owner.

[Statutory Authority: RCW 43.70.040, 91-02-049 (Order 121), recodified as § 246-250-520, filed 12/27/90, effective 1/31/91. Statutory Authority: RCW 70.98.080, 87-01-031 (Order 2450), § 402-61-300, filed 12/11/86.]

**WAC 246-250-530 Financial assurances for institutional controls.** (1) Prior to the issuance of the license, the applicant shall provide for departmental approval, a binding arrangement, between the applicant and the disposal site owner that ensures that sufficient funds will be available to cover the costs of monitoring and any required maintenance during the institutional control period. The binding arrangement shall be reviewed annually by the department to ensure that changes in inflation, technology, and disposal facility operations are reflected in the arrangements.

(2) Subsequent changes to the binding arrangement specified in subsection (1) of this section relevant to institutional control shall be submitted to the department for prior approval.

[Statutory Authority: RCW 43.70.040, 91-02-049 (Order 121), recodified as § 246-250-530, filed 12/27/90, effective 1/31/91. Statutory Authority: RCW 70.98.080, 87-01-031 (Order 2450), § 402-61-310, filed 12/11/86.]

**RECORDS, REPORTS, TESTS, AND INSPECTIONS**

**WAC 246-250-600 Maintenance of records, reports, and transfers.** (1) Each licensee shall maintain any records and make any reports in connection with the licensed activities as may be required by the conditions of the license or by the rules, regulations, and orders of the department.

(2) Records which are required by these regulations or by license conditions shall be maintained for a period specified by the appropriate regulations or by license condition. If a retention period is not otherwise specified, these records must be maintained and transferred to the officials specified in subsection (4) of this section as a condition of license termination unless the department otherwise authorizes their disposition.

(3) Records which shall be maintained pursuant to this chapter may be the original or a reproduced copy or microfilm if this reproduced copy or microfilm is capable of producing copy that is clear and legible at the end of the required retention period.

(4) Notwithstanding subsections (1) through (3) of this section, copies of records of the location and the quantity of wastes contained in the disposal site must be transferred upon license termination to the chief executive of the nearest municipality, the chief executive of the county in which the facility is located, the county zoning board or land development and planning agency, the state governor, the United States Department of Energy, and other state, local, and federal governmental agencies as designated by the department at the time of license termination.

(5) Following receipt and acceptance of a shipment of waste, the licensee shall record the date of disposal of the waste, the specific location of waste in the disposal site, the condition of the waste packages as received, any discrepancies between materials listed on the manifest and those received, and any evidence of leaking or damaged packages or radiation or contamination levels in excess of limits specified in United States Department of Transportation and state of Washington regulations. The licensee shall briefly describe any repackaging operations of any of the waste packages included in the shipment, plus any other information required by the department as a license condition.

(6) Each licensee authorized to dispose of waste received from other persons shall file a copy of its financial report or a certified financial statement annually with the department in order to update the information base for determining financial qualifications.

(7)(a) Each licensee authorized to dispose of waste received from other persons, pursuant to this chapter, shall submit annual reports to the department. Reports shall be submitted by the end of the first calendar quarter of each year for the preceding year.

(b) The reports shall include:

(i) Specification of the quantity of each of the principal contaminants released to unrestricted areas in liquid and in airborne effluents during the preceding year;

(ii) The results of the environmental monitoring program;

(iii) A summary of licensee disposal unit survey and maintenance activities;

(iv) A summary, by waste class, of activities and quantities of radionuclides disposed of;

(v) Any instances in which observed site characteristics were significantly different from those described in the application for a license; and

(vi) Any other information the department may require.

(c) If the quantities of waste released during the reporting period, monitoring results, or maintenance performed are significantly different from those expected, the report must cover this specifically.

[Statutory Authority: RCW 70.98.050 and 70.98.080. 91-16-109 (Order 187), § 246-250-600, filed 8/7/91, effective 9/7/91. Statutory Authority: RCW 43.70.040. 91-02-049 (Order 121), recodified as § 246-250-600, filed 12/27/90, effective 1/31/91. Statutory Authority: RCW 70.98.080. 87-01-031 (Order 2450), § 402-61-320, filed 12/11/86.]

**WAC 246-250-620 Tests on land disposal facilities.**

Each licensee shall perform, or permit the department to perform, any tests the department deems appropriate or necessary for the administration of the regulations in this chapter, including but not limited to, tests of:

(1) Wastes;

(2) Facilities used for the receipt, storage, treatment, handling, or disposal of wastes;

(3) Radiation detection and monitoring instruments; or

(4) Other equipment and devices used in connection with the receipt, possession, handling, treatment, storage, or disposal of waste.

[Statutory Authority: RCW 43.70.040. 91-02-049 (Order 121), recodified as § 246-250-620, filed 12/27/90, effective 1/31/91. Statutory Authority: RCW 70.98.080. 87-01-031 (Order 2450), § 402-61-330, filed 12/11/86.]

**LAND DISPOSAL OF RADIOACTIVE WASTE**

**WAC 246-250-700 Agency inspections of land disposal facilities.** (1) Each licensee shall afford to the department at all reasonable times opportunity to inspect waste not yet disposed of, and the premises, equipment, operations, and facilities in which wastes are received, possessed, handled, treated, stored, or disposed.

(2) Each licensee shall make available to the department for inspection, upon reasonable notice, records kept by it pursuant to these regulations. Authorized representatives of the department may copy and take away copies of, for the department's use, any record required to be kept pursuant to these regulations.

[Statutory Authority: RCW 43.70.040. 91-02-049 (Order 121), recodified as § 246-250-700, filed 12/27/90, effective 1/31/91. Statutory Authority: RCW 70.98.080. 87-01-031 (Order 2450), § 402-61-340, filed 12/11/86.]

**Chapter 246-252 WAC****RADIATION PROTECTION—URANIUM AND/OR THORIUM MILLING****WAC**

246-252-001

Reclamation and decommissioning.

246-252-010

Definitions.

246-252-020

Purpose of uranium mill tailings areas.

246-252-030

Criteria related to disposition of uranium mill tailings or wastes.

246-252-040

Continuing dose assessment.

246-252-050

Appendix A.

**WAC 246-252-001 Reclamation and decommissioning.** A specific plan for reclamation and disposal of tailings and for decommissioning the site of uranium or thorium milling operations shall be included as part of the proposed action assessed under SEPA regulations and guidelines as required by WAC 246-235-080 (6)(a) for licensing of environmentally significant operations. For any uranium or thorium mill in operation on or before the effective date of this regulation for which a plan for reclamation and disposal of tailings and decommissioning of the site has not been submitted and assessed, such a plan must be submitted to the department and a final environmental impact statement or final declaration of nonsignificance must accompany or precede the license renewal.

[Statutory Authority: RCW 70.98.050 and 70.98.080. 91-16-109 (Order 187), § 246-252-001, filed 8/7/91, effective 9/7/91. Statutory Authority: RCW 43.70.040. 91-02-049 (Order 121), recodified as § 246-252-001, filed 12/27/90, effective 1/31/91. Statutory Authority: RCW 70.98.080. 79-12-073 (Order 1459), § 402-52-005, filed 11/30/79, effective 1/1/80.]

**WAC 246-252-010 Definitions.** The following definitions apply to the specified terms as used in this chapter.

(1) "Aquifer" means a geologic formation, group of formations, or part of a formation capable of yielding a significant amount of groundwater to wells or springs. Any saturated zone created by uranium or thorium recovery operations would not be considered an aquifer unless the zone is, or potentially is (a) hydraulically interconnected to a natural aquifer, (b) capable of discharge to surface water, or (c) reasonably accessible because of migration beyond the vertical projection of the boundary of the land transferred to long-term government ownership and care in accordance with WAC 246-252-030(11).

(2) "Closure" means the activities following operations to decontaminate and decommission the buildings and site used to produce by-product materials and reclaim the tailings and/or waste disposal area.

(3) "Closure plan" means the department approved plan to accomplish closure.

(4) "Compliance period" begins when the department sets secondary groundwater protection standards and ends when the owner or operator's license is terminated and the site is transferred to the state or federal agency for long-term care.

(5) "Dike" means an embankment or ridge of either natural or man-made materials used to prevent the movement of liquids, sludges, solids, or other materials.

(6) "Disposal area" means the area containing by-product materials to which the requirements of Criterion 6 apply.

(7) "Existing portion" means that land surface area of an existing surface impoundment on which significant quantities of uranium or thorium by-product materials had been placed prior to September 30, 1983.

(8) "Groundwater" means water below the land surface in a zone of saturation. For the purposes of this chapter, groundwater is the water contained within an aquifer as defined above.

(9) "Leachate" means any liquid, including any suspended or dissolved components in the liquid, that has percolated through or drained from the by-product material.

(10) "Licensed site" means the area contained within the boundary of a location under the control of persons generating or storing by-product materials under a department license.

(11) "Liner" means a continuous layer of natural or man-made materials, beneath or on the sides of a surface impoundment which restricts the downward or lateral escape of by-product material, hazardous constituents, or leachate.

(12) "Point of compliance" is the site specific location in the uppermost aquifer where the groundwater protection standard must be met.

(13) "Surface impoundment" means a natural topographic depression, man-made excavation, or diked area, which is designed to hold an accumulation of liquid wastes or wastes containing free liquids, and which is not an injection well.

(14) "Uppermost aquifer" means the geologic formation nearest the natural ground surface that is an aquifer, as well as lower aquifers that are hydraulically interconnected with this aquifer within the facility's property boundary.

[Statutory Authority: RCW 70.98.050 and 70.98.080. 91-16-109 (Order 187), § 246-252-010, filed 8/7/91, effective 9/7/91. Statutory Authority: RCW 43.70.040. 91-02-049 (Order 121), recodified as § 246-252-010, filed 12/27/90, effective 1/31/91. Statutory Authority: RCW 70.98.080. 87-01-031 (Order 2450), § 402-52-050, filed 12/11/86.]

**WAC 246-252-020 Purpose of uranium mill tailings areas.** Uranium mill tailing areas shall be used only for disposal of radioactive wastes originating from the exploration, mining, and milling of uranium.

[Statutory Authority: RCW 43.70.040. 91-02-049 (Order 121), recodified as § 246-252-020, filed 12/27/90, effective 1/31/91. Statutory Authority: RCW 70.98.080 and chapter 70.121 RCW. 86-17-027 (Order 2406), § 402-52-090, filed 8/13/86.]

**WAC 246-252-030 Criteria related to disposition of uranium mill tailings or wastes.** As used in this section, the term "as low as reasonably achievable" has the same meaning as in WAC 246-220-007. The term by-product material means the tailings or wastes produced by the extraction or concentration of uranium or thorium from any ore processed primarily for its source material content.

As required by WAC 246-235-110(6), each applicant for a license to possess and use source material in conjunction with uranium or thorium milling, or by-product material at sites formerly associated with such milling, is required to include in a license application proposed specifications relating to the milling operation and the disposition of tailings or waste resulting from such milling activities. This section establishes criteria relating to the siting, operation, decontamination, decommissioning, and reclamation of mills and tailings or waste systems and sites at which such mills and systems are located and site and by-product material ownership. Applications must clearly demonstrate how these criteria have been addressed. The specifications shall be developed considering the expected full capacity of tailings or waste systems and the lifetime of mill operations. Where later expansions of systems or operations may be likely, the amenability of the disposal system to accommodate increased capacities without degradation in long-term stability and other performance factors shall be evaluated.

Licensees or applicants may propose alternatives to the specific requirements in these criteria. The alternative

proposals may take into account local or regional conditions, including geology, topography, hydrology, and meteorology. The department may find that the proposed alternatives meet the department's requirements if the alternatives will achieve a level of stabilization and containment of the sites concerned, and a level of protection for public health, safety, and the environment from radiological and nonradiological hazards associated with the sites, which is equivalent to, to the extent practicable, or more stringent than the level which would be achieved by the requirements of the standards promulgated by the United States Environmental Protection Agency in 40 CFR 192, Subparts D and E.

(1) Criterion 1 - In selecting among alternative tailings disposal sites or judging the adequacy of existing tailings sites, the following site features which would contribute to meeting the broad objective of permanent isolation of the tailings and associated contaminants from man and the environment for one thousand years to the extent reasonably achievable, and in any case, for at least two hundred years without ongoing active maintenance shall be considered:

(a) Remoteness from populated areas;

(b) Hydrogeologic and other environmental conditions conducive to continued immobilization and isolation of contaminants from groundwater sources; and

(c) Potential for minimizing erosion, disturbance, and dispersion by natural forces over the long term.

The site selection process must be an optimization to the maximum extent reasonably achievable in terms of these features.

In the selection of disposal sites, primary emphasis shall be given to isolation of tailings or wastes, a matter having long-term impacts, as opposed to consideration only of short-term convenience or benefits, such as minimization of transportation or land acquisition costs. While isolation of tailings will be a function of both site characteristics and engineering design, overriding consideration shall be given to siting features given the long-term nature of the tailings hazards.

Tailings shall be disposed in a manner such that no active maintenance is required to preserve the condition of the site.

(2) Criterion 2 - To avoid proliferation of small waste disposal sites, by-product material from in-situ extraction operations, such as residues from solution evaporation or contaminated control processes, and wastes from small remote above ground extraction operations shall be disposed at existing large mill tailings disposal sites; unless, considering the nature of the wastes, such as their volume and specific activity and the costs and environmental impacts of transporting the wastes to a large disposal site, such offsite disposal is demonstrated to be impracticable or the advantage of onsite burial clearly outweighs the benefits of reducing the perpetual surveillance obligations.

(3) Criterion 3 - The "prime option" for disposal of tailings is placement below grade, either in mines or specially excavated pits (that is, where the need for any specially constructed retention structure is eliminated).

The evaluation of alternative sites and disposal methods performed by mill operators in support of their proposed tailings disposal program (provided in applicants' environmental reports) shall reflect serious consideration of this disposal mode. In some instances, below grade disposal may

not be the most environmentally sound approach, such as might be the case if a groundwater formation is relatively close to the surface or not very well isolated by overlying soils and rock. Also, geologic and topographic conditions might make full, below grade burial impracticable; for example, near-surface bedrock could create prominent excavation costs while more suitable alternate sites may be available. Where full below grade burial is not practicable, the size of the retention structures, and the size and steepness of slopes of associated exposed embankments, shall be minimized by excavation to the maximum extent reasonably achievable or appropriate, given the geologic and hydrogeologic conditions at a site. In these cases, it must be demonstrated that an above-grade disposal program will provide reasonably equivalent isolation of the tailings from natural erosional forces.

(4) Criterion 4 - The following site and design criteria shall be adhered to whether tailings or wastes are disposed of above or below grade:

(a) Upstream rainfall catchment areas must be minimized to decrease erosion potential and the size of the probable maximum flood which could erode or wash out sections of the tailings disposal area.

(b) Topographic features shall provide good wind protection.

(c) Embankment and cover slopes shall be relatively flat after final stabilization to minimize erosion potential and to provide conservative factors of safety assuring long-term stability. The broad objective should be to contour final slopes to grades which are as close as possible to those which would be provided if tailings were disposed of below grade; this could, for example, lead to slopes of about ten horizontal to one vertical (10h:1v) or less steep. In general, slopes should not be steeper than about 5h:1v. Where steeper slopes are proposed, reasons why a slope less steep than 5h:1v would be impracticable should be provided, and compensating factors and conditions which make such slopes acceptable should be identified.

(d) A fully self-sustaining vegetative cover shall be established or rock cover employed to reduce wind and water erosion to negligible levels.

Where a full vegetative cover is not likely to be self-sustaining due to climatic conditions, such as in semi-arid and arid regions, rock cover shall be employed on slopes of the impoundment system. The NRC will consider relaxing this requirement for extremely gentle slopes such as those which may exist on the top of the pile.

The following factors shall be considered in establishing the final rock cover design to avoid displacement of rock particles by human and animal traffic or by natural processes, and to preclude undercutting and piping:

(i) Shape, size, composition, gradation of rock particles (excepting bedding material, average particle size shall be at least cobble size or greater);

(ii) Rock cover thickness and zoning of particles by size; and

(iii) Steepness of underlying slopes.

(e) Individual rock fragments shall be dense, sound, and resistant to abrasion, and free from defects that would tend to unduly increase their destruction by water and frost actions. Weak, friable, or laminated aggregate shall not be



used. Shale, rock laminated with shale, and cherts shall not be used.

Rock covering of slopes may not be required where top covers are on the order of ten meters or greater; impoundment slopes are on the order of 10h:1v or less; bulk cover materials have inherently favorable erosion resistance characteristics; and there is negligible drainage catchment area upstream of the pile, and there is good wind protection as described in (a) and (b) of this subsection.

(f) Impoundment surfaces shall be contoured to avoid areas of concentrated surface runoff or abrupt or sharp changes in slope gradient. In addition to rock cover on slopes, areas toward which surface runoff might be directed shall be well protected with substantial rock cover (riprap). In addition to providing for stability of the impoundment systems itself, the overall stability, erosion potential, and geomorphology of surrounding terrain shall be evaluated to assure that there are no processes, such as gully erosion, which would lead to impoundment instability.

(g) The impoundment shall not be located near a capable fault that could cause a maximum credible earthquake larger than that which the impoundment could reasonably be expected to withstand. As used in this criterion, the term "capable fault" has the same meaning as defined in Section III (g) of Appendix A of 10 CFR Part 100. The term "maximum credible earthquake" means that earthquake which would cause the maximum vibratory ground motion based upon an evaluation of earthquake potential considering the regional and local geology and seismology and specific characteristics of local subsurface material.

(h) The impoundment, where feasible, should be designed to incorporate features which will promote deposition of suspended particles. For example, design features which promote deposition of sediment suspended in any runoff which flows into the impoundment area might be utilized; the object of such a design feature would be to enhance the thickness of cover over time.

(5) Criterion 5 - Criteria 5(a) through 5(g) and new Criterion 13 incorporate the basic groundwater protection standards imposed by the United States Environmental Protection Agency in 40 CFR Part 192, Subparts D and E (48 FR 45926; October 7, 1983) which apply during operations and prior to the end of closure. Groundwater monitoring to comply with these standards is required by Criterion 7.

(a) The primary groundwater protection standard is a design standard for surface impoundments used to manage uranium and thorium by-product material. Surface impoundments (except for an existing portion) must have a liner that is designed, constructed, and installed to prevent any migration of wastes out of the impoundment to the adjacent subsurface soil, groundwater, or surface water at any time during the active life (including the closure period) of the impoundment. The liner may be constructed of materials that may allow wastes to migrate into the liner (but not into the adjacent subsurface soil, groundwater, or surface water) during the active life of the facility, provided that impoundment closure includes removal or decontamination of all waste residues, contaminated containment system components (liners, etc.), contaminated subsoils, and structures and equipment contaminated with waste and leachate. For

impoundments that will be closed with the liner material left in place, the liner must be constructed of materials that can prevent wastes from migrating into the liner during the active life of the facility.

(b) The liner required by (a) of this subsection must be:

(i) Constructed of materials that have appropriate chemical properties and sufficient strength and thickness to prevent failure due to pressure gradients (including static head and external hydrogeologic forces), physical contact with the waste or leachate to which they are exposed, climatic conditions, the stress of installation, and the stress of daily operation;

(ii) Placed upon a foundation or base capable of providing support to the liner and resistance to pressure gradients above and below the liner to prevent failure of the liner due to settlement, compression, or uplift; and

(iii) Installed to cover all surrounding earth likely to be in contact with the wastes or leachate.

(c) The applicant or licensee will be exempted from the requirements of (a) of this subsection if the department finds, based on a demonstration by the applicant or licensee, that alternate design and operating practices, including the closure plan, together with site characteristics will prevent the migration of any hazardous constituents into groundwater or surface water at any future time. In deciding whether to grant an exemption, the department will consider:

(i) The nature and quantity of the wastes;

(ii) The proposed alternate design and operation;

(iii) The hydrogeologic setting of the facility, including the attenuative capacity and thickness of the liners and soils present between the impoundment and groundwater or surface water; and

(iv) All other factors which would influence the quality and mobility of the leachate produced and the potential for it to migrate to groundwater or surface water.

(d) A surface impoundment must be designed, constructed, maintained, and operated to prevent overtopping resulting from normal or abnormal operations; overfilling; wind and wave actions; rainfall; run-on; from malfunctions of level controllers, alarms, and other equipment; and human error.

(e) When dikes are used to form the surface impoundment, the dikes must be designed, constructed, and maintained with sufficient structural integrity to prevent massive failure of the dikes. In ensuring structural integrity, it must not be presumed that the liner system will function without leakage during the active life of the impoundment.

(f) Uranium and thorium by-product materials must be managed to conform to the following secondary groundwater protection standard: Hazardous constituents entering the groundwater from a licensed site must not exceed the specified concentration limits in the uppermost aquifer beyond the point of compliance during the compliance period. Hazardous constituents are those constituents identified by the department pursuant to (g) of this subsection. Specified concentration limits are those limits established by the department as indicated in (j) of this subsection. The department will also establish the point of compliance and compliance period on a site specific basis through license conditions and orders. The objective in selecting the point of compliance is to provide the earliest practicable warning that the impoundment is releasing hazardous constituents to the groundwater. The point of compliance



must be selected to provide prompt indication of groundwater contamination on the hydraulically downgradient edge of the disposal area. The department must identify hazardous constituents, establish concentration limits, set the compliance period, and adjust the point of compliance, if needed, when the detection monitoring established under criterion 7 indicates leakage of hazardous constituents from the disposal area.

(g) A constituent becomes a hazardous constituent subject to (j) of this subsection when the constituent:

(i) Is reasonably expected to be in or derived from the by-product material in the disposal area;

(ii) Has been detected in the groundwater in the uppermost aquifer; and

(iii) Is listed in WAC 246-252-050 Appendix A.

(h) The department may exclude a detected constituent from the set of hazardous constituents on a site specific basis if it finds that the constituent is not capable of posing a substantial present or potential hazard to human health or the environment. In deciding whether to exclude constituents, the department will consider the following:

(i) Potential adverse effect on groundwater quality, considering —

(A) The physical and chemical characteristics of the waste in the licensed site, including its potential for migration;

(B) The hydrogeological characteristics of the facility and surrounding land;

(C) The quantity of groundwater and the direction of groundwater flow;

(D) The proximity and withdrawal rates of groundwater users;

(E) The current and future uses of groundwater in the area;

(F) The existing quality of groundwater, including other sources of contamination and their cumulative impact on the groundwater quality;

(G) The potential for health risks caused by human exposure to waste constituents;

(H) The potential damage to wildlife, crops, vegetation, and physical structures caused by exposure to waste constituents;

(I) The persistence and permanence of the potential adverse effects.

(ii) Potential adverse effects on hydraulically-connected surface water quality, considering —

(A) The volume and physical and chemical characteristics of the waste in the licensed site;

(B) The hydrogeological characteristics of the facility and surrounding land;

(C) The quantity and quality of groundwater, and the direction of groundwater flow;

(D) The patterns of rainfall in the region;

(E) The proximity of the licensed site to surface waters;

(F) The current and future uses of surface waters in the area and any water quality standards established for those surface waters;

(G) The existing quality of surface water, including other sources of contamination and the cumulative impact on surface water quality;

(H) The potential for health risks caused by human exposure to waste constituents;

(I) The potential damage to wildlife, crops, vegetation, and physical structures caused by exposure to waste constituents; and

(J) The persistence and permanence of the potential adverse effects.

(i) In making any determinations under (h) and (k) of this subsection about the use of groundwater in the area around the facility, the department will consider any identification of underground sources of drinking water and exempted aquifers made by the United States Environmental Protection Agency.

(j) At the point of compliance, the concentration of a hazardous constituent must not exceed —

(i) The department approved background concentration of that constituent in the groundwater;

(ii) The respective value given in the table in subsection (5)(l) of this section if the constituent is listed in the table and if the background level of the constituent is below the value listed; or

(iii) An alternate concentration limit established by the department.

(k) Conceptually, background concentrations pose no incremental hazards and the drinking water limits in (j)(i) of this subsection state acceptable hazards but these two options may not be practically achievable at a specific site. Alternate concentration limits that present no significant hazard may be proposed by licensees for department consideration. Licensees must provide the basis for any proposed limits including consideration of practicable corrective actions, that limits are as low as reasonably achievable, and information on the factors the department must consider.

The department will establish a site specific alternate concentration limit for a hazardous constituent as provided in (j) of this subsection if it finds that the constituent will not pose a substantial present or potential hazard to human health or the environment as long as the alternate concentration limit is not exceeded. In establishing alternate concentration limits, the department will apply its as low as reasonably achievable criterion in this chapter. The department will also consider the following factors:

(i) Potential adverse effects on groundwater quality, considering —

(A) The physical and chemical characteristics of the waste in the licensed site including its potential for migration;

(B) The hydrogeological characteristics of the facility and surrounding land;

(C) The quantity of groundwater and the direction of groundwater flow;

(D) The proximity and withdrawal rates of groundwater users;

(E) The current and future uses of groundwater in the area;

(F) The existing quality of groundwater, including other sources of contamination and their cumulative impact on the groundwater quality;

(G) The potential for health risks caused by human exposure to waste constituents;

(H) The potential damage to wildlife, crops, vegetation, and physical structures caused by exposure to waste constituents;

- (I) The persistence and permanence of the potential adverse effects.
- (ii) Potential adverse effects on hydraulically-connected surface water quality, considering —
  - (A) The volume and physical and chemical characteristics of the waste in the licensed site;
  - (B) The hydrogeological characteristics of the facility and surrounding land;
  - (C) The quantity and quality of groundwater, and the direction of groundwater flow;
  - (D) The patterns of rainfall in the region;
  - (E) The proximity of the licensed site to surface waters;
  - (F) The current and future uses of surface waters in the area and any water quality standards established for those surface waters;
  - (G) The existing quality of surface water including other sources of contamination and the cumulative impact on surface water quality;
  - (H) The potential for health risks caused by human exposure to waste constituents;
  - (I) The potential damage to wildlife, crops, vegetation, and physical structures caused by exposure to waste constituents; and
  - (J) The persistence and permanence of the potential adverse effects.
- (I) MAXIMUM VALUES FOR GROUNDWATER PROTECTION:

Constituent or Property	Maximum Concentration
	Milligrams per liter
Arsenic	0.05
Barium	1.0
Cadmium	0.01
Chromium	0.05
Lead	0.05
Mercury	0.002
Selenium	0.01
Silver	0.05
Endrin (1,2,3,4,10,10-hexachloro-1,7 -epoxy-1,4,4a,5,6,7,8,9a-octahydro-1, 4-endo, endo-5,8-dimethano naphthalene)	0.0002
Lindane (1,2,3,4,5,6-hexachlorocyclohexane, gamma isomer)	0.004
Methoxychlor (1,1,1-Trichloro-2,2-bis (p-methoxyphenylethane)	0.1
Toxaphene (C <sub>10</sub> H <sub>10</sub> Cl <sub>6</sub> , Technical chlorinated camphene, 67-69 percent chlorine)	0.005
2,4-D (2,4-Dichlorophenoxyacetic acid)	0.1
2,4,5-TP Silvex (2,4,5-Trichlorophenoxypropionic acid)	0.01
	Picocuries per liter
Combined radium - 226 and radium - 228	5
Gross alpha - particle activity (excluding radon and uranium when producing uranium by-product material or thorium when producing thorium by-product material)	15

(m) If the groundwater protection standards established under (f) of this subsection are exceeded at a licensed site, a corrective action program must be put into operation as soon as is practicable, and in no event later than eighteen months after the department finds that the standards have been exceeded. The licensee shall submit the proposed corrective action program and supporting rationale for department approval prior to putting the program into

operation, unless otherwise directed by the department. The objective of the program is to return hazardous constituent concentration levels in groundwater to the concentration limits set as standards. The licensee's proposed program must address removing the hazardous constituents that have entered the groundwater at the point of compliance or treating them in place. The program must also address removing or treating in place any hazardous constituents that exceed concentration limits in groundwater between the point of compliance and the downgradient facility property boundary. The licensee shall continue corrective action measures to the extent necessary to achieve and maintain compliance with the groundwater protection standard. The department will determine when the licensee may terminate corrective action measures based on data from the groundwater monitoring program and other information that provide reasonable assurance that the groundwater protection standard will not be exceeded.

(n) In developing and conducting groundwater protection programs, applicants and licensees shall also consider the following:

(i) Installation of bottom liners (where synthetic liners are used, a leakage detection system must be installed immediately below the liner to ensure major failures are detected if they occur. This is in addition to the groundwater monitoring program conducted as provided in Criterion 7. Where clay liners are proposed or relatively thin, in-situ clay soils are to be relied upon for seepage control, tests must be conducted with representative tailings solutions and clay materials to confirm that no significant deterioration of permeability or stability properties will occur with continuous exposure of clay to tailings solutions. Tests must be run for a sufficient period of time to reveal any effects if they are going to occur (in some cases deterioration has been observed to occur rather rapidly after about nine months of exposure)).

(ii) Mill process designs which provide the maximum practicable recycle of solutions and conservation of water to reduce the net input of liquid to the tailings impoundment.

(iii) Dewatering of tailings by process devices and/or in-situ drainage systems (at new sites, tailings must be dewatered by a drainage system installed at the bottom of the impoundment to lower the phreatic surface and reduce the driving head of seepage, unless tests show tailings are not amenable to such a system. Where in-situ dewatering is to be conducted, the impoundment bottom must be graded to assure that the drains are at a low point. The drains must be protected by suitable filter materials to assure that drains remain free running. The drainage system must also be adequately sized to assure good drainage).

(iv) Neutralization to promote immobilization of hazardous constituents.

(o) Where groundwater impacts are occurring at an existing site due to seepage, action must be taken to alleviate conditions that lead to excessive seepage impacts and restore groundwater quality. The specific seepage control and groundwater protection method, or combination of methods, to be used must be worked out on a site-specific basis. Technical specifications must be prepared to control installation of seepage control systems. A quality assurance, testing, and inspection program, which includes supervision

by a qualified engineer or scientist, must be established to assure the specifications are met.

(p) In support of a tailings disposal system proposal, the applicant/operator shall supply information concerning the following:

(i) The chemical and radioactive characteristics of the waste solutions.

(ii) The characteristics of the underlying soil and geologic formations particularly as they will control transport of contaminants and solutions. This includes detailed information concerning extent, thickness, uniformity, shape, and orientation of underlying strata. Hydraulic gradients and conductivities of the various formations must be determined. This information must be gathered from borings and field survey methods taken within the proposed impoundment area and in surrounding areas where contaminants might migrate to groundwater. The information gathered on boreholes must include both geologic and geophysical logs in sufficient number and degree of sophistication to allow determining significant discontinuities, fractures, and channeled deposits of high hydraulic conductivity. If field survey methods are used, they should be in addition to and calibrated with borehole logging. Hydrologic parameters such as permeability may not be determined on the basis of laboratory analysis of samples alone; a sufficient amount of field testing (e.g., pump tests) must be conducted to assure actual field properties are adequately understood. Testing must be conducted to allow estimating chemi-sorption attenuation properties of underlying soil and rock.

(iii) Location, extent, quality, capacity and current uses of any groundwater at and near the site.

(q) Steps must be taken during stockpiling of ore to minimize penetration of radionuclides into underlying soils; suitable methods include lining and/or compaction of ore storage areas.

(6) Criterion 6 - (a) In cases where waste by-product material is to be permanently disposed, an earthen cover shall be placed over tailings or wastes at the end of the milling operations and the waste disposal area shall be closed in accordance with a design<sup>1</sup> which shall provide reasonable assurance of control of radiological hazard to:

(i) Be effective for one thousand years, to the extent reasonably achievable, and, in any case, for at least two hundred years; and

(ii) Limit releases of Radon-222 from uranium by-product materials, and Radon-220 from thorium by-product materials, to the atmosphere so as to not exceed an average<sup>2</sup> release rate of twenty picocuries per square meter per second ( $\text{pCi}/\text{m}^2\text{s}$ ) to the extent practicable throughout the effective design life determined pursuant to (a)(i) of this subsection. In computing required tailings cover thicknesses, moisture in soils in excess of amounts found normally in similar soils in similar circumstances shall not be considered. Direct gamma exposure from the tailings or wastes should be reduced to background levels. The effects of any thin synthetic layer shall not be taken into account in determining the calculated radon exhalation level. If nonsoil materials are proposed as cover materials, it must be demonstrated that such materials will not crack or degrade by differential settlement, weathering, or other mechanism over long term time intervals.

(b) Near surface materials (i.e., within the top three meters) shall not include mine waste or rock that contains

elevated levels of radium; soils used for near surface cover must be essentially the same, as far as radioactivity is concerned, as that of surrounding soils. This is to insure that surface radon exhalation is not significantly above background because of the cover material itself.

(c) The design requirements in this criterion for longevity and control of radon releases shall apply to any portion of a licensed and/or disposal site unless such portion contains a concentration of radium in land, averaged over areas of one hundred square meters, which, as a result of by-product material does not exceed the background level by more than:

(i) Five picocuries per gram ( $\text{pCi}/\text{g}$ ) of Radium-226, or, in the case of thorium by-product material, Radium-228, averaged over the first fifteen centimeters below the surface; and

(ii) Fifteen  $\text{pCi}/\text{g}$  of Radium-226, or, in the case of thorium by-product material, Radium-228, averaged over fifteen centimeters thick layers more than fifteen centimeters below the surface.

(d) The licensee must also address the nonradiological hazards associated with the wastes in planning and implementing closure. The licensee shall ensure that disposal areas are closed in a manner that minimizes the need for further maintenance. To the extent necessary to prevent threats to human health and the environment, the license shall control, minimize, or eliminate post-closure escape of nonradiological hazardous constituents, leachate, contaminated rainwater, or waste decomposition products to the ground or surface waters or to the atmosphere.

Footnotes:

<sup>1</sup> The standard applies to design. Monitoring for radon after installation of an appropriately designed cover is not required.

<sup>2</sup> This average shall apply to the entire surface of each disposal area over periods of at least one year, but short compared to one hundred years. Radon will come from both uranium by-product materials and from covering material. Radon emissions from covering materials should be estimated as part of developing a closure plan for each site. The standard, however, applies only to emissions from by-product materials to the atmosphere.

(7) Criterion 7 - At least one full year prior to any major site construction, a preoperational monitoring program must be conducted to provide complete baseline data on a milling site and its environs. Throughout the construction and operating phases of the mill, an operational monitoring program must be conducted to complete the following:

(a) To measure or evaluate compliance with applicable standards and regulations;

(b) To evaluate performance of control systems and procedures;

(c) To evaluate environmental impacts of operation; and

(d) To detect potential long-term effects.

The licensee shall establish a detection monitoring program needed for the department to set the site-specific groundwater protection standards in Criterion 5 of this section. For all monitoring under this paragraph, the licensee or applicant will propose for department approval as license conditions, which constituents are to be monitored on a site-specific basis. A detection monitoring program has two purposes. The initial purpose of the program is to detect leakage of hazardous constituents from the disposal area so that the need to set groundwater protection standards is monitored. If leakage is detected, the second purpose of

the program is to generate data and information needed for the department to establish the standards under Criterion 5. The data and information must provide a sufficient basis to identify those hazardous constituents which require concentration limit standards and to enable the department to set the limits for those constituents and the compliance period. They may also need to provide the basis for adjustments to the point of compliance. For licenses in effect September 30, 1983, the detection monitoring programs must have been in place by October 1, 1984. For licenses issued after September 30, 1983, the detection monitoring programs must be in place when specified by the department in orders or license conditions. Once groundwater protection standards have been established pursuant to Criterion 5, the licensee shall establish and implement a compliance monitoring program. The purpose of the compliance monitoring program is to determine that the hazardous constituent concentrations in ground water continue to comply with the standards set by the department. In conjunction with a corrective action program, the licensee shall establish and implement a corrective action monitoring program. The purpose of the corrective action monitoring program is to demonstrate the effectiveness of the corrective actions. Any monitoring program required by this paragraph may be based on existing monitoring programs to the extent the existing programs can meet the stated objective for the program.

(8) Criterion 8 - Milling operations shall be conducted so that all airborne effluent releases are reduced to as low as is reasonably achievable. The primary means of accomplishing this shall be by means of emission controls. Institutional controls, such as extending the site boundary and exclusion area, may be employed to ensure that offsite exposure limits are met, but only after all practicable measures have been taken to control emissions at the source. Notwithstanding the existence of individual dose standards, strict control of emissions is necessary to assure that population exposures are reduced to the maximum extent reasonably achievable and to avoid site contamination. The greatest potential sources of offsite radiation exposure (aside from radon exposure) are dusting from dry surfaces of the tailings disposal area not covered by tailings solution and emissions from yellowcake drying and packaging operations. During operations and prior to closure, radiation doses from radon emissions from surface impoundments shall be kept as low as is reasonably achievable. Checks shall be made and logged hourly of all parameters (e.g., differential pressure and scrubber water flow rate) which determine the efficiency of yellowcake stack emission control equipment operation. It shall be determined whether or not conditions are within a range prescribed to ensure that the equipment is operating consistently near peak efficiency; corrective action shall be taken when performance is outside of prescribed ranges. Effluent control devices shall be operative at all times during drying and packaging operations and whenever air is exhausting from the yellowcake stack.

Drying and packaging operations shall terminate when controls are inoperative. When checks indicate the equipment is not operating within the range prescribed for peak efficiency, actions shall be taken to restore parameters to the prescribed range. When this cannot be done without shutdown and repairs, drying and packaging operations shall cease as soon as practicable.

Operations may not be restarted after cessation due to off-normal performance until needed corrective actions have been identified and implemented. All such cessations, corrective actions, and restarts shall be reported to the department in writing, within ten days of the subsequent restart.

To control dusting from tailings, that portion not covered by standing liquids shall be wetted or chemically stabilized to prevent or minimize blowing and dusting to the maximum extent reasonably achievable. This requirement may be relaxed if tailings are effectively sheltered from wind, such as may be the case where they are disposed of below grade and the tailings surface is not exposed to wind. Consideration shall be given in planning tailings disposal programs to methods which would allow phased covering and reclamation of tailings impoundments since this will help in controlling particulate and radon emissions during operation. To control dustings from diffuse sources, such as tailings and ore pads where automatic controls do not apply, operators shall develop written operating procedures specifying the methods of control which will be utilized.

Milling operations producing or involving thorium by-product material shall be conducted in such a manner as to provide reasonable assurance that the annual dose equivalent does not exceed twenty-five millirems to the whole body, seventy-five millirems to the thyroid, and twenty-five millirems to any other organ of any member of the public as a result of exposures to the planned discharge of radioactive materials, Radon-220 and its daughters excepted, to the general environment.

Uranium and thorium by-product materials shall be managed so as to conform to the applicable provisions of Title 40 of the Code of Federal Regulations, Part 440, Ore Mining and Dressing Point Source Category: Effluent Limitations Guidelines and New Source Performance Standards, Subpart C, Uranium, Radium, and Vanadium Ores Subcategory, as codified on January 1, 1983.

The licensee shall establish a detection monitoring program needed to establish the groundwater protection standards in subsection (5)(f) of this section. A detection monitoring program has two purposes. The initial purpose of the program is to detect leakage of hazardous constituents from the disposal area so that the need to set groundwater protection standards is monitored. If leakage is detected, the second purpose of the program is to generate data and information needed for the department to establish the standards under subsection (5)(f) of this section. The data and information must provide a sufficient basis to identify those hazardous constituents which require concentration limit standards and to enable the department to set the limits for those constituents and the compliance period. They may also need to provide the basis for adjustments to the point of compliance. For licenses in effect September 30, 1983, the detection monitoring programs must have been in place by October 1, 1984. For licenses issued after September 30, 1983, the detection monitoring programs must be in place when specified by the department in orders or license conditions. Once groundwater protection standards have been established pursuant to subsection (5)(f) of this section, the licensee shall establish and implement a compliance monitoring program. The purpose of the compliance monitoring program is to determine that the hazardous

constituent concentrations in groundwater continue to comply with the standards set by the department. In conjunction with a corrective action program, the licensee shall establish and implement a corrective action monitoring program. The purpose of the corrective action monitoring program is to demonstrate the effectiveness of the corrective actions. Any monitoring program required by this paragraph may be based on existing monitoring programs to the extent the existing programs can meet the stated objective for the program.

Daily inspections of tailings or waste retention systems must be conducted by a qualified engineer or scientist and documented. The department must be immediately notified of any failure in a tailings or waste retention system which results in a release of tailings or waste into unrestricted areas, and/or of any unusual conditions (conditions not contemplated in the design of the retention system) which if not corrected could indicate the potential or lead to failure of the system and result in a release of tailings or waste into unrestricted areas.

(9) Criterion 9 - (a) Pursuant to chapter 70.121 RCW, and except as otherwise provided, financial surety arrangements for site reclamation and long-term surveillance and control which may consist of surety bonds, cash deposits, certificates of deposit, deposits of government securities, irrevocable letters or lines of credit, or any combination of the above, or other arrangements approved by the department, milling operations shall be established for source material to ensure the protection of the public health and safety in the event of abandonment, default, or other inability of the licensee to meet the requirements of the act and these regulations.

(i) The amount of funds to be ensured by such surety arrangements shall be based on department-approved cost estimates.

(ii) Self-insurance, or any arrangement which essentially constitutes self-insurance (e.g., a contract with a state or federal agency), will not satisfy the surety requirement, since this provides no additional assurance other than that which already exists through license requirements.

(b) The arrangements required in (a) of this subsection shall be established prior to commencement of operations to assure that sufficient funds will be available to carry out decontamination and decommissioning of the facility.

(c) Amendments to licenses in effect on the effective date of this regulation may be issued, providing that the required surety arrangements are established within ninety days after the effective date of this subsection.

(d) For source material milling operations, the amount of funds to be ensured by such surety arrangements shall be based on department-approved cost estimates in an approved plan for (i) decontamination and decommissioning of mill buildings and the milling site to levels which would allow unrestricted use of these areas upon decommissioning, and (ii) the reclamation of tailings and/or waste disposal areas in accordance with the technical criteria delineated in this section. The licensee shall submit this plan in conjunction with an environmental report that addresses the expected environmental impacts of the milling operation, decommissioning and tailings reclamation, and evaluates alternatives for mitigating these impacts. In addition, the surety shall cover the payment of the charge for long-term surveillance and control required by the department. In establishing

specific surety arrangements, the licensee's cost estimates shall take into account total costs that would be incurred if an independent contractor were hired to perform the decommissioning and reclamation work. In order to avoid unnecessary duplication and expense, the department may accept financial sureties that have been consolidated with financial or surety arrangements established to meet requirements of other federal or state agencies and/or local governing bodies for such decommissioning, decontamination, reclamation, and long-term site surveillance, provided such arrangements are considered adequate to satisfy these requirements and that portion of the surety which covers the decommissioning and reclamation of the mill, mill tailings site and associated areas, and the long-term funding charge is clearly identified and committed for use in accomplishing these activities. The licensee's surety mechanism will be reviewed annually by the department to assure that sufficient funds will be available for completion of the reclamation plan if the work had to be performed by an independent contractor. The amount of surety liability should be adjusted to recognize any increases or decreases resulting from inflation, changes in engineering plans, activities performed, and any other conditions affecting costs. Regardless of whether reclamation is phased through the life of the operation or takes place at the end of operations, an appropriate portion of surety liability shall be retained until final compliance with the reclamation plan is determined. This will yield a surety that is at least sufficient at all times to cover the costs of decommissioning and reclamation of the areas that are expected to be disturbed before the next license renewal. The term of the surety mechanism must be open ended, unless it can be demonstrated that another arrangement would provide an equivalent level of assurance. This assurance could be provided with a surety instrument which is written for a specific period of time (e.g., five years), yet which must be automatically renewed unless the surety notifies the beneficiary (the state regulatory agency) and the principal (the licensee) some reasonable time (e.g., ninety days) prior to the renewal date of their intention not to renew. In such a situation, the surety requirement still exists and the licensee would be required to submit an acceptable replacement surety within a brief period of time to allow at least sixty days for the department to collect.

Proof of forfeiture must not be necessary to collect the surety so that in the event that the licensee could not provide an acceptable replacement surety within the required time, the surety shall be automatically collected prior to its expiration. The conditions described above would have to be clearly stated on any surety instrument which is not open-ended and must be agreed to by all parties.

Long-term care requirements. Pursuant to chapter 70.121 RCW, and as otherwise provided in WAC 246-235-080 (6)(d), a long-term care trust fund shall be established by source material milling licensees prior to the issuance of the license.

(10) Criterion 10 - (a) A minimum charge of two hundred fifty thousand dollars (1978 United States dollars) accrued as specified in WAC 246-235-080 (6)(d) to cover the costs of long-term surveillance shall be paid by each mill operator to the agency prior to the termination of a uranium or thorium mill license. If site surveillance or control requirements at a particular site are determined, on the basis

of a site-specific evaluation, to be significantly greater than those specified in (a) of this subsection (e.g., if fencing is determined to be necessary), variance in funding requirements may be specified by the department. The total charge to cover the costs of long-term surveillance shall be such that, with an assumed one percent annual real interest rate, the collected funds will yield interest in an amount sufficient to cover the annual costs of site surveillance. The charge will be adjusted annually prior to actual payments to recognize inflation. The inflation rate to be used is that indicated by the change in the consumer price index published by the United States Department of Labor, Bureau of Labor Statistics. Contributions by a licensee to the long-term care trust fund pursuant to chapter 70.121 RCW shall be transferred to cover the costs assessed under this criterion.

(11) Criterion 11 - These criteria relating to ownership of tailings and their disposal sites become effective on November 8, 1981, and apply to all licenses terminated, issued, or renewed after that date.

Any uranium or thorium milling license or tailings license shall contain such terms and conditions as the United States Nuclear Regulatory Commission determines necessary to assure that prior to termination of the license, the licensee will comply with ownership requirements of this criterion for sites used for tailings disposal.

Title to the by-product material licensed pursuant to WAC 246-252-030 and land, including any interests therein (other than land owned by the United States or by the state of Washington) which is used for the disposal of any such by-product material, or is essential to ensure the long-term stability of such disposal site, shall be transferred to the United States or the state of Washington. In view of the fact that physical isolation must be the primary means of long term control, and government land ownership is a desirable supplementary measure, ownership of certain-severable subsurface interests (for example, mineral rights) may be determined to be unnecessary to protect the public health and safety and the environment. In any case, the applicant/operator must demonstrate a serious effort to obtain such subsurface rights, and must, in the event that certain rights cannot be obtained, provide notification in local public land records of the fact that the land is being used for the disposal of radioactive material and is subject to either a United States Nuclear Regulatory Commission general or specific license prohibiting the disruption and disturbance of the tailings. In some rare cases, such as may occur with deep burial where no ongoing site surveillance will be required, surface land ownership transfer requirements may be waived. For licenses issued before November 8, 1981, the United States Nuclear Regulatory Commission may take into account the status of the ownership of such land, and interests therein, and the ability of a licensee to transfer title and custody thereof to the United States or the state. If the United States Nuclear Regulatory Commission, subsequent to title transfer, determines that use of the surface or subsurface estates, or both, of the land transferred to the United States or to a state will not endanger the public health, safety, welfare or environment, the United States Nuclear Regulatory Commission may permit the use of the surface or subsurface estates, or both, of such land in a manner consistent with the provisions provided in these criteria. If the United States Nuclear Regulatory Commission

permits such use of such land, it will provide the person who transferred such land with the right of first refusal with respect to such use of such land.

Material and land transferred to the United States or a state in accordance with this criterion must be transferred without cost to the United States or a state other than administrative and legal costs incurred in carrying out such transfer.

The provisions of this part, respecting transfer of title and custody to land and tailings and wastes, do not apply in the case of lands held in trust by the United States for any Indian tribe, or lands owned by such Indian tribe subject to a restriction against alienation imposed by the United States. In the case of such lands which are used for the disposal of byproduct material, as defined in this section, the licensee shall enter into arrangements with the United States Nuclear Regulatory Commission as may be appropriate to assure the long-term surveillance of such lands by the United States.

(12) Criterion 12 - The final disposition of tailings or wastes at milling sites should be such that ongoing active maintenance is not necessary to preserve isolation. As a minimum, annual site inspections must be conducted by the government agency retaining ultimate custody of the site where tailings or wastes are stored, to confirm the integrity of the stabilized tailings or waste systems, and to determine the need, if any, for maintenance and/or monitoring. Results of the inspection must be reported to the United States Nuclear Regulatory Commission within sixty days following each inspection. The United States Nuclear Regulatory Commission may require more frequent site inspections if, on the basis of a site-specific evaluation, such a need appears necessary, due to the features of a particular tailings or waste disposal system.

(13) Criterion 13 - Secondary groundwater protection standards required by Criterion 5 of this section are concentration limits for individual hazardous constituents. The list of constituents found in Appendix A of this chapter, chapter 246-252 WAC, identifies the constituents for which standards must be set and complied with if the specific constituent is reasonably expected to be in or derived from the by-product material and has been detected in groundwater. For purposes of this criterion, the property of gross alpha activity will be treated as if it is a hazardous constituent. Thus, when setting standards under subsection (5)(j) of this section, the department will also set a limit for gross alpha activity.

[Statutory Authority: RCW 70.98.050. 94-01-073, § 246-252-030, filed 12/9/93, effective 1/9/94. Statutory Authority: RCW 70.98.050 and 70.98.080. 91-16-109 (Order 187), § 246-252-030, filed 8/7/91, effective 9/7/91. Statutory Authority: RCW 43.70.040. 91-02-049 (Order 121), recodified as § 246-252-030, filed 12/27/90, effective 1/31/91. Statutory Authority: RCW 70.98.080. 87-01-031 (Order 2450), § 402-52-100, filed 12/11/86. Statutory Authority: Chapter 70.121 RCW. 81-16-031 (Order 1683), § 402-52-100, filed 7/28/81.]

#### **WAC 246-252-040 Continuing dose assessment.**

Each uranium or thorium milling operation shall submit in writing to the department by May 1 and November 1 of each year, reports specifying the quantities of each of the principle radionuclides released to unrestricted areas in liquid and in gaseous effluent during the previous six months of operations. This data shall be reported in a manner that will permit the department to confirm the potential annual



radiation doses to the public. All data from the radiological and nonradiological environmental monitoring program will also be submitted for the same time period and frequency as specified above. The data shall be reported in a manner which will allow the department to confirm the potential annual radiation doses to the public. In addition, the report due each May 1 shall include a dose assessment to assure compliance with 40 CFR 190 Environmental Radiation Protection Standards for Nuclear Power Operation and an annual land use survey to include but not be limited to water supply information, location and number of occupants, time spent at each location by occupants, amount and type of locally grown stored feed and amount of pasture consumed by local livestock.

[Statutory Authority: RCW 43.70.040. 91-02-049 (Order 121), recodified as § 246-252-040, filed 12/27/90, effective 1/31/91. Statutory Authority: Chapter 70.121 RCW. 81-16-031 (Order 1683), § 402-52-200, filed 7/28/81.]

## WAC 246-252-050 Appendix A.

### Hazardous Constituents

- Acetonitrile (Ethanenitrile)  
 Acetophenone (Ethanone, 1-phenyl)  
 3-(alpha-Acetylbenzyl)-4-hydroxycoumarin and salts (Warfarin)  
 2-Acetylaminofluorene (Acetamide, N-(9H-fluoren-2-yl)-)  
 Acetyl chloride (Ethanoyl chloride)  
 1-Acetyl-2-thiourea (Acetamide, N-(aminothioxomethyl)-)  
 Acrolein (2-Propenal)  
 Acrylamide (2-Propenamidine)  
 Acrylonitrile (2-Propenenitrile)  
 Aflatoxins  
 Aldrin (1,2,3,4,10,10-Hexachloro-1,4,4a,5,8,8a,8b-hexahydro-endo, exo-1,4:5,8-Dimethanonaphthalene)  
 Allyl alcohol (2-Propen-1-ol)  
 Aluminum phosphide  
 4-Aminobiphenyl ([1,1'-Biphenyl]-4-amine)  
 6-Amino-1,1a,2,8,8a,8b-hexahydro-8-(hydroxymethyl)-8a-methoxy-5-methyl-carbamate azirino[2',3':3,4] pyrrolo [1,2-a] indole-4,7-dione, (ester) (Mitomycin C) (Azirino[2'3':3,4] pyrrolo (1,2-a) indole-4,7-dione, 6-amino-8-[(amino-carbonyl)oxy)methyl]-1,1a,2,8,8a,8b-hexahydro-8a-methoxy-5-methyl-)  
 5-(Aminomethyl)-3-isoxazolol (3(2H)-Isoxazolone, 5-(aminomethyl)-) 4-Aminopyridine (4-Pyridinamine)  
 Amitrole (1H-1,2,4-Triazol-3-amine)  
 Aniline (Benzenamine)  
 Antimony and compounds, N.O.S.\*  
 Aramite (Sulfurous acid, 2-chloroethyl-, 2-[4-(1,1-dimethylethyl)phenoxy]-1-methylethyl ester)  
 Arsenic and compounds, N.O.S.\*  
 Arsenic acid (Orthoarsenic acid)  
 Arsenic pentoxide (Arsenic (V) oxide)  
 Arsenic trioxide (Arsenic (III) oxide)  
 Auramine (Benzenamine, 4,4'-carbonimidoylbis [N,N-Dimethyl-, monohydrochloride])  
 Azaserine (L-Serine, diazoacetate (ester))  
 Barium and compounds, N.O.S.\*  
 Barium cyanide  
 Benz[c]acridine (3,4-Benzacridine)  
 Benz[a]anthracene (1,2-Benzanthracene)  
 Benzene (Cyclohexatriene)  
 Benzenearsonic acid (Arsenic acid, phenyl-)  
 Benzene, dichloromethyl- (Benzal chloride)  
 Benzenethiol (Thiophenol)  
 Benzidine ([1,1'-Biphenyl]-4,4' diamine)  
 Benzo[b]fluoranthene (2,3-Benzofluoranthene)  
 Benzo[j]fluoranthene (7,8-Benzofluoranthene)  
 Benzo[a]pyrene (3,4-Benzopyrene)  
 p-Benzoquinone (1,4-Cyclohexadienedione)  
 Benzotrithloride (Benzene, trichloromethyl)  
 Benzyl chloride (Benzene, (chloromethyl)-)
- Beryllium and compounds, N.O.S.\*  
 Bis(2-chloroethoxy)methane (Ethane, 1,1'-[methylenebis(oxy)]bis(2-chloro-))  
 Bis(2-chloroethyl) ether (Ethane, 1,1'-oxybis[2-chloro-])  
 N,N-Bis(2-chloroethyl)-2-naphthylamine (Chlornaphazine)  
 Bis(2-chloroisopropyl) ether (Propane, 2,2'-oxybis[2-chloro-])  
 Bis(chloromethyl) ether (Methane, oxybis[chloro-])  
 Bis(2-ethylhexyl) phthalate (1,2-Benzenedicarboxylic acid, bis(2-ethylhexyl) ester)  
 Bromoacetone (2-Propanone, 1-bromo-)  
 Bromomethane (Methyl bromide)  
 4-Bromophenyl phenyl ether (Benzene, 1-bromo-4-phenoxy-)  
 Brucine (Strychnidin-10-one, 2,3-dimethoxy-)  
 2-Butanone peroxide (Methyl ethyl ketone, peroxide)  
 Butyl benzyl phthalate (1,2-Benzenedicarboxylic acid, butyl phenylmethyl ester)  
 2-sec-Butyl-4,6-dinitrophenol (DNBP) (Phenol, 2,4-dinitro-6-(1-methylpropyl)-)  
 Cadmium and compounds, N.O.S.\*  
 Calcium chromate (Chromic acid, calcium salt)  
 Calcium cyanide  
 Carbon disulfide (Carbon bisulfide)  
 Carbon oxyfluoride (Carbonyl fluoride)  
 Chloral (Acetaldehyde, trichloro-)  
 Chlorambucil (Butanoic acid, 4-[bis(2-chloroethyl)amino]benzene-)  
 Chlordane (alpha and gamma isomers) (4,7-Methanoindan, 1,2,4,5,6,7,8,8-octachloro-3,4,7,7a-tetrahydro-) (alpha and gamma isomers)  
 Chlorinated benzenes, N.O.S.\*  
 Chlorinated ethane, N.O.S.\*  
 Chlorinated fluorocarbons, N.O.S.\*  
 Chlorinated naphthalene, N.O.S.\*  
 Chlorinated phenol, N.O.S.\*  
 Chloroacetaldehyde (Acetaldehyde, chloro-)  
 Chloroalkyl ethers, N.O.S.\*  
 p-Chloroaniline (Benzenamine, 4-chloro-)  
 Chlorobenzene (Benzene, chloro-)  
 Chlorobenzilate (Benzenoacetic acid, 4-chloro-alpha-(4-chlorophenyl)-alpha-hydroxy-, ethyl ester)  
 p-Chloro-m-cresol (Phenol, 4-chloro-3-methyl)  
 1-Chloro-2,3-epoxypropane (Oxirane, 2-(chloromethyl)-)  
 2-Chloroethyl vinyl ether (Ethene, (2-chloroethoxy)-)  
 Chloroform (Methane, trichloro-)  
 Chloromethane (Methyl chloride)  
 Chloromethyl methyl ether (Methane, chloromethoxy-)  
 2-Chloronaphthalene (Naphthalene, betachloro-)  
 2-Chlorophenol (Phenol, o-chloro-)  
 1-(o-Chlorophenyl)thiourea (Thiourea, (2-chlorophenyl)-)  
 3-Chloropropionitrile (Propanenitrile, 3-chloro-)  
 Chromium and compounds, N.O.S.\*  
 Chrysene (1,2-Benzphenanthrene)  
 Citrus red No. 2 (2-Naphthol, 1-[(2,5-dimethoxyphenyl)azo]-)  
 Coal tars  
 Copper cyanide  
 Creosote (Creosote, wood)  
 Cresols (Cresylic acid) (Phenol, methyl-)  
 Crotonaldehyde (2-Butenal)  
 Cyanides (soluble salts and complexes), N.O.S.\*  
 Cyanogen (Ethanedinitrile)  
 Cyanogen bromide (Bromide cyanide)  
 Cyanogen chloride (Chlorine cyanide)  
 Cycasin(beta-D-Glucopyranoside, (methyl-ONN-azoxy)methyl-)  
 2-Cyclohexyl-4,6-dinitrophenol (Phenol, 2-cyclohexyl-4,6-dinitro-)  
 Cyclophosphamide (2H-1,3,2, -Oxazaphosphorine, [bis(2-chloroethyl)amino]-tetrahydro-,2-oxide)  
 Daunomycin (5,12-Naphthacenedione, (8S-cis)-8-acetyl-10-[(3-amino-2,3,6-trideoxy)-alpha-L-lyxo-hexopyranosyl]oxy]-7,8,9,10-tetrahydro-6,8,11-trihydroxy-1-methoxy-y-)  
 DDD (Dichlorodiphenyldichloroethane) (Ethane, 1,1-dichloro-2,2-bis(p-chlorophenyl)-)  
 DDE (Ethylene, 1,1-dichloro-2,2-bis(4-chlorophenyl)-)  
 DDT (Dichlorodiphenyltrichloroethane) (Ethane, 1,1,1-trichloro-2,2-bis(p-chlorophenyl)-)  
 Diallate (S-(2,3-dichloroallyl) diisopropylthiocarbamate)  
 Dibenz[a,h]acridine (1,2,5,6-Dibenzacridine)  
 Dibenz[a,j]acridine (1,2,7,8-Dibenzacridine)



- Dibenz[a,h]anthracene (1,2,5,6-Dibenzanthracene)  
 7H-Dibenzo[c,g]carbazole (3,4,5,6-Dibenzcarbazole)  
 Dibenzo[a,e]pyrene (1,2,4,5-Dibenzpyrene)  
 Dibenzo[a,h]pyrene (1,2,5,6-Dibenzpyrene)  
 Dibenz[a,i]pyrene (1,2,7,8-Dibenzpyrene)  
 1,2-Dibromo-3-chloropropane (Propane, 1,2-dibromo-3-chloro-)  
 1,2-Dibromoethane (Ethylene dibromide)  
 Dibromomethane (Methylene bromide)  
 Di-n-butyl phthalate (1,2-Benzenedicarboxylic acid, dibutyl ester)  
 o-Dichlorobenzene (Benzene, 1,2-dichloro-)  
 m-Dichlorobenzene (Benzene, 1,3-dichloro-)  
 p-Dichlorobenzene (Benzene, 1,4-dichloro-)  
 Dichlorobenzene, N.O.S.\* (Benzene, dichloro-, N.O.S.\*)  
 3,3'-Dichlorobenzidine ([1,1'-Biphenyl]-4,4'-diamine, 3,3'-dichloro-)  
 1,4-Dichloro-2-butene (2-Butene, 1,4-dichloro-)  
 Dichlorodifluoromethane (Methane, dichlorodifluoro-)  
 1,1-Dichloroethane (Ethylidene dichloride)  
 1,2-Dichloroethane (Ethylene dichloride)  
 trans-1,2-Dichloroethene (1,2-Dichloroethylene)  
 Dichloroethylene, N.O.S.\* (Ethene, dichloro-, N.O.S.\*)  
 1,1-Dichloroethylene (Ethene, 1,1-dichloro-)  
 Dichloromethane (Methylene chloride)  
 2,4-Dichlorophenol (Phenol, 2,4-dichloro-)  
 2,6-Dichlorophenol (Phenol, 2,6-dichloro-)  
 2,4-Dichlorophenoxyacetic acid (2,4-D), salts and esters (Acetic acid, 2,4-dichlorophenoxy-, salts and esters)  
 Dichlorophenylarsine (Phenyl dichloroarsine)  
 Dichloropropane, N.O.S.\* (Propane, dichloro-, N.O.S.\*)  
 1,2-Dichloropropane (Propylene dichloride)  
 Dichloropropanol, N.O.S.\* (Propanol, dichloro-, N.O.S.\*)  
 Dichloropropene, N.O.S.\* (Propene, dichloro-, N.O.S.\*)  
 1,3-Dichloropropene (1-Propene, 1,3-dichloro-)  
 Dieldrin (1,2,3,4,10,10-hexachloro-6,7-epoxy-1,4,4a,5,6,7,8,8a-octa-hydro-endo, exo-1,4:5,8-Dimethanonaphthalene)  
 1,2:3,4-diepoxybutane (2,2'-Bioxirane)  
 Diethylarsine (Arsine, diethyl-)  
 N,N-Diethylhydrazine (Hydrazine, 1,2-diethyl)  
 O,O-Diethyl S-methyl ester of phosphorodithioic acid (Phosphorodithioic acid, O,O-diethyl S-methyl ester)  
 O,O-Diethylphosphoric acid, O-p-nitrophenyl ester (Phosphoric acid, diethyl p-nitrophenyl ester)  
 Diethyl phthalate (1,2-Benzenedicarboxylic acid, diethyl ester)  
 O,O-Diethyl O-2-pyrazinyl phosphorothioate (Phosphorothioic acid, O,O-diethyl O-pyrazinyl ester)  
 Diethylstilbesterol (4,4'-Stilbenediol, alpha, alpha-diethyl, bis(dihydrogen phosphate, (E)-)  
 Dihydrosafrole (Benzene, 1,2-methylenedioxy-4-propyl-)  
 3,4-Dihydroxy-alpha-(methylamino)methyl benzyl alcohol (1,2-Benzenediol, 4-[1-hydroxy-2-(methylamino)ethyl]-)  
 Dilsopropylfluorophosphate (DFP) (Phosphorofluoric acid, bis(1-methylethyl) ester)  
 Dimethoate (Phosphorodithioic acid, O,O-dimethyl S-[2-(methylamino)-2-oxoethyl] ester)  
 3,3'-Dimethoxybenzidine ([1,1'-Biphenyl]-4,4'-diamine, 3,3'-di-methoxy-)  
 p-Dimethylaminoazobenzene (Benzenamine, N,N-dimethyl-4-(phenylazo)-)  
 7,12-Dimethylbenz[a]anthracene (1,2-Benzanthracene, 7,12-dimethyl-)  
 3,3'-Dimethylbenzidine ([1,1'-Biphenyl]-4,4'-diamine, 3,3'-dimethyl-)  
 Dimethylcarbamoyl chloride (Carbamoyl chloride, dimethyl-)  
 1,1-Dimethylhydrazine (Hydrazine, 1,1-dimethyl-)  
 1,2-Dimethylhydrazine (Hydrazine, 1,2-dimethyl-)  
 3,3-Dimethyl-1-(methylthio)-2-butanone, O-[(methylamino) carbonyl] oxime (Thiofanox)  
 alpha, alpha-Dimethylphenethylamine (Ethanamine, 1,1-dimethyl-2-phenyl-)  
 2,4-Dimethylphenol (Phenol, 2,4-dimethyl-)  
 Dimethyl phthalate (1,2-Benzenedicarboxylic acid, dimethyl ester)  
 Dimethyl sulfate (Sulfuric acid, dimethyl ester)  
 Dinitrobenzene, N.O.S.\* (Benzene, dinitro-, N.O.S.\*)  
 4,6-Dinitro-o-cresol and salts (Phenol, 2,4-dinitro-6-methyl-, and salts)  
 2,4-Dinitrophenol (Phenol, 2,4-dinitro-)  
 2,4-Dinitrotoluene (Benzene, 1-methyl-2,4-dinitro-)  
 2,6-Dinitrotoluene (Benzene, 1-methyl-2,6-dinitro-)  
 Di-n-octyl phthalate (1,2-Benzenedicarboxylic acid, dioctyl ester)  
 1,4-Dioxane (1,4-Diethylene oxide)  
 Diphenylamine (Benzenamine, N-phenyl-)  
 1,2-Diphenylhydrazine (Hydrazine, 1,2-diphenyl-)  
 Di-n-propylnitrosamine (N-Nitroso-di-n-propylamine)  
 Disulfoton (O,O-diethyl S-[2-(ethylthio)ethyl] phosphorodithioate)  
 2,4-Dithiobiuret (Thioimidodicarbonic diamide)  
 Endosulfan (5-Norbornene, 2,3-dimethanol, 1,4,5,6,7,7-hexachloro-, cyclic sulfite)  
 Endrin and metabolites (1,2,3,4,10,10-hexachloro-6,7-epoxy-1,4,4a,5,6,7,8,8a-octahydro-endo,endo-1,4:5,8-dimethanonaphthalene, and metabolites)  
 Ethyl carbamate (Urethan) (Carbamic acid, ethyl ester)  
 Ethyl cyanide (propanenitrile)  
 Ethylenebisdithiocarbamic acid, salts and esters  
 (1,2-Ethanediylobis carbamodithioic acid, salts and esters)  
 Ethyleneimine (Aziridine)  
 Ethylene oxide (Oxirane)  
 Ethylenethiourea (2-Imidazolidinethione)  
 Ethyl methacrylate (2-Propenoic acid, 2-methyl-, ethyl ester)  
 Ethyl methanesulfonate (Methanesulfonic acid, ethyl ester)  
 Fluoranthene (Benzo[j,k]fluorene)  
 Fluorine  
 2-Fluoroacetamide (Acetamide, 2-fluoro-)  
 Fluoroacetic acid, sodium salt (Acetic acid, fluoro-, sodium salt)  
 Formaldehyde (Methylene oxide)  
 Formic acid (Methanoic acid)  
 Glycidylaldehyde (1-Propanol-2,3-epoxy)  
 Halomethane, N.O.S.\*  
 Heptachlor (4,7-Methano-1H-indene, 1,4,5,6,7,8,8-heptachloro-3a,4,7,7a-tetrahydro-)  
 Heptachlor epoxide (alpha, beta, and gamma isomers) (4,7-Methano-1H-indene, 1,4,5,6,7,8,8-heptachloro-2,3-epoxy-3a,4,7,7-tetrahydro-, alpha, beta, and gamma isomers)  
 Hexachlorobenzene (Benzene, hexachloro-)  
 Hexachlorobutadiene (1,3-Butadiene, 1,1,2,3,4,4-hexachloro-)  
 Hexachlorocyclohexane (all isomers) (Lindane and isomers)  
 Hexachlorocyclopentadiene (1,3-Cyclopentadiene, 1,2,3,4,5,5-hexachloro-)  
 Hexachloroethane (Ethane, 1,1,1,2,2,2-hexachloro-)  
 1,2,3,4,10,10-Hexachloro-1,4,4a,5,8,8a-hexahydro-1,4:5,8-endo, endo-dimethanonaphthalene (Hexachlorohexa-hydro-endo, endo-dimethanonaphthalene)  
 Hexachlorophene (2,2'-Methylenebis(3,4,6-trichlorophenol))  
 Hexachloropropene (1-Propene, 1,1,2,3,3,3-hexachloro-)  
 Hexaethyl tetraphosphate (Tetraphosphoric acid, hexaethyl ester)  
 Hydrazine (Diamine)  
 Hydrocyanic acid (Hydrogen cyanide)  
 Hydrofluoric acid (Hydrogen fluoride)  
 Hydrogen sulfide (Sulfur hydride)  
 Hydroxydimethylarsine oxide (Cacodylic acid)  
 Indeno (1,2,3-cd)pyrene (1,10-(1,2-phenylene)pyrene)  
 Iodomethane (Methyl iodide)  
 Iron dextran (Ferric dextran)  
 Isocyanic acid, methyl ester (Methyl isocyanate)  
 Isobutyl alcohol (1-Propanol, 2-methyl-)  
 Isosafrole (Benzene, 1,2-methylenedioxy-4-allyl-)  
 Kepone (Decachlorooctahydro-1,3,4-Methano-2H-cyclobuta[cd]pentalen-2-one)  
 Lasiocarpine (2-Butenoic acid, 2-methyl-,7-[(2,3-dihydroxy-2-(1-methoxyethyl)-3-methyl-1-oxobutoxy)methyl]-2,3,5,7a-tetrahydro-1H-pyrrolizin-1-yl ester)  
 Lead and compounds, N.O.S.\*  
 Lead acetate (Acetic acid, lead salt)  
 Lead phosphate (Phosphoric acid, lead salt)  
 Lead subacetate (Lead, bis(acetato-0)tetrahydroxytri-)  
 Maleic anhydride (2,5-Furandione)  
 Maleic hydrazide (1,2-Dihydro-3,6-pyridazinedione)  
 Malononitrile (Propanedinitrile)  
 Melphalan (Alanine, 3-[p-bis(2-chloroethyl)amino]phenyl-,L-)  
 Mercury fulminate (Fulminic acid, mercury salt)  
 Mercury and compounds, N.O.S.\*  
 Methacrylonitrile (2-Propenenitrile, 2-methyl-)  
 Methanethiol (Thiomethanol)  
 Methapyriline (Pyridine, 2-[(2-dimethylamino)ethyl]-2-thenylamino-)  
 Metholmyl (Acetimidic acid, N-[(methylcarbamoyl)oxy]thio-, methyl ester)  
 Methoxychlor (Ethane, 1,1,1-trichloro-2,2'-bis(p-methoxyphenyl)-)  
 2-Methylaziridine (1,2-Propylenimine)

- 3-Methylcholanthrene (Benz[*j*]aceanthrylene, 1,2-dihydro-3-methyl-)  
Methyl chlorocarbonate (Carbonochloridic acid, methyl ester)  
4,4'-Methylenebis(2-chloroaniline) (Benzenamine, 4,4'-methylenebis(2-chloro-))  
Methyl ethyl ketone (MEK) (2-Butanone)  
Methyl hydrazine (Hydrazine, methyl-)  
2-Methylacetonitrile (Propanenitrile, 2-hydroxy-2-methyl-)  
Methyl methacrylate (2-Propenoic acid, 2-methyl-, methyl ester)  
Methyl methanesulfonate (Methanesulfonic acid, methyl ester)  
2-Methyl-2-(methylthio)propionaldehyde-*o*-(methylcarbonyl) oxime (Propanal, 2-methyl-2-(methylthio)-, 0-[(methylamino)carbonyl]oxime)  
N-Methyl-N'-nitro-N-nitrosoguanidine (Guanidine, N-nitroso-N-methyl-N'-nitro-)  
Methyl parathion (0,0-dimethyl 0-(4-nitrophenyl) phosphorothioate)  
Methylthiouracil (4-1H-Pyrimidinone, 2,3-dihydro-6-methyl-2-thioxo-)  
Molybdenum and compounds, N.O.S.\*  
Mustard gas (Sulfide, bis(2-chloroethyl)-)  
Naphthalene  
1,4-Naphthoquinone (1, 4-Naphthalenedione)  
1-Naphthylamine (alpha-Naphthylamine)  
2-Naphthylamine (beta-Naphthylamine)  
1-Naphthyl-2-thiourea (Thiourea, 1-naphthalenyl-)  
Nickel and compounds, N.O.S.\*  
Nickel carbonyl (Nickel tetracarbonyl)  
Nickel cyanide (Nickel (II) cyanide)  
Nicotine and salts (Pyridine, (S)-3-(1-methyl-2-pyrrolidinyl)-, and salts)  
Nitric oxide (Nitrogen (II) oxide)  
p-Nitroaniline (Benzenamine, 4-nitro-)  
Nitrobenzene (Benzene, nitro-)  
Nitrogen dioxide (Nitrogen (IV) oxide)  
Nitrogen mustard and hydrochloride salt (Ethanamine, 2-chloro-, N-(2-chloroethyl) - N-methyl-, and hydrochloride salt)  
Nitrogen mustard N-Oxide and hydrochloride salt (Ethanamine, 2-chloro-N-(2-chloroethyl)-N-methyl-, and hydrochloride salt)  
Nitroglycerine (1,2,3-Propanetriol, trinitrate)  
4-Nitrophenol (Phenol, 4-nitro-)  
4-Nitroquinoline-1-oxide (Quinoline, 4-nitro-1-oxide-)  
Nitrosamine, N.O.S.\*  
N-Nitrosodi-n-butylamine (1-Butanamine, N-butyl-N-nitroso-)  
N-Nitrosodiethanolamine (Ethanol, 2,2'-(nitrosoimino)bis-)  
N-Nitrosodiethylamine (Ethanamine, N-ethyl-N-nitroso-)  
N-Nitrosodimethylamine (Dimethylnitrosamine)  
N-Nitroso-N-ethylurea (Carbamide, N-ethyl-N-nitroso-)  
N-Nitrosomethylethylamine (Ethanamine, N-methyl-N-nitroso-)  
N-Nitroso-N-methylurea (Carbamide, N-methyl-N-nitroso-)  
N-Nitroso-N-methylurethane (Carbamic acid, methylnitroso-, ethyl ester)  
N-Nitrosomethylvinylamine (Ethenamine, N-methyl-N-nitroso-)  
N-Nitrosomorpholine (Morpholine, N-nitroso-)  
N-Nitrososarcosine (Sarcosine, N-nitroso-)  
N-Nitrosopiperidine (Pyridine, hexahydro-, N-nitroso-)  
Nitrosopyrrolidine (Pyrrole, tetrahydro-, N-nitroso-)  
N-Nitrososarcosine (Sarcosine, N-nitroso-)  
5-Nitro-*o*-toluidine (Benzenamine, 2-methyl-5-nitro-)  
Octamethylpyrophosphoramide (Diphosphoramidate, octamethyl-)  
Osmium tetroxide (Osmium (VIII) oxide)  
7-Oxabicyclo[2.2.1]heptane-2,3-dicarboxylic acid (Endothal)  
Paraldehyde (1,3,5-Trioxane, 2,4,6-trimethyl-)  
Parathion (Phosphorothioic acid, 0,0-diethyl 0-(*p*-nitrophenyl)ester)  
Pentachlorobenzene (Benzene, pentachloro-)  
Pentachloroethane (Ethane, pentachloro-)  
Pentachloronitrobenzene (PCNB) (Benzene, pentachloronitro-)  
Pentachlorophenol (Phenol, pentachloro-)  
Phenacetin (Acetamide, N-(4-ethoxyphenyl)-)  
Phenol (Benzene, hydroxy-)  
Phenylenediamine (Benzenediamine)  
Phenylmercury acetate (Mercury, acetatophenyl-)  
N-Phenylthiourea (Thiourea, phenyl-)  
Phosgene (Carbonyl chloride)  
Phosphine (Hydrogen phosphide)  
Phosphorodithioic acid, 0,0-diethyl S-[(ethylthio)methyl] ester (Phorate)  
Phosphorothioic acid, 0,0-dimethyl 0-[*p*-((dimethylamino)sulfonyl)phenyl] ester (Famphur)  
Phthalic acid esters, N.O.S.\* (Benzene, 1, 2-dicarboxylic acid, esters, N.O.S.\*)  
Phthalic anhydride (1,2-Benzenedicarboxylic acid anhydride)  
2-Picoline (Pyridine, 2-methyl-)  
Polychlorinated biphenyl, N.O.S.\*  
Potassium cyanide  
Potassium silver cyanide (Argentate(1-), dicyano-, potassium)  
Pronamide (3,5-Dichloro-N-(1,1-dimethyl-2-propynyl)benzamide)  
1,3-Propane sultone (1,2-Oxathiolane, 2,2-dioxide)  
n-Propylamine (1-Propanamine)  
Propylthiouracil (Undecamethylenediamine, N,N'-bis(2-chlorobenzyl-), dihydrochloride)  
2-Propyn-1-ol (Propargyl alcohol)  
Pyridine  
Radium -226 and -228  
Reserpine (Yohimban-16-carboxylic acid, 11,17-dimethoxy-18-[3,4,5-trimethoxybenzoyl]oxy-, methyl ester)  
Resorcinol (1,3-Benzenediol)  
Saccharin and salts (1,2-Benzoisothiazolin-3-one, 1,1-dioxide, and salts)  
Safrole (Benzene, 1,2-methylenedioxy-4-allyl-)  
Selenious acid (Selenium dioxide)  
Selenium and compounds, N.O.S.\*  
Selenium sulfide (Sulfur selenide)  
Selenourea (Carbamimidoseleenoic acid)  
Silver and compounds, N.O.S.\*  
Silver cyanide  
Sodium cyanide  
Streptozotocin (D-Glucopyranose, 2-deoxy-2-(3-methyl-3-nitro-soureido)-)  
Strontium sulfide  
Strychnine and salts (Strychnidin-10-one, and salts)  
1,2,4,5-Tetrachlorobenzene (Benzene, 1,2,4,5-tetrachloro-)  
2,3,7,8-Tetrachlorodibenzo-*p*-dioxin (TCDD) (Dibenzo-*p*-dioxin, 2,3,7,8-tetrachloro-)  
Tetrachloroethane, N.O.S.\* (Ethane, tetrachloro-, N.O.S.\*)  
1,1,1,2-Tetrachlorethane (Ethane, 1,1,1,2-tetrachloro-)  
1,1,2,2-Tetrachlorethane (Ethane, 1,1,2,2-tetrachloro-)  
Tetrachloroethane (Ethane, 1,1,2,2-tetrachloro-)  
Tetrachloromethane (Carbon tetrachloride)  
2,3,4,6-Tetrachlorophenol (Phenol, 2,3,4,6-tetrachloro-)  
Tetraethylthiopyrophosphate (Dithiopyrophosphoric acid, tetraethyl-ester)  
Tetraethyl lead (Plumbane, tetraethyl-)  
Tetraethylpyrophosphate (Pyrophosphoric acid, tetraethyl ester)  
Tetranitromethane (Methane, tetranitro-)  
Thallium and compounds, N.O.S.\*  
Thallic oxide (Thallium (III) oxide)  
Thallium (I) acetate (Acetic acid, thallium (I) salt)  
Thallium (I) carbonate (Carbonic acid, dithallium (I) salt)  
Thallium (I) chloride  
Thallium (I) nitrate (Nitric acid, thallium (I) salt)  
Thallium selenite  
Thallium (I) sulfate (Sulfuric acid, thallium (I) salt)  
Thioacetamide (Ethanethioamide)  
Thiosemicarbazide (Hydrazinecarbothioamide)  
Thiourea (Carbamide thio-)  
Thiuram (Bis(dimethylthiocarbamoyl) disulfide)  
Thorium and compounds, N.O.S.\*, when producing thorium by-product material  
Toluene (Benzene, methyl-)  
Toluenediamine (Diaminotoluene)  
*o*-Toluidine hydrochloride (Benzenamine, 2-methyl-, hydrochloride)  
Tolylene diisocyanate (Benzene, 1,3-diisocyanatomethyl-)  
Toxaphene (Camphene, octachloro-)  
Tribromomethane (Bromoform)  
1,2,4-Trichlorobenzene (Benzene, 1,2,4-trichloro-)  
1,1,1-Trichloroethane (Methyl chloroform)  
1,1,2-Trichloroethane (Ethane, 1,1,2-trichloro-)  
Trichloroethene (Trichloroethylene)  
Trichloromethanethiol (Methanethiol, trichloro-)  
Trichloromonofluoromethane (Methane, trichlorofluoro-)  
2,4,5-Trichlorophenol (Phenol, 2,4,5-trichloro-)  
2,4,6-Trichlorophenol (Phenol, 2,4,6-trichloro-)  
2,4,5-Trichlorophenoxyacetic acid (2,4,5-T) (Acetic acid, 2,4,5-trichlorophenoxy-)  
2,4,5-Trichlorophenoxypropionic acid (2,4,5-TP) (Silvex) (Propionic acid, 2-(2,4,5-trichlorophenoxy)-)  
Trichloropropane, N.O.S.\* (Propane, trichloro-, N.O.S.\*)  
1,2,3-Trichloropropane (Propane, 1,2,3-trichloro-)

0,0,0-Triethyl phosphorothioate (Phosphorothioic acid, 0,0,0-triethyl ester)  
 sym-Trinitrobenzene (Benzene, 1,3,5-trinitro-)  
 Tris(1-aziridinyl) phosphine sulfide (Phosphine sulfide, tris(1-aziridinyl-)  
 Tris(2,3-dibromopropyl) phosphate (1-Propanol, 2,3-dibromo-, phosphate)  
 Trypan blue (2,7-Naphthalenedisulfonic acid, 3,3'-[(3,3'-dimethyl (1,1'-  
 biphenyl)- 4,4'-diyl)bis(azo)]bis(5-amino-4-hydroxy-, tetrasodium  
 salt)  
 Uracil mustard (Uracil 5-[bis(2-chloroethyl)amino]-)  
 Uranium and compounds, N.O.S.\*  
 Vanadic acid, ammonium salt (ammonium vanadate)  
 Vanadium pentoxide (Vanadium (V) oxide)  
 Vinyl chloride (Ethene, chloro-)  
 Zinc cyanide  
 Zinc phosphide

\* The abbreviation N.O.S. (not otherwise specified) signifies those members of the general class not specifically listed by name in this list.

[Statutory Authority: RCW 43.70.040. 91-02-049 (Order 121), recodified as § 246-252-050, filed 12/27/90, effective 1/31/91. Statutory Authority: RCW 70.98.080. 87-01-031 (Order 2450), § 402-52-300, filed 12/11/86.]

**Reviser's note:** The brackets and enclosed material in the text of the above section occurred in the copy filed by the agency.

## Chapter 246-254 WAC

### RADIATION PROTECTION—FEES

#### WAC

246-254-001	Purpose and scope.
246-254-010	Definitions.
246-254-020	Payment of fees.
246-254-030	Small business discount provision and optional fee payment schedule applicable to radioactive materials licensees.
246-254-040	Denial, revocation, suspension, and reinstatement.
246-254-050	Method of payment.
246-254-053	Radiation machine facility registration fees.
246-254-070	Fees for specialized radioactive material licenses.
246-254-080	Fees for medical and veterinary radioactive material licenses.
246-254-090	Fees for industrial radioactive material licenses.
246-254-100	Fees for laboratory radioactive material licenses.
246-254-110	Fees for reciprocity.
246-254-120	Fees for licensing and compliance actions.
246-254-130	Radioactive waste disposal site surveillance fee.
246-254-140	Fees for uranium, thorium and other mineral processors.
246-254-150	Fees for perpetual care and maintenance.
246-254-160	Fees for airborne emissions of radioactive materials.
246-254-170	Failure by applicant or licensee to pay prescribed fees.

#### DISPOSITION OF SECTIONS FORMERLY CODIFIED IN THIS CHAPTER

246-254-057	License fees for radioactive materials. [Statutory Authority: RCW 43.70.040. 91-02-049 (Order 121), recodified as § 246-254-057, filed 12/27/90, effective 1/31/91. Statutory Authority: RCW 43.20A.055. 87-21-016 (Order 2545), § 440-44-057, filed 10/9/87; 86-08-054 (Order 2359), § 440-44-057, filed 3/28/86; 85-13-007 (Order 2238), § 440-44-057, filed 6/7/85; 85-06-024 (Order 2209), § 440-44-057, filed 2/27/85. Statutory Authority: RCW 70.98.080. 83-24-014 (Order 2050), § 440-44-057, filed 11/30/83. Statutory Authority: RCW 43.20A.055. 83-12-058 (Order 1965), § 440-44-057, filed 6/1/83. Statutory Authority: 1982 c 201. 82-17-021 (Order 1860), § 440-44-057, filed 8/9/82.] Repealed by 91-22-027 (Order 208), filed 10/29/91, effective 11/29/91. Statutory Authority: RCW 43.70.110.
246-254-058	Fees for additional service. [Statutory Authority: RCW 43.70.040. 91-02-049 (Order 121), recodified as § 246-254-058, filed 12/27/90, effective 1/31/91. Statutory Authority: RCW 43.20A.055. 85-13-007 (Order 2238),

§ 440-44-058, filed 6/7/85.] Repealed by 91-22-027 (Order 208), filed 10/29/91, effective 11/29/91. Statutory Authority: RCW 43.70.110.  
 246-254-999 Site use permit fee. [Statutory Authority: RCW 43.70.040. 91-02-049 (Order 121), recodified as § 246-254-999, filed 12/27/90, effective 1/31/91. Statutory Authority: Chapter 70.98 RCW and 1985 c 383. 85-20-021 (Order 2283), § 440-44-060, filed 9/23/85. Statutory Authority: RCW 43.20A.055. 83-12-058 (Order 1965), § 440-44-060, filed 6/1/83.] Repealed by 91-22-027 (Order 208), filed 10/29/91, effective 11/29/91. Statutory Authority: RCW 43.70.110.

**WAC 246-254-001 Purpose and scope.** This chapter establishes fees charged for licensing, permitting, registration, and inspection services rendered by the division of radiation protection as authorized under chapters 43.70, 70.98, and 70.121 RCW. These fees apply to owners and operators of radiation generating machines, users of radioactive material, operators of low-level radioactive waste disposal facilities, owners and operators of facilities emitting airborne radioactivity, and owners and operators of certain mineral processing and uranium or thorium milling operations and their associated tailings or waste.

[Statutory Authority: RCW 43.70.110. 91-22-027 (Order 208), § 246-254-001, filed 10/29/91, effective 11/29/91. Statutory Authority: RCW 43.70.040. 91-02-049 (Order 121), recodified as § 246-254-001, filed 12/27/90, effective 1/31/91. Statutory Authority: RCW 70.98.080. 87-01-031 (Order 2450), § 402-70-010, filed 12/11/86; 79-12-073 (Order 1459), § 402-70-010, filed 11/30/79, effective 1/1/80.]

**WAC 246-254-010 Definitions.** As used in this chapter, the following definitions apply:

(1) "Application" means a completed RHF-1 or equivalent with supporting documentation requesting the department to grant authority to receive, possess, use, transfer, own or acquire radioactive material.

(2) "Compliance inspection" means a routinely scheduled visit to the licensee's facility and/or temporary job site(s) for the purpose of determining compliance with the radioactive material license and applicable regulations. This service is covered by the annual fee for the radioactive material license.

(3) "Department" means the department of health which has been designated as the state radiation control agency.

(4) "Direct staff time" means all work time directly applicable to or associated with a specific radioactive material licensee and includes license file review, inspection preparation, on-site visits, report writing, review and acknowledgement of correspondence, review of license applications, renewals and amendment requests, telephone contacts, and staff or management conferences specifically related to the license. Travel time is not considered direct staff time.

(5) "Emission unit" means the point of release of airborne emissions of radioactive material.

(6) "Environmental cleanup monitoring" means an on-site visit by the department to a licensee's facility or site of operation to determine the status of corrective actions to remove environmental radiation contamination resulting from the licensee's operation. Such a monitoring visit may include, but is not limited to, the review of the licensee's records pertaining to the environmental cleanup, observation of the licensee's cleanup work, sampling by the department

for analysis, associated laboratory work, and the analysis of the information collected by the department.

(7) "Facility" means all buildings, structures and operations on one contiguous site.

(8) "Follow-up inspection" means an on-site visit to a licensee's facility to verify that prompt action was taken to correct significant items of noncompliance found by the department in a previous inspection. The first follow-up inspection is covered by the annual fee for the radioactive material license.

(9) "Inspection" means an official examination or observation by the department including but not limited to tests, surveys and monitoring to determine compliance with rules, regulations, orders, requirements and conditions of the department.

(10) "Investigation" means an on-site visit to a licensee's facility or site of operation when, in the department's judgment, it is required for the purpose of reviewing specific conditions, allegations, or other information regarding unusual conditions, operations, or practices. This service is covered by the annual fee for the radioactive material license.

(11) "License" means a license issued by the department in accordance with the regulations adopted by the department.

(12) "New license application" means a request to use radioactive material from a person not currently a licensee or from a current licensee requesting authorization to use radioactive material in a new way such that a change of fee category is required.

(13) "Perpetual care and maintenance" means further maintenance, surveillance or other care of milling or tailings impoundment sites after termination of the site operator's decommissioning responsibilities and license.

(14) "Registration" means registration with the department by any person possessing a source of ionizing radiation in accordance with regulations adopted by the department.

(15) "Sealed source and device evaluation" means a radiological safety evaluation performed by the department on the design, manufacture, and test data of any single sealed source and/or device model for the purpose of registering the sealed source or device with the United States Nuclear Regulatory Commission.

[Statutory Authority: RCW 43.70.110. 91-22-027 (Order 208), § 246-254-010, filed 10/29/91, effective 11/29/91. Statutory Authority: RCW 43.70.040. 91-02-049 (Order 121), recodified as § 246-254-010, filed 12/27/90, effective 1/31/91. Statutory Authority: RCW 70.98.080. 87-01-031 (Order 2450), § 402-70-020, filed 12/11/86; 79-12-073 (Order 1459), § 402-70-020, filed 11/30/79, effective 1/1/80.]

**WAC 246-254-020 Payment of fees.** (1) Applicants, licensees, permittees, and registrants requesting or receiving licenses, permits, registrations, and actions or services by the department shall pay the applicable fee or fees for the license, permit, registration, and action or service provided by the department.

(2) The department shall charge a fee for each:

(a) Radiation machine facility registration;

(b) Radioactive material license;

(c) Service or action with respect to a radioactive material licensee not otherwise covered by fees;

(d) Cubic foot of low-level radioactive waste volume received at a commercial disposal site;

(e) Kilogram of uranium or thorium milled from ore; and

(f) Air emission permit.

(3) The department shall charge a fee for each radioactive material license based on the single highest fee category describing activities subject to the conditions of the license.

(4) The department shall charge the applicable license fee for each category when multiple licenses are required.

(5) The department may require multiple radioactive material licenses based upon:

(a) Physical separation of operations;

(b) Organizational separations within a licensee's operation;

(c) Complexity of uses of radioactive material such that two or more fee categories would apply to the operation.

(6) Each licensee, permittee, or registrant shall:

(a) Remit the full fee (i) at the fee rate established by rule at the time such fee is paid, and (ii) at least thirty days prior to the annual anniversary date for licensees or the biennial expiration date for registrants or (iii) on a payment schedule as provided in WAC 246-254-030.

(b) Consider the annual anniversary to be the month and day of the expiration date of the existing radioactive material license.

(7) The department shall refund one-half of the fee if an application is withdrawn prior to issuance of a radioactive material license.

(8) If there is a change by the applicant, licensee, permittee or registrant resulting in a higher fee category, the applicant, licensee, permittee, or registrant shall pay an additional fee prorated for the remainder of the fee interval.

(9) Each licensee, permittee, or registrant shall remit the full amount of any quarterly billing or individual billing for licensing or compliance actions within thirty days of receipt of the bill.

(10) Fees due on or after the effective date of these regulations shall be at the rate prescribed in this chapter.

[Statutory Authority: RCW 43.70.110. 91-22-027 (Order 208), § 246-254-020, filed 10/29/91, effective 11/29/91. Statutory Authority: RCW 43.70.040. 91-02-049 (Order 121), recodified as § 246-254-020, filed 12/27/90, effective 1/31/91. Statutory Authority: RCW 70.98.080. 87-01-031 (Order 2450), § 402-70-030, filed 12/11/86; 79-12-073 (Order 1459), § 402-70-030, filed 11/30/79, effective 1/1/80.]

**WAC 246-254-030 Small business discount provision and optional fee payment schedule applicable to radioactive materials licensees.** (1) Small business may receive a twenty-five percent discount on radioactive materials license fees specified in WAC 246-254-070, 246-254-080, 246-254-090, and 246-254-100.

(2) To qualify for the discount, the business shall:

(a) Be a corporation, partnership, sole proprietorship, or other legal entity formed for the purpose of making a profit;

(b) Be independently owned and operated from all other businesses (i.e., not a subsidiary of a parent company); and

(c) Have fifty or fewer employees.

(3) To receive the discount, the license applicant at the time of initial license request, or the licensee at the time of annual billing shall:

(a) Certify, on the business' letterhead or appropriate departmental form, the business meets the conditions in subsection (2) of this section;

(b) Sign the certification as the chief executive officer of the business or as an official designee;

(c) Have the certification notarized;

(d) Enclose the payment with the certification; and

(e) Submit the certification and payment in accordance with instructions provided by the department.

(4) The department may verify certifications and will suspend any radioactive materials license if the applicant/ licensee:

(a) Failed to pay the required fee; or

(b) Made an invalid or false certification.

(5) Upon request of any radioactive materials licensee or license applicant, the department may accept semiannual or quarterly payments in lieu of the required annual license fee, provided:

(a) A written payment schedule setting specific due dates and payment amounts is submitted; and

(b) The total payments per the schedule equal the fee in effect at the time such fee payment schedule is accepted by the department.

[Statutory Authority: RCW 43.70.110. 91-22-027 (Order 208), § 246-254-030, filed 10/29/91, effective 11/29/91. Statutory Authority: RCW 43.70.040. 91-02-049 (Order 121), recodified as § 246-254-030, filed 12/27/90, effective 1/31/91. Statutory Authority: RCW 43.20A.055. 86-12-039 (Order 2382), § 440-44-059, filed 5/30/86.]

**WAC 246-254-040 Denial, revocation, suspension, and reinstatement.** The department shall:

(1) Deny an application if the appropriate fee is not received;

(2) Suspend or revoke a license, permit, or registration if a required fee is not received;

(3) Refund no fees if a license, permit or registration is denied, revoked, or suspended;

(4) Require reapplication for a license, permit, or registration after denial or revocation including fees as required under this chapter.

[Statutory Authority: RCW 43.70.110. 91-22-027 (Order 208), § 246-254-040, filed 10/29/91, effective 11/29/91.]

**WAC 246-254-050 Method of payment.** Licensees, permittees and registrants shall:

(1) Submit fee payments by check, draft or money order made payable to the department of health; and

(2) Include fee payment with the application for license or submit the fee by mail, in person, or by courier to the address provided in the bill or bill correspondence.

[Statutory Authority: RCW 43.70.110. 91-22-027 (Order 208), § 246-254-050, filed 10/29/91, effective 11/29/91. Statutory Authority: RCW 43.70.040. 91-02-049 (Order 121), recodified as § 246-254-050, filed 12/27/90, effective 1/31/91. Statutory Authority: RCW 70.98.080. 87-01-031 (Order 2450), § 402-70-050, filed 12/11/86; 79-12-073 (Order 1459), § 402-70-050, filed 11/30/79, effective 1/1/80.]

**WAC 246-254-053 Radiation machine facility registration fees.** (1) Persons owning and/or leasing and using radiation-producing machines shall submit an eighty-nine dollar registration fee to the department at the time of application and every two years thereafter. In addition:

(a) For dentists, veterinarians, and podiatrists, add:

(i) Ninety dollars for the first tube; and

(ii) Forty-two dollars for each additional tube.

(b) For hospitals and medical or chiropractic facilities, add:

(i) Two hundred fifty dollars for the first tube; and

(ii) One hundred twenty dollars for each additional tube.

(c) For industrial, research, and other uses, add:

(i) One hundred forty dollars for the first tube; and

(ii) Forty-two dollars for each additional tube.

(2) The department shall charge a maximum total fee of five thousand five hundred dollars for any facility or group of facilities where an in-house, full-time staff of at least two or more is devoted entirely to in-house radiation safety.

(3) A penalty fee of eighty-nine dollars shall be charged for late registration or late reregistration.

(4) A fee of eighty-nine dollars shall be charged for review of medical x-ray shielding calculations and floor plans submitted under WAC 246-225-030. This fee shall be added to the registration fee described above.

(5) A penalty fee of eighty-nine dollars shall be charged to a facility where submittal of medical x-ray shielding calculations and floor plans is not made before x-ray machine installation as required under WAC 246-225-030. This penalty fee shall be added to the registration fee described above.

(6) Facilities electing to consolidate x-ray machine registrations into a single registration shall be able to demonstrate and document that their businesses are under one business license.

(7) No additional tube fee shall be charged for electron microscopes, mammographic x-ray machines or airport baggage cabinet x-ray systems. Only the base registration fee described above is applicable.

[Statutory Authority: RCW 43.70.110, [43.70.]250 and chapter 70.98 RCW. 96-11-043, § 246-254-053, filed 5/8/96, effective 6/28/96; 95-12-004, § 246-254-053, filed 5/25/95, effective 6/25/95; 94-11-010, § 246-254-053, filed 5/5/94, effective 6/5/94; 93-13-019 (Order 372), § 246-254-053, filed 6/8/93, effective 7/9/93. Statutory Authority: RCW 43.70.110. 91-22-027 (Order 208), § 246-254-053, filed 10/29/91, effective 11/29/91. Statutory Authority: RCW 43.70.040. 91-02-049 (Order 121), recodified as § 246-254-053, filed 12/27/90, effective 1/31/91. Statutory Authority: RCW 43.20B.110. 89-16-064 (Order 2839), § 440-44-050, filed 7/31/89, effective 8/31/89. Statutory Authority: RCW 43.20A.055. 86-08-054 (Order 2359), § 440-44-050, filed 3/28/86. Statutory Authority: Chapter 70.98 RCW and 1985 c 383. 85-20-021 (Order 2283), § 440-44-050, filed 9/23/85. Statutory Authority: RCW 43.20A.055. 85-13-007 (Order 2238), § 440-44-050, filed 6/7/85; 83-12-058 (Order 1965), § 440-44-050, filed 6/1/83. Statutory Authority: 1982 c 201. 82-13-011 (Order 1825), § 440-44-050, filed 6/4/82.]

**WAC 246-254-070 Fees for specialized radioactive material licenses.** (1) Persons licensed or authorized to possess or use radioactive material in the following special categories shall forward annual fees to the department as follows:

(a) Four thousand three hundred seventy dollars for operation of a single nuclear pharmacy.

(b) Seven thousand four hundred sixty dollars for operation of a single nuclear laundry.

(c) Seven thousand four hundred sixty dollars for a license authorizing a single facility to use more than one curie of unsealed radioactive material in the manufacture and

distribution of radioactive products or devices containing radioactive material.

(d) Two thousand six hundred twenty dollars for a license authorizing a single facility to use less than or equal to one curie of unsealed radioactive material or any quantity of previously sealed sources in the manufacture and distribution of products or devices containing radioactive material.

(e) Six hundred eighty dollars for a license authorizing the receipt and redistribution from a single facility of manufactured products or devices containing radioactive material.

(f) Five thousand dollars for a license authorizing decontamination services operating from a single facility.

(g) Two thousand three hundred seventy dollars for a license authorizing waste brokerage including the possession, temporary storage at a single facility, and over-packing only of radioactive waste.

(h) One thousand sixty dollars for a license authorizing equipment servicing involving:

(i) Incidental use of calibration sources;

(ii) Maintenance of equipment containing radioactive material; or

(iii) Possession of sealed sources for purpose of sales demonstration only.

(i) One thousand nine hundred eighty dollars for a license authorizing health physics services, leak testing, or calibration services.

(j) One thousand two hundred forty dollars for a civil defense license.

(k) Three hundred seventy dollars for a license authorizing possession of special nuclear material as pacemakers or depleted uranium as shielding.

(2) Persons licensed or authorized to possess and use radioactive material in the following broad scope categories shall forward annual fees to the department as follows:

(a) Fourteen thousand eight hundred dollars for a license authorizing possession of atomic numbers three through eighty-three with maximum authorized possession of any single isotope greater than one curie.

(b) Six thousand eight hundred forty dollars for a license authorizing possession of atomic numbers three through eighty-three with maximum authorized possession of any single isotope greater than 0.1 curie but less than or equal to one curie.

(c) Five thousand five hundred dollars for a license authorizing possession of atomic numbers three through eighty-three with maximum authorized possession less than or equal to 0.1 curie.

(3) Persons licensed or authorized to possess or use radioactive material which are not covered by any of the annual license fees described in WAC 246-254-070 through 246-254-100, shall pay fees as follows:

(a) An initial application fee of one thousand dollars;

(b) Billing at the rate of ninety dollars for each hour of direct staff time associated with issuing and maintaining the license and for the inspection of the license; and

(c) Any fees for additional services as described in WAC 246-254-120.

(d) The initial application fee will be considered a credit against billings for direct staff charges but is otherwise nonrefundable.

(4) Persons licensed or authorized to possess or use radioactive material in a facility for radioactive waste processing, including resource recovery, volume reduction, decontamination activities, or other waste treatment, but not permitting commercial on-site disposal, shall pay fees as follows:

(a) A nonrefundable initial application fee for a new license of sixteen thousand dollars which shall be credited to the applicant's quarterly billing described in (b) of this subsection; and

(b) Quarterly billings for actual direct and indirect costs incurred by the department including, but not limited to, license renewal, license amendments, compliance inspections, a resident inspector for time spent on the licensee's premises as deemed necessary by the department, laboratory and other support services, and travel costs associated with staff involved in the foregoing.

[Statutory Authority: RCW 43.70.110, [43.70.]250 and chapter 70.98 RCW. 96-11-043, § 246-254-070, filed 5/8/96, effective 6/28/96; 95-12-004, § 246-254-070, filed 5/25/95, effective 6/25/95; 94-11-011 § 246-254-070, filed 5/5/94, effective 6/5/94; 93-13-019 (Order 372), § 246-254-070, filed 6/8/93, effective 7/9/93. Statutory Authority: RCW 43.70.110. 91-22-027 (Order 208), § 246-254-070, filed 10/29/91, effective 11/29/91.]

**WAC 246-254-080 Fees for medical and veterinary radioactive material licenses.** (1) Persons licensed or authorized to possess or use radioactive material in the following medical or veterinary categories shall forward annual fees to the department as follows:

(a) Three thousand seven hundred dollars for operation of a mobile nuclear medicine program from a single base of operation.

(b) Two thousand seven hundred dollars for a license authorizing groups II and III of WAC 246-235-120 for diagnostic nuclear medicine at a single facility.

(c) Two thousand three hundred forty dollars for a license authorizing groups IV and V of WAC 246-235-120 for medical therapy at a single facility.

(d) Three thousand seven hundred twenty dollars for a license authorizing groups II or III and groups IV or V of WAC 246-235-120 for full diagnostic and therapy services at a single facility.

(e) Two thousand dollars for a license authorizing group VI of WAC 246-235-120 for brachytherapy at a single facility.

(f) One thousand two hundred forty dollars for a license authorizing brachytherapy or gamma stereotactic therapy or teletherapy at a single facility.

(g) One thousand eight hundred eighty dollars for a license authorizing medical or veterinary possession of greater than two hundred millicuries total possession of radioactive material at a single facility.

(h) One thousand five hundred dollars for a license authorizing medical or veterinary possession of greater than thirty millicuries but less than or equal to two hundred millicuries total possession of radioactive material at a single facility.

(i) One thousand one hundred ten dollars for a license authorizing medical or veterinary possession of less than or equal to thirty millicuries total possession of radioactive material at a single facility.



(j) Nine hundred eighty dollars for a license authorizing group I as defined in WAC 246-235-120 or in vitro uses of radioactive material at a single facility.

(k) Six hundred ten dollars for a license authorizing medical or veterinary possession of a sealed source for diagnostic use at a single facility.

(2) Persons with licenses authorizing multiple locations of use shall increase the annual fee by fifty percent for each additional location or base of operation.

[Statutory Authority: RCW 43.70.110, [43.70.]250 and chapter 70.98 RCW. 96-11-043, § 246-254-080, filed 5/8/96, effective 6/28/96; 95-12-004, § 246-254-080, filed 5/25/95, effective 6/25/95; 94-11-011 § 246-254-080, filed 5/5/94, effective 6/5/94; 93-13-019 (Order 372), § 246-254-080, filed 6/8/93, effective 7/9/93. Statutory Authority: RCW 43.70.110. 91-22-027 (Order 208), § 246-254-080, filed 10/29/91, effective 11/29/91.]

**WAC 246-254-090 Fees for industrial radioactive material licenses.** (1) Persons licensed or authorized to possess or use radioactive material in the following industrial categories shall forward annual fees to the department as follows:

(a) Four thousand three hundred sixty dollars for a license authorizing the use of radiographic exposure devices in one or more permanent radiographic vaults in a single facility.

(b) Five thousand eight hundred forty dollars for a license authorizing the use of radiographic exposure devices at temporary job sites but operating from a single storage facility.

(c) Two thousand eight hundred sixty dollars for a license authorizing well-logging activities including the use of radioactive tracers operating from a single storage facility.

(d) Six hundred twenty dollars for a license authorizing possession of portable sealed sources including moisture/density gauges and excluding radiographic exposure devices operating from a single storage facility.

(e) Six hundred eighty dollars for a license authorizing possession of any nonportable sealed source, including special nuclear material and excluding radioactive material used in a gas chromatograph at a single facility.

(f) Four hundred thirty dollars for a license authorizing possession of gas chromatograph units containing radioactive material at a single facility.

(g) One thousand one hundred eighty dollars for a license authorizing possession of any self-shielded or pool type irradiator with sealed source total quantity greater than one hundred curies at a single facility.

(h) Six thousand two hundred forty dollars for a license authorizing possession of sealed sources for a walk-in type irradiator at a single facility.

(i) Five thousand four hundred forty dollars for a license authorizing possession of greater than one gram of unsealed special nuclear material or greater than five hundred kilograms of source material at a single facility.

(j) One thousand seven hundred forty dollars for a license authorizing possession of less than or equal to one gram of unsealed special nuclear material or five hundred kilograms of source material at a single facility.

(k) Two hundred eighty dollars for a license authorizing possession of static elimination devices not covered by a general license.

(2) Persons with licenses authorizing multiple locations of permanent storage shall increase the annual fee by fifty percent for each additional location.

(3) Depleted uranium registrants required to file Form RHF-20 shall forward an annual fee of sixty dollars to the department.

[Statutory Authority: RCW 43.70.110, [43.70.]250 and chapter 70.98 RCW. 96-11-043, § 246-254-090, filed 5/8/96, effective 6/28/96; 95-12-004, § 246-254-090, filed 5/25/95, effective 6/25/95; 94-11-011 § 246-254-090, filed 5/5/94, effective 6/5/94; 93-13-019 (Order 372), § 246-254-090, filed 6/8/93, effective 7/9/93. Statutory Authority: RCW 43.70.110. 91-22-027 (Order 208), § 246-254-090, filed 10/29/91, effective 11/29/91.]

**WAC 246-254-100 Fees for laboratory radioactive material licenses.** (1) Persons licensed or authorized to possess or use unsealed radioactive material in the following laboratory categories shall forward annual fees to the department as follows:

(a) Two thousand nine hundred eighty dollars for a license authorizing possession at a single facility of unsealed sources in amounts greater than:

(i) One millicurie of I-125 or I-131; or

(ii) One hundred millicuries of H-3 or C-14; or

(iii) Ten millicuries of any single isotope.

(b) One thousand four hundred eighty dollars for a license authorizing possession at a single facility of unsealed sources in amounts:

(i) Greater than 0.1 millicurie and less than or equal to one millicurie of I-125 or I-131; or

(ii) Greater than ten millicuries and less than or equal to one hundred millicuries of H-3 or C-14; or

(iii) Greater than one millicurie and less than or equal to ten millicuries of any single isotope.

(c) One thousand two hundred forty dollars for a license authorizing possession at a single facility of unsealed sources in amounts:

(i) Greater than 0.01 millicurie and less than or equal to 0.1 millicurie of I-125 or I-131; or

(ii) Greater than one millicurie and less than or equal to ten millicuries of H-3 or C-14; or

(iii) Greater than 0.1 millicurie and less than or equal to one millicurie of any other single isotope.

(d) Four hundred thirty dollars for a license authorizing possession at a single facility of unsealed or sealed sources in amounts:

(i) Less than or equal to 0.01 millicurie of I-125 or I-131; or

(ii) Less than or equal to one millicurie of H-3 or C-14; or

(iii) Less than or equal to 0.1 millicurie of any other single isotope.

(e) Five hundred seventy dollars for a license authorizing possession at a single facility of large quantities of naturally occurring radioactive material in total concentration not exceeding 0.002 microcurie per gram.

(2) Persons with licenses authorizing multiple locations of use shall increase the annual fee by fifty percent for each additional location.

(3) Persons registered to perform in vitro testing pursuant to Form RHF-15 shall forward an annual fee of sixty dollars to the department.



[Statutory Authority: RCW 43.70.110, [43.70.]250 and chapter 70.98 RCW. 96-11-043, § 246-254-100, filed 5/8/96, effective 6/28/96; 95-12-004, § 246-254-100, filed 5/25/95, effective 6/25/95; 94-11-011 § 246-254-100, filed 5/5/94, effective 6/5/94; 93-13-019 (Order 372), § 246-254-100, filed 6/8/93, effective 7/9/93. Statutory Authority: RCW 43.70.110. 91-22-027 (Order 208), § 246-254-100, filed 10/29/91, effective 11/29/91.]

**WAC 246-254-110 Fees for reciprocity.** (1) The department shall charge fees for reciprocal recognition of other agreement state, licensing state or United States Nuclear Regulatory Commission licenses based upon the actual amount of radioactive material or type of devices being transported into Washington state or the type of service to be performed involving radioactive material.

(2) The department shall charge a fee equal to one hundred percent of the fee specified under WAC 246-254-070, 246-254-080, 246-254-090, and 246-254-100.

(3) The department shall permit the reciprocally recognized licensee to possess and use radioactive material in the state of Washington up to one hundred eighty days during the twelve-month period following payment of each fee.

[Statutory Authority: RCW 43.70.110. 91-22-027 (Order 208), § 246-254-110, filed 10/29/91, effective 11/29/91.]

**WAC 246-254-120 Fees for licensing and compliance actions.** (1) In addition to the fee for each radioactive material license as described under WAC 246-254-070, 246-254-080, 246-254-090, and 246-254-100, a licensee shall pay a service fee for each additional licensing and compliance action as follows:

(a) For a second follow-up inspection, and each follow-up inspection thereafter, a fee of ninety dollars per hour of direct staff time associated with the follow-up inspection, not to exceed nine hundred dollars per follow-up inspection. Hours are calculated in half-hour increments.

(b) For each environmental cleanup monitoring visit, a fee of ninety dollars per hour of direct staff time associated with the environmental cleanup monitoring visit, not to exceed two thousand two hundred fifty dollars per visit. Hours are calculated in half-hour increments.

(c) For each new license application, the fee of one hundred fifty dollars in addition to the required annual fee.

(d) For each sealed source and device evaluation, a fee of ninety dollars per hour of direct staff time associated with each sealed source and device evaluation, not to exceed two thousand seven hundred dollars per evaluation.

(e) For review of air emission and environmental programs and data collection and analysis of samples, and review of decommissioning activities by qualified staff in those work units, a fee of ninety dollars per hour of direct staff time associated with the review. The fee does not apply to reviews conducted by the radioactive materials section staff and does not apply unless the review time would result in a special service charge exceeding ten percent of the licensee's annual fee.

(f) For expedited licensing review, a fee of ninety dollars per hour of direct staff time associated with the review. This fee only applies when, by the mutual consent of licensee and affected staff, a licensing request is taken out of date order and processed by staff during nonwork hours and for which staff is paid overtime.

(2) The licensee or applicant shall pay any additional service fees at the time of application for a new license or within thirty days of the date of the billing for all other licensing and compliance actions.

(3) The department shall process an application only upon receipt of the new application fee and the annual fee.

(4) The department may take action to modify, suspend, or terminate the license or sealed source and device registration if the licensee fails to pay the fee for additional licensing and compliance actions billed by the department.

[Statutory Authority: RCW 43.70.110, 43.70.250 and chapter 70.98 RCW. 95-12-004, § 246-254-120, filed 5/25/95, effective 6/25/95; 94-11-011, § 246-254-120, filed 5/5/94, effective 6/5/94; 93-13-019 (Order 372), § 246-254-120, filed 6/8/93, effective 7/9/93. Statutory Authority: RCW 43.70.110. 91-22-027 (Order 208), § 246-254-120, filed 10/29/91, effective 11/29/91. Statutory Authority: RCW 43.70.040. 91-02-049 (Order 121), recodified as § 246-254-120, filed 12/27/90, effective 1/31/91. Statutory Authority: RCW 70.98.080. 87-01-031 (Order 2450), § 402-70-070, filed 12/11/86; 79-12-073 (Order 1459), § 402-70-070, filed 11/30/79, effective 1/1/80.]

**WAC 246-254-130 Radioactive waste disposal site surveillance fee.** (1) The department shall charge a fee for radioactive waste site surveillance.

(2) The fee shall be an added charge on each cubic foot of low-level waste disposed at the disposal site.

(3) The department shall authorize by contract the operator of a low-level radioactive waste disposal site to collect the fee from waste generators and brokers.

(4) The department shall provide for reimbursement to the site operator for collection costs.

(5) The department shall calculate the fee collected from waste generators and brokers as required under RCW 70.98.085 and the fee shall not exceed the statutory limit specified in that section.

(6) The site operator shall remit the fee to the department as follows:

(a) Quarterly for the first seven quarters of each biennium.

(b) By July 15 for the final quarter of the biennium.

[Statutory Authority: RCW 43.70.040. 91-02-049 (Order 121), recodified as § 246-254-130, filed 12/27/90, effective 1/31/91. Statutory Authority: RCW 70.98.085. 90-11-126 (Order 050), § 402-70-073, filed 5/23/90, effective 6/23/90.]

**WAC 246-254-140 Fees for uranium, thorium and other mineral processors.** (1) Persons licensed or authorized to receive, possess, or use natural uranium and its decay daughters for the extraction of uranium or thorium compounds or for the reclamation and disposal of the associated tailings or waste shall pay:

(a) Initial application fee of thirty-five thousand dollars; and

(b) Quarterly billings for actual costs to the department.

(2) The department shall bill the uranium or thorium milling licensee quarterly for the department's actual cost of:

(a) Reviewing and issuing a license in excess of the initial application fee;

(b) Determining the licensee's compliance with terms and conditions of the license;

(c) Reviewing license amendment requests;

(d) Maintaining a uranium mill program which is compatible with the requirements of the United States Nuclear Regulatory Commission;

(e) Determining and assuring compliance with chapter 173-11 WAC; and

(f) Reviewing and processing an application for renewal.

(3) The department shall delineate in the quarterly billing the staff, laboratory, and support service costs.

(4) The department:

(a) Shall process any initial application only upon receipt of the full fee specified; and

(b) May return an application to an applicant if no payment is received.

(5) The department shall credit the initial application fee to the applicants' quarterly billing.

(6) Mineral processors requiring licenses for naturally occurring radioactive material in excess of exempt concentrations shall pay:

(a) Initial application fee of twenty-seven thousand dollars; and

(b) Quarterly billings not to exceed forty thousand dollars.

(7) The department shall bill mineral processor licensees quarterly for the department's actual cost of:

(a) Processing and issuing a license in excess of the initial application fee;

(b) Determining the licensee's compliance with terms and conditions of the license;

(c) Reviewing and processing amendment and renewal requests; and

(d) Determining and assuring compliance with chapter 173-11 WAC.

[Statutory Authority: RCW 43.70.110. 91-22-027 (Order 208), § 246-254-140, filed 10/29/91, effective 11/29/91.]

**WAC 246-254-150 Fees for perpetual care and maintenance.** (1) Persons with licenses specifically authorizing the receipt, possession, or use of natural uranium and its decay daughters for the extraction of uranium or thorium compounds or for the reclamation and disposal of the associated tailings or waste shall:

(a) Make quarterly payments of twenty cents per kilogram of uranium or thorium compound milled out of the raw ore;

(b) Remit this payment within thirty days after the end of each calendar quarter; and

(c) Pay to the department a minimum of two hundred fifty thousand dollars (1978 dollars) to cover the costs of long-term surveillance prior to the termination of a uranium or thorium mill license.

(2) Licensees under this section may make additional payments to meet the minimum, prior to the release of any surety arranged by the licensee in accordance with WAC 246-235-080 (6)(d).

[Statutory Authority: RCW 43.70.110. 91-22-027 (Order 208), § 246-254-150, filed 10/29/91, effective 11/29/91. Statutory Authority: RCW 43.70.040. 91-02-049 (Order 121), recodified as § 246-254-150, filed 12/27/90, effective 1/31/91. Statutory Authority: RCW 70.98.080. 87-01-031 (Order 2450), § 402-70-080, filed 12/11/86.]

**WAC 246-254-160 Fees for airborne emissions of radioactive materials.** (1) The department shall waive the

[Title 246 WAC—page 358]

fee of one thousand dollars for each air emission permit application for those facilities who pay the fees specified in WAC 246-254-070, 246-254-080, 246-254-090, and 246-254-100; however, those facilities shall pay costs associated with direct staff time of the air emissions program in accordance with WAC 246-254-120 (1)(e).

(2) For emission units at all other facilities:

(a) Application. The applicant shall submit a fee of one thousand dollars for each air emission license to the department with each application.

(i) The department shall process only those applications accompanied by the fee prescribed in (a) of this subsection. The department shall return any application submitted without the prescribed fee to the applicant.

(ii) The applicant shall pay any additional actual costs involved with processing the application upon receipt of a bill from the department on a calendar quarter basis.

(iii) The department shall credit the initial application fee to the applicant's quarterly billings.

(b) Operations. The department shall charge each emission unit operator the actual expenses incurred by the department in determining compliance with the provisions of established regulations and conditions of the air emission license; and:

(i) Bill the operator each calendar quarter until the air emission license is terminated by the department.

(ii) Specify in the quarterly bill the staff, laboratory, and support service costs associated with the regulatory activities conducted by the department.

(c) Amendment. The department shall add and include the actual costs incurred by the department in reviewing and processing an amendment to an air emission license in the department's calendar quarter charge for regulatory activities.

[Statutory Authority: Chapters 70.98 and 70.94 RCW and chapter 173-480 WAC. 94-07-010, § 246-254-160, filed 3/4/94, effective 4/4/94. Statutory Authority: RCW 43.70.110. 91-22-027 (Order 208), § 246-254-160, filed 10/29/91, effective 11/29/91. Statutory Authority: RCW 43.70.040. 91-02-049 (Order 121), recodified as § 246-254-160, filed 12/27/90, effective 1/31/91. Statutory Authority: Chapter 70.98 RCW. 88-17-061 (Order 2670), § 440-44-062, filed 8/17/88.]

**WAC 246-254-170 Failure by applicant or licensee to pay prescribed fees.** In any case where the department finds that an applicant, a permittee, a registrant, or a licensee failed to pay a prescribed fee or actual costs incurred during a calendar quarter, the department: (1) Shall not process any application and (2) may suspend or revoke any license, permit, registration, or approval involved; or (3) may issue an order with respect to licensed, permitted, or registered activities as the department determines appropriate or necessary in order to carry out the provisions of this chapter.

[Statutory Authority: RCW 43.70.110. 91-22-027 (Order 208), § 246-254-170, filed 10/29/91, effective 11/29/91. Statutory Authority: RCW 43.70.040. 91-02-049 (Order 121), recodified as § 246-254-170, filed 12/27/90, effective 1/31/91. Statutory Authority: RCW 70.98.080. 87-01-031 (Order 2450), § 402-70-090, filed 12/11/86; 79-12-073 (Order 1459), § 402-70-090, filed 11/30/79, effective 1/1/80.]

**Chapter 246-260 WAC**  
**WATER RECREATION FACILITIES**

**WAC**

246-260-001	Purpose and authority.
246-260-010	Definitions.
246-260-020	General administration.
246-260-030	Construction permit.
246-260-040	Operating permit.
246-260-050	Compliance.
246-260-060	Surveillance.
246-260-070	Water quality standards, analysis, and sample collection.
246-260-080	Monitoring, reporting, and record keeping.
246-260-090	Swimming pool design, construction, and equipment.
246-260-100	Operation of swimming pool facilities.
246-260-110	Spa pool design, construction, and equipment.
246-260-120	Operation of spa pool facilities.
246-260-130	Wading pool design, construction, and equipment.
246-260-140	Operation of wading pool facilities.
246-260-150	Spray pool design, construction, and equipment.
246-260-160	Operation of spray pool facilities.
246-260-170	Water recreation facility pools not in operation.
246-260-180	Bathing beaches.
246-260-200	Water recreation industry requirements.
246-260-210	Technical advisory committee.
246-260-220	Restrictions on animals.
246-260-230	Variance.
246-260-240	Substitution.
246-260-250	Enforcement.
246-260-260	Hearings.
246-260-9901	Fees.
246-260-998	Severability.

**DISPOSITION OF SECTIONS FORMERLY  
CODIFIED IN THIS CHAPTER**

246-260-990	Fees. [Statutory Authority: RCW 43.70.040, 91-02-050 (Order 122), § 246-260-990, filed 12/27/90, effective 1/31/91.] Repealed by 94-11-056, filed 5/11/94, effective 6/11/94. Statutory Authority: RCW 70.90.150 and 43.20B.020.
-------------	--

**WAC 246-260-001 Purpose and authority.** The purpose of this chapter is to protect the health, safety, and welfare of users of water recreation facilities (WRF). This chapter is established per RCW 70.90.120.

[Statutory Authority: RCW 43.20.050, 91-02-051 (Order 124B), recodified as § 246-260-001, filed 12/27/90, effective 1/31/91. Statutory Authority: RCW 70.90.120, 90-07-010 (Order 042), § 248-98-003, filed 3/12/90, effective 4/12/90.]

**WAC 246-260-010 Definitions.** (1) "Abbreviations" (technical):

- (a) "DE" means diatomaceous earth;
  - (b) "fps" means feet per second;
  - (c) "gpm" means gallons per minute;
  - (d) "mg/l" means milligrams per liter. When requirements in this regulation specify limits for liquid volume measurements using mg/l or ppm, either may be used depending on the type of testing equipment available;
  - (e) "ppm" means parts per million. See notation under mg/l for use;
  - (f) "TU" means turbidity unit as measured by the nephelometric method.
- (2) "ANSI" means American National Standards Institute.
- (3) "APHA" means American Public Health Association.

(1997 Ed.)

(4) "Approved" means the department or local health officer has stated in writing that the design plans and specifications are in accordance with chapter 246-260 WAC.

(5) "ARC" means American Red Cross.

(6) "Architect" means a registered architect currently licensed under chapter 18.08 RCW in Washington state.

(7) "ASHRAE" means American Society of Heating, Refrigeration and Air Conditioning Engineers.

(8) "Assistant lifeguard" means a person appointed by the owner or manager meeting the training requirements of this chapter actively assisting lifeguards (under direct lifeguard supervision) for the purpose of ensuring bather safety.

(9) "Attendant" means a person appointed by the owner or manager meeting the training requirements of this chapter, monitoring activities and conditions for the purpose of ensuring bather safety.

(10) "Bathing beach" means a bathing place, together with buildings and appurtenances used in connection therewith, on a natural pond, lake, stream, or other body of fresh or salt water, which is open to the public for bathing by express permission of the owner, or which is operated for a fee, or openly advertised as a place for bathing by the public.

(11) "Board" means the state board of health.

(12) "CNCA" means Council for National Cooperation in Aquatics.

(13) "CPSC" means Consumer Product Safety Commission (U.S.).

(14) "Communication system" means any combination of devices permitting the passage of or exchange of messages between personnel and/or personnel and bathers. Systems can include but are not limited to two-way radios, hard wired intercoms, horns, whistles, hand signals, direct voice, signs, or equivalent.

(15) "Contaminant" means any physical, chemical, or biological substance present in the WRF water which may adversely affect the health or safety of the bather and/or the quality of the water.

(16) "Cross-connection" means any physical arrangement connecting a:

(a) Potable water system directly or indirectly, with anything other than another potable water system; or

(b) WRF pool to any potable or nonpotable water source capable of contaminating either the WRF pool, its components, or potable water source as a result of backflow.

(17) "Department" means the department of health.

(18) "Diving envelope" means the minimum dimensions of an area within the pool necessary to provide entry from a diving board, platform, or pool decking intended for users to dive.

(19) "Engineer" means a registered professional engineer currently licensed under chapter 18.43 RCW in Washington state.

(20) "FINA" means Federation Internationale de Natation Amateur.

(21) "General use pool" means any swimming, spa, wading, or spray pool regulated by this chapter not meeting the definition of a "limited use pool." If limited-use pools provide organized programs (as noted in limited use definition), the limited use pools shall conform with the general-use pool requirements during periods of such activity.

[Title 246 WAC—page 359]

(22) "Handhold" means a structure not over twelve inches above the water line around the perimeter of the pool wall, affording physical means for the bather to grasp the pool sides.

(23) "Illness or injury report" means the written record of all facts regarding an injury or illness associated with the WRF.

(24) "Lifeguard" means a person appointed by the owner or manager to maintain surveillance over the bathers on the deck or in the pool and to supervise bather safety. The lifeguard shall meet the training requirements of this chapter.

(25) "Lifeguard station" means designated work station of a lifeguard.

(26) "Lifesaving equipment" means emergency equipment and barrier protection.

(27) "Limited use pool" means any swimming, spa, wading, or spray pool regulated by this chapter at an apartment, boarding home, condominium, home owners association, hotel, mobile home park, motel, recreational vehicle park, or rental housing unit and is for the use of the persons living or residing at these facilities and the resident's invited guests. If such pool provides organized programs at the facility (that is, formal instructional lessons for swimming or diving, swim meets, exercise classes, or other activities planned for users besides those specified under the limited use pool category), the pool facility shall conform with the general use pool requirements during periods of such activity.

(28) "Local health officer" means the health officer of the city, county, or city-county department or district or a representative authorized by the local health officer.

(29) "NSF" means National Sanitation Foundation.

(30) "NSPI" means National Spa and Pool Institute.

(31) "Operations" means all aspects of a WRF which must be controlled to make the facility safe, healthy, and usable for the purpose intended.

(32) "Owner" means a person owning and responsible for a WRF or authorized agent.

(33) "Person" means an individual, firm, partnership, copartnership, corporation, company, association, club, government entity, or organization of any kind.

(34) "Pool" means swimming pool, wading pool, spray pool, or spa pool or the like.

(35) "Plummet" means a line perpendicular to water surface and extending vertically to a point located at the front end of the diving board and at the center line directly in front of the diving board.

(36) "Primary zone of visual coverage" means the area assigned to a lifeguard or attendant for primary visual surveillance of user activity.

(37) "Radius of curvature" means the radius arc denoting the curved surface from the point of departure from the springline (vertical sidewall) of the pool to the pool bottom.

(38) "Response time" means time between bather distress and initiation of rescue assistance contact by a lifeguard in facilities providing lifeguards.

(39) "Recreational water contact facility" means an artificial water associated facility with design and operational features that provide patron recreational activity which is different from that associated with a conventional swimming pool and purposefully involves immersion of the body

partially or totally in the water, and that includes but is not limited to water slides, wave pools, and water lagoons. These facilities are regulated by chapter 246-262 WAC.

(40) "RLSSC" means the Royal Life Saving Society of Canada.

(41) "Secretary" means the secretary of the department of health.

(42) "Serious injury" means any injury:

(a) Requiring emergency service response where a person requires medical treatment as determined by the emergency medical response personnel; and/or

(b) Resulting in a person seeking medical attention at a hospital emergency room or admittance to a hospital.

(43) "Spa pool" means a pool designed for relaxation or recreational use where the user is sitting, reclining, or at rest and the pool is not drained, cleaned, or refilled for each user. The spa pool may include, but not be limited to, hydrojet circulation, hot water, cold water, mineral baths, air induction bubbles in any combination.

(44) "Spray pool" means a pool or artificially constructed depression for use by bathers in which water is sprayed, but is not allowed to pond, in the bottom of the pool.

(45) "Springline" means the point where the pool wall breaks from vertical and begins its arc in the radius of curvature (for cove construction) to the bottom of the pool.

(46) "Swimming pool" means any structure, basin, chamber, or tank containing an artificial body of water for swimming, diving, relaxation, or recreational bathing and having a depth of two feet or more at any point and including all associated facilities.

(47) "Turnover time" means the minimum time necessary to circulate the entire volume of the pool facility through the treatment system.

(48) "Wading pool" means any artificial pool of water equal to or less than two feet deep and intended for wading purposes.

(49) "Walking surface" means any surface used as a direct access surface for a pool area and the walking surface's change room facilities where the user is barefoot.

(50) "Water treatment operator" means the appointed person operating the physical and mechanical equipment and performing related water quality monitoring and associated record keeping for proper operation of the physical facility.

(51) "Water recreation facility (WRF)" means any artificial basin or other structure containing water used or intended to be used for recreation, bathing, relaxation or swimming, where body contact with the water occurs or is intended to occur and includes auxiliary buildings and appurtenances. The term includes, but is not limited to:

(a) Conventional swimming pools, wading pools, and spray pools;

(b) Recreational water contact facilities as defined under RCW 70.90.110 and regulated under chapter 246-262 WAC;

(c) Spa pools and tubs using hot water, cold water, mineral water, air induction, or hydrojets; and

(d) Any area designated for swimming in natural waters with artificial boundaries within the waters.

[Statutory Authority: RCW 70.90.120. 92-02-020 (Order 226B), § 246-260-010, filed 12/23/91, effective 1/23/92. Statutory Authority: RCW 43.20.050. 91-02-051 (Order 124B), recodified as § 246-260-010, filed 12/27/90, effective 1/31/91. Statutory Authority: RCW 70.90.120. 90-07-

010 (Order 042), § 248-98-001, filed 3/12/90, effective 4/12/90; Regulation 98.001, effective 3/11/60.]

**WAC 246-260-020 General administration.** (1) The department and local health officer for each local health jurisdiction shall develop an interagency agreement listing the responsibilities of each agency for administering these rules. The agreement shall designate the person responsible for:

(a) Issuance of construction permits with plan review and review of completed facilities;

(b) Issuance of operation permits and routine surveillance of facilities; and

(c) Enforcement actions.

(2) Fees may be charged as authorized in RCW 70.90.150.

(3) The interagency agreement shall be reviewed periodically to ensure effective use of local and state resources.

(4) The department shall conduct a local health jurisdiction program review a minimum of once every five years to ensure conformance with state board of health standards.

(5) The department shall review this chapter for changes at least once every five years.

[Statutory Authority: RCW 43.20.050. 91-02-051 (Order 124B), recodified as § 246-260-020, filed 12/27/90, effective 1/31/91. Statutory Authority: RCW 70.90.120. 90-07-010 (Order 042), § 248-98-005, filed 3/12/90, effective 4/12/90.]

**WAC 246-260-030 Construction permit.** (1) Persons planning to construct, alter, or modify a WRF pool, except for routine maintenance, shall submit plans to the department or local health officer as required for review and approval:

(a) A completed construction permit application form obtained from the department or local health officer;

(b) Three sets of plans and specifications prepared and signed by an engineer or architect.

(2) The architect or engineer shall provide the following information for plan review approval and project completion:

(a) Plans drawn to scale and in sufficient detail to completely illustrate construction including, but not limited to:

(i) One plan view;

(ii) One or more cross sections through the main drain;

(iii) Overall plan showing the pool in relation to other facilities in the area;

(iv) Detailed view of the equipment layout and the associated room or location;

(v) A piping schematic showing piping configuration, pipe size, valves, inlets, main drains, overflow outlets, make-up water, and backwash from filter;

(vi) Dimensional drawings of pool bottom and side-walls;

(vii) Specifications of all required components;

(viii) Such other department-required information.

(b) Engineers or architects may submit standard plans for prefabricated structures or structures virtually identical from one installation to the next. When the engineer or architect submits such standard drawings, future submittals, involving the standard equipment shall:

(i) Include copies of the approved standard drawings;

(ii) Include an engineer or architect cover letter noting the location and address of the new facility;

(iii) Be substantially in conformance with the original standard plan;

(iv) Provide information on changes and note any specification differences; and

(v) Be valid only during the period regulations or department policies concerning plan review and design standards are not changed. If errors are determined at a later period, it will be necessary to resubmit.

(c) The facility construction report noted under subsection (5)(a) of this section. On pools:

(i) Less than fifteen hundred square feet, the construction report shall confirm the:

(A) Mechanical equipment and circulation system is installed and functioning substantially in accordance with the approved plans; and

(B) Facility with provisions for diving substantially conforms with the diving envelope requirements established in the regulation.

(ii) Fifteen hundred square feet or more, shall confirm:

(A) Subitems under subsection (2)(c)(i) of this section; and

(B) Walking surfaces, barriers, pool components including piping, inlets, outlets, dimensional design, pool appurtenances, equipment rooms, ventilation, and lighting and plumbing fixtures are substantially in conformance with the approved plans.

(3) Following review of the completed permit application and plans and specifications, the department or local health officer shall forward:

(a) Written approval or rejection or note modifications, additional information needed or conditions, and issue or deny a construction permit within thirty days of a complete submittal;

(b) A copy of approved plans to the designer; and

(c) A copy of the approval letter to the department or local health officer and local building department.

(4) The owner shall ensure any construction, modification, or alteration is completed according to approved plans and specifications.

(5) Upon completion of WRF pool facility construction, modification, or alteration and before use, owners shall:

(a) Submit to the department or local health officer a construction report signed by an engineer or architect certifying construction is substantially in compliance with approved plans and specifications and related to conditions under subsection (2)(c) of this section;

(b) Notify the department or local health officer at least five working days before intended use of the facility; and

(c) Before use of a new or modified pool facility, obtain a valid operating permit from the state or local health jurisdiction having authority for surveillance of the pool.

(6) The construction permit issued by the department or local health officer shall be valid for a period of eighteen months. Renewals of construction permits may be granted by the department or local health officer for a period of one year. The owner is responsible to resubmit for a reapplication for a construction permit.

(7) WRF pool owners shall comply and obtain approval with all other applicable agency codes and standards. The agency codes and standards include, but are not limited to:

(a) The National Electrical Code, chapter 19.28 RCW and chapter 296-46 WAC determined under the electrical section of the Washington state department of labor and industries or local electrical authority;

(b) Local gas piping and appliance codes, American Gas Association standards, and certification meeting the latest ANSI Z21.56 or other applicable and equivalent standards;

(c) Local building authority standards, including structural design of components;

(d) State and local plumbing authority standards;

(e) Washington state department of labor and industries requirements for pressure vessels under chapter 70.79 RCW and chapter 296-104 WAC; and

(f) Codes designated under chapter 70.92 RCW for handicapped accessibility.

[Statutory Authority: RCW 43.20.050, 91-02-051 (Order 124B), recodified as § 246-260-030, filed 12/27/90, effective 1/31/91. Statutory Authority: RCW 70.90.120, 90-07-010 (Order 042), § 248-98-010, filed 3/12/90, effective 4/12/90; Regulation .98.010, effective 3/11/60.]

**WAC 246-260-040 Operating permit.** (1) No person shall operate a water recreation pool facility without a current department or local health officer-issued operating permit.

(2) To obtain an operating permit, owners of a water recreation pool facility shall provide department or local health officer information showing the WRF is in compliance with this chapter.

(3) Operating permits shall be:

(a) Valid for one year;

(b) Subject to annual renewal; and

(c) Nontransferable without written department or local health officer consent. For purposes of this section, a change in management of a corporation, partnership, association, or other nonindividual business entity shall create a new person requiring either consent to a permit transfer or issuance of a new permit upon proper application.

(4) The department or local health officer issuing the operating permit may revoke or suspend the permit if the WRF is not operated in accordance with chapter 70.90 RCW or chapter 246-260 WAC.

[Statutory Authority: RCW 70.90.120, 92-02-020 (Order 226B), § 246-260-040, filed 12/23/91, effective 1/23/92. Statutory Authority: RCW 43.20.050, 91-02-051 (Order 124B), recodified as § 246-260-040, filed 12/27/90, effective 1/31/91. Statutory Authority: RCW 70.90.120, 90-07-010 (Order 042), § 248-98-015, filed 3/12/90, effective 4/12/90.]

**WAC 246-260-050 Compliance.** (1) Existing water recreation facilities which do not fully comply with the design, construction, and equipment requirements in WAC 246-260-090, 246-260-110, 246-260-130, and 246-260-150 may be continued in use except as noted in subsections (2) and (3) of this section.

(2) Existing water recreation facilities shall be operated in continuous compliance with the provisions of this chapter as outlined in the life saving equipment requirements as defined in WAC 246-260-010(26), 246-260-070, 246-260-080, 246-260-100, 246-260-120, 246-260-140, 246-260-160, and 246-260-170, and provisions for lifesaving equipment in this chapter.

(3) Existing water recreation facilities built before the effective date of this chapter revision:

(a) Having barriers not conforming with this chapter, may maintain the barrier as it presently exists provided:

(i) Barrier is forty-eight inches or more in height;

(ii) Barrier has a maximum width opening of vertical members not exceeding six inches in width;

(iii) Each entry to the pool area has a self-closing, self-latching gate or door.

(b) Having barriers not conforming with this chapter, must upgrade the barrier to conform with this chapter if the existing barrier height is less than forty-eight inches in height.

(4) Facilities exempted from the regulations are noted under RCW 70.90.250 and the term medical therapy include facilities whose sole use is therapy provided for medical:

(a) Treatment under the supervision of licensed medical practitioners; or

(b) Rehabilitation for institutionalized patients under supervision of licensed medical practitioners.

[Statutory Authority: RCW 70.90.120, 92-02-020 (Order 226B), § 246-260-050, filed 12/23/91, effective 1/23/92. Statutory Authority: RCW 43.20.050, 91-02-051 (Order 124B), recodified as § 246-260-050, filed 12/27/90, effective 1/31/91. Statutory Authority: RCW 70.90.120, 90-07-010 (Order 042), § 248-98-020, filed 3/12/90, effective 4/12/90; Regulation .98.020, effective 3/11/60.]

**WAC 246-260-060 Surveillance.** (1) Owners and operators shall permit the department or local health officer to perform on-site WRF inspections or other surveillance activity as necessary in the discretion of the enforcing agency to ensure compliance with standards under chapter 70.90 RCW and chapter 246-260 WAC.

(2) Employees of the enforcing agency shall provide appropriate identification when entering a WRF for the purpose of routine inspections.

[Statutory Authority: RCW 70.90.120, 92-02-020 (Order 226B), § 246-260-060, filed 12/23/91, effective 1/23/92. Statutory Authority: RCW 43.20.050, 91-02-051 (Order 124B), recodified as § 246-260-060, filed 12/27/90, effective 1/31/91. Statutory Authority: RCW 70.90.120, 90-07-010 (Order 042), § 248-98-025, filed 3/12/90, effective 4/12/90.]

**WAC 246-260-070 Water quality standards, analysis, and sample collection.** (1) **Contaminants.** Owners shall maintain waters free from harmful levels of disease-producing organisms, toxic chemicals, or adverse physical conditions.

(2) **Bacteriological standards.** Owners shall maintain WRF pool waters to meet the following standards of bacteriological quality:

(a) Heterotrophic plate counts not to exceed two hundred bacteria per milliliter in two consecutive tests;

(b) Total coliform not to exceed an average of one coliform per sample of one hundred milliliters in two consecutive tests when using the membrane filter test; and

(c) Total coliform not to exceed one tube positive in two consecutive tests when using the MPN method.

(3) **Disinfection.** Owners shall maintain continuous and effective methods of disinfection of WRF pool waters at all times with use of:

(a) Chlorine or bromine described under Table 070.1 of this section; and/or

(b) Alternate forms of disinfection meeting the following criteria:



(i) Registered with the Environmental Protection Agency, if required;

(ii) Registered with the Washington state department of agriculture, if required;

(iii) Conformance with NSF standard 50 or equal when applicable; and

(iv) Adherence to department-established guidelines.

(c) Alternate forms of disinfection for which the department has developed board-approved standards or guidelines including:

(i) "Interim guidelines governing the use of ozone and ozonators for water recreation facilities;"

(ii) "Interim guidelines governing the use of copper/silver disinfection processes for water recreation facilities."

(4) **Chemical and physical quality.** Owners shall maintain:

(a) Physical and chemical conditions within the ranges specified under Table 070.2 of this section;

(b) Cleanliness by:

(i) Closing an affected WRF area or affected portion of a WRF area when contaminated with feces, vomit, sewage, or other hazardous or unknown material until the area is clean, disinfected, and free of the hazardous material;

(ii) Daily removal of scum or floating material on the pool water surface;

(iii) Continuous removal of scum or floating material by overflow action of pool water with flotsam screened and filtered; and

(iv) Maintaining sanitary walking surfaces.

(c) WRF spa pools which are routinely drained, cleaned, and refilled at a minimum using the formula as follows:

$$\text{Spa volume} \div 3 \div \text{average number of users/day} = \text{Number of days, between draining, cleaning, and refilling.}$$

(5) **Laboratory sampling and testing.** Persons collect laboratory analysis water samples shall:

(a) Collect and transport chemical and micro-organism samples based on the most recent published edition of standard methods for the examination of water and waste/water analysis, published jointly by the American Public Health Association/Water Pollution Control Federation and American Waterworks Association, referred to as "standard methods" in this chapter;

(b) Have laboratory tests performed per "standard methods" at department-approved laboratories to provide such analyses;

(c) Provide adequate data for completing analyses; and

(d) Use department-approved water sample bottles for collection of samples.

(6) **Field testing.** Owners shall have field testing equipment:

(a) To provide means for measuring disinfectant residuals, pH, alkalinity, and any other chemicals routinely used in the pool water;

(b) In pools where compressed chlorine gas is used, to detect leaks using commercial strength (twenty-six degrees Baume') ammonia vapor; and

(c) With a suitable range of readings for the routinely measured parameters as noted under Table 070.3 of this section.

(7) **Chemicals in pool.** Owners shall ensure addition of chemicals or materials to WRF pool waters only when the use is approved or recognized as acceptable by the department. The department has available to WRF pool owners the current approved or acceptable material lists.

(8) **Additional tests.** Owners shall perform additional department or local health officer-directed tests.

TABLE 070.1

MINIMUM AND MAXIMUM LEVELS OF DISINFECTANTS \*

Currently Recognized Disinfectants	Type of Residual Measured	pH Ranges			Maximum Residual ppm **
		7.2-7.49 Minimum	7.5-7.79 Residual	7.8-8.0 Levels	
1. Chlorine	Free available chlorine	1.0	1.4	1.8	6
2. Chlorinated cyanurate	Free available chlorine	1.5	2.0	2.8	6
3. Bromine	Total available bromine	2.0	2.5	3.5	6

NOTE:

\*When using spa facilities, increase minimum residuals in all categories by 1.5 ppm.

\*\*Maximum residual as noted or manufacturer's recommendations (whichever is less). In spa facilities, maximum residual may be raised to 10 ppm or manufacturer's recommendations (whichever is less).

TABLE 070.2

ACCEPTABLE RANGES OF SELECTED CHEMICAL AND PHYSICAL WATER QUALITY CONSTITUENTS

Chemical or Physical Constituent	Minimum	Maximum
1. pH (Hydrogen ion)	7.2	8.0
2. Water clarity (safety)	Main drain and pool bottom visible at all times	—
3. Turbidity (shielding micro-organisms from disinfection)	—	0.5 TU*
4. Cyanuric acid or its derivatives (if used)	0	90 ppm
5. Temperature	—	104 F.**
6. Combined chlorine	—	<50% of free chlorine
7. ORP***	700 mv.	

NOTE:

\*In peak periods, turbidity may increase to 1.0 TU provided turbidity returns to 0.5 TU within a six-hour period following peak use. Turbidity is not a required routine analysis. Turbidity monitoring may be required by the department or local health officer if special conditions warrant turbidity monitoring.

\*\*A pool facility thermometer shall be provided when the water temperature exceeds 95 degrees Fahrenheit.

\*\*\*Oxidation-reduction potential (ORP) readings used in conjunction with chlorine and bromine may be allowed as long as values are maintained no less than 700 millivolts. ORP readings do not preclude the need for field testing of the actual mg/l residual for the specific disinfectant on at least a daily basis.



TABLE 070.3

## RANGE OF ACCEPTABLE TESTING LEVELS FOR FIELD TEST KITS\*

Chemical Test	Minimum Range	Minimum Accuracy
1. Free available chlorine	0.3 to 3.0 ppm	0.2 ppm to 1.0 ppm 0.5 ppm above 1.0 ppm
2. Total chlorine	0.3 to 3.0 ppm	0.2 ppm to 1.0 ppm 0.5 ppm above 1.0 ppm
3. Total bromine	0.3 to 4.0 ppm	0.2 ppm to 1.0 ppm 0.5 ppm above 1.0 ppm
4. pH (hydrogen ion)	7.0 to 8.2	0.2
5. Cyanuric Acid	0 to 100 ppm	10 ppm
6. Alkalinity	0 to 300 ppm	15 ppm
7. Temperature (spas)	60 to 110 degrees F.	1 degree F.

## NOTE:

\*Do not make a chemical condition determination based on readings at the extreme measurable limits of the scale.

[Statutory Authority: RCW 70.90.120. 92-02-020 (Order 226B), § 246-260-070, filed 12/23/91, effective 1/23/92. Statutory Authority: RCW 43.20.050. 91-02-051 (Order 124B), recodified as § 246-260-070, filed 12/27/90, effective 1/31/91. Statutory Authority: RCW 70.90.120. 90-07-010 (Order 042), § 248-98-030, filed 3/12/90, effective 4/12/90; Regulation .98.030, effective 3/11/60.]

**WAC 246-260-080 Monitoring, reporting, and record keeping.** (1) Reporting death, injury, and illness. Owners shall:

(a) Provide department or local health officer-requested information for statewide injury and illness surveillance reports; and

(b) Within forty-eight hours, notify the department or local health officer of a drowning, near drowning, death, or serious injury or illness occurring at the water recreation facility.

(2) Incidents. Owners shall provide department or local health officer-requested information after an incident creating a potential problem of health or safety significance, for example, chlorine gas leak.

(3) Monitoring and record keeping. Owners shall monitor and maintain records for at least three years on the following:

(a) Water quality conditions on WRF pools including:

(i) Residual disinfectant testing often enough to determine the residual is satisfactory, and in no condition shall residual disinfectant testing be done less than once every twenty-four hours;

(ii) Hydrogen ion (pH) concentration testing often enough to determine the concentration is satisfactory, and in no condition shall testing be done less than once every twenty-four hours;

(iii) Checking alkalinity monitored at least weekly;

(iv) Recording quantities of all chemicals added to pool water, including alum, algicides, cyanuric acid, acids, alkalinity compounds, etc.

(v) Checking gauges sufficiently to assure conformance with code requirements for turnover during the filter cycle;

(vi) Any gross water contamination, for example, vomiting, feces, etc.;

(vii) When pool temperature is over ninety-five degrees, temperature testing sufficiently often to determine temperature is in a satisfactory range at or below one hundred and

four degrees Fahrenheit and in no condition shall temperature testing be done less than once every twenty-four hours; and

(viii) When cyanuric acid or its derivatives are used in a pool, cyanurate level testing to determine the cyanurate level is maintained below the maximum level of ninety mg/l, and in no condition shall cyanurate level testing be done less than once every week the pool is in use.

(b) Routine preventive maintenance provided on all hazardous equipment, for example, gas chlorination equipment;

(c) Daily estimation of number of users;

(d) Personnel credentials, training, and/or certifications required under WAC 246-260-100(5), 246-260-120(5), and 246-260-140(5).

(4) Availability. Owners shall make records required by this section available for department or local health officer review upon request.

[Statutory Authority: RCW 70.90.120. 92-02-020 (Order 226B), § 246-260-080, filed 12/23/91, effective 1/23/92. Statutory Authority: RCW 43.20.050. 91-02-051 (Order 124B), recodified as § 246-260-080, filed 12/27/90, effective 1/31/91. Statutory Authority: RCW 70.90.120. 90-07-010 (Order 042), § 248-98-035, filed 3/12/90, effective 4/12/90.]

**WAC 246-260-090 Swimming pool design, construction, and equipment.** (1) Location. Owners shall locate pools to:

(a) Minimize pollution by dust, smoke, soot, and other undesirable substances;

(b) Eliminate pollution from surrounding surface drainage; and

(c) Ensure pump house, trees, and other structures are located fifteen feet or more from the pool or provide barriers or other means to prevent ready access from the structure. Structures shall not be construed to include:

(i) Building walkways above the second story or roofs of any building structure; or

(ii) Any barriers provided to prevent unauthorized pool access, for example fencing.

(2) **Materials.** Owners shall use only structure and equipment materials which are nontoxic, durable, inert, impervious to water, and easily cleanable.

(3) **Walking surfaces.** Owners shall design and maintain walking surfaces:

(a) Uniformly sloping away from the pool or pools a minimum of one-fourth inch per foot and a maximum of one-half inch per foot;

(b) Of a nonslip finish not presenting a tripping hazard;

(c) Equipped with sufficient drains to prevent standing water;

(d) Of easily cleanable, impervious finishes;

(e) At least six feet wide on the shallow end of pool, except for:

(i) Pools with all depths uniform at ends, at least one end six feet wide or more; or

(ii) Circular or irregular pools at least twenty-five percent of the deck six feet wide or more.

(f) Four feet or more in width on pools with an area fifteen hundred square feet or less;

(g) Six feet or more in width;

(i) On outdoor pools fifteen hundred square feet or more;

(ii) On fifty percent of the perimeter of indoor pools fifteen hundred square feet or more. Perimeter on remainder of the deck shall be four feet or more in width.

(h) A minimum of sixteen square feet per bather on pools fifteen hundred square feet or more. Determine maximum bather load as described under subsection (12) of this section. If owner provides maximum facility occupancy loading less than that of subsection (12) of this section, and such occupancy limit is posted and enforced, that loading may be used in lieu of the maximum bather load figure as described under subsection (12) of this section;

(i) In swimming pools designed for competitive use with likelihood of spectators, a minimum of six feet between spectator viewing area and the pool. Balconies shall be fifteen feet or more from the pool unless properly safeguarded from intruding into the pool area;

(j) In conformance with department-established guidelines for any resilient artificial surfaces; and

(k) General use pools shall not have sand and grass areas within the pool enclosure unless separated to prevent direct access from the pool area and means are provided for cleansing the bather's feet before re-entering the pool and deck area.

(4) **Barriers.** Owners shall provide barrier protection to prevent unauthorized access.

(a) A barrier shall be sixty inches or more in height and:

(i) Shall not allow passage of a four-inch diameter sphere;

(ii) If it has horizontal members that are spaced less than forty-five inches between the tops of the horizontal members, shall have spaces between the vertical members no greater than a width of one and three-quarter inches (see Figure 090.1); or

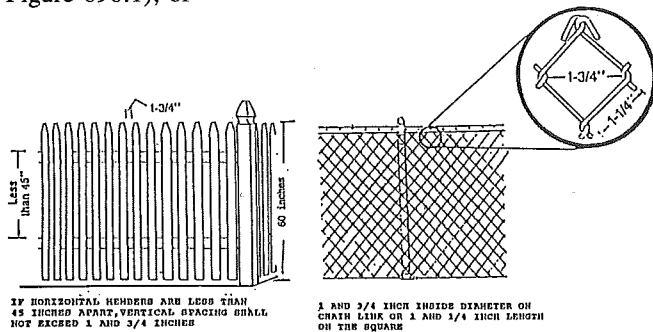

(iii) If it has horizontal members that are spaced at, or more than, forty-five inches between the tops of the horizontal members, shall have spaces between the vertical members no greater than a four-inch width (see Figure 090.2); and

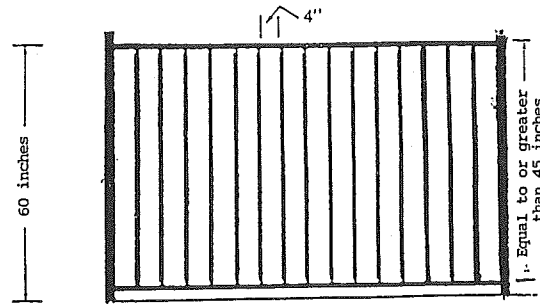

IF HORIZONTAL MEMBERS ARE EQUAL TO OR MORE THAN 45 INCHES APART, VERTICAL SPACING SHALL NOT EXCEED 4 INCHES

(iv) Shall have lockable gates and entrances provided with a self-closing, self-latching mechanism fifty-four inches or more from the ground with a clear space fifty inches deep on the latch side of the door to position a wheelchair. When a latching mechanism is provided at any lower height, the latching mechanism shall be of a type remaining continuously locked, and only opening with the use of a key or other access control system.

(b) At outdoor facilities not a part of living facilities, such as in a municipal park, a barrier six feet or more shall be provided to prevent unauthorized access;

(c) Restricted area service entrances shall be exempt from door or gate requirements providing no public access is available;

(d) Lifeguarded pools are not required to have a self-closing, self-latching gate during the period a pool is in use. Facility gates shall be closed and locked during nonuse periods; and

(e) An entrance to the pool area which shall not serve as a required exit from another part of the building when there is a conflict with other codes or regulations.

(5) **Pool surfaces.** Owners shall ensure pool surfaces with:

(a) Materials complying with subsection (2) of this section;

(b) Water tight and nonabrasive construction; and

(c) White or light color finish not obscuring the view of objects or surfaces;

(d) Surfaces not causing cutting, pinching, puncturing, entanglement, or abrasion hazard under casual contact; and

(e) Construction tolerances conforming with current NSPI public pool standards.

(6) **Pool general floor and wall dimensional design.** Owners shall ensure pool dimensional designs for floors and walls provide for safety, circulation, and quality of the water including, but not limited to:

(a) Uniform pool floor slopes as follows:

(i) Pools fifteen hundred square feet or more providing a maximum slope of one foot drop in twelve feet of run at pool depths to five and one-half feet;

(ii) Where diving provisions are included, floor slopes not intruding into the area designated as the diving envelope; and

(iii) A slope change transition zone (breakpoint from shallow to deep areas of pool) providing warning of the break in slope into diving or deep pool areas consisting of a two-foot wide ramp sloped at twice the slope of the shallow bottom.

(b) Pool vertical walls may be curved, not to exceed allowable radius, to join the floor for minimum distance as noted under Table 050.1 [090.3] of this section. Vertical means walls not greater than eleven degrees from plumb:

(i) Coving or portion of the side wall of a pool diving area shall conform as required and as described under subsection (7) of this section; and

(ii) In new construction or alterations to existing construction, ledges are prohibited.

(c) A maximum intrusion for pool walls beyond the vertical, as defined under subsection (6)(b) of this section, with any configuration not to exceed a transitional radius from wall to floor where floor slopes join walls and which has:

(i) Center of radius not less than the minimum vertical depth specified under Table 090.3 of this section below the water level;

(ii) Arc of radius tangent to the wall; and

(iii) Maximum radius of coving, or any intrusion into the pool wall/floor interface, determined by subtracting the vertical wall depth from the total pool depth.

TABLE 090.3

MAXIMUM RADIUS COVING OR POOL INTRUSION DIMENSIONS BETWEEN POOL FLOOR AND WALL\*

Pool Depth	2'0"	3'0"	3'6"	5'0"	>5'0"
Minimum Sidewall Vertical Depth (Springline)	1'6"	2'2"	2'6"	3'6"	@>3'6"
Maximum Radius of Curvature	6"	10"	12"	1'6"	**Maximum radius equals pool depth minus the vertical wall depth

NOTE:

\*For pool depths falling between the depths listed, values can be interpolated.

\*\*Radius of coving cannot intrude into pool within diving envelope.

(7) **Specific design requirements for pools furnishing areas for diving.** Owners shall ensure provision of diving envelopes in pools or areas of pools designated for diving activities to include a diving envelope not less than the:

(a) APHA standard configuration noted under figure 090.4 of this section in areas where user would enter from the deck level twelve inches or less from water level. This requirement is based on a standard described under APHA public pool regulations, 1981, for pool type described under D-8.01 Table 1, the section noting the requirements from deck level;

(b) CNCA standard configuration noted under figure 090.5 of this section in areas where the user would enter from the deck level over twelve inches from water level, or has a platform or diving board provided at a height of less than one-half meter (twenty inches). This requirement is based on a standard described under CNCA publication **Swimming Pools: A Guide to their Planning, Design, and Operation** 1987, Fourth Edition. Human Kinetics Publisher, Inc., Champaign, Illinois, figure 8.1; and

(c) FINA standard configuration noted under figure 090.6 of this section in areas where the user would enter from the diving board or platform at a height of one-half

meter (twenty inches) or greater. This requirement is based on a standard described in FINA publication **FINA Handbook, 1986-88**, constitution and rules governing swimming, diving, water polo, and synchronized swimming, 1986-88. Edited by E. Allen Harvey, Vancouver, Canada VGN 3R6, Section D, pp. 114-115.

FIGURE 090.4

MINIMUM DIMENSIONS FOR POOLS WITH DIVING FROM DECK LEVEL WHICH IS LESS THAN TWELVE INCHES FROM THE WATER LINE

APHA STANDARDS\*  
D-8 DIVING AREA REQUIREMENTS

D-8.01

The dimensions of the diving area on all swimming pools providing diving from deck level shall conform to the following dimensions:

Table 1. The diving area dimensions on all swimming pools providing diving from deck level.

Heights Height of Deck Above Water Level H	Lengths			
	Water	Depths	Length of Diving Well	Run-Out
12" or less	D(0) 6 ft	D(1) 8.5 ft	L(1) 12 ft	L(2) 10.5 ft
Over 12 inches	See standards for over twelve inches as applicable (either CNCA or FINA in inches following subsections).			

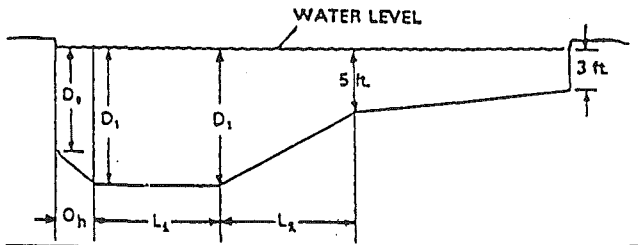

NOTE:

\*The department underlined areas for clarification.



FIGURE 090.6

MINIMUM DIMENSIONS FOR POOLS WITH BOARDS OR PLATFORMS AT A HEIGHT OF 1/2 METER OR MORE

FINA STANDARDS

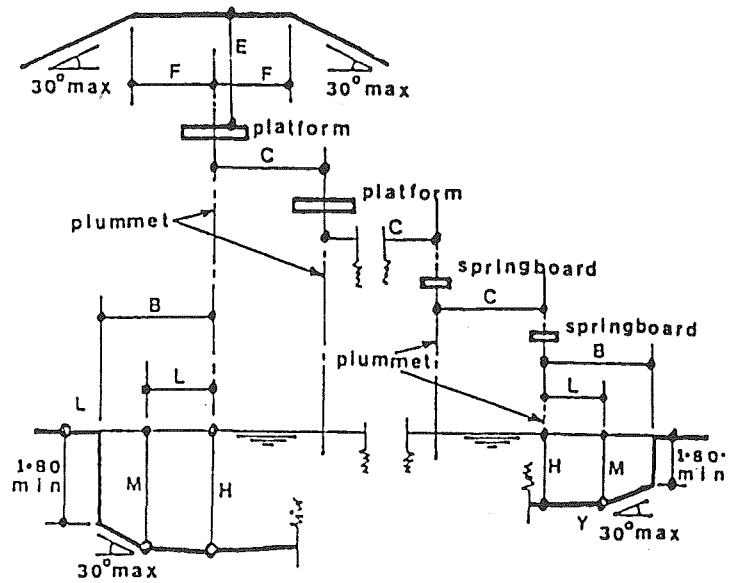
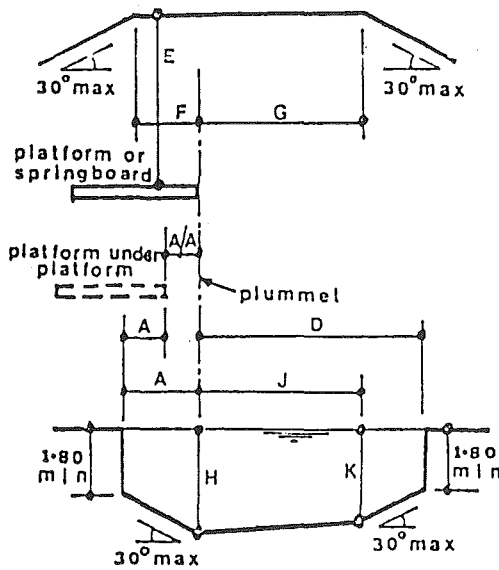

LONGITUDINAL SECTION  
DIAGRAMMATIC ONLY

CROSS SECTION  
DIAGRAMMATIC ONLY

FINA Dimensions For Diving Facilities		Dimensions are in Metres	Springboard		Platform					
			1 Metre	3 Metres	1 Metre	3 Metres	5 Metres	7.5 Metres	10 Metres	
LENGTH		4.80	4.80	4.50	5.00	6.00	6.00	6.00	6.00	
WIDTH		0.50	0.50	0.60	1.50	1.50	1.50	2.00	2.00	
HEIGHT		1.00	3.00	0.60-1.00	2.60-3.00	5.00	7.50	10.00		
Revised to 1st Jan 1987										
			HORIZ VERT	HORIZ VERT	HORIZ VERT	HORIZ VERT	HORIZ VERT	HORIZ VERT	HORIZ VERT	
A	From plumbet BACK TO POOL WALL	DESIGNATION	A-1	A-3	A-1pl	A-3pl	A-5	A-7.5	A-10	
		MINIMUM	1.80	1.80	0.75	1.25	1.25	1.50	1.50	
A/A	From plumbet BACK TO PLATFORM plumbet directly below	DESIGNATION					AA5/1	AA7.5/3/1	AA10/5/3/1	
		MINIMUM					1.50	1.50	1.50	
B	From plumbet to POOL WALL AT SIDE	DESIGNATION	B-1	B-3	B-1pl	B-3pl	B-5	B-7.5	B-10	
		MINIMUM	2.50	3.50	2.30	2.90	4.25	4.50	5.25	
C	From plumbet to ADJACENT PLUMBET	DESIGNATION	C-1/1	C-3/3/1	C-1/1pl	C-3/1/1/3pl	C-5/3/1	C-7.5/3/1	C-10/5/3/1	
		MINIMUM	2.40	2.60	1.65	2.10	2.50	2.50	2.75	
D	From plumbet to POOL WALL AHEAD	DESIGNATION	D-1	D-3	D-1pl	D-3pl	D-5	D-7.5	D-10	
		MINIMUM	9.00	10.25	8.00	9.50	10.25	11.00	13.50	
E	On plumbet, from BOARD TO CEILING	DESIGNATION	E-1	E-3	E-1pl	E-3pl	E-5	E-7.5	E-10	
		MINIMUM	5.00	5.00	3.50	3.50	3.50	3.50	5.00	
F	CLEAR OVERHEAD behind and each side of plumbet	DESIGNATION	F-1	F-3	F-1pl	F-3pl	F-5	F-7.5	F-10	
		MINIMUM	2.50	5.00	2.50	3.50	2.75	3.50	2.75	
G	CLEAR OVERHEAD ahead of plumbet	DESIGNATION	G-1	G-3	G-1pl	G-3pl	G-5	G-7.5	G-10	
		MINIMUM	5.00	5.00	5.00	5.00	5.00	5.00	6.00	
H	DEPTH OF WATER at plumbet	DESIGNATION	H-1	H-3	H-1pl	H-3pl	H-5	H-7.5	H-10	
		MINIMUM	3.50	3.80	3.30	3.60	3.80	4.50	5.00	
J	DISTANCE AND DEPTH ahead of plumbet	DESIGNATION	J-1	J-3	J-1pl	J-3pl	J-5	J-7.5	J-10	
		MINIMUM	5.00	6.00	3.70	6.00	3.50	6.00	4.40	
K	DISTANCE AND DEPTH each side of plumbet	DESIGNATION	K-1	K-3	K-1pl	K-3pl	K-5	K-7.5	K-10	
		MINIMUM	5.00	3.40	3.70	5.00	3.20	6.00	3.50	
L	DISTANCE AND DEPTH each side of plumbet	DESIGNATION	L-1	L-3	L-1pl	L-3pl	L-5	L-7.5	L-10	
		MINIMUM	1.50	3.40	2.00	3.70	1.40	3.20	1.80	
M	DISTANCE AND DEPTH each side of plumbet	DESIGNATION	M-1	M-3	M-1pl	M-3pl	M-5	M-7.5	M-10	
		MINIMUM	1.50	3.40	2.00	3.70	1.40	3.20	1.80	
N	MAXIMUM SLOPE TO REDUCE DIMENSIONS beyond full requirements	POOL DEPTH CEILING HT	30 degrees 30 degrees	NOTE: Dimensions C (plumbet to adjacent plumbet) apply for Platform with widths as detailed. For wider Platforms increase C by half the additional width(s)						

(8) **Pool appurtenances.** Owners shall ensure swimming pools:

(a) Have handholds around the perimeter in pools two feet or more in depth. Handholds shall be four feet or less apart and consist of any one or a combination of the following:

(i) Coping, ledges, radius flanges, or decks along the immediate top edge of the pool or suitable slip-resisting handholds located twelve inches or less above the waterline;

(ii) Ladders or steps; or

(iii) Secured rope or railing twelve inches or less above the water line.

(b) Have stairs, ladders, or stepholes with:

(i) Stairs, when provided, meeting the following construction requirements:

(A) Nonslip tread finish;

(B) Contrasting color stair tread edges clearly visible to users;

(C) Recessed in pool areas used for lap or competitive swimming to prevent intrusion into the activity areas;

(D) Handrails with the leading edge for stairs at pool entry/exit being neither eighteen inches or more beyond nor eight inches or more inside (horizontally) the vertical plane of the bottom riser;

(E) Riser treads with a minimum unobstructed, horizontal, ten-inch tread depth and a minimum two-hundred-forty-inch surface area;

(F) Riser heights, on general use pools fifteen hundred square feet or more, uniform and seven and one-half inches or less, except the bottom riser may be less than the uniform height; and

(G) Riser heights, on general use pools less than fifteen hundred square feet, and limited use pools, uniform and have a preferred seven-and-one-half-inch height, but not greater than ten inches, except the bottom riser may be plus or minus two-inches of the uniform height.

(ii) Ladders or stepholes:

(A) Spaced at a minimum of one for every seventy-five feet of pool perimeter deeper than four feet;

(B) Provided at both sides of the deep end of pools over thirty feet in width; and

(C) Equipped with a handrail at the top of both sides extending over the coping or deck edge.

(iii) Means of access at the shallow end of the pool; and

(iv) Designs permitting entry and exit for impaired or handicapped persons are encouraged.

(c) Diving boards and diving platforms, when provided, shall:

(i) Be installed according to manufacturer's instructions;

(ii) Have slip-resistant tread surfaces;

(iii) Have steps and ladders leading to diving boards which provide handrails.

(iv) Be protected with forty-two inch high guardrails extending at least to the water edge when one meter or more above the water.

(d) Starting blocks, when provided, shall:

(i) If on the shallow end of pool, be removed when not in use by the competitive swimmers trained in starting blocks proper use; and

(ii) Be firmly secured when in use.

(e) Water slides, when provided, shall:

(i) Be installed according to manufacturer's instructions and be approved by the manufacturer for general use and limited use pools; and

(ii) Conform to Part 1207 of the Consumer Product Safety Act (Sec. 7(f), P.L. 92-573, 86 Statute 1215, 15 U.S.C. 1056(f)); or

(iii) If not manufactured for general use and limited use pools, conform to requirements under chapter 246-262 WAC, Recreational Water Contact Facilities.

(9) **Turnover.** Owners shall ensure pools turn over entire pool water volume in six hours or less. Exceptions to recirculation requirements may be made for flow-through pools in the following conditions where:

(a) Water supply is sufficient to provide the same turnover period specified for recirculation pools;

(b) The source water supply meets acceptable quality requirements and is subject to a disinfection method as described under WAC 246-260-070(3);

(c) The introduction of fresh treated pool water is accomplished by the same type of inlet and outlet design required for recirculation pools; and

(d) The pool water quality complies with WAC 246-260-070.

(10) **Pool depth markings.** Owners shall provide depth markings:

(a) Plainly marking the water depth in feet on the vertical wall at or above the water level and on the horizontal surface of the coping or deck edge;

(b) Positioned on the vertical pool wall to be read from the water side. Where markings cannot be placed above the water level, markings shall be placed in other areas and plainly visible to users in the pool;

(c) Located on the coping or deck within eighteen inches of the water edge and positioned to be read while standing on the deck facing the water;

(d) Which are slip resistant;

(e) Placed at the maximum and minimum water depths and at all points of slope change;

(f) Installed at intermediate increments of water depth not to exceed two feet, nor spaced at distances greater than twenty-five foot intervals;

(g) Uniformly arranged on both sides and ends of the pool;

(h) On irregularly shaped pools, meeting the requirements in subdivision (a) through (g) of this subsection and also designate the depths at all major deviations in shape;

(i) With a four-inch minimum height on the deck and a two-inch minimum height on the vertical pool wall; and

(j) Applied in a contrasting deck color which does not fade.

(11) **Safety line or marking line.** Owners shall provide safety (float) lines or marking lines (lines on pool sides and bottom) separating areas where the pool slope breaks from a uniform slope leading from shallow to deeper water.

(a) Safety lines when used shall:

(i) Be kept in place at all times, except when the pool is used for a specific purpose such as lap swimming or competitive use;

(ii) Be placed one foot toward the shallow end away from the break point line. See subsection (6)(a)(iii) of this section;

- (iii) Be strung tightly allowing the bather to hold onto the line for support;
- (iv) Have a receptacle for receiving the safety line:
  - (A) Recessed in the wall; or
  - (B) Not constituting a safety hazard when the safety line is removed.
- (v) Provide floats on the line at a minimum distance of every four feet.
  - (b) Markings lines when used shall:
    - (i) Provide a minimum three-inch wide marking line at the break point where the pool slope breaks from a uniform slope leading from shallow to deeper water; and
    - (ii) Be of a contrasting color to the background color of the pool sidewalls and floor.
    - (c) In pool facilities with uniform slopes not exceeding one foot in twelve feet to deep portions of the pool, a safety line or marking line shall not be required.
- (12) **Bather load.** Owners shall ensure maximum number of bathers in the pool facility at any one time do not exceed a number determined by the formula noted under Table 090.7 of this section.

TABLE 090.7

SWIMMING POOL MAXIMUM BATHING LOAD\* (SPMBL)

$$SPMBL = \frac{A - S}{(30)} + \frac{S}{(15)} \quad \text{For outdoor pools}$$

$$SPMBL = \frac{A - S}{(30)} + \frac{S}{(25)} \quad \text{For indoor pools}$$

Where

A = Total area of water surface in square feet

S = Area of pool less than 5 feet deep in square feet

NOTE:

\*This formula will be used in determining certain features of pools as noted elsewhere in these rules and regulations.

- (13) **Inlets.** Owners shall provide pool inlets:
  - (a) Submerged and located to produce uniform water and chemical circulation throughout the pool; and
  - (b) Located on the bottom of pools twenty-five hundred square feet or more, unless otherwise justified by the design engineer to the department's or local health officer's satisfaction.
- (14) **Outlets.** Owners shall provide pool outlets with:
  - (a) Overflow and main drain grating systems each designed to carry one hundred percent of the total recirculation filter flow and main drain piping designed to carry fifty percent or more of total recirculation filter flow;
  - (b) Overflow outlets that maintain:
    - (i) A minimum of sixty percent of filter recirculation flow at all times; and
    - (ii) An overflow channel which may be used on any pool and required on pools twenty-five hundred square feet or more on the pool perimeter to promote uniform circulation and skimming action of the upper water layer with:
      - (A) A design preventing all matter entering the channel from returning to the pool;
      - (B) Dimensions minimizing the hazard for bathers, such as catching arms or feet;

- (C) One one-hundredth of a foot slope per foot or more;
- (D) Drains sufficiently spaced and sized to collect and remove overflow water to return line and filter, where applicable; and
- (E) Size sufficient to carry one hundred percent of the recirculation flow plus the surge flow equivalent to one-fifth of the balancing tank expressed in gallons per minute.
- (iii) Skimmers in lieu of pool overflow channels up to twenty-five hundred square feet if:
  - (A) Weir provided in skimmer has a maximum flow rate through skimmer not exceeding four gpm per inch of weir;
  - (B) Devices are recessed in the pool wall so no part protrudes beyond the plane of the wall into the pool;
  - (C) The skimmer is equipped with a device to prevent air lock in the recirculation suction line, such as, an equalizer line;
  - (D) The skimmer is equipped with a removable and cleanable screen designed to trap large solids;
  - (E) Automatically adjustable and operates freely with continuous skimming action to continue through all designed loading rates. Displacement shall be computed at fifteen gallons per bather.
- (c) Main drains in all pools with:
  - (i) Location at the pool's low points;
  - (ii) A minimum of two main drains spaced:
    - (A) Twenty feet or less apart nor closer than six feet; or
    - (B) As far as possible from each other in pools seven feet or less linear floor distance.
  - (iii) Total open area of grates sized to prevent a suction or entrapment hazard dangerous to user;
  - (iv) Grates on drains with:
    - (A) Maximum flow of one and one-half feet per second; or
    - (B) Net outlet area four times or more the area of the discharge pipe.
  - (v) Openings not allowing a sphere over one-half inch in diameter to pass;
  - (vi) Grates designed to withstand forces of users;
  - (vii) Grates removable only with specific tool; and
  - (viii) Means to control flow from recirculation pump or balancing tank.
- (15) **Flow.** Owners shall maintain pool recirculation flow not to exceed:
  - (a) Six feet per second in valved suction or discharge side of the pump; and
  - (b) Ten feet per second in open discharge pipes on the pressure side of the pump or filter discharge. The recirculation flow limit does not apply to the return inlet and the last two feet of pipe leading to the inlet.
- (16) **Balancing tanks.** Owners with overflow channels requiring balancing tanks shall:
  - (a) Maintain volume equivalent to fifteen times maximum bathing load expressed in gallons; and
  - (b) Increase capacity as necessary to provide volume for make-up water and to prevent air lock in the pump suction line.
- (17) **Pumps.** Owners shall have and maintain recirculation pumps with adequate capacity to:
  - (a) Provide design flows and pressure for water recirculation over the entire operating filter pressure;
  - (b) Allow proper back washing of filters when specified; and



(c) Have self-priming capability when installed above pool water level.

(18) **Strainers.** Where pumps precede the filter, owners shall equip pool recirculation facilities with hair and lint strainers which shall:

- (a) Be located upstream of recirculation pumps;
- (b) Provide strainer screen sufficiently strong to prevent collapse when clogged;
- (c) Have an openable cover; and
- (d) Provide valving to isolate the strainer when located below pool water level.

(19) **Valves.** Owners shall provide valves at appropriate locations to allow isolation and maintenance of equipment.

(20) **Equipment rooms.** Owners shall provide equipment rooms:

(a) Enclosing pumps, disinfection equipment, filters and other electrical and mechanical feed equipment and associated chemicals. Chemical storage shall conform to manufacturer requirements;

(b) Providing work space and access to perform routine operations;

(c) With a forty-six-square-foot minimum floor area and provide a three-foot minimum access area to service equipment;

(d) With one floor drain or more and a floor slope to the drain at a one-fourth-inch-per-foot minimum;

(e) Ready access if below grade;

(f) Ventilation;

(g) Twenty foot-candles or more of light measured thirty inches from the floor; and

(h) Kept locked.

(21) **Make-up water.** Owners shall ensure a source of make-up water and associated piping at the pool:

(a) Providing sufficient quantity to replace daily pool losses;

(b) Coming from a supply conforming with chapter 246-290 WAC;

(c) Preventing cross connections using a minimum air gap of two pipe diameters or approved backflow prevention devices between the make-up water source and the pool water or waste water; and

(d) If using a pool fill spout, not projecting greater than one inch into the space above the water surface area and shielded to not create a deck hazard.

(22) **Filters.** Owners shall equip pools with filtration equipment:

(a) Meeting the applicable standards of NSF or equivalent;

(b) Using acceptable type and filter rates described under Table 050.6 of this section;

(c) Having pressure or vacuum gauges for measuring loss of head through the filter with minimum of one gauge preceding and one gauge following the filter;

(d) Having a rate of flow indicator to measure flow which has accuracy, repeatability, and durability equivalent to flow meters meeting NSF standards; and

(e) Having a means of discharging filter backwash to waste with:

(i) Discharge in a manner not creating a public nuisance;

(ii) Disposal in accordance with applicable local laws or regulations;

(iii) Minimum air gap of two pipe diameters to prevent cross-connection from waste discharge and recirculation system piping;

(iv) Discharge receptor and piping of sufficient size to accept backwash water and prevent flooding; and

(v) Ability to monitor filter effluent during backwash, that is, use of a sight glass.

(f) Providing means to release air entering the filter tank on pressure filters;

(g) When cartridge filters are used:

(i) Provide with an extra set of cartridges; and

(ii) Have any bypass valves in a permanently closed position.

(h) When using pressure DE filters with separation tanks:

(i) Provide a means of air release or a lid providing a slow and safe release of pressure; and

(ii) Show a readily visible user warning that the air release must be opened before starting the circulation pump.

TABLE 090.8

TYPE AND RANGES OF FILTERS FOR SWIMMING POOLS

Range of Acceptable Filter Rate Type of Filter Media	Expressed in gpm/Square Feet	
	Minimum	Maximum
Sand	Minimum	Maximum
	Rapid Sand or Pressure Sand High Rate Sand Pressure or Vacuum	3 18*
D.E.	Continuous Feed	Manual Feed
	Pressure Vacuum	0.8 1.0 1.0 1.35
Cartridge**		.375

NOTE:

\*Filters which are sized at maximum application rate shall be equipped with flow control valves to maintain flow equilibrium to account for varying filter pressures and consequent flow production.

\*\*Cartridge filters shall have a nominal micron rating of twenty microns or less.

(23) **Disinfection equipment.** Owners shall provide disinfection equipment:

(a) Providing a continuous and effective disinfectant residual in the water;

(b) Using a disinfectant with an easily monitored residual;

(c) Having a design feed rate providing effective disinfection levels when the pool is in peak demand conditions;

(d) Having easily cleanable equipment and piping used to apply chemicals and with provisions to prevent undue clogging. All materials shall be resistant to action of chemicals used;

(e) Conforming to NSF standards if disinfection equipment has:

(i) Adjustable output rate chemical feed equipment for liquid solutions. The equipment shall:

(A) Feed under positive pressure in the recirculation system;

(B) Provide means for dosage adjustment;

(C) Have provisions to prevent hypochlorite solution siphoning when equipment is turned off. This applies when the disinfection equipment is above pool water level.

(ii) Flow through chemical feed for solid feed material. Solid tablets or granules shall not be placed in skimmer baskets accessible to the public.

(f) Allowing hand feeding on an emergency basis only;

(g) Meeting the following conditions when using chlorine gas:

(i) Chlorine rooms shall:

(A) Be above ground level;

(B) Be constructed so all openings or partitions with adjoining rooms are sealed;

(C) Be located with consideration of prevailing winds to dissipate leaked chlorine away from the pool facility;

(D) Have door opening outward only and to the out-of-doors;

(E) Provide a sign on the door exterior reading DANGER CHLORINE. The sign shall be large enough to be read twenty-five feet away.

(ii) Chlorine rooms shall have mechanical exhausting ventilation including:

(A) Air inlet located as far as possible from fan intake to promote good air circulation patterns;

(B) Minimum of one air change per minute in the chlorine room when fan is operating;

(C) A remote switch outside the room or a door-activated switch to turn on fan before entering;

(D) Suction for fan near the floor;

(E) Exhaust for fan and chlorinator vent located to prevent contaminating air intake and prevent undue hazard for the pool facility users; and

(F) Screened chlorinator vent.

(iii) Gas chlorine systems shall:

(A) Be vacuum injection type, with vacuum-actuated cylinder regulators;

(B) Provide integral backflow and anti-siphon protection at the injector; and

(C) Provide taring (net weight of cylinder gas) scales for determining chlorine weight.

(iv) Breathing protection available in an accessible area for the operator outside of the chlorine room including:

(A) Self-contained breathing apparatus designed for use in a chlorine atmosphere for working with chlorine leaks and maintained in accordance with department of labor and industries standards; or

(B) Provisions to substitute breathing protection at the site, if procedures can be established and documented with emergency service fire districts or other approved organization within the area for promptly responding to chlorine leaks.

(v) Means for automatic shutoff when pool flow is interrupted; and

(vi) Chlorine gas cylinders shall:

(A) Be stored only in chlorine rooms;

(B) Have approved valve-stem cylinder wrench on the valve stem to shut the system down in an emergency event;

(C) Be properly secured to prevent tipping;

(D) Be tagged to indicate cylinders are empty or full; and

(E) Not exceed one hundred fifty pounds tare weight per cylinder. If one-ton cylinder use is desired, an engineer

specializing in chlorine design shall prepare a design proposal for department consideration.

**(24) Chemical feeding equipment for pH control.**

Owners applying chemicals for controlling pH through chemical feed equipment shall provide equipment with:

(a) Adequate size and design to allow routine cleaning and maintenance;

(b) Materials resistant to chemical action;

(c) Means for automatic shut off when pool flow is interrupted;

(d) Chemical feed equipment for pH control on pools fifty thousand gallons volume or greater;

(e) Any pool feeding with:

(i) Caustic soda (NAOH);

(ii) Carbon dioxide (CO<sub>2</sub>); or

(iii) Other chemicals the department determines necessary to require metered and controlled feeding.

**(25) Heaters.** Where pool heating equipment is provided, owners shall:

(a) Locate equipment so any standing pilot is readily accessible; and

(b) Install equipment per NEC and UMC.

**(26) Ventilation.** Owners shall provide indoor pool facility ventilation conforming with ASHRAE pool facility standards.

**(27) Testing equipment.** Owners shall use testing equipment as noted in the water quality section under WAC 246-260-070(6).

**(28) Chemical storage.** Owners shall ensure chemical storage design and placement minimizes safety risks.

**(29) Restroom, locker room, and plumbing fixtures.** Owners shall provide restroom, locker room, and plumbing facilities at pools as follows:

(a) General use swimming pool facilities with:

(i) Minimum components including:

(A) Dressing rooms;

(B) Showers;

(C) Toilets and urinals;

(D) Lavatories; and

(E) Hose bibs.

(ii) A design providing easy accessibility to toilet and shower facilities by users with minimum cross traffic of nonusers;

(iii) Locker rooms including:

(A) Separate facilities for both sexes with provisions to block line of sight into locker rooms;

(B) Nonslip floors with suitable drains;

(C) Junctions between walls and floors coved for ease of cleaning; and

(D) Adequate ventilation to prevent moisture build-up in the facility.

(iv) Plumbing fixtures as described under Table 050.7 of this section;

(v) Shower facilities that:

(A) Deliver water at a temperature range of ninety to one hundred ten degrees Fahrenheit; and

(B) Provide single service soap in nonglass dispensers.

(vi) Flush toilets and toilet tissue in dispensers;

(vii) Sinks provided with:

(A) Tempered or hot and cold running water;

(B) Single service soap in nonglass dispensers; and

(C) Single service towels or electric hand dryers.

- (viii) Hose bibs with vacuum breakers provided:
  - (A) At a maximum spacing of one hundred fifty feet around pool deck; and
  - (B) Within the equipment room at facilities having pools fifteen hundred square feet or more.
- (ix) Janitor sink with a vacuum breaker at pools greater than fifteen hundred square feet; and
- (x) Sewage disposed of in a manner approved by the department or local health officer.
- (b) Limited-use swimming pool facility plumbing as described under Table 050.8 [090.10] of this section.

TABLE 090.9

PLUMBING FIXTURE MINIMUM REQUIREMENTS FOR GENERAL USE SWIMMING POOLS AMOUNT OF FIXTURES REQUIRED FOR OCCUPANCY LOAD BY SEX

Type of Fixture		Male	Female
1. Toilets	up to 120	1/60	1/40
	from 121-360 add	1/80	1/60
	over 360 add	1/150	1/100
2. Urinals	up to 120	1/60	NA
	from 121-360 add	1/80	
	over 360 add	1/150	
3. Showers	up to 120	1/40	1/40
	from 121-360 add	1/60	1/60
	over 360 add	1/100	1/100
4. Sinks	up to 200	1/100	1/100
	from 201-400 add	1/200	1/200
	over 400 add	1/400	1/400
5. Hose bibs	One hose bib accessible to each locker room and provided with a vacuum breaker.		
6. Janitor sink	One*		

NOTE:

\*Required for pools 1500 square feet or greater.

TABLE 090.10

PLUMBING FIXTURE MINIMUM REQUIREMENT FOR LIMITED USE SWIMMING POOLS

Pools with:	Toilets	Showers	Sinks	Dress.Rm.
1. Living units within 100 feet and less than 3 stories	-	-	-	-
2. Living units >100 feet but <500 feet and less than 3 stories.	1	-	1	-
3. Living units within 1/4 mile and/or with 3 or more stories.*	1(M)	-	1(M)	-
	1(F)	-	1(F)	-
4. Living units greater than 1/4 mile.**	1(M)	1(M)	1(M)	1(M)
	1(F)	1(F)	1(F)	1(F)

NOTE:

\*Consideration for elevators adjacent to pool may allow variance from this requirement.

\*\*When pool bathing load for the proposed facility exceeds a capacity of 150 people, the fixture units provided at limited use facilities shall conform with the general use requirements in Table 090.9.

(c) If owners limit the number of people within their facility to a certain number and post maximum occupancy loading, the number of plumbing fixture units may be based on that maximum occupancy.

(30) **Lighting.** Owners shall design and maintain pool facility lighting to:

- (a) Illuminate indoor facilities, outdoor facilities used after dusk, and locker room facilities with a minimum lighting intensity maintained thirty inches above any walking surface, pool deck, or pool area of:
  - (i) Thirty foot-candles at indoor facilities;
  - (ii) Fifteen foot-candles at outdoor facilities;
  - (iii) Twenty foot-candles in locker rooms.
- (b) Allow lifeguards or attendants to clearly see pool areas and walking surfaces;
- (c) Meet any additional lighting requirements deemed necessary by the department or local health officer;
- (d) Provide protective shielding for all lighting fixtures above walking surfaces and pool areas; and
- (e) Provide all indoor facilities with one or more pool area emergency lights designed to turn on in the event of a power failure. The emergency lighting shall conform to requirements of UL standard 924.

(31) **Emergency equipment.** Owners shall provide first aid and emergency equipment readily available during operating hours as follows:

- (a) General use swimming pool facilities:
  - (i) A telephone within the facility with a prominently displayed list of emergency medical service response numbers;
  - (ii) Sufficient and suitable area provided to accommodate persons within the facility requiring first aid treatment and necessary first aid equipment;
  - (iii) A supplied first aid kit as follows:
    - (A) For general use pools fifteen hundred square feet or more, a standard twenty-four unit kit;
    - (B) For general use pools less than fifteen hundred square feet and limited use pools, a standard sixteen unit kit;
    - (iv) Two or more blankets reserved for emergency use;
    - (v) A backboard with means to secure victim to board and provide immobilization of head, neck, and back at pools requiring lifeguards;
    - (vi) Devices to aid victims in distress as follows:
      - (A) For pools with width less than twenty-four feet, rescue poles one-half the pool width or more;
      - (B) For pools with width twenty-four feet or more, rescue poles twelve feet or more in length;
      - (C) One or more of the poles with a double crook life hook in pools without lifeguards;
      - (D) One or more reaching poles for every fifteen hundred square feet of pool surface area;
      - (E) Throwing ring buoy, heaving jug, heaving line, throw-rope bag, or other similar devices with rope the width of the pool or fifty feet, whichever is less for reaching and retrieving victim;
      - (F) Rescue tube or rescue buoy at each lifeguard station.
- (b) Limited use swimming pool facilities:
  - (i) During period facility is open for use, one of the following:
    - (A) A telephone within one minute access;
    - (B) Alternate means of reaching emergency medical service response numbers;
    - (C) Provision of an audible emergency alarm to alert others at area of need to respond.
  - (ii) Comply with requirements under subsection (31)(a)(iii), (iv), and (vi) of this section.

(32) **Lifeguard chairs.** Owners shall provide lifeguard chairs as follows:

(a) Where lifeguards are required and pools have depths greater than five feet, at least one lifeguard chair shall be provided adjacent to the deep area of the pool;

(b) Installed to manufacturer standards.

(33) **Signs.** Owners shall provide signs at pools which must convey the following conditions, but may be conveyed by any combination of words, pictures, or symbols:

(a) Prohibition of running or horseplay;

(b) Prohibition of use by persons with communicable diseases;

(c) Prohibition of use by persons under the influence of alcohol or drugs;

(d) Requirement for a cleansing shower before entering the pool;

(e) Warning that persons refusing to obey the regulations are subject to removal from the premises;

(f) Prohibition of food or drink in the pool water;

(g) In pools where lifeguards are not present, post requirements for facility use as described under WAC 246-260-100 (3)(b)(iii) and (c);

(h) Location of nearest telephone for emergency use or emergency notification procedure.

(34) **Food service.** When food service is provided, owners shall:

(a) At general use pool facilities, ensure food and beverage sale and consumption areas are separated from pool and deck enclosure areas. Special provisions may be made for allowing food and beverage service on the walkway provided a minimum six feet clear area is maintained between the pool edge and any tables or chairs provided for special facility functions;

(b) At limited use pool facilities, prohibit food and beverage in the pool water and maintain a minimum four foot clear area between pool edge and any tables and chairs provided for food service;

(c) At general use pool facilities, prohibit alcohol;

(d) At limited use pool facilities, when alcohol is sold within the pool facility, provide an attendant at the pool area;

(e) Provide trash containers;

(f) Prohibit glass containers in the pool facility.

(35) **Drinking fountain.** Owners shall provide an operable drinking fountain at general use swimming pools fifteen hundred square feet or more. Drinking fountains shall conform with American Standards Association requirements.

(36) **Foot baths.** Owners shall prohibit the use of foot baths at water recreation facilities. This does not preclude use of foot showers, provided the area is well drained.

[Statutory Authority: RCW 70.90.120, 92-02-020 (Order 226B), § 246-260-090, filed 12/23/91, effective 1/23/92. Statutory Authority: RCW 43.20.050, 91-02-051 (Order 124B), recodified as § 246-260-090, filed 12/27/90, effective 1/31/91. Statutory Authority: RCW 70.90.120, 90-07-010 (Order 042), § 248-98-050, filed 3/12/90, effective 4/12/90; § 248-98-050, filed 10/3/67; Regulation .98.050, effective 3/11/60.]

**WAC 246-260-100 Operation of swimming pool facilities.** (1) **Operation plan.** Owners shall ensure proper operation to protect the public health, safety, and water quality by establishing practices and developing an operations manual addressing each of the following:

(a) Physical pool facility components;

(b) Personnel;

(c) Users and spectators;

(d) Environmental conditions.

(2) **Physical components.** Owners shall provide routine checks of the physical components:

(a) Ensuring all structural facilities which the users come in contact are intact and free from undue wear or fatigue and replaced as needed;

(b) Eliminating adverse affects of water ponding on walking surfaces;

(c) Ensuring preventive maintenance on equipment essential for protection of the public health, safety, and water quality;

(d) Ensuring any necessary emergency equipment is available and in good repair;

(e) Maintaining barrier protection;

(f) Ensuring common articles such as towels, bathing suits, bathing caps, etc., for patron use are sanitized before reuse if provided for patrons; and

(g) Ensuring treatment and turnover times are continuous twenty-four hours a day during seasons or periods of use and do not exceed six hours provided:

(i) Allowances shall be made for minor equipment maintenance;

(ii) Pools previously approved with turnover rates varying from subsection (2)(g)(i) of this section may continue to operate if water quality conditions conform with WAC 246-260-070.

(3) **Required personnel.** Owners shall ensure appropriate personnel at pool facilities as follows:

(a) General use pool facilities having one or more pools fifteen hundred square feet or more in surface area shall have lifeguards present at all times pools are in use, except:

(i) Pools having surface area less than twenty-five hundred square feet, four and one-half feet or less in depth, limiting use from two to ten adults in the pool are not required to have a lifeguard;

(ii) When swim teams are facility users, the owner may allow substitution of qualified coaches. See subsection (5) of this section to substitute for a lifeguard for guarding of a swim team.

(b) General use pool facilities less than fifteen hundred square feet shall provide lifeguards or attendants as follows:

(i) Lifeguards shall be present:

(A) If pool facility provides training for water safety and basic swimming instruction for children twelve years of age or under; or

(B) If pool facility provides training for safety and basic swimming instruction for adults and the pool is over four feet deep; or

(C) When pool facility provides training, practice, and/or meets for swim teams, substitution may occur as described under subsection (3)(a)(ii) of this section.

(ii) Attendants or lifeguards shall be present when organized programs are provided at the pool facility, for example, teaching of adult swimming lessons in water four feet or less, formal exercise classes, and the like;

(iii) When no lifeguard or attendant is present, the facility use shall be limited by the following conditions:

(A) When pool is used by children twelve years of age or under, a responsible adult eighteen years of age or older

shall accompany the children and be at the pool or pool deck at all times the children use the facility;

(B) When used by persons seventeen years of age or under, a minimum of two people at the pool facility at all times the pool is in use;

(C) Subdivision (b)(iii)(A) and (B) of this subsection posted.

(c) When lifeguards are not provided at limited use pool facilities, within the conditions noted in the definition for a limited use pool, use of the facility shall be limited by the following conditions:

(i) When the pool is used by children twelve years of age or under, a responsible adult eighteen years of age or older shall accompany the children and be at the pool or pool deck at all times the children use the facility;

(ii) When used by persons seventeen years of age or under, a minimum of two people at the pool facility at all times the pool is in use;

(iii) Subdivision (c)(i) and (ii) of this subsection posted and ongoing provisions to notify the responsible person of conditions for use of the facility.

(d) A water treatment operator.

(4) **Personnel duties and equipment.** Owners shall ensure the specific duties and equipment of designated personnel include:

(a) Lifeguards during periods of lifeguarding, guard users of the pool facility in areas assigned;

(b) Assistant lifeguards when provided at the pool used under the following conditions:

(i) Fifty percent or more of the persons assigned to guard on the deck are lifeguards;

(ii) Assistant lifeguards limited to guarding responsibility of areas four feet or less in depth; and

(iii) One or more lifeguards on duty trained at the equivalent of "lifeguard training" as recognized by the ARC or equivalent as recognized by the department.

(c) Attendants, when provided at pools not requiring lifeguards, oversee pool use by the bathers and provide supervision and elementary rescues such as reaching assists to bathers in need. This does not mean the person is qualified or trained to make swimming rescues;

(d) Qualified swimming coaches when substituting for lifeguards, guard swimming team at the pool facility in areas assigned;

(e) Water treatment operator oversees that the water treatment components are functioning adequately to protect public health, safety, and water quality;

(f) Notification of responsible persons on the conditions for facility use at pool facilities not requiring lifeguards, and for which no lifeguards or attendants are present. A responsible person means a person having responsibility for overseeing users seventeen years of age or under including, but not limited to a person:

(i) Renting an apartment, hotel, motel, RV camp site; or

(ii) Who is an owner or member of a condominium, homeowner's association, mobile home park, or private club with a pool facility.

(g) Lifeguards, assistant lifeguards, or attendants:

(i) Wearing a distinguishing suit, uniform, or emblem; and

(ii) Equipped with a whistle or a signaling device.

(5) **Personnel training.** Owners shall require training for each type of personnel including:

(a) Lifeguards shall maintain current certificates in the following:

(i) Standard first aid and adult, single rescue CPR through ARC or the American Heart Association; and

(ii) Advanced lifesaving, advanced lifesaving review, or lifeguard training through ARC; or

(iii) YMCA lifeguarding or crossover course through the YMCA; or

(iv) Lifeguard through the National Lifeguard Service, Canadian; or

(v) Lifeguard through the National Pool and Waterpark Lifeguard Training Course; or

(vi) Basic lifeguard through advanced lifeguard training international; or

(vii) Other training the department determines equivalent; and

(viii) Thirty-six months after enactment of the personnel training provisions of this chapter, the department will no longer recognize training for lifeguards in advanced lifesaving or advanced lifesaving review through the ARC.

(b) Assistant lifeguards shall maintain current certificates and meet the requirements in the following:

(i) Adult, single rescue CPR through ARC or the American Heart Association; and

(ii) Emergency water safety with ARC; or

(iii) Bronze medallion award through the Royal Lifesaving Society of Canada;

(iv) Shallow water lifeguard through the National Pool and Waterpark Lifeguard Training; or

(v) Other training the department determines equivalent; and

(vi) Be fourteen years of age or older.

(c) Swim coaches substituting for lifeguards with swim teams shall maintain current certificates through the following:

(i) Standard first aid and adult, single rescue CPR through ARC or the American Heart Association; and

(ii) Safety training for swim coaches through ARC; or

(iii) Other training the department determines equivalent.

(d) Attendant shall maintain current certificates and meet the requirements in the following:

(i) Adult, single rescue CPR through ARC or the American Heart Association; and

(ii) Basic water safety with ARC; or

(iii) Other training the department determines equivalent; and

(iv) Be sixteen years of age or older.

(e) Water treatment operator shall have specific knowledge in provision of pool water chemistry, filtration, pumping equipment, and rules and regulations pertaining to pool facilities;

(f) When pool facility is using chlorine gas, an operator shall have specific training as follows:

(i) Proper operation of the chlorination equipment and routine maintenance procedures;

(ii) Basic understanding of physical and chemical properties of chlorine gas under pressure;

(iii) Basic understanding on use of leak detection and emergency safety equipment;

(iv) Basic knowledge of proper first-aid procedures and response for accidental inhalation of chlorine gas;

(v) Six hours or more of formal instruction once every three years or three hours or more every eighteen months with certificate of training provided.

(g) Persons shall be exempt from having current CPR or standard first-aid certificates if the persons hold current certificates in any of the following:

(i) Community CPR in the place of adult, single rescue CPR;

(ii) In the place of standard first aid:

(A) Advanced first aid;

(B) First responder;

(C) Emergency medical technician; or

(D) Paramedic.

(iii) Other training the department recognizes as equivalent or exceeding current requirements.

(6) **Emergency response plan.** Owners shall ensure emergency response provisions as follows:

(a) In pool facilities where lifeguards, assistant lifeguards, or swim coaches are required:

(i) Sufficient qualified personnel, for example, lifeguards, assistant lifeguards, or swim coaches where appropriate, located to provide a response time not to exceed thirty seconds to all pool users;

(ii) Based on, but not limited to, the following:

(A) Pool depth;

(B) Line of sight;

(C) Bather load;

(D) Training procedures;

(E) Emergency procedures, and

(F) Lifeguard rotation.

(iii) Emergency response drills to meet the response time including:

(A) Drills two or more times each year;

(B) Testing documentation.

(iv) Where SCUBA or kayaking lessons are performed at the pool, personnel guarding these activities shall be provided special in-service training.

(b) In pool facilities where no lifeguards are provided:

(i) Posting and ongoing notification and enforcement of conditions for pool use. See subsection (3)(b) and (c) of this section;

(ii) Enforcement of conditions by owner and authorized personnel;

(iii) Emergency equipment specified under WAC 246-260-090(31), readily available during operating hours.

(c) Ongoing training and evaluation of the lifeguarding skills and/or assistant, coach, or attendant skills;

(d) In facilities where chlorine gas is used:

(i) Annual emergency drills;

(ii) Identification of the location of accessible chlorine cylinder repair kits.

(7) **Bather use.** Owners shall establish rules of conduct for facility users to ensure health and safety as follows:

(a) Signage noted under WAC 246-260-090(33);

(b) Facilities used for swimming instruction courses may allow diving into water depths recognized as adequate by the organization providing the certificates, for example ARC or YMCA, provided the divers are supervised by instructors.

(8) **Environmental conditions.** Owners shall monitor various environmental conditions affecting the facility or the

user and take appropriate action in response to these factors, including electrical storms, fog, wind, visibility problems, etc.

(9) **Closure.** Owners shall close the facility when the facility or portion thereof presents an unhealthful, unsafe, or unsanitary condition. These conditions include lack of compliance with the water quality or operation requirements as detailed under WAC 246-260-070 and 246-260-100.

[Statutory Authority: RCW 70.90.120. 92-02-020 (Order 226B), § 246-260-100, filed 12/23/91, effective 1/23/92. Statutory Authority: RCW 43.20.050. 91-02-051 (Order 124B), recodified as § 246-260-100, filed 12/27/90, effective 1/31/91. Statutory Authority: RCW 70.90.120. 90-07-010 (Order 042), § 248-98-060, filed 3/12/90, effective 4/12/90; Regulation .98.060, effective 3/11/60.]

**WAC 246-260-110 Spa pool design, construction, and equipment.** (1) **Location.** Owners shall locate pools to:

(a) Minimize pollution by dust, smoke, soot, and other undesirable substances;

(b) Eliminate pollution from surrounding surface drainage; and

(c) Ensure pump house, trees, and other structure locations are fifteen feet or more away from the pool or provide barriers or other means to prevent ready access from any such structure. Structures shall not be construed to include:

(i) Building walkways above the second story or roofs of any building structure; or

(ii) Any barriers provided to prevent unauthorized pool access, for example, fencing.

(2) **Materials.** Owners shall use only structure and equipment materials which are nontoxic, durable, inert, impervious to water, and easily cleanable.

(3) **Walking surfaces.** Owners shall design and maintain walking surfaces:

(a) Uniformly sloping away from the pool or pools with a minimum of one-fourth inch per foot and a maximum of one-half inch per foot;

(b) Of a nonslip finish not presenting a tripping hazard;

(c) Equipped with sufficient drains to prevent standing water;

(d) Of easily cleanable impervious finishes;

(e) Providing a minimum unobstructed six feet by seven feet area adjacent to the pool;

(f) Continuous and four feet wide or more extending around the entire pool if perimeter is equal to or greater than forty feet;

(g) Forty inches or less below horizontal ledge of elevated pool. Elevated pools over twelve inches above deck level shall have a maximum ledge thickness of twelve inches, except in the area of stairs;

(h) Continuously extending, and four feet wide or more, around fifty percent or more of the pool, if the pool is over forty inches above the primary walkway; and

(i) In conformance with department-established guidelines for any resilient artificial surfaces.

(4) **Barriers.** Owners shall provide barrier protection to prevent unauthorized access.

(a) A barrier shall be sixty inches or more in height and:

(i) Shall not allow passage of a four-inch diameter sphere;

(ii) If it has horizontal members that are spaced less than forty-five inches between the tops of the horizontal members, shall have spaces between the vertical members no greater than a width of one and three-quarter inches (see Figure 110.1); or

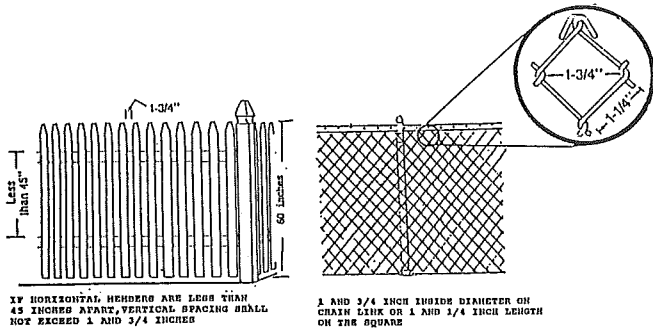

(iii) If it has horizontal members that are spaced at, or more than, forty-five inches between the tops of the horizontal members, shall have spaces between the vertical members no greater than a four-inch width (see Figure 110.2); and

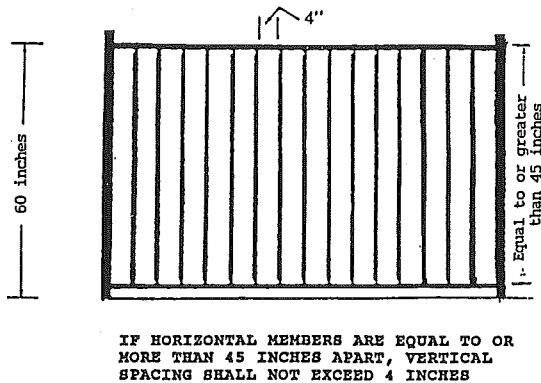

(iv) Shall have lockable gates and entrances provided with a self-closing, self-latching mechanism fifty-four inches or more from the ground with a clear space fifty inches deep on the latch side of the door to position a wheelchair. When a latching mechanism is provided at any lower height, the latching mechanism shall be of a type remaining continuously locked, and only opening with the use of a key or other access control system.

(b) Restricted area service entrances shall be exempt from door or gate requirements providing no public access is available;

(c) Lifeguarded pools are not required to have a self-closing, self-latching gate during the period a pool is in use. Facility gates shall be closed and locked during nonuse periods; and

(d) An entrance to the pool area which shall not serve as a required exit from another part of a building when there is a conflict with other codes or regulations.

(5) **Spa pool structure.** Owners shall ensure general pool requirements include:

(a) Pool surfaces which are nontoxic, impervious, smooth, easily cleanable, and enduring. Pools one hundred square feet or more shall be a white or light color;

(b) A dimensional design providing for safety, circulation, and quality of the water including, but not be limited to:

(i) Surfaces not causing cutting, pinching, puncturing, entanglement, or an abrasion hazard under casual contact;

(ii) Construction tolerances conforming with current NSPI public spa standards;

(iii) Uniform floor slopes not exceeding one foot of drop in twelve feet of run sloped to drain;

(iv) A minimum height between the top of the pool rim and the ceiling shall be seven feet; and

(v) Maximum operational depth of four feet measured from the water line. Exceptions may be made for special purpose designed pools.

(c) Adequate means to routinely drain or otherwise remove water from the pool.

(6) **Spa pool appurtenances.** Owners shall ensure pools contain:

(a) Handholds around the pool perimeter two feet or more in depth. Handholds shall be four feet apart or less and consist of any one or a combination of the following:

(i) Coping, ledges, radius flanges, or decks along the immediate top edge of the pool or suitable slip-resisting handholds located twelve inches or less above the water line;

(ii) Ladders or steps; or

(iii) Secured rope or railing twelve inches or less above the water line.

(b) Stairs:

(i) Meeting the following construction requirements:

(A) Nonslip tread finishes;

(B) Contrasting color stair tread edges clearly visible to users;

(C) Handrails with the leading edge for stairs at pool entry/exit being neither eighteen inches or more beyond nor eight inches or more inside (horizontally) the vertical plane of the bottom riser;

(D) Less than or equal to twenty feet of any point within the spa measured at the wall at the point of entry;

(E) Riser treads with a minimum unobstructed, horizontal, ten-inch tread depth and a minimum two-hundred-forty-inch surface area;

(F) Riser heights on spa pools over forty feet in perimeter, uniform and seven and one-half inches or less, except the bottom riser may be less than uniform height; and

(G) Riser heights on spa pools of forty feet or less in perimeter, uniform and have a preferred seven and one-half inch height, but not greater than ten inches, except the bottom riser may be less than uniform height.

(7) **Spa pool bather design capacity and load.** Owners shall design and control the pool use to not exceed a maximum bather capacity and load as designated below:

(a) The maximum bather capacity is one person per four square feet. Maximum bather capacity is the maximum number of bathers at any one time; and

(b) Bather loads are designated in terms of three different loading conditions: Light, moderate, and heavy use as shown under Graph 040.1. Maximum bather load is the maximum number of bathers in a one-hour period. Interpret a single bather use to mean a bather using the pool for a fifteen minute duration. For pools with volumes greater than noted on the graph, loadings shall be based on the continued slope of the line above each use category.



GRAPH 110.3 SPA DESIGN FOR BATHER LOAD AND TURNOVER

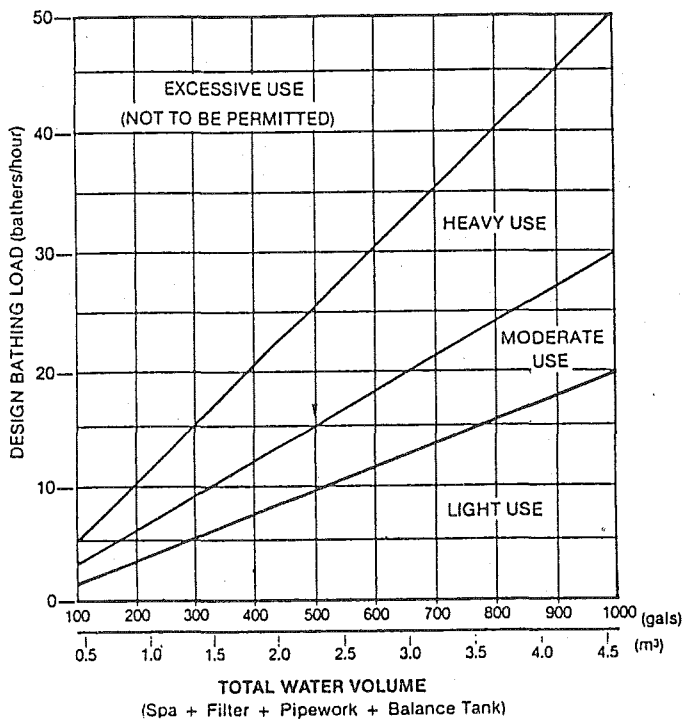

(8) **Turnover.** Owners shall ensure pools turn over entire pool water volume at rates in accordance with designated bather load as determined from Graph 110.3 noted in subsection (7) of this section.

(a) Minimum turnover time for treatment recirculation shall be:

- (i) For light use pool facilities, thirty minutes;
- (ii) For moderate use pool facilities, twenty minutes;
- (iii) For heavy use pool facilities, ten minutes.

(b) Exceptions to recirculation requirements may be made for flow-through pools in the following conditions:

(i) Where water supply is sufficient to provide the same turnover period specified for recirculation pools;

(ii) The source water supply meets the quality requirements and is subject to a disinfection method outlined under WAC 246-260-070(3);

(iii) The introduction of fresh treated pool water is accomplished by the same type of inlet and outlet design required for recirculation pools; and

(iv) The pool water quality complies with WAC 246-260-070.

(9) **Inlets.** Owners shall provide pool inlets:

(a) Submerged and located to produce uniform water and chemical circulation throughout the pool;

(b) Located on the bottom of pools ten thousand gallons or more, unless otherwise justified by the design engineer to either the department's or local health officer's satisfaction.

(10) **Outlets.** Owners shall provide pool outlets with:

(a) Overflow and main drain grating systems each designed to carry one hundred percent of the total recirculation filter flow, and main drain piping designed to carry fifty percent or more of the total recirculation filter flow;

(b) Overflow outlets maintaining:

(i) A minimum of sixty percent of filter recirculation flow at all times; and

(ii) An overflow channel which may be used on any pool and required on pools ten thousand gallons or more on the pool perimeter to promote uniform circulation and skimming action of the upper water layer with:

(A) A design preventing all matter entering the channel from returning to the pool;

(B) Dimensions minimizing bather hazards, such as catching arms or feet;

(C) One one-hundredth of a foot slope per foot or more;

(D) Drains sufficiently spaced and sized to collect and remove overflow water to return line and filter, where applicable; and

(E) Size sufficient to prevent flooded suction conditions on the overflow system and to properly drain water away from the pool. Displacement shall be computed at twenty gallons per bather. Balancing tanks use is optional dependent on the overflow channel volume and design.

(iii) Skimmers in lieu of pool overflow channels up to ten thousand gallons if:

(A) Weir provided in skimmer has a maximum flow rate through skimmer not exceeding four gpm per inch of weir;

(B) Devices are recessed in the pool wall so no part protrudes beyond the plane of the wall into the pool;

(C) The skimmer is equipped with a device to prevent air lock in the recirculation suction line, such as, an equalizer line;

(D) The skimmer is equipped with a removable and cleanable screen designed to trap large solids;

(E) Automatically adjustable and operates freely with continuous skimming action to continue through all loading rates as the skimmer is designed. Displacement shall be computed at twenty gallons per bather.

(c) Main drains in all pools with:

(i) Location of one main drain or more at the lowest point of the pool floor, or means to readily drain the entire pool water readily available;

(ii) A minimum of two main drains with equivalent recirculation capacity and net surface open area; or on spa pools with fifteen hundred gallon volume or less, a large single main drain twelve inches square or more in surface area;

(iii) A design to aid in hair entrapment prevention when main drains are on vertical walls;

(iv) Total open area of grates sized to prevent a suction or entrapment hazard dangerous to user;

(v) Grates on drains with a:

(A) Maximum flow of one and one-half feet per second; or

(B) Net outlet area four times or more the area of the discharge pipe;

(vi) Openings not allowing a sphere over one-half inch in diameter to pass;

(vii) Grates designed to withstand forces of users;

(viii) Grates removable only with specific tools; and

(ix) Means to control flow from recirculation pump or balancing tank.

(11) **Flow.** Owners shall maintain pool recirculation flow not to exceed:

(a) Six feet per second in the valved suction or discharge side of the pump; and

(b) Ten feet per second in open discharge pipes on the pressure side of the pump or filter discharge. The recirculation flow limit does not apply to the return inlet and the last two feet of pipe leading to the inlet.

(c) The recirculation piping of the spa pool shall not inter-mix back with any companion swimming pool water.

(12) **Pumps.** Owners shall have and maintain recirculation pumps with adequate capacity to:

(a) Provide design flows and pressure for water recirculation over the entire operating filter pressure;

(b) Allow proper backwashing of filters when specified;

(c) Have self-priming capability when installed above the pool water level; and

(d) Ensure the recirculation pump system shall have a separate water treatment pump than that used for hydrotherapy spa action, unless automatic flow control valving is provided to limit filter flow to required design.

(13) **Strainers.** Where pumps precede the filter, owners shall equip pool recirculation facilities with hair and lint strainers which shall:

(a) Be located upstream of recirculation pumps;

(b) Provide strainer screen sufficiently strong to prevent collapse when clogged;

(c) Have an operable cover; and

(d) Provide valving to isolate the strainer when located below pool water level.

(14) **Valves.** Owners shall provide valves at appropriate locations to allow equipment isolation and maintenance.

(15) **Equipment rooms.** Owners shall provide equipment rooms for a spa pool with:

(a) Ten thousand gallons or more in water volume or for spa pools provided adjacent to a swimming pool at the same facility with:

(i) Enclosed pumps, disinfection equipment, filters, and other electrical and mechanical feed equipment and associated chemicals. Storage of chemicals shall conform to manufacturer requirements;

(ii) Working space and access to perform routine operation;

(iii) A forty-six-square-foot minimum floor area and provides a three-foot minimum access area to service equipment;

(iv) One floor drain or more and a floor slope to the drain at a one-fourth-inch-per-foot minimum;

(v) If below grade, ready access;

(vi) Ventilation;

(vii) Twenty foot candles or more of light measured thirty inches from the floor; and

(viii) Kept locked.

(b) Less than ten thousand gallons in water volume or for spa pools not provided at the same facility as a swimming pool complying with subsection (15)(a)(i), (ii), (v), and (viii) of this section.

(16) **Make-up water.** Owners shall ensure a source of make-up water and associated piping at the pool:

(a) Providing sufficient quantity to replace daily pool water losses;

(b) Coming from a supply conforming with chapter 246-290 WAC;

(c) Preventing cross connections using a minimum air gap of two pipe diameters or approved backflow prevention

devices between the make-up water source and the pool water or waste water; and

(d) If using a pool fill spout, not projecting greater than one inch into the space above the water surface area and shielded to not create a deck hazard.

(17) **Filters.** Owners shall equip pools with filtration equipment:

(a) Meeting the applicable NSF standards or equivalent;

(b) Using acceptable type and filter rates described under Table 040.2 of this section;

(c) Having pressure or vacuum gauges for measuring loss of head through the filter with a minimum of one gauge preceding and one gauge following the filter;

(d) Having a rate of flow indicator to measure a flow with accuracy, repeatability, and durability equivalent to flow meters meeting NSF standards; and

(e) Having means of discharging filter backwash to waste with:

(i) Discharge in a manner not creating a public nuisance;

(ii) Disposal in accordance with applicable local laws or regulations;

(iii) Minimum air gap of two pipe diameters to prevent cross-connection from waste discharge and recirculation system piping;

(iv) Discharge receptor and sufficient size piping to accept backwash water and to prevent flooding; and

(v) Ability to monitor filter effluent during backwash, that is, use of sight glass.

(f) Providing means to release air entering the filter tank on pressure filters;

(g) When cartridge filters are used:

(i) Provide with an extra set of cartridges; and

(ii) Have any bypass valves in a permanently closed position.

(h) When using pressure DE filters with separation tanks:

(i) Providing a means of air release or a lid providing a slow and safe release of pressure; and

(ii) Showing a readily visible user warning that the air release must be opened before starting the circulation pump.

TABLE 110.4

SPA POOL FILTER RATE APPLICATION RATES

Type of Filter Media	Rates in gpm/Square Feet		
	Minimum	Maximum	
Sand	Minimum	Maximum	
	Rapid Sand or Pressure Sand	—	3
High Rate Sand Pressure or Vacuum	10	15	
	Continuous Feed	Manual Feed	
DE	Pressure	0.8	1.0
	Vacuum	1.0	1.35
Cartridge*			.375

NOTE:

\*Cartridge filters shall have a nominal micron rating of twenty microns or less.

(18) **Disinfection equipment.** Owners shall provide disinfection equipment:

- (a) Providing a continuous and effective disinfectant residual in the water;
- (b) Using a disinfectant with an easily monitored residual;
- (c) Having a design feed rate providing effective disinfection levels when the pool is in peak demand conditions;
- (d) Having easily cleanable equipment and piping used to apply chemicals and with provisions to prevent undue clogging. All materials shall be resistant to action of chemicals used;
- (e) Conforming to NSF standards if the disinfection equipment contains:
  - (i) Adjustable output rate chemical feed equipment for liquid solutions. The equipment shall:
    - (A) Feed under positive pressure in the recirculation system;
    - (B) Provide means for dosage adjustment;
    - (C) Have provisions to prevent hypochlorite solution siphoning when equipment is turned off. This applies when the disinfection equipment is above pool water level.
  - (ii) Flow through chemical feed for solid feed materials. Solid tablets or granules shall not be placed in skimmer baskets accessible to the public.
- (f) Allowing hand feeding on an emergency basis only;
- (g) Meeting the following conditions when using chlorine gas:
  - (i) Chlorine rooms shall:
    - (A) Be above ground level;
    - (B) Be constructed so all openings or partitions with adjoining rooms are sealed;
    - (C) Be located with consideration of prevailing winds to dissipate leaked chlorine away from the pool facility;
    - (D) Have door opening outward only and to the out-of-doors; and
    - (E) Provide a sign on the door exterior reading DANGER CHLORINE. The sign shall be large enough to be read twenty-five feet away.
  - (ii) Chlorine rooms shall have mechanical exhausting ventilation including:
    - (A) Air inlet located as far as possible from fan intake to promote good air circulation patterns;
    - (B) Minimum of one air change per minute in the chlorine room when fan is operating;
    - (C) A remote switch outside the room or a door-activated switch to turn on fan before entering;
    - (D) Suction for fan near the floor;
    - (E) Exhaust for fan and chlorinator vent located to prevent contaminating air intake and prevent undue hazard for pool facility users; and
    - (F) Screened chlorinator vent.
  - (iii) Gas chlorine systems shall:
    - (A) Be vacuum injection type, with vacuum actuated cylinder regulators;
    - (B) Provide integral backflow and anti-siphon protection at the injector;
    - (C) Provide taring (net weight of cylinder gas) scales to determine chlorine weight.
  - (iv) Breathing protection available in an accessible area for the operator outside of the chlorine room including:
    - (A) Self-contained breathing apparatus designed for use in a chlorine atmosphere for working with chlorine leaks and

maintained in accordance with department of labor and industries standards; or

(B) Provisions to substitute breathing protection at the site, if procedures can be established and documented with emergency service fire districts or other approved organization within the area for promptly responding to chlorine leaks.

(v) Means for automatic shutoff when pool flow is interrupted;

(vi) Chlorine gas cylinders shall:

(A) Be stored only in chlorine rooms;

(B) Have approved valve-stem cylinder wrench on the valve stem to shut the system down in an emergency event;

(C) Be properly secured to prevent tipping;

(D) Be tagged to indicate cylinders are empty or full; and

(E) Not exceed one hundred fifty pounds tare weight per cylinder. If one-ton cylinder use is desired, an engineer specializing in chlorine design shall prepare a design proposal for department consideration.

(19) **Chemical feeding equipment for pH control.** Owners applying chemicals for controlling pH through chemical feed equipment shall provide equipment with:

(a) Adequate size and design to allow routine cleaning and maintenance;

(b) Materials resistant to chemical action;

(c) Means for automatic shut off when pool flow is interrupted;

(d) Chemical feed equipment for pH control on pools ten thousand gallons or greater;

(e) Any pool feeding with:

(i) Caustic soda (NaOH);

(ii) Carbon dioxide (CO<sub>2</sub>); or

(iii) Other chemicals the department determines necessary to require metered and controlled feeding.

(20) **Heaters.** Where pool heating equipment is provided, owners shall:

(a) Locate equipment so any standing pilot is readily accessible;

(b) Install equipment per NEC and UMC.

(21) **Ventilation.** Owners shall provide indoor pool facility ventilation conforming with ASHRAE pool facility standards.

(22) **Testing equipment.** Owners shall use testing equipment as noted in the water quality section under WAC 246-260-070(6).

(23) **Chemical storage.** Owners shall ensure chemical storage design and placement minimizes safety risks.

(24) **Restroom and plumbing fixtures.** Owners shall provide restrooms and plumbing facilities at pools as follows:

(a) In the spa pool facilities provided in conjunction with general use and limited use swimming pools, wading pools, or other water recreation facilities, the spa pool bathing load shall be added to the total load for consideration of plumbing fixture units;

(b) If a spa pool is the sole water recreation facility at a site, plumbing fixtures, as noted under Table 110.5, including:

(i) Flush toilets and toilet tissue in dispensers;

(ii) Shower facilities that:

- (A) Deliver water at a temperature range of ninety to one hundred ten degrees Fahrenheit; and
- (B) Provide single service soap in nonglass dispensers.
- (iii) Sinks provided with:
  - (A) Tempered or hot and cold running water;
  - (B) Single service soap in nonglass dispensers; and
  - (C) Single service towels or electric hand dryer.
- (iv) Hose bibs with vacuum breakers conveniently accessible to pool and within one hundred feet; and
- (v) Sewage disposed in a manner approved by the department or local health officer.
- (c) If owners limit the number of people within their facility to a certain number and post maximum occupancy loading, the number of plumbing fixtures may be based on the maximum occupancy.

TABLE 110.5

PLUMBING FIXTURE MINIMUM REQUIREMENTS FOR SOLE FACILITY SPA POOLS

Spa Pools With:	Minimum Number of Fixture Units				
	Toilet	Shower	Sink	Dress- ing Room	Hose Bib
1. Limited spa use with living units* within 100 feet and less than 3 stories	-	-	-	-	1
2. Limited spa use with living units > 100 ft. and < 500 ft. and < three stories**	1	-	1	-	1
3. Limited spa use with living units > 500 ft. and < 1/4 mi. and/or > three stories**	1(M) 1(F)	1(M) 1(F)	1(M) 1(F)	- -	1 -
4. Limited spa use with living units > 1/4 mile or general use spa pool***	1(M) 1(F)	1(M) 1(F)	1(M) 1(F)	1(M) 1(F)	1 -

NOTE:

- \*"Living unit" means all the units the facility serves.
- \*\*Consideration for elevators adjacent to pool may allow variance from this requirement.
- \*\*\*When bathing load exceeds 40 of either sex, the fixture units provided shall conform to general use requirements for swimming pools.

(25) **Lighting.** Owners shall design and maintain pool facility lighting to:

- (a) Illuminate indoor facilities, outdoor facilities used after dusk, and locker room facilities with a minimum lighting intensity maintained thirty inches above any walking surface, pool deck, or pool area of:
  - (i) Thirty foot candles at indoor facilities;
  - (ii) Fifteen foot candles at outdoor facilities; and
  - (iii) Twenty foot candles in locker rooms.
- (b) Allow lifeguards or attendants to clearly see pool areas and walking surfaces;
- (c) Meet any additional lighting requirements deemed necessary by the department or local health officer;
- (d) Provide protective shielding for all lighting fixtures above walking surfaces and pool areas; and

(e) Provide all indoor facilities with one or more pool-area emergency lights designed to turn on in the event of a power failure. The emergency lighting shall conform to requirements of UL standard 924.

(26) **Emergency equipment.** Owners shall provide first aid and emergency equipment readily available during operating hours as follows:

- (a) Spa pool facilities ten thousand gallons or more or used in conjunction with a general use swimming pool:
  - (i) A telephone within the facility with a prominently displayed list of emergency medical service response numbers;
  - (ii) Sufficient and suitable area provided to accommodate persons within the facility requiring first aid treatment and necessary first aid equipment;
  - (iii) A standard sixteen unit first aid kit;
  - (iv) Two or more blankets reserved for emergency use;
  - (v) A clearly marked emergency shut off switch for shutting off all pumps, accessible to the public within twenty feet of the pool. Spa pool facilities shall also provide an audible alarm with the emergency shut off switch; and
  - (vi) Heater thermostat switches shall be inaccessible to bathers.

(b) Spa facilities containing less than ten thousand gallons:

- (i) During the period the facility is open for use, one of the following is required:
  - (A) Telephone within one minute access;
  - (B) Alternate means of reaching emergency medical service response numbers; or
  - (C) Provision of an audible emergency alarm to alert others at the area of need to respond.
- (ii) Comply with subsections (26)(a)(iii), (iv), (v), and (vi) of this section.

(27) **Signs.** Owners shall provide signs at pools which must convey the following conditions, but may be conveyed by any combination of words, pictures, or symbols:

- (a) Prohibition of running or horseplay;
- (b) Prohibition of use by persons with communicable diseases;
- (c) Prohibition of use by persons under the influence of alcohol or drugs;
- (d) Requirement for a cleansing shower before pool entry;
- (e) Caution that persons suffering from heart disease, diabetes, or high blood pressure should consult a physician before spa pool use;
- (f) Caution for women who are or may be pregnant to seek the advice of a physician regarding spa use and to limit the women's time in the pool;
- (g) Persons should limit the stay in the pool to fifteen minutes at any one session;
- (h) All children twelve years of age or under shall be accompanied by a responsible adult observer. No child six years of age or under should use the pool;
  - (i) No person seventeen years of age or under shall use the pool alone;
  - (j) Maximum bathing capacity of pool shall be posted;
  - (k) Prohibition of food or drink in the pool water;
- (l) In pools where lifeguards or attendants are not present, post requirements for facility use as described under WAC 246-260-120(3); and

(m) Location of the nearest telephone or emergency notification procedure.

(28) **Food service.** When owners allow or make provisions for food service:

(a) At general use pool facilities, ensure food and beverage sale and consumption areas are separated from pool and deck. Special provisions may allow food and beverage service on the walkway provided a minimum six feet clear area is maintained between the pool and any tables or chairs provided for food service for special facility functions;

(b) At limited use spa pool facilities, prohibit food and beverage in the pool water and maintain a minimum four foot clear area between pool edge and any tables and chairs provided for food service;

(c) At general use pool facilities, prohibit alcoholic beverages;

(d) At limited use pool facilities, when alcohol is sold within the pool facility, provide an attendant at the pool area;

(e) Provide trash containers; and

(f) Prohibit glass containers in the pool facilities.

[Statutory Authority: RCW 70.90.120. 92-02-020 (Order 226B), § 246-260-110, filed 12/23/91, effective 1/23/92. Statutory Authority: RCW 43.20.050. 91-02-051 (Order 124B), recodified as § 246-260-110, filed 12/27/90, effective 1/31/91. Statutory Authority: RCW 70.90.120. 90-07-010 (Order 042), § 248-98-040, filed 3/12/90, effective 4/12/90; Regulation .98.040, effective 3/11/60.]

#### **WAC 246-260-120 Operation of spa pool facilities.**

(1) **Operation plan.** Owners shall ensure proper operation to protect the public health, safety, and water quality by establishing practices and developing an operations manual addressing each of the following:

(a) Physical pool facility components;

(b) Personnel;

(c) Users and spectators; and

(d) Environmental conditions.

(2) **Physical components.** Owners shall provide routine checks of the physical components:

(a) Ensuring all structural facilities which the users come in contact are intact and free from undue wear or fatigue and replaced as needed;

(b) Eliminating adverse affects of water ponding on walking surfaces;

(c) Ensuring preventive maintenance on equipment essential for protection of the public health, safety, and water quality;

(d) Ensuring any necessary emergency equipment is available and in good repair;

(e) Having means for routine oxidation of spa pool water provided after heavy use, for example, super chlorination;

(f) Maintaining barrier protection;

(g) Ensuring common articles such as towels, bathing suits, bathing caps, etc., for patron use shall be sanitized before re-use if provided for patrons; and

(h) Ensuring a continuous twenty-four-hour-a-day treatment and turnover during periods of use not exceeding:

(i) Thirty minutes in lightly loaded spas; or

(ii) Twenty minutes in moderately loaded spas; or

(iii) Ten minutes in heavily loaded spas.

(iv) Turnover rates designated in subsection (2) of this section, except allowance shall be made for minor equipment

maintenance and existing pools with turnover rates varying from this section may continue to operate if water quality conditions conform with WAC 246-260-070.

(3) **Required personnel.** Owners shall ensure appropriate personnel at pool facilities as follows:

(a) A lifeguard or attendant. If no lifeguard or attendant is present, pool facility use shall be subject to the following conditions:

(i) When pool is used by children twelve years of age or under, a responsible adult eighteen years of age or older shall accompany the children and be at the pool or the pool deck at all times the children use the facility;

(ii) When used by persons seventeen years of age or under, a minimum of two people at the pool facility at all times the pool is in use;

(iii) At general use pools, subdivision (a)(i) and (ii) of this subsection be posted; and

(iv) At limited use pools, subdivision (a)(i) and (ii) of this subsection be posted and ongoing provisions notifying the responsible person of the conditions.

(b) A water treatment operator.

(4) **Personnel duties and equipment.** Owners shall ensure the specific duties and equipment of designated personnel include:

(a) Lifeguards, during periods of lifeguarding, guard users of the pool facility in areas assigned;

(b) Assistant lifeguards when provided at the pool used under the following conditions:

(i) Assistant lifeguard limited to guarding responsibility of areas four feet or less in depth; and

(ii) A lifeguard overseeing the activities of the assistant lifeguard;

(c) Attendants, when provided, at pools not requiring lifeguards oversee use of the pool by bathers and provide supervision and elementary rescues such as reaching assists to bathers in need;

(d) Water treatment operator oversees that the water treatment components are adequately functioning to protect public health, safety, and water quality;

(e) Notification of responsible persons on the conditions for facility use at pool facilities not requiring lifeguards, and where no lifeguards or attendants are present. A responsible person means a person having responsibility for overseeing users seventeen years of age or under, including but not limited to a person:

(i) Renting an apartment, hotel, motel, RV camp site; or

(ii) Who is an owner or member of a condominium, home owner's association, mobile home park, or private club with a pool facility.

(f) Lifeguards, assistant lifeguards, or attendants:

(i) Wear distinguishing suit, uniform, or emblem; and

(ii) Equipped with a whistle or a signaling device.

(5) **Personnel training.** Owners shall require training for each type of personnel including:

(a) Lifeguards shall maintain current certificates in the following:

(i) Standard first aid and adult, single rescue CPR through ARC or American Heart Association; and

(ii) Advanced lifesaving, advanced lifesaving review, or lifeguard training through ARC; or

(iii) YMCA lifeguarding or crossover course through the YMCA; or

(iv) Lifeguard through the National Lifeguard Service, Canada; or

(v) Lifeguard through the National Pool and Waterpark Lifeguard Training; or

(vi) Basic lifeguard through advanced lifeguard training international; or

(vii) Other training the department determines equivalent; and

(viii) Thirty-six months after enactment of personnel training provisions of this chapter, the department shall no longer recognize training for lifeguards in advanced lifesaving or advanced lifesaving review through the ARC.

(b) Assistant lifeguards shall maintain current certificates and meet the requirements in the following:

(i) Adult, single rescue CPR through ARC or American Heart Association; and

(ii) Emergency water safety with ARC; or

(iii) Bronze medallion award through the Royal Lifesaving Society of Canada; or

(iv) Shallow water lifeguard through the National Pool and Waterpark Lifeguard Training; or

(v) Other training the department determines equivalent; and

(vi) Be fourteen years of age or older.

(c) Attendant shall maintain current certificates and meet the requirements in the following:

(i) Adult, single rescue CPR through ARC or American Heart Association; and

(ii) Basic water safety with ARC; or

(iii) Lifesaver with YMCA; or

(iv) Bronze medallion award through the Royal Lifesaving Society of Canada; or

(v) Other training the department determines equivalent; and

(vi) Be sixteen years of age or older.

(d) Water treatment operator shall have specific knowledge in the provision of pool water chemistry, filtration, pumping equipment, and rules and regulations pertaining to pool facilities;

(e) When the pool facility is using chlorine gas, an operator shall have specific training as follows:

(i) Proper operation of the chlorination equipment and routine maintenance procedures;

(ii) Basic understanding of physical and chemical properties of chlorine gas under pressure;

(iii) Basic understanding on use of leak detection and emergency safety equipment;

(iv) Basic knowledge of proper first aid procedures and response for accidental chlorine gas inhalation; and

(v) Six hours or more of formal instruction once every three years or three hours or more every eighteen months with certificate of training provided.

(f) Persons shall be exempt from having a current CPR or standard first aid certificate if the person holds a current certificate in any of the following:

(i) Community CPR, in place of adult, single rescue CPR;

(ii) In place of standard first aid:

(A) Advanced first aid;

(B) First responder;

(C) Emergency medical technician; or

(D) Paramedic.

(iii) Other training the department recognizes as equivalent or exceeding current requirements.

(6) **Emergency response plan.** Owners shall ensure emergency response provisions as follows:

(a) In pool facilities where lifeguards or assistant lifeguards are provided:

(i) Lifeguard, or assistant lifeguard where provided, is located to provide a response time not to exceed thirty seconds to all pool users;

(ii) Based on, but not limited to, the following:

(A) Pool depth;

(B) Line of sight;

(C) Bather load;

(D) Training procedures;

(E) Emergency procedures; and

(F) Lifeguard rotation.

(iii) Emergency response drills to meet the response time including:

(A) Drills two or more times each year;

(B) Testing documentation.

(b) In pool facilities where no lifeguard or assistant is provided:

(i) Posting and ongoing notification and enforcement of conditions of pool use described under subsection (3) of this section;

(ii) Enforcement of conditions by owner and authorized personnel;

(iii) Emergency equipment specified under WAC 246-260-110(26) readily available during operating hours.

(c) In pool facilities where chlorine gas is used:

(i) Annual emergency drills; and

(ii) Identification of the location of accessible chlorine cylinder repair kits.

(7) **Bather use.** Owners shall establish rules of conduct for facility users to ensure health and safety. The rules shall include signage noted under WAC 246-260-110(27) of this chapter.

(8) **Environmental conditions.** Owners shall monitor various environmental conditions affecting the facility or the user and take appropriate action in response to these factors, including electrical storms, fog, wind, visibility problems, etc.

(9) **Closure.** Owners shall close the facility when the facility or portion thereof presents an unhealthful, unsafe, or unsanitary condition. These conditions would include lack of compliance with the water quality or operation requirements as detailed under WAC 246-260-070 and 246-260-120.

[Statutory Authority: RCW 70.90.120. 92-02-020 (Order 226B), § 246-260-120, filed 12/23/91, effective 1/23/92. Statutory Authority: RCW 43.20.050. 91-02-051 (Order 124B), recodified as § 246-260-120, filed 12/27/90, effective 1/31/91. Statutory Authority: RCW 70.90.120. 90-07-010 (Order 042), § 248-98-045, filed 3/12/90, effective 4/12/90.]

**WAC 246-260-130 Wading pool design, construction, and equipment.** (1) **Location.** Owners shall locate pools to:

(a) Minimize pollution by dust, smoke, soot, and other undesirable substances;

(b) Eliminate pollution from surrounding surface drainage; and

(c) Ensure pump house, trees, and other structures are located fifteen feet or more from the pool or provide barriers or other means to prevent ready access from the structures. Structure shall not be construed to include:

(i) Building walkways above the second story or roofs of any building structure; or

(ii) Any barriers provided to prevent unauthorized pool access, for example, fencing.

(2) **Materials.** Owners shall use only structure and equipment materials which are nontoxic, durable, inert, impervious to water, and easily cleanable.

(3) **Walking surfaces.** Owners shall design and maintain pool walking surfaces:

(a) Uniformly sloping away from the pool or pools a minimum of one-fourth inch per foot and a maximum of one-half inch per foot;

(b) Of a nonslip finish not presenting a tripping hazard;

(c) Equipped with sufficient drains to prevent standing water;

(d) Of easily cleanable, impervious finishes;

(e) Four feet or more in width;

(f) At facilities with swimming pools fifteen hundred square feet or more associated with the wading pool, provide a minimum of sixteen square feet per bather; and

(g) In conformance with department-established guidelines for any resilient artificial surface.

(4) **Barriers.** Owners shall provide barrier protection to prevent unauthorized access.

(a) A barrier shall be sixty inches or more in height and:

(i) Shall not allow passage of a four-inch diameter sphere;

(ii) If it has horizontal members that are spaced less than forty-five inches between the tops of the horizontal members, shall have spaces between the vertical members no greater than a width of one and three-quarter inches (see Figure 130.1); or

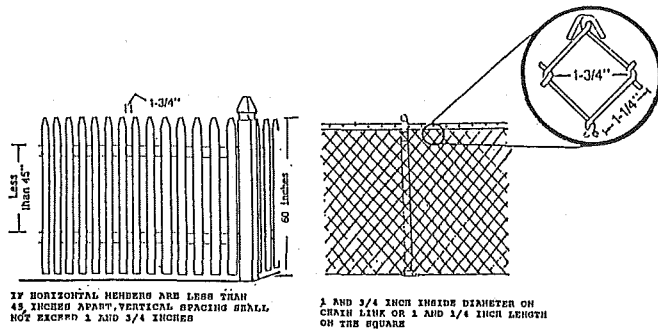

(iii) If it has horizontal members that are spaced at, or more than, forty-five inches between the tops of the horizontal members, shall have spaces between the vertical members no greater than a four-inch width (see Figure 130.2); and

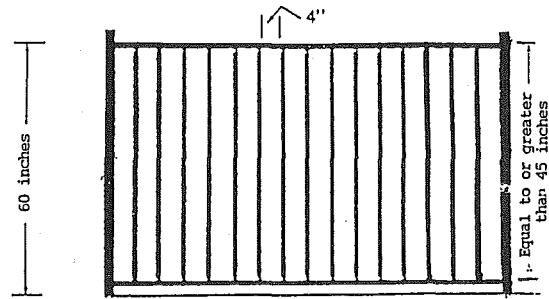

IF HORIZONTAL MEMBERS ARE EQUAL TO OR MORE THAN 45 INCHES APART, VERTICAL SPACING SHALL NOT EXCEED 4 INCHES

(iv) Shall have lockable gates and entrances provided with a self-closing, self-latching mechanism fifty-four inches or more from the ground with a clear space fifty inches deep on the latch side of the door to position a wheelchair. When a latching mechanism is provided at any lower height, the latching mechanism shall be of a type remaining continuously locked, and only opening with the use of a key or other access control system.

(b) Restricted area service entrances shall be exempt from door or gate requirements providing no public access is available;

(c) Lifeguarded pools are not required to have a self-closing, self-latching gate during the period a pool is in use. Facility gates shall be closed and locked during nonuse periods; and

(d) An entrance to the pool area which shall not serve as a required exit from another part of a building when there is a conflict with other codes or regulations.

(5) **Pool surfaces.** Owners shall ensure pool surfaces with:

(a) Materials complying with subsection (2) of this section;

(b) Watertight and nonabrasive construction;

(c) White or light color finish not obscuring the view of objects or surfaces;

(d) Surfaces not causing cutting, pinching, puncturing, entanglement, or abrasion hazard under casual contact; and

(e) Construction tolerances conforming with current NSPI public pool standards.

(6) **Wading pool floor and wall dimensional design.** Owners shall ensure pool dimensional designs for floors and walls provide for safety, circulation, and water quality including, but not limited to:

(a) All corners formed by intersection of walls with floor shall be coved;

(b) Uniform pool floor slopes not exceeding one foot of drop in twelve feet of run.

(7) **Wading pool entry and exit.** Owners shall provide means of entry and exit on all pools including one of the following:

(a) Stairs when provided meeting the following construction requirements:

(i) Nonslip tread finish;

(ii) Contrasting color stair tread edges clearly visible to users;

(iii) Handrails with the leading edge for stairs at entry/exit being neither eighteen inches or more beyond nor eight



inches or more inside (horizontally) the vertical plane of the bottom riser;

(iv) Riser treads with a minimum unobstructed, horizontal, ten-inch tread depth and minimum two-hundred-forty-inch surface area;

(v) Riser height uniform and seven and one-half inches or less, except last step leading into pool may be less than uniform height.

(b) Shallow pool entry seven and one-half inches or less in depth;

(c) Ramp entry into the pool meeting the following construction requirements:

(i) Handrail extending over the deck edge and extending to the bottom of the ramp for entering and leaving the wading pool;

(ii) Ramp edges protruding into the pool of contrasting color;

(iii) Ramp slope not to exceed one foot in seven feet.

(d) Designs permitting entry and exit for impaired or handicapped persons are encouraged.

(8) **Turnover.** Owners shall ensure pools turn over entire pool water volume in three hours or less and:

(a) Where wading pools are recirculated jointly with swimming pools, means to ensure efficient turnover and treatment are maintained;

(b) Exceptions to recirculation requirements may be made for flow-through pools in the following conditions:

(i) Where water supply is sufficient to provide the same turnover period specified for recirculation pools;

(ii) The water supply source meets the quality requirements and is subject to a disinfection method as outlined under WAC 246-260-070(3);

(iii) The introduction of fresh treated pool water is accomplished by the same type of inlet and outlet design required for recirculation pools; and

(iv) The pool water quality complies with WAC 246-260-070.

(9) **Pool depth markings.** Owners shall provide depth markings:

(a) Plainly marking the water depth in feet on the horizontal surface of the coping or deck edge;

(b) Located on the coping or deck within eighteen inches of the water edge and positioned to be read while standing on the deck facing the water;

(c) Which are slip resistant;

(d) Placed at the maximum and minimum water depths;

(e) Spaced at intervals not exceeding twenty-five feet;

(f) Uniformly arranged on both sides and ends of the pool; and

(g) With a four-inch minimum height.

(10) **Bather load.** Owners shall ensure maximum number of bathers permitted in the wading pool facility at any one time not exceed one bather per seven square feet.

(11) **Inlets.** Owners shall provide pool inlets:

(a) Submerged and located to produce uniform water and chemical circulation throughout the pool; and

(b) Located on the bottom of pools twenty-five hundred square feet or more, unless otherwise justified by the design engineer to the department's or local health officer's satisfaction.

(12) **Outlets.** Owners shall provide pool outlets with:

(a) Overflow and main drain grating systems each designed to carry one hundred percent of the total recirculation filter flow and main drain piping designed to carry fifty percent or more of total recirculation filter flow;

(b) Overflow outlets that maintain:

(i) A minimum of sixty percent of filter recirculation flow at all times; and

(ii) An overflow channel which may be used on any pool and required on pools twenty-five hundred square feet or more on the pool perimeter to promote uniform circulation and skimming action of the upper water layer with:

(A) A design preventing all matter entering the channel from returning to the pool;

(B) Dimensions minimizing the hazard for bathers, such as catching arms or feet;

(C) One one-hundredth of a foot slope per foot or more;

(D) Drains sufficiently spaced and sized to collect and remove overflow water to return line and filter, where applicable; and

(E) Size sufficient to carry one hundred percent of the recirculation flow plus the surge flow equivalent to one-fifth of the balancing tank expressed in gallons per minute.

(iii) Skimmers in lieu of pool overflow channels up to twenty-five hundred square feet if:

(A) Weir provided in skimmer has a maximum flow rate through skimmer not exceeding four gpm per inch of weir;

(B) Devices are recessed in the pool wall so no part protrudes beyond the plane of the wall into the pool;

(C) The skimmer is equipped with a device to prevent air lock in the recirculation suction line, such as, an equalizer line;

(D) The skimmer is equipped with a removable and cleanable screen designed to trap large solids;

(E) Automatically adjustable and operates freely through all designed loading rates. Displacement shall be computed at ten gallons per bather.

(c) Main drains in all pools with:

(i) Location at the pool's low points;

(ii) A minimum of two main drains spaced:

(A) Twenty feet or less apart nor closer than six feet; or

(B) As far as possible from each other in pools seven feet or less linear floor distance.

(iii) Total open area of grates sized to prevent a suction or entrapment hazard dangerous to user;

(iv) Grates on drains with:

(A) Maximum flow of one and one-half feet per second;

or

(B) Net outlet area four times or more the area of the discharge pipe.

(v) Openings not allowing a sphere over one-half inch in diameter to pass;

(vi) Grates designed to withstand forces of users;

(vii) Grates removable only with specific tool; and

(viii) Means to control flow from recirculation pump or balancing tank.

(13) **Flow.** Owners shall maintain pool recirculation flow not to exceed:

(a) Six feet per second in valved suction or discharge side of the pump; and

(b) Ten feet per second in open discharge pipes on the pressure side of the pump or filter discharge. The recircula-

tion flow limit does not apply to the return inlet and the last two feet of pipe leading to the inlet.

(14) **Balancing tanks.** Owners with overflow channels requiring balancing tanks shall:

(a) Maintain volume equivalent to seven times maximum bathing load expressed in gallons; and

(b) Increase capacity as necessary to provide volume for make-up water and to prevent air lock in the pump suction line.

(15) **Pumps.** Owners shall have and maintain wading pool recirculation pumps with adequate capacity to:

(a) Provide design flows and pressure for water recirculation over the entire operating filter pressure;

(b) Allow proper back washing of filters when specified; and

(c) Have self-priming capability when installed above pool water level.

(16) **Strainers.** Where pumps precede the filter, owners shall equip pool recirculation facilities with hair and lint strainers which shall:

(a) Be located upstream of recirculation pumps;

(b) Provide strainer screen sufficiently strong to prevent collapse when clogged;

(c) Have an openable cover; and

(d) Provide valving to isolate the strainer when located below pool water level.

(17) **Valves.** Owners shall provide valves at appropriate locations to allow isolation and maintenance of equipment.

(18) **Equipment rooms.** Owners shall provide equipment rooms:

(a) Enclosing pumps, disinfection equipment, filters and other electrical and mechanical feed equipment and associated chemicals. Chemical storage shall conform to manufacturer requirements;

(b) Providing work space and access to perform routine operations;

(c) With a forty-six-square-foot minimum floor area and provide a three-foot minimum of access area to service equipment;

(d) With one floor drain or more and a floor slope to the drain at a one-fourth-inch-per-foot minimum;

(e) Ready access if below grade;

(f) Ventilation;

(g) Twenty foot-candles or more of light measured thirty inches from the floor; and

(h) Kept locked.

(19) **Make-up water.** Owners shall ensure a source of make-up water and associated piping at the pool:

(a) Providing sufficient quantity to replace daily pool losses;

(b) Coming from a supply conforming with chapter 246-290 WAC;

(c) Preventing cross connections using a minimum air gap of two pipe diameters or approved backflow prevention devices between the make-up water source and the pool water or waste water; and

(d) If using a pool fill spout, not projecting greater than one inch into the space above the water surface area and shielded to not create a deck hazard.

(20) **Filters.** Owners shall equip pools with filtration equipment:

(a) Meeting the applicable standards of NSF or equivalent;

(b) Using acceptable type and filter rates described under Table 080.1 of this section;

(c) Having pressure or vacuum gauges for measuring loss of head through the filter with a minimum of one gauge preceding and one gauge following the filter;

(d) Having a rate of flow indicator to measure flow which has accuracy, repeatability, and durability equivalent to flow meters meeting NSF standards; and

(e) Having a means of discharging filter backwash to waste with:

(i) Discharge in a manner not creating a public nuisance;

(ii) Disposal in accordance with applicable local laws or regulations;

(iii) Minimum air gap of two pipe diameters to prevent cross-connection from waste discharge and recirculation system piping;

(iv) Discharge receptor and piping of sufficient size to accept backwash water and prevent flooding; and

(v) Ability to monitor filter effluent during backwash, that is, use of a sight glass.

(f) Providing means to release air entering the filter tank on pressure filters;

(g) When cartridge filters are used:

(i) Provide with an extra set of cartridges; and

(ii) Have any bypass valves in a permanently closed position.

(h) When using pressure DE filters with separation tanks:

(i) Provide means of air release or a lid providing a slow and safe release of pressure; and

(ii) Show a readily visible user warning that the air release must be opened before starting the circulation pump.

TABLE 130.3

TYPE AND RANGES OF FILTERS FOR WADING POOLS

Range of Acceptable Filter Rate Type of Filter Media	Expressed in gpm/Square Feet		
	Minimum	Maximum	
Sand			
Rapid Sand and Pressure Sand	—		3
Wading Pools less than 10,000 gallons			
High Rate Sand Pressure or Vacuum	10		15
Wading Pools greater than 10,000 gallons			
High Rate Sand Pressure* or Vacuum*	10		18
	Continuous Feed	Manual Feed	
D.E.			
Pressure	1.0	1.35	2.0
Vacuum	0.8	1.0	2.0
Cartridge**			0.375

## NOTE:

\*Filters sized at maximum application rate shall be equipped with flow control valves to maintain flow equilibrium to account for varying filter pressures and consequent flow production.

\*\*Cartridge filters shall have a nominal micron rating of twenty microns or less.

(21) **Disinfection equipment.** Owners shall provide disinfection equipment:

(a) Providing a continuous and effective disinfectant residual in the water;

(b) Using a disinfectant with an easily monitored residual;

(c) Having a design feed rate providing effective disinfection levels when the pool is in peak demand conditions;

(d) Having easily cleanable equipment and piping used to apply chemicals and with provisions to prevent undue clogging. All materials shall be resistant to action of chemicals used;

(e) Conforming to NSF standards if the disinfection equipment has:

(i) Adjustable output rate chemical feed equipment for liquid solutions. When using this equipment, it shall:

(A) Feed under positive pressure in the recirculation system;

(B) Provide means for dosage adjustment;

(C) Have provisions to prevent hypochlorite solution siphoning when equipment is turned off, this applies when the disinfection equipment is above pool water level.

(ii) Flow through chemical feed for solid feed material. Solid tablets or granules shall not be placed in skimmer baskets accessible to the public.

(f) Allowing hand feeding on an emergency basis only;

(g) Meeting the following conditions when using chlorine gas:

(i) Chlorine rooms shall:

(A) Be above ground level;

(B) Be constructed so all openings or partitions with adjoining rooms are sealed;

(C) Be located with consideration of prevailing winds to dissipate leaked chlorine away from the pool facility;

(D) Have door opening outward only and to the out-of-doors;

(E) Provide a sign on the door exterior reading danger chlorine. The sign shall be large enough to be read twenty-five feet away.

(ii) Chlorine rooms shall have mechanical exhausting ventilation including:

(A) Air inlet located as far as possible from fan intake to promote good air circulation patterns;

(B) Minimum of one air change per minute in the chlorine room when fan is operating;

(C) A remote switch outside the room or a door-activated switch to turn on fan before entering;

(D) Suction for fan near the floor;

(E) Exhaust for fan and chlorinator vent located to prevent contaminating air intake and prevent undue hazard for the pool facility users; and

(F) Screened chlorinator vent.

(iii) Gas chlorine systems shall:

(A) Be vacuum injection type, with vacuum-actuated cylinder regulators;

(B) Provide integral backflow and anti-siphon protection at the injector; and

(C) Provide taring (net weight of cylinder gas) scales for determining chlorine weight.

(iv) Breathing protection available in an accessible area for the operator outside of the chlorine room including:

(A) Self-contained breathing apparatus designed for use in a chlorine atmosphere for working with chlorine leaks and maintained in accordance with department of labor and industries standards; or

(B) Provisions to substitute breathing protection at the site, if procedures can be established and documented with emergency service fire districts or other approved organization within the area for promptly responding to chlorine leaks.

(v) Means for automatic shutoff when pool flow is interrupted; and

(vi) Chlorine gas cylinders shall:

(A) Be stored only in chlorine rooms;

(B) Have approved valve-stem cylinder wrench on the valve stem to shut the system down in an emergency event;

(C) Be properly secured to prevent tipping;

(D) Be tagged to indicate cylinders are empty or full; and

(E) Not exceed one hundred fifty pounds tare weight per cylinder. If one-ton cylinder use is desired, an engineer specializing in chlorine design shall prepare a design proposal for department consideration.

(22) **Chemical feeding equipment for pH control.** Owners applying chemicals for controlling pH through chemical feed equipment shall provide equipment with:

(a) Adequate size and design to allow routine cleaning and maintenance;

(b) Materials resistant to chemical action;

(c) Means for automatic shut off when pool flow is interrupted;

(d) Chemical feed equipment for pH control on pools fifty thousand gallons volume or greater;

(e) Any pool feeding with:

(i) Caustic soda (NaOH);

(ii) Carbon dioxide (CO<sub>2</sub>); or

(iii) Other chemicals the department determines necessary to require metered and controlled feeding.

(23) **Heaters.** Where pool heating equipment is provided, owners shall:

(a) Locate equipment so any standing pilot is readily accessible; and

(b) Install equipment per NEC and UMC.

(24) **Ventilation.** Owners shall provide indoor pool facility ventilation conforming with ASHRAE pool facility standards.

(25) **Testing equipment.** Owners shall use testing equipment as noted in the water quality section under WAC 246-260-070(6).

(26) **Chemical storage.** Owners shall ensure chemical storage design and placement minimizes safety risks.

(27) **Restroom and plumbing fixtures.** Owners shall provide restroom and plumbing facilities at pools as follows:

(a) Where wading pool facilities are provided in conjunction with general use and limited use swimming pools, spas, or other water recreation facilities, the wading

pool bathing load shall be added to the total load for consideration of plumbing fixture units;

(b) If a wading pool is the sole water recreation facility at a site, plumbing fixtures as described under Table 130.4 including:

- (i) Flush toilets and toilet tissue in dispensers;
- (ii) Shower facilities that:
  - (A) Deliver water at a temperature range of ninety to one hundred ten degrees Fahrenheit;
  - (B) Provide single service soap in nonglass dispensers.
- (iii) Sinks provided with:
  - (A) Tempered or hot and cold running water;
  - (B) Single service soap in nonglass dispensers; and
  - (C) Single service towels or electric hand dryers.
- (iv) Hose bibs with vacuum breakers conveniently accessible to pool and within one hundred feet; and
- (v) Sewage disposed of in a manner approved by the department or local health officer.

TABLE 130.4

PLUMBING FIXTURE MINIMUM REQUIREMENTS FOR SOLE FACILITY WADING POOLS

Wading Pools with:	Toilets	Sinks	H.B.	Showers
1. Limited use wading pools with living units* within 100 feet and less than 3 stories	-	-	1	-
2. Limited use wading pools with living units >100 feet but <500 feet and less than 3 stories.**	1	1	1	-
3. Limited use wading pools with living units >500 feet but <1/4 mile and/or with 3 or more stories.**	1(M) 1(F)	1(M) 1(F)	1	-
4. Limited use wading pools with living units >1/4 mile or general use wading pools***	1(M) 1(F)	1(M) 1(F)	1	1(M) 1(F)

NOTE:

\*\*Living Units" means all units associated with limited use facilities intended to be served.

\*\*Consideration for elevators adjacent to pool may allow variance from this requirement.

\*\*\*When wading pool bathing load exceeds 40 of either sex, the fixture units provided shall conform with the general use requirements for swimming pools.

(c) If owners limit the number of people within their facility to a certain number and post maximum occupancy loading, the number of plumbing fixture units may be based on that maximum occupancy.

(28) **Lighting.** Owners shall design and maintain pool facility lighting to:

(a) Illuminate indoor facilities, outdoor facilities used after dusk, and locker room facilities with a minimum lighting intensity maintained thirty inches above any walking surface, pool deck, or pool area of:

- (i) Thirty foot-candles at indoor facilities;
- (ii) Fifteen foot-candles at outdoor facilities;
- (iii) Twenty foot-candles in locker rooms.

(b) Allow lifeguards or attendants to clearly see pool areas and walking surfaces;

(c) Meet any additional lighting requirements deemed necessary by the department or local health officer;

(d) Provide protective shielding for all lighting fixtures above walking surfaces and pool areas;

(e) Provide all indoor facilities with one or more pool area emergency lights designed to turn on in the event of a power failure. The emergency lighting shall conform to requirements of UL standard 924.

(29) **Signs.** Owners shall provide signs at pools which must convey the following conditions, but may be conveyed by any combination of words, pictures, or symbols:

(a) Prohibition of running or horseplay;

(b) Prohibition of use by persons with communicable diseases;

(c) Prohibition of use by persons under the influence of alcohol or drugs;

(d) Prohibition of food or drink in the pool water;

(e) In pools where lifeguards or attendants are not present, post requirements for facility use as required under WAC 246-260-140(3).

(30) **Food service.** When food service is provided, owners shall:

(a) At general use pool facilities, ensure food and beverage sale and consumption areas are separated from pool and deck. Special provisions may be made for allowing food and beverage service on the walkway provided a minimum six feet clear area is maintained between the pool edge and any tables or chairs provided for special facility functions;

(b) At limited use pool facilities, prohibit food and beverage in the pool water and maintain a minimum four-foot clear area between pool edge and any tables and chairs provided for food service;

(c) Provide trash containers;

(d) Prohibit glass containers in the pool facility.

[Statutory Authority: RCW 70.90.120. 92-02-020 (Order 226B), § 246-260-130, filed 12/23/91, effective 1/23/92. Statutory Authority: RCW 43.20.050. 91-02-051 (Order 124B), recodified as § 246-260-130, filed 12/27/90, effective 1/31/91. Statutory Authority: RCW 70.90.120. 90-07-010 (Order 042), § 248-98-080, filed 3/12/90, effective 4/12/90; Regulation .98.080, effective 3/11/60.]

**WAC 246-260-140 Operation of wading pool facilities.**

(1) **Operation plan.** Owners shall ensure proper operation to protect the public health, safety, and water quality by establishing practices and developing an operations manual addressing each of the following:

- (a) Physical pool facility components;
- (b) Personnel;
- (c) Users and spectators;
- (d) Environmental conditions.

(2) **Physical components.** Owners shall provide routine checks of the physical components:

(a) Ensuring all structural facilities the users come in contact are intact and free from undue wear or fatigue and replaced as needed;

(b) Eliminating adverse effects of water ponding on walking surfaces;

(c) Ensuring preventative maintenance on equipment essential for protection of the public health, safety, and water quality;

(d) Maintaining barrier protection;

(e) Ensuring treatment turnover is continuous twenty-four hours a day during seasons or periods of use and does not exceed three hours provided:

(i) Allowances shall be made for minor equipment maintenance;

(ii) Pools previously approved with turnover rates varying from subsection (2)(e)(i) of this section may continue to operate if water quality conditions conform with WAC 246-260-070.

(3) **Required personnel.** Owners shall ensure appropriate personnel at pool facilities as follows:

(a) A water treatment operator oversees that the water treatment components are adequately functioning to protect public health, safety, and water quality; and

(b) At pool facilities with no lifeguards, assistant lifeguards, or attendants, use shall be subject to the following conditions:

(i) When the pool is used by children twelve years of age or under, a responsible adult eighteen years of age or older shall accompany the children and be at the pool or pool deck at all times the children use the facility;

(ii) When used by persons seventeen years of age or under, a minimum of two people are at the pool facility at all times the pool is in use;

(iii) At general use pools, subdivision (b)(i) and (ii) of this subsection be posted; and

(iv) At limited-use pools, subdivision (b)(i) and (ii) of this subsection be posted and ongoing provisions notifying the responsible person of the conditions.

(4) **Personnel duties and equipment.** Owners shall ensure the specific duties and equipment of designated personnel include:

(a) Lifeguards, during periods of lifeguarding, guard pool facility users in areas assigned;

(b) Assistant lifeguards when provided at the pool used under the following conditions:

(i) Assistant lifeguard limited to guarding responsibility of areas four feet or less in depth; and

(ii) A lifeguard overseeing the activities of the assistant lifeguard.

(c) Attendants when provided oversee use of the pool by the bathers and provide supervision and elementary rescues, such as reaching assists to bathers in need;

(d) Water treatment operators oversee, as needed, the water treatment components are functioning adequately to protect public health, safety, and water quality;

(e) Notification of responsible persons on the conditions for use at pool facilities not requiring lifeguards, and for which no lifeguards or attendants are present. A responsible person means a person having responsibility for overseeing users, including but limited to a person:

(i) Renting an apartment, hotel, motel, RV camp site; or

(ii) Who is an owner or member of a condominium, homeowner's association, mobile home park, or private club with a pool facility.

(f) Lifeguards, assistant lifeguards, or attendants:

(i) Wear distinguishing suit, uniform, or emblem; and

(ii) Equipped with a whistle or a signaling device.

(5) **Personnel training.** Owners shall require training for each type of personnel including:

(a) Lifeguards shall maintain a current certificate in the following:

(i) Standard first aid and adult, single rescue CPR through ARC or American Heart Association; and

(ii) Advanced lifesaving, advanced lifesaving review, or lifeguard training through ARC; or

(iii) YMCA lifeguarding or crossover course through the YMCA; or

(iv) Lifeguard through the National Lifeguard Service, Canadian; or

(v) Lifeguard through National Pool and Waterpark Lifeguard Training; or

(vi) Basic lifeguard through advanced lifeguard training international; or

(vii) Other training the department determines equivalent; and

(viii) Thirty-six months after enactment of the personnel training provisions of this chapter, the department shall no longer recognize training for lifeguards in advanced lifesaving, or advanced lifesaving review through the ARC.

(b) Assistant lifeguards shall maintain current certificates and meet the requirements in the following:

(i) Adult, single rescue CPR through ARC or American Heart Association; and

(ii) Emergency water rescue with ARC; or

(iii) Bronze medallion award through the Royal Lifesaving Society of Canada; or

(iv) Shallow water lifeguard through the National Pool and Waterpark lifeguard training; or

(v) Other training the department determines equivalent; and

(vi) Be fourteen years of age or older.

(c) Attendant shall maintain current certificates and meet the requirements in the following:

(i) Adult, single rescue CPR through ARC or the American Heart Association; and

(ii) Basic water safety with ARC; or

(iii) Other training the department determines equivalent; and

(iv) Be sixteen years of age or older.

(d) Water treatment operator shall have specific knowledge in provision of pool water chemistry, filtration, pumping equipment and rules and regulations pertaining to pool facilities;

(e) When pool facility is using chlorine gas, an operator shall have specific training as follows:

(i) Proper operation of the chlorination equipment and routine maintenance procedures;

(ii) Basic understanding of physical and chemical properties of chlorine gas under pressure;

(iii) Basic understanding on use of leak detection and emergency safety equipment;

(iv) Basic knowledge of proper first aid procedures and response for accidental inhalation of chlorine gas;

(v) Six hours or more of formal instruction once every three years or three hours or more every eighteen months with certificate of training provided.

(f) Persons shall be exempt from having current CPR or standard first aid certificates if the persons hold current certificates in any of the following:

(i) Community CPR in place of adult, single rescue CPR;

(ii) In place of standard first aid:

(A) Advanced first aid;

- (B) First responder;
- (C) Emergency medical technician; or
- (D) Paramedic.

(iii) Other training the department recognizes as equivalent or exceeding current requirements.

(6) **Bather use.** Owners shall establish conduct rules for users to ensure health and safety. The rules shall include signage noted under WAC 246-260-130(29).

(7) **Environmental conditions.** Owners shall monitor various environmental conditions affecting the facility or the user and take appropriate action in response to these factors, including electrical storms, visibility problems, etc.

(8) **Closure.** Owners shall close the facility when the facility or portion thereof presents an unhealthy, unsafe, or unsanitary condition. These conditions include lack of compliance with the water quality or operation requirements as detailed under WAC 246-260-070 and 246-260-140.

[Statutory Authority: RCW 70.90.120. 92-02-020 (Order 226B), § 246-260-140, filed 12/23/91, effective 1/23/92. Statutory Authority: RCW 43.20.050. 91-02-051 (Order 124B), recodified as § 246-260-140, filed 12/27/90, effective 1/31/91. Statutory Authority: RCW 70.90.120. 90-07-010 (Order 042), § 248-98-085, filed 3/12/90, effective 4/12/90.]

**WAC 246-260-150 Spray pool design, construction, and equipment.** (1) **Location.** Owners shall locate pools to:

(a) Minimize pollution by dust, smoke, soot, and other undesirable substances; and

(b) Eliminate pollution from surrounding surface drainage.

(2) **Materials.** Owners shall only use structure and equipment materials which are nontoxic, durable, inert, impervious to water and easily cleanable.

(3) **Walking surfaces.** Owners shall design and maintain walking surfaces:

(a) Uniformly sloping away from the pool or pools a minimum of one-fourth inch per foot and a maximum of one-half inch per foot;

(b) Of a nonslip finish not presenting a tripping hazard;

(c) Equipped with sufficient drains to prevent standing water;

(d) Of easily cleanable impervious finishes;

(e) Four feet or more in width, extending around fifty percent or more of the spray pool;

(f) In conformance with department-established guidelines for any resilient artificial surfaces.

(4) **Pool structure.** Owners shall ensure general pool requirements include:

(a) Pool surfaces with nonslip finishes and impervious to water;

(b) Uniform pool floor slopes not to exceed one foot in twelve feet;

(c) Provision for using an approved potable water supply. Water shall not be recirculated, but drain to waste after use in the spray pool; or

(d) If a spray pool facility is used in conjunction with a swimming pool over thirty thousand gallons in volume, recirculated swimming pool water may be used in the spray pool if:

(i) Means for treatment of the water draining from the spray pool is provided including filtration, disinfection, and recirculation through a separate spray pool treatment system;

(ii) Such system is sized on the maximum introduction rate of water from the recirculated swimming pool water;

(iii) Treated spray pool water is introduced into the swimming pool recirculation system;

(iv) Proper safeguards are employed to prevent interruption of proper swimming pool facility operation; and

(v) Design and construction of treatment equipment and associated facilities conform with swimming pool design requirements.

(5) **Inlets and outlets.** Owners shall provide pool inlets and outlets with:

(a) Spray nozzles not inflicting damage to users. Maximum flow through nozzles within close proximity to bathers shall not exceed fifteen fps at the nozzle;

(b) The drain located at the low point of the pool and with sufficient capacity and design to prohibit water accumulation in the pool. The outlet drain shall:

(i) Be located at the low point of the pool;

(ii) Have openings not allowing a sphere over one-half inch in diameter to pass;

(iii) Use grate design to withstand forces of users;

(iv) Have grates removable only with specific tools; and

(v) On grates attached to recirculating pumps, have:

(A) Total open area of grates sized to prevent a suction hazard dangerous to the user;

(B) Grates on drains with a maximum flow of one and one-half feet per second, or net area of outlet four times or more the discharge pipe area.

(6) **Valves.** Owners shall provide valves at appropriate locations to allow isolation and maintenance of equipment.

(7) **Make-up water.** Owners shall ensure a source of make-up water and associated pool piping:

(a) Coming from a supply conforming with chapter 246-290 WAC;

(b) Preventing cross connections using a minimum air gap of two pipe diameters or approved backflow prevention devices between the make-up water source and the spray pool water or waste water.

(8) **Waste water discharge.** Water used in a pool shall be disposed of in a manner acceptable to the local health jurisdiction.

(9) **Signs.** Owners shall provide signs at pools about general requirements for facility use. Owners may use any combination of words, pictures, or symbols conveying the prohibition of the following conditions:

(a) Running or horseplay;

(b) Use by persons with communicable diseases;

(c) Use by persons under the alcohol or drug influence;

(d) Food or drink in pool water.

[Statutory Authority: RCW 70.90.120. 92-02-020 (Order 226B), § 246-260-150, filed 12/23/91, effective 1/23/92. Statutory Authority: RCW 43.20.050. 91-02-051 (Order 124B), recodified as § 246-260-150, filed 12/27/90, effective 1/31/91. Statutory Authority: RCW 70.90.120. 90-07-010 (Order 042), § 248-98-090, filed 3/12/90, effective 4/12/90; Regulation 98.090, effective 3/11/60.]

**WAC 246-260-160 Operation of spray pool facilities.** (1) **Operation plan.** Owners shall ensure proper operation to protect the public health, safety, and water quality. An operations plan shall address each of the following:

(a) Physical pool facility components;

- (b) Personnel;
- (c) Users and spectators;
- (d) Environmental conditions.

(2) **Physical components.** Owners shall provide routine checks of the physical components:

(a) Ensuring all structural facilities which the users come in contact are intact and free from undue wear or fatigue and replace as needed;

(b) Eliminating adverse effects of water ponding on walking surfaces;

(c) Ensuring preventative maintenance on equipment essential for protection of the public health, safety, and water quality.

(3) **Required personnel and duties.** Owners shall provide personnel to oversee the spray pool facility ensuring proper operation and maintenance. When the facility is using recirculated water, a water treatment operator shall oversee water quality and equipment operation.

(4) **Bather use.** Owners shall establish rules of conduct for users to ensure health and safety. The rules shall include conditions noted under WAC 246-260-150(9).

(5) **Environmental conditions.** Owners shall monitor various environmental conditions affecting the facility or the user and take appropriate action in response to these factors, including electrical storms, visibility problems, etc.

(6) **Closure.** Owners shall close the facility when the facility or portion thereof presents an unhealthy, unsafe, or unsanitary condition. The conditions include lack of compliance with the water quality and/or operation requirements as detailed under WAC 246-260-070 and 246-260-160.

[Statutory Authority: RCW 70.90.120. 92-02-020 (Order 226B), § 246-260-160, filed 12/23/91, effective 1/23/92. Statutory Authority: RCW 43.20.050. 91-02-051 (Order 124B), recodified as § 246-260-160, filed 12/27/90, effective 1/31/91. Statutory Authority: RCW 70.90.120. 90-07-010 (Order 042), § 248-98-095, filed 3/12/90, effective 4/12/90.]

**WAC 246-260-170 Water recreation facility pools not in operation.** Owners of pool facilities not in operation shall maintain one of the following conditions:

(1) Inoperable spa, swimming, and wading pool access shall be locked; and

(2) If pools are abandoned, backfilled with appropriate fill material.

[Statutory Authority: RCW 43.20.050. 91-02-051 (Order 124B), recodified as § 246-260-170, filed 12/27/90, effective 1/31/91. Statutory Authority: RCW 70.90.120. 90-07-010 (Order 042), § 248-98-098, filed 3/12/90, effective 4/12/90.]

**WAC 246-260-180 Bathing beaches.** No bathing beach shall be maintained or operated when such water is determined by the health officer to be so polluted or subject to pollution as to constitute a menace to health if used for bathing. Where bathhouse and toilet facilities are provided for use of bathers they shall be constructed, maintained and operated in a sanitary manner approved by the health officer.

[Statutory Authority: RCW 43.20.050. 91-02-051 (Order 124B), recodified as § 246-260-180, filed 12/27/90, effective 1/31/91; Regulation .98.070, effective 3/11/60.]

**WAC 246-260-200 Water recreation industry requirements.** All owners of companies selling swimming

pools, spa pools, wading pools or spray pools, and their associated facilities regulated by chapter 246-260 WAC shall furnish each purchaser a complete set of operating instructions and shall include detailed information on the safe use of the facilities including:

(1) Proper treatment methods to ensure water quality and sanitation;

(2) Proper safety procedures to reduce injury risks;

(3) Specific safety instructions for use at facilities having water temperatures ninety-five degrees Fahrenheit or more on the health effects of hot water and a specific caution and explanation on the health effects of hot water on pregnant women and young children.

[Statutory Authority: RCW 70.90.120. 92-02-020 (Order 226B), § 246-260-200, filed 12/23/91, effective 1/23/92. Statutory Authority: RCW 43.20.050. 91-02-051 (Order 124B), recodified as § 246-260-200, filed 12/27/90, effective 1/31/91. Statutory Authority: RCW 70.90.120. 90-07-010 (Order 042), § 248-98-100, filed 3/12/90, effective 4/12/90; Regulation .98.100, effective 3/11/60.]

**WAC 246-260-210 Technical advisory committee.**

(1) The department shall appoint a technical advisory committee to assist in the following:

(a) Reviewing and drafting of proposed rules;

(b) Development of guidelines for use of new products, equipment, procedures, and periodic program review.

(2) The technical advisory committee shall have meetings whenever the department determines necessary.

(3) The technical advisory committee water recreation pool facility membership shall include representation from the following:

(a) General use pool facility;

(b) Limited use pool facility;

(c) Local representative from the spa and pool industry (NSPI);

(d) Washington recreation and parks association representative;

(e) Engineer or architect design consultant;

(f) Eastern and western Washington local environmental health authority representatives;

(g) Department representative;

(h) RWCF owner representative, as appropriate, as described under chapter 246-262 WAC.

(4) The technical advisory committee may appoint subcommittees as the committee determines appropriate to address specific issues.

(5) The department shall maintain minutes of meetings.

[Statutory Authority: RCW 70.90.120. 92-02-020 (Order 226B), § 246-260-210, filed 12/23/91, effective 1/23/92. Statutory Authority: RCW 43.20.050. 91-02-051 (Order 124B), recodified as § 246-260-210, filed 12/27/90, effective 1/31/91. Statutory Authority: RCW 70.90.120. 90-07-010 (Order 042), § 248-98-102, filed 3/12/90, effective 4/12/90.]

**WAC 246-260-220 Restrictions on animals.** Owners shall prevent animal access to the water recreation pool facility except by users or spectators requiring services of guide dogs accompanying them to the deck area.

[Statutory Authority: RCW 43.20.050. 91-02-051 (Order 124B), recodified as § 246-260-220, filed 12/27/90, effective 1/31/91. Statutory Authority: RCW 70.90.120. 90-07-010 (Order 042), § 248-98-104, filed 3/12/90, effective 4/12/90.]



**WAC 246-260-230 Variance.** (1) The department or local health officer may allow variance from this chapter or portions thereof provided:

(a) The local health officer receives written department concurrence;

(b) The department receives written local health officer concurrence in jurisdictions with active water recreation facilities programs;

(c) Data and/or research provides sufficient evidence to the satisfaction of the department or local health officer the water recreation facility, or considered components, adequately protects public health and safety, as well as water quality;

(d) The variance is consistent with the intent of this chapter.

(2) The department and local health officer shall provide the board an annual summary of variances granted January 31 of the following year or at the board's request at any time. The board may evaluate such variances granted to determine if the provisions of this chapter are met.

(3) The board may, in its discretion, make provisions to submit variance requests to the board for review and decision.

[Statutory Authority: RCW 43.20.050, 91-02-051 (Order 124B), recodified as § 246-260-230, filed 12/27/90, effective 1/31/91. Statutory Authority: RCW 70.90.120, 90-07-010 (Order 042), § 248-98-110, filed 3/12/90, effective 4/12/90; Order 715, § 248-98-110, filed 9/14/72.]

**WAC 246-260-240 Substitution.** The board authorizes the department to allow substitutions of equipment, facilities, or procedures required by chapter 246-260 WAC when, in the sole determination of the department, data and/or research provide sufficient evidence that such substitution is equivalent to the requirement and will adequately provide for the protection of the public health and safety of persons using the water recreation facility.

[Statutory Authority: RCW 70.90.120, 92-02-020 (Order 226B), § 246-260-240, filed 12/23/91, effective 1/23/92. Statutory Authority: RCW 43.20.050, 91-02-051 (Order 124B), recodified as § 246-260-240, filed 12/27/90, effective 1/31/91. Statutory Authority: RCW 70.90.120, 90-07-010 (Order 042), § 248-98-120, filed 3/12/90, effective 4/12/90; Order 715, § 248-98-120, filed 9/14/72.]

**WAC 246-260-250 Enforcement.** (1) The department or, if enforcement responsibility is assigned under a joint plan of operation in WAC 246-260-020, the local health officer:

(a) Shall enforce chapter 246-260 WAC rules; or

(b) May refer cases within the department's or local health officer's jurisdiction to the local prosecutor's office or the office of the attorney general, as appropriate.

(2) When a water recreation facility (WRF) is in violation of chapter 70.90 RCW provisions or chapter 246-260 WAC rules, appropriate enforcement action may be initiated by the department, local health officer, local prosecutor's office, or office of the attorney general. Enforcement actions may include any one or a combination of the following:

(a) Informal administrative conferences to explore facts and resolve problems, convened at the request of the department, local health officer, or owner;

(b) Orders directed to the water recreation facility (WRF) owner and/or operator and/or the person causing or responsible for the violation of the chapter 246-260 WAC rules;

(c) Imposition of civil penalties of up to five hundred dollars per violation per day as authorized under RCW 70.90.200;

(d) Denial, suspension, or revocation of operating permits; and

(e) Civil or criminal action initiated by the local prosecutor's office or by the office of the attorney general.

(3) Orders authorized under this section include, but are not limited to the following:

(a) Requiring corrective measures necessary to effect compliance with chapters 246-260 WAC or 70.90 RCW. Such orders may or may not include a compliance schedule; and

(b) Orders to stop work and/or refrain from using any WRF or portion thereof or improvement thereto until all permits, certifications, and approvals required by statute or rule are obtained.

(4) An order issued under this section shall:

(a) Be in writing;

(b) Name the facility and the person or persons to whom the order is directed;

(c) Briefly describe each action or inaction constituting a violation of chapters 70.90 RCW or 246-260 WAC rules;

(d) Specify any required corrective action, if applicable;

(e) Provide notice, as appropriate, that continued or repeated violation may subject the violator to:

(i) Civil penalties of up to five hundred dollars;

(ii) Denial, suspension, or revocation of the facility's operating permit; or

(iii) Referral to the county prosecutor or attorney general's office.

(f) Provide the name, business address, and phone number of an appropriate staff person who may be contacted regarding an order.

(5) Service of an order shall be made:

(a) Personally, unless otherwise provided by law; or

(b) By certified mail return receipt requested.

(6) Under department or local health officer adopted rules or policies, civil penalties of up to five hundred dollars per day may be assessed against any person violating provisions of chapter 70.90 RCW or 246-260 WAC.

(7) The department or local health officer shall have cause to deny the operating permit application or reapplication or to revoke or suspend a required operating permit of any person who has:

(a) Previously had:

(i) An operating permit suspended or revoked; or

(ii) An operating permit application denied for reason.

(b) Failed or refused to comply with provisions of chapters 70.90 RCW and 246-260 WAC or any other statutory provision or rule regulating the WRF construction or operation; or

(c) Obtained or attempted to obtain an operating permit or any other required certificate or approval by fraudulent means or misrepresentation.

(8) For the purposes of subsection (7) of this section, a person shall be defined to include:

(a) Applicant;

- (b) Reapplicant;
- (c) Permit holder; or
- (d) An individual associated with subsection (8)(a), (b), or (c) of this section including, but not limited to:
  - (i) Board members;
  - (ii) Officers;
  - (iii) Managers;
  - (iv) Partners;
  - (v) Association members;
  - (vi) Agents; and
  - (vii) In addition, third persons acting with the knowledge of such persons.

(9) The department or local health officer may summarily suspend an operating permit, other required permit, license, or certification without a prior hearing if the department or local health officer:

- (a) Finds public health, safety, or welfare imperatively requires emergency action; and
- (b) Incorporates a finding to that effect in its notice or order.

[Statutory Authority: RCW 70.90.120. 92-02-020 (Order 226B), § 246-260-250, filed 12/23/91, effective 1/23/92. Statutory Authority: RCW 43.20.050. 91-02-051 (Order 124B), recodified as § 246-260-250, filed 12/27/90, effective 1/31/91. Statutory Authority: RCW 70.90.120. 90-07-010 (Order 042), § 248-98-130, filed 3/12/90, effective 4/12/90.]

**WAC 246-260-260 Hearings.** (1) A person aggrieved by the department's or local health officer's denial, suspension, or revocation of any permit may request an administrative hearing.

(a) A hearing requested to contest a local health officer's action shall be governed by the local health jurisdiction's rules for hearings.

(b) A hearing requested to contest the department's action shall be governed by section 377, chapter 3, Laws of 1991. The applicant's and permit holder's right to an adjudicative proceeding is in the same law.

(c) The procedure for the adjudicative proceeding is in this chapter and in chapter 246-08 WAC.

(2) Any person aggrieved by the department's or local health officer's application of civil penalties may request an administrative hearing.

(a) A hearing requested to contest a local health officer's action shall be governed by the local health jurisdiction's rules for hearings.

(b) A hearing requested to contest the department's action shall be governed by section 377, chapter 3, Laws of 1991. When the department imposes a civil fine, the right of a person to an adjudicative proceeding is in the same law.

(c) The procedure for the adjudicative proceeding is in this chapter and in chapter 246-08 WAC.

[Statutory Authority: RCW 70.90.120. 92-02-020 (Order 226B), § 246-260-260, filed 12/23/91, effective 1/23/92. Statutory Authority: RCW 43.20.050. 91-02-051 (Order 124B), recodified as § 246-260-260, filed 12/27/90, effective 1/31/91. Statutory Authority: RCW 70.90.120. 90-07-010 (Order 042), § 248-98-135, filed 3/12/90, effective 4/12/90.]

**WAC 246-260-9901 Fees.** (1) CONSTRUCTION PERMIT FEES. The department establishes the fees listed in Table 990.1 for construction permits for carrying out its duties under WAC 246-260-030.

**TABLE 990.1  
CONSTRUCTION PERMIT FEES**

TYPE OF FACILITY	CONSTRUCTION PERMIT PLAN REVIEW FEES
I. Swimming Pools	
(a) 125,000 gallons or more in volume	\$535.00
(b) Greater than 75,000 gallons and less than 125,000 gallons	\$320.00
(c) Greater than 40,000 gallons and less than 75,000 gallons	\$210.00
(d) Less than 40,000 gallons	\$160.00
II. Spa Pools	\$160.00
III. Wading Pools	\$105.00
IV. Spray Pools	\$ 80.00
V. Alterations, renovations, or modifications to existing swimming, spa, wading or spray pools, not to exceed two-thirds of new construction permit fees, or \$65/hour (which ever is less).	
VI. The fees for multiple pools at the same location will be based upon the highest fee for one facility and two thirds of the fee for each additional facility. For example: The fee for a 100,000 gallon swimming pool, a 60,000 gallon swimming pool, and a spa pool will be: \$320 + \$140 + \$107 = \$576. The fees for a small 30,000 gallon swimming pool and a spa pool will be \$160 + \$107 = \$267.	

(2) OPERATING PERMIT FEES The department establishes the fees listed in Table 990.2 for operating permits for carry[ing] out its duties under WAC 246-260-040.

**TABLE 990.2**  
**FEE SCHEDULE**  
**OPERATING PERMITS**  
**Type + Number of Facilities**

	Single Swim Pool	Single Spa Pool	Single Wading Pool	Spray Pool or Pools	Each Additional Swim, Spa, or Wading Pool
Operating Permit 0-6 month	\$275.00	\$240.00	\$200.00	\$100.00	\$60.00
Operating Permit 6-12 months	\$450.00	\$400.00	\$350.00	\$150.00	\$80.00

**Other Terms and Conditions:**

- (1) The department may charge an additional fee of \$85 plus associated laboratory costs for any inspections beyond those provided under the annual operating

permit when necessary due to violations of such items as (a) noncompliance with water quality standards, and (b) failure to comply with operational requirements for health and safety.

- (2) The department may charge an alternate annual fee for an operating permit based on direct and indirect costs associated with issuance of the permit when arrangements are made with local health jurisdictions to administer all or portions of the duties associated with the operating permit. Except, that the fee for this operating permit cannot exceed the cost established by the previous portions of this regulation, but the fee may be less.
- (3) During the first year of development of the operating permit and for new pool facilities built hereafter, or pools temporarily closed (significant period of several months) and reopened, there are provisions for prorating the costs for the operating permits.
- (4) A reduction in fees, up to but not exceeding thirty percent, may be granted by the department when a facility operator can demonstrate a satisfactory level of training in pool safety, water quality, maintenance and operations. The department will develop criteria for such fee reductions within six months of the adoption of this regulation.
- (5) For limited use facilities requiring operating permits which are serving less than fifteen living units, the operating permit shall be fifty percent of the fee. However, reinspection fees when necessary, will be charged as noted in condition (1).
- (6) Fees for multiple facilities at the same physical location shall have a maximum **FEE CAP** as follows: **Seasonal (0-6 months) WRF's: \$750 NOTE:** The third and subsequent pool/spa at the same location will be charged \$50 for each such additional pool/spa.  
**Year around (>6 months) WRF's \$1000 NOTE:** The third and subsequent pool/spa at the same physical location will be charged \$65 for each such additional pool/spa.

**Examples of Fees Charged:**

- (1) If more than one pool at a facility and one is a year-round pool and another is a seasonal pool — year-round pool is base cost, seasonal pool is charged at additional fee charge. For example: year-round spa = \$400 plus seasonal swimming pool is \$60 = \$460 total operating permits.
- (2) If a single swimming pool and a single spa pool is used at the facility, the fee schedule will include fees as noted. For a 0-6 month permit, the primary fee for the single swimming would be \$275 and the spa pool would be viewed as the second pool at the facility and would have a fee of \$60, total operating permit fees would be \$335.
- (3) If there are 12 pools/spas at a single year-around pool facility, the **FEE CAP** would apply and the maximum fee of \$1000 would be charged. (\$450 base fee; \$80 for first additional pool/spa, \$65 for the remaining ten year-around pools/spas (10 x \$65 = \$650) Total fee before fee cap = \$550 + \$80 + \$650 = \$1280. After **FEE CAP** the total fee=\$1000. If approved training were credited to this facility for the maximum 30% discount, the 30% would be applied to the **FEE CAP** fee of \$1000; \$1000 - 30% = \$700.

[Statutory Authority: RCW 70.90.150 and 43.20B.020. 94-11-056, § 246-260-9901, filed 5/11/94, effective 6/11/94.]

**WAC 246-260-998 Severability.** If any provision of this chapter or its application to any person or circumstances is held invalid, the remainder of this chapter or the application of the provision to other persons or circumstances shall not be affected.

[Statutory Authority: RCW 43.20.050. 91-02-051 (Order 124B), recodified as § 246-260-998, filed 12/27/90, effective 1/31/91. Statutory Authority: RCW 70.90.120. 90-07-010 (Order 042), § 248-98-998, filed 3/12/90, effective 4/12/90.]

**Chapter 246-262 WAC****RECREATIONAL WATER CONTACT FACILITIES****WAC**

246-262-001	Purpose and authority.
246-262-010	Definitions.
246-262-020	General administration.
246-262-030	Construction permit.
246-262-040	Operating permit.
246-262-050	Water quality standards, analysis, and sample collection.
246-262-060	General design, construction, and equipment.
246-262-070	Specific design, construction, and equipment.
246-262-080	Operation.
246-262-090	Monitoring, reporting, and record keeping.

246-262-100	Inspection.
246-262-110	Advisory committee.
246-262-120	Enforcement.
246-262-130	Notice of decision—Adjudicative proceeding.
246-262-140	Insurance.
246-262-150	Compliance.
246-262-160	Variance.
246-262-170	Innovations—Substitutions.
246-262-990	Fees.

**WAC 246-262-001 Purpose and authority.** The purpose of these rules is to protect the health, safety, and welfare of users of recreational water contact facilities (RWCFs). The rules as set forth are adopted per RCW 70.90.120.

[Statutory Authority: RCW 43.20.050, 91-02-051 (Order 124B), recodified as § 246-262-001, filed 12/27/90, effective 1/31/91. Statutory Authority: RCW 70.90.120, 88-13-125 (Order 311), § 248-97-010, filed 6/22/88.]

**WAC 246-262-010 Definitions.** (1) "Advanced first aid" means a course of instruction recognized by the American Red Cross, department of labor and industries, the U.S. Bureau of Mines, or fire services training program.

(2) "ANSI" means American National Standards Institute.

(3) "Approved" means the department or local health officer has stated in writing that the design plans and specifications are in accordance with chapter 246-262 WAC.

(4) "ARC" means American Red Cross.

(5) "Architect" means a registered architect currently licensed under chapter 18.08 RCW in Washington state.

(6) "ASTM" means American Society for Testing Material.

(7) "Attendant" means a person trained to operate an attraction and control the users in a safe orderly manner.

(8) "Attraction or ride" means any of the specific types of recreational facilities involving partial or total immersion or intentional contact with the water designated for public recreational use.

(9) "Biomechanics" means the study of the human body as a system operating under the laws of Newtonian mechanics and the biological laws of life.

(10) "Board" means the state board of health.

(11) "Boogie or mini-surf board" means any semirigid device used in a wave pool for flotation or as a riding device.

(12) "Centerline" means the path defined by geometric midpoints of a component or structure, generally used in consideration of the slide path in flume rides.

(13) "Communication system" means any combination of devices permitting the passage of or exchange of messages between park operating personnel and between operating personnel and users. Systems can include, but are not limited to, two-way radios, hardwired intercoms, horns, whistles, hand signals, direct voice, signs, or equivalent.

(14) "Contaminant" means any physical, chemical or biological substance present in the RWCF water which may adversely affect the health or safety of the user and/or the quality of the water.

(15) "CNCA" means Council for National Cooperation in Aquatics.

(16) "Cross-connection" means any physical arrangement connecting:

(a) A potable water system directly or indirectly, with anything other than another potable water system; or

(b) A RWCF to any potable or nonpotable water source capable of contaminating either the RWCF or potable water source as a result of backflow.

(17) "Department" means the department of health.

(18) "Discharge section" means the component or components making up the exit of the water slide, water tube, inner tube ride, speed slide, ramp slide, drop slide or drop tube, or kiddie flume. These components are the elements controlling the final direction and speed of the user.

(19) "Diving envelope" means the minimum dimensions of an area within the pool necessary to provide entry from a diving board, platform, or attraction segment where users enter above pool water level.

(20) "Drop slide or drop tube ride" means a sloped trough, chute, or tube exiting the user above the pool operating water level.

(21) "Engineer" means a registered professional engineer currently licensed under chapter 18.43 RCW in Washington state.

(22) "Entry access points" means the areas where users enter an attraction.

(23) "Entry rate" means the frequency at which users are permitted access to the attraction.

(24) "Ergonomics" means a multidisciplinary activity dealing with the interactions between humans and their environment plus the traditional environmental elements atmosphere, heat, light, and sound, as well as objects with which the user comes in contact.

(25) "FINA" means Federation Internationale de Natation Amateur.

(26) "Flume or tube entry" means the area at which users enter a water slide, water tube, inner tube ride, speed slide, drop slide, drop tube, or kiddie flume.

(27) "fps" means feet per second.

(28) "gpm" means gallons per minute.

(29) "IAAPA" means International Association of Amusement Parks and Attractions.

(30) "Injury or illness report" means the written record of all facts regarding an injury or illness associated with the RWCF.

(31) "Inner tube ride" means an attraction where users ride inner tube-like devices through a series of chutes, channels, flumes, and pools.

(32) "Innovative recreational water contact facility" means any type of RWCF currently unregulated.

(33) "Intermediate pool" means any pool between the entry and exit pools in attractions using a series of pools.

(34) "Kiddie flume or tube attraction" means a flume, chute, or tube designated for and restricted to use by small children.

(35) "Lifeguard" means an individual currently certified by red cross in advanced lifesaving or lifeguard training, or YMCA senior lifesaver, or equivalent certification through the royal Canadian lifeguard services.

(36) "Lifeguard station" means the designated work station of the lifeguard.

(37) "Local health officer" means the health officer of the city, county, or city-county department or district or a representative authorized by the local health officer.

(38) "mg/l" means milligrams per liter.

(39) "Multi-activity pool" means a pool with more than one type of attraction (i.e., an adult activity pool with a series of tubes, chutes, cable rides, etc., intended for use by individuals with specific swimming abilities).

(40) "NSF" means National Sanitation Foundation.

(41) "NSPI" means National Spa and Pool Institute.

(42) "Operating levels" means water levels maintained within attractions during use for proper operation of facility and for controlling safety and sanitation.

(43) "Operations" means all aspects of a RWCF which must be controlled to make the facility safe, healthy, and usable for the purpose intended.

(44) "Owner" means a person owning and responsible for a RWCF or authorized agent.

(45) "Person" means an individual, firm, partnership, co-partnership, corporation, company, association, club, government entity, or organization of any kind.

(46) "Ponding" means a condition where water fails to drain from walking surfaces.

(47) "ppm" means parts per million.

(48) "Primary zone of visual coverage" means the area assigned to a lifeguard or attendant for primary visual surveillance of user activity.

(49) "Radius of curvature" means the radius arc which denotes the curved surface from the point of departure from the vertical sidewall (springline) of the pool to the pool bottom.

(50) "Ramp slide" means a slide allowing one or more users to slide in unison down a straight incline to a runout or a receiving pool.

(51) "Recirculation filter water" means water which is recirculated by the RWCF for treatment purposes, i.e., filtration and disinfection.

(52) "Response time" means elapsed time between bather distress and initiation of rescue assistance by a lifeguard (or attendant where applicable).

(53) "RWCF" means recreational water contact facility which is an artificial water associated facility with design and operational features that provide patron recreational activity which is different from that associated with a conventional swimming pool and purposefully involves immersion of the body partially or totally in the water and includes, but is not limited to, water slides, wave pools, and water lagoons.

(54) "Secretary" means the secretary of the department of health.

(55) "Serious injury" means any injury requiring admission to a hospital.

(56) "Speed slide or speed tube" means a sloped trough, flume, tube, or roller track having long straight and/or steep drops where users sustain speeds of twenty miles per hour or more.

(57) "Springline" means the point from which the pool wall breaks from vertical and begins its arc in the radius of curvature (for coved construction) to the bottom of the pool.

(58) "Surfboard" means a rigid device used in a wave pool for riding.

(59) "Tail coverage" means providing insurance coverage for a given period of time for discovery of claims made after the policy term for "claims made" type of insurance.

(60) "Total turnover" means the time it takes for the pool attraction water volume to be recirculated as a sum of

the flows from treatment turnover and attraction recirculation systems turnover.

(61) "Treatment turnover" means the minimum time necessary to circulate the entire attraction water volume through the recirculation filter system.

(62) "T.U." means turbidity unit as measured by the nephelometric method.

(63) "Wading activity pool" means a pool or area less than twenty-four inches in total water depth with activities intended for younger children.

(64) "Walking surface" means any direct access surface to the attractions or change rooms where the user will be in bare feet. Areas set aside for picnicking, sunbathing, and lounging are excluded.

(65) "Water slide or water tube" means a sloped trough-like flume or tube structure of varying slope and direction using water as a lubricant and/or method of regulating the rider speed.

(66) "Water treatment operator" means the person appointed to operate the mechanical equipment and perform related water quality monitoring for proper operation of the physical facility.

(67) "Wave pool" means a recreational pool producing waves which usually begin at the deep end and proceed toward and dissipate at the shallow end.

(68) "WWA" means World Waterpark Association.

[Statutory Authority: RCW 70.90.120. 92-02-020 (Order 226B), § 246-262-010, filed 12/23/91, effective 1/23/92. Statutory Authority: RCW 43.20.050. 91-02-051 (Order 124B), recodified as § 246-262-010, filed 12/27/90, effective 1/31/91. Statutory Authority: RCW 70.90.120. 88-13-125 (Order 311), § 248-97-020, filed 6/22/88.]

**WAC 246-262-020 General administration.** (1) The department and the local health officer for each local health jurisdiction containing a RWCF shall develop a joint plan of operation listing the roles of each agency for administering these rules. The plan shall designate who will be responsible for:

- (a) Plan review;
- (b) Permit issuance;
- (c) Inspection;
- (d) Surveillance; and
- (e) Enforcement.

(2) The department shall have information on which agency to contact for obtaining construction and operation permits.

(3) Fees may be charged as authorized in RCW 70.90.150.

[Statutory Authority: RCW 43.20.050. 91-02-051 (Order 124B), recodified as § 246-262-020, filed 12/27/90, effective 1/31/91. Statutory Authority: RCW 70.90.120. 88-13-125 (Order 311), § 248-97-030, filed 6/22/88.]

**WAC 246-262-030 Construction permit.** (1) Persons planning to construct, alter, or modify a RWCF, excluding routine maintenance, shall provide the following to the department or local health officer for review and approval:

- (a) A completed construction permit application;
- (b) Three sets of plans and specifications prepared and signed by an engineer or architect; and
- (c) A report prepared by an engineer certifying the design of the RWCF is consistent with accepted safety engineering practices and industrial standards. Such engineer

shall have experience in safety design, including ergonomic aspects of biomechanics of RWCFs, amusement rides, or equal.

(2) Owners may schedule a predesign meeting with the designer and the department or local health officer to determine if the project is consistent with the intent of these rules;

(3) Following review of the completed permit application and plans and specifications, the department or local health officer shall:

(a) Forward written approval, including construction permit, or denial to the owner;

(b) Forward a copy of approved plans to the designer; and

(c) Forward a copy of the approval letter to the department or local health officer and local building department.

(4) The owner shall ensure any construction, modification, or alteration is completed according to approved plans and specifications;

(5) Upon completion of RWCF construction, alteration, or modification and prior to use, owners shall:

(a) Submit to the department or local health officer a construction report signed by an engineer or architect certifying that construction is substantially in compliance with approved plans and specifications; and

(b) Notify the department or local health officer at least five working days prior to intended use of the facility.

(6) Owners of the RWCF must comply with all other applicable agency codes and standards. These include, but are not limited to:

(a) The National Electrical Code, chapter 19.28 RCW and chapter 296-46 WAC as determined by the electrical section of the Washington state department of labor and industries;

(b) Local gas piping and appliance codes, American Gas Association standards, and certification meeting the latest ANSI Z21.56 or other applicable and equivalent standards;

(c) Local building authority standards, including structural design of components;

(d) State and local plumbing authority standards;

(e) Washington state department of labor and industries requirements for pressure vessels under chapter 70.79 RCW and chapter 296-104 WAC; and

(f) Codes designated under chapter 70.92 RCW for handicapped accessibility.

[Statutory Authority: RCW 43.20.050, 91-02-051 (Order 124B), recodified as § 246-262-030, filed 12/27/90, effective 1/31/91. Statutory Authority: RCW 70.90.120, 88-13-125 (Order 311), § 248-97-040, filed 6/22/88.]

**WAC 246-262-040 Operating permit.** (1) No person shall operate a RWCF without a current operating permit issued by the department or local health officer.

(2) To obtain an operating permit, owners of an RWCF must provide information to the department or local health officer that shows the RWCF is in compliance with these rules.

(3) Operating permits shall be:

(a) Valid for one year;

(b) Renewed annually; and

(c) Nontransferable without written consent of the department or local health officer. For purposes of this

section, a change in management of a corporation, partnership, association, or other nonindividual business entity shall create a new person requiring either consent to a permit transfer or issuance of a new permit upon proper application.

(4) The department or local health officer issuing the operating permit may revoke or suspend the permit if the RWCF is not operated in accordance with chapter 70.90 RCW or chapter 246-262 WAC.

[Statutory Authority: RCW 70.90.120, 92-02-020 (Order 226B), § 246-262-040, filed 12/23/91, effective 1/23/92. Statutory Authority: RCW 43.20.050, 91-02-051 (Order 124B), recodified as § 246-262-040, filed 12/27/90, effective 1/31/91. Statutory Authority: RCW 70.90.120, 88-13-125 (Order 311), § 248-97-050, filed 6/22/88.]

**WAC 246-262-050 Water quality standards, analysis, and sample collection.** (1) Owners shall maintain waters free from harmful levels of disease-producing organisms, toxic chemicals, or adverse physical conditions.

(2) Owners shall maintain RWCF waters to meet standards of bacteriological quality. Standards include:

(a) Heterotrophic plate counts not to exceed a density of two hundred bacteria per milliliter in any series of tests; and

(b) Total coliform density not to exceed an average of one coliform bacteria per one hundred milliliters in any series of tests.

(3) Owners shall maintain continuous and effective methods of disinfection of RWCF waters at all times with use of:

(a) Chlorine or bromine as described in Table 1 of this section; and/or

(b) Alternate forms of disinfection which meet the following criteria:

(i) Registered with the environmental protection agency, if necessary;

(ii) Registered with the Washington state department of agriculture, if necessary;

(iii) Conformance with NSF standard 50 or equal when applicable; and

(iv) Adherence to guidelines established by the department.

(4) Owners shall maintain:

(a) Physical and chemical conditions within the ranges specified in Table 2 of this section; and

(b) Cleanliness by:

(i) Closing an affected area of the RWCF or affected portion when contaminated with feces, vomit, sewage, or other hazardous or unknown material until the area is clean, disinfected, and free of the hazardous material;

(ii) Daily removal of scum or floating material on the pool water surface; and

(iii) Continuous removal of scum or floating material by action of overflow of pool water with flotsom screened and filtered.

(5) Persons collecting water samples for laboratory analysis shall:

(a) Collect and transport samples for chemicals and micro-organisms based on the most recently published edition of standard methods for the examination of water and waste/water analysis published jointly by the American Public Health Association/Water Pollution Control Federation and American Waterworks Association; hereafter, it is referred to as "standard methods;"

(b) Have laboratory tests performed per "standard methods" at laboratories approved by the department to provide such analyses;

(c) Provide adequate data for completing analyses; and

(d) Use water sample bottles approved by the department for collection of samples.

(6) Persons shall use field test kits with a suitable range of accuracy for the parameters routinely measured as noted in Table 3 of this section.

(7) Owners shall require and ensure addition of chemicals or materials to RWCF water only when the use has been approved or recognized as acceptable by the department. Current lists of approved or acceptable materials are available from the department.

(8) Owners shall perform additional tests as directed by the department or local health officer.

TABLE 1  
MINIMUM AND MAXIMUM LEVELS OF DISINFECTANTS

Currently Recognized Disinfectants	Type of Residual Measured	pH Ranges			Maximum Residual Level in mg/l*
		7.2-7.49	7.5-7.79	7.8-8.0	
1. Chlorine	Free available chlorine	1.0	1.4	1.8	8
2. Chlorinated cyanurate	Free available chlorine	1.5	2.0	2.8	8
3. Bromine	Total available bromine	2.0	2.5	3.5	8

Note:

\*Maximum residual or manufacturer's recommendation (whichever is less).

TABLE 2  
ACCEPTABLE RANGES OF SELECTED  
PHYSICAL AND CHEMICAL WATER QUALITY CONSTITUENTS

Chemical or Physical Constituent	Minimum	Maximum
1. pH	7.2	8.0
2. Water Clarity (safety)	main drain visible at all times	—
3. Turbidity (shielding micro-organisms from disinfection)	—	0.5* T.U.
4. Cyanuric acid or its derivatives (if used)	0	90 mg/l
5. Temperature		104°F.

Note:

\*In peak use periods, turbidity may increase to 1.0 T.U. provided it returns to 0.5 T.U. within a six-hour period after peak use. Turbidity is not a required routine analysis which must be performed by the RWCF. Turbidity monitoring may be required by the department or local health officer if special conditions warrant it.

TABLE 3  
RANGE OF ACCEPTABLE TESTING LEVELS\*

Chemical Test	Minimum Range	Minimum Accuracy
1. Free available chlorine	0.3 to 3.0 mg/l	0.2 mg/l
2. Total chlorine	0.3 to 3.0 mg/l	0.2 mg/l
3. Total bromine	0.3 to 3.0 mg/l	0.2 mg/l
4. pH	7.0 to 8.2	0.2
5. Cyanuric acid	0 to 100 mg/l	5 mg/l
6. Alkalinity	0 to 300 mg/l	15 mg/l

Note:

\*Do not make determinations of chemical conditions based on readings at the extreme measurable limits of the scale.

[Statutory Authority: RCW 43.20.050. 91-02-051 (Order 124B), recodified as § 246-262-050, filed 12/27/90, effective 1/31/91. Statutory Authority: RCW 70.90.120. 88-13-125 (Order 311), § 248-97-060, filed 6/22/88.]

**WAC 246-262-060 General design, construction, and equipment.** (1) Owners shall locate RWCFs to:

(a) Minimize pollution by dust, smoke, soot, and other undesirable substances;

(b) Eliminate pollution from surrounding surface drainage; and

(c) Ensure pools within the RWCF are more than fifteen feet from any structure, object, or land formation (i.e., pumphouse, tree, etc.), which would provide a user with the opportunity to jump from such a structure into the pool. This does not include any barriers provided to prevent unauthorized access to pool or segments of attractions which enter pool.

(2) Owners shall use only materials in the structure and equipment which are nontoxic, durable, inert, impervious to water, and easily cleaned.

(3) Owners shall design and maintain walking surfaces which are:

(a) Sloped a minimum one-fourth inch per foot;

(b) Of a nonslip finish;

(c) Equipped with sufficient drains to prevent standing water;

(d) Free of resilient coverings, e.g., carpeting; and

(e) At least four feet in width.

(4) Owners shall provide adequate barrier protection to prevent unauthorized access including:

(a) In outdoor facilities, a barrier six feet or more in height with:

(i) Openings, holes, or gaps not to exceed four inches except openings protected by gates or doors; and

(ii) Lockable gates and entrances either regulated during periods of use or provided with a self-closing, self-latching mechanism a minimum of forty-two inches from the ground.

(b) In indoor facilities, suitable barriers to prevent access by unauthorized individuals or pool access by unattended small children.

(5) Owners shall ensure that pools:

(a) Comply with all provisions of chapter 246-260 WAC where pool facilities are a separate attraction;

(b) Have surfaces with:

(i) Materials complying with subsection (2) of this section;

(ii) Watertight and nonabrasive construction;

(iii) Nonslip finish where users are walking; and

(iv) White or light color finish not obscuring the view of objects or surfaces.

(c) Are dimensionally designed to provide for the safety of the user and circulation of the water including, but not limited to:

(i) Absence of protrusions, extensions, means of entanglement, or other obstruction which can cause entrapment or injury;



(ii) Construction tolerances conforming with current ANSI public pool standards;

(iii) Uniform pool floor slopes as follows:

(A) Not exceeding one foot of drop in seven feet of run for pools serving as landing or exiting pools, where total water depth is less than forty-eight inches; and

(B) Providing a maximum slope of one foot of drop in twelve feet of run up to a depth of five and one-half feet in pools where users enter and participate in extended activities.

(iv) Vertical walls for a minimum distance noted in Table 4 of this section, which may be curved (not to exceed allowable radius) to join the floor.

(A) Vertical means walls not greater than eleven degrees from plumb.

(B) Coving or portion of the side wall of a diving area in the pool shall conform as described in subsection (5)(c)(vi) of this section.

(C) In new construction or alterations to existing construction, ledges are prohibited.

(D) Requirements in subsection (5)(c) of this section do not apply to spas.

(v) A maximum intrusion beyond the vertical (as defined in subsection (5)(c)(iv)(A) of this section) with any configuration not to exceed a transitional radius from wall to floor where floor slopes join walls and which:

(A) Has its center of radius no less than the minimum vertical depth specified in Table 4 of this section below the water level;

(B) Has arc of radius tangent to the wall; and

(C) Has a maximum radius of coving (or any intrusion into the pool wall/floor interface) determined by subtracting the vertical wall depth from the total pool depth.

TABLE 4  
MAXIMUM RADIUS COVING OR POOL INTRUSION  
DIMENSIONS BETWEEN POOL FLOOR AND WALL\*

Pool Depth	2'0"	2'6"	3'0"	3'6"	4'0"	4'6"	5'0"	>5'0"
Minimum Side Wall Vertical Depth	1'6"	1'10"	2'2"	2'6"	2'10"	3'2"	3'6"	>3'6"
Maximum Radius of Curvature	6"	8"	10"	12"	1'2"	1'4"	1'6"	**Maximum radius equals pool depth minus the vertical wall depth

Note:

\*For pool depths which fall between the depths listed, values can be interpolated.

\*\*Radius of coving cannot intrude into pool within diving envelope or deep water entry area for attractions entering above pool water level.

(vi) Provision of diving envelopes in pools or areas of pools designated for diving activities to include:

(A) A diving envelope of no less than the CNCA standard configuration\* noted in Figure 1 of this section in areas where user would enter from deck level, diving board, or platform at a height of less than one-half meter (twenty inches).

Note:

\*This requirement is based on a standard described in CNCA publication "Swimming Pools: a Guide to their Planning, Design, and

Operation" 1987. Fourth edition. Human Kinetics Publisher, Inc., Champaign, Illinois. Figure 8.1

FIGURE 1:

Minimum dimensions for pools with provision for diving from deck level or providing boards or platforms at a height less than one-half meter.

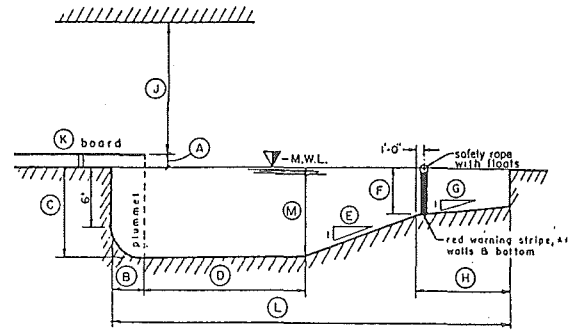

Dimension	Minimum	Preferred or Maximum
A Height of board above water	2 ft 6 in.	30 in.
B Board overhang	9 ft	3 ft
C Depth of water at plummet	16 ft	10 ft *
D Distance from plummet to start of upslope	4 ft 6 in.	18 ft *
E Inclination of upslope of bottom	1:12	1:3
F Depth of water at breakpoint	8 ft	1:15 *
G Slope of bottom in shallow portion of pool	13 ft	14 ft *
H Length of shallow section of pool	12 ft	15 ft *
I Distance to any overhead structure	40 ft	12 ft
K Board length	6 in.	50 ft *
L Length of pool		
M Dimension not less than C minus		

Note:

\*Values with asterisks are not to be considered as maximums.

\*\*Warning stripe at break point may be of any contrasting color.

(B) A diving envelope of no less than the FINA standard configuration\*\* noted in Figure 2 of this section in areas where user would enter from diving board or platform at a height of one-half meter (twenty inches) or greater.

Note:

\*\*This requirement is based on a standard described in FINA publication "FINA Handbook - 1986-1988." Constitution and rules governing swimming, diving, water polo, and synchronized swimming, 1986-1988. Edited by E. Allen Harvey, Vancouver, Canada VGN 3R6, Section D, pp. 114-115.

FIGURE 2:

Minimum dimensions for pools with boards or platforms at a height of one-half meter or more.

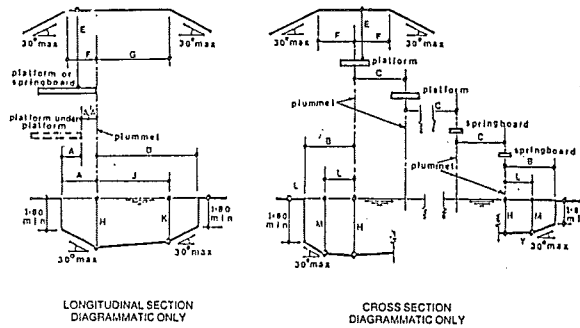

FINA	Dimensions are in Metres	SPRINGBOARD				PLATFORM								
		1 Metre		3 Metres		1 Metre		3 Metres		5 Metres		7.5 Metres		10 Metres
DIMENSIONS FOR DIVING FACILITIES	LENGTH	4.80	4.80	4.80	4.50	5.80	6.00	6.00	6.00	6.00	6.00	6.00	6.00	6.00
Revised to 1st Jan 1987	WIDTH	0.50	0.50	0.50	0.60	1.50	1.50	1.50	1.50	1.50	1.50	1.50	2.00	2.00
	HEIGHT	1.80	3.00	0.60-1.00	2.60-3.00	5.00	7.50	10.00	10.00	10.00	10.00	10.00	10.00	10.00
A	From plumbet BACK TO POOL WALL	DESIGNATION A-1	A-3	A-1Pl	A-3Pl	A-5	A-7.5	A-10	A-10	A-10	A-10	A-10	A-10	A-10
A/A	From plumbet BACK TO PLATFORM Plumbet directly below	DESIGNATION												
B	From plumbet to POOL WALL AT SIDE	DESIGNATION B-1	B-3	B-1Pl	B-3Pl	B-5	B-7.5	B-10	B-10	B-10	B-10	B-10	B-10	B-10
C	From plumbet to ADJACENT PLUMBET	DESIGNATION C-1/1	C-3/3/1	C-1/1Pl	C-3/1Pl/3Pl	C-5/3/1	C-7.5/5/3/1	C-10/7.5/5/3	C-10/7.5/5/3	C-10/7.5/5/3	C-10/7.5/5/3	C-10/7.5/5/3	C-10/7.5/5/3	C-10/7.5/5/3
D	From plumbet to POOL WALL AHEAD	DESIGNATION D-1	D-3	D-1Pl	D-3Pl	D-5	D-7.5	D-10	D-10	D-10	D-10	D-10	D-10	D-10
E	On plumbet, from BOARD TO CEILING	DESIGNATION E-1	E-3	E-1Pl	E-3Pl	E-5	E-7.5	E-10	E-10	E-10	E-10	E-10	E-10	E-10
F	CLEAR OVERHEAD behind and each side of plumbet	DESIGNATION F-1	F-3	F-1Pl	F-3Pl	F-5	F-7.5	F-10	F-10	F-10	F-10	F-10	F-10	F-10
G	CLEAR OVERHEAD ahead of plumbet	DESIGNATION G-1	G-3	G-1Pl	G-3Pl	G-5	G-7.5	G-10	G-10	G-10	G-10	G-10	G-10	G-10
H	DEPTH OF WATER at plumbet	DESIGNATION H-1	H-3	H-1Pl	H-3Pl	H-5	H-7.5	H-10	H-10	H-10	H-10	H-10	H-10	H-10
J	DISTANCE AND DEPTH ahead of plumbet	DESIGNATION J-1	J-3	J-1Pl	J-3Pl	J-5	J-7.5	J-10	J-10	J-10	J-10	J-10	J-10	J-10
K	DISTANCE AND DEPTH each side of plumbet	DESIGNATION K-1	K-3	K-1Pl	K-3Pl	K-5	K-7.5	K-10	K-10	K-10	K-10	K-10	K-10	K-10
M	MAXIMUM SLOPE TO REDUCE DIMENSIONS beyond full requirements	POOL DEPTH	30 degrees	NOTE	Dimensions C (plumbet to adjacent plumbet) apply for Platform with widths as detailed. For wider Platforms increase C by half the additional width(s)									
	CEILING HT		30 degrees											

- (d) Have adequate handholds around the perimeter in pools designed for extended swimming and bathing activity and excluding wave pools; and
- (e) Stairs, ladders, or stepholes with:
  - (i) Stairs, when provided, meeting the following construction requirements:
    - (A) Treads of a nonslip finish;
    - (B) Stair tread edges colored to contrast with the color of the pool and clearly visible to the users;

- (C) Recessed in pool areas used for lap swimming or provided with wave action; and
- (D) Equipped with handrails extending over the edge of the deck.
  - (ii) Ladders or stepholes which:
    - (A) Furnish exit from pools greater than four feet in depth except in landing pools bringing the user toward a shallow area after entering the water;

(B) Are spaced a minimum of one for every fifty feet of pool perimeter greater than four feet deep;

(C) Are provided at both sides of the deep end in pools over thirty feet in width; and

(D) Are equipped with a handrail at the top of both sides extending over the coping or edge of the deck.

(iii) User access at the shallow end of pool.

(6) Owners shall ensure treatment turnover at rates no less than designated as follows:

(a) In receiving pools for water slides, water tubes, inner tube rides, speed slides or tubes, drop slides or tubes, and kiddie flume slides, treatment turnover time can be based on any of the following:

(i) Total attraction volume in one-hour period;

(ii) Treatment turnover equals design peak usage (maximum users per hour) expressed in gpm;

(iii) A rate of one hour for 20,000 gallons per two or less attraction segments. Treatment turnover times may increase proportionately for larger pool volumes per two or less attraction segments;

(iv) Alternative methods where provisions to reduce contaminants are justified to the satisfaction of the department or local health officer; and

(v) Treatment turnover times not to exceed six hours.

(b) For wave pools, a minimum treatment turnover time of two hours; and

(c) For activity pools, a minimum treatment turnover time of four hours.

(7) Owners shall provide pool inlets which are:

(a) Submerged and located to produce uniform circulation of water and chemicals throughout the pool; and

(b) Located on the bottoms of pools greater than two thousand five hundred square feet, unless otherwise justified by the engineer to the satisfaction of the department or local health officer.

(8) Owners shall provide pool outlets with:

(a) Overflow and main drain with each designed to carry one hundred percent of total recirculation filter flow;

(b) Overflow outlets that have:

(i) Design to maintain a minimum of sixty percent of filter recirculation flow at all times;

(ii) An overflow channel on the pool perimeter to promote uniform circulation and skimming action of the upper water layer for pools greater than twenty-five hundred square feet, with:

(A) Design preventing matter entering channel from returning to the pool;

(B) Dimensions minimizing the hazard for bathers, such as catching arms or feet in an overflow channel;

(C) 0.01 foot slope per foot or more;

(D) Drains sufficiently spaced and sized to collect and remove overflow water to return line to filter where applicable;

(E) Size sufficient to carry one hundred percent of the recirculation flow plus the surge flow equivalent to one-fifth of the balancing tank expressed in gallons per minute.

(iii) Skimmers, when used on pools up to twenty-five hundred square feet, if:

(A) Demonstrated to operate properly under design conditions;

(B) Turbulence is not expected to interfere with operation;

(C) Maximum flow rate through skimmers does not exceed four gpm per inch of weir;

(D) Devices are recessed in the wall of the pool so that no part protrudes beyond the plane of the wall into the pool;

(E) The skimmer is equipped with a device to prevent air lock in the recirculation suction line (i.e., an equalizer line); and

(F) The skimmer is equipped with a removable and cleanable screen designed to trap large solids.

(iv) Sidewall channels, when used on pools up to twenty-five hundred square feet, which accept the total recirculation volume of the pool through the upper side of the pool if:

(A) Overall flow through the channel exceeds four times the treatment recirculation rate;

(B) Design of channel prevents entrapment of the user;

(C) Openings of any screens have less than one-half inch slots;

(D) Channel openings do not allow access beyond the pool, except with the use of specific tools requiring their opening;

(E) Open area of grates prevent a suction or entrapment hazard which could be dangerous to the user; and

(F) The channel provides an action pulling water from the top of the pool to remove floatable debris and oils.

(c) Main drains in all pools with:

(i) Location at the low points of the pool;

(ii) A minimum of two main drains spaced not further than twenty feet apart nor closer than six feet or spaced as far as possible from each other in pools less than six feet linear floor distance;

(iii) Total open area of grates preventing a suction or entrapment hazard which could be dangerous to user;

(iv) Flat grate drains having:

(A) Maximum flow of 1.5 feet per second; or

(B) Net area of outlet being at least four times the area of the discharge pipe.

(v) Maximum flow of four feet per second in anti-vortex drains;

(vi) Openings not allowing a sphere over one-half inch in diameter to pass;

(vii) Grate design to withstand forces of users;

(viii) Grates removable only with specific tools; and

(ix) Means to control flow from recirculation pump or balancing tank.

(9) Owners shall maintain recirculation flow which:

(a) Does not exceed six feet per second in suction or valved discharge side of pump; and

(b) Does not exceed ten feet per second in open discharge pipes on the pressure side of the pump or filter discharge. This limit does not apply to the return inlet and the last two feet of pipe leading to the inlet.

(10) Owners shall provide a surge chamber or surge area in RWCFs with an entry pool to:

(a) Accommodate at least two minutes of the total turnover; and

(b) Maintain proper water levels for treatment and operation of the attraction.

(11) Owners having RWCFs with overflow channels requiring balancing tanks shall:

(a) Maintain volume equivalent to fifteen times maximum bathing load expressed in gallons; and

(b) Increase capacity as necessary to provide volume for make-up water and to prevent air lock in the pump suction line.

(12) Owners shall have and maintain recirculation pumps with adequate capacity to:

(a) Provide design flows and pressure for recirculation of the RWCF water over the entire operating pressure of the filter;

(b) Allow proper capacity for backwashing of filters when specified; and

(c) Have self-priming capability when installed above the pool water level.

(13) Where pumps precede the filter, owners shall install hair and lint strainers, which shall:

(a) Be located upstream of recirculation pumps;

(b) Be of corrosion-resistant material sufficiently strong to prevent collapse when clogged;

(c) Have an operable cover; and

(d) Provide valving to isolate the strainer when located below pool water level.

(14) Owners shall provide valves at appropriate locations to allow isolation and maintenance of equipment.

(15) Owners shall provide equipment rooms which:

(a) Enclose pumps, disinfection equipment, filters, and other electrical and mechanical equipment and associated chemicals;

(b) Provide adequate working space and access to perform routine operations;

(c) Provide lighting and ventilation of the equipment room; and

(d) Are not accessible to the public.

(16) Owners shall ensure the source of make-up water and associated piping in the RWCF:

(a) Provides sufficient quantity to replace daily losses from the pool;

(b) Comes from a supply conforming with chapter 246-290 WAC; and

(c) Prevents cross-connections using a minimum air gap of two pipe diameters or approved backflow prevention devices between the make-up water source and the RWCF attraction water or waste water.

(17) Owners shall equip RWCFs with filtration equipment which:

(a) Meets the applicable standards of NSF or equivalent;

(b) Uses acceptable types and filter rates described in Table 5 of this section:

TABLE 5  
FILTER TYPES AND ACCEPTABLE RATES

Type of Filter	Range of Acceptable Filter Rate Expressed in gpm/sq. ft.		
	Minimum	Maximum*	
<b>Sand</b>			
Rapid & pressure	—	3	
Pressure high rate	10	18	
Vacuum high rate	10	18	
<b>DE</b>			
	Continuous feed	Manual feed	
Vacuum	0.8	1.0	2.0
Pressure	1.0	1.35	2.0

Cartridge\*\*

Applied in temperature ranges:

<95°F.	—	0.375
>95°F.	—	0.188

Note:

\*Filters sized at maximum application rate shall use flow control valves.

\*\*Cartridge filters shall have a nominal micron rating of twenty microns or less.

(c) Has pressure or vacuum gauges for measuring loss of head (pressure) through the filter with minimum of one gauge preceding and one gauge following the filter;

(d) Has a flow indicator to measure treatment turnover; and

(e) Has means of discharging filter backwash to waste with:

(i) Discharge in a manner not creating a public nuisance;

(ii) Disposal in accordance with applicable local law or regulation;

(iii) Minimum air gap of two pipe diameters to prevent cross-connection from waste discharge and recirculation system piping;

(iv) Discharge receptor and piping of sufficient size to accept backwash water and prevent flooding; and

(v) Provisions to monitor filter effluent during backwash.

(18) Owners shall provide disinfection equipment which:

(a) Provides a continuous and effective residual of disinfectant in the water;

(b) Uses a disinfectant with a residual that is easily monitored;

(c) Conforms with NSF standards when liquid or solid feed materials are used;

(d) Has a design feed rate which will provide effective disinfection levels when RWCFs are in use;

(e) Meets the following conditions if chlorine gas is used:

(i) Chlorine rooms shall:

(A) Be above ground level;

(B) Be constructed so all openings or partitions with adjoining rooms are sealed;

(C) Be located with consideration of prevailing winds to dissipate leaked chlorine away from the RWCF;

(D) Have door opening outward only and to the out-of-doors.

(ii) Mechanical exhaust ventilation of the chlorine room including:

(A) Air inlet located as far as possible from fan intake to promote good air circulation patterns;

(B) Minimum of one air change per minute in the chlorine room when fan is operating;

(C) A remote switch outside the room or a door-activated switch to turn on fan prior to entering;

(D) Suction for fan near the floor; and

(E) Exhaust for fan and chlorinator vent located to prevent contaminating air intakes or prevent undue hazard for the users of the RWCF.

(iii) Gas chlorine systems which:

(A) Are vacuum injection type, with vacuum actuated cylinder regulators; and

(B) Provide adequate-sized backflow and anti-siphon protection at the ejector.

(iv) Breathing protection available in an accessible area for the operator outside of the chlorine room including:

(A) Instructions about limitations with chlorine concentrations and concentrations of oxygen if chlorine-type canister masks are used; and

(B) Self-contained breathing apparatus designed for use in a chlorine atmosphere as preferred equipment for working with chlorine leaks.

(v) Means for automatic shutoff when the recirculation filter pump is off or flow to the pool is interrupted;

(vi) Chlorine gas cylinders shall:

(A) Be stored only in chlorine rooms; and

(B) Not exceed one hundred fifty pounds tare weight per cylinder; except, wave pools, where one-ton cylinders may be used. Only a single, one-ton cylinder shall be stored on the premise at any time.

(19) Owners applying chemicals other than disinfectant shall provide chemical feed equipment with:

(a) Adequate size and design to allow routine cleaning and maintenance;

(b) Materials resistant to action of the chemicals to be used; and

(c) Means for automatic shut off when the recirculation filter pump is off or flow to the pool is interrupted.

(20) Owners shall have testing equipment to provide means for measuring disinfectant residuals, pH, alkalinity, and any other chemicals used routinely in the RWCF water. In pools where compressed chlorine gas is used, means to detect leaks shall be provided, i.e., use of proper strength ammonia vapor.

(21) Owners shall provide easily accessible change room facilities at all RWCFs with:

(a) Dressing rooms, showers, toilets, urinals, and sinks;

(b) Change room design including:

(i) Separate facilities for both sexes;

(ii) Floors of a nonslip finish with suitable drains;

(iii) Junctions between walls and floors covered for ease of cleaning;

(iv) Adequate ventilation to prevent build-up of moisture in the facility; and

(v) Provisions to minimize cross traffic with nonusers.

(c) Plumbing fixtures as described in Table 6 of this section.

4.	Sinks	First 400	1/200	1/200
		Next 350	1/350	1/350
5.	Hose bibs	Portion exceeding 750	1/500	1/500
			1 accessible to change rooms	
6.	Janitor sink		1 within the RWCF	

(d) Showers:

(i) Delivering water at a temperature range between ninety and one hundred ten degrees Fahrenheit; and

(ii) Providing liquid or powdered soap in nonglass dispensers.

(e) Flush toilets and toilet tissue in dispensers;

(f) Sinks providing:

(i) Tempered or hot and cold running water,

(ii) Liquid or powdered soap in nonglass dispensers, and

(iii) Disposable towels or electric hand dryers.

(g) Sewage disposed of in a manner approved by the department or local health officer; and

(h) Hose bibs with vacuum breakers provided at convenient locations.

(22) Owners shall design and maintain lighting at RWCF attractions or change rooms to:

(a) Illuminate indoor attractions, outdoor attractions used after dusk, or change rooms with a minimum lighting intensity maintained thirty inches above any walking surface, pool deck, or pool area of:

(i) Thirty foot-candles at indoor facilities;

(ii) Fifteen foot-candles at outdoor facilities; or

(iii) Twenty foot-candles in change rooms.

(b) Allow lifeguards or attendants to clearly see every part of pool waters and walking surfaces; and

(c) Meet any additional lighting requirements deemed necessary by the department or local health officer.

(23) Owners shall provide first aid facilities in every RWCF including:

(a) A twenty-four package first aid kit per WAC 296-24-065;

(b) Two or more blankets reserved for emergency use;

(c) A telephone with a prominently displayed list of emergency medical service response numbers;

(d) A backboard meeting the specifications of the ARC; and

(e) Sufficient and suitable area to accommodate persons requiring treatment and necessary first aid equipment.

(24) Owners shall provide signs at RWCF entrances and change rooms. Any combination of words, pictures, or symbols may be used to convey the following conditions:

(a) Prohibition of use by persons with communicable diseases;

(b) Prohibition of use by persons under the influence of alcohol or drugs;

(c) Requirement for a cleansing shower before entering the attractions;

(d) Warning that persons refusing to obey the attendants are subject to removal from the premises; and

(e) Prohibition of food and drink in pool, change room, or on walking surfaces.

(25) If owners allow or make provision for food service:

(a) Food and beverage sale and consumption areas shall be separate from pool, change room, and walking surfaces;

TABLE 6  
MINIMUM PLUMBING FIXTURE REQUIREMENTS  
BASED ON MAXIMUM PEAK PERIOD OCCUPANCY

Type of Fixture	Occupancy/Sex	Number of Fixtures Required Per Occupancy Load	
		Male	Female
1. Toilets	First 600	1/200	1/100
	Portion exceeding 600	1/450	1/300
2. Urinals	First 600	1/200	-
	Portion exceeding 600	1/450	-
3. Showers	First 300	1/100	1/100
	Portion exceeding 300	1/200	1/200

- (b) Trash containers shall be provided; and
  - (c) No glass containers shall be allowed in the RWCF.
- (26) Owners shall prevent users or spectators access to mechanical, electrical, or chemical equipment facilities.

(27) Owners shall provide an operable drinking fountain of the angle jet type design meeting the requirements of the American Standards Association.

[Statutory Authority: RCW 70.90.120. 92-02-020 (Order 226B), § 246-262-060, filed 12/23/91, effective 1/23/92. Statutory Authority: RCW 43.20.050. 91-02-051 (Order 124B), recodified as § 246-262-060, filed 12/27/90, effective 1/31/91. Statutory Authority: RCW 70.90.120. 88-13-125 (Order 311), § 248-97-070, filed 6/22/88.]

**WAC 246-262-070 Specific design, construction, and equipment.** (1) Owners shall provide specific design, construction, and equipment for the various types of RWCF attractions.

(2) Owners and manufacturers shall ensure adherence to recognized design and construction standards including, but not limited to:

- (a) ASTM F-24 Standards on Amusement Rides and Devices;
- (b) "Suggested Health and Safety Guidelines for Recreational Water Slide Flumes" U.S. Department of Health and Human Services, Centers for Disease Control, Atlanta, Georgia, 30333;
- (c) "World Waterpark Association Considerations for Operating Safety" published by the World Waterpark Association, 7474 Village Drive, Prairie Village, Kansas, 66208; and

(d) Department recognized or approved guidelines, criteria, or standards.

(3) Owners shall ensure design and construction for water slides or tubes, inner-tube rides, kiddie flumes, or ramp slides meet the following minimum standards:

- (a) Flume or tube entry access points shall have:
  - (i) Means to control unauthorized entrance;
  - (ii) Handrails or slip-resistant surfaces provided to assist users; and
  - (iii) Attendant stations which provide:
    - (A) User entry spacing control;
    - (B) Attendant line of sight to the attraction; and
    - (C) Attendant access to a communication system.
- (b) Receiving pools shall have:

(i) Clearances and minimum distances as noted in Figure 3 of this section for tube or flume entrances into pools.

FIGURE 3  
MINIMUM CLEARANCES FOR FLUME OR TUBE ENTRY TO RECEIVING POOLS

	MINIMUM VALUE	DISTANCE	DESCRIPTION
A	5 feet		Minimum distance from edge of flume to side of pool.
B	6 feet		Minimum distance between sides of parallel flumes.
C	20 feet		Minimum distance between two flumes or tubes that are not parallel shall be so constructed so that the intersecting lines of each closest side does not intersect for a distance of at least twenty feet from the end of each flume.
D	20 feet		Minimum distance where flume terminates to opposite side of pool.

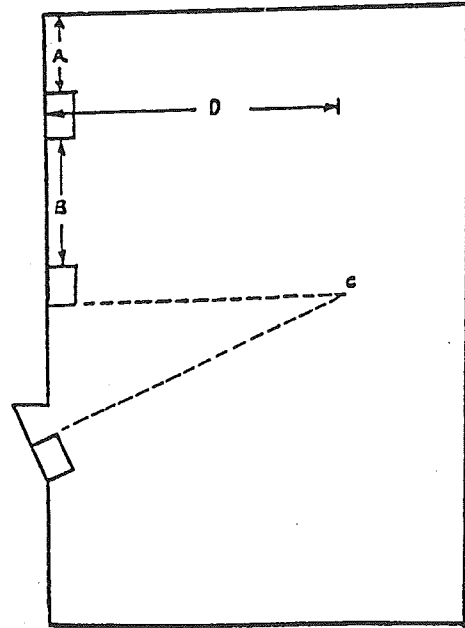

- (ii) Flume or tube sliding surface ending below the pool operating water level when users ride unaided or on mats;
- (iii) Flume or tube perpendicular for a minimum of ten feet to the wall of entry;
- (iv) Handrails, when steps are provided for exiting; and
- (v) Attendant and/or lifeguard stations with:
  - (A) Unobstructed access to users; and
  - (B) Ready access to communication system for contacting control station attendant and first aid personnel.
- (4) Owners shall design and construct barriers to prevent unauthorized entry or exit from any intermediate pool.
- (5) Owners shall ensure design and construction of speed slides meet the following minimum standards:
  - (a) Entry points conforming with subsection (3)(a) of this section;
  - (b) Roller- or sled-type slides designed to prevent accidental flipping of the sleds or coasters when entering the water;
  - (c) Provision of sufficient transition zones for deceleration preventing unsafe user impact; and

(d) Maintenance of critical water operation levels providing proper braking action of the user.

(6) Owners shall ensure design and construction of wave pools meet the following minimum standards:

(a) Walls of wave pools shall be vertical with minimum six inch radius of curvature between wall and pool bottom;

(b) Pool bottom sloped:

(i) Not exceeding one foot of drop in twelve feet of run where pool depths range from zero to three and one-half feet; or

(ii) Not exceeding one foot of drop in nine feet of run where depths range from three and one-half feet to six and one-half feet.

(c) Recessed ladders or step holes with vertical grab bars at depths above three and one-half feet:

(i) For emergency exit only;

(ii) Spaced at intervals of fifty feet or less where pool water depths are greater than three and one-half feet. Pool water depths are measured without wave action.

(d) Deck width of at least ten feet along the shallow end;

(e) A fence or restrictive barrier a minimum of forty-two inches in height and at least two feet out from the pool/deck interface at the side walls of wave pools, with emergency exit openings.

(f) Lifeguard station locations appropriate to prevailing conditions;

(g) A push-button system to shut off the wave-making equipment with:

(i) Shut offs installed on sidewall decks and spaced at intervals no greater than one hundred feet, readily accessible to the lifeguards; and

(ii) Shock hazard protection.

(h) A communication system for use by authorized personnel which is clearly audible to all portions of the pool;

(i) A communication system for interaction between authorized personnel; and

(j) Maximum bathing load (users) not to exceed a value equal to  $S/12 + D/68$  where:

(i) "S" equals surface area in square feet where depth is less than three and one-half feet;

(ii) "D" equals surface area in square feet where pool depth is three and one-half feet deep or greater; and

(iii) Pool depths are measured without wave action.

(7) If inner tubes, boogie boards, or surf boards are used, the owner shall ensure the design and operation of the wave pool provides for such activity, including:

(a) The establishment of rules for use;

(b) Operating and emergency procedures; and

(c) Crowd control.

(8) Owners shall ensure design and construction of any wading activity pool meets the following minimum standards. Wading activity pool areas are:

(a) Built with maximum water depth of two feet;

(b) Constructed with pool walls so that distance from deck to water level is six inches or less for at least seventy-five percent of the pool perimeter;

(c) Equipped with floors uniformly sloped to drain with a maximum slope of one foot of drop in twelve feet of run;

(d) Separated by at least a four foot high barrier when distance to any water area greater than four feet in depth is less than ten feet; and

(e) Protected from water areas greater than two feet by providing:

(i) A float line separating the two areas;

(ii) A six inch contrasting color line on pool bottom and side walls at float line; and

(iii) A transition zone with a maximum floor slope not exceeding one foot of drop in twelve feet of run.

(9) Owners shall ensure design and construction of drop slides or drop tubes meet the following minimum standards:

(a) Entry in accordance with subsection (3)(a) of this section;

(b) Receiving pool envelope:

(i) Conforming to CNCA standards noted in WAC 246-262-060 (5)(c)(vi)(A) if the point of exit is less than one-half meter (or twenty inches);

(ii) Conforming to FINA standards noted in WAC 246-262-060 (5)(c)(vi)(B) if the point of exit is one-half meter (or twenty inches) or greater.

(iii) Increasing in size to ensure user safety if warranted by angle of entry or speed of the user.

(c) Sufficient distance between slides or tubes to prevent collisions of users. Parallel exits are recommended.

(d) Direct line of sight and direct communication between entry access point and receiving pool.

(10) Owners shall provide signs for specific RWCF attractions. Words, pictures, or symbols may be used to convey the following as appropriate:

(a) Prohibition of running, standing, kneeling, tumbling, horseplay, or stopping in the flumes or tubes;

(b) Failure to follow directions of attendant or failure to obey posted rules may result in removal from the RWCF;

(c) Prohibition of diving from flume;

(d) Prohibition of multiple user chains if applicable to ride;

(e) Requirement to leave the landing area promptly after exiting;

(f) Recommended minimum or maximum age or height for using this attraction; and

(g) Prohibition of head first sliding if applicable to ride.

(h) Additional information on wave pools including:

(i) Warning that wave pools can be very tiring;

(ii) Warning for small children and poor swimmers to use personal flotation devices in designated areas;

(iii) Requirement for adult supervision for children;

(iv) Prohibition of diving, jumping, or entering from sides of pool; and

(v) Prohibition of using surf boards during periods of general public use.

(11) If the proposed attraction design is not addressed by or exceeds limitations of standards and guidelines specified by this section, owners shall submit:

(a) Justification to the department or local health officer prepared by an engineer; and

(b) Information on the construction, maintenance, and operation of the proposed attraction.

[Statutory Authority: RCW 70.90.120. 92-02-020 (Order 226B), § 246-262-070, filed 12/23/91, effective 1/23/92. Statutory Authority: RCW 43.20.050. 91-02-051 (Order 124B), recodified as § 246-262-070, filed 12/27/90, effective 1/31/91. Statutory Authority: RCW 70.90.120. 88-13-125 (Order 311), § 248-97-080, filed 6/22/88.]



**WAC 246-262-080 Operation.** (1) Owners shall ensure proper operation to protect the public health and safety of the users and the water quality of the RWCF.

(2) Owners shall prepare and use an operations manual for the RWCF.

(3) Owners shall routinely inspect, maintain, and repair the physical components to:

(a) Ensure all structural facilities are intact and free from corrosion, wear, or stress;

(b) Prevent water ponding on walking surfaces;

(c) Ensure equipment is available and operable including:

(i) Disinfection, filtration, and related equipment;

(ii) Lifesaving equipment; and

(iii) Communication systems.

(4) Owners shall ensure user health and safety by adequately staffing the RWCF during operation. Staffing shall include:

(a) Advanced first aid personnel at all times facility is open to the public;

(b) Lifeguards and/or attendants as appropriate at all times facility is open to the public; and

(c) Water treatment operator as needed.

(5) Owners shall ensure each type of personnel performs the following duties:

(a) Advanced first aid personnel shall provide emergency medical treatment;

(b) Lifeguard shall have sole responsibility for guarding users in area assigned;

(c) Attendants shall have sole responsibility for assuring proper user control in areas assigned; and

(d) Water treatment operator shall oversee water treatment operations and conduct necessary water quality monitoring.

(6) Owners shall ensure each type of personnel meets the designated training requirements:

(a) Advanced first aid personnel with:

(i) A current advanced first aid certification or equivalent or higher levels of training including:

(A) First responder;

(B) Emergency medical technician; or

(C) Paramedic.

(ii) Training on management of spinal injuries in the aquatic environment if lifeguards with lifeguard training are not at the RWCF.

(b) Lifeguards with a current lifeguard certificate through any of the recognized programs in the definition (WAC 246-262-010(23));

(c) Attendants with training determined appropriate by the owner to respond to user safety needs at the attractions, and:

(i) Attendants stationed at shallow pool facilities (less than four feet water depth) with documented training regarding their response in at least the following:

(A) Safety instruction on basic methods of water rescue, reaching, and extension assists;

(B) Cardiopulmonary resuscitation (CPR) and airway management;

(C) Basic bleeding control;

(D) Basic fracture management; and

(E) Specific instruction on management of spinal injuries related to the aquatic environment.

(ii) Attendants stationed at entry access areas with basic training including:

(A) Controlling and supervising users in areas where attendant is responsible;

(B) Controlling timing of user entry rate where appropriate;

(C) Use of communication systems; and

(D) Knowledge of CPR by at least one attendant on duty.

(d) Water treatment operators knowledgeable in pool water chemistry, filters, and pumping equipment; and

(e) When gas chlorine is used, the manager or the operator with specific training in:

(i) Proper operation and maintenance procedures of the chlorination equipment;

(ii) Physical and chemical properties of chlorine gas under pressure;

(iii) Use of emergency safety equipment; and

(iv) Proper first aid procedures and response for accidental inhalation of chlorine gas and leaks.

(7) Owners shall ensure adequate emergency response with:

(a) Lifeguards (and attendants where appropriate) located to provide a response time not to exceed thirty seconds to all users in pools;

(b) Backup lifeguard (or attendant where appropriate) provisions so response time is maintained during multiple rescues;

(c) Lifeguards at all pools. Attendants may substitute for lifeguards at pools less than four feet in depth which:

(i) Are strictly used as receiving pools for attractions where users leave the pool immediately after entering; or

(ii) Are strictly used for wading activity; and

(iii) Attendants meet the training requirements specified in subsection (6)(c)(i) of this section.

(d) Provisions for emergency response drills to meet the response time and actions noted in WAC 246-262-080 including:

(i) Drills at least twice each operating season; and

(ii) Documentation of testing.

(8) Owners shall regulate activities of users and spectators including:

(a) Requirement to obey RWCF rules related to health and safety; and

(b) Warning that failure to comply with rules constitutes grounds for exclusion from the premises or management action as necessary.

(9) Owners shall ensure RWCF user control in specific attractions by requiring:

(a) On speed slides, completion of the ride by one user before allowing another user to enter;

(b) On ramp slides, clearing of the slide by one group prior to second group entering; and

(c) On drop slide or tube, clearing of the pool entry area prior to allowing another user to enter.

(10) Owners shall monitor various environmental conditions which affect facility safety. Weather conditions, including electrical storms, fog, wind, sun glare creating visibility problems, and other such factors shall be evaluated. Appropriate action shall be taken in response to these factors to ensure user safety.

[Statutory Authority: RCW 70.90.120. 92-02-020 (Order 226B), § 246-262-080, filed 12/23/91, effective 1/23/92. Statutory Authority: RCW 43.20.050. 91-02-051 (Order 124B), recodified as § 246-262-080, filed 12/27/90, effective 1/31/91. Statutory Authority: RCW 70.90.120. 88-13-125 (Order 311), § 248-97-090, filed 6/22/88.]

**WAC 246-262-090 Monitoring, reporting, and record keeping.** (1) Owners shall:

(a) Provide information requested by the department or local health officer for statewide injury and illness surveillance reports; and

(b) Notify the department or local health officer within forty-eight hours of any drowning, near drowning, death, or serious injury or illness occurring at the RWCF.

(2) Owners shall monitor and maintain records on the following for at least three years:

(a) Water quality conditions including:

(i) Testing for residual disinfectant concentration three or more different periods daily, except once a day if electronic monitoring and control equipment is provided;

(ii) Hydrogen ion (pH) concentration tested daily;

(iii) Alkalinity monitored at least weekly;

(iv) Any other chemical added to water including alum, algicides, cyanurate compounds, acid, and alkalinity compounds, etc.;

(v) Pressure or vacuum gauge readings; and

(vi) Any gross contamination to the water (i.e., vomiting, feces, etc.).

(b) Routine preventive maintenance provided on all hazardous equipment, e.g., gas chlorination equipment;

(c) Number of users of the facility; and

(d) Credentials, training, and/or certifications required for personnel per WAC 246-262-080 of this chapter.

(3) Owners shall notify the department in the event an incident occurs with a chemical creating a problem of health or safety significance (e.g., chlorine gas leak).

(4) Owners shall make records available for department review upon request.

[Statutory Authority: RCW 70.90.120. 92-02-020 (Order 226B), § 246-262-090, filed 12/23/91, effective 1/23/92. Statutory Authority: RCW 43.20.050. 91-02-051 (Order 124B), recodified as § 246-262-090, filed 12/27/90, effective 1/31/91. Statutory Authority: RCW 70.90.120. 88-13-125 (Order 311), § 248-97-100, filed 6/22/88.]

**WAC 246-262-100 Inspection.** (1) Owners shall permit the department or local health officer to perform on-site inspections as necessary in the discretion of the enforcing agency to ensure compliance with standards in chapter 70.90 RCW and chapter 246-262 WAC.

(2) Employees of the enforcing agency shall provide appropriate identification when entering for purpose of routine inspections.

[Statutory Authority: RCW 70.90.120. 92-02-020 (Order 226B), § 246-262-100, filed 12/23/91, effective 1/23/92. Statutory Authority: RCW 43.20.050. 91-02-051 (Order 124B), recodified as § 246-262-100, filed 12/27/90, effective 1/31/91. Statutory Authority: RCW 70.90.120. 88-13-125 (Order 311), § 248-97-110, filed 6/22/88.]

**WAC 246-262-110 Advisory committee.** The RWCF advisory committee shall:

(1) Perform functions as specified in accordance with RCW 70.90.130;

(2) Meet at least one time each year;

(3) Be composed of representatives as specified in RCW 70.90.130 appointed to staggered two-year terms, the representative from the department shall not be subject to these conditions;

(4) Select a chairperson every two years;

(5) Establish department representative as ongoing secretary of the advisory committee; and

(6) Present an annual report to the board summarizing committee activities.

[Statutory Authority: RCW 43.20.050. 91-02-051 (Order 124B), recodified as § 246-262-110, filed 12/27/90, effective 1/31/91. Statutory Authority: RCW 70.90.120. 88-13-125 (Order 311), § 248-97-120, filed 6/22/88.]

**WAC 246-262-120 Enforcement.** (1) The department or, if enforcement responsibility has been assigned under a joint plan of operation, the local health officer:

(a) Shall enforce the rules of chapter 246-262 WAC; or

(b) May refer cases within their jurisdiction to the local prosecutor's office or office of the attorney general, as appropriate.

(2) When a RWCF is in violation of provisions of chapter 70.90 RCW or the rules of chapter 246-262 WAC, appropriate enforcement action may be initiated by the department, local health officer, local prosecutor's office, or office of the attorney general. Enforcement actions may include any one or a combination of the following:

(a) Informal administrative conferences, convened at the request of the department, local health officer, or owner, to explore facts and resolve problems;

(b) Orders directed to the owner and/or operator of the RWCF and/or the person causing or responsible for the violation of the rules of chapter 246-262 WAC;

(c) Imposition of civil penalties of up to five hundred dollars per violation per day as authorized under RCW 70.90.200;

(d) Denial, suspension, or revocation of operating permits; and

(e) Civil or criminal action initiated by the local prosecutor's office or by the office of the attorney general.

(3) Orders authorized under this section include, but are not limited to, the following:

(a) Orders requiring corrective measures necessary to effect compliance with chapter 246-262 WAC or chapter 70.90 RCW. Such orders may or may not include a compliance schedule; and

(b) Orders to stop work and/or refrain from using any RWCF or portion thereof or improvement thereto until all permits, certifications, and approvals required by statute or rule are obtained.

(4) An order issued under this section shall:

(a) Be in writing;

(b) Name the facility and the person or persons to whom the order is directed;

(c) Briefly describe each action or inaction constituting a violation of chapter 70.90 RCW or the rules of chapter 246-262 WAC;

(d) Specify any required corrective action or forbearance together with a schedule for completing such corrective action, if applicable;

(e) Provide notice, as appropriate, that continued or repeated violation may subject the violator to:

- (i) Civil penalties of up to five hundred dollars;
- (ii) Denial, suspension, or revocation of the facilities operating permit; or
- (iii) Referral to the office of the county prosecutor or attorney general.

(f) Provide the name, business address, and phone number of an appropriate staff person who may be contacted in regard to an order.

(5) Service of an order shall be made:

- (a) Personally, unless otherwise provided by law; or
- (b) By certified mail return receipt requested.

(6) Under such rules or policies as the department or local health officer may adopt, civil penalties of up to five hundred dollars per violation per day may be assessed against any person violating the provisions of chapter 70.90 RCW or chapter 246-262 WAC.

(7) The department or local health officer shall have cause to deny the application or reapplication for an operating permit or to revoke or suspend a required operating permit of any person who has:

(a) Previously had:

- (i) An operating permit suspended or revoked; or
- (ii) An application for an operating permit denied for any reason whether in this state or any other state.

(b) Failed or refused to comply with the provisions of chapter 70.90 RCW, chapter 246-262 WAC, or any other statutory provision or rule regulating the construction or operation of a RWCF; or

(c) Obtained or attempted to obtain an operating permit or any other required certificate or approval by fraudulent means or misrepresentation.

(8) For the purposes of subsection (7) of this section, a person shall be defined to include:

- (a) Applicant;
- (b) Reapplicant;
- (c) Permit holder; or

(d) Any individual associated with subsection (8)(a), (b), or (c) of this section including, but not limited to:

- (i) Board members,
- (ii) Officers,
- (iii) Managers,
- (iv) Partners,
- (v) Association members,
- (vi) Employees,
- (vii) Agents, and in addition
- (viii) Third persons acting with the knowledge of such persons.

(9) The department or local health officer may summarily suspend an operating permit, other required permit, license, or certification without a prior hearing if the department or local health officer:

(a) Finds that public health, safety, or welfare imperatively requires emergency action; and

(b) Incorporates a finding to that effect in its notice or order.

[Statutory Authority: RCW 70.90.120. 92-02-020 (Order 226B), § 246-262-120, filed 12/23/91, effective 1/23/92. Statutory Authority: RCW 43.20.050. 91-02-051 (Order 124B), recodified as § 246-262-120, filed 12/27/90, effective 1/31/91. Statutory Authority: Chapter 34.05 RCW and RCW 70.90.120. 90-06-049 (Order 040), § 248-97-130, filed 3/2/90, effective 3/2/90. Statutory Authority: RCW 70.90.120. 88-13-125 (Order 311), § 248-97-130, filed 6/22/88.]

**WAC 246-262-130 Notice of decision—Adjudicative proceeding.** (1) A hearing requested to contest a local health officer's action shall be governed by the local health jurisdiction's rules for hearings.

(2)(a) The department's notice of a denial, suspension, modification, or revocation of a license shall be consistent with section 377, chapter 3, Laws of 1991. An applicant or license holder has the right to an adjudicative proceeding to contest the decision.

(b) A department notice of imposition of a civil fine shall be consistent with section 378, chapter 3, Laws of 1991. A person the department imposes a civil fine on has the right to an adjudicative proceeding to contest the decision.

(c) A license applicant or holder or a person the department imposes a fine on contesting a department decision shall within twenty-eight days of receipt of the decision:

(i) File a written application for an adjudicative proceeding by a method showing proof of receipt with the Administrative Hearings Unit, Department of Health, 1300 Quince Street, S.E., Mailstop: EY-17, Olympia, WA 98504; and

(ii) Include in or with the application:

(A) A specific statement of the issue or issues and law involved;

(B) The grounds for contesting the department decision; and

(C) A copy of the contested department decision.

(d) The proceeding is governed by the Administrative Procedure Act (chapter 34.05 RCW), this chapter, and chapter 246-08 WAC. If a provision in this chapter conflicts with chapter 246-08 WAC, the provision in this chapter governs.

[Statutory Authority: RCW 70.90.120. 92-02-020 (Order 226B), § 246-262-130, filed 12/23/91, effective 1/23/92. Statutory Authority: RCW 43.20.050. 91-02-051 (Order 124B), recodified as § 246-262-130, filed 12/27/90, effective 1/31/91. Statutory Authority: Chapter 34.05 RCW and RCW 70.90.120. 90-06-049 (Order 040), § 248-97-135, filed 3/2/90, effective 3/2/90.]

**WAC 246-262-140 Insurance.** (1) As a condition of obtaining and maintaining a valid operating permit, owners shall provide evidence of having liability insurance.

(2) The minimum amount of liability insurance required shall be one hundred thousand dollars combined single limit. The coverage for this insurance shall include:

(a) Bodily injury or death of one or more persons in any one incident from the use of the RWCF.

(b) Tail coverage shall be required twenty-four months beyond the insured period on a "claims made" form of insurance.

(3) A certificate of insurance shall be provided to the department or local health officer at the time of application for operating permit subject to the approval of the risk manager of the state of Washington.

(4) The liability insurance company shall provide the department or local health officer a thirty-day prior notice of cancellation, alteration, or nonrenewal. This condition shall be stated in the certificate.

(5) If the owner's insurance is cancelled, the operating permit is void and the owner shall cease operation of the

RWCF until required insurance is obtained and a valid operating permit is reinstated by the department or local health officer.

[Statutory Authority: RCW 43.20.050. 91-02-051 (Order 124B), recodified as § 246-262-140, filed 12/27/90, effective 1/31/91. Statutory Authority: RCW 70.90.120. 88-13-125 (Order 311), § 248-97-140, filed 6/22/88.]

**WAC 246-262-150 Compliance.** Existing RWCFs not complying with the design, construction, and equipment requirements outlined in WAC 246-202-060 and 246-262-070 of these regulations may continue in use, provided the facility is operated in continuous compliance of the safety, sanitation, and water quality provisions of chapter 246-292 WAC as outlined in WAC 246-262-050, 246-262-080, 246-262-090, and 246-262-140.

[Statutory Authority: RCW 70.90.120. 92-02-020 (Order 226B), § 246-262-150, filed 12/23/91, effective 1/23/92. Statutory Authority: RCW 43.20.050. 91-02-051 (Order 124B), recodified as § 246-262-150, filed 12/27/90, effective 1/31/91. Statutory Authority: RCW 70.90.120. 88-13-125 (Order 311), § 248-97-150, filed 6/22/88.]

**WAC 246-262-160 Variance.** The board may grant a variance from requirements of chapter 246-262 WAC if, in the sole discretion of the board, data and/or research provides sufficient evidence that the RWCF (attraction, device, equipment, procedure, etc.), will adequately protect public health and safety, as well as water quality.

[Statutory Authority: RCW 70.90.120. 92-02-020 (Order 226B), § 246-262-160, filed 12/23/91, effective 1/23/92. Statutory Authority: RCW 43.20.050. 91-02-051 (Order 124B), recodified as § 246-262-160, filed 12/27/90, effective 1/31/91. Statutory Authority: RCW 70.90.120. 88-13-125 (Order 311), § 248-97-160, filed 6/22/88.]

**WAC 246-262-170 Innovations—Substitutions.** The board authorizes the department:

(1) To review new innovations, and if accepted for use, prepare appropriate amendments to chapter 246-262 WAC.

(2) To allow substitution of equipment, facilities, or procedures required by chapter 246-262 WAC when, in the sole discretion of the department, data and/or research provide sufficient evidence that such substitution is equivalent to the requirement and will adequately provide for the protection of the public health and safety of persons using the RWCF.

[Statutory Authority: RCW 70.90.120. 92-02-020 (Order 226B), § 246-262-170, filed 12/23/91, effective 1/23/92. Statutory Authority: RCW 43.20.050. 91-02-051 (Order 124B), recodified as § 246-262-170, filed 12/27/90, effective 1/31/91. Statutory Authority: RCW 70.90.120. 88-13-125 (Order 311), § 248-97-170, filed 6/22/88.]

**WAC 246-262-990 Fees.** (1) The fee for plan review of a new recreational water contact facility containing a single attraction shall be two hundred dollars plus the safety engineer reviewer's cost as billed.

(2) The fee for plan review of a new recreational water contact facility containing more than one attraction shall be two hundred dollars plus the cost of the safety engineer reviewer's cost as billed plus seventy-five dollars for each attraction.

(3) The fee for review of plans for alterations or modifications of an existing recreational water contact

facility shall be the total of direct and indirect costs, not to exceed one-half of the fee for review of a new project.

(4) The annual fee for an operating permit for a recreational water contact facility containing one attraction shall be one hundred seventy-five dollars.

(5) The annual fee for an operating permit for a recreational water contact facility containing more than one attraction shall be one hundred seventy-five dollars for the first attraction plus fifty dollars for each additional attraction up to a maximum fee of three hundred twenty-five dollars.

(6) The department may charge an additional fee of fifty dollars plus associated laboratory costs for inspections beyond those provided under the annual operating permit when necessary due to violations of such items as:

- (a) Noncompliance with water quality standards; and
- (b) Failure to comply with operational requirements for health and safety.

[Statutory Authority: RCW 43.70.040. 91-02-050 (Order 122), § 246-262-990, filed 12/27/90, effective 1/31/91.]

## Chapter 246-270 WAC

### SEWER SYSTEMS—CERTIFICATION OF NECESSITY FOR WATER DISTRICT INVOLVEMENT

#### WAC

246-270-001	Purpose.
246-270-010	Definitions.
246-270-020	Application content.
246-270-030	Notification of interested parties.
246-270-040	Criteria for necessity.
246-270-050	Notice of decision—Adjudicative proceeding.
246-270-060	Limitation of an approval and a certification of necessity.
246-270-990	Fees.

**WAC 246-270-001 Purpose.** This regulation prescribes the procedure whereby a water district organized under the provisions of chapter 57.04 RCW may apply for and receive an approval and a certification of necessity from the department in accordance with the provisions of RCW 57.08.065 in order to exercise powers of a sewer district in accordance with the provisions of Title 56 RCW, as now, or hereafter amended. Additionally, this regulation will define the criteria which the department will consider in determining the eligibility of an applicant water district for an approval and a certification of necessity.

[Statutory Authority: RCW 43.20.050. 91-02-051 (Order 124B), recodified as § 246-270-001, filed 12/27/90, effective 1/31/91; Order 6, § 248-91-020, filed 10/16/68; Emergency Order 3, § 248-91-020, filed 8/2/68.]

**WAC 246-270-010 Definitions.** For purposes of this chapter, the following definitions are applicable:

(1) "Approval and a certification of necessity" shall mean an order of the department which gives approval to a water district to establish, maintain, construct and operate a sewer system in a proposed service area in accordance with RCW 57.08.065.

(2) "Board" shall mean the Washington state board of health.

(3) "Department" shall mean the Washington state department of health.

(4) "Drainage basin" shall mean a geographic area drained by a surface stream or body of impounded water together with all tributary surface streams and bodies of impounded surface water.

(5) "Industrial wastes" shall mean the liquids, solids, or other wastes resulting from any process of industry, or from the development of any natural resource.

(6) "Necessity" shall mean a reasonable need and not mean an indispensable need.

(7) "Proposed service area" shall mean the area proposed to be served with a sewer system by the applicant water district.

(8) "Sewage" shall mean the water-carried waste products or discharge from human beings or other wastes from residences, public or private buildings, or industrial plants, together with such ground, surface or storm waters as may be present.

(9) "Sewer entities" shall mean any municipal or public corporations which by law are entitled to construct and operate a sewer system.

(10) "Sewer system" shall mean a system of sewers and appurtenances for the collection, transportation, treatment and disposal of sewage and industrial wastes.

[Statutory Authority: RCW 43.70.040 and 57.08.065. 92-02-018 (Order 224), § 246-270-010, filed 12/23/91, effective 1/23/92. Statutory Authority: RCW 43.20.050. 91-02-051 (Order 124B), recodified as § 246-270-010, filed 12/27/90, effective 1/31/91; Order 6, § 248-91-010, filed 10/16/68; Emergency Order 3, § 248-91-010, filed 8/2/68.]

**WAC 246-270-020 Application content.** An application for an approval and a certification of necessity must be presented to the department and shall include, but not be limited to, the following considerations:

(1) A general statement of the present and future sewage problems in the proposed area of service.

(2) A consideration of the relationship of the district to contiguous, nearby or overlapping sewer entities.

(3) Service areas considering reasonable drainage basin oriented planning.

(4) Population forecasts as a basis of sewer system design in the proposed service area.

(5) A layout map showing major trunk lines and interceptor lines including the drainage area to be served within and outside of the boundaries of the water district.

(6) The methods of interception and disposal of sewage.

(7) The projected completion time for the sewer system.

(8) An affidavit signed by an officer of the applicant water district, stating that all persons, parties or entities have been given the notice required by WAC 246-270-030.

(9) A summary setting forth the reasons why the applicant water district is better suited to provide a sewer system within the proposed service area than a contiguous or adjacent sewer entity.

[Statutory Authority: RCW 43.70.040 and 57.08.065. 92-02-018 (Order 224), § 246-270-020, filed 12/23/91, effective 1/23/92. Statutory Authority: RCW 43.20.050. 91-02-051 (Order 124B), recodified as § 246-270-020, filed 12/27/90, effective 1/31/91; Order 6, § 248-91-030, filed 10/16/68; Emergency Order 3, § 248-91-030, filed 8/2/68.]

**WAC 246-270-030 Notification of interested parties.** Prior to the submission of an application to the department

for an approval and a certification of necessity, an applicant water district shall:

(1) Notify all the contiguous and affected sewer entities in the area in which the water district is proposing to construct and operate a sewer system that the applicant water district will submit an application for an approval and a certification of necessity, and that the department will consider all written comments and objections submitted to the department from any contiguous and affected sewer entity if the same written comments and objections are received by the department before a date which will be specified by the department.

(2) Notify the county commissioners, county health officer, county engineer, county planning commission and the county boundary review board, if any, in the county of the proposed service area, that the applicant water district will submit an application for an approval and certification of necessity and the department will consider all written comments and objections submitted to the department by any of the same if the written comments and objections are received by the department before a date which will be specified by the department.

(3) The dates for inclusion in the notification provided for in paragraphs (1) and (2) hereof will be furnished by the department upon the request of any applicant water district to the department.

[Statutory Authority: RCW 43.20.050. 91-02-051 (Order 124B), recodified as § 246-270-030, filed 12/27/90, effective 1/31/91; Order 6, § 248-91-040, filed 10/16/68; Emergency Order 3, § 248-91-040, filed 8/2/68.]

**WAC 246-270-040 Criteria for necessity.** The department will issue an approval and a certification of necessity to an applicant water district if all of the following conditions are satisfied:

(1) The granting of an approval and a certification of necessity will eliminate or alleviate an existing or imminent health problem as determined by the department.

(2) A sewer system does not exist in a substantial portion of the proposed service area and no regularly constituted and established sewer entity intends to construct and operate a sewer system in a substantial portion of the proposed service area within the reasonably foreseeable future.

(3) The proposed service area conforms to any or all established sewage drainage basins designated pursuant to RCW 90.48.270.

(4) The proposed service area conforms to any or all established comprehensive plans for sewage drainage basins, established pursuant to RCW 90.48.280.

[Statutory Authority: RCW 43.20.050. 91-02-051 (Order 124B), recodified as § 246-270-040, filed 12/27/90, effective 1/31/91; Order 6, § 248-91-050, filed 10/16/68; Emergency Order 3, § 248-91-050, filed 8/2/68.]

**WAC 246-270-050 Notice of decision—Adjudicative proceeding.** (1) The department's notice of a denial, suspension, modification, or revocation of an approval and certificate of necessity shall be consistent with RCW 43.70.115. An applicant or certificate holder has the right to an adjudicative proceeding to contest the decision.

(2) A certificate applicant or holder contesting a department certificate decision shall within twenty-eight days of receipt of the decision:

(a) File a written application for an adjudicative proceeding by a method showing proof of receipt with the Administrative Hearings Unit, Department of Health, 1300 Quince Street S.E., P.O. Box 47851, Olympia, WA 98504-7851; and

(b) Include in or with the application:

(i) A specific statement of the issue or issues and law involved;

(ii) The grounds for contesting the department decision; and

(iii) A copy of the contested department decision.

(3) The proceeding is governed by the Administrative Procedure Act (chapter 34.05 RCW), this chapter, and chapter 246-08 WAC. If a provision in this chapter conflicts with chapter 246-08 WAC, the provision in this chapter governs.

[Statutory Authority: RCW 43.70.040, 34.05.220 and 57.08.065. 92-02-018 (Order 224), § 246-270-050, filed 12/23/91, effective 1/23/92. Statutory Authority: RCW 43.20.050. 91-02-051 (Order 124B), recodified as § 246-270-050, filed 12/27/90, effective 1/31/91. Statutory Authority: Chapter 34.05 RCW, RCW 34.05.220 (1)(a) and 1st ex.s. c 9 § 106. 90-06-019 (Order 039), § 248-91-060, filed 2/28/90, effective 3/1/90; Order 6, § 248-91-060, filed 10/16/68; Emergency Order 3, § 248-91-060, filed 8/2/68.]

**WAC 246-270-060 Limitation of an approval and a certification of necessity.** The granting of an approval and a certification of necessity by the department shall only constitute approval to establish, maintain, construct, and operate a sewer system within the proposed service area requested in the initial application for an approval and a certification of necessity, and shall in no way constitute approval or authority to establish, maintain, construct and operate a sewer system in any area which may be annexed at some future time by the applicant water district.

The granting of an approval and a certification of necessity by the department does not constitute approval of the engineering report or plans and specifications of any sewer system, and all plans and specifications and the proposed method of operation and maintenance for any sewer system must be approved by the department pursuant to WAC 246-271-050.

[Statutory Authority: RCW 43.70.040 and 57.08.065. 92-02-018 (Order 224), § 246-270-060, filed 12/23/91, effective 1/23/92. Statutory Authority: RCW 43.20.050. 91-02-051 (Order 124B), recodified as § 246-270-060, filed 12/27/90, effective 1/31/91; Order 6, § 248-91-070, filed 10/16/68.]

**WAC 246-270-990 Fees.** The minimum fee for required written approval and certification of necessity shall be two hundred dollars. If review time exceeds four hours, fifty dollars for each additional hour or part of an hour shall be added to the minimum fee.

[Statutory Authority: RCW 43.70.040. 91-02-050 (Order 122), § 246-270-990, filed 12/27/90, effective 1/31/91.]

## Chapter 246-271 WAC PUBLIC SEWAGE

### WAC

246-271-010	Definitions.
246-271-020	Prohibited methods of sewage disposal.
246-271-030	Investigative and order powers of secretary.
246-271-040	Plans for sewage systems.
246-271-050	Plans for sewage treatment works.
246-271-060	Plans for sewage treatment works—Requirements for engineers.
246-271-070	Operation of sewage treatment plants—Efficiency.
246-271-080	Operation of sewage treatment plants—Freedom from sand and silt.
246-271-090	Operation of sewage treatment plants—Disinfection.
246-271-100	Irrigation with sewage.
246-271-110	Use of sewage sludge for fertilizer.
246-271-120	Adoption of appendix details as rules.
246-271-130	Appendix—Definitions.
246-271-140	Appendix—Report—Sewage system.
246-271-150	Appendix—General layout map.
246-271-160	Appendix—Plot plan.
246-271-170	Appendix—Engineering report—Sewage treatment works.
246-271-180	Appendix—Preliminary report, industrial waste treatment works.
246-271-990	Fees.

**WAC 246-271-010 Definitions.** For the purpose of these rules and regulations, the terms shall have the meaning as defined in the appendix.

[Statutory Authority: RCW 43.20.050. 91-02-051 (Order 124B), recodified as § 246-271-010, filed 12/27/90, effective 1/31/91; Regulation .92.001, effective 3/11/60.]

**WAC 246-271-020 Prohibited methods of sewage disposal.** No sewage or industrial waste, or components thereof, shall be placed or permitted to be placed, or permitted to flow onto the surface of the ground, or into any waters of the state in any manner determined by the secretary to be prejudicially affecting a domestic water supply, or otherwise endangering the health and well-being of the people of the state.

[Statutory Authority: RCW 43.20.050. 92-02-019 (Order 225B), § 246-271-020, filed 12/23/91, effective 1/23/92; 91-02-051 (Order 124B), recodified as § 246-271-020, filed 12/27/90, effective 1/31/91; Regulation .92.010, effective 3/11/60.]

**WAC 246-271-030 Investigative and order powers of secretary.** The secretary shall investigate the methods of sewage and industrial waste disposal and if such may endanger a domestic water supply, or in any other way endanger the health or well-being of the people of the state, the secretary shall issue and enforce such orders as may be necessary to correct the condition.

[Statutory Authority: RCW 43.20.050. 92-02-019 (Order 225B), § 246-271-030, filed 12/23/91, effective 1/23/92; 91-02-051 (Order 124B), recodified as § 246-271-030, filed 12/27/90, effective 1/31/91; Regulation .92.020, effective 3/11/60.]

**WAC 246-271-040 Plans for sewage systems.** Report, general layout map and specifications - Every owner or authorized representative shall make a comprehensive study of the proposed sewage system and prepare and submit to the department a copy of a report, a general layout map and general construction specifications of the proposed



public sewage system. Written approval of this report, general layout map and general construction specifications shall be obtained from the department before any further construction, alterations or additions are made to the system or, in case of a new system, before such system is constructed except as provided in subsection (1) of this section. After such approval has been received the owner shall not be required to submit any further plans and specifications for any part of the sewage system covered by the general layout map except as required by subsections (2), (3), and (4) of this section, but the owner shall notify the department of any portion of the system to be constructed and indicate its position on the approved general layout map. (The specifications may be submitted at the time of notification of construction.) The report and general layout map shall include but not be limited to the items listed under those headings in the appendix.

(1) In lieu of an approved report, general layout map, and specifications, any owner or authorized representative shall submit a copy of a report, a plot plan, and specifications of each new sewage system or alterations or additions to any existing sewage system and receive written approval before construction is started. The report and plot plan shall include but not be limited to those items listed in the appendix.

(2) Whether or not a report and general layout map have been approved, if the system does not include adequate sewage treatment works as determined by the department, written approval for the construction of each addition or alteration of the sewage system must be obtained from the department before construction is started.

(3) In case an addition is to be made to a sewage system and this addition is not a part of an approved general layout map, the owner shall submit a copy of a revised general layout map or a plot plan of the area to the department and receive written approval before construction is started.

(4) Every owner shall submit a set of detailed plans and specifications of all overflow or bypass structures, pipe outlets and pumping stations with overflow structures, showing the quantities of flow for which they are designed and shall receive written approval from the department before construction is started.

[Statutory Authority: RCW 43.20.050. 92-02-019 (Order 225B), § 246-271-040, filed 12/23/91, effective 1/23/92; 91-02-051 (Order 124B), recodified as § 246-271-040, filed 12/27/90, effective 1/31/91; Regulation .92.030, effective 3/11/60.]

**WAC 246-271-050 Plans for sewage treatment works. Engineering report of sewage treatment works -** Before detailed plans and specifications for new sewage treatment works or major extensions, alterations or improvements to existing sewage treatment works are prepared, every owner or authorized agent shall submit one copy of a preliminary engineering report to the department and receive written approval. This report shall include the items listed under "scope of the engineering report" in the appendix.

[Statutory Authority: RCW 43.20.050. 92-02-019 (Order 225B), § 246-271-050, filed 12/23/91, effective 1/23/92; 91-02-051 (Order 124B), recodified as § 246-271-050, filed 12/27/90, effective 1/31/91; Order 72, § 248-92-040, filed 4/11/72; Regulation .92.040, effective 3/11/60.]

**WAC 246-271-060 Plans for sewage treatment works—Requirements for engineers.** All plans for new sewage treatment plants, major changes or additions to existing systems or plants shall be prepared under the supervision of a professional engineer licensed in accordance with chapter 283, Laws of 1947 (chapter 18.43 RCW). All copies of plans submitted to the department for review shall bear the seal of the professional engineer under whose supervision they have been prepared.

[Statutory Authority: RCW 43.20.050. 92-02-019 (Order 225B), § 246-271-060, filed 12/23/91, effective 1/23/92; 91-02-051 (Order 124B), recodified as § 246-271-060, filed 12/27/90, effective 1/31/91; Regulation .92.050, effective 3/11/60.]

**WAC 246-271-070 Operation of sewage treatment plants—Efficiency.** (1) **Efficient operation -** All sewage treatment plants shall be operated at their highest practical efficiency at all times. If, after investigation by the department, it is determined that any sewage treatment works is, because of defective design, inadequacy, incompetent supervision or inefficient operation, causing unsatisfactory conditions in the waters into which the effluent is discharged or otherwise interfering with the legitimate uses of such waters or causes a menace to public health, the owner shall make such changes in the plant or its operation as are necessary to produce satisfactory results. These changes shall be made within such time limits as are set by the department.

(2) **Records -** The owner shall make such tests and keep such records as are necessary to assure the effective operation of the sewage treatment works, and such records shall be made available to the department.

[Statutory Authority: RCW 43.20.050. 92-02-019 (Order 225B), § 246-271-070, filed 12/23/91, effective 1/23/92; 91-02-051 (Order 124B), recodified as § 246-271-070, filed 12/27/90, effective 1/31/91; Regulation .92.060, effective 3/11/60.]

**WAC 246-271-080 Operation of sewage treatment plants—Freedom from sand and silt.** All sewage systems shall be kept free from obstructions and deposits of sand and silt. All pumping stations in the sewage system shall be effectively maintained to insure continuous operation.

[Statutory Authority: RCW 43.20.050. 92-02-019 (Order 225B), § 246-271-080, filed 12/23/91, effective 1/23/92; 91-02-051 (Order 124B), recodified as § 246-271-080, filed 12/27/90, effective 1/31/91; Regulation .92.070, effective 3/11/60.]

**WAC 246-271-090 Operation of sewage treatment plants—Disinfection.** Effective disinfection of sewage discharges shall be provided in accordance with the determination of the department. If at any time effective disinfection cannot be accomplished due to the breakdown of equipment or the need for bypassing raw or partially treated sewage, or any other reason, the owner shall immediately notify the department by telephone or by facsimile machine.

[Statutory Authority: RCW 43.20.050. 92-02-019 (Order 225B), § 246-271-090, filed 12/23/91, effective 1/23/92; 91-02-051 (Order 124B), recodified as § 246-271-090, filed 12/27/90, effective 1/31/91; Regulation .92.080, effective 3/11/60.]

**WAC 246-271-100 Irrigation with sewage.** Raw sewage, or treatment plant effluent, shall not be used for



irrigation, except under conditions as may be prescribed by the department.

[Statutory Authority: RCW 43.20.050. 92-02-019 (Order 225B), § 246-271-100, filed 12/23/91, effective 1/23/92; 91-02-051 (Order 124B), recodified as § 246-271-100, filed 12/27/90, effective 1/31/91; Regulation .92.090, effective 3/11/60.]

**WAC 246-271-110 Use of sewage sludge for fertilizer.** The use of sewage sludge for fertilizing material shall be in compliance with the limitations and procedures as may be prescribed by the department; and the owner shall notify the department of any intended use of sludge as a fertilizing material.

[Statutory Authority: RCW 43.20.050. 92-02-019 (Order 225B), § 246-271-110, filed 12/23/91, effective 1/23/92; 91-02-051 (Order 124B), recodified as § 246-271-110, filed 12/27/90, effective 1/31/91; Regulation .92.100, effective 3/11/60.]

**WAC 246-271-120 Adoption of appendix details as rules.** This appendix contains details referred to in the rules and regulations and is adopted as a part of these rules and regulations.

[Statutory Authority: RCW 43.20.050. 91-02-051 (Order 124B), recodified as § 246-271-120, filed 12/27/90, effective 1/31/91; Appendix to Public Sewage Rules, effective 3/11/60.]

**WAC 246-271-130 Appendix—Definitions.** (1) "Department" - Washington state department of health.

(2) "Detailed plans" of sewage systems - Plans used for the construction of any sewer or sewer system.

(3) "Final plans" of sewage treatment works - Plans used for the construction of any sewage treatment works.

(4) "Industrial wastes" - The liquids, solids, or other wastes resulting from any process of industry, or from the development of any natural resource.

(5) "Industrial waste treatment works" - An arrangement of devices and structures for treating industrial wastes.

(6) "Owner" - The state, county, city, town, village, corporation, firm, company, institution, person or persons owning or operating any sewage system, sewage treatment plant, or industrial waste disposal system or treatment plant.

(7) "Pipe outlet" - A pipe line which conveys the effluent from a reservoir, sewage treatment plant, or other structure to its point of discharge.

(8) "Pumping station" - A station housing sewage pumps, and their appurtenances.

(9) "Secretary" - Secretary of the Washington state department of health or the secretary's authorized designee.

(10) "Sewage" - The water-carried waste products or discharge from human beings or other wastes from residences, public or private buildings, together with such ground, surface or storm water as may be present.

(11) "Sewage system" - A system of sewers and appurtenances for the collection, transportation, and pumping of sewage and industrial wastes.

(12) "Sewage treatment works" - An arrangement of devices and structures for treating sewage, industrial wastes, and sludge. Sometimes used as synonymous with sewage treatment plant.

(13) "Sewage works" - A comprehensive term which includes facilities for collecting, pumping, treating, and

disposing of sewage; the sewage system and the sewage treatment works.

(14) "Sewer" - A pipe or conduit; generally closed, but normally not flowing full, for carrying sewage and other waste liquids.

(15) "Sewer outlet" - The point of final discharge of sewage or treatment plant effluent.

[Statutory Authority: RCW 43.20.050. 92-02-019 (Order 225B), § 246-271-130, filed 12/23/91, effective 1/23/92; 91-02-051 (Order 124B), recodified as § 246-271-130, filed 12/27/90, effective 1/31/91; Public Sewage Appendix, effective 3/11/60.]

**WAC 246-271-140 Appendix—Report—Sewage system.** The "report" shall include: -

(1) A description of the nature and extent of the area included in the present system (if any) and the area and extent to which plans provide sewage works for future development.

(2) The population trend and an estimate of future population to be served.

(3) A statement regarding the present and expected future quantity and character of sewage, including any industrial wastes which may be present or expected in the sewage system.

(4) A discussion of limitations placed on infiltration and the infiltration problem.

(5) A statement regarding provisions for treatment.

[Statutory Authority: RCW 43.20.050. 92-02-019 (Order 225B), § 246-271-140, filed 12/23/91, effective 1/23/92; 91-02-051 (Order 124B), recodified as § 246-271-140, filed 12/27/90, effective 1/31/91; Public Sewage Appendix, effective 3/11/60.]

**WAC 246-271-150 Appendix—General layout map.** The general layout map shall include the following items:

(1) **Boundaries** - The boundary lines of the municipality or sewer district to be seweraged.

(2) **Existing sewers** - The location, size and direction of flow of all existing sanitary or combined trunk sewers and the boundaries of the areas served by each.

(3) **Proposed sewers** - The location, size and direction of flow of all proposed trunk sewers and the boundaries of the areas to be served by each.

(4) **Existing and proposed pump stations** - Location of all existing and proposed pumping stations designated to distinguish between those existing and proposed.

(5) **Topography and elevations** - Topography showing pertinent ground elevations and including existing and proposed streets, if such information is available.

(6) **Streams, lakes and other bodies of water** - The location and direction of flow of major streams and the high and low elevations of all water surfaces at sewer outlets and overflows.

(7) **Public water supplies** - The location of wells or other sources of public water supply, water storage reservoirs, and other structures of public health significance.

[Statutory Authority: RCW 43.20.050. 91-02-051 (Order 124B), recodified as § 246-271-150, filed 12/27/90, effective 1/31/91; Public Sewage Appendix, effective 3/11/60.]

**WAC 246-271-160 Appendix—Plot plan.** The plot plan shall include: -

(1) **Boundaries** - The boundary lines of the area involved.

(2) **Sewer lines** - All sewer lines and their tie-in with the existing system.

(3) **Other data** - Elevations, slopes, pipe sizes, and manhole spacings.

(4) **Public water supplies** - The location of wells or other sources of public water supply, water storage reservoirs, and other structures of public health significance.

[Statutory Authority: RCW 43.20.050, 91-02-051 (Order 124B), recodified as § 246-271-160, filed 12/27/90, effective 1/31/91; Public Sewage Appendix, effective 3/11/60.]

**WAC 246-271-170 Appendix—Engineering report—Sewage treatment works.** The engineering report for the sewage treatment works shall include the following items together with any other relevant data -

(1) The purpose and need for the proposed project.

(2) The nature and extent of the area included in the present system and the area and extent to which plans provide sewage works for future development. If the area to be served by existing and proposed sewers does not include the entire municipality, sewer district, or natural drainage area, give a brief description of that portion not included, together with information as to the probability of future development, and the method by which this area can be served by treatment works.

(3) The population trend as indicated by available records, and give the estimated future population for the design period. Describe briefly the method used to determine future population trends.

(4) Any existing sewage treatment works as they are related to the proposed project.

(5) Discuss the location of water supply and distribution structures as they relate to the various portions of the proposed sewage works.

(6) The considerations given to possibility of garbage disposal in sewage works.

(7) List of all establishments producing appreciable quantities of industrial wastes and the quantity, production periods, and character of industrial wastes in so far as they may affect the sewerage system or sewage treatment works. Consideration shall be given to future industrial expansion.

(8) The degree of treatment proposed based upon the size, usage and character of the receiving body of water and upon the amount and strength of sewage or waste to be treated and other influencing factors.

(9) The type or types of treatment process proposed based upon the character of sewage or waste to be handled and the degree of treatment required.

(10) Data on the volume and strength of sewage and the design data regarding flow and strength.

(11) The ratio of interception in connection with existing combined sewers, and the quantity expected to be bypassed during storms.

(12) The basic design data of each unit of the treatment works.

(13) Provision for future needs.

(14) Discussion of the various sites available and the advantages of the one recommended. The proximity of residences or developed areas to any treatment works. The

relationship of maximum high water to the plant site and various plant units.

(15) Expected efficiencies of each unit and the entire plant, and the character of effluent expected.

(16) A flow diagram showing general layout of various units.

[Statutory Authority: RCW 43.20.050, 91-02-051 (Order 124B), recodified as § 246-271-170, filed 12/27/90, effective 1/31/91; Public Sewage Appendix, effective 3/11/60.]

**WAC 246-271-180 Appendix—Preliminary report, industrial waste treatment works.** The preliminary report on industrial waste disposal or treatment facilities shall include the following items where pertinent -

(1) Type of industry.

(2) Kind and quantity of finished products.

(3) The amount of process waste and its sources.

(4) The quantity of unpolluted water, such as cooling water, etc., and the provision for segregation for separate discharge.

(5) Description of the waste, including if possible a chemical analysis.

(6) The amount and kind of chemicals used in the process, if any.

(7) The basic design data of the treatment units.

(8) All necessary maps and layout sketches, including any flow diagrams.

(9) Results to be expected from the treatment process.

(10) All data necessary to indicate the location of the outlet pipe and method of diffusing the waste into the receiving water.

(11) If any domestic sewage is to be disposed of through the system, a brief description in compliance with the provisions of WAC 246-271-030 should be included.

[Statutory Authority: RCW 43.20.050, 92-02-019 (Order 225B), § 246-271-180, filed 12/23/91, effective 1/23/92; 91-02-051 (Order 124B), recodified as § 246-271-180, filed 12/27/90, effective 1/31/91; Public Sewage Appendix, effective 3/11/60.]

**WAC 246-271-990 Fees.** (1) The minimum fee for required review of land application of municipal wastewater shall be two hundred dollars. If review time exceeds four hours, fifty dollars for each additional hour or part of an hour shall be added to the minimum fee.

(2) The minimum fee for required review of comprehensive sewer plans shall be two hundred dollars. If review time exceeds four hours, fifty dollars for each additional hour or part of an hour shall be added to the minimum fee.

[Statutory Authority: RCW 43.70.040, 91-02-050 (Order 122), § 246-271-990, filed 12/27/90, effective 1/31/91.]

## Chapter 246-272 WAC

### ON-SITE SEWAGE SYSTEMS

#### WAC

246-272-00101	Purpose, objectives, and authority.
246-272-00501	Administration.
246-272-01001	Definitions.
246-272-02001	Local regulation.
246-272-03001	Applicability.
246-272-04001	Alternative systems and proprietary devices.
246-272-05001	Experimental systems.

246-272-07001	Connection to public sewer system.	
246-272-08001	Large on-site sewage systems (LOSS).	
246-272-09001	Permits for OSS under three thousand five hundred gallons per day.	
246-272-09501	Location.	246-272-040
246-272-11001	Soil and site evaluation.	
246-272-11501	Design.	
246-272-12501	Holding tank sewage systems.	
246-272-13501	Installation.	
246-272-14501	Inspection.	
246-272-15501	Operation and maintenance.	
246-272-16501	Repair of failures.	
246-272-17501	Expansions.	
246-272-18501	Abandonment.	246-272-050
246-272-19501	Septage management.	
246-272-20501	Developments, subdivisions, and minimum land area requirements.	
246-272-21501	Areas of special concern.	
246-272-22501	Certification of designers, installers, pumpers, inspectors, and maintenance personnel.	246-272-060
246-272-23501	Technical review committee.	
246-272-24001	State advisory committee.	
246-272-25001	Waiver of state regulations.	
246-272-26001	Enforcement.	
246-272-27001	Notice of decision—Adjudicative proceeding.	
246-272-28001	Severability.	
246-272-990	Fees.	246-272-070

**DISPOSITION OF SECTIONS FORMERLY  
CODIFIED IN THIS CHAPTER**

246-272-001	Authority. [Statutory Authority: RCW 43.20.050. 91-02-051 (Order 124B), recodified as § 246-272-001, filed 12/27/90, effective 1/31/91; 83-13-014 (Order 259), § 248-96-010, filed 6/3/83; Order 101, § 248-96-010, filed 6/10/74.] Repealed by 94-09-025, filed 4/15/94, effective 1/1/95. Statutory Authority: RCW 43.20.050.	246-272-080
246-272-002	Purpose and objectives. [Statutory Authority: RCW 43.20.050. 91-02-051 (Order 124B), recodified as § 246-272-002, filed 12/27/90, effective 1/31/91; 83-13-014 (Order 259), § 248-96-011, filed 6/3/83; Order 101, § 248-96-011, filed 6/10/74.] Repealed by 94-09-025, filed 4/15/94, effective 1/1/95. Statutory Authority: RCW 43.20.050.	
246-272-005	Administration. [Statutory Authority: RCW 43.20.050. 91-02-051 (Order 124B), recodified as § 246-272-005, filed 12/27/90, effective 1/31/91; 83-13-014 (Order 259), § 248-96-018, filed 6/3/83; Order 101, § 248-96-018, filed 6/10/74.] Repealed by 94-09-025, filed 4/15/94, effective 1/1/95. Statutory Authority: RCW 43.20.050.	246-272-090
246-272-010	Definitions. [Statutory Authority: RCW 43.20.050. 92-02-019 (Order 225B), § 246-272-010, filed 12/23/91, effective 1/23/92; 91-02-051 (Order 124B), recodified as § 246-272-010, filed 12/27/90, effective 1/31/91. Statutory Authority: 1989 c 349. 89-21-026 (Order 332), § 248-96-020, filed 10/10/89, effective 11/10/89. Statutory Authority: RCW 43.20.050. 83-13-014 (Order 259), § 248-96-020, filed 6/3/83; 81-05-028 (Order 208), § 248-96-020, filed 2/18/81; 80-04-038 (Order 196), § 248-96-020, filed 3/20/80; Order 101, § 248-96-020, filed 6/10/74.] Repealed by 94-09-025, filed 4/15/94, effective 1/1/95. Statutory Authority: RCW 43.20.050.	246-272-100
246-272-020	Local regulation. [Statutory Authority: RCW 43.20.050. 92-02-019 (Order 225B), § 246-272-020, filed 12/23/91, effective 1/23/92; 91-02-051 (Order 124B), recodified as § 246-272-020, filed 12/27/90, effective 1/31/91; 83-13-014 (Order 259), § 248-96-025, filed 6/3/83.] Repealed by 94-09-025, filed 4/15/94, effective 1/1/95. Statutory Authority: RCW 43.20.050.	246-272-110
246-272-030	Applicability. [Statutory Authority: RCW 43.20.050. 92-02-019 (Order 225B), § 246-272-030, filed 12/23/91, effective 1/23/92; 91-02-051 (Order 124B), recodified as § 246-272-030, filed 12/27/90, effective 1/31/91. Statutory Authority: 1989 c 349. 89-21-026 (Order 332), § 248-96-040, filed 10/10/89, effective 11/10/89. Statutory Authority: RCW 43.20.050. 83-13-014 (Order 259), §	246-272-120
		248-96-040, filed 6/3/83; 80-04-038 (Order 196), § 248-96-040, filed 3/20/80; Order 101, § 248-96-040, filed 6/10/74.] Repealed by 94-09-025, filed 4/15/94, effective 1/1/95. Statutory Authority: RCW 43.20.050.
		Alternative systems. [Statutory Authority: RCW 43.20.050. 91-02-051 (Order 124B), recodified as § 246-272-040, filed 12/27/90, effective 1/31/91. Statutory Authority: 1989 c 349. 89-21-026 (Order 332), § 248-96-046, filed 10/10/89, effective 11/10/89. Statutory Authority: RCW 43.20.050. 83-13-014 (Order 259), § 248-96-046, filed 6/3/83; Order 101, § 248-96-046, filed 6/10/74.] Repealed by 94-09-025, filed 4/15/94, effective 1/1/95. Statutory Authority: RCW 43.20.050.
		Experimental systems. [Statutory Authority: RCW 43.20.050. 91-02-051 (Order 124B), recodified as § 246-272-050, filed 12/27/90, effective 1/31/91; 83-13-014 (Order 259), § 248-96-047, filed 6/3/83.] Repealed by 94-09-025, filed 4/15/94, effective 1/1/95. Statutory Authority: RCW 43.20.050.
		No surface discharge. [Statutory Authority: RCW 43.20.050. 92-02-019 (Order 225B), § 246-272-060, filed 12/23/91, effective 1/23/92; 91-02-051 (Order 124B), recodified as § 246-272-060, filed 12/27/90, effective 1/31/91; 83-13-014 (Order 259), § 248-96-050, filed 6/3/83; Order 101, § 248-96-050, filed 6/10/74.] Repealed by 94-09-025, filed 4/15/94, effective 1/1/95. Statutory Authority: RCW 43.20.050.
		Connection to public sewer system. [Statutory Authority: RCW 43.20.050. 91-02-051 (Order 124B), recodified as § 246-272-070, filed 12/27/90, effective 1/31/91. Statutory Authority: 1989 c 349. 89-21-026 (Order 332), § 248-96-060, filed 10/10/89, effective 11/10/89. Statutory Authority: RCW 43.20.050. 83-13-014 (Order 259), § 248-96-060, filed 6/3/83; Order 101, § 248-96-060, filed 6/10/74.] Repealed by 94-09-025, filed 4/15/94, effective 1/1/95. Statutory Authority: RCW 43.20.050.
		Larger on-site sewage systems. [Statutory Authority: RCW 43.20.050. 92-02-019 (Order 225B), § 246-272-080, filed 12/23/91, effective 1/23/92; 91-02-051 (Order 124B), recodified as § 246-272-080, filed 12/27/90, effective 1/31/91; 83-13-014 (Order 259), § 248-96-075, filed 6/3/83; 80-04-038 (Order 196), § 248-96-075, filed 3/20/80; Order 101, § 248-96-075, filed 6/10/74.] Repealed by 94-09-025, filed 4/15/94, effective 1/1/95. Statutory Authority: RCW 43.20.050.
		Permit. [Statutory Authority: RCW 43.20.050. 91-02-051 (Order 124B), recodified as § 246-272-090, filed 12/27/90, effective 1/31/91; 83-13-014 (Order 259), § 248-96-080, filed 6/3/83; 80-04-038 (Order 196), § 248-96-080, filed 3/20/80; Order 101, § 248-96-080, filed 6/10/74.] Repealed by 94-09-025, filed 4/15/94, effective 1/1/95. Statutory Authority: RCW 43.20.050.
		Minimum land area requirement. [Statutory Authority: RCW 43.20.050. 92-02-019 (Order 225B), § 246-272-100, filed 12/23/91, effective 1/23/92; 91-02-051 (Order 124B), recodified as § 246-272-100, filed 12/27/90, effective 1/31/91; 83-13-014 (Order 259), § 248-96-090, filed 6/3/83; Order 101, § 248-96-090, filed 6/10/74.] Repealed by 94-09-025, filed 4/15/94, effective 1/1/95. Statutory Authority: RCW 43.20.050.
		Determination of site characteristics. [Statutory Authority: RCW 43.20.050. 92-02-019 (Order 225B), § 246-272-110, filed 12/23/91, effective 1/23/92; 91-02-051 (Order 124B), recodified as § 246-272-110, filed 12/27/90, effective 1/31/91; 83-13-014 (Order 259), § 248-96-094, filed 6/3/83.] Repealed by 94-09-025, filed 4/15/94, effective 1/1/95. Statutory Authority: RCW 43.20.050.
		Subdivision and individual site review. [Statutory Authority: RCW 43.20.050. 92-02-019 (Order 225B), § 246-272-120, filed 12/23/91, effective 1/23/92; 91-02-051 (Order 124B), recodified as § 246-272-120, filed 12/27/90, effective 1/31/91; 83-13-014 (Order 259), § 248-96-095, filed 6/3/83; Order 101, § 248-96-095, filed 6/10/74.] Repealed by 94-09-025, filed 4/15/94, effective 1/1/95. Statutory Authority: RCW 43.20.050.

- 246-272-130 Larger tract requirements. [Statutory Authority: RCW 43.20.050. 92-02-019 (Order 225B), § 246-272-130, filed 12/23/91, effective 1/23/92; 91-02-051 (Order 124B), recodified as § 246-272-130, filed 12/27/90, effective 1/31/91; 83-13-014 (Order 259), § 248-96-096, filed 6/3/83; Order 101, § 248-96-096, filed 6/10/74.] Repealed by 94-09-025, filed 4/15/94, effective 1/1/95. Statutory Authority: RCW 43.20.050.
- 246-272-140 Location. [Statutory Authority: RCW 43.20.050. 91-02-051 (Order 124B), recodified as § 246-272-140, filed 12/27/90, effective 1/31/91; 83-13-014 (Order 259), § 248-96-100, filed 6/3/83; Order 101, § 248-96-100, filed 6/10/74.] Repealed by 94-09-025, filed 4/15/94, effective 1/1/95. Statutory Authority: RCW 43.20.050.
- 246-272-150 Design. [Statutory Authority: RCW 43.20.050. 92-02-019 (Order 225B), § 246-272-150, filed 12/23/91, effective 1/23/92; 91-02-051 (Order 124B), recodified as § 246-272-150, filed 12/27/90, effective 1/31/91. Statutory Authority: 1989 c 349. 89-21-026 (Order 332), § 248-96-110, filed 10/10/89, effective 11/10/89. Statutory Authority: RCW 43.20.050. 83-13-014 (Order 259), § 248-96-110, filed 6/3/83; Order 101, § 248-96-110, filed 6/10/74.] Repealed by 94-09-025, filed 4/15/94, effective 1/1/95. Statutory Authority: RCW 43.20.050.
- 246-272-160 Repair of failures along marine shorelines. [Statutory Authority: RCW 43.20.050. 92-02-019 (Order 225B), § 246-272-160, filed 12/23/91, effective 1/23/92; 91-02-051 (Order 124B), recodified as § 246-272-160, filed 12/27/90, effective 1/31/91. Statutory Authority: 1989 c 349. 89-21-026 (Order 332), § 248-96-120, filed 10/10/89, effective 11/10/89.] Repealed by 94-09-025, filed 4/15/94, effective 1/1/95. Statutory Authority: RCW 43.20.050.
- 246-272-170 Marine expansions. [Statutory Authority: RCW 43.20.050. 92-02-019 (Order 225B), § 246-272-170, filed 12/23/91, effective 1/23/92; 91-02-051 (Order 124B), recodified as § 246-272-170, filed 12/27/90, effective 1/31/91. Statutory Authority: 1989 c 349. 89-21-026 (Order 332), § 248-96-125, filed 10/10/89, effective 11/10/89.] Repealed by 94-09-025, filed 4/15/94, effective 1/1/95. Statutory Authority: RCW 43.20.050.
- 246-272-180 Designer program. [Statutory Authority: RCW 43.20.050. 91-02-051 (Order 124B), recodified as § 246-272-180, filed 12/27/90, effective 1/31/91; 83-13-014 (Order 259), § 248-96-130, filed 6/3/83; Order 101, § 248-96-130, filed 6/10/74.] Repealed by 94-09-025, filed 4/15/94, effective 1/1/95. Statutory Authority: RCW 43.20.050.
- 246-272-190 Inspection. [Statutory Authority: RCW 43.20.050. 92-02-019 (Order 225B), § 246-272-190, filed 12/23/91, effective 1/23/92; 91-02-051 (Order 124B), recodified as § 246-272-190, filed 12/27/90, effective 1/31/91; 83-13-014 (Order 259), § 248-96-140, filed 6/3/83; Order 101, § 248-96-140, filed 6/10/74.] Repealed by 94-09-025, filed 4/15/94, effective 1/1/95. Statutory Authority: RCW 43.20.050.
- 246-272-200 Appeals. [Statutory Authority: RCW 43.20.050. 91-02-051 (Order 124B), recodified as § 246-272-200, filed 12/27/90, effective 1/31/91; 83-13-014 (Order 259), § 248-96-150, filed 6/3/83.] Repealed by 94-09-025, filed 4/15/94, effective 1/1/95. Statutory Authority: RCW 43.20.050.
- 246-272-210 Waiver of state regulations. [Statutory Authority: RCW 43.20.050. 91-02-051 (Order 124B), recodified as § 246-272-210, filed 12/27/90, effective 1/31/91; 83-13-014 (Order 259), § 248-96-160, filed 6/3/83; Order 101, § 248-96-160, filed 6/10/74.] Repealed by 94-09-025, filed 4/15/94, effective 1/1/95. Statutory Authority: RCW 43.20.050.
- 246-272-220 Disposal of septic tank waste. [Statutory Authority: RCW 43.20.050. 91-02-051 (Order 124B), recodified as § 246-272-220, filed 12/27/90, effective 1/31/91; Order 101, § 248-96-170, filed 6/10/74.] Repealed by 94-09-025, filed 4/15/94, effective 1/1/95. Statutory Authority: RCW 43.20.050.
- 246-272-230 Installer requirements. [Statutory Authority: RCW 43.20.050. 91-02-051 (Order 124B), recodified as § 246-272-230, filed 12/27/90, effective 1/31/91; 83-13-014 (Order 259), § 248-96-175, filed 6/3/83; Order 101, § 248-96-175, filed 6/10/74.] Repealed by 94-09-025, filed 4/15/94, effective 1/1/95. Statutory Authority: RCW 43.20.050.
- 246-272-240 State advisory committee. [Statutory Authority: RCW 43.20.050. 91-02-051 (Order 124B), recodified as § 246-272-240, filed 12/27/90, effective 1/31/91; 83-13-014 (Order 259), § 248-96-180, filed 6/3/83; Order 101, § 248-96-180, filed 6/10/74.] Repealed by 94-09-025, filed 4/15/94, effective 1/1/95. Statutory Authority: RCW 43.20.050.

**WAC 246-272-00101 Purpose, objectives, and authority.** (1) The purpose of this chapter is to protect the public health by minimizing:

(a) The potential for public exposure to sewage from on-site sewage systems; and

(b) Adverse effects to public health that discharges from on-site sewage systems may have on ground and surface waters.

(2) This chapter regulates the location, design, installation, operation, maintenance, and monitoring of on-site sewage systems to:

(a) Achieve long-term sewage treatment and effluent disposal; and

(b) Limit the discharge of contaminants to waters of the state.

(3) This chapter is adopted by the state board of health in accordance with the authority granted in RCW 43.20.050 to establish minimum requirements for the department of health, and local boards of health whether or not they choose to adopt local regulations.

[Statutory Authority: RCW 43.20.050. 94-09-025, § 246-272-00101, filed 4/15/94, effective 1/1/95.]

**WAC 246-272-00501 Administration.** The local health officers and the department shall administer this chapter under the authority and requirements of chapters 70.05, 70.08, 70.46, and 43.70 RCW. Under RCW 70.05.060(7), fees may be charged for this administration.

[Statutory Authority: RCW 43.20.050. 94-09-025, § 246-272-00501, filed 4/15/94, effective 1/1/95.]

**WAC 246-272-01001 Definitions.** "Additive" means a commercial product added to an on-site sewage system intended to affect performance or aesthetics of an on-site sewage system.

"Alternative system" means an on-site sewage system other than a conventional gravity system or conventional pressure distribution system. Properly operated and maintained alternative systems provide equivalent or enhanced treatment performance as compared to conventional gravity systems.

"Approved" means a written statement of acceptability, in terms of the requirements in this chapter, issued by the local health officer or the department.

"Approved list" means "List of Approved Systems and Products," developed annually and maintained by the department and containing the following:

List of proprietary devices approved by the department;

List of specific systems meeting treatment standard 1 and treatment standard 2;

List of experimental systems approved by the department;

List of septic tanks, pump chambers, and holding tanks approved by the department.

**"Area of special concern"** means an area of definite boundaries delineated through public process, where a local health officer, or the department in consultation with the health officer, determines additional requirements for on-site sewage systems may be necessary to reduce potential failures, or minimize negative impact of on-site systems upon public health.

**"Cesspool"** means a pit receiving untreated sewage and allowing the liquid to seep into the surrounding soil or rock.

**"Conforming system"** means any on-site sewage system, except an experimental system, meeting any of the following criteria:

Systems in full compliance with new construction requirements under this chapter; or

Systems approved, installed, and operating in accordance with requirements of previous editions of this chapter; or

Systems or repairs permitted through departmental concurrence by the waiver process which assure public health protection by higher treatment performance or other methods.

**"Conventional gravity system"** means an on-site sewage system consisting of a septic tank and a subsurface soil absorption system with gravity distribution of the effluent.

**"Conventional pressure distribution system"** means an on-site sewage system consisting of a septic tank and a subsurface soil absorption system with pressure distribution of the effluent. Design, operation and maintenance, and performance monitoring are described by *"Guidelines for Pressure Distribution Systems"* by the Washington state department of health.

**"Covenant"** means a recorded agreement stating certain activities and/or practices are required or prohibited.

**"Cuts and/or banks"** means any naturally occurring or artificially formed slope greater than one hundred percent (forty-five degrees) and extending vertically at least five feet from the toe of the slope to the top of the slope as follows:

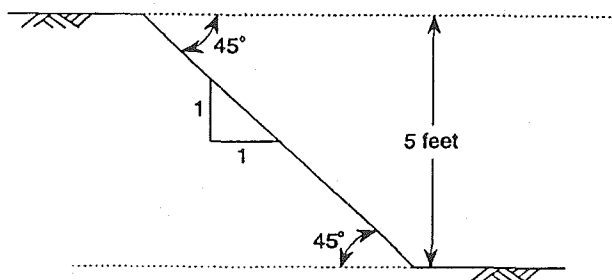

**"Designer"** means a person who matches site and soil characteristics with appropriate on-site sewage technology.

**"Development"** means the creation of a residence, structure, facility, mobile home park, subdivision, planned unit development, site, area, or any activity resulting in the production of sewage.

**"Department"** means the Washington state department of health.

**"Disposal component"** means a subsurface absorption system (SSAS) or other soil absorption system receiving septic tank or other pretreatment device effluent and transmitting it into original, undisturbed soil.

**"Effluent"** means liquid discharged from a septic tank or other on-site sewage system component.

**"Engineer"** means a person who is licensed and in good standing under chapter 18.43 RCW.

**"Expansion"** means a change in a residence, facility, site, or use that:

Causes an on-site sewage system to exceed its existing treatment or disposal capability, for example, when a residence is increased from two to three bedrooms or a change in use from an office to a restaurant; or

Reduces the treatment or disposal capability of the existing on-site sewage system or the reserve area, for example, when a building is placed over a reserve area.

**"Experimental system"** means any alternative system: Without design guidelines developed by the department;

or  
A proprietary device or method which has not yet been evaluated and approved by the department.

**"Failure"** means a condition of an on-site sewage system that threatens the public health by inadequately treating sewage or by creating a potential for direct or indirect contact between sewage and the public. Examples of failure include:

Sewage on the surface of the ground;

Sewage backing up into a structure caused by slow soil absorption of septic tank effluent;

Sewage leaking from a septic tank, pump chamber, holding tank, or collection system;

Cesspools or seepage pits where evidence of ground water or surface water quality degradation exists;

Inadequately treated effluent contaminating ground water or surface water; or

Noncompliance with standards stipulated on the permit.

**"Ground water"** means a subsurface water occupying the zone of saturated soil, permanently, seasonally, or as the result of the tides. Indications of ground water may include:

Water seeping into or standing in an open excavation from the soil surrounding the excavation.

Spots or blotches of different color or shades of color interspersed with a dominant color in soil, commonly referred to as mottling. Mottling is a historic indication for the presence of ground water caused by intermittent periods of saturation and drying, and may be indicative of poor aeration and impeded drainage. Also see "water table."

**"Holding tank sewage system"** means an on-site sewage system which incorporates a holding tank, the services of a sewage pumper/hauler, and the off-site treatment and disposal for the sewage generated.

**"Industrial wastewater"** means the water or liquid carried waste from an industrial process. These wastes may result from any process or activity of industry, manufacture, trade or business, from the development of any natural resource, or from animal operations such as feedlots, poultry houses, or dairies. The term includes contaminated storm water and leachate from solid waste facilities.

**"Installer"** means a qualified person approved by a local health officer to install or repair on-site sewage systems or components.

**"Large on-site sewage system (LOSS)"** means any on-site sewage system with design flows, at any common point, greater than three thousand five hundred gallons per day.

**"Local health officer"** means the health officer of the city, county, or city-county health department or district within the state of Washington, or a representative authorized by and under the direct supervision of the local health officer, as defined in chapter 70.05 RCW.

**"May"** means discretionary, permissive, or allowed.

**"On-site sewage system (OSS)"** means an integrated arrangement of components for a residence, building, industrial establishment or other places not connected to a public sewer system which:

Convey, store, treat, and/or provide subsurface soil treatment and disposal on the property where it originates, upon adjacent or nearby property; and

Includes piping, treatment devices, other accessories, and soil underlying the disposal component of the initial and reserve areas.

**"Ordinary high-water mark"** means the mark on lakes, streams, and tidal waters, found by examining the beds and banks and ascertaining where the presence and action of waters are so common and usual, and so long continued in all ordinary years, as to mark upon the soil a character distinct from that of the abutting upland with respect to vegetation, as that condition exists on the effective date of this chapter, or as it may naturally change thereafter. The following definitions apply where the ordinary high-water mark cannot be found:

The ordinary high-water mark adjoining marine water is the elevation at mean higher high tide; and

The ordinary high-water mark adjoining freshwater is the line of mean high water.

**"Person"** means any individual, corporation, company, association, society, firm, partnership, joint stock company, or any governmental agency, or the authorized agents of any such entities.

**"Planned unit development"** means a development characterized by a unified site design, clustered residential units and/or commercial units, and areas of common open space.

**"Pressure distribution"** means a system of small diameter pipes equally distributing effluent throughout a trench or bed, as described in the *"Guidelines for Pressure Distribution Systems"* by the department. Also see "conventional pressure distribution."

**"Proprietary device or method"** means a device or method classified as an alternative system, or a component thereof, held under a patent, trademark or copyright.

**"Public sewer system"** means a sewerage system:

Owned or operated by a city, town, municipal corporation, county, or other approved ownership consisting of a collection system and necessary trunks, pumping facilities and a means of final treatment and disposal; and

Approved by or under permit from the department of ecology, the department of health and/or a local health officer.

**"Pumper"** means a person approved by the local health officer to remove and transport wastewater or septage from on-site sewage systems.

**"Repair"** means restoration, by reconstruction or relocation, or replacement of a failed on-site sewage system.

**"Reserve area"** means an area of land approved for the installation of a conforming system and dedicated for replacement of the OSS upon its failure.

**"Residential sewage"** means sewage having the constituency and strength typical of wastewater from domestic households.

**"Restrictive layer"** means a stratum impeding the vertical movement of water, air, and growth of plant roots, such as hardpan, claypan, fragipan, caliche, some compacted soils, bedrock and unstructured clay soils.

**"Seepage pit"** means an excavation more than three feet deep where the sidewall of the excavation is designed to dispose of septic tank effluent. Seepage pits may also be called "dry wells."

**"Septage"** means the mixture of solid wastes, scum, sludge, and liquids pumped from within septic tanks, pump chambers, holding tanks, and other OSS components.

**"Septic tank"** means a watertight pretreatment receptacle receiving the discharge of sewage from a building sewer or sewers, designed and constructed to permit separation of settleable and floating solids from the liquid, detention and anaerobic digestion of the organic matter, prior to discharge of the liquid.

**"Sewage"** means any urine, feces, and the water carrying human wastes, including kitchen, bath, and laundry wastes from residences, buildings, industrial establishments or other places. For the purposes of these regulations, "sewage" is generally synonymous with domestic wastewater. Also see "residential sewage."

**"Shall"** means mandatory.

**"Soil log"** means a detailed description of soil characteristics providing information on the soil's capacity to act as an acceptable treatment and disposal medium for sewage.

**"Soil type"** means a numerical classification of fine earth particles and coarse fragments as described in WAC 246-272-11001 (2)(e).

**"Subdivision"** means a division of land or creation of lots or parcels, described under chapter 58.17 RCW, now or as hereafter amended, including both long and short subdivisions, planned unit developments, and mobile home parks.

**"SSAS" or "subsurface soil absorption system"** means a system of trenches three feet or less in width, or beds between three and ten feet in width, containing distribution pipe within a layer of clean gravel designed and installed in original, undisturbed soil for the purpose of receiving effluent and transmitting it into the soil.

**"Surface water"** means any body of water, whether fresh or marine, flowing or contained in natural or artificial unlined depressions for significant periods of the year, including natural and artificial lakes, ponds, springs, rivers, streams, swamps, marshes, and tidal waters.

**"Table VI repair"** means a repair or replacement of an existing on-site sewage system which, because of site limitations, must utilize treatment standards shown in Table VI in lieu of compliance with new construction requirements for vertical separation and/or horizontal set back from surface waters or drinking water wells or springs.



"Treatment standard 1" means a thirty-day average of less than 10 milligrams per liter of biochemical oxygen demand (five-day BOD<sub>5</sub>), 10 milligrams per liter of total suspended solids (TSS), and a thirty-day geometric mean of less than 200 fecal coliform per 100 milliliters.

"Treatment standard 2" means a thirty-day average of less than 10 milligrams per liter of biochemical oxygen demand (five-day BOD<sub>5</sub>), 10 milligrams per liter of total suspended solids (TSS), and a thirty-day geometric mean of less than 800 fecal coliform per 100 milliliters.

"Unit volume of sewage" means:

A single family residence;

A mobile home site in a mobile home park; or

Four hundred fifty gallons of sewage per day where the proposed development is not single family residences or a mobile home park.

"Vertical separation" means the depth of unsaturated, original, undisturbed soil of soil types 1B-6 between the bottom of a disposal component and the highest seasonal water table, a restrictive layer, or soil type 1A, as illustrated below by the profile drawing of a subsurface soil absorption system:

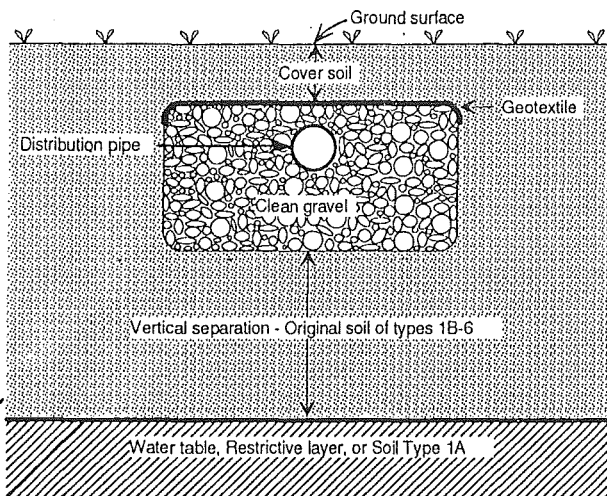

"Water table" means the upper surface of the ground water, whether permanent or seasonal. Also see "ground water."

"Wave barrier" means a bulkhead of adequate height and construction protecting the immediate area of on-site sewage system components from wave action.

[Statutory Authority: RCW 43.20.050. 94-09-025, § 246-272-01001, filed 4/15/94, effective 1/1/95.]

**WAC 246-272-02001 Local regulation.** (1) Local boards of health may adopt and enforce local rules and regulations governing on-site sewage systems when the local regulations are:

- (a) Consistent with, and as stringent as, this chapter; and
- (b) Approved by the department prior to the effective date of local regulations.

(2) A local board of health may apply for departmental approval of local regulations at any time by initiating the following procedure:

- (a) The local board shall submit the proposed local regulations to the department.

(1997 Ed.)

- (b) Within ninety days of receipt, the department shall:
  - (i) Approve the regulation; or
  - (ii) Signify automatic tacit agreement with the local regulations and permitting local implementation by failing to act; or
  - (iii) Deny approval of the regulations. If the department determines local regulations are not consistent with this chapter, the department shall provide specific reasons for denial.

(3) Upon receipt of departmental approval or after ninety days without notification, whichever comes first, the local board may implement adopted regulations. The local board shall provide a copy of the adopted local regulations to the department.

(4) If the department denies approval of local regulations, the local board of health may:

- (a) Resubmit revised regulations for departmental consideration; or
- (b) Submit a written request for a review of the departmental denial within one hundred twenty days from the date the local board of health receives the written reasons for the denial.

(5) Upon receipt of written request for review of the departmental denial, the department shall:

- (a) Acknowledge the receipt of the request in writing; and
- (b) Form a mutually acceptable advisory panel consisting of:

- (i) One departmental employee;
- (ii) One employee from a local health jurisdiction other than that which requested the review; and
- (iii) One member of the technical review committee described in WAC 246-272-23501.

(6) If good faith efforts to reach agreement are unsuccessful, the local board of health may appeal the denial to the Washington state board of health for resolution.

(7) Nothing in this chapter shall prohibit the adoption and enforcement of more stringent regulations by local health departments where such regulations are needed to protect the public health.

[Statutory Authority: RCW 43.20.050. 94-09-025, § 246-272-02001, filed 4/15/94, effective 1/1/95.]

**WAC 246-272-03001 Applicability.** (1) The local health officer and the department:

- (a) Shall apply this chapter to OSS treating wastewater and disposing of effluent from residential sewage sources;
- (b) May apply this chapter to OSS for sources other than residential sewage, excluding industrial wastewater, if pretreatment, siting, design, installation, and operation and maintenance measures provide treatment and effluent disposal equal to that required of residential sewage.

(2) Preliminary plats specifying general methods of sewage treatment, disposal, system designs and locations approved prior to the effective date of these regulations shall be acted upon in accordance with regulations in force at the time of preliminary plat approval for a maximum period of five years from the date of approval or for an additional year beyond the effective date of these regulations, whichever assures the most lenient expiration date.



(3) A valid sewage system design approval, or installation permit issued prior to the effective date of these regulations:

(a) Shall be acted upon in accordance with regulations in force at the time of issuance;

(b) Shall have a maximum validity period of five years from the date of issuance or remain valid for an additional year beyond the effective date of these regulations, whichever assures the most lenient expiration date; and

(c) May be modified to include additional requirements if the health officer determines that a serious threat to public health exists.

(4) The Washington state department of ecology has authority and approval over:

(a) Domestic or industrial wastewater under chapter 173-240 WAC; and

(b) Sewage systems using mechanical treatment, or lagoons, with ultimate design flows above three thousand five hundred gallons per day.

(5) The Washington state department of health has authority and approval over:

(a) Systems with design flows through any common point between three thousand five hundred to fourteen thousand five hundred gallons per day; and

(b) Any large on-site sewage system "LOSS" for which jurisdiction has been transferred to the department of health under conditions of memorandum of agreement with the department of ecology.

(6) The local health officer has authority and approval over:

(a) Systems with design flows through any common point up to three thousand five hundred gallons per day;

(b) Any large on-site sewage system "LOSS" for which jurisdiction has been transferred to a local health jurisdiction from the department by contract.

(7) Where this chapter conflicts with chapter 90.48 RCW, Water pollution control, the requirements under those statutes apply.

[Statutory Authority: RCW 43.20.050. 94-09-025, § 246-272-03001, filed 4/15/94, effective 1/1/95.]

**WAC 246-272-04001 Alternative systems and proprietary devices.** (1) The department:

(a) May approve guidelines for alternative systems if they are based upon:

(i) Sufficient theory and/or applied research to warrant guideline development; and

(ii) Sufficient accumulation of performance data to prove treatment standards are met; and

(iii) Review and recommendations by the technical review committee established under WAC 246-272-23501.

(b) May maintain lists of approved methods, proprietary devices, guidelines, and alternative systems.

(c) May charge fees to cover the cost of administering an alternative system program.

(2) The local health officer or department shall only permit installation of alternative systems for which there are alternative system guidelines, or a proprietary device if it appears on the list of approved systems or devices maintained by the department under subsection (1)(a) and (b) of this section.

(3) The local health officer:

(a) May require performance monitoring or sampling of any alternative system.

(b) May charge fees to cover the costs for monitoring system performance.

(c) Shall submit copies of evaluation reports to the department when alternative system performance is evaluated.

(d) Shall notify the department of alternative system approvals and failures.

(4) Persons desiring product inclusion on the approved list, or intending to alter an approved device or method, shall submit to the department:

(a) Documentation, data, plans, or other information requested, in an acceptable format for technical evaluation to certify that the product meets all the criteria in the appropriate guidelines; and

(b) Required fees.

(5) Persons desiring continued retention on the list of approved systems and products shall submit to the department:

(a) An acceptable annual report which includes any changes in the product and certifies that the device meets appropriate guidelines; and

(b) Required fees.

[Statutory Authority: RCW 43.20.050. 94-09-025, § 246-272-04001, filed 4/15/94, effective 1/1/95.]

**WAC 246-272-05001 Experimental systems.** (1)

Persons proposing a system for inclusion on the departmental approved list of experimental systems shall submit to the department for review and approval, a written proposal which includes:

(a) Description of existing theory and/or applied research supporting the application;

(b) Proposed testing protocol;

(c) Proposed operation, maintenance, and monitoring detail and schedules;

(d) Maximum number of installations;

(e) Proposed locations and uses, if multiple locations are proposed;

(f) Proposed reporting detail and frequency;

(g) Proposed schedule for the experimental program;

(h) Name(s) of the person(s) financially responsible for the experimental program, including:

(i) Routine operation and maintenance;

(ii) Monitoring; and

(iii) Repair and/or replacement of the system.

(i) Verification that the proposal is consistent with the intent of this chapter, requirements of this section, and the departmental application process.

(2) The local health officer:

(a) May permit a limited number of specific experimental systems if:

(i) The specific system is included on the department's approved list of experimental systems under subsection (5)(b) of this section;

(ii) The site will accommodate the installation of a conforming system in the event of failure of the experimental system;

(iii) Local agreements to provide for monitoring, sampling, testing, reporting, maintenance, repairs, and the replacement of the system in accordance with the protocol approved by the department under subsection (1) of this section are completed and signed.

(b) May charge fees to cover the cost of evaluating or monitoring the experimental system.

(3) After the experimental system proposal is approved, the person noted as responsible for an experimental system program on the departmental approved list shall:

(a) Follow the experimental system protocol, procedures, and other related written agreements approved by the department and the local health officer;

(b) Monitor the experimental system and submit records as required to meet department's approval or the local health officer's permit; and

(c) Annually renew each state experimental system permit.

(4) A person desiring to install an experimental system shall:

(a) Obtain a permit from the local health officer;

(b) Submit a written promise to the health officer agreeing to abandon the experimental system and install a conforming system if:

(i) The system fails;

(ii) The performance of the experimental system is unsatisfactory; or

(iii) The applicant fails to adequately monitor the experimental system and submit records as required in the department's approval or the local health officer's permit;

(iv) The system components do not function as indicated by submitted documents;

(v) Performance does not meet the anticipated objectives of the experiment; or

(vi) The state experimental system permit is not renewed annually.

(c) Provide financial guarantees, acceptable to the health officer, and a copy of the recorded covenant required under (b) of this subsection to the local health officer; and

(d) Obtain through the local health officer an annually renewable state experimental system permit.

(5) The department:

(a) Shall obtain recommendations from the technical review committee prior to issuing approval of a proposal;

(b) Shall maintain a list of experimental systems that have been approved by the department, which also indicates each system's current status, application, use, and restrictions;

(c) Shall monitor the performance of the experimental system, including evaluation of any failures;

(d) Shall annually renew the state experimental system permit when:

(i) The requirements under subsections (3)(a) and (b) of this section are satisfied; and

(ii) The performance of the system is satisfactory; and

(e) Shall no longer apply the requirements of this section when the requirements of WAC 246-272-04001 are satisfied.

(6) The department and the local health officer shall not permit an experimental LOSS.

[Statutory Authority: RCW 43.20.050. 94-09-025, § 246-272-05001, filed 4/15/94, effective 1/1/95.]

(1997 Ed.)

**WAC 246-272-07001 Connection to public sewer system.** (1) When adequate public sewer services are available within two hundred feet of the residence or facility the local health officer, upon the failure of an existing on-site sewage system may:

(a) Require hook-up to a public sewer system; or

(b) Permit the repair or replacement of the on-site sewage system only if a conforming system can be designed and installed.

(2) Except as noted in subsection (1) of this section, the owner of a failure shall abandon the OSS under WAC 246-272-18501 and connect the residence or other facility to a public sewer system when:

(a) The distance between the residence or other facility and an adequate public sewer is two hundred feet or less as measured along the usual or most feasible route of access; and

(b) The sewer utility allows the sewer connection.

(3) The owner of a residence or other facility served by a Table VI repair as defined in WAC 246-272-01001 of this chapter shall abandon the OSS according to the requirements specified in WAC 246-272-18501, and connect the residence or other facility to a public sewer system when:

(a) Connection is deemed necessary to protect public health by the local health officer;

(b) An adequate public sewer becomes available within two hundred feet of the residence or other facility as measured along the usual or most economically feasible route of access; and

(c) The sewer utility allows the sewer connection.

(4) Local boards of health may require a new development to connect to a public sewer system to protect public health.

[Statutory Authority: RCW 43.20.050. 94-09-025, § 246-272-07001, filed 4/15/94, effective 1/1/95.]

**WAC 246-272-08001 Large on-site sewage systems (LOSS).** (1) Persons proposing a new LOSS for which the department has jurisdiction by WAC or memorandum of agreement with the department of ecology shall meet the requirements specified in "Design Standards for Large On-site Sewage Systems," 1993, Washington state department of health (available upon written request to the department).

(2) Persons shall submit the documents and fees specified under (a) through (f) of this subsection and obtain approval from the department before installing a LOSS to serve any facility:

(a) A preliminary report, stamped and signed by an engineer, including:

(i) A discussion of the proposed project, including the schedule of construction;

(ii) A discussion of compliance with other state and local zoning, platting, health, and building regulations as they relate to sewage treatment and disposal;

(iii) An analysis of the site's capacity to treat and dispose of the proposed quantity and quality of sewage;

(iv) An analysis of the factors identified in WAC 246-272-20501 (2)(d)(ii)(A); and

(v) A soil and site evaluation as specified in WAC 246-272-11001 signed by the evaluator;

(vi) A management plan describing the:

(A) Management entity consisting of one of the following:

(I) For residential subdivisions where the lots are individually owned, a public entity serves as the primary management entity, or as the third party trust for a private management entity; or

(II) For other uses, including single ownership, a public entity or a private entity via an appropriate contract or agreement provides management;

(B) Duties of the management entity, including specific tasks and frequency of operation and maintenance;

(C) Controls to ensure the continuity and permanency of proper operation and maintenance;

(D) Methods and frequency of monitoring, recordkeeping, and reporting to the department;

(E) Rights and responsibilities of management; and

(F) Rights and responsibilities of persons purchasing connections to the LOSS.

(b) Complete plans and specifications of the LOSS:

(i) Showing a conventional pressure distribution system with three feet of vertical separation;

(ii) Meeting all other design criteria within "*Design Standards for Large On-site Sewage Systems*," 1993, department of health (available upon written request to the department); and

(iii) Stamped and signed by an engineer;

(c) A schedule of inspections to confirm the installation conforms to the plans and specifications;

(d) A draft operation and maintenance manual, describing the LOSS and outlining routine maintenance procedures for proper operation of the system;

(e) Required fees; and

(f) Other information as required by the department.

(3) Persons desiring to repair, modify or expand a facility served, or to be served by a LOSS shall submit all documents and fees specified under subsection (2)(a) through (f) of this section, unless the department waives submission of some elements as unnecessary, and obtain approval from the department.

(4) The department:

(a) Shall not change the terms of a project's construction approval during a two-year validity period. However additional terms to protect public health may be included before granting one-year approval permit extensions;

(b) Shall conduct a presite inspection; and

(c) May allow the applicant to renew approval under the initial terms for successive one-year periods if:

(i) The LOSS is incomplete two years after the department's approval;

(ii) The applicant requests renewal in writing; and

(iii) The applicant submits required fees.

(5) A qualified installer shall install the LOSS.

(6) The applicant or applicant's agent:

(a) Shall comply with all conditions set forth in the department's construction approval;

(b) May request extensions to the construction approval permit; and

(c) Shall comply with any additional conditions upon construction approval extensions set forth by the department, and pay required fees for renewing the approval.

(7) Before a new LOSS is used:

(a) An engineer shall stamp, sign, and submit a LOSS construction report to the department within sixty days following the completion of construction of the LOSS including:

(i) A completed form stating the LOSS was constructed in accordance with the department's approved plans and specifications; and

(ii) An "as built" or "record" drawing;

(b) The department shall conduct a final inspection; and

(c) The owner shall:

(i) Submit an operation and maintenance manual developed by an engineer for the installed LOSS to the department for review and approval; and

(ii) Obtain a LOSS operating permit from the department by:

(A) Completing and submitting forms to the department;

and

(B) Paying required fees.

(8) The owner of a LOSS that has been approved by the department or local health officer or constructed after July 1, 1984, shall:

(a) Obtain a LOSS operating permit from the department; and

(b) Annually renew it.

(9) The owner shall annually renew the LOSS operating permit by:

(a) Continued retention of an approved management entity to operate and maintain the LOSS;

(b) Submitting a report to the department demonstrating the LOSS is operated, maintained, and monitored in accordance with this chapter and the approved operation and maintenance manual; and

(c) Submitting required fees.

(10) The department:

(a) Shall issue a LOSS operating permit to owners of LOSS meeting the requirements of subsections (1) through (7) of this section;

(b) Shall annually renew the LOSS operating permit when the owner has complied with the requirements under subsection (9) of this section;

(c) May revoke the LOSS operating permit when the:

(i) Approved management entity ceases to operate and maintain the LOSS;

(ii) Owner does not meet other conditions of the LOSS operating permit; or

(iii) LOSS fails;

(d) Shall monitor the performance of LOSS; and

(e) Shall apply the requirements under WAC 246-272-16501 to failing LOSS.

(11) The department may request the assistance of the local health officer to review the site or the design or to inspect the construction of a LOSS.

(12) A local health officer and the department may enter into a contract under which:

(a) The local health officer will assume the department's responsibilities in subsections (2), (4), (6), (7)(a), (b) and (c)(i) of this section to regulate LOSS; and

(b) The local health officer may charge fees to a LOSS applicant or owner for services provided if the authorization for such fees is set forth in local regulations adopted under this chapter.

[Statutory Authority: RCW 43.20.050. 94-09-025, § 246-272-08001, filed 4/15/94, effective 1/1/95.]

**WAC 246-272-09001 Permits for OSS under three thousand five hundred gallons per day.** (1) Prior to beginning the construction process, a person proposing the installation, repair, modification, connection to, or expansion of an OSS, shall develop and submit the following to the local health officer and obtain approval:

- (a) General information including:
  - (i) Name and address of the property owner and the applicant at the head of each page of submission;
  - (ii) Parcel number and address, if available, of the site;
  - (iii) Source of drinking water supply;
  - (iv) Identification if the property is within the boundaries of a recognized sewer utility;
  - (v) Size of the parcel;
  - (vi) Type of permit for which application is being made, for example, new installation, repair, expansion, alteration, or operational;
  - (vii) Source of sewage, for example, residential, restaurant, or other type of business;
  - (viii) Location of utilities;
  - (ix) Name of the site evaluator;
  - (x) Name of the designer;
  - (xi) Date of application; and
  - (xii) Signature of applicant.
- (b) The soil and site evaluation as specified under WAC 246-272-11001(2).
- (c) A complete, detailed, and dimensional site plan including:
  - (i) Designated areas for the proposed initial system and the reserve area;
  - (ii) The location of all soil logs and other soil tests for the OSS;
  - (iii) General topography and/or slope of the site;
  - (iv) Site drainage characteristics;
  - (v) The location of existing and proposed encumbrances affecting system placement, including legal access documents if any component of the OSS is not on the lot where the sewage is generated; and
  - (vi) An arrow indicating north.
- (d) A detailed system design meeting the requirements under WAC 246-272-11501 including:
  - (i) A dimensional drawing showing the location of components of the proposed OSS, and the system designed for the reserve area if reserve site characteristics differ significantly from the initial area;
  - (ii) Vertical cross-section drawings showing:
    - (A) The depth of the disposal component, the vertical separation, and depth of soil cover; and
    - (B) Other OSS components constructed at the site.
  - (iii) Calculations and assumptions supporting the proposed design, including:
    - (A) Soil type;
    - (B) Hydraulic loading rate in the disposal component; and
    - (C) System's maximum daily flow capacity.
  - (e) Such additional information as deemed necessary by the local health officer.

(2) The local health officer may develop the required information specified in subsection (1) of this section if authorization for such actions is included in local regulations.

(3) The local health officer shall:

- (a) Issue a permit when the information submitted under subsection (1) of this section meets the requirements contained in this chapter and in local regulations;
  - (b) Identify the permit as a new installation, repair, expansion, modification, or operational permit;
  - (c) Specify the expiration date on the permit;
  - (d) Include a reminder on the permit application of the applicant's right of appeal; and
  - (e) State the period of validity and the date and conditions of renewal when requiring operational permits to be obtained and retained;
- (4) The local health officer may revoke or deny a permit for due cause. Examples include, but are not limited to:
- (a) Development or continued use of an OSS that threatens the public health;
  - (b) Misrepresentation or concealment of material fact in information submitted to the local health officer; or
  - (c) Failure to meet conditions of the permit or the regulations.
- (5) Before the local health officer issues a permit for the installation of an OSS to serve more than one development, the applicant shall show:
- (a) An approved public entity owning or managing the OSS in perpetuity; or
  - (b) An arrangement with a management entity acceptable to the local health officer, recorded in covenant, lasting until the on-site system is no longer needed, and containing, but not limited to:
    - (i) A legal easement allowing access for construction, operation and maintenance, and repair of the OSS; and
    - (ii) Identification of an adequate financing mechanism to assure the funding of operation, maintenance, and repair of the OSS.
- (6) The local health officer shall not delegate the authority to issue permits.
- (7) The local health officer may stipulate additional requirements for a particular permit if necessary for public health protection.

[Statutory Authority: RCW 43.20.050. 94-09-025, § 246-272-09001, filed 4/15/94, effective 1/1/95.]

**WAC 246-272-09501 Location.** (1) Persons shall design and install OSS to meet the minimum horizontal separations shown in Table I, Minimum Horizontal Separations:

**TABLE I  
MINIMUM HORIZONTAL SEPARATIONS**

Items requiring setback	From edge of disposal component and reserve area	From septic tank, holding tank, containment vessel, pump chamber, and distribution box	From building sewer, collection, and non-perforated distribution line <sup>1</sup>
Non-public well or suction line	100 ft.	50 ft.	50 ft.
Public drinking water well	100 ft.	100 ft.	100 ft.
Public drinking water spring <sup>3</sup>	200 ft.	200 ft.	100 ft.
Spring or surface water used as drinking water source <sup>2,3</sup>	100 ft.	50 ft.	50 ft.
Pressurized water supply line <sup>4</sup>	10 ft.	10 ft.	10 ft.
Properly decommissioned well <sup>5</sup>	10 ft.	N/A	N/A
Surface water <sup>3</sup> Marine water Fresh water	100 ft. 100 ft.	50 ft. 50 ft.	10 ft. 10 ft.
Building foundation	10 ft. <sup>6</sup>	5 ft. <sup>6</sup>	2 ft.
Property or easement line <sup>6</sup>	5 ft.	5 ft.	N/A
Interceptor / curtain drains/ drainage ditches Down-gradient <sup>7</sup> Up-gradient <sup>7</sup>	30 ft. 10 ft.	5 ft. N/A	N/A N/A
Down-gradient cuts or banks with at least 5 ft. of original, undisturbed soil above a restrictive layer due to a structural or textural change	25 ft.	N/A	N/A
Down-gradient cuts or banks with less than 5 ft. of original, undisturbed, soil above a restrictive layer due to a structural or textural change	50 ft.	N/A	N/A

1 "Building sewer" as defined by the most current edition of the Uniform Plumbing Code.  
"Nonperforated distribution" includes pressure sewer transport lines.

2 If surface water is used as a public drinking water supply, the designer shall locate the OSS outside of the required sanitary control area.

3 Measured from the ordinary high-water mark.

4 The local health officer may approve a sewer transport line within ten feet of a water supply line if the sewer line is constructed in accordance with section 2.4 of the department of ecology's "Criteria For Sewage Works Design," revised October 1985, or equivalent.

5 Before any component can be placed within one hundred feet of a well, the designer shall submit a "decommissioned water well report" provided by a licensed well driller, which verifies that appropriate decommissioning procedures noted in chapter 173-160 WAC were followed. Once the well is properly decommissioned, it no longer provides a potential conduit to ground

water, but septic tanks, pump chambers, containment vessels, or distribution boxes should not be placed directly over the site.

6 The local health officer may allow a reduced horizontal separation to not less than two feet where the property line, easement line, or building foundation is up-gradient.

7 The item is down-gradient when liquid will flow toward it upon encountering a water table or a restrictive layer. The item is up-gradient when liquid will flow away from it upon encountering a water table or restrictive layer.

(2) Where any condition indicates a greater potential for contamination or pollution, the local health officer or the department may increase the minimum horizontal separations. Examples of such conditions include excessively permeable soils, unconfined aquifers, shallow or saturated soils, dug wells, and improperly abandoned wells.

(3) The horizontal separation between an OSS disposal component and an individual water well, spring, or surface water can be reduced to a minimum of seventy-five feet, by

the local health officer, and be described as a "conforming" system upon signed approval by the health officer if the applicant demonstrates:

(a) Adequate protective site specific conditions, such as physical settings with low hydro-geologic susceptibility from contaminant infiltration. Examples of such conditions include evidence of confining layers and or aquatards separating potable water from the OSS treatment zone, excessive depth to ground water, down-gradient contaminant source, or outside the zone of influence; or

(b) Design and proper operation of an OSS system assuring enhanced treatment performance beyond that accomplished by meeting the vertical separation and effluent distribution requirements described in WAC 246-272-11501 (2)(f) Table IV; or

(c) Evidence of protective conditions involving both (a) and (b) of this subsection.

(4) Persons shall design and/or install disposal components only where:

(a) The slope is less than forty-five percent (twenty-four degrees);

(b) The area is not subject to:

(i) Encroachment by buildings or construction such as placement of swimming pools, power poles and underground utilities;

(ii) Cover by impervious material;

(iii) Vehicular traffic; or

(iv) Other activities adversely affecting the soil or the performance of the OSS.

(c) Sufficient reserve area for replacement exists to treat and dispose one hundred percent of the design flow;

(d) The land is stable; and

(e) Surface drainage is directed away from the site.

(5) A local health officer may allow expansion of an existing on-site sewage system adjacent to a marine shoreline that does not meet the minimum horizontal separation between the disposal component and the ordinary high water mark required by WAC 246-272-09501 Table I, provided that:

(a) The system meets all requirements of WAC 246-272-11501;

(b) The system complies with all other requirements of WAC 246-272-09501 and 246-272-17501;

(c) Horizontal separation between the disposal component and the ordinary high water mark is fifty feet or greater; and

(d) Vertical separation is three feet or greater with a conventional gravity drainfield, or two feet or greater with a conventional pressure distribution drainfield.

[Statutory Authority: RCW 43.20.050. 94-09-025, § 246-272-09501, filed 4/15/94, effective 1/1/95.]

**WAC 246-272-11001 Soil and site evaluation. (1)**

The local health officer or department shall permit only engineers, qualified designers and soil scientists to perform soil and site evaluations.

(2) The person evaluating the soil and site shall:

(a) Record:

(i) A sufficient number of soil logs to evaluate conditions within:

(A) The initial disposal component; and

(B) The reserve area.

(ii) The ground water conditions, the date of the observation, and the probable maximum height;

(iii) The topography of the site;

(iv) The drainage characteristics of the site;

(v) The existence of structurally deficient soils subject to major wind or water erosion events such as slide zones and dunes;

(vi) The existence of designated flood plains; and

(vii) The location of existing encumbrances affecting system placement, such as:

(A) Wells and suction lines;

(B) Water sources and supply lines;

(C) Surface water;

(D) Abandoned wells;

(E) Outcrops of bedrock and restrictive layers;

(F) Buildings;

(G) Property lines and lines of easement;

(H) Interceptors such as footing drains, curtain drains and drainage ditches;

(I) Cuts, banks, and fills;

(J) Driveways and parking areas;

(K) Existing OSS; and

(L) Underground utilities.

(b) Use the soil and site evaluation procedures and terminology in accordance with chapter 3 and Appendix A of the "Design Manual: On-site Wastewater Treatment and Disposal Systems," United States Environmental Protection Agency, EPA-625/1-80-012, October, 1980, except where modified by, or in conflict, with this chapter (available upon written request to the department);

(c) Use the soil names and particle size limits of the United States Department of Agriculture Soil Conservation Service classification system;

(d) Determine texture, structure, compaction and other soil characteristics that affect the treatment and water movement potential of the soil by using normal field and/or laboratory procedures such as particle size analysis; and

(e) Classify the soil as in Table II, Soil Textural Classification:

TABLE II  
SOIL TEXTURAL CLASSIFICATION

Soil Type	Soil Textural Classifications
1A	Very gravelly <sup>1</sup> coarse sands or coarser. All extremely gravelly <sup>2</sup> soils.
1B	Very gravelly medium sand, very gravelly fine sand, very gravelly very fine sand, very gravelly loamy sands.
2A	Coarse sands (also includes ASTM C-33 sand).
2B	Medium sands.
3	Fine sands, loamy coarse sands, loamy medium sands.
4	Very fine sands, loamy fine sands, loamy very fine sands, sandy loams, loams.
5	Silt loams, that are porous and have well developed structure.
6	Other silt loams, sandy clay loams, clay loams, silty clay loams.
Unsuitable for treatment or disposal	Sandy clay, clay, silty clay, and strongly cemented or firm soils.

1 Very Gravelly = >35% and <60% gravel and coarse fragments, by volume.

2 Extremely Gravelly = >60% gravel and coarse fragments, by volume.

(3) The owner of the property or his agent shall:

(a) Prepare the soil log excavation to:

(i) Allow examination of the soil profile in its original position by:

(A) Excavating pits of sufficient dimensions to enable observation of soil characteristics by visual and tactile means to a depth three feet deeper than the anticipated bottom of the disposal component; or

(B) Stopping at a shallower depth if a water table or restrictive layer is encountered; and

(ii) Allow determination of the soil's texture, structure, color, bulk density or compaction, water absorption capabilities or permeability, and elevation of the highest seasonal water table; and

(b) Assume responsibility for constructing and maintaining the soil log excavation in a manner to reduce potential for physical injury by:

(i) Placing excavated soil no closer than two feet of the excavation;

(ii) Providing a ladder, earth ramp or steps for safe egress to a depth of four feet, then scoop out a portion from the floor to gain the additional two foot depth necessary to observe the six feet of soil face, however the scooped portion is not to be entered;

(iii) Provide a physical warning barrier around the excavation's perimeter; and

(iv) Fill the excavation upon completion of the soil log.

(4) The local health officer:

(a) Shall render a decision on the height of the water table within twelve months of receiving the application under precipitation conditions typical for the region;

(b) May require water table measurements to be recorded during months of probable high-water table conditions, if insufficient information is available to determine the highest seasonal water table;

(c) May require any other soil and site information affecting location, design, or installation; and

(d) May reduce the required number of soil logs for OSS serving a single family residence if adequate soils information has previously been developed.

[Statutory Authority: RCW 43.20.050. 94-09-025, § 246-272-11001, filed 4/15/94, effective 1/1/95.]

**WAC 246-272-11501 Design.** (1) The local health officer shall require that on-site sewage systems be designed only by engineers or qualified designers, except:

(a) Where at the discretion of the local health officer a resident owner of the single family residence is allowed to design a system for that residence; or

(b) The local health officer performs the soil and site evaluation and develops the design.

(2) The local health officer and the department shall require the following design criteria:

(a) All the sewage from the building served is directed to the OSS;

(b) Drainage from the surface, footing drains, roof drains, and other nonsewage drains is prevented from entering the OSS and the area where the OSS is located;

(c) The OSS is designed to treat and dispose of the following flows:

(i) For single family residences, one hundred twenty gallons per bedroom per day, with a minimum of two hundred forty gallons per day, unless technical justification is provided to support calculations using a lower design flow;

(ii) For other facilities, the design flows noted in "*Design Manual: On-site Wastewater Treatment and Disposal Systems*," United States Environmental Protection Agency, EPA-625/1-80-012, October, 1980 (available upon written request to the department.) If the type of facility is not listed in the EPA design manual, design flows from one of the following documents are used:

(A) "*Design Standards for Large On-site Sewage Systems*," 1993, Washington state department of health (available upon request to the department); or

(B) "*Criteria for Sewage Works Design*," revised October 1985, Washington state department of ecology (available upon written request to the department of ecology).

(d) Septic tanks:

(i) Are included on the approved list under subsection (5)(d) of this section;

(ii) Have the following minimum liquid capacities:

(A) For a single family residence use Table III, Required Minimum Liquid Volumes of Septic Tanks:



TABLE III  
REQUIRED MINIMUM LIQUID VOLUMES OF SEPTIC TANKS

Number of bedrooms	Required minimum liquid tank volume in gallons
≤ 3	900
4	1000
Each additional bedroom	250

(B) For facilities handling residential sewage, other than one single family residence, one and one-half times the daily design flow with a minimum of one thousand gallons;

(iii) Have clean-out and inspection accesses within twelve inches of finished grade; and

(iv) Are designed with protection against floatation and ground water intrusion in high ground water areas;

(e) Pump chambers:

(i) Are included on the approved list under subsection (5)(d) of this section;

(ii) Have clean-out and inspection accesses at or above finished grade; and

(iii) Are designed with protection against floatation, ground water intrusion, and surface water inflow in high ground water areas;

(f) Methods for effluent distribution shall correlate to soil types 1A through soil type 6 as described by Table IV of this section, except where local regulations approved by the department under WAC 246-272-02001 are more stringent:

TABLE IV  
METHODS OF EFFLUENT DISTRIBUTION FOR SOIL TYPES AND DEPTHS

SOIL TYPE	VERTICAL SEPARATION			
	< 1 foot	≥ 1 foot to < 2 feet	≥ 2 feet to < 3 feet	≥ 3 feet
1A	Not allowed	Pressure Distribution (see note) <sup>1 &amp; 2</sup>	Pressure Distribution (see note) <sup>1</sup>	Pressure Distribution (see note) <sup>1</sup>
2A	Not allowed	Pressure Distribution (see note) <sup>1 &amp; 2</sup>	Pressure Distribution	Pressure Distribution
1B - 6	Not allowed	Pressure Distribution (see note) <sup>1 &amp; 2</sup>	Pressure Distribution	Gravity Distribution

<sup>1</sup> System meeting Treatment Standard 2 required.

<sup>2</sup> Mound systems installed where the original, undisturbed, unsaturated soil depth is between twelve and eighteen inches, require pretreatment by an intermittent sand filter.

(g) SSAS beds are only designed in soil types 2A, 2B, or 3, with a width not exceeding ten feet;

(h) Designs for conventional gravity systems in type 1A soil are not permitted due to the inadequate treatment performance capability of coarse grained soils. However, an exception may be permitted by the local health officer if the site meets all of the following criteria:

(i) System serves a single family residence;

(ii) The lot size is greater than two and one-half acres;

(iii) Annual precipitation in the region is less than twenty-five inches per year as described by "Washington Climate" published jointly by the Cooperative Extension Service, College of Agriculture, and Washington State University (available for inspection at Washington state libraries);

(iv) The system is located outside all areas of special concern defined by WAC 246-272-21501(1);

(v) The system is located outside the twelve county Puget Sound water quality authority region; and

(vi) The geologic conditions beneath the disposal component must satisfy the minimum unsaturated depth requirements to ground water identified by interpreting a readable, representative well log. The method for determination is described by "Design Guideline for Conventional Gravity Systems In Soil Type 1," (available upon written request to the department).

(i) Individual SSAS laterals greater than one hundred feet in length are to use pressure distribution;

(j) OSS having daily design flows between one thousand and three thousand five hundred gallons of sewage per day:

(i) Are located only in soil types 1 - 5;

(ii) Are located on slopes of less than thirty percent, or seventeen degrees; and

(iii) Have pressure distribution;

(k) Conventional gravity systems and conventional pressure distribution system have:

(i) The calculation of absorption area based upon the design flows in (c) of this subsection and loading rates equal to or less than those in Table V, Maximum hydraulic loading rate for residential sewage, and applied only to the bottom of the trench of the excavation.

**TABLE V**  
**MAXIMUM HYDRAULIC LOADING RATE**  
**FOR RESIDENTIAL SEWAGE<sup>1</sup>**

SOIL TYPE	SOIL TEXTURAL CLASSIFICATION DESCRIPTION	LOADING RATE gal./sq. ft./day
1A	Very gravelly <sup>2</sup> coarse sands or coarser, extremely gravelly <sup>3</sup> soils.	Varies according to system selected to meet Treatment Standard 2 <sup>4</sup>
1B	Very gravelly medium sands, very gravelly fine sands, very gravelly very fine sands, very gravelly loamy sands.	Varies according to soil type of the non-gravel portion <sup>5</sup>
2A	Coarse sands (includes the ASTM C-33 sand).	1.2
2B	Medium sands.	1.0
3	Fine sands, loamy coarse sands, loamy medium sands.	0.8
4	Very fine sands, loamy fine sands, loamy very fine sands, sandy loams, loams.	0.6
5	Silt loams that are porous and have well developed structure.	0.45
6	Other silt loams, sandy clay loams, clay loams, silty clay loams.	0.2

<sup>1</sup> Compacted soils, cemented soils, and/or poor soil structure may require a reduction of the loading rate or make the soil unsuitable for conventional OSS systems.

<sup>2</sup> Very gravelly = >35% and <60% gravel and coarse fragments, by volume.

<sup>3</sup> Extremely gravelly = >60% gravel and coarse fragments, by volume.

<sup>4</sup> Due to the highly permeable nature of type 1A soil, only alternative systems which meet or exceed Treatment Standard 2 can be installed. However, a conventional gravity system may be used if it meets all criteria listed under (h) of this subsection. The loading rate for these systems is provided in the appropriate guideline.

<sup>5</sup> The maximum loading rate listed for the soil described as the nongravel portion is to be used for calculating the absorption surface area required. The value is to be determined from this table.

(ii) The bottom of a SSAS shall not be deeper than three feet below the finished grade, except under special conditions approved by the local health officer. The depth of such system shall not exceed ten feet from the finished grade;

(iii) The sidewall below the invert of the distribution pipe is located in original, undisturbed soil;

(iv) Clean gravel, covered with a geotextile; and

(v) A cover of between six and twenty-four inches of mineral soil containing no greater than ten percent organic content over the gravel to preclude accumulation of water over the drainfield.

(l) For other features, conventional gravity systems shall conform with the "Design Manual: On-site Wastewater Treatment and Disposal Systems," United States Environmental Protection Agency, EPA-625/1-80-012, October, 1980 (available upon written request to the department) except where modified by, or in conflict with this section or local regulations.

(3) When proposing the use of OSS for nonresidential sewage, the designer shall provide to the local health officer:

(a) Information to show the sewage is not industrial wastewater;

(b) Information to establish the sewage's strength and identify chemicals found in the sewage that are not found in residential sewage; and

(c) A design providing treatment equal to that required of residential sewage.

(4) The local health officer or department:

(a) Shall approve only OSS designs meeting the requirements of this chapter;

(b) Shall only permit the use of septic tanks, pump chambers, and holding tanks on the approved list under subsection (5)(d) of this section;

(c) Shall not approve designs for:

(i) Cesspools;

(ii) Seepage pits, except as allowed for repairs under WAC 246-272-16501(3); or

(iii) Conventional gravity systems or conventional pressure distribution systems in soil type 1A, except when an applicant meets all criteria established by subsection (2)(h) of this section.

(d) May approve a design for the reserve area different than the design approved for the initial OSS, if both designs meet the requirements of this chapter for new construction; and

(e) May allow the hydraulic loading rate calculated for the infiltration surface area in a disposal component to include six inches of the SSAS sidewall height for determining design flow where total recharge by annual precipitation and irrigation is less than twelve inches per year.

(5) The department shall:

(a) Develop and maintain design and construction standards for septic tanks, pump chambers, and holding tanks.

(b) Review septic tanks, pump chambers, and holding tanks, approving those satisfying the design and construction standards developed by the department.

(c) Require an annual report from the manufacturers or distributors of all products on the approved list under (d) of this subsection which assures that the product still meets the standards defined in this section, before relisting the product.

(d) Maintain a list of approved septic tanks, pump chambers, holding tanks that meet design and construction standards.

(e) Make periodic checks of products approved under this subsection.

(6) Persons desiring to manufacture or distribute septic tanks, pump chambers, holding tanks for use in an OSS shall:

(a) Certify the product meets standards for subsection (5)(a) of this section and submit the required documentation to the department for approval when:

(i) The manufacturer or distributor needs initial departmental review and listing to allow permitting by the local health officer or department;

(ii) The department amends the applicable criteria or standards; or

(iii) The manufacturer or distributor alters the product;

(b) Submit an annual report acceptable to the department to retain departmental approval; and

(c) Pay required fees to the department.

[Statutory Authority: RCW 43.20.050. 94-09-025, § 246-272-11501, filed 4/15/94, effective 1/1/95.]

#### **WAC 246-272-12501 Holding tank sewage systems.**

(1) Persons shall not install or use holding tank sewage

systems for residential development or expansion of residences, whether seasonal or year-round, except as set forth under subsection (2) of this section.

(2) The local health officer may approve installation of holding tank sewage systems only:

(a) For permanent uses limited to controlled, part-time, commercial usage situations, such as, recreational vehicle parks and trailer dump stations.

(b) For interim uses limited to handling of emergency situations.

(c) For repairs as permitted under WAC 246-272-16501(1)(c)(i).

(3) A person proposing to use a holding tank sewage system shall:

(a) Follow established design criteria established by the department;

(b) Submit a management program to the local health officer assuring ongoing operation and maintenance before the local health officer issues the installation permit; and

(c) Use a holding tank on the current approved list under WAC 246-272-11501 (5)(d).

[Statutory Authority: RCW 43.20.050. 94-09-025, § 246-272-12501, filed 4/15/94, effective 1/1/95.]

**WAC 246-272-13501 Installation.** (1) The local health officer and the department shall require approved installers to construct OSS, except as noted under subsection (2) of this section.

(2) The local health officer may allow the resident owner of a single family residence to install the OSS for that single family residence when: The OSS is either located on the same lot as the residence or situated on adjoining property controlled by the owner and legally listed as an encumbrance.

(3) The installer described by either subsection (1) or (2) of this section shall:

(a) Follow the approved design;

(b) Have the approved design in possession during installation;

(c) Only install septic tanks, pump chambers, and holding tanks approved by the department;

(d) Be on the site at all times during the excavation and construction of the OSS;

(e) Install the OSS to be watertight, except for the disposal component;

(f) Cover the installation only after the local health officer has given approval to cover; and

(g) Back fill and grade the site to prevent surface water from accumulating over any component of the OSS.

[Statutory Authority: RCW 43.20.050. 94-09-025, § 246-272-13501, filed 4/15/94, effective 1/1/95.]

**WAC 246-272-14501 Inspection.** (1) The local health officer shall:

(a) Visit the OSS site during the site evaluation, construction, or final construction inspection;

(b) Either inspect the OSS before cover or allow the designer of the OSS to perform the inspection before cover if:

(i) The designer is qualified; and

(ii) The designer is not also named as installer of the system; and

(iii) A qualified installer installed the OSS.

(c) Keep the "as-built" or "record" drawings on file.

(2) The person responsible for the final construction inspection shall:

(a) Assure the OSS meets the approved design; and

(b) Direct the person responsible for final cover of the system to place a permanent marker at finished grade where needed to identify the location of the septic tank's first manhole.

(3) The designer or installer, as directed by the local health officer, upon completion of the OSS shall develop and submit a complete and detailed, "as-built" or "record drawing" to both the health officer and the OSS owner that include:

(a) For new OSS, measurements to existing site features enabling the first tank manhole to be easily located, and a dimensioned reserve area; and

(b) For repaired or altered OSS, the new, repaired, or altered components with their relationship to the existing system.

[Statutory Authority: RCW 43.20.050. 94-09-025, § 246-272-14501, filed 4/15/94, effective 1/1/95.]

#### **WAC 246-272-15501 Operation and maintenance.**

(1) The OSS owner is responsible for properly operating and maintaining the OSS, and shall:

(a) Determine the level of solids and scum in the septic tank once every three years;

(b) Employ an approved pumper to remove the septage from the tank when the level of solids and scum indicates that removal is necessary;

(c) Protect the OSS area and the reserve area from:

(i) Cover by structures or impervious material;

(ii) Surface drainage;

(iii) Soil compaction, for example by vehicular traffic or livestock; and

(iv) Damage by soil removal and grade alteration;

(d) Keep the flow of sewage to the OSS at or below the approved design both in quantity and waste strength;

(e) Operate and maintain alternative systems as directed by the local health officer; and

(f) Direct drains, such as footing or roof drains, away from the area where the OSS is located.

(2) The local health officer shall:

(a) Provide operation and maintenance information to the OSS owner upon approval of any installation, repair, or alteration of an OSS; and

(b) Develop and implement plans to:

(i) Monitor all OSS performance within areas of special concern;

(ii) Initiate periodic monitoring of each OSS no later than January 1, 2000, to assure that each OSS owner properly maintains and operates the OSS in accordance with this section and in accordance with other applicable operation and maintenance requirements.

(iii) Disseminate relevant operation and maintenance information to OSS owners through effective means routinely and upon request; and

(iv) Assist in distributing educational materials to OSS owners.

(3) Persons shall not:

(a) Use or introduce strong bases, acids or chlorinated organic solvents into an OSS for the purpose of system cleaning;

(b) Use a sewage system additive unless it is specifically approved by the department; or

(c) Use an OSS to dispose of waste components atypical of residential wastewater.

(4) The local health officer shall require annual inspections of OSS serving food service establishments and may require pumping as needed.

(5) The local health officer may require the owner of the OSS to:

(a) Use one or more of the following management methods or another method consistent with the following management methods for proper operation and maintenance:

(i) Obtain and comply with the conditions of a renewable or operational permit;

(ii) Employ a public entity eligible under Washington state statutes to, directly or indirectly, manage the OSS; or

(iii) Employ a private management entity, guaranteed by a public entity eligible under Washington state statutes or sufficient financial resources, to manage the OSS;

(b) Evaluate any effects the OSS may have on ground water or surface water; and/or

(c) Dedicate easements for inspections, maintenance, and potential future expansion of the OSS.

(6) Persons may obtain a handbook with material outlining management methods to achieve proper operation, maintenance, and monitoring of OSS from the department one year after the effective date of this chapter.

(7) The local health officer may require installation of observation ports in each individual lateral or bed which extend from the bottom of the gravel to the finished grade for monitoring OSS performance.

[Statutory Authority: RCW 43.20.050. 94-09-025, § 246-272-15501, filed 4/15/94, effective 1/1/95.]

**WAC 246-272-16501 Repair of failures.** (1) When an OSS failure occurs, the OSS owner shall:

(a) Repair or replace the OSS with a conforming system or a Table VI repair either on the:

(i) Property served; or

(ii) Nearby or adjacent property if easements are obtained; or

(b) Connect the residence or facility to a:

(i) Publicly owned LOSS; or

(ii) Privately owned LOSS where it is deemed economically feasible; or

(iii) Public sewer; or

(c) Perform one of the following when requirements in (a) or (b) of this subsection are not feasible:

(i) Use a holding tank; or

(ii) Obtain a National Pollution Discharge Elimination System or state discharge permit from the Washington state department of ecology issued to a public entity or jointly to a public entity and the system owner only when the local health officer determines:

(A) An OSS is not feasible; and

(B) The only realistic method of final disposal of treated effluent is discharge to the surface of the land or into surface water; or

(iii) Abandon the property.

(2) Prior to replacing or repairing the effluent disposal component, the OSS owner shall develop and submit information required under WAC 246-272-09001(1).

(3) The local health officer shall permit a Table VI repair only when:

(a) Installation of a conforming system is not possible; and

(b) Connection to either an approved LOSS or a public sewer is not feasible.

(4) The person responsible for the design shall locate and design repairs to:

(a) Meet the requirements of Table VI if the effluent treatment and disposal component to be repaired or replaced is closer to any surface water, well, or spring that is not used as a public water source as prescribed by the minimum separation required in Table 1 of WAC 246-272-09501(1);

TABLE VI

REQUIREMENTS FOR REPAIR OR REPLACEMENT OF DISPOSAL COMPONENTS NOT MEETING VERTICAL AND HORIZONTAL SEPARATIONS<sup>1,2</sup>

Vertical Separation in feet	Horizontal Separation in Feet <sup>3</sup>		
	< 25	25 - 50	> 50 - ≤100
<1	Treatment Standard 1	Treatment Standard 1	Treatment Standard 2 <sup>4</sup>
1-2	Treatment Standard 1	Treatment Standard 2 <sup>4</sup>	Pressure Distribution
>2	Treatment Standard 2 <sup>4</sup>	Pressure Distribution	Pressure Distribution

<sup>1</sup> The treatment standards refer to effluent quality before discharge to unsaturated, subsurface soil.

<sup>2</sup> The local health officer may permit ASTM C-33 sand to be used as fill to prevent direct discharge of treated effluent to ground water, surface water, or upon the surface of the ground.

<sup>3</sup> The horizontal separation indicated is the distance between the disposal component and the surface water, well, or spring. If the disposal component is up-gradient of a surface water, well, or spring to be used as a potable water source, the next higher standard level of treatment shall apply unless treatment standard 1 is already being met.

<sup>4</sup> Mound systems are not allowed to meet treatment standard 2.

(b) Protect drinking water sources;

(c) Prevent the direct discharge of sewage to ground water, surface water, or upon the surface of the ground;

(d) Meet the horizontal separations under WAC 246-272-09501(1) to public drinking water sources;

(e) Meet other requirements of this chapter to the maximum extent permitted by the site;

(f) Maximize the:

(i) Vertical separation;

(ii) Distance from a well, spring, or suction line; and

(iii) Distance to surface water.

(5) The local health officer shall identify Table VI repair permits for the purpose of tracking future performance.

(6) An OSS owner receiving a Table VI repair permit from the local health officer shall:

(a) Immediately report any failure to the local health officer;

(b) Monitor the performance of the OSS according to the "Interim Guidelines for the Application of Treatment Standards 1 & 2, using Alternative On-site Sewage Treatment/Disposal Systems" amended August 4, 1992, (available upon written request to the department of health) and report the results to the local health officer at a minimum frequency of:

(i) Quarterly when treatment standard 1 is required; and

(ii) Annually when treatment standard 2 is required;

(c) Comply with all local and state requirements stipulated on the permit.

[Statutory Authority: RCW 43.20.050. 94-09-025, § 246-272-16501, filed 4/15/94, effective 1/1/95.]

**WAC 246-272-17501 Expansions.** The local health officer or department shall require an on-site sewage system and a reserve area in full compliance with the new system construction standards specified in this chapter for an expansion of a residence or other facility.

[Statutory Authority: RCW 43.20.050. 94-09-025, § 246-272-17501, filed 4/15/94, effective 1/1/95.]

**WAC 246-272-18501 Abandonment.** Persons permanently removing a septic tank, seepage pit, cesspool, or other sewage container from service shall:

- (1) Have the septage removed by an approved pumper;
- (2) Remove or destroy the lid; and
- (3) Fill the void with soil.

[Statutory Authority: RCW 43.20.050. 94-09-025, § 246-272-18501, filed 4/15/94, effective 1/1/95.]

**WAC 246-272-19501 Septage management.** (1) An individual shall be approved by the local health officer as a qualified pumper before removing septage from an OSS.

- (2) Persons removing septage from an OSS shall:
  - (a) Transport septage or sewage only in vehicles clearly identified with the name of the business and approved by the local health officer;
  - (b) Record and report septage removal to the local health officer;
  - (c) Dispose of septage, or apply septage biosolids to land only in a manner consistent with applicable laws.

[Statutory Authority: RCW 43.20.050. 94-09-025, § 246-272-19501, filed 4/15/94, effective 1/1/95.]

**WAC 246-272-20501 Developments, subdivisions, and minimum land area requirements.** (1) A person proposing the development shall obtain approval from the

local health officer prior to any development where the use of OSS is proposed.

(2) The local health officer shall require the following prior to approving any development:

- (a) Site evaluations as required under WAC 246-272-11001, excluding subsections (3)(a)(i) and (4)(d);
- (b) Where a subdivision with individual wells is proposed:
  - (i) Configuration of each lot to allow a one hundred-foot radius water supply protection zone to fit within the lot lines; or
  - (ii) Establishment of a one hundred-foot protection zone around each existing and proposed well site;
- (c) Where preliminary approval of a subdivision is requested, provision of at least one soil log per proposed lot, unless the local health officer determines existing soils information allows fewer soil logs;
- (d) Determination of the minimum lot size or minimum land area required for the development using Method I and/or Method II:

(i) **METHOD I.** Table VII, Single family residence minimum lot size or minimum land area required per unit volume of sewage, shows the minimum lot size required per single family residence. For developments other than single family residences, the minimum land areas shown are required for each unit volume of sewage.

**TABLE VII  
MINIMUM LAND AREA REQUIREMENT  
SINGLE FAMILY RESIDENCE OR UNIT VOLUME OF SEWAGE**

Type of Water Supply	Soil Type (defined by section 11001 of this chapter)					
	1A, 1B	2A, 2B	3	4	5	6
Public	0.5 acre <sup>1</sup>	12,500 sq. ft.	15,000 sq. ft.	18,000 sq. ft.	20,000 sq. ft.	22,000 sq. ft.
	2.5 acre <sup>2</sup>					
Individual, on each lot	1 acre <sup>1</sup>	1 acre	1 acre	1 acre	2 acres	2 acres
	2.5 acres <sup>2</sup>					

<sup>1</sup> Due to the highly permeable nature of type 1 soil, only alternative systems which meet or exceed Treatment Standard 2 can be installed.

<sup>2</sup> A conventional gravity system in type 1 soil is only allowed if it is in compliance with all conditions listed under WAC 246-272-11501 (2)(h). One of these limiting conditions is a 2.5 acre minimum lot size.

(ii) **METHOD II.** A minimum land area proposal using Method II is acceptable only when the applicant:

- (A) Justifies the proposal through a written analysis of the:
  - (I) Soil type and depth;
  - (II) Area drainage, and/or lot drainage;

- (III) Public health impact on ground and surface water quality;
- (IV) Setbacks from property lines, water supplies, etc.;
- (V) Source of domestic water;
- (VI) Topography, geology, and ground cover;
- (VII) Climatic conditions;
- (VIII) Availability of public sewers;
- (IX) Activity or land use, present, and anticipated;
- (X) Growth patterns;
- (XI) Reserve areas for additional subsurface treatment and disposal;
- (XII) Anticipated sewage volume;
- (XIII) Compliance with current planning and zoning requirements;

(XIV) Possible use of alternative systems or designs;  
 (XV) Existing encumbrances, such as listed in WAC 246-272-09001 (1)(c)(v) and 246-272-11001 (2)(a)(vii); and  
 (XVI) Any other information required by the local health officer.

(B) Shows development with public water supplies having:

(I) At least twelve thousand five hundred square feet lot sizes per single family residence;

(II) No more than 3.5 unit volumes of sewage per day per acre for developments other than single family residences; and

(C) Shows development with individual water supplies having at least one acre per unit volume of sewage; and

(D) Shows land area under surface water is not included in the minimum land area calculation; and

(e) Regardless of which method is used for determining required minimum lot sizes or minimum land area, submittal to the health officer of information consisting of field data, plans, and reports supporting a conclusion the land area provided is sufficient to:

(i) Install conforming OSS;

(ii) Assure preservation of reserve areas for proposed and existing OSS;

(iii) Properly treat and dispose of the sewage; and

(iv) Minimize public health effects from the accumulation of contaminants in surface and ground water.

(3) The local health officer shall require lot areas of twelve thousand five hundred square feet or larger except when a person proposes:

(a) OSS within the boundaries of a recognized sewer utility having a finalized assessment roll; or

(b) A planned unit development with:

(i) A signed, notarized, and recorded deed covenant restricting any development of lots or parcels above the approved density with the density meeting the minimum land area requirements of subsection (2)(d) of this section;

(ii) A public entity responsible for operation and maintenance of the OSS, or a single individual owning the OSS;

(iii) Management requirements under WAC 246-272-08001 when installing a LOSS; and

(iv) Extinguishment of the deed covenant and higher density development allowed only when the development connects to public sewers.

(4) The local health officer may:

(a) Allow inclusion of the area to the centerline of a road or street right-of-way in a Method II determination under subsection (2)(d)(ii) of this section to be included in the minimum land area calculation if:

(i) The dedicated road or street right-of-ways are along the perimeter of the development;

(ii) The road or street right-of-ways are dedicated as part of the proposed development; and

(iii) Lots are at least twelve thousand five hundred square feet in size.

(b) Require detailed plot plans and OSS designs prior to final approval of subdivision proposals;

(c) Require larger land areas or lot sizes to achieve public health protection;

(d) Prohibit development on individual lots within the boundaries of an approved subdivision if the proposed OSS

design does not protect public health by meeting requirements of these regulations; and

(e) Permit the installation of an OSS, where the minimum land area requirements or lot sizes cannot be met, only when all of the following criteria are met:

(i) The lot is registered as a legal lot of record created prior to the effective date of this chapter;

(ii) The lot is outside an area of special concern where minimum land area has been listed as a design parameter necessary for public health protection; and

(iii) The proposed system meets all requirements of these regulations other than minimum land area.

[Statutory Authority: RCW 43.20.050, 94-09-025, § 246-272-20501, filed 4/15/94, effective 1/1/95.]

**WAC 246-272-21501 Areas of special concern.** (1)

The local health officer may investigate and take appropriate action to minimize public health risk in formally designated areas such as:

(a) Shellfish protection districts or shellfish growing areas;

(b) Sole source aquifers designated by the U.S. Environmental Protection Agency;

(c) Areas with a critical recharging effect on aquifers used for potable water as designated under RCW 36.70A.170 (Washington Growth Management Act);

(d) Designated public water supply wellhead protection areas;

(e) Up-gradient areas directly influencing water recreation facilities designated for swimming in natural waters with artificial boundaries within the waters as described by the Water Recreation Facilities Act, chapter 70.90 RCW;

(f) Areas designated by the department of ecology as special protection areas under WAC 173-200-090, water quality standards for ground waters of the state of Washington;

(g) Wetland areas under production of crops for human consumption;

(h) Frequently flooded areas delineated by the Federal Emergency Management Agency; and

(i) Areas identified and delineated by the local board of health in consultation with the department to address public health threat from on-site systems.

(2) The permit issuing authority may impose more stringent requirements on new development and corrective measures to protect public health upon existing developments in areas of special concern, including:

(a) Additional location, design, and/or performance standards for OSS;

(b) Larger land areas for new development;

(c) Prohibition of development;

(d) Additional operation, maintenance, and monitoring of OSS performance;

(e) Requirements to upgrade existing OSS;

(f) Requirements to abandon existing OSS; and

(g) Monitoring of ground water or surface water quality.

(3) Within areas of special concern, to reduce risk of system failures, a person approved or designated by the local health officer shall:

(a) Inspect every OSS at least once every three years;



(b) Submit the following written information to both the local health officer and the property owner within thirty days following the inspection:

- (i) Location of the tank;
- (ii) Structural condition of the tank, including baffles;
- (iii) Depth of solids in tank;
- (iv) Problems detected with any part of the system;
- (v) Maintenance needed;
- (vi) Maintenance provided at time of inspection; and
- (vii) Other information as required by the local health officer.

(c) Immediately report failures to the local health officer.

[Statutory Authority: RCW 43.20.050, 94-09-025, § 246-272-21501, filed 4/15/94, effective 1/1/95.]

**WAC 246-272-22501 Certification of designers, installers, pumpers, inspectors, and maintenance personnel.** Guidelines defining qualifications for designers, installers, pumpers, inspectors and maintenance personnel shall be established by the department. The guidelines shall include, but not be limited to education, experience, testing, and certification.

[Statutory Authority: RCW 43.20.050, 94-09-025, § 246-272-22501, filed 4/15/94, effective 1/1/95.]

**WAC 246-272-23501 Technical review committee.** The department shall:

(1) Maintain a committee consisting of a maximum of nine individuals with technical or scientific knowledge applicable to OSS whose purpose is to provide technical advice to the department; and

(2) Select members for the technical review committee from:

- (a) Local health departments;
  - (b) Engineering firms;
  - (c) The department of ecology;
  - (d) Land sales, development and building industries;
  - (e) Public sewer utilities;
  - (f) On-site sewage system design and installation firms;
  - (g) Environmental organizations;
  - (h) University/college academic communities;
  - (i) On-site sewage system or related product manufacturers; and
  - (j) Other interested organizations or groups.
- (3) Convene meetings as needed.

[Statutory Authority: RCW 43.20.050, 94-09-025, § 246-272-23501, filed 4/15/94, effective 1/1/95.]

**WAC 246-272-24001 State advisory committee.** The department shall:

(1) Maintain an on-site sewage advisory committee to:

- (a) Make recommendations concerning departmental policy and regulations;
- (b) Review program services; and
- (c) Provide input to the department regarding the on-site sewage program;

(2) Select members from agencies, professions, organizations having knowledge and interest in OSS, and groups which are affected by the regulations; and

(3) Convene meetings as needed.

[Title 246 WAC—page 434]

[Statutory Authority: RCW 43.20.050, 94-09-025, § 246-272-24001, filed 4/15/94, effective 1/1/95.]

**WAC 246-272-25001 Waiver of state regulations.**

(1) For individual, site-by-site waiver requests, if concurrence is granted by the department, the local health officer may grant a waiver from specific requirements in this chapter for OSS under three thousand five hundred gallons per day only after the following procedure has been completed:

(a) The applicant submits a waiver application to the local health officer, including justification describing how the requested waiver is consistent with purpose and objectives to meet the public health intent of this chapter;

(b) If the local health officer determines that the waiver is consistent with the standards in and the intent of this chapter;

(c) On a quarterly basis, the local health officer will forward to the department any approved or denied waivers for their records.

(2) The department may grant a waiver from specific requirements in this chapter for a LOSS if a person submits a completed departmental waiver application and required fee to the department, including justification showing the requested waiver is consistent with the LOSS standards in this chapter, and is consistent with the purpose and objectives of this chapter to assure public health protection.

(3) If an applicant desires to modify and resubmit a previously denied waiver request, the process described above in subsection (1) of this section for OSS under three thousand five hundred gallons per day, or subsection (2) of this section for a LOSS shall be followed again.

[Statutory Authority: RCW 43.20.050, 95-09-018, § 246-272-25001, filed 4/11/95, effective 5/12/95; 94-09-025, § 246-272-25001, filed 4/15/94, effective 1/1/95.]

**WAC 246-272-26001 Enforcement.** (1) The department or the local health officer:

(a) Shall enforce the rules of chapter 246-272 WAC; or

(b) May refer cases within their jurisdiction to the local prosecutor's office or office of the attorney general, as appropriate.

(2) When a person violates the provisions under this chapter, the department, local health officer, local prosecutor's office, or office of the attorney general may initiate enforcement or disciplinary actions, or any other legal proceeding authorized by law, including but not limited to any one or a combination of the following:

(a) Informal administrative conferences, convened at the request of the department or owner, to explore facts and resolve problems;

(b) Orders directed to the owner and/or operator of the OSS and/or person causing or responsible for the violation of the rules of chapter 246-272 WAC;

(c) Denial, suspension, modification, or revocation of permits, approvals, or certification; and

(d) Civil or criminal action.

(3) Orders authorized under this section include the following:

(a) Orders requiring corrective measures necessary to effect compliance with chapter 246-272 WAC which may include a compliance schedule; and

(b) Orders to stop work and/or refrain from using any OSS or portion of the OSS or improvements to the OSS until all permits, certifications, and approvals required by rule or statute are obtained.

(4) Enforcement orders issued under this section shall:

(a) Be in writing;

(b) Name the person or persons to whom the order is directed;

(c) Briefly describe each action or inaction constituting a violation of the rules of chapter 246-272 WAC, or applicable local code;

(d) Specify any required corrective action, if applicable;

(e) Specify the effective date of the order, with time or times of compliance;

(f) Provide notice of the consequences of failure to comply or repeated violation, as appropriate. Such notices may include a statement that continued or repeated violation may subject the violator to:

(i) Denial, suspension, or revocation of a permit approval, or certification; and/or

(ii) Referral to the office of the county prosecutor or attorney general; and/or

(iii) Other appropriate remedies;

(g) Provide the name, business address, and phone number of an appropriate staff person who may be contacted regarding an order;

(h) Comply with chapters 43.70 and 34.05 RCW if issued by the department.

(5) Enforcement orders shall be personally served in the manner of service of a summons in a civil action or in a manner showing proof of receipt.

(6) The department shall have cause to deny the application or reapplication for an operational permit or to revoke, suspend, or modify a required operational permit of any person who has:

(a) Failed or refused to comply with the provisions of chapter 246-272 WAC, or any other statutory provision or rule regulating the operation of an OSS; or

(b) Obtained or attempted to obtain a permit or any other required certificate or approval by misrepresentation.

(7) For the purposes of subsection (6) of this section and WAC 246-272-27001, a person is defined to include:

(a) Applicant;

(b) Re-applicant;

(c) Permit holder; or

(d) Any individual associated with (a), (b), or (c) of this subsection including, but not limited to:

(i) Board members;

(ii) Officers;

(iii) Managers;

(iv) Partners;

(v) Association members;

(vi) Agents; and in addition

(vii) Third persons acting with the knowledge of such persons.

[Statutory Authority: RCW 43.20.050. 94-09-025, § 246-272-26001, filed 4/15/94, effective 1/1/95.]

**WAC 246-272-27001 Notice of decision—Adjudicative proceeding.** (1) All local boards of health shall:

(a) Maintain an administrative appeals process to consider procedural and technical conflicts arising from the administration of local regulations; and

(b) Establish rules for conducting hearings requested to contest a local health officer's actions.

(2) The department shall provide notice of a denial, suspension, modification or revocation of a permit, certification, or approval consistent with RCW 43.70.115, chapter 34.05 RCW, and chapter 246-10 WAC.

(3) A person contesting a departmental decision regarding a permit, certificate, approval, or fine may file a written application for an adjudicative proceeding consistent with chapter 246-10 WAC.

(4) Department actions are governed under the Administrative Procedure Act, chapter 34.05 RCW, RCW 43.70.115, this chapter, and chapter 246-10 WAC.

[Statutory Authority: RCW 43.20.050. 94-09-025, § 246-272-27001, filed 4/15/94, effective 1/1/95.]

**WAC 246-272-28001 Severability.** If any provision of this chapter or its application to any person or circumstances is held invalid, the remainder of this chapter, or the application of the provision to other persons or circumstances shall not be affected.

[Statutory Authority: RCW 43.20.050. 94-09-025, § 246-272-28001, filed 4/15/94, effective 1/1/95.]

**WAC 246-272-990 Fees.** (1) The minimum fee for required review of larger on-site system's engineering reports and plans and specifications shall be four hundred dollars. If review time exceeds eight hours, fifty dollars for each additional hour or part of an hour shall be added to the minimum fee. The fee for pre-site inspections for larger on-site systems shall be one hundred dollars per visit. The fee for final inspection of larger on-site systems shall be one hundred dollars per site visit.

(2) The minimum fee for required review of proprietary devices shall be two hundred dollars. If review time exceeds four hours, fifty dollars for each additional hour or part of an hour shall be added to the minimum fee.

(3) The minimum fee for required review of experimental systems shall be four hundred dollars. If review time exceeds eight hours, fifty dollars for each additional hour or part of an hour shall be added to the minimum fee.

[Statutory Authority: RCW 43.70.040. 91-02-050 (Order 122), § 246-272-990, filed 12/27/90, effective 1/31/91.]

## Chapter 246-273 WAC

### ON-SITE SEWAGE SYSTEM ADDITIVES

#### WAC

246-273-001

246-273-010

246-273-020

246-273-030

246-273-040

246-273-050

246-273-060

246-273-065

246-273-070

246-273-080

Purpose and authority.

Definitions.

Applicability.

Additive review and approval application—Process and requirements.

Review criteria and decision-making procedures.

Ingredients—Prohibitions and conditions.

Unfair practices.

Reregistration.

Confidentiality.

Enforcement.

(b) Orders to stop work and/or refrain from using any OSS or portion of the OSS or improvements to the OSS until all permits, certifications, and approvals required by rule or statute are obtained.

(4) Enforcement orders issued under this section shall:

(a) Be in writing;

(b) Name the person or persons to whom the order is directed;

(c) Briefly describe each action or inaction constituting a violation of the rules of chapter 246-272 WAC, or applicable local code;

(d) Specify any required corrective action, if applicable;

(e) Specify the effective date of the order, with time or times of compliance;

(f) Provide notice of the consequences of failure to comply or repeated violation, as appropriate. Such notices may include a statement that continued or repeated violation may subject the violator to:

(i) Denial, suspension, or revocation of a permit approval, or certification; and/or

(ii) Referral to the office of the county prosecutor or attorney general; and/or

(iii) Other appropriate remedies;

(g) Provide the name, business address, and phone number of an appropriate staff person who may be contacted regarding an order;

(h) Comply with chapters 43.70 and 34.05 RCW if issued by the department.

(5) Enforcement orders shall be personally served in the manner of service of a summons in a civil action or in a manner showing proof of receipt.

(6) The department shall have cause to deny the application or reapplication for an operational permit or to revoke, suspend, or modify a required operational permit of any person who has:

(a) Failed or refused to comply with the provisions of chapter 246-272 WAC, or any other statutory provision or rule regulating the operation of an OSS; or

(b) Obtained or attempted to obtain a permit or any other required certificate or approval by misrepresentation.

(7) For the purposes of subsection (6) of this section and WAC 246-272-27001, a person is defined to include:

(a) Applicant;

(b) Re-applicant;

(c) Permit holder; or

(d) Any individual associated with (a), (b), or (c) of this subsection including, but not limited to:

(i) Board members;

(ii) Officers;

(iii) Managers;

(iv) Partners;

(v) Association members;

(vi) Agents; and in addition

(vii) Third persons acting with the knowledge of such persons.

[Statutory Authority: RCW 43.20.050. 94-09-025, § 246-272-26001, filed 4/15/94, effective 1/1/95.]

**WAC 246-272-27001 Notice of decision—Adjudicative proceeding.** (1) All local boards of health shall:

(a) Maintain an administrative appeals process to consider procedural and technical conflicts arising from the administration of local regulations; and

(b) Establish rules for conducting hearings requested to contest a local health officer's actions.

(2) The department shall provide notice of a denial, suspension, modification or revocation of a permit, certification, or approval consistent with RCW 43.70.115, chapter 34.05 RCW, and chapter 246-10 WAC.

(3) A person contesting a departmental decision regarding a permit, certificate, approval, or fine may file a written application for an adjudicative proceeding consistent with chapter 246-10 WAC.

(4) Department actions are governed under the Administrative Procedure Act, chapter 34.05 RCW, RCW 43.70.115, this chapter, and chapter 246-10 WAC.

[Statutory Authority: RCW 43.20.050. 94-09-025, § 246-272-27001, filed 4/15/94, effective 1/1/95.]

**WAC 246-272-28001 Severability.** If any provision of this chapter or its application to any person or circumstances is held invalid, the remainder of this chapter, or the application of the provision to other persons or circumstances shall not be affected.

[Statutory Authority: RCW 43.20.050. 94-09-025, § 246-272-28001, filed 4/15/94, effective 1/1/95.]

**WAC 246-272-990 Fees.** (1) The minimum fee for required review of larger on-site system's engineering reports and plans and specifications shall be four hundred dollars. If review time exceeds eight hours, fifty dollars for each additional hour or part of an hour shall be added to the minimum fee. The fee for pre-site inspections for larger on-site systems shall be one hundred dollars per visit. The fee for final inspection of larger on-site systems shall be one hundred dollars per site visit.

(2) The minimum fee for required review of proprietary devices shall be two hundred dollars. If review time exceeds four hours, fifty dollars for each additional hour or part of an hour shall be added to the minimum fee.

(3) The minimum fee for required review of experimental systems shall be four hundred dollars. If review time exceeds eight hours, fifty dollars for each additional hour or part of an hour shall be added to the minimum fee.

[Statutory Authority: RCW 43.70.040. 91-02-050 (Order 122), § 246-272-990, filed 12/27/90, effective 1/31/91.]

## Chapter 246-273 WAC

### ON-SITE SEWAGE SYSTEM ADDITIVES

#### WAC

246-273-001

246-273-010

246-273-020

246-273-030

246-273-040

246-273-050

246-273-060

246-273-065

246-273-070

246-273-080

Purpose and authority.

Definitions.

Applicability.

Additive review and approval application—Process and requirements.

Review criteria and decision-making procedures.

Ingredients—Prohibitions and conditions.

Unfair practices.

Reregistration.

Confidentiality.

Enforcement.

246-273-990 Fees.

**WAC 246-273-001 Purpose and authority.** (1) This chapter establishes the review, criteria and decision-making procedures for evaluating on-site sewage disposal system additives to determine whether individual additives have an adverse effect on public health or water quality.

(2) The Washington state department of health administers this chapter under the authority and requirements of chapter 70.118 RCW.

[Statutory Authority: Chapter 70.118 RCW and RCW 43.70.040. 95-24-062, § 246-273-001, filed 12/1/95, effective 1/1/96.]

**WAC 246-273-010 Definitions. "Additive"** means a commercial product intended to affect the performance or aesthetics of an on-site sewage disposal system.

**"Additive manufacturer"** means any person who manufactures, formulates, blends, packages, or repackages an additive product for sale, use, or distribution within Washington state.

**"Approved"** means a written statement of acceptability, in terms of the requirements of this chapter, issued by the Washington state department of health.

**"Chemical additive"** means those additives containing acids, bases, or other chemicals deemed unsafe by the department for use in an on-site sewage disposal system. Chemicals identified as unsafe are specified in WAC 246-273-050.

**"Department"** means the Washington State Department of Health, P.O. Box 47826, Olympia, Washington 98504-7826.

**"Failure"** means:

- Effluent has been discharged on the surface of the ground prior to approved treatment; or
  - Effluent has percolated to the surface of the ground;
- or
- Effluent has contaminated or threatens to contaminate a ground water supply.

**"On-site sewage disposal system"** means any system of piping, treatment devices, or other facilities that convey, store, treat, or dispose of sewage on the property where it originates or on nearby property under the control of the user where the system is not connected to a public sewer system. For purposes of this chapter, an on-site sewage disposal system does not include indoor plumbing and associated fixtures.

**"Person"** means any individual, corporation, company, association, society, firm, partnership, joint stock company, or any governmental agency, or the authorized agents of any such entities.

**"Sewage"** means any urine, feces, and the water carrying human wastes, including kitchen, bath, and laundry wastes from residences, buildings, industrial establishments or other places.

[Statutory Authority: Chapter 70.118 RCW and RCW 43.70.040. 95-24-062, § 246-273-010, filed 12/1/95, effective 1/1/96.]

**WAC 246-273-020 Applicability.** (1) After July 1, 1994, no person shall use, sell, or distribute an on-site sewage disposal system chemical additive in Washington state.

[Title 246 WAC—page 436]

(2) After January 1, 1996, no person shall use, sell or distribute an on-site sewage disposal system additive whose ingredients have not been approved by the department in accordance with requirements of chapter 70.118 RCW and this chapter.

[Statutory Authority: Chapter 70.118 RCW and RCW 43.70.040. 95-24-062, § 246-273-020, filed 12/1/95, effective 1/1/96.]

**WAC 246-273-030 Additive review and approval application—Process and requirements.** (1) Manufacturers desiring to sell, advertise, or distribute an on-site sewage disposal system additive for use in Washington state must request and obtain departmental review and approval of their product(s) by submitting a complete application, including:

- (a) Comprehensive, yet concise, response to the questionnaire (see subsection (3) of this section);
- (b) A product sample in the labeled container intended for sale or distribution;
- (c) The on-site sewage disposal system additive evaluation fee described in WAC 246-273-990.

(2) All submitted material (written responses and other materials) must be legible, typed or printed. Hand-written responses to the application questions or hand-written notes or other submitted documentation may, at the discretion of the department, result in rejection of the application.

(3) The questionnaire for review and approval of an on-site sewage disposal system additive consists of four parts: Applicant information, product information, product literature, and certification. All applicants must provide complete written responses to the following questions:

#### **Applicant information (AI)**

- (AI-1) Applicant name, mailing address, street address, city/town, state, zip code, telephone and FAX, with area code, time zone. The applicant must be vested with the authority to represent the manufacturer in this capacity.
- (AI-2) Contact individual (if different from person in Item 1) name, mailing address, street address, city/town, state, zip code, telephone and FAX, with area code, time zone.
- (AI-3) Manufacturing facility location/address, mailing address, street address, city/town, state, zip code.
- (AI-4) Name of on-site sewage disposal system additive product. (One product per application. If identical formulations of product are marketed under different product names or distributor labels, list them here. If product formulations vary, submit separate applications for each product.)
- (AI-5) List of firms, companies, or persons distributing the on-site sewage disposal system additive product in Washington state. Do not list product retailers. Provide the following information for each: Contact person name, mailing address, street address, city/town, state, zip code, telephone and FAX, with area code, time zone.

#### **Product information (PI)**

- (PI-1) List all physical, chemical, biological, or other agents which make up the additive and provide

toxicity information for each component (provide material safety data sheet, if possible). Provide trade and scientific name and formula of chemical agents. Specify trade and scientific name(s) of bacteria and enzymes, and characterization (origin, native occurrence, pathogenicity, etc.). Report formulation in "% by weight," including inert and active ingredients, and trace amounts, if any, of prohibited ingredients (WAC 246-273-050).

- (PI-2) Describe the anticipated use of the additive in the on-site sewage system. Include in the description where and how the product is to be applied, the frequency of application, who will perform the application, and the amount and/or concentration of the product per application. For additives with chemical constituents, indicate the amount and/or concentration of each chemical constituent applied and resulting from application of the product.
- (PI-3) Describe the function of the additive within the on-site sewage disposal system and explain in detail how the additive achieves this function.
- (PI-4) List all known reactions and by-products produced by the use of the additive including:
- The product's effect on bacteria normally found in a septic tank or aerobic treatment device and the soil surrounding a subsurface drainfield, and in the treatment media of a sand filter or sand mound system; and
  - pH range adjustment in all parts of an on-site sewage disposal system.
- (PI-5) Provide any known or projected limitation on the use of the on-site sewage disposal system additive.
- (PI-6) Provide reports of any available studies on the use of the on-site sewage disposal system additive to support the responses to questions PI-1 through PI-5 and to demonstrate the product's safety (lack of harm) to the public health, water quality, on-site sewage system components and function. Include monitoring reports and data from actual field or laboratory-based on-site sewage system studies.
- (PI-7) Attach any formal approvals or other acceptances from other jurisdictions (private sector, state, or federal) for use of the on-site sewage disposal system additive.

#### Product literature (PL)

- (PL-1) Attach single copies of sewage system additive product marketing, sales, distribution, advertising literature/materials intended for use in Washington state, not otherwise submitted as part of the complete application.

#### Certification (C)

- (C-1) The following statement must be included as part of a complete application:

"I certify that I represent (INSERT MANUFACTURING COMPANY NAME), that I am authorized to prepare, or direct the preparation of, this application, and

that the product presented for review and approval contains no prohibited ingredients (WAC 246-273-050). I attest, under penalty of law, that this document and all attachments, to the best of my knowledge and belief, are true, accurate, and complete."

- (C-2) Lines or space must be provided for the applicant's signature, printed name of preparer (if different than the applicant), preparer's signature (if needed) and date.

[Statutory Authority: Chapter 70.118 RCW and RCW 43.70.040. 95-24-062, § 246-273-030, filed 12/1/95, effective 1/1/96.]

#### WAC 246-273-040 Review criteria and decision-making procedures. The department shall:

- (1) Upon receipt of an application for review and approval of an on-site sewage disposal system additive:

(a) Determine if the application is complete. The department may return incomplete applications, suspending further review until a completed application is submitted. Processing time period begins anew with resubmittal.

(b) Notify the applicant, in writing, that the completed application has been received, and inform the applicant of the anticipated time period for review. A decision of either approval or denial shall be made within forty-five calendar days of receiving a complete application.

(2) Upon review of a complete application, grant or deny approval of the on-site sewage disposal system additive for use, sale, or distribution in Washington state, informing the applicant, in writing, of either approval or denial of the application. Notice of denial shall include explanation of the reason(s) for denial.

(3) Evaluate the request for approval of an on-site sewage disposal system additive according to the following criteria:

(a) Does the additive contain any ingredients deemed unsafe by the department? If yes, the application for approval shall be denied.

(b) Does the additive contain acids or bases that raise or lower the pH of the contents of a septic tank, or wastewater in any other portion of an on-site sewage disposal system, outside of a pH range between 6.0 - 8.0? If yes, the application for approval shall be denied.

(c) Would use of the additive (when applied according to the manufacturer's product-use instructions) adversely affect public health or water quality (surface water or ground water) by either the nature of the ingredients or the effect of the additive on the function of the on-site sewage system? If yes, the application for approval shall be denied.

(d) If the review according to the criteria listed above determines that none of these questions are answered "yes," the on-site sewage disposal system additive shall be approved.

[Statutory Authority: Chapter 70.118 RCW and RCW 43.70.040. 95-24-062, § 246-273-040, filed 12/1/95, effective 1/1/96.]

**WAC 246-273-050 Ingredients—Prohibitions and conditions.** (1) The following substances and compounds shall not be ingredients of approved on-site sewage disposal system additives. Trace amounts of these substances and compounds may exist in approved on-site sewage disposal



24P PCB-1016

25P toxaphene

**Table III-Other Toxic Pollutants (Metals and Cyanide) and Total Phenols**

Antimony, Total  
 Arsenic, Total  
 Beryllium, Total  
 Cadmium, Total  
 Chromium, Total  
 Copper, Total  
 Lead, Total  
 Mercury, Total  
 Nickel, Total  
 Selenium, Total  
 Silver, Total  
 Thallium, Total  
 Zinc, Total  
 Cyanide, Total  
 Phenols, Total

**Table IV-Toxic Pollutants and Hazardous Substances Required To Be Identified By Existing Dischargers If Expected To Be Present***Toxic Pollutants*

Asbestos

*Hazardous Substances*

Acetaldehyde  
 Allyl alcohol  
 Allyl chloride  
 Amyl acetate  
 Aniline  
 Benzonitrile  
 Benzyl chloride  
 Butyl acetate  
 Butylamine  
 Captan  
 Carbaryl  
 Carbofuran  
 Carbon disulfide  
 Chlorpyrifos  
 Coumaphos  
 Cresol  
 Crotonaldehyde  
 Cyclohexane  
 2,4-D(2,4-Dichlorophenoxy acetic acid)  
 Diazinon  
 Dicamba  
 Dichlobenil  
 Dichlone  
 2,2-Dichloropropionic acid  
 Dichlorvos  
 Diethyl amine  
 Dimethyl amine  
 Dinitrobenzene  
 Diquat  
 Disulfoton  
 Diuron  
 Epichlorohydrin  
 Ethion  
 Ethylene diamine

Ethylene dibromide  
 Formaldehyde  
 Furfural  
 Guthion  
 Isoprene  
 Isopropanolamine  
 Dodecylbenzenesulfonate  
 Kelthane  
 Kepone  
 Malathion  
 Mercaptodimethur  
 Methoxychlor  
 Methyl mercaptan  
 Methyl methacrylate  
 Methyl parathion  
 Mevinphos  
 Mexacarbate  
 Monoethyl amine  
 Monomethyl amine  
 Naled  
 Napthenic acid  
 Nitrotoluene  
 Parathion  
 Phenolsulfanate  
 Phosgene  
 Propargite  
 Propylene oxide  
 Pyrethrins  
 Quinoline  
 Resorcinol  
 Strontium  
 Strychnine  
 Styrene  
 2,4,5-T (2,4,5-Trichlorophenoxy acetic acid)  
 TDE (Tetrachlorodiphenylethane)  
 2,4,5-TP (2-(2,4,5-Trichlorophenoxy propanoic acid)  
 Trichlorofan  
 Triethanolamine  
 Dodecylbenzenesulfonate  
 Triethylamine  
 Trimethylamine  
 Uranium  
 Vanadium  
 Vinyl acetate  
 Xylene  
 Xylenol  
 Zirconium

(b) Other chemicals deemed by the department to be detrimental to on-site sewage disposal system function, public health, or water quality.

(2) The department may prohibit (not approve on-site sewage system additives containing) acids and bases depending upon the effect on public health or ground water of their concentration when applied according to the manufacturer's product-use instructions.

[Statutory Authority: Chapter 70.118 RCW and RCW 43.70.040. 95-24-062, § 246-273-050, filed 12/1/95, effective 1/1/96.]



**WAC 246-273-060 Unfair practices.** Manufacturers of approved additives advertised, sold, or distributed in Washington state shall:

(1) Make no claims relating to the elimination of the need for septic tank pumping or proper septic tank maintenance;

(2) List the components of additive products on the product label, along with information regarding instructions for use and precautions;

(3) Make no false statements, design, or graphic representation relative to an additive product that is inconsistent with RCW 70.118.060, 70.118.070, or 70.118.080; and

(4) Make no claims, either direct or implied, about the performance of the product based on state approval of its ingredients.

[Statutory Authority: Chapter 70.118 RCW and RCW 43.70.040. 95-24-062, § 246-273-060, filed 12/1/95, effective 1/1/96.]

**WAC 246-273-065 Reregistration.** Reregister, by written correspondence to the department, their on-site sewage disposal system additive product(s) each time the product formulation changes. The department may require a new review and approval for reregistration of products that undergo formulation changes.

[Statutory Authority: Chapter 70.118 RCW and RCW 43.70.040. 95-24-062, § 246-273-065, filed 12/1/95, effective 1/1/96.]

**WAC 246-273-070 Confidentiality.** (1) Manufacturers shall submit a signed confidentiality statement if any information submitted would, if made public, divulge confidential business information, methods, or processes entitled to protection as trade secrets of the manufacturer, and identify any such information.

(2) The department shall not disclose any information obtained from manufacturers, when stated by the manufacturer, that the information, if made public, would divulge confidential business information, methods or processes entitled to protection as trade secrets of the manufacturer.

[Statutory Authority: Chapter 70.118 RCW and RCW 43.70.040. 95-24-062, § 246-273-070, filed 12/1/95, effective 1/1/96.]

**WAC 246-273-080 Enforcement.** (1) The attorney general, or appropriate city or county prosecuting attorney may bring appropriate action to enjoin any violation of the:

(a) Prohibition on the sale or distribution of on-site sewage disposal system additives; or

(b) Conditions of RCW 70.118.080 Additives—Unfair practices, and WAC 246-273-060 (1) through (4).

(2) The department may rescind approval of an on-site sewage disposal system additive in response to:

(a) Demonstrated link to on-site sewage disposal system failure resulting from use (consistent with the manufacturer's product-use instructions) of an approved additive; or

(b) Documentation that ingredients or formulation of an approved on-site sewage system additive differs from the ingredients or formulation information submitted for review, and upon which departmental approval was granted.

[Statutory Authority: Chapter 70.118 RCW and RCW 43.70.040. 95-24-062, § 246-273-080, filed 12/1/95, effective 1/1/96.]

**WAC 246-273-990 Fees.** (1) The applicant shall pay to the department, with the application, a three hundred fifty dollar fee. This fee includes two hundred dollars for developing criteria and review procedures, plus one hundred fifty dollars for up to two hours of product-specific review. Additional review time will be billed at seventy-five dollars per hour.

(2) All fees must be paid prior to the departments' approval.

[Statutory Authority: Chapter 70.118 RCW and RCW 43.70.040. 95-24-062, § 246-273-990, filed 12/1/95, effective 1/1/96.]

## Chapter 246-280 WAC

### RECREATIONAL SHELLFISH BEACHES

#### WAC

246-280-001	Authority, purpose, and scope.
246-280-010	Definitions.
246-280-015	General administration.
246-280-020	Recreational shellfish beach classification.
246-280-030	Water quality criteria and standards.
246-280-040	Marine water quality testing.
246-280-050	Shellfish meat quality standards and testing.
246-280-060	Recreational shellfish beach sanitary survey.
246-280-070	PSP monitoring of recreational beaches.
246-280-080	Public information and notification.

#### WAC 246-280-001 Authority, purpose, and scope.

(1) Authority. Under the authority of RCW 43.20.050, powers and duties of state board of health, these regulations are hereby established as minimum requirements for the monitoring and classification of recreational shellfish beaches.

(2) Purpose. It is the purpose of chapter 246-280 WAC to protect public health and establish procedures for evaluating the sanitary quality of recreational shellfish beaches.

(3) Scope.

(a) These regulations shall apply to recreational shellfish beaches under public ownership. Commercial shellfish harvest, even though it may occur on publicly owned beaches, is governed by chapter 246-282 WAC and chapter 69.30 RCW.

(b) These regulations shall apply to recreationally harvested shellfish on privately owned beaches when the general public has unlimited access to beaches for recreational shellfishing. The department may evaluate and monitor these privately owned beaches if the department determines it to be in the public interest.

(4) Other statutes related to this chapter are:

(a) Chapter 69.30 RCW, sanitary control of shellfish; and

(b) Chapter 246-282 WAC, sanitary control of shellfish.

[Statutory Authority: RCW 43.20.050. 92-02-019 (Order 225B), § 246-280-001, filed 12/23/91, effective 1/23/92; 91-02-051 (Order 124B), recodified as § 246-280-001, filed 12/27/90, effective 1/31/91. Statutory Authority: Chapter 90.70 RCW. 89-20-020 (Order 335), § 248-52-001, filed 9/27/89, effective 10/28/89.]

#### WAC 246-280-010 Definitions.

(1) Abbreviations:

(a) "ml" means milliliter; and

(b) "PSP" means paralytic shellfish poisoning.

(2) "Beach evaluation" means the examination of the sanitary conditions of recreational shellfish beaches through

water quality testing, shellfish tissue testing, PSP testing, and sanitary surveys.

(3) "Beach inventory" means the department's list of recreational shellfish beaches governed by chapter 246-280 WAC.

(4) "Closed classification" means a beach exceeds the standards for safe shellfish harvest.

(5) "Conditionally open classification" means a recreational shellfish beach meets the standards for safe shellfish harvest during well-defined time periods, such as dry weather months, and is closed to shellfish harvest when the standards are exceeded.

(6) "Department" means the Washington state department of health (DOH).

(7) "Emergency closure" means temporary closure of a recreational shellfish beach when a contamination event is suspected of impacting an open or conditionally open beach.

(8) "Geometric mean value" means a statistical calculation giving a mean value of data points. Geometric mean value is a term used in state water quality standards. The calculation is:

(a)  $a \times b \times c \times d = y$ ; and

(b)  $n$ th root of  $y$  = geometric mean value.  $N$  = number of data points which determines the power of the root.

(9) "Health officer" means the health officer or an authorized representative of the city, county, city-county health department or district.

(10) "Local board of health" means the city, town, county, city-county, or district board of health as defined under chapters 70.05, 70.08, and 70.46 RCW.

(11) "Open classification" means a recreational shellfish beach which complies with WAC 246-280-030 standards for safe shellfish harvest without any restrictions due to health hazards.

(12) "Paralytic shellfish poisoning (PSP)" means a human illness caused by eating shellfish that contain high levels of toxin which results from the shellfish consuming large amounts of toxin-producing microscopic marine organism called *Gonyaulax catenella*.

(13) "Public ownership" means owned by the federal government, state government, a county, a city, or a port district.

(14) "Recreational shellfish beach" means any beach under public ownership available to the public and any privately owned beach where the general public has unlimited access to recreationally harvest shellfish.

(15) "Recreational shellfish harvest" means to harvest shellfish for personal consumption with no intention for sale or barter.

(16) "Sanitary survey" means an evaluation of the sanitary conditions of the shoreline and uplands of a recreational shellfish beach.

(17) "Shellfish" means, for the purposes of chapter 246-280 WAC, all varieties of oysters, clams, mussels, and scallops.

(18) "Unclassified" means a recreational shellfish beach which does not have an initial classification because the department has incomplete sanitary survey data.

(19) "Water quality study" means an evaluation of the sanitary conditions of the marine water of a recreational shellfish beach described under WAC 246-280-030 and 246-280-040.

[Statutory Authority: RCW 43.20.050, 92-02-019 (Order 225B), § 246-280-010, filed 12/23/91, effective 1/23/92; 91-02-051 (Order 124B), recodified as § 246-280-010, filed 12/27/90, effective 1/31/91. Statutory Authority: Chapter 90.70 RCW, 89-20-020 (Order 335), § 248-52-005, filed 9/27/89, effective 10/28/89.]

**WAC 246-280-015 General administration.** (1) The department and the health officer for each local health jurisdiction shall develop a joint plan of operation designating the roles of each agency for administering chapter 246-280 WAC. This plan shall:

(a) Specifically designate those recreational shellfish beaches included in the joint plan;

(b) Establish whether the department or the health officer shall assume primary responsibility for an identified beach;

(c) Provide for a minimum acceptable frequency of beach evaluation;

(d) Specify who has responsibility for water quality studies, sanitary surveys, PSP monitoring, beach classification, and public notification;

(e) Be signed by the secretary and the chairperson of the local board of health;

(f) Be updated as needed to ensure proper operation of the plan; and

(g) Identify a process for implementing remedial actions to correct pollution sources where deemed appropriate by the department for those beaches classified as closed or conditionally open.

(2) If the local board of health adopts rules governing recreational shellfish harvest within its jurisdiction, the adopted rules shall be consistent with chapter 246-280 WAC.

(3) The department shall develop guidelines on water quality monitoring, PSP monitoring, shoreline survey procedures, public information/notification, and other topics.

(4) Throughout this chapter, the term "health officer" may be substituted for the term "department" if the joint plan of operation delegates authority for action to the health officer.

[Statutory Authority: RCW 43.20.050, 92-02-019 (Order 225B), § 246-280-015, filed 12/23/91, effective 1/23/92; 91-02-051 (Order 124B), recodified as § 246-280-015, filed 12/27/90, effective 1/31/91. Statutory Authority: Chapter 90.70 RCW, 89-20-020 (Order 335), § 248-52-010, filed 9/27/89, effective 10/28/89.]

**WAC 246-280-020 Recreational shellfish beach classification.** (1) The department or the health officer for each local health jurisdiction as designated in the joint plan of operation, under WAC 246-280-015, shall classify recreational shellfish beaches, based on the risk to public health from consuming shellfish. After completing an initial classification, the department or the health officer for each local health jurisdiction shall make an annual update based on the additional data collected during the year.

(2) The joint plan of operation's criteria used to classify beaches shall include the following:

(a) Water quality data;

(b) A sanitary survey of pollution sources; and

(c) A review of natural and synthetic toxins, including PSP.

(3) The department shall classify recreational shellfish beaches as follows:

(a) Open;

- (b) Conditionally open;
- (c) Closed;
- (d) Emergency closure; and
- (e) Unclassified.

[Statutory Authority: RCW 43.20.050. 92-02-019 (Order 225B), § 246-280-020, filed 12/23/91, effective 1/23/92; 91-02-051 (Order 124B), recodified as § 246-280-020, filed 12/27/90, effective 1/31/91. Statutory Authority: Chapter 90.70 RCW. 89-20-020 (Order 335), § 248-52-020, filed 9/27/89, effective 10/28/89.]

**WAC 246-280-030 Water quality criteria and standards.** (1) The department shall classify the beach as open when the following three conditions are met:

(a) The marine water covering a recreational shellfish beach shall not exceed a geometric mean value of fourteen fecal coliform bacteria/100 ml of water. In addition, not more than ten percent of the individual water samples may exceed forty-three fecal coliform bacteria/100 ml of water. The geometric mean value shall be calculated on no less than fifteen samples for each water quality station;

(b) Upon completion of a sanitary survey, there are no major sources of pollution of public health significance identified as affecting the beach; and

(c) Natural and synthetic toxin levels shall not exceed established standards.

(2) The department shall classify the beach as conditionally open when standards for open criteria are met during a well-defined and predictable time period, such as dry weather months. Use of the conditionally open classification shall be limited to beaches where sufficient data are available to establish the beach meets the open criteria for well-defined time periods.

(3) The department shall classify a beach as closed for failing to meet the open or conditionally open standards and the beach shall not be used for recreational shellfish harvest.

(4) The department shall list a recreational shellfish beach as unclassified until complete sanitary data are available. The department shall list initially the beach as unclassified on the beach inventory.

(5) In the event an open or conditionally open beach is suspected of being impacted by a source of pollution or other threat to public health, the department shall implement an emergency closure immediately. The closure shall remain in effect until the department's investigation verifies the beach is safe for recreational shellfish harvesting.

[Statutory Authority: RCW 43.20.050. 91-02-051 (Order 124B), recodified as § 246-280-030, filed 12/27/90, effective 1/31/91. Statutory Authority: Chapter 90.70 RCW. 89-20-020 (Order 335), § 248-52-030, filed 9/27/89, effective 10/28/89.]

**WAC 246-280-040 Marine water quality testing.** The department shall test marine water in recreational shellfish areas for fecal coliform bacteria according to sampling and analysis protocols under *National Shellfish Sanitation Program Manual of Operations* for commercial shellfish harvest areas.

(1) The department shall establish the location of marine water sampling stations for each recreational shellfish beach to adequately reflect potential pollution sources for the area.

(2) The department shall collect a minimum of fifteen samples at each station prior to an area receiving a classifi-

cation. The department shall time each sampling to reflect potential adverse pollution events.

[Statutory Authority: RCW 43.20.050. 91-02-051 (Order 124B), recodified as § 246-280-040, filed 12/27/90, effective 1/31/91. Statutory Authority: Chapter 90.70 RCW. 89-20-020 (Order 335), § 248-52-040, filed 9/27/89, effective 10/28/89.]

**WAC 246-280-050 Shellfish meat quality standards and testing.** (1) The department shall:

(a) Periodically test shellfish meat samples for fecal coliform bacteria to provide supportive information for water quality data;

(b) Establish a routine schedule for collection of shellfish samples for each beach; and

(c) Sample all beaches classified as open or conditionally open at a frequency determined by the director.

(2) The department shall conduct tests to identify the chemicals present in the shellfish tissue when a toxic chemical is suspected to impact a recreational beach. In the event of an imminent health hazard, the department shall implement an emergency closure.

[Statutory Authority: RCW 43.20.050. 91-02-051 (Order 124B), recodified as § 246-280-050, filed 12/27/90, effective 1/31/91. Statutory Authority: Chapter 90.70 RCW. 89-20-020 (Order 335), § 248-52-050, filed 9/27/89, effective 10/28/89.]

**WAC 246-280-060 Recreational shellfish beach sanitary survey.** In addition to the evaluation of the shellfish growing waters, and before establishing a classification for the beach, the department shall conduct a sanitary survey of the shoreline and upland areas located adjacent to recreational shellfish beaches. The sanitary survey shall be updated as necessary to reflect changes in shoreline and upland sanitary conditions. A sanitary survey shall consist of:

(1) Identifying and evaluating point source discharges in the vicinity of the beach;

(2) Evaluating all on-site sewage disposal systems in the survey area; and

(3) Evaluating impacts from other nonpoint sources in the area, such as animal waste and storm water.

[Statutory Authority: RCW 43.20.050. 91-02-051 (Order 124B), recodified as § 246-280-060, filed 12/27/90, effective 1/31/91. Statutory Authority: Chapter 90.70 RCW. 89-20-020 (Order 335), § 248-52-060, filed 9/27/89, effective 10/28/89.]

**WAC 246-280-070 PSP monitoring of recreational beaches.** (1) The department shall conduct a paralytic shellfish poisoning (PSP) monitoring program for recreational shellfish beaches.

(2) The department shall coordinate the monitoring program with the health officer. The joint plan of operation developed between the department and the health officer shall include the following elements:

(a) A sampling schedule which includes the beaches sampled and the frequency of the sampling;

(b) Designation of responsibility for a sample collection; and

(c) A system of establishing beach closures due to PSP which includes:

(i) Closing the beach when the level of toxin exceeds 80 micrograms of toxin per 100 grams of shellfish meat;

(ii) Maintaining the beach closure until two consecutive samples of the same species test below the standard of 80 micrograms of toxin per 100 grams of shellfish meat; and

(iii) Closing beaches suspected of posing a PSP threat to public health when they are located in a PSP-impacted area that cannot be sampled on a frequent basis. The beaches shall remain closed until samples verify the area is safe to reopen.

[Statutory Authority: RCW 43.20.050. 91-02-051 (Order 124B), recodified as § 246-280-070, filed 12/27/90, effective 1/31/91. Statutory Authority: Chapter 90.70 RCW. 89-20-020 (Order 335), § 248-52-070, filed 9/27/89, effective 10/28/89.]

**WAC 246-280-080 Public information and notification.** The department shall develop guidelines describing an approved public information/public notification system. The guidelines shall include methods for public notification, public meetings, beach posting, public announcements, and other control mechanisms the jurisdictional health agency deems necessary. The department shall provide for a public notification process of beach classifications under the joint plan of operation.

[Statutory Authority: RCW 43.20.050. 91-02-051 (Order 124B), recodified as § 246-280-080, filed 12/27/90, effective 1/31/91. Statutory Authority: Chapter 90.70 RCW. 89-20-020 (Order 335), § 248-52-080, filed 9/27/89, effective 10/28/89.]

## Chapter 246-282 WAC

### SANITARY CONTROL OF SHELLFISH

#### WAC

246-282-001	Scope and purpose.
246-282-005	Minimum performance standards.
246-282-010	Definitions.
246-282-020	Growing areas.
246-282-030	Storage, cleansing and washing and shipping of shellstock.
246-282-040	Shucking of shellfish.
246-282-050	Packing of shucked shellfish.
246-282-060	Personal health and cleanliness.
246-282-070	Construction and maintenance.
246-282-080	Identification and records.
246-282-090	Certificate of compliance—Certificate of approval— Suspension for revocation of certificate of approval— Licensure—Revocation of license.
246-282-100	Notice of decision—Adjudicative proceeding.
246-282-110	Administrative provisions.
246-282-120	Penalty clause.
246-282-130	Separability clause.
246-282-990	Shellfish program certification fees.

**WAC 246-282-001 Scope and purpose.** These requirements, as authorized under chapter 69.30 RCW (chapter 144, Laws of 1955), establish minimum performance standards for the growing, harvesting, processing, packing, storage, transporting, and selling of shellfish for human consumption.

[Statutory Authority: RCW 43.20.050. 91-02-051 (Order 124B), recodified as § 246-282-001, filed 12/27/90, effective 1/31/91. Statutory Authority: RCW 69.30.030. 78-08-059 (Order 163), § 248-58-001, filed 7/24/78; Regulation 58.001, effective 3/11/60.]

**WAC 246-282-005 Minimum performance standards.** (1) Every person engaged in a shellfish operation shall comply with and shall be subject to:

(a) The "satisfactory compliance" standards of the 1995 revision of the National Shellfish Sanitation Program (NSSP) Manual of Operations Part I and II, published by the United States Department of Health and Human Services, Public Health Service, Food and Drug Administration. Copies can be obtained through the U.S. Food and Drug Administration, Shellfish Sanitation Branch, and the Washington state department of health, office of shellfish programs.

(b) All other provisions of this chapter.

(2) Where a "satisfactory compliance" provision is inconsistent with a provision otherwise established under this chapter or other state law or rule, the more stringent provision, as determined by the department, shall apply.

[Statutory Authority: RCW 69.30.030. 96-18-096, § 246-282-005, filed 9/4/96, effective 10/5/96; 94-23-026, § 246-282-005, filed 11/8/94, effective 12/9/94.]

**WAC 246-282-010 Definitions.** The following definitions shall apply in the interpretation and the implementation of these rules and regulations:

(1) "Approved" means acceptable to the secretary based on his or her determination as to conformance with appropriate standards and good public health practice.

(2) "Commercial quantity" means any quantity exceeding:

(a) Forty pounds of mussels;

(b) One hundred oysters;

(c) Fourteen horse clams;

(d) Six geoducks; or

(e) Fifty pounds of hard or soft shell clams.

(3) "Department" means the state department of health.

(4) "Easily cleanable" means readily accessible and of such material and finish, and so fabricated that residue may be completely removed by approved cleaning methods.

(5) "Food contact surfaces" means those surfaces of equipment and utensils with which the shellfish meat normally comes in contact, and those surfaces that drain onto surfaces that may come into contact with said food being processed.

(6) "Person" means any individual, firm, corporation, partnership, company, association, or joint stock association, and the legal successor thereof.

(7) "Person in charge" means an individual responsible for the supervision of employees and the management of any shellfish operation as defined in subsection (12) of this section.

(8) "Sanitized" means the treatment of clean surfaces of equipment and utensils by an approved process which is effective in destroying microorganisms, including pathogens.

(9) "Secretary" means the secretary of the department of health or the secretary's authorized representative.

(10) "Shellfish" means all varieties of fresh or frozen oysters, clams, or mussels, either shucked or in the shell, and all fresh or frozen edible products thereof.

(11) "Shellfish growing areas" means the lands and waters in and upon which shellfish are grown for harvesting in commercial quantities or for sale for human consumption.

(12) "Shellfish operation" means any activity in the harvesting, transporting, processing, to include, but not limited to culling, shucking, packing, and repacking or shipping or reshipping of shellfish in commercial quantities or for sale for human consumption.

[Statutory Authority: RCW 69.30.030, 92-02-019 (Order 225B), § 246-282-010, filed 12/23/91, effective 1/23/92. Statutory Authority: RCW 43.20.050, 91-02-051 (Order 124B), recodified as § 246-282-010, filed 12/27/90, effective 1/31/91. Statutory Authority: RCW 69.30.030 and 43.20.050, 85-21-048 (Order 296), § 248-58-005, filed 10/14/85. Statutory Authority: RCW 69.30.030, 78-08-059 (Order 163), § 248-58-005, filed 7/24/78.]

**WAC 246-282-020 Growing areas.** (1) All shellfish to be sold as defined in RCW 69.30.010(2) in the state of Washington shall be obtained from approved growing areas or from approved growing areas outside the state that have programs of control and standards equivalent to that of the state of Washington.

(2) Approved shellfish growing areas shall be located in areas not adversely affected by human waste, industrial or natural toxins, recreational use, or other sources of pollutants which may have a detrimental influence on the water quality of the shellfish growing beds and subsequent hazards to the human consumers of shellfish.

(3) No commercial quantities of shellfish or shellfish to be sold as defined in RCW 69.30.010(2), for human consumption, shall be harvested from growing areas which are not approved as provided herein: *Provided*, That permission may be granted by the director for the removal of shellfish from nonapproved growing areas for relaying to approved growing areas under the following conditions:

(a) Shellfish shall be relayed to a designated, approved growing area for a minimum of two weeks or for a longer time period as prescribed by the director.

(b) Relaying and subsequent removal from the approved area for sale or shipment shall be under the supervision of the director.

(c) Records shall be kept showing growing areas from which the shellfish were taken, where relayed, dates of relaying, and dates of harvesting.

(4) All boats, oyster harvesters, and floats used for harvesting or transporting shellfish shall be so constructed, operated, and maintained as to prevent contamination or deterioration of the shellfish. Approved facilities shall be provided for the disposal of human waste.

[Statutory Authority: RCW 43.20.050, 91-02-051 (Order 124B), recodified as § 246-282-020, filed 12/27/90, effective 1/31/91. Statutory Authority: RCW 69.30.030 and 43.20.050, 85-21-048 (Order 296), § 248-58-010, filed 10/14/85. Statutory Authority: RCW 69.30.030, 78-08-059 (Order 163), § 248-58-010, filed 7/24/78; Regulation 58.010, effective 3/11/60.]

**WAC 246-282-030 Storage, cleansing and washing and shipping of shellstock.** (1) Shellstock shall be stored, handled, and shipped under such temperature conditions as will keep them alive, and shall be protected from contamination at all times.

(2) All shellstock prior to opening or shipping shall be reasonably clean so that mud, sand, and extraneous material will not be transferred to the opened product during processing.

(3) Water used for washing, or "wet storage" (natural storing and cleansing), of shellstock shall be obtained from an approved growing area, or from other sources which meet or exceed the water quality standards of an approved growing area.

(4) Wet storage of shellstock may be practiced only upon approval of the director. A detailed description and map denoting the location of the wet storage area shall accompany the request.

[Statutory Authority: RCW 69.30.030, 92-02-019 (Order 225B), § 246-282-030, filed 12/23/91, effective 1/23/92. Statutory Authority: RCW 43.20.050, 91-02-051 (Order 124B), recodified as § 246-282-030, filed 12/27/90, effective 1/31/91. Statutory Authority: RCW 69.30.030, 78-08-059 (Order 163), § 248-58-020, filed 7/24/78; Regulation 58.020, effective 3/11/60.]

**WAC 246-282-040 Shucking of shellfish.** (1) Shellfish shall be shucked in a manner that will minimize contamination. Only live shellfish shall be shucked. Shucked shellfish shall be processed within one hour after opening or shall be rapidly cooled to a product temperature of forty-five degrees Fahrenheit or less within two hours after shucking.

(2) Shucking containers shall be rinsed with running tap water before each filling. Shucker's colanders shall be rinsed with running tap water at two and one-half hour intervals or less during use.

(3) Shells from which meats have been shucked shall be removed from the plant at sufficient intervals to prevent the interference with the sanitary operation of the plant.

[Statutory Authority: RCW 43.20.050, 91-02-051 (Order 124B), recodified as § 246-282-040, filed 12/27/90, effective 1/31/91. Statutory Authority: RCW 69.30.030, 78-08-059 (Order 163), § 248-58-030, filed 7/24/78; Regulation 58.030, effective 3/11/60.]

**WAC 246-282-050 Packing of shucked shellfish.** (1) Shucked shellfish shall be protected from contamination during all phases of processing and shall be packed in approved containers which are clean, and free from contamination.

(2) Shucked shellfish shall be maintained at forty degrees Fahrenheit or less until received by the consumer. A temperature of thirty-four degrees Fahrenheit to forty degrees Fahrenheit shall be maintained in refrigerators where shucked shellfish are stored.

(3) Shellfish which are to be marketed as a frozen product shall be frozen as quickly as practicable and maintained at a product temperature of zero degrees Fahrenheit or less until received by the consumer.

(4) The packing of shucked shellfish shall take place in the same plant in which the shellfish are shucked, unless specific approval for repacking is granted by the director. Repacking plants shall meet all requirements as specified for packing plants. Frozen shucked shellfish shall not be repacked.

[Statutory Authority: RCW 43.20.050, 91-02-051 (Order 124B), recodified as § 246-282-050, filed 12/27/90, effective 1/31/91. Statutory Authority: RCW 69.30.030, 78-08-059 (Order 163), § 248-58-040, filed 7/24/78; Regulation 58.040, effective 3/11/60.]

**WAC 246-282-060 Personal health and cleanliness.** (1) Persons ill with or the carrier of a communicable disease

which is transmissible through food and is in the infectious stage, or persons having exposed boils, infected lesions or wounds, or similar skin infections, or persons having an acute respiratory infection shall not work in any growing area, shucking, packing or repacking plant in any capacity where they might contaminate the shellfish or food contact surfaces with pathogenic organisms. Both the person in charge and the employee shall be responsible for compliance with the requirements of this section.

(2) Persons who shuck or handle shucked shellfish shall wear clean, waterproof aprons or coats and clean clothing that can be easily cleaned and shall practice good personal cleanliness during all periods of duty. They shall wash their hands thoroughly with soap and warm water before starting to work and as often thereafter as may be necessary to remove soil and contamination. Gloves or other protective gear worn on the hands shall be made of waterproof, easily cleanable material and shall be clean. When manual handling of shucked shellfish becomes necessary, sanitized rubber gloves shall be worn or the hands shall be thoroughly cleaned immediately before such handling. Effective means shall be taken to keep hair from shellfish (shucked meats) and from food contact surfaces.

[Statutory Authority: RCW 43.20.050. 91-02-051 (Order 124B), recodified as § 246-282-060, filed 12/27/90, effective 1/31/91. Statutory Authority: RCW 69.30.030. 78-08-059 (Order 163), § 248-58-050, filed 7/24/78; Regulation 58.050, effective 3/11/60.]

#### **WAC 246-282-070 Construction and maintenance.**

(1) Equipment and utensils: All food contact surfaces of equipment and utensils shall be constructed of nontoxic, corrosion resistant, and nonabsorbent materials, designed to be easily cleanable and shall be clean and in an approved condition of repair. Equipment shall be installed and maintained so that it and adjacent areas can be readily cleaned. Articles intended for single service use shall be used only once and then discarded.

Utensils and food contact surfaces of equipment shall be cleaned, sanitized and stored in an approved manner so as to be protected from recontamination. Cleaning and sanitization shall occur before use and at such intervals as necessary to preclude contamination of the shucked product.

Nonfood contact surfaces of equipment shall be constructed of corrosion resistant and nonabsorbent materials, designed to be easily cleanable and shall be clean and in an approved condition of repair.

(2) Physical facilities: The plant shall be so arranged to facilitate the flow of the product through processing and storage areas in a manner that will preclude contamination. Shucking and packing operations shall be conducted in separate rooms. Only authorized persons shall be allowed in the packing room during periods of operation.

Interior surfaces of rooms or areas where shellfish are stored, processed or utensils or hands are washed, and in walk-in refrigerators and freezers shall be easily cleanable, clean and in an approved condition of repair.

Rooms for utensil and packaging material storage shall be provided, and separate from areas which shall be provided for employee clothing storage. These areas shall be separate and apart from the shucking and packing rooms.

Approved lighting, heating and ventilation shall be provided. Approved measures for control of rodents and

flies, roaches, and other insects on the premises shall be utilized. Live animals shall be excluded from all areas of the plant.

(3) Sanitary facilities: Hot and cold water adequate in quality and quantity, and under pressure shall be provided or easily accessible to all rooms in which shellfish are processed or utensils are washed. The water supply, plumbing, sewage, garbage and rubbish disposal, handwashing, toilet and other facilities shall be installed, operated, and maintained in an approved manner.

Ice shall be from an approved source and shall be stored and handled in a manner as to be protected from contamination.

Handwashing facilities consisting of a lavatory or lavatories and equipped with hot and cold or tempered running water, hand-cleansing soap or detergent, single service towels or approved hand drying devices shall be located and maintained to permit convenient use by all employees in shellfish processing areas, utensil washing areas, and toilet rooms or vestibules. Such facilities shall be kept clean and in an approved condition of repair.

[Statutory Authority: RCW 43.20.050. 91-02-051 (Order 124B), recodified as § 246-282-070, filed 12/27/90, effective 1/31/91. Statutory Authority: RCW 69.30.030. 78-08-059 (Order 163), § 248-58-060, filed 7/24/78; Regulation 58.060, effective 3/11/60.]

#### **WAC 246-282-080 Identification and records. (1)**

Shellfish shall be so identified by label, tag or other permanent means at the wholesale or retail level that any given container of shucked meats or lot of shellstock can be traced to the original growing area source(s).

(2) Shipments of shellfish in the shell shall be accompanied by a tag, label or other mark showing that the shipper has been duly certified by the state in which the growing area is located.

(3) Shucked shellfish shall be packed, shipped and sold retail in approved containers that are legibly marked by embossing, lithographing, or other permanent means with the name, address, and certification number of the packer, and the date packed or coded in such a manner that the date packed can be determined. Fresh packs shall be labeled with wording equivalent to "keep refrigerated," and frozen packs shall be labeled with wording equivalent to "keep frozen."

(4) All shippers, reshippers, packers, repackers, and wholesalers shall keep an accurate record of all lots of shellfish received, shipped and sold. Retailers shall keep a record of all lots received. Such records shall be kept on file for a minimum of six months.

(5) Information recorded by the harvester-shipper shall include: (a) Location of harvesting area(s) by name or code, (b) name and quantity of shellfish, (c) date of harvest, (d) date shipped.

(6) Shucker-packers and repackers shall record the following information: (a) Location of harvesting area(s) by name or code, or name of harvester, (b) name and quantity of shellfish, (c) date of harvest or date received, and (d) packing date.

[Statutory Authority: RCW 69.30.030. 92-02-019 (Order 225B), § 246-282-080, filed 12/23/91, effective 1/23/92. Statutory Authority: RCW 43.20.050. 91-02-051 (Order 124B), recodified as § 246-282-080, filed 12/27/90, effective 1/31/91. Statutory Authority: RCW 69.30.030. 78-08-



059 (Order 163), § 248-58-070, filed 7/24/78; Regulation 58.070, effective 3/11/60.]

**WAC 246-282-090 Certificate of compliance—Certificate of approval—Suspension for revocation of certificate of approval—Licensure—Revocation of license.**

(1) Only shellfish bearing, upon the tag, bill of lading, label or container as required in WAC 246-282-080(2), a certificate of compliance with the sanitary requirements of this state, or a state, territory, province of, or country of origin whose requirements are equal or comparable to these regulations, may be sold or offered for sale for human consumption in the state of Washington.

(2) No person shall possess a commercial quantity of shellfish or sell or offer to sell for human consumption shellfish in the state which have not been grown, harvested, shucked, packed, or shipped in accordance with the provisions of these regulations or chapter 69.30 RCW.

(3) Certificates of approval for shellfish growing areas and/or for shellfish operations, as hereinabove defined, shall be issued and administered as prescribed in chapter 69.30 RCW, and may be denied, suspended, or revoked for any failure or refusal to maintain the sanitary requirements or to comply with the provisions of these regulations or chapter 69.30 RCW.

(4) No person shall operate a "shellfish operation," as defined hereinabove, without having first obtained a valid operating license issued by the director. Each license shall be issued only for the shellfish operation and person named in the application and no license shall be transferable or assignable except with the written approval of the director. An operating license will be issued to any person who shall evidence:

(a) Possession of, or an approved application for, a valid certificate of approval as described hereinabove;

(b) Continued compliance by the licensee, the licensee's employees, or those under the licensee's supervision, with the rules and regulations herein and with chapter 69.30 RCW which compliance, in part, shall include the licensee's processing and/or sale of shellfish which have been harvested only from growing areas certified by the director in the name of the licensee or the person from whom the licensee has obtained said shellfish.

(5) The department shall have cause to deny, revoke, or suspend the license required herein where any licensee has:

(a) Had his or her certificate of approval, as defined above, and as issued by the department, revoked, suspended, or denied, for any reason;

(b) Failed or refused to comply with any of the rules and regulations of the state board of health or chapter 69.30 RCW;

(c) Harvested shellfish from any growing area which does not have a valid certificate of approval issued in the name of said licensee or in the name of the person from whom the licensee has obtained said shellfish;

(d) Obtained or attempted to obtain an operating license, certificate of compliance, or certificate of approval by fraudulent means or misrepresentation.

(6) All licenses and certificates issued under the provisions of these regulations shall be posted in a conspicuous place on the licensed premises. The licensee, or at least one employee thereof, shall have a certificate of approval on

his or her person while engaged in the harvesting of shellfish. Such certificates of approval shall be provided by the department. All licenses and certificates of approval shall expire on the thirtieth day of September each year.

(7) Certificates of approval shall be displayed, upon request, to an authorized representative of the department, a fisheries patrol officer, or an ex officio patrol officer. Failure to do so subjects the grower to the penalty provisions of this chapter, as well as immediate seizure of the shellfish by the representative or officer.

[Statutory Authority: RCW 69.30.030. 92-02-019 (Order 225B), § 246-282-090, filed 12/23/91, effective 1/23/92. Statutory Authority: RCW 43.20.050. 91-02-051 (Order 124B), recodified as § 246-282-090, filed 12/27/90, effective 1/31/91. Statutory Authority: RCW 69.30.030 and 43.20.050. 85-21-048 (Order 296), § 248-58-080, filed 10/14/85. Statutory Authority: RCW 69.30.030. 78-08-059 (Order 163), § 248-58-080, filed 7/24/78; Regulation 58.080, effective 3/11/60.]

**WAC 246-282-100 Notice of decision—Adjudicative proceeding.**

(1) The department's notice of a denial, suspension, modification, or revocation of a license shall be consistent with RCW 43.70.115. An applicant or license holder has the right to an adjudicative proceeding to contest the decision.

(2) The department's notice of imposition of a civil fine shall be consistent with RCW 43.70.095. A person upon whom the department imposes a civil fine has the right to an adjudicative proceeding to contest the decision.

(3) A license applicant or holder or a person upon whom the department imposes a civil fine, contesting a department decision, shall within twenty-eight days of receipt of the decision:

(a) File a written application for an adjudicative proceeding by a method showing proof of receipt with the Administrative Hearings Unit, Department of Health, 1300 Quince Street S.E., P.O. Box 47851, Olympia, WA 98504-7851; and

(b) Include in or with the application:

(i) A specific statement of the issue or issues and law involved;

(ii) The grounds for contesting the department decision; and

(iii) A copy of the contested department decision.

(4) The proceeding is governed by the Administrative Procedure Act (chapter 34.05 RCW), this chapter, and chapter 246-08 WAC. If a provision in this chapter conflicts with chapter 246-08 WAC, the provision in this chapter governs.

[Statutory Authority: RCW 69.30.030. 92-02-019 (Order 225B), § 246-282-100, filed 12/23/91, effective 1/23/92. Statutory Authority: RCW 43.20.050. 91-02-051 (Order 124B), recodified as § 246-282-100, filed 12/27/90, effective 1/31/91. Statutory Authority: Chapter 34.05 RCW and RCW 69.30.030. 90-06-049 (Order 040), § 248-58-085, filed 3/2/90, effective 3/2/90.]

**WAC 246-282-110 Administrative provisions.** (1) The person in charge of shellfish growing areas or processing plant operations shall ensure operations are conducted in a manner complying with the requirements of these regulations. The person in charge shall periodically inspect the shellfish operations to determine compliance with these regulations, and shall take measures to correct any deficiencies thereby revealed.



(2) The director shall have access to and be permitted to inspect any and all areas comprising the shellfish operation for the purpose of determining compliance with these regulations and chapter 69.30 RCW, or for the purpose of determining whether any person, shellfish, or condition in the shellfish operation constitutes a nuisance or a threat to the public health.

(a) In the course of such inspection, the director may, among other things, examine or sample the shellfish in the shellfish operation as often as necessary to determine its safeness for human consumption, and he or she may also examine any and all pertinent records pertaining to shellstock, shellfish, or operational supplies purchased, received, or used, and records pertaining to persons employed.

(b) If, after the inspection of a shellfish operation, the director finds such operation fails to comply with the requirements of the law, rules and regulations, he or she shall issue to the person in charge of the shellfish operation a written order specifying the manner in which the operation fails to comply with the law, rules and regulations and which sets out a specific and reasonable period of time for correction of the violations.

(c) In the event the person in charge of the shellfish operation fails to correct the violations as required by the order of the director, the director may revoke the certificate of compliance and/or license of such person and/or initiate such legal enforcement proceeding as authorized by law.

(d) During or after an investigation or inspection of a shellfish operation, the director may, if he or she suspects the shellfish are unsafe for human consumption, give to the owner or person in charge of the shellfish operation a written hold order prohibiting the disposition or sale of the shellfish pending the director's further investigation of the shellfish's safety. The person in charge shall thereafter cease from offering such shellfish for human consumption and shall store such shellfish in a suitable place as prescribed by the director until the hold order is lifted or modified by the director or by a court of competent jurisdiction. Shellfish placed under a hold order shall not be destroyed for at least two days and shall not be held longer than fifteen days; however, upon a finding that the shellfish are safe for human consumption, the director may release them immediately.

(e) If, during an inspection of a shellfish harvesting operation, the owner or person in charge of the operation fails to immediately display his or her certificate of approval upon request from an authorized representative of the department, a fisheries patrol officer, or an ex officio patrol officer, a written hold order may be issued prohibiting the disposition or sale of the shellfish or the shellfish may immediately be seized. If a hold order is issued, the person in charge shall thereafter cease from offering such shellfish for human consumption and shall store such shellfish in a suitable place as prescribed by the director until the hold order is lifted or modified by the director or by a court of competent jurisdiction. Shellfish placed under a hold order or seizure shall not be destroyed for at least two days and shall not be held longer than fifteen days; however, upon a finding that the shellfish are safe for human consumption, the director shall determine disposition. If the director determines that the operation is certified, the shellfish shall be released to the owner or person in charge of the opera-

tion. If the director determines that the operation is not certified, the director may release the shellfish according to his or her discretion.

(f) If after investigation the director determines the shellfish are unsafe for human consumption, he or she shall give the owner or person in charge of the shellfish operation a written abatement order, which abatement order may require any or all of the following measures:

(i) A permanent prohibition against the sale or disposition of the shellfish for human consumption;

(ii) Immediate destruction of the shellfish in question by measures such as denaturing and placement in a sanitary landfill. Such destruction shall be accomplished by at least two employees of the department or authorized representatives.

(iii) At the discretion of the director, shellfish having been found to be unsafe for human consumption may be relayed to an approved growing area for subsequent reharvest.

(g) When the director, after conducting an appropriate investigation, determines either that:

(i) A shellfish operation or employee is transmitting a disease; or

(ii) There is a substantial risk a shellfish operation or employee may be transmitting a disease, he or she may thereafter give to the owner or person in charge of the shellfish operation an abatement order, which order may require any or all of the following measures:

(A) Immediate closure of the shellfish operation until, in the opinion of the director, no further danger of a disease outbreak exists;

(B) Immediate exclusion of the employee from all shellfish operations or food service establishments;

(C) Restriction of the employee's service to some area of the operation where there would be no danger of transmitting disease.

(h) As an alternative to the abatement order described in subsection (2)(g) of this section, the director may require any or all of the employees to submit to adequate medical and laboratory examinations, including examination of their bodily discharges.

(i) No person shall remove or alter a notice or tag constituting a hold order or abatement order placed on the shellfish by the director, and neither such shellfish nor its container shall be relabeled, repacked, reprocessed, altered, disposed of, destroyed, or released without permission of the director, except on order by a court of competent jurisdiction.

(j) In the event the person in charge of the shellfish operation fails to comply with either the hold order or the abatement order described above, the director may revoke the certificate of compliance and/or license of such person and/or initiate such legal enforcement proceedings as are authorized by law; except that the director may undertake summary abatement of the shellfish, an article, or a condition which is so severely contaminated or contaminating that a delay in abatement until legal enforcement proceedings could be had would pose a grave threat to the public health.

[Statutory Authority: RCW 43.20.050, 91-02-051 (Order 124B), recodified as § 246-282-110, filed 12/27/90, effective 1/31/91. Statutory Authority: RCW 69.30.030 and 43.20.050, 85-21-048 (Order 296), § 248-58-090, filed

10/14/85. Statutory Authority: RCW 69.30.030. 78-08-059 (Order 163), § 248-58-090, filed 7/24/78; Regulation 58.090, effective 3/11/60.]

**WAC 246-282-120 Penalty clause.** Any person found violating any of the provisions of these regulations or chapter 69.30 RCW shall be guilty of a gross misdemeanor, and upon conviction thereof shall be subject to a fine of not less than twenty-five dollars nor more than one thousand dollars, or imprisonment in the county jail of the county in which the offense was committed for not less than thirty days nor more than one year, or to both fine and imprisonment.

[Statutory Authority: RCW 43.20.050. 91-02-051 (Order 124B), recodified as § 246-282-120, filed 12/27/90, effective 1/31/91. Statutory Authority: RCW 69.30.030 and 43.20.050. 85-21-048 (Order 296), § 248-58-500, filed 10/14/85. Statutory Authority: RCW 69.30.030. 78-08-059 (Order 163), § 248-58-500, filed 7/24/78.]

**WAC 246-282-130 Separability clause.** Should any section, paragraph, clause or phrase of these rules and regulations be declared unconstitutional or invalid for any reason, the remainder of said rules and regulations shall not be affected thereby.

[Statutory Authority: RCW 43.20.050. 91-02-051 (Order 124B), recodified as § 246-282-130, filed 12/27/90, effective 1/31/91. Statutory Authority: RCW 69.30.030. 78-08-059 (Order 163), § 248-58-900, filed 7/24/78.]

**WAC 246-282-990 Shellfish program certification fees.** (1) Annual certificate fees shall be:

Type of Operation	Annual Fee
Shellstock Shipper	
0 - 49 Acres	\$250.
50 or greater Acres	\$400.
Shucker-Packer	
Plants with floor space < 2000 sq. ft.	\$450.
Plants with floor space > 2000 sq. ft. and < 5000 sq. ft.	\$550.
Plants with floor space > 5000 sq. ft.	\$1,000.

(2) Type of operations are defined as follows:

(a) "Shellstock shipper" shall mean shippers growing, harvesting, buying, or selling shellstock. Shellstock shippers are not authorized to shuck shellfish or to repack shucked shellfish.

(b) "Shucker-packer" shall mean shippers shucking and packing shellfish. A shucker-packer may act as a shellstock dealer.

(3) "Export certificate" means a certificate issued by the department to a licensed shucker-packer or shellstock shipper for use in the foreign export of a lot or shipment of shellfish. The fee for each export certificate shall be \$10.

[Statutory Authority: RCW 43.20B.020 and 69.30.030. 96-16-073, § 246-282-990, filed 8/6/96, effective 10/1/96. Statutory Authority: RCW 43.70.040. 93-17-096 (Order 389), § 246-282-990, filed 8/17/93, effective 9/17/93; 91-02-049 (Order 121), recodified as § 246-282-990, filed 12/27/90, effective 1/31/91. Statutory Authority: RCW 43.20A.055. 85-12-029 (Order 2236), § 440-44-065, filed 5/31/85; 84-13-006 (Order 2109), § 440-44-065, filed 6/7/84; 83-15-021 (Order 1991), § 440-44-065, filed 7/14/83. Statutory Authority: 1982 c 201. 82-13-011 (Order 1825), § 440-44-065, filed 6/4/82.]

**Chapter 246-290 WAC  
PUBLIC WATER SUPPLIES**

**WAC**

**PART 1.  
GENERAL PROVISIONS**

- 246-290-001 Purpose and scope.
- 246-290-010 Definitions.
- 246-290-020 Applicability.
- 246-290-025 Adoption by reference.
- 246-290-030 General administration.
- 246-290-040 Engineering requirements.
- 246-290-050 Enforcement.
- 246-290-060 Variances, exemptions, and waivers.

**PART 2.  
PLANNING AND ENGINEERING DOCUMENTS**

- 246-290-100 Water system plan.
- 246-290-110 Project report.
- 246-290-115 Corrosion control recommendation report.
- 246-290-120 Construction documents.
- 246-290-130 Source approval.
- 246-290-135 Source protection.
- 246-290-140 Existing system approval.

**PART 3.  
DESIGN OF PUBLIC WATER SYSTEMS**

- 246-290-200 Design standards.
- 246-290-220 Lead in materials.
- 246-290-230 Distribution systems.
- 246-290-240 Disinfection of facilities.
- 246-290-250 Treatment design.

**PART 4.  
WATER QUALITY**

- 246-290-300 Monitoring requirements.
- 246-290-310 Maximum contaminant levels (MCLs).
- 246-290-320 Follow-up action.
- 246-290-330 Public notification.

**PART 5.  
WATER SYSTEM OPERATIONS**

- 246-290-410 Small water system management program.
- 246-290-420 Reliability.
- 246-290-430 Continuity of service.
- 246-290-440 Operations.
- 246-290-460 Fluoridation of drinking water.
- 246-290-470 Distribution reservoirs.
- 246-290-480 Recordkeeping and reporting.
- 246-290-490 Cross-connection control.
- 246-290-500 Severability.

**PART 6.  
SURFACE WATER TREATMENT**

**Subpart A—Introduction and General Requirements**

- 246-290-601 Purpose of surface water treatment.
- 246-290-610 Definitions relating to surface water treatment.
- 246-290-620 Applicability of surface water treatment requirements.
- 246-290-630 General requirements.
- 246-290-632 Treatment technique violations.
- 246-290-634 Follow-up to treatment technique violations.
- 246-290-636 Determination of disinfectant contact time (T).
- 246-290-638 Analytical requirements.
- 246-290-639 SWTR records.
- 246-290-640 Determination of GWI sources.

**Subpart B—Requirements for Filtered Systems**

- 246-290-650 Compliance requirements for filtered systems.
- 246-290-652 Filtration technology and design criteria for existing filtered systems.
- 246-290-654 Treatment criteria for filtered systems.
- 246-290-660 Filtration.
- 246-290-662 Disinfection for filtered systems.

- 246-290-664 Monitoring for filtered systems.  
 246-290-666 Reporting for filtered systems.  
 246-290-668 Watershed control.

Subpart C—Requirements for Systems Installing Filtration Facilities

- 246-290-670 Compliance requirements for existing unfiltered systems installing filtration.  
 246-290-672 Interim treatment requirements.  
 246-290-674 Interim monitoring and reporting.  
 246-290-676 Filtration technology and design criteria.  
 246-290-678 Reliability for filtered systems.  
 246-290-680 Operating criteria for new water treatment facilities.

Subpart D—Requirements for Other Unfiltered Systems

- 246-290-686 Compliance requirements for unfiltered systems.  
 246-290-690 Criteria to remain unfiltered.  
 246-290-692 Disinfection for unfiltered systems.  
 246-290-694 Monitoring for unfiltered systems.  
 246-290-696 Reporting for unfiltered systems.

FEES

- 246-290-990 Water system evaluation and project review and approval fees.

DISPOSITION OF SECTIONS FORMERLY  
 CODIFIED IN THIS CHAPTER

- 246-290-210 Source protection. [Statutory Authority: RCW 43.20.050. 91-02-051 (Order 124B), recodified as § 246-290-210, filed 12/27/90, effective 1/31/91. Statutory Authority: RCW 34.04.045. 88-05-057 (Order 307), § 248-54-125, filed 2/17/88. Statutory Authority: RCW 43.20.050. 83-19-002 (Order 266), § 248-54-125, filed 9/8/83.] Repealed by 93-08-011 (Order 352B), filed 3/25/93, effective 4/25/93. Statutory Authority: RCW 43.20.050.  
 246-290-400 Operator certification. [Statutory Authority: RCW 43.20.050. 91-02-051 (Order 124B), recodified as § 246-290-400, filed 12/27/90, effective 1/31/91. Statutory Authority: RCW 34.04.045. 88-05-057 (Order 307), § 248-54-194, filed 2/17/88.] Repealed by 93-08-011 (Order 352B), filed 3/25/93, effective 4/25/93. Statutory Authority: RCW 43.20.050.  
 246-290-450 Watershed control. [Statutory Authority: RCW 43.20.050. 91-02-051 (Order 124B), recodified as § 246-290-450, filed 12/27/90, effective 1/31/91. Statutory Authority: RCW 34.04.045. 88-05-057 (Order 307), § 248-54-225, filed 2/17/88. Statutory Authority: RCW 43.20.050. 83-19-002 (Order 266), § 248-54-225, filed 9/8/83.] Repealed by 93-08-011 (Order 352B), filed 3/25/93, effective 4/25/93. Statutory Authority: RCW 43.20.050.

PART 1.  
 GENERAL PROVISIONS

**WAC 246-290-001 Purpose and scope.** (1) The purpose of these rules is to define basic regulatory requirements and to protect the health of consumers using public drinking water supplies.

(2) The rules of this chapter are specifically designed to ensure:

(a) Adequate design, construction, sampling, management, maintenance, and operation practices; and

(b) Provision of high quality drinking water in a reliable manner and in a quantity suitable for intended use.

(3) Purveyors shall be responsible for complying with the regulatory requirements of this chapter.

(4) These rules are intended to conform with P.L. 93-523, the Federal Safe Drinking Water Act of 1974, and P.L. 99-339, the Safe Drinking Water Act Amendments of 1986.

(5) The rules set forth are adopted under chapter 43.20 RCW. Other statutes relating to this chapter are:

(a) RCW 43.20B.020, Fees for services—Department of health and department of social and health services;

(b) Chapter 43.70 RCW, Department of health;

(c) Chapter 70.05 RCW, Local health department, boards, officers—Regulations;

(d) Chapter 70.116 RCW, Public Water System Coordination Act of 1977;

(e) Chapter 70.119 RCW, Public water supply systems—Certification and regulation of operators;

(f) Chapter 70.119A RCW, Public water systems—Penalties and compliance; and

(g) Chapter 70.142 RCW, Chemical contaminants and water quality.

[Statutory Authority: RCW 43.20.050. 93-08-011 (Order 352B), § 246-290-001, filed 3/25/93, effective 4/25/93; 91-02-051 (Order 124B), recodified as § 246-290-001, filed 12/27/90, effective 1/31/91. Statutory Authority: P.L. 99-339. 89-21-020 (Order 336), § 248-54-005, filed 10/10/89, effective 11/10/89. Statutory Authority: RCW 34.04.045. 88-05-057 (Order 307), § 248-54-005, filed 2/17/88. Statutory Authority: RCW 43.20.050. 83-19-002 (Order 266), § 248-54-005, filed 9/8/83.]

**WAC 246-290-010 Definitions.** Abbreviations:

BAT - best available technology;

CFR - code of federal regulations;

CSE - comprehensive system evaluation;

GW - ground water under the direct influence of surface water;

HPC - heterotrophic plate count;

kPa - kilo pascal (SI units of pressure);

m - meter;

MCL - maximum contaminant level;

mg/L - milligrams per liter;

mL - milliliter;

mm - millimeter;

NTNC - nontransient **noncommunity**;

NTU - nephelometric turbidity unit;

pCi/L - picocuries per liter;

psi - pounds per square inch;

SAL - state advisory level;

SOC - synthetic organic chemical;

TTHM - total trihalomethane;

TNC - transient **noncommunity**;

TNTC - too numerous to count;

ug/L - micrograms per liter;

umhos/cm - micromhos per centimeter;

VOC - volatile organic chemical;

WFI - water facilities inventory and report form; and

WHPA - wellhead protection area.

"Acute" means posing an immediate risk to human health.

"Authorized agent" means any person who:

Makes decisions regarding the operation and management of a public water system whether or not he or she is engaged in the physical operation of the system;

Makes decisions whether to improve, expand, purchase, or sell the system; or

Has discretion over the finances of the system.

"Best available technology (BAT)" means the best technology, treatment techniques, or other means which EPA finds, after examination for efficacy under field conditions,

are available (taking cost into consideration). For the purposes of setting MCLs for synthetic organic chemicals, any BAT shall be at least as effective as granular activated carbon.

"Category red operating permit" means an operating permit identified as such pursuant to chapter 246-294 WAC. Placement in this category results in permit issuance with conditions and a determination that the system is inadequate.

"Coliform sample" means a sample of water collected from the distribution system at or after the first service and analyzed for coliform presence in compliance with this chapter.

"Composite sample" means a sample created in a certified laboratory by mixing equal parts of water from up to five different sources.

"Comprehensive monitoring plan" means a schedule which describes both the frequency and appropriate locations for sampling of drinking water contaminants as required by state and federal rules.

"Comprehensive system evaluation (CSE)" means a review, inspection, and assessment of a public water system, including but not limited to: Source; facilities; equipment; operation and administration; maintenance; records; planning documents and schedules; and monitoring, for the purpose of ensuring that safe and adequate drinking water is provided.

"Confirmation" means to demonstrate the results of a sample to be precise by analyzing a sample from the same location. Confirmation occurs when analysis results fall within plus or minus thirty percent of the original sample.

"Confluent growth" means a continuous bacterial growth covering a portion or the entire filtration area of a membrane filter in which bacterial colonies are not discrete.

"Contaminant" means a substance present in drinking water which may adversely affect the health of the consumer or the aesthetic qualities of the water.

"Contingency plan" means that portion of the wellhead protection program section of the water system plan or small water system management program which addresses the replacement of the major well(s) or wellfield in the event of loss due to ground water contamination.

"Cross-connection" means a physical arrangement connecting a public water system, directly or indirectly, with anything other than another potable water system, and capable of contaminating the public water system.

"Department" means the Washington state department of health or health officer as identified in a joint plan of operation in accordance with WAC 246-290-030(1).

"Disinfection" means the use of chlorine or other agent or process the department approves for killing or inactivating microbiological organisms, including pathogenic and indicator organisms.

"Distribution reservoir" means a water storage structure which is integrated with a water system's distribution network to provide for variable system demands including, but not limited to, daily equalizing storage, standby storage, or fire reserves, or to provide for disinfectant contact time.

"Distribution system" means that portion of a public water system which conveys water from the source and/or treatment facilities to consumers.

"Domestic or other nondistribution system plumbing problem," means contamination of a system having more than one service connection with the contamination limited

to the specific service connection from which the sample was taken.

"Duplicate (verification) sample" means a second sample collected at the same time and location as the first sample and used for verification.

"Expanding public water system" means a public water system installing additions, extensions, changes, or alterations to their existing source, transmission, storage, or distribution facilities which will enable the system increasing in size its existing service area and/or its number of approved service connections. Exceptions:

A system which connects new approved individual retail or direct service connections onto an existing distribution system within an existing service area; or

A distribution system extension in an existing service area identified in a current and approved water system plan or project report.

"Fire flow" means the rate of water flow needed to fight fires under WAC 246-293-640 or adopted city, town, or county standards.

"First customer" means the first service connection, i.e., the point where water is first withdrawn for human consumption, excluding connections where water is delivered to another water system covered by these regulations.

"Grab sample" means a water quality [quality] sample collected at a specific instant in time and analyzed as an individual sample.

"Ground water under the direct influence of surface water (GWI)" means any water beneath the surface of the ground, which the department determines has the following characteristics:

Significant occurrence of insects or other macroorganisms, algae, or large-diameter pathogens such as *Giardia lamblia*; or

Significant and relatively rapid shifts in water characteristics such as turbidity, temperature, conductivity, or pH closely correlating to climatological or surface water conditions.

"Guideline" means a department document assisting the purveyor in meeting a rule requirement.

"Health officer" means the health officer of the city, county, city-county health department or district, or an authorized representative.

"Hydraulic analysis" means the study of the water system network evaluating water flows within the distribution system under worst case conditions such as, peak hourly design flow plus fire flow, when required. Hydraulic analysis includes consideration of all factors affecting system energy losses.

"Initial inventory" means an inventory which consists, at a minimum, of all potential sources of ground water contamination located within the one-year time of travel area of a WHPA and all high risk potential sources of ground water contamination located within the ten-year ground water time of travel area.

"Maximum contaminant level (MCL)" means the maximum permissible level of a contaminant in water the purveyor delivers to any public water system user, measured at the locations identified under WAC 246-290-300, Table 4.

"Maximum contaminant level violation" means a confirmed measurement above the MCL and for a duration

of time, where applicable, as outlined under WAC 246-290-310.

"Monitoring waiver" means an action taken by the department pursuant to WAC 246-290-300 (3)(g) or (7)(f) to allow a water system to reduce specific monitoring requirements based on a determination of low source vulnerability to contamination. Guidance on applying for monitoring waivers is found in the department guideline titled, *Source Vulnerability and Monitoring Waivers* which is available from the department.

"Nonacute" means posing a possible or less than immediate risk to human health.

"Nonresident" means a person without a permanent home or without a home served by the system, such as travelers, transients, employees, students, etc.

"Peak hourly design flow" means the maximum rate of water use, excluding fire flow, which can be expected to ever occur within a defined service area over a sixty minute time period.

"Population served" means the number of persons, resident and nonresident, having immediate access to drinking water from a public water system, whether or not such persons have actually consumed water from that system. The number of nonresidents shall be the average number of persons having immediate access to drinking water on days access was provided during that month. In the absence of specific population data, the number of residents shall be computed by multiplying the number of active services by two and one-half.

"Potable" means water suitable for drinking by the public.

"Primary standards" means standards based on chronic, nonacute, or acute human health effects.

"Protected ground water source" means a ground water source the purveyor shows to the department's satisfaction as protected from potential sources of contamination on the basis of hydrogeologic data and/or satisfactory water quality history.

"Public water system" is defined and referenced under WAC 246-290-020.

"Purchased source" means water a purveyor purchases from a public water system not under the control of the purveyor for distribution to the purveyor's customers.

"Purveyor" means an agency, subdivision of the state, municipal corporation, firm, company, mutual or cooperative association, institution, partnership, or person or other entity owning or operating a public water system. Purveyor also means the authorized agents of such entities.

"Regularly" means four hours or more per day for four days or more per week.

"Repeat sample" means a sample collected to confirm the results of a previous analysis.

"Resident" means an individual living in a dwelling unit served by a public water system.

"Residual disinfectant concentration" means the concentration of disinfectant in mg/L in a representative sample of disinfected water.

"Same farm" means a parcel of land or series of parcels which are connected by covenants and devoted to the production of livestock or agricultural commodities for commercial purposes and does not qualify as a **Group A** public water system.

"Seasonal source" means a public water system source used on a regular basis, but not in use more than three consecutive months within a twelve-month period.

"Secondary standards" means standards based on factors other than health effects.

"Service" means a connection to a public water system designed to provide potable water to a single family residence, or other residential or nonresidential population. When the connection is to a system without clearly defined single family residences or with a nonresident population, the following formulas shall be used in determining equivalent number of services:

For group home or barracks-type accommodation, divide the average population served each day by two and one-half;

For NTNC systems, divide the average population served each day by two and one-half; and

For TNC systems, divide the average population served each day by twenty-five.

In no case shall the calculated number of services be less than one.

"Special purpose sample" means a sample collected for reasons other than the monitoring compliance specified in this chapter.

"Standard methods" means the 18th edition of the book, titled *Standard Methods for the Examination of Water and Waste Water*, jointly published by the American Public Health Association, American Water Works Association (AWWA), and Water Pollution Control Federation. This book is available through public libraries or may be ordered from AWWA, 6666 West Quincy Avenue, Denver, Colorado 80235.

"State advisory level (SAL)" means a department-established value for a contaminant without an existing state board of health MCL. The SAL represents a level which when exceeded, indicates the need for further assessment to determine if the chemical is an actual or potential threat to human health.

"State board of health" and "board" means the board created by RCW 43.20.030.

"Surface water" means a body of water open to the atmosphere and subject to surface runoff.

"Susceptibility assessment" means the Susceptibility Assessment Survey Form developed by the department to evaluate the hydrologic setting of the water source and assess its contribution to the sources' overall vulnerability to pollution from surface activities.

"Synthetic organic chemical (SOC)" means a manufactured carbon-based chemical.

"Time-of-travel" means the time required for ground water to move through the water bearing zone from a specific point to a well.

"Too numerous to count (TNTC)" means the total number of bacterial colonies exceeds 200 on a 47-mm diameter membrane filter used for coliform detection.

"Trihalomethane" means one of a family of organic compounds, named as derivatives of methane, where three of the four hydrogen atoms in methane are each substituted by a halogen atom in the molecular structure. Trihalomethanes may occur when chlorine, a halogen, is added to water containing organic material.

"Verification" means to demonstrate the results of a sample to be precise by analyzing a duplicate sample.

Verification occurs when analysis results fall within plus or minus thirty percent of the original sample.

"Volatile organic chemical (VOC)" means a manufactured carbon-based chemical that vaporizes quickly at standard pressure and temperature.

"Waterborne disease outbreak" means the significant occurrence of acute infectious illness, epidemiologically associated with drinking water from a public water system, as determined by the appropriate local health agency or the department.

"Water facilities inventory form (WFI)" means the department form summarizing each public water system's characteristics.

"Watershed" means the region or area which:

Ultimately drains into a surface water source diverted for drinking water supply; and

Affects the physical, chemical, microbiological, and radiological quality of the source.

"Well field" means a group of wells one purveyor owns or controls which:

Draw from the same aquifer or aquifers as determined by comparable inorganic chemical analysis; and

Discharge water through a common pipe and the common pipe shall allow for collection of a single sample before the first distribution system connection.

"Wellhead protection area (WHPA)" means the portion of a well's, wellfield's or spring's zone of contribution defined as such using WHPA criteria established by the department.

"Zone of contribution" means the area surrounding a pumping well or spring that encompasses all areas or features that supply ground water recharge to the well or spring.

[Statutory Authority: RCW 43.20.050. 94-14-001, § 246-290-010, filed 6/22/94, effective 7/23/94; 93-08-011 (Order 352B), § 246-290-010, filed 3/25/93, effective 4/25/93; 92-04-070 (Order 241B), § 246-290-010, filed 2/4/92, effective 3/6/92. Statutory Authority: Chapter 43.20 RCW. 91-07-031 (Order 150B), § 246-290-010, filed 3/15/91, effective 4/15/91. Statutory Authority: RCW 43.20.050. 91-02-051 (Order 124B), recodified as § 246-290-010, filed 12/27/90, effective 1/31/91. Statutory Authority: P.L. 99-339. 89-21-020 (Order 336), § 248-54-015, filed 10/10/89, effective 11/10/89. Statutory Authority: RCW 34.04.045. 88-05-057 (Order 307), § 248-54-015, filed 2/17/88. Statutory Authority: RCW 43.20.050. 83-19-002 (Order 266), § 248-54-015, filed 9/8/83.]

**WAC 246-290-020 Applicability.** (1) Public water system shall mean any system, excluding a system serving only one single-family residence and a system with four or fewer connections all of which serve residences on the same farm, providing piped water for human consumption, including any:

(a) Collection, treatment, storage, or distribution facilities under control of the purveyor and used primarily in connection with such system; and

(b) Collection or pretreatment storage facilities not under control of the purveyor primarily used in connection with such system.

(2) The rules of this chapter shall apply to all **Group A** public water systems except those systems meeting all of the following conditions:

(a) Consists only of distribution and/or storage facilities and does not have any source or treatment facilities;

(b) Obtains all water from, but is not owned by, a public water system where the rules of this chapter apply;

(c) Does not sell water directly to any person; and

(d) Is not a passenger-conveying carrier in interstate commerce.

(3) **Group A** public water systems meeting all of the provisions under subsection (2) of this section may be required by the department to comply with such provisions of this chapter as are necessary to resolve a public health concern if the department determines a public health threat exists or is suspected.

(4) A **Group A** system shall be defined as a public water system:

(a) With fifteen or more service connections, regardless of the number of people; or

(b) Serving an average of twenty-five or more people per day for sixty or more days within a calendar year, regardless of the number of service connections.

(5) **Group A** water systems are further defined as **community** and **noncommunity** water systems.

(a) **Community** water system means any **Group A** water system:

(i) With fifteen or more service connections used by residents for one hundred eighty or more days within a calendar year, regardless of the number of people; or

(ii) Regularly serving twenty-five or more residents for one hundred eighty or more days within the calendar year, regardless of the number of service connections.

Examples of a **community** water system might include a municipality, subdivision, mobile home park, apartment complex, college with dormitories, nursing home, or prison.

(b) **Noncommunity** water system means a **Group A** water system which is not a **community** water system. **Noncommunity** water systems are further defined as:

(i) **Nontransient (NTNC)** water system which regularly serves twenty-five or more of the same nonresidents for one hundred eighty or more days within a calendar year.

Examples of a **NTNC** water system might include a school, day care center, or a business, factory, motel, or restaurant with twenty-five or more employees on-site.

(ii) **Transient (TNC)** water system which:

(A) Has fifteen or more service connections used less than one hundred eighty days within a calendar year; or

(B) Serves twenty-five or more different nonresidents for sixty or more days within a calendar year; or

(C) Serves twenty-five or more of the same nonresidents for sixty or more days, but less than one hundred eighty days within a calendar year; or

(D) Serves twenty-five or more residents for sixty or more days, but less than one hundred eighty days within a calendar year.

Examples of a **TNC** water system might include a restaurant, tavern, motel, campground, state or county park, an RV park, vacation cottages, highway rest area, or church.

(c) A **Group B** water system is a public water system which does not meet the definition of a **Group A** water system. (See Table 1 and chapter 246-291 WAC for further explanation of a **Group B** water system.)

(6) A **Group A** system meeting more than one of the categories described in this section shall be classified by the department in the following order:

(a) **Community** water system;

- (b) NTNC water system; and
- (c) TNC water system.
- (7) The rules of this chapter to apply to the source or supply of water used by bottled water or ice plants to produce bottled water or ice are as follows:
  - (a) If the bottled water or ice plant is a **Group A** water system and the plant uses the system's source for the water that is bottled or made into ice, the source and supply used for the bottled water and ice shall meet the applicable **Group A** requirements;
  - (b) If the bottled water or ice plant uses its own source for the water that is bottled or made into ice, and the plant is not a **Group A** system, the owner or operator shall obtain source approval from the department, and the source water

- shall meet the ongoing source water quality monitoring requirements for a **Group A** community system;
- (c) If the bottled water or ice plant purchases the water for bottling or making ice from another source or supply, the water shall meet the minimum requirements for a **Group A** system, and the owner or operator of the plant shall ensure that the water meets such requirements;
- (d) The source or supply for the water that is bottled or made into ice shall be protected from contamination prior to the bottling or ice making process; and
- (e) In addition to the requirements imposed under this subsection, the processing of bottled water shall be subject to regulation by the state department of agriculture and the United States Food and Drug Administration.

Table 1

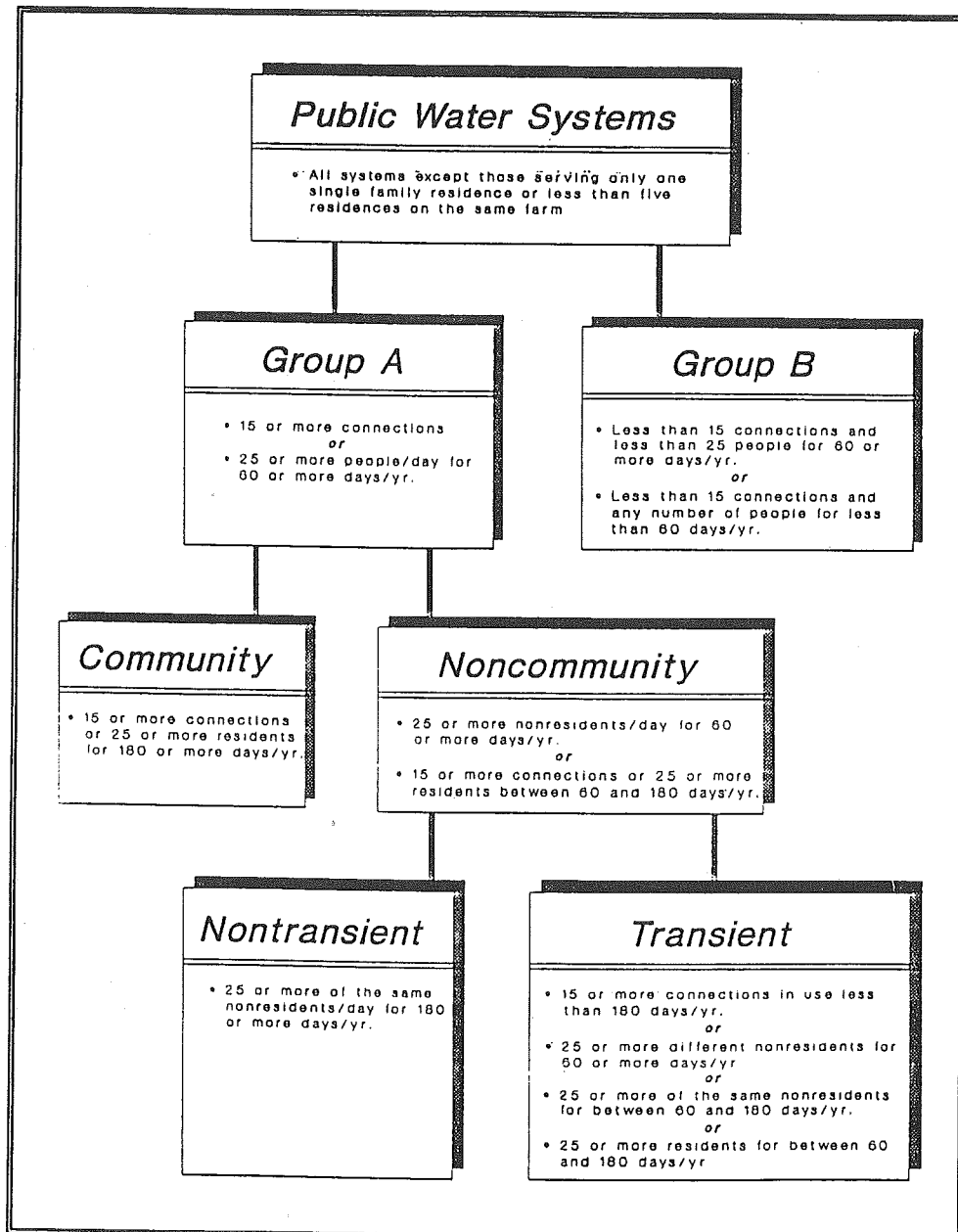



[Statutory Authority: RCW 43.20.050. 94-14-001, § 246-290-020, filed 6/22/94, effective 7/23/94; 93-08-011 (Order 352B), § 246-290-020, filed 3/25/93, effective 4/25/93; 91-02-051 (Order 124B), recodified as § 246-290-020, filed 12/27/90, effective 1/31/91. Statutory Authority: P.L. 99-339. 89-21-020 (Order 336), § 248-54-006, filed 10/10/89, effective 11/10/89.]

**WAC 246-290-025 Adoption by reference.** The following sections and subsections of Title 40 Code of Federal Regulations (CFR) Part 141 National Primary Drinking Water Regulations revised as of July 1, 1993, and including all amendments and modifications thereto effective as of the date of adoption of this chapter are adopted by reference:

141.2 Definitions. Only those definitions listed as follows:

Action level;  
Corrosion inhibitor;  
Effective corrosion inhibitor residual;  
First draw sample;  
Large water system;  
Lead service line;  
Medium-size water system;  
Optimal corrosion control treatment;  
Service line sample;  
Single family structure; and  
Small water system.

141.12 Maximum contaminant levels for organic chemicals.

141.23(a) - 141.23(j), Inorganic chemical sampling.

141.23(m) - 141.23(o)

141.24(a) - 141.24(d), Organic chemicals other than total trihalomethanes.

141.24 (f)(1) - 141.24 (f)(15),

141.24 (f)(18), 141.24 (f)(19),

141.24 (f)(21),

141.24 (g)(1) - 141.24 (g)(9),

141.24 (g)(12) - 141.24 (g)(14),

141.24 (h)(1) - 141.24 (h)(11),

141.24 (h)(14) - 141.24 (h)(17)

141.40(a) - 141.40(e), Special monitoring for inorganic and organic chemicals.

141.40(g), 141.40(i) - 141.40(n)

141.61 Maximum contaminant levels for organic contaminants.

141.62 Maximum contaminant levels for inorganic chemical and physical contaminants.

141.80 General requirements.

141.81 Applicability of corrosion control treatment steps to small, medium-size and large water systems.

141.82(a) - 141.82(h) Description of corrosion control treatment requirements.

141.83 Source water treatment requirements.

141.84 Lead service line replacement requirements.

141.85 Public education and supplemental monitoring requirements.

141.86 Monitoring requirements for lead and copper in tap water.

141.87 Monitoring requirements for water quality parameters.

141.88 Monitoring requirements for lead and copper in source water.

141.90 Reporting requirements.

141.91 Recordkeeping requirements.

Copies of the incorporated sections and subsections of Title 40 CFR are available from the Department of Health, Airdustrial Center Building 3, P.O. Box 47822, Olympia, Washington 98504-7822.

[Statutory Authority: RCW 43.20.050. 94-14-001, § 246-290-025, filed 6/22/94, effective 7/23/94.]

**WAC 246-290-030 General administration.** (1) The department and the health officer for each local health jurisdiction may develop a joint plan of operation. This plan shall:

(a) List the roles and responsibilities of each agency;  
(b) Specifically designate those **Group A** systems for which the department and local health officer have primary responsibility;

(c) Provide for a minimum level of water system supervision;

(d) Be signed by the department and the local health department or district; and

(e) Be reviewed at least once every five years and updated as needed.

Wherever in these rules the term "department" is used, the term "health officer" may be substituted based on the terms of this plan of operation.

(2) The department shall, upon request, review and report on the adequacy of water supply supervision to both the state and local boards of health.

(3) The local board of health may adopt rules governing **Group A** water systems within its jurisdiction for which the health officer has assumed primary responsibility. Adopted local board of health rules shall be:

(a) No less stringent than this chapter; and

(b) Revised, if necessary, within twelve months after the effective date of revised state board of health rules. During this time period, existing local rules shall remain in effect, except provisions of the revised state board of health rules which are more stringent than the local board of health rules shall apply.

(4) For those **Group A** water systems where the health officer has assumed primary responsibility, the health officer may approve project reports and construction documents in accordance with engineering criteria approved by the department and listed under WAC 246-290-200.

(5) An advisory committee shall be established to provide guidance to the department on drinking water issues. Members shall be appointed by the department and conform to department policies for advisory committees. The committee shall be composed of representatives of public water systems, public groups, agencies, and individuals having an interest in drinking water.

(6) The department may develop guidelines to clarify sections of the rules as needed and make these available for distribution.

(7) Fees may be charged by the department as authorized in chapter 43.20B RCW and by local health agencies as authorized in RCW 70.05.060 to recover all or a portion of the costs incurred in administering these rules.

(8) All state and local agencies involved in review, approval, surveillance, testing, and/or operation of public water systems, or issuance of permits for buildings or sewage systems shall be governed by these rules and any decisions of the department.

[Statutory Authority: RCW 43.20.050. 94-14-001, § 246-290-030, filed 6/22/94, effective 7/23/94; 93-08-011 (Order 352B), § 246-290-030, filed 3/25/93, effective 4/25/93; 91-02-051 (Order 124B), recodified as § 246-290-030, filed 12/27/90, effective 1/31/91. Statutory Authority: P.L. 99-339. 89-21-020 (Order 336), § 248-54-025, filed 10/10/89, effective 11/10/89. Statutory Authority: RCW 34.04.045. 88-05-057 (Order 307), § 248-54-025, filed 2/17/88. Statutory Authority: RCW 43.20.050. 83-19-002 (Order 266), § 248-54-025, filed 9/8/83.]

**WAC 246-290-040 Engineering requirements.** (1) Purveyors shall ensure that all water system plans, project reports, corrosion control recommendation reports, tracer studies, and construction documents are prepared under the direction, and bear the seal and signature of a professional engineer:

(a) Licensed in the state of Washington under chapter 18.43 RCW; and

(b) Having specific expertise regarding design, operation, and maintenance of public water systems.

Exceptions to this requirement are minor projects under WAC 246-290-120 (2)(a) through (d).

(2) Purveyors shall submit a *Construction Report For Public Water System Projects* to the department within sixty days of completion and before use of any project approved by the department. The form shall:

(a) Be signed by a professional engineer.

(b) State:

(i) The project is constructed and is substantially completed in accordance with approved construction documents; and

(ii) In the opinion of the engineer, based on information available, the installation, testing, and disinfection of the system was carried out per department guidelines.

(3) The purveyor shall ensure the requirements of this section are fulfilled before the use of any completed project. When required by the department, the purveyor shall submit an updated water facilities inventory form with the *Construction Report For Public Water System Projects* form.

[Statutory Authority: RCW 43.20.050. 94-14-001, § 246-290-040, filed 6/22/94, effective 7/23/94; 93-08-011 (Order 352B), § 246-290-040, filed 3/25/93, effective 4/25/93; 91-02-051 (Order 124B), recodified as § 246-290-040, filed 12/27/90, effective 1/31/91. Statutory Authority: P.L. 99-339. 89-21-020 (Order 336), § 248-54-035, filed 10/10/89, effective 11/10/89. Statutory Authority: RCW 34.04.045. 88-05-057 (Order 307), § 248-54-035, filed 2/17/88. Statutory Authority: RCW 43.20.050. 83-19-002 (Order 266), § 248-54-035, filed 9/8/83.]

**WAC 246-290-050 Enforcement.** When any purveyor is out of compliance with these rules, the department may initiate appropriate enforcement actions, regardless of any prior approvals issued by the department. These actions may include any one or combination of the following:

(1) Notice of violation instructing or requiring appropriate corrective measures;

(2) Compliance schedule for specific actions necessary to achieve compliance status;

(3) Departmental order requiring submission of project reports, construction documents, and construction report forms;

(4) Departmental order requiring specific actions or ceasing unacceptable activities within a designated time period;

(5) Departmental order to stop work and/or refrain from using any public water system or improvements thereto until all written approvals required by statute or rule are obtained;

(6) Imposition of civil penalties for failure to comply with departmental orders may be issued for up to 5,000 dollars per day per violation under authority of chapter 70.119A RCW; and

(7) Legal action may be taken by the attorney general or local prosecutor. The legal action may be criminal or civil.

[Statutory Authority: RCW 43.20.050. 93-08-011 (Order 352B), § 246-290-050, filed 3/25/93, effective 4/25/93; 91-02-051 (Order 124B), recodified as § 246-290-050, filed 12/27/90, effective 1/31/91. Statutory Authority: P.L. 99-339. 89-21-020 (Order 336), § 248-54-045, filed 10/10/89, effective 11/10/89. Statutory Authority: RCW 34.04.045. 88-05-057 (Order 307), § 248-54-045, filed 2/17/88. Statutory Authority: RCW 43.20.050. 83-19-002 (Order 266), § 248-54-045, filed 9/8/83.]

**WAC 246-290-060 Variances, exemptions, and waivers.** (1) General.

(a) The state board of health may grant variances, exemptions, and waivers of the requirements of this chapter according to the procedures outlined in subsection (5) of this section. See WAC 246-290-300 (3)(g) and (7)(f) for monitoring waivers.

(b) Consideration by the board of requests for variances, exemptions, and waivers shall not be considered adjudicative proceedings as that term is defined in chapter 34.05 RCW.

(c) Statements and written material regarding the request may be presented to the board at or before the public hearing wherein the application will be considered. Allowing cross-examination of witnesses shall be within the discretion of the board.

(d) The board may grant a variance, exemption, or waiver if it finds:

(i) Due to compelling factors, the public water system is unable to comply with the requirements; and

(ii) The granting of the variance, exemption, or waiver will not result in an unreasonable risk to the health of consumers.

(2) Variances.

(a) MCL.

(i) The board may grant a MCL variance to a public water system that cannot meet the MCL requirements because of characteristics of the source water that is reasonably available to the system.

(ii) A MCL variance may only be granted after the system has applied the best available technology (BAT), treatment techniques, or other means as identified by the environmental protection agency (EPA) and still cannot meet a MCL as specified in section 1415, P.L. 99-523 as amended by P.L. 99-339.

(iii) A variance shall not be granted from the MCL for presence of total coliform under WAC 246-290-310(3).

(b) Treatment techniques.

(i) The board may grant a treatment technique variance to a public water system if the system demonstrates that the treatment technique is not necessary to protect the health of consumers because of the nature of the system's source water.

(ii) A variance shall not be granted from any treatment technique requirement under Part 6 of chapter 246-290 WAC.

(c) The board shall condition the granting of a variance upon a compliance schedule as described in subsection (6) of this section.

(3) Exemptions.

(a) The board may grant a MCL or treatment technique exemption to a public water system that cannot meet an MCL or provide the required treatment in a timely manner, or both, as specified under section 1416, P.L. 93-523 as amended by P.L. 99-339.

(b) An exemption may be granted for up to one year if the system was:

(i) In operation on the effective date of the MCL or treatment technique requirement; or

(ii) Not in operation on the effective date, and no reasonable alternative source of drinking water is available.

(c) No exemption shall be granted from:

(i) The requirement to provide a residual disinfectant concentration in the water entering the distribution system under WAC 246-290-662 or 246-290-692; or

(ii) The MCL for presence of total coliform under WAC 246-290-310(2).

(d) The board shall condition the granting of an exemption upon a compliance schedule as described in subsection (6) of this section.

(4) Waivers. The board may grant a waiver to a public water system if the system cannot meet the requirements of these regulations pertaining to any subject not covered by EPA regulations.

(5) Procedures.

(a) For variances and exemptions. The board shall consider granting a variance or exemption to a public water system upon completion of the following actions:

(i) The purveyor applies in writing to the department. The application, which may be in the form of a letter shall clearly state the reason for the request and what actions the purveyor has taken to meet the requirement;

(ii) The purveyor provides notice of the purveyor's application to customers and provides proof of such notice to the department;

(iii) The department prepares recommendations, including a compliance schedule for the board's consideration;

(iv) The board provides notice for and conducts a public hearing on the purveyor's request.

(v) EPA reviews any variance or exemption granted by the board for concurrence, revocation, or revision as provided under sections 1415 and 1416 of P.L. 93-523.

(b) For waivers. The board shall consider granting a waiver upon completion of the following actions:

(i) The purveyor applies to the department in writing. The application, which may be in the form of a letter, shall clearly state the reason for the request;

(ii) The purveyor provides notice of the purveyor's application to customers and provides proof of such notice to the department;

(iii) The department prepares a recommendation to the board; and

(iv) The board provides notice for and conducts a public hearing on the purveyor's request.

(6) Compliance schedule.

(a) The board shall condition the granting of a variance or exemption based on a compliance schedule. The compliance schedule shall include:

(i) Actions the purveyor must undertake to comply with a MCL or treatment technique requirement within a specified time period; and

(ii) A description and time-table for implementation of interim control measures the department may require while the purveyor completes the actions required in (a)(i) of this subsection.

(b) The purveyor shall complete the required actions in the compliance schedule within the stated time frame.

(7) Extensions to exemptions.

(a) The board may extend the final date of compliance prescribed in the compliance schedule for a period of up to three years after the date the exemption was granted upon a finding that the water system:

(i) Cannot meet the MCL or treatment technique requirements without capital improvements which cannot be completed within the original exemption period; or

(ii) Has entered into an agreement to obtain needed financial assistance for necessary improvements; or

(iii) Has entered into an enforceable agreement to become part of a regional public water system and the system is taking all practicable steps to meet the MCL.

(b) The board may extend the final date of compliance prescribed in the compliance schedule of an exemption for one or more additional two-year periods if the purveyor:

(i) Is a community water system providing water to less than five hundred service connections; and

(ii) Needs financial assistance for the necessary improvements; and

(iii) Is taking all practicable steps to meet the compliance schedule.

(c) Procedures listed in subsection (5) of this section shall be followed in the granting of extensions to exemptions.

[Statutory Authority: RCW 43.20.050. 94-14-001, § 246-290-060, filed 6/22/94, effective 7/23/94; 93-08-011 (Order 352B), § 246-290-060, filed 3/25/93, effective 4/25/93; 91-02-051 (Order 124B), recodified as § 246-290-060, filed 12/27/90, effective 1/31/91. Statutory Authority: P.L. 99-339. 89-21-020 (Order 336), § 248-54-055, filed 10/10/89, effective 11/10/89. Statutory Authority: RCW 34.04.045. 88-05-057 (Order 307), § 248-54-055, filed 2/17/88. Statutory Authority: RCW 43.20.050. 83-19-002 (Order 266), § 248-54-055, filed 9/8/83.]

## PART 2.

### PLANNING AND ENGINEERING DOCUMENTS

**WAC 246-290-100 Water system plan.** (1) The purpose of this section is to establish a uniform process for purveyors to:

(a) Identify present and future needs;

(b) Set forth means for addressing those needs; and

(c) Do so in a manner consistent with other relevant plans and local, state, and federal laws.

(2) Purveyors of the following categories of public water systems shall ensure the development and submittal of a water system plan for review and approval by the department:

- (a) All systems having one thousand or more services;
- (b) Systems located in areas utilizing the Public Water System Coordination Act of 1977, chapter 70.116 RCW and chapter 248-56 WAC as required in WAC 246-293-230;
- (c) Any system experiencing problems related to planning, operation, and/or management as determined by the department;
- (d) Any expanding system;
- (e) Any system for which a change of ownership is proposed; and
- (f) All new systems.

(3) The department shall work with the purveyor and other parties to establish the level of detail for a water system plan. In general, the scope and detail of the plan will be related to size and complexity of the water system. Project reports may be combined with a water system plan.

(4) The water system plan shall address the following elements as a minimum for a period of at least twenty years into the future. A department guideline titled *Planning Handbook* is available to assist the utility in adequately addressing these elements:

- (a) Basic water system planning data;
- (b) Existing system analysis;
- (c) Planned improvements;
- (d) Conservation;
- (e) Source of supply analysis when additional water rights are being pursued;
- (f) Financial viability;
- (g) Consistency with adjacent water system plans;
- (h) Consistency with applicable land use plans;
- (i) Supporting maps;
- (j) Operations program;
- (k) Ownership and management;
- (l) State Environmental Policy Act; and
- (m) Source protection, including a watershed control program or wellhead protection program when applicable under WAC 246-290-135.

(5) The department, at its discretion, may require reports from purveyors identifying the progress in developing their water system plans.

(6) Purveyors shall transmit water system plans to adjacent utilities and local governments having jurisdiction, to assess consistency with ongoing and adopted planning efforts.

(7) Department approval of a water system plan shall be in effect for six years from the date of written approval unless:

- (a) Major system improvements are contemplated which are not addressed in the plan;
- (b) Changes occur in the basic planning data affecting improvements identified; or
- (c) The department requests an updated plan.

(8) The purveyor shall update the plan and submit it for approval every six years. However, if only minor alterations to an existing plan are considered necessary, the purveyor may submit an amendment to the plan for department approval.

(9) Project reports and construction documents submitted for approval per WAC 246-290-110 and 246-290-120 by purveyors required to have a water system plan, will not be considered for approval unless there is a current approved water system plan and the plan adequately addresses the project.

[Statutory Authority: RCW 43.20.050. 94-14-001, § 246-290-100, filed 6/22/94, effective 7/23/94; 93-08-011 (Order 352B), § 246-290-100, filed 3/25/93, effective 4/25/93; 91-02-051 (Order 124B), recodified as § 246-290-100, filed 12/27/90, effective 1/31/91. Statutory Authority: RCW 34.04.045. 88-05-057 (Order 307), § 248-54-065, filed 2/17/88. Statutory Authority: RCW 43.20.050. 83-19-002 (Order 266), § 248-54-065, filed 9/8/83.]

**WAC 246-290-110 Project report.** (1) The purpose of this section is to assure the following factors are taken into account for specific projects prior to construction:

- (a) Engineering concepts;
- (b) Design criteria;
- (c) Planning;
- (d) Source protection, including a watershed control program or wellhead protection program when applicable under WAC 246-290-135;
- (e) Water quality and quantity;
- (f) Results of the filtration facility pilot study;
- (g) Local requirements such as fire flow;
- (h) Facility operation;
- (i) Short-term and long-term financing; and
- (j) Other necessary department-determined considerations.

The project report shall document the reasons for carrying out the project and construction documents shall identify how the project will be constructed.

(2) The purveyor shall submit project reports to the department for written approval prior to installation of any new water system, water system extension, or improvement with the following exceptions:

- (a) Installation of valves, fittings, and meters;
- (b) Installation of hydrants under WAC 246-290-230;
- (c) Repair of a system component or replacement with a similar component;
- (d) Maintenance or painting of surfaces not contacting potable water; and
- (e) Distribution mains if:
  - (i) Approved standard construction specifications are documented in the water system plan approved by the department; and
  - (ii) The purveyor provides documentation to the department that a professional engineer registered in Washington, certified the construction and that said construction complied with the standard specifications found in the current department-approved water system plan; and
  - (iii) The purveyor provides documentation to the department of the pressure test results, disinfection procedures used and tests performed, and water quality sample results obtained prior to placing the distribution pipe into service.

(3) Project reports shall be consistent with the standards identified under WAC 246-290-200 and shall include, at a minimum, the following elements (information contained in a current approved water system plan or current project report need not be duplicated in the new project report. Any

planning information in a project report shall be project specific.):

(a) Project description. Identify what the project is intended to achieve, design considerations, approach, etc.;

(b) Planning. If the system has an approved water system plan, show the project's relationship to the plan. If a water system plan is not required, include:

(i) General project background with population and water demand forecasts;

(ii) Relationship between the project and other system components;

(iii) Project schedule;

(iv) Management program; and

(v) How the project will impact neighboring water systems.

(c) Alternatives. Describe options, their impacts, and justify the selected alternative;

(d) Legal considerations. Identify legal aspects such as ownership, right-of-way, sanitary control area, and restrictive covenants. Include discussion of the project's relationship with the boundary review board and the utility and transportation commission;

(e) Engineering calculations. Describe how the project complies with the design considerations. Include the hydraulic analysis, sizing justification, and other relevant technical considerations necessary to support the project;

(f) Management. If the system has an approved management program, refer to that document. If not, describe:

(i) System ownership and management responsibilities;

(ii) Long-term management considerations;

(iii) How the project will be operated; and

(iv) How the project will be maintained over time.

(g) Implementation. Identify the schedule for completion of the project and implementation strategies, if any. Project phasing should also be discussed;

(h) State Environmental Policy Act (SEPA). Include an environmental impact statement, determination of nonsignificance, or justify why SEPA does not apply to the project. Refer to chapter 246-03 WAC and the *DOH Drinking Water SEPA Guide*;

(i) Source development information. If the project involves source development, address requirements under WAC 246-290-130; and

(j) Type of treatment. If the project involves treatment, refer to WAC 246-290-250.

(4) Approval of project documents shall be in effect for two years unless the department determines a need to withdraw the approval. An extension of the approval may be obtained by submitting a status report and a written schedule for completion. Extensions may be subject to additional terms and conditions imposed by the department.

[Statutory Authority: RCW 43.20.050. 94-14-001, § 246-290-110, filed 6/22/94, effective 7/23/94; 93-08-011 (Order 352B), § 246-290-110, filed 3/25/93, effective 4/25/93; 91-02-051 (Order 124B), recodified as § 246-290-110, filed 12/27/90, effective 1/31/91. Statutory Authority: P.L. 99-339. 89-21-020 (Order 336), § 248-54-086, filed 10/10/89, effective 11/10/89. Statutory Authority: RCW 34.04.045. 88-05-057 (Order 307), § 248-54-086, filed 2/17/88.]

**WAC 246-290-115 Corrosion control recommendation report.** (1) Purveyors required to prepare a recommen-

dation regarding optimal corrosion control pursuant to 40 CFR 141.81, shall prepare a report in accordance with WAC 246-290-040(1) for review by the department. The report shall, at a minimum, consist of:

(a) A narrative which includes the following information:

(i) Public water system name and public water system identification number;

(ii) Identification of the individual responsible for preparing the recommendation with name, address, phone number, and relation to the system;

(iii) Summary, by source, of all existing treatment processes and objectives (to include treatments only used on a periodic basis);

(iv) Description of existing corrosion control treatment processes and the operation of those processes;

(v) Summary of historical information regarding water quality, to include:

(A) Customer and user complaints;

(B) Prior corrosion control studies and recommendations of those studies; and

(C) Summary of any known water quality problems.

(vi) Description of future plans or designs which may influence system operation or water quality; and

(vii) Location of lead service lines present within the distribution system.

(b) A summary of sample analysis results which includes:

(i) Lead and copper tap sample results for each monitoring period in which samples were collected in accordance with 40 CFR 141.86 shall be summarized by:

(A) Maximum value;

(B) Minimum value;

(C) 90th percentile value; and

(D) The percent of samples exceeding the action level.

(ii) Initial water quality shall be summarized by:

(A) Determinations of source water lead and copper levels in accordance with 40 CFR 141.88(a) and 141.88(b); and

(B) Determinations of initial water quality parameters in accordance with 141.87(b);

(iii) A comparison of water quality parameters, prior to and after treatment for sources utilizing a treatment process. This comparison shall use, at a minimum, the water quality parameters listed in 40 CFR 141.82 (c)(3).

(c) A description and evaluation of those treatment technologies listed in 40 CFR 141.82 (c)(3) which are determined feasible with respect to:

(i) Water quality constraints;

(ii) Treatment processes; and

(iii) Operational considerations.

(d) Background information supporting the corrosion control treatment proposal shall include:

(i) Documentation of the methods utilized in the recommendation;

(ii) Information supporting the proposed treatment process or the proposed corrosion control demonstration study;

(iii) Description of treatment processes in similar systems with successful outcomes; and

(iv) Other information used by the system in making this recommendation.

(e) The treatment proposal which addresses the following:

(i) Source water treatment recommendations for lead and copper removal in accordance with 40 CFR 141.83. The recommendation shall include:

(A) Method of treatment; and

(B) Operating parameters necessary to ensure adequate treatment.

(ii) Corrosion control treatment including:

(A) Method of treatment; and

(B) Operating parameters necessary to ensure adequate treatment.

(iii) Performance of a demonstration corrosion control study including:

(A) Method of demonstration as listed in 40 CFR 141.82(c)(2);

(B) Treatment processes to be evaluated; and

(C) An evaluation of the similarity of systems when the demonstration corrosion control study is performed by another system.

(2) A guideline titled *Lead and Copper Rule Guidance Manual Volume II: Corrosion Control Treatment* is available to assist the purveyor in preparing this recommendation.

(3) The department may require the purveyor of a system to:

(a) Provide additional information; and/or

(b) Perform a corrosion control study in accordance with 141.82(c).

[Statutory Authority: RCW 43.20.050. 94-14-001, § 246-290-115, filed 6/22/94, effective 7/23/94.]

#### **WAC 246-290-120 Construction documents.** (1)

The purpose of this section is to assure detailed plans, specifications, drawings, and other documents are adequately prepared for specific projects. Construction documents shall identify how specific projects will be constructed while the project report documents the reasons for carrying out the project.

(2) Purveyors shall submit construction documents to the department for written approval prior to installation of any new water system, or water system extension or improvement with the following exceptions:

(a) Installation of valves, fittings, and meters;

(b) Installation of hydrants per WAC 246-290-230(3);

(c) Repair of a system component or replacement with a similar component;

(d) Maintenance or painting of surfaces not contacting potable water; or

(e) Distribution mains if:

(i) Approved water system plan documents standard construction specifications approved by the department; and

(ii) The purveyor provides documentation to the department that a professional engineer registered in Washington, certified the construction and that said construction complied with the standard specifications found in the current department-approved water system plan; and

(iii) The purveyor provides documentation to the department of the pressure test results, disinfection procedures used and tests performed, and water quality sample results obtained prior to placing the distribution pipe into service.

(3) Construction documents shall be consistent with the standards identified in WAC 246-290-200 and shall include, at a minimum, the following:

(a) Drawings. Include detailed drawings of each project component;

(b) Material specifications. List detailed material specifications for each project component;

(c) Construction specifications. List detailed construction specifications and assembly techniques for carrying out the project;

(d) Testing. Identify testing criteria and procedures for each applicable portion of the project;

(e) Disinfection. Identify specific disinfection procedures which must conform with American water works association standards or other standards acceptable by the department;

(f) Inspection. Identify provisions for inspection of the installation of each project component. See WAC 246-290-040 for construction reporting requirements; and

(g) Change orders. All changes except for minor field revisions must be submitted to and approved by the department in writing. Identify who will be responsible for obtaining departmental approval and how change orders will be reported to the department.

(4) Approval of construction documents shall be in effect for two years unless the department determines a need to withdraw the approval. An extension of the approval may be obtained by submitting a status report and a written schedule for completion. Extensions may be subject to additional terms and conditions imposed by the department.

(5) A department guideline titled *Planning Handbook* is available to assist the utility in meeting the planning-related requirements of this section.

[Statutory Authority: RCW 43.20.050. 93-08-011 (Order 352B), § 246-290-120, filed 3/25/93, effective 4/25/93; 91-02-051 (Order 124B), recodified as § 246-290-120, filed 12/27/90, effective 1/31/91. Statutory Authority: RCW 34.04.045. 88-05-057 (Order 307), § 248-54-096, filed 2/17/88.]

**WAC 246-290-130 Source approval.** (1) No new source, previously unapproved source, or modification of an existing source shall be used as a public water supply without department approval.

(2) A party seeking approval shall provide the department:

(a) A copy of the water right permit, if required, obtained from the department of ecology for the source, quantity, type, and place of use;

(b) A hydrogeologic assessment of the proposed source along with a general description of the watershed, spring, and/or aquifer recharge area affecting the quantity or quality of flow. Seasonal variation shall also be included;

(c) Any information, in addition to (b) of this subsection, as requested by the department to determine whether a source is a GWI;

(d) For surface water and GWI sources, the watershed control program identified under WAC 246-290-135 and Part 6 of chapter 246-290 WAC;

(e) For wells and springs:

(i) A susceptibility assessment;

(ii) A preliminary WHPA designation using the calculated fixed radius method, with six month, one, five, and ten year time of travel criteria; and

(iii) An initial inventory of potential sources of ground water contamination located within the WHPA.

(f) Upstream water uses affecting either water quality or quantity;

(g) A map showing the project location and vicinity;

(h) A map depicting topography, distances to the surface water intake, well or spring from existing property lines, buildings, potential sources of contamination, ditches, drainage patterns, and any other natural or man-made features affecting the quality or quantity of water;

(i) The dimensions and location of the sanitary control area under WAC 246-290-135;

(j) Copies of the recorded legal documents for the sanitary control area under WAC 246-290-135;

(k) A copy of the on-site inspection approval made by the department or local health department representative;

(l) A copy of the water well report including the Washington well identification number, depth to open interval or top of screened interval, overall depth of well, and location (both plat location and latitude/longitude);

(m) Required construction documents in accordance with WAC 246-290-120;

(n) Documentation of source meter installation;

(o) Well source development data establishing the capacity of the source. Data shall include:

(i) Static water level;

(ii) Wellhead elevation;

(iii) Yield;

(iv) The amount of drawdown;

(v) Recovery rate;

(vi) Duration of pumping; and

(vii) Interference between existing sources and the source being tested.

The source shall be pump tested at no less than the maximum design rate to determine whether the well and aquifer are capable of supplying water at the rate desired and to provide information necessary to determine the proper pump settings in the well. A department guideline on pump testing is available to assist purveyors;

(p) An initial analysis result of source water quality, including as a minimum the following:

(i) Bacteriological;

(ii) Complete inorganic chemical and physical;

(iii) VOC;

(iv) Radionuclide (if source being approved is for a community system); and

(v) Any other information required by the department.

When source water quality is subject to variation, the department may require additional analyses to define the range of variation;

(q) If treatment is planned, refer to WAC 246-290-250(2) and Part 6 of chapter 246-290 WAC, if applicable; and

(r) Other department-required information. Before initiating source development or modification, the purveyor shall contact the department to identify any such additional information.

(3) The department shall issue a written source approval when:

(a) The purveyor submits the necessary information to the satisfaction of the department; and

(b) The developed source provides water complying with this chapter.

(4) No new surface water or GWI sources with less than one hundred service connections shall be approved unless the system is owned and operated by an approved satellite management agency.

[Statutory Authority: RCW 43.20.050. 94-14-001, § 246-290-130, filed 6/22/94, effective 7/23/94; 93-08-011 (Order 352B), § 246-290-130, filed 3/25/93, effective 4/25/93. Statutory Authority: Chapter 43.20 RCW. 91-07-031 (Order 150B), § 246-290-130, filed 3/15/91, effective 4/15/91. Statutory Authority: RCW 43.20.050. 91-02-051 (Order 124B), recodified as § 246-290-130, filed 12/27/90, effective 1/31/91. Statutory Authority: P.L. 99-339. 89-21-020 (Order 336), § 248-54-097, filed 10/10/89, effective 11/10/89. Statutory Authority: RCW 34.04.045. 88-05-057 (Order 307), § 248-54-097, filed 2/17/88.]

**WAC 246-290-135 Source protection.** (1) The purveyor shall obtain drinking water from the highest quality source feasible. Existing and proposed sources of supply shall conform to the water quality standards established in WAC 246-290-310.

(2) The department may require monitoring and controls in addition to those specified in this section if, in the opinion of the department, a potential risk exists to the water quality of a source.

(3) Sanitary control area.

(a) The purveyor shall maintain a sanitary control area around all sources for the purpose of protecting them from existing and potential sources of contamination.

(b) For wells and springs, the minimum sanitary control area shall have a radius of one hundred feet (thirty meters) and two hundred feet (sixty meters) respectively, unless engineering justification supports a smaller area. The justification must address geological and hydrological data, well construction details and other relevant factors necessary to assure adequate sanitary control.

(c) The department may require a larger sanitary control area than specified in (b) of this subsection if geological and hydrological data support such a decision. It shall be the purveyor's responsibility to obtain the protection needed.

(d) No source of contamination may be constructed, stored, disposed of, or applied within the sanitary control area without the permission of the department and the purveyor.

(e) The sanitary control area shall be owned by the purveyor in fee simple, or the purveyor shall have the right to exercise complete sanitary control of the land through other legal provisions.

(f) A purveyor, owning all or part of the sanitary control area in fee simple or having possession and control, shall send to the department copies of legal documentation, such as a duly recorded declaration of covenant, restricting the use of the land. This legal documentation shall state:

(i) No source of contamination may be constructed, stored, disposed of, or applied without the permission of the department and the purveyor; and

(ii) If any change in ownership of the system or sanitary control area is considered, all affected parties shall be informed of these requirements.

(g) Where portions of the control area are in the possession and control of another, the purveyor shall obtain a duly



recorded restrictive covenant which shall run with the land, restricting the use of said land in accordance with these rules and provide the department with copies of the appropriate documentation.

(4) Wellhead protection.

(a) Purveyors of water systems using ground water or spring sources shall develop and implement a wellhead protection program.

(b) The wellhead protection program shall be part of the water system plan required under WAC 246-290-100 or the small water system management program required under WAC 246-290-410.

(c) The purveyor's wellhead protection program shall contain, at a minimum, the following elements:

(i) A susceptibility assessment;

(ii) WHPA delineation for each well, wellfield, or spring with the one, five and ten year time of travel boundaries marked, or boundaries established using alternate criteria approved by the department in those settings where ground water time of travel is not a reasonable delineation criteria. WHPA delineations shall be done in accordance with recognized methods such as those described in the following sources:

(A) *Washington State Wellhead Protection Program*; or

(B) EPA Guidelines for Delineation of Wellhead Protection Areas, EPA 440/6-87-010;

(iii) A list of all actual and potential ground water contaminant sources located within the defined WHPA(s). This list shall be updated every two years;

(iv) Documentation of purveyor's notification to all owners/ operators of actual and potential sources of ground water contamination within the WHPA boundaries;

(v) Documentation of purveyor's notification to regulatory agencies and local governments of the boundaries of the WHPA(s) and the finding of the WHPA inventory;

(vi) A contingency plan to ensure consumers have an adequate supply of potable water in the event that contamination results in the temporary or permanent loss of the principal source of supply (major well(s) or wellfield); and

(vii) Documentation of coordination with local emergency spill responders (including police, fire and health departments), including notification of WHPA boundaries, results of susceptibility assessment, inventory findings, and contingency plan.

Sections in the department guidelines titled *Planning Handbook*, *Washington State Wellhead Protection Program*, and *Inventory of Potential Sources of Ground Water Contamination in Washington's Wellhead Protection Areas* address wellhead protection in more detail, and are available to purveyors establishing local wellhead protection programs.

(5) Watershed control program.

(a) Purveyors of water systems using surface water or GWI sources shall develop and implement a watershed control program in accordance with Part 6 of chapter 246-290 WAC as applicable.

(b) The watershed control program shall be part of the water system plan required in WAC 246-290-100 or the small water system management program required in WAC 246-290-410.

(c) The purveyor's watershed control program shall contain, at a minimum, the following elements:

(i) Watershed description and inventory, including location, hydrology, land ownership and activities which may adversely affect source water quality;

(ii) Watershed control measures, including documentation of ownership and relevant written agreements, and monitoring of activities and water quality;

(iii) System operation, including emergency provisions; and

(iv) Documentation of water quality trends.

Sections in the department guideline titled *Planning Handbook* and in the *DOH SWTR Guidance Manual* address watershed control and are available to purveyors establishing watershed control programs.

(d) The purveyor shall submit the watershed control program to the department for approval. Following departmental approval, the purveyor shall implement the watershed control program as approved.

(e) Purveyors of systems using unfiltered surface or GWI sources and meeting the criteria to remain unfiltered as specified in WAC 246-290-690 shall submit an annual report to the department which summarizes the effectiveness of the watershed control program. Refer to WAC 246-290-690 for further information about this report.

(f) The purveyor shall update the watershed control program at least every six years, or more frequently if required by the department.

[Statutory Authority: RCW 43.20.050. 94-14-001, § 246-290-135, filed 6/22/94, effective 7/23/94; 93-08-011 (Order 352B), § 246-290-135, filed 3/25/93, effective 4/25/93.]

**WAC 246-290-140 Existing system approval.** (1)

When applying for approval, purveyors of existing public water systems without approved construction documents shall provide department-determined information.

(2) Information provided shall be consistent with chapter 248-54 WAC.

(3) Purveyors shall contact the department to obtain a list of specific requirements including, for wells and springs:

(a) A susceptibility assessment;

(b) A preliminary WHPA designation using the calculated fixed radius method, with six month, one, five, and ten year time of travel criteria; and

(c) An initial inventory of potential sources of ground water contamination located within the WHPA.

(4) After receipt of the required data, the department shall review the information and either:

(a) Approve the as-built construction documents; or

(b) Indicate what additional actions the purveyor needs to complete before approval is granted.

[Statutory Authority: RCW 43.20.050. 94-14-001, § 246-290-140, filed 6/22/94, effective 7/23/94; 91-02-051 (Order 124B), recodified as § 246-290-140, filed 12/27/90, effective 1/31/91. Statutory Authority: P.L. 99-339. 89-21-020 (Order 336), § 248-54-098, filed 10/10/89, effective 11/10/89.]

**PART 3.**

**DESIGN OF PUBLIC WATER SYSTEMS**

**WAC 246-290-200 Design standards.** (1) Purveyors shall ensure that good engineering practices are used in the design of all public water systems, such as those set out in:

(a) The most recently published edition of *Recommended Standards for Water Works, A Committee Report of the Great Lakes - Upper Mississippi River Board of State Public Health and Environmental Managers*;

(b) Department guideline titled *Sizing Guidelines for Public Water Supplies*;

(c) Standard specifications of the American Public Works Association;

(d) Standard specifications of the American Water Works Association;

(e) Design criteria, such as contained in current college texts and professional journal articles, acceptable to the department;

(f) Chapter 173-160 WAC *Minimum Standards for Construction and Maintenance of Water Wells*;

(g) Visscher, J.T., et. al., *Slow Sand Filtration for Community Water Supply, Planning, Design, Construction, Operation, and Maintenance. 1987.* Technical paper no. 24, The Hague, Netherlands: International Reference Center for Community Water Supply and Sanitation;

(h) Huisman, L. and W.E. Wood. 1974. *Slow Sand Filtration.* Geneva. World Health Organization;

(i) *Manual of Design for Slow Sand Filtration. 1991.* AWWA Research Foundation; and

(j) *Slow Sand Filtration. 1991.* American Society of Civil Engineers.

(2) In addition, purveyors of new or expanding public water systems shall use the following design factors:

(a) Historical water use;

(b) Community versus recreational uses of water;

(c) Local conditions and/or regulations;

(d) Community expectations;

(e) Public Water System Coordination Act considerations where appropriate;

(f) Risks from potential disasters; and

(g) Other requirements as determined by the department.

[Statutory Authority: RCW 43.20.050. 93-08-011 (Order 352B), § 246-290-200, filed 3/25/93, effective 4/25/93; 91-02-051 (Order 124B), recodified as § 246-290-200, filed 12/27/90, effective 1/31/91. Statutory Authority: RCW 34.04.045. 88-05-057 (Order 307), § 248-54-105, filed 2/17/88. Statutory Authority: RCW 43.20.050. 83-19-002 (Order 266), § 248-54-105, filed 9/8/83.]

**WAC 246-290-220 Lead in materials.** (1) Any pipe, pipe fittings, solder, or flux used in the installation or repair of a public water system shall be lead-free. This prohibition shall not apply to leaded joints necessary for the repair of cast iron pipes.

(2) Within the context of this section, lead-free shall mean:

(a) No more than eight percent lead in pipes and pipe fittings, and

(b) No more than two-tenths of one percent lead in solder and flux.

[Statutory Authority: RCW 43.20.050. 91-02-051 (Order 124B), recodified as § 246-290-220, filed 12/27/90, effective 1/31/91. Statutory Authority: RCW 34.04.045. 88-05-057 (Order 307), § 248-54-131, filed 2/17/88.]

**WAC 246-290-230 Distribution systems.** (1) Distribution reservoirs completed after June 1, 1975, shall have suitable watertight roofs or covers preventing entry by birds, animals, insects, and dust and shall include appropriate

provisions to safeguard against trespass, vandalism, and sabotage. Purveyors with uncovered distribution reservoirs in use before June 2, 1975, shall comply with the provisions of WAC 246-290-470 until suitable watertight roofs or covers are installed. Purveyors with uncovered distribution reservoirs shall submit a plan and schedule to cover all reservoirs to the department for approval before January 1, 1996.

(2) The purveyor shall size and evaluate the distribution system using a hydraulic analysis acceptable to the department.

(3) The minimum diameter of all distribution mains shall be six inches (150 mm) unless justified by hydraulic analysis. Systems designed to provide fire flows shall have a minimum distribution main size of six inches (150 mm). Installation of standard fire hydrants shall not be allowed on mains less than six inches (150 mm) in diameter.

(4) New public water systems or additions to existing systems shall provide a design quantity of water at a positive pressure of at least 30 psi (200 kPa) under peak hourly design flow conditions measured at any customer's water meter or at the property line if no meter exists.

(5) If fire flow is to be provided, the distribution system shall be designed to provide the required fire flow at a pressure of at least 20 psi during peak hourly design flow conditions.

(6) Booster pumps needed for individual services shall be subject to review and approval by the department. Installation shall be made under the supervision of the purveyor to assure cross-connection control requirements are met.

[Statutory Authority: RCW 43.20.050. 94-14-001, § 246-290-230, filed 6/22/94, effective 7/23/94; 93-08-011 (Order 352B), § 246-290-230, filed 3/25/93, effective 4/25/93; 91-02-051 (Order 124B), recodified as § 246-290-230, filed 12/27/90, effective 1/31/91. Statutory Authority: RCW 34.04.045. 88-05-057 (Order 307), § 248-54-135, filed 2/17/88. Statutory Authority: RCW 43.20.050. 83-19-002 (Order 266), § 248-54-135, filed 9/8/83.]

**WAC 246-290-240 Disinfection of facilities.** No portion of a public water system containing potable water shall be put into service, nor shall service be resumed, until the facility has been effectively disinfected. The procedure used for disinfection shall conform to the American Water Works Association standards or other standards acceptable to the department. In cases of new construction, drinking water shall not be furnished to the consumer until satisfactory bacteriological samples have been analyzed by a laboratory certified by the state.

[Statutory Authority: RCW 43.20.050. 91-02-051 (Order 124B), recodified as § 246-290-240, filed 12/27/90, effective 1/31/91. Statutory Authority: RCW 34.04.045. 88-05-057 (Order 307), § 248-54-145, filed 2/17/88. Statutory Authority: RCW 43.20.050. 83-19-002 (Order 266), § 248-54-145, filed 9/8/83.]

**WAC 246-290-250 Treatment design.** (1) Purveyors shall ensure finished water quality from existing and proposed sources of supply conforms to the minimum water quality standards established in WAC 246-290-310.

(2) Purveyors using surface water or GWI sources shall design, install, and operate treatment facilities to ensure at least:

(a) 99.9 percent (3 log) removal and/or inactivation of *Giardia lamblia* cysts; and

(b) 99.99 percent (4 log) removal and/or inactivation of viruses.

Part 6 of chapter 246-290 WAC contains specific requirements for filtered and unfiltered surface water and GWI systems, including treatment technique, monitoring and reporting requirements.

(3) Predesign studies shall be required for proposed surface water and GWI sources and those ground water sources requiring treatment. The goal of the predesign study shall be to establish the most effective method, considering economics, to produce satisfactory finished water quality meeting the requirements of this chapter and complying with the treatment technique requirements in Part 6 of chapter 246-290 WAC. The predesign study shall be included as part of the project report under WAC 246-290-110. Refer to WAC 246-290-676 for requirements relating specifically to the filtration facility pilot study.

(4) The minimum level of treatment for all well sources and spring sources not classified as GWI's shall be continuous and effective disinfection as determined by the department. The department may reduce the requirement for disinfection for public water systems with:

(a) Well sources not classified as GWI's:

(i) Having a satisfactory bacteriological history at the source and within the distribution system as determined by the department; and

(ii) Drawing from a protected aquifer as determined by the department.

(b) Spring sources not classified as GWI's:

(i) Having a satisfactory bacteriological history at the source and within the distribution system as determined by the department;

(ii) Having evidence to demonstrate, to the satisfaction of the department, the spring originates in a stratum not subject to contamination; and

(iii) Where the water is collected by a method precluding contamination.

(5) The minimum level of treatment for surface water supplies shall be coagulation, flocculation, filtration, and disinfection. In certain cases, alternative treatment designs followed by disinfection may be acceptable to the department, provided there is adequate engineering justification. Group A systems with surface water sources and GWI sources shall provide treatment as specified under WAC 246-290-630.

(6) Disinfection methods, other than chlorination, such as ozonation, ultraviolet radiation, and iodination, may be approved by the department with appropriate engineering justification.

[Statutory Authority: RCW 43.20.050. 93-08-011 (Order 352B), § 246-290-250, filed 3/25/93, effective 4/25/93; 91-02-051 (Order 124B), recodified as § 246-290-250, filed 12/27/90, effective 1/31/91. Statutory Authority: RCW 34.04.045. 88-05-057 (Order 307), § 248-54-155, filed 2/17/88. Statutory Authority: RCW 43.20.050. 83-19-002 (Order 266), § 248-54-155, filed 9/8/83.]

## PART 4. WATER QUALITY

**WAC 246-290-300 Monitoring requirements.** (1) General.

(a) The monitoring requirements specified in this section are minimums. The department may require additional monitoring when:

(i) Contamination is present or suspected in the water system;

(ii) The department determines a ground water source may be a GWI;

(iii) The department determines the degree of source protection is not satisfactory;

(iv) The department determines additional monitoring is needed to verify source vulnerability for a requested monitoring waiver; or

(v) Under other circumstances as identified in a departmental order.

(b) Special purpose samples collected by the purveyor shall not count toward fulfillment of the monitoring requirements of this chapter unless both quality of data and method of analysis are acceptable to the department.

(c) The purveyor shall ensure samples required by this chapter are collected, transported, and submitted for analysis according to department-approved methods. The analyses shall be performed by the state public health laboratory or another laboratory certified by the department. Qualified water utility, certified laboratory, or health department personnel may conduct measurements for pH, temperature, residual disinfectant concentration and turbidity as required by this chapter, provided, these measurements are made in accordance with "standard methods."

(d) Compliance samples required by this chapter shall be taken at locations listed in Table 3 of this section.

(e) When one public water system sells water to another public water system, the purveyor of the selling system, regardless of size, shall conduct at least the minimum source monitoring required by this chapter for community systems.

(f) When one public water system receives completely treated water, as determined by the department, from another public water system, the purveyor of the receiving system shall:

(i) Collect coliform samples in accordance with subsection (2) of this section;

(ii) Collect trihalomethane samples in accordance with subsection (5) of this section;

(iii) Perform the distribution system residual disinfectant concentration monitoring required under WAC 246-290-440 or 246-290-694;

(iv) Perform lead and copper monitoring required under 40 CFR 141.86, 141.87, and 141.88; and

(v) Perform the distribution system monitoring in accordance with 40 CFR 141.23(b) for asbestos if applicable.

(g) The department may reduce the coliform, lead and copper, THM and distribution system disinfectant residual concentration monitoring requirements of the receiving system provided the receiving system:

(i) Has a satisfactory water quality history as determined by the department;

(ii) Operates in a satisfactory manner consistent with this chapter;

(iii) Purchases water from a purveyor which has a department-approved regional monitoring program; and

(iv) Has a written agreement with the supplying system that is acceptable to the department, which identifies the responsibilities of both the supplying and receiving system with regards to monitoring, reporting and maintenance of the distribution system.

(h) The department may periodically review both the selling and receiving system's sampling records to determine if continued reduced monitoring is appropriate. If the department determines a change in the monitoring requirements of the receiving system is appropriate:

(i) The department shall notify the purveyor of the change in monitoring requirements; and

(ii) The purveyor shall conduct monitoring as directed by the department.

(i) Purveyors failing to comply with a monitoring requirement shall notify:

(i) The department in accordance with WAC 246-290-480; and

(ii) The water system users in accordance with WAC 246-290-330.

(2) Bacteriological.

(a) The purveyor shall be responsible for collection and submittal of coliform samples from representative points throughout the distribution system after the first service and at regular time intervals at least once per calendar month unless otherwise specified in this subsection, each month the system provides water to consumers.

(b) Coliform monitoring plan.

(i) The purveyor shall prepare a written coliform monitoring plan and base routine monitoring upon the plan. A department guideline titled *Preparation of a Coliform Monitoring Plan* is available to assist the purveyor in preparing this plan.

(ii) The plan shall include at a minimum:

(A) A system map or diagram showing the locations of:

(I) Water sources;

(II) Storage, treatment, and pressure regulation facilities;

(III) Distribution systems;

(IV) Pressure zones;

(V) Interconnections; and

(VI) Coliform sample collection sites.

(B) A narrative which includes the following information:

(I) Public water system identification number;

(II) Population served and services;

(III) Water sources;

(IV) System facilities and processes for storage, treatment, and pressure regulation;

(V) Coliform sample collection sites; and

(VI) Sampling schedules.

(iii) The purveyor shall:

(A) Keep the coliform monitoring plan on file with the system and make it available to the department for inspection upon request;

(B) Revise or expand the plan at any time the plan no longer ensures representative monitoring of the system, or as directed by the department; and

(C) Submit the plan to the department for review and approval when requested and as part of the water system plan required under WAC 246-290-100.

(c) Monitoring frequency. The number of required routine coliform samples is based on total population served.

(i) Purveyors of **community** systems shall collect and submit for analysis no less than the number of routine samples listed in Table 2 during each calendar month of operation;

(ii) Purveyors of **noncommunity** systems shall collect and submit for analysis no less than the number of samples required in Table 2. Each month's population shall be based on the average daily population and shall include all residents and nonresidents served during that month. During months when the average daily population served is less than twenty-five, routine sample collection is not required when:

(A) Using only protected ground water sources;

(B) No coliforms were detected in samples during the previous month; and

(C) One routine sample has been collected and submitted for analysis during one of the previous two months.

(iii) Purveyors of systems serving both a resident and a nonresident population shall base their minimum sampling requirement on the total of monthly populations served, both resident and nonresident and on Table 2; and

(iv) Purveyors of systems with a nonresident population lasting two weeks or less during a month shall sample as directed by the department.

(d) Surface water or ground water under the direct influence of surface water (GWI) sources. A purveyor using unfiltered surface water or unfiltered GWI sources shall:

(i) Collect and submit for analysis, at least one coliform sample at the first service connection during each day in which source water turbidity exceeds 1.0 NTU; or

(ii) Collect samples as directed by the department when logistical problems beyond the purveyor's control make analysis of the coliform samples impractical because the time between sample collection and analysis exceeds thirty hours. If the department extends the time limits, the purveyor shall collect the required samples as directed by the department.

(e) Comprehensive system evaluations (CSEs).

(i) Purveyors of systems with less than four thousand one hundred one population served shall:

(A) Submit to a CSE conducted by the department; or

(B) Collect and submit for analysis five or more routine samples each month.

(ii) Purveyors electing to have CSEs conducted shall be evaluated by the department based on the following schedule:

(A) **Community** water systems, every five years. The initial CSE shall be conducted by June 29, 1994; and

(B) **Noncommunity** systems, every five years unless the system uses only disinfected and protected ground water as determined by the department, in which case the evaluation need only be repeated every ten years. The initial CSE shall be conducted by June 29, 1999.

(iii) The department may substitute source of contamination information from the wellhead protection program for CSE information if the information was collected since the last CSE; and

(iv) Purveyors collecting less than five routine samples per month shall be responsible for:

(A) Ensuring full cooperation in scheduling CSEs; and  
 (B) Making all facilities and records available to the department for the CSE.

(f) Invalid samples. When a coliform sample is determined invalid under WAC 246-290-320 (2)(d), the purveyor shall:

(i) Not include the sample in the determination of monitoring compliance; and

(ii) Collect and submit for coliform analysis, an additional drinking water sample from the same location as each invalid sample within twenty-four hours of notification by the laboratory of the invalid sample.

(g) The purveyor using a surface water or GWI source shall collect representative source water samples for bacteriological density analysis in accordance with WAC 246-290-664 and 246-290-694 as applicable.

TABLE 2

MINIMUM MONTHLY ROUTINE COLIFORM SAMPLING REQUIREMENTS

Population Served <sup>1</sup> During Month	Minimum Number of Routine Samples/Calendar Month	
	When NO samples with a coliform presence were collected during the previous month	When ANY samples with a coliform presence were collected during the previous month
1 - 1,000	1 <sup>2</sup>	5
1,001 - 2,500	2	5
2,501 - 3,300	3	5
3,301 - 4,100	4	5
4,101 - 4,900	5	5
4,901 - 5,800	6	6
5,801 - 6,700	7	7
6,701 - 7,600	8	8
7,601 - 8,500	9	9
8,501 - 12,900	10	10
12,901 - 17,200	15	15
17,201 - 21,500	20	20
21,501 - 25,000	25	25
25,001 - 33,000	30	30
33,001 - 41,000	40	40
41,001 - 50,000	50	50
50,001 - 59,000	60	60
59,001 - 70,000	70	70
70,001 - 83,000	80	80
83,001 - 96,000	90	90
96,001 - 130,000	100	100
130,001 - 220,000	120	120
220,001 - 320,000	150	150
320,001 - 450,000	180	180
450,001 - 600,000	210	210
600,001 - 780,000	240	240
780,001 - 970,000	270	270
970,001 - 1,230,000 <sup>3</sup>	300	300

<sup>1</sup> Does not include population of utilities purchasing water.

<sup>2</sup> Noncommunity systems using only protected ground water sources and serving less than 25 individuals, may collect and submit for analysis, one sample every three months.

<sup>3</sup> Systems serving populations larger than 1,230,000 shall contact the department for the minimum number of samples required per month.

### (3) Inorganic chemical and physical.

(a) A complete inorganic chemical and physical analysis shall consist of the primary and secondary chemical and physical substances.

(i) Primary chemical and physical substances are antimony, arsenic, asbestos, barium, beryllium, cadmium, chromium, cyanide, fluoride, mercury, nickel, nitrate (as N), nitrite (as N), selenium, sodium, thallium, and turbidity.

(ii) Secondary chemical and physical substances are chloride, color, hardness, iron, manganese, specific conductivity, silver, sulfate, total dissolved solids\*, and zinc.

\*Required only when specific conductivity exceeds seven hundred micromhos/centimeter.

(b) Purveyors shall monitor in accordance with 40 CFR 141.23(a) through 141.23(j), except for composite samples for systems serving less than 3,300 persons. For these systems, compositing among different systems may be allowed if the systems are owned or operated by a department-approved satellite management agency. A department guideline titled *Inorganic and Organic Chemical Monitoring Plans* is available on request.

(c) Samples required by this subsection shall be taken at designated locations in accordance with 40 CFR 141.23(a) through 141.23(j) and Table 3 herein.

(i) Wellfield samples shall be allowed from department designated wellfields; and

(ii) In accordance with 40 CFR 141.23 (a)(3), alternate sampling locations may be allowed if approved by the department. These alternate sites are described in the department guideline titled *Inorganic and Organic Chemical Monitoring Plans*. Purveyors of community and NTNC systems may ask the department to approve an alternate sampling location for multiple sources within a single system which are blended prior to entry to the distribution system. Department approval shall consider the following:

(A) Source vulnerability;

(B) Updated inorganic monitoring plan showing location of all sources with current and proposed sampling locations;

(C) Individual source characteristics;

(D) Previous water quality information;

(E) Status of monitoring waiver applications; and

(F) Other information deemed necessary by the department.

(d) Composite samples:

(i) In accordance with CFR 141.23 (a)(4), purveyors may ask the certified lab to composite samples representing as many as five individual samples from within one system. Sampling procedures and protocols are outlined in the department guideline titled *Inorganic and Organic Chemical Monitoring Plans*; and

(ii) For systems serving a population of less than three thousand three hundred one, the department may approve composite sampling between systems when those systems are part of an approved satellite management agency.

(e) When the purveyor provides treatment for one or more inorganic chemical or physical contaminants, the department may require the purveyor to sample before and after treatment. The department shall notify the purveyor if and when this additional source sampling is required.

(f) Inorganic monitoring plans.

(i) Purveyors of community and NTNC systems shall prepare an inorganic chemical monitoring plan and conduct routine monitoring in accordance with the plan. A department guideline titled *Inorganic and Organic Chemical*

*Monitoring Plans* is available to assist the purveyor in preparing this plan.

(ii) The plan shall include, at a minimum:

(A) A system map or diagram showing the location of:

(I) Water sources;

(II) Storage, treatment, and distribution system; and

(III) Inorganic sample collection locations.

(B) A narrative which includes the following information:

(I) The system's public water system identification number;

(II) Population served and number of services;

(III) Water sources;

(IV) Storage, treatment, and distribution system;

(V) Inorganic sampling locations (including asbestos if applicable);

(VI) Source vulnerability ratings and status of monitoring waiver applications; and

(VII) Sampling schedule.

(iii) The purveyor shall:

(A) Keep the monitoring plan on file with the system and make it available to the department for inspection upon request;

(B) Revise or expand the plan at any time the plan no longer reflects the monitoring requirements, procedures or sampling locations, or as directed by the department; and

(C) Submit the plan to the department for review and approval when requested and as part of the water system plan required under WAC 246-290-100.

(g) Monitoring waivers.

(i) Purveyors may request in writing, a monitoring waiver from the department for any nonnitrate/nitrite inorganic chemical and physical monitoring requirements identified in this chapter.

(ii) Purveyors requesting a monitoring waiver shall comply with applicable subsections of 40 CFR 141.23 (b)(3), 141.23 (c)(3), and 141.40 (n)(4). A department guideline titled *Source Vulnerability and Monitoring Waivers* is available to assist purveyors.

(iii) Purveyors shall update and resubmit requests for waiver renewals as applicable during each compliance cycle or period or more frequently as directed by the department.

(iv) Failure to provide complete and accurate information in the waiver application shall be grounds for denial of the monitoring waiver.

(h) The department may require the purveyor to repeat sample for confirmation of results.

(i) Purveyors with emergency and seasonal sources shall monitor those sources when they are in use.

(4) Lead and copper. Monitoring for lead and copper shall be conducted in accordance with 40 CFR 141.86, 141.87, and 141.88.

(5) Turbidity.

(a) Purveyors of systems with surface water or GWI sources and installing filtration, and other water systems as directed by the department, shall monitor turbidity a minimum of once per day at the entry to the distribution system.

(b) For purveyors of systems installing filtration, the monitoring requirement of (a) of this subsection is effective between written department notification of the filtration requirement and installation of filtration. Once filtration is

installed, the purveyor shall monitor turbidity in accordance with WAC 246-290-664.

(c) Purveyors of systems with surface water or GWI sources not subject to the requirements specified in (a) of this subsection, shall monitor turbidity in accordance with Subpart B or Subpart D of Part 6 of chapter 246-290 WAC, whichever is applicable.

(d) Purveyors conducting turbidity measurements shall ensure that analytical requirements are met, in accordance with WAC 246-290-638, at all times the system serves water to the public.

(6) Trihalomethanes.

(a) Purveyors of **community** systems serving a population of ten thousand or more and providing water treated with chlorine or other halogenated disinfectant shall monitor as follows:

(i) Ground water sources. The purveyor shall collect one sample from each treated spring, well, or well field every twelve months. This sample shall be taken at the source before treatment or at the extreme end of the distribution system. The sample shall be analyzed for maximum total trihalomethane potential (MTTP); or

(ii) Surface water sources. The purveyor shall collect four samples per treated source every three months. The samples shall be taken within a twenty-four-hour period. The purveyor shall take one of the samples from the extreme end of the distribution system and three samples from representative locations in the distribution system. The samples shall be analyzed for total trihalomethanes (TTHM), the sum of trichloromethane, bromodichloromethane, dibromochloromethane, and tribromomethane. After one year of monitoring, the department may reduce the monitoring frequency to one sample every three months per treatment plant if the TTHM levels are less than 0.10 mg/L. The purveyor shall take the sample at the extreme end of the distribution system; or

(iii) Purchased surface water sources. The purveyor shall collect one water sample per each purchased surface source every three months. The sample shall be taken at the extreme end of the distribution system and analyzed for TTHM.

(b) Purveyors of **community** systems shall monitor for TTHM when serving a population less than ten thousand and providing surface water treated with chlorine or other halogenated disinfectant. The purveyor shall collect one water sample per treated source every three months for one year. The sample shall be taken at the extreme end of the distribution system and analyzed for TTHM. After the first year, the purveyor shall monitor surface water sources every thirty-six months.

(c) Purveyors of **community** systems shall monitor for TTHM when serving less than ten thousand people and purchasing surface water treated with chlorine or other halogenated disinfectant or adding a halogenated disinfectant after purchase. The purveyor shall collect one water sample every three months at the extreme end of the distribution system or at a department-acceptable location. The sample shall be analyzed for TTHM. After the first year, the purveyor shall monitor every thirty-six months.

(7) Organic chemicals.

(a) Purveyors of community and NTNC water systems shall comply with monitoring requirements in accordance



with 40 CFR 141.24(a), 141.24(f), 141.24(g), 141.24(h), 141.40(a), 141.40(d), and 141.40(e).

(b) Sampling locations shall be as defined in 40 CFR 141.24(f), 141.24(g), 141.24(h), 141.40(b) and 141.40(c).

(i) Wellfield samples shall be allowed from department designated wellfields; and

(ii) In accordance with 40 CFR 141.24 (f)(3) and 141.24 (h)(3), alternate sampling locations may be allowed if approved by the department. These alternate locations are described in the departmental guideline titled *Inorganic and Organic Chemical Monitoring Plans*. Purveyors may ask the department to approve an alternate sampling location for multiple sources within a single system which are blended prior to entry to the distribution system. Department approval shall consider the following:

(A) Source vulnerability;

(B) An updated organic monitoring plan showing location of all sources with current and proposed sampling locations;

(c) Individual source characteristics;

(D) Previous water quality information;

(E) Status of monitoring waiver applications; and

(F) Other information deemed necessary by the department.

(c) Composite samples:

(i) Purveyors may ask the certified lab to composite samples representing as many as five individual samples from within one system. Sampling procedures and protocols are outlined in the department guideline titled *Inorganic and Organic Chemical Monitoring Plans*;

(ii) For systems serving a population of less than three thousand three hundred one, the department may approve composite sampling between systems when those systems are part of an approved satellite management agency.

(d) The department may require the purveyor to sample both before and after treatment for one or more organic contaminants. The department shall notify the purveyor if and when this additional source sampling is required.

(e) Organic chemical monitoring plans.

(i) Purveyors of community and NTNC systems shall prepare an organic chemical monitoring plan and conduct routine monitoring in accordance with the plan. A department guideline titled *Inorganic and Organic Chemical Monitoring Plans* is available to assist the purveyor in preparing this plan.

(ii) The plan shall include at a minimum:

(A) A system map or diagram showing the location of:

(I) Water sources;

(II) Storage, treatment, and distribution system; and

(III) Organic sample collection locations.

(B) A narrative which includes the following information:

(I) The system's public water system identification number;

(II) Population served and number of services;

(III) Water sources;

(IV) Storage, treatment, and distribution system;

(V) Organic sampling locations;

(VI) Source vulnerability ratings and status of monitoring waiver applications; and

(VII) Sampling schedule.

(iii) The purveyor shall:

(A) Keep the monitoring plan on file with the system and make it available to the department for inspection upon request;

(B) Revise or expand the plan at any time the plan no longer reflects the monitoring requirements, procedures or sampling locations, or as directed by the department; and

(C) Submit the plan to the department for review and approval when requested and as part of the water system plan required under WAC 246-290-100.

(f) Monitoring waivers.

(i) Purveyors may request in writing, a monitoring waiver from the department for any organic monitoring requirement except those relating to unregulated VOCs;

(ii) Purveyors requesting a monitoring waiver shall comply with 40 CFR 141.24 (f)(7), 141.24 (f)(10), 141.24 (h)(6), 141.24 (h)(7) or 141.40 (n)(4). A department guideline titled *Source Vulnerability and Monitoring Waivers* is available to assist purveyors;

(iii) Purveyors shall update and resubmit requests for waiver renewals as directed by the department; and

(iv) Failure to provide complete and accurate information in the waiver application shall be grounds for denial of the monitoring waiver.

(g) Purveyors with emergency and seasonal sources shall monitor those sources when they are in use.

(8) Unregulated chemicals.

(a) Unregulated inorganic contaminants. Purveyors of community and NTNC systems shall:

(i) Monitor for the unregulated inorganic chemicals listed in 40 CFR 141.40 (n)(12); and

(ii) Comply with monitoring methods, frequencies, and sampling locations in accordance with 40 CFR 141.40 (n)(2) through 141.40 (n)(9) and 141.40 (n)(12).

(iii) Apply in writing for a monitoring waiver according to the conditions outlined in 40 CFR 141.40 (n)(3), and the departmental procedures described in subsection (7)(f) of this section.

(iv) Request the department to defer this monitoring if they are a system with less than one hundred fifty service connections.

(b) Unregulated VOCs. Purveyors shall:

(i) Monitor in accordance with 40 CFR 141.40(e) and 141.40(j);

(ii) Comply with monitoring methods, frequency and sampling locations in accordance with 40 CFR 141.40(a) through 141.40(d), 141.40(g) and 141.40(i); and

(iii) Perform repeat monitoring for these compounds in accordance with 40 CFR 141.40(l).

(c) Unregulated SOCs. Purveyors shall:

(i) Monitor for the unregulated SOCs listed in 40 CFR 141.40 (n)(11); and

(ii) Comply with monitoring methods, frequencies, and sampling locations in accordance with 40 CFR 141.40 (n)(1) through 141.40 (n)(9).

Purveyors may request that the department defer this monitoring if a system has less than one hundred fifty service connections.

(d) Purveyors with emergency and seasonal sources shall monitor those sources when they are in use.

(9) Radionuclides.

(a) The purveyor's monitoring requirements for gross alpha particle activity, radium-226 and radium-228 shall be:



(i) **Community** systems shall monitor once every forty-eight months. Compliance shall be based on the analysis of an annual composite of four consecutive quarterly samples or the average of the analyses of four samples obtained at quarterly intervals;

(ii) The purveyor may omit analysis for radium-226 and radium-228 if the gross alpha particle activity is less than five pCi/L; and

(iii) If the results of the initial analysis are less than half of the established MCL, the department may allow compliance with the monitoring requirements based on analysis of a single sample collected every forty-eight months.

(b) The purveyor's monitoring requirements for man-made radioactivity shall be:

(i) Purveyors of **community** systems using surface water sources and serving more than one hundred thousand persons and other department-designated water systems shall monitor for man-made radioactivity (beta particle and photon) every forty-eight months. Compliance shall be based on the analysis of a composite of four consecutive quarterly samples or the analysis of four quarterly samples; and

(ii) The purveyor of a water system located downstream from a nuclear facility as determined by the department, shall monitor once every three months for gross beta and iodine-131, and monitor once every twelve months for strontium-90 and tritium. The department may allow the substitution of environmental surveillance data taken in conjunction with a nuclear facility for direct monitoring of man-made radioactivity if the department determines that such data is applicable to a particular public water system.

(10) Other substances.

On the basis of public health concerns, the department may require the purveyor to monitor for additional substances.

Organic Chemicals (VOCs & SOCs) From a point representative of the source, after treatment and prior to entry to distribution system.

Other Substances (unregulated chemicals) From a point representative of the source, after treatment, and prior to entry to the distribution system, or as directed by the department.

[Statutory Authority: RCW 43.20.050. 94-14-001, § 246-290-300, filed 6/22/94, effective 7/23/94; 93-08-011 (Order 352B), § 246-290-300, filed 3/25/93, effective 4/25/93; 92-04-070 (Order 241B), § 246-290-300, filed 2/4/92, effective 3/6/92. Statutory Authority: Chapter 43.20 RCW. 91-07-031 (Order 150B), § 246-290-300, filed 3/15/91, effective 4/15/91. Statutory Authority: RCW 43.20.050. 91-02-051 (Order 124B), recodified as § 246-290-300, filed 12/27/90, effective 1/31/91. Statutory Authority: P.L. 99-339. 89-21-020 (Order 336), § 248-54-165, filed 10/10/89, effective 11/10/89. Statutory Authority: RCW 34.04.045. 88-05-057 (Order 307), § 248-54-165, filed 2/17/88. Statutory Authority: RCW 43.20.050. 83-19-002 (Order 266), § 248-54-165, filed 9/8/83.]

**WAC 246-290-310 Maximum contaminant levels (MCLs).** (1) General.

(a) The purveyor shall be responsible for complying with the standards of water quality identified in this section. If a substance exceeds its maximum contaminant level (MCL), the purveyor shall take follow-up action in accordance with WAC 246-290-320.

(b) When enforcing the standards described under this section, the department shall enforce compliance with the primary standards as its first priority.

(2) Bacteriological.

(a) MCLs under this subsection shall be considered primary standards.

(b) Notwithstanding subsection (1) of this section, if coliform presence is detected in any sample, the purveyor shall take follow-up action in accordance with WAC 246-290-320(2).

(c) Acute MCL. An acute MCL for coliform bacteria occurs when there is:

- (i) Fecal coliform presence in a repeat sample;
- (ii) E. coli presence in a repeat sample; or
- (iii) Coliform presence in a set of repeat samples collected as a follow-up to a sample with fecal coliform or E. coli presence.

(d) Nonacute MCL. A nonacute MCL for coliform bacteria occurs when:

- (i) Systems taking less than forty routine samples during the month have more than one sample with coliform presence; or
- (ii) Systems taking forty or more routine samples during the month have more than 5.0 percent with coliform presence.

(e) MCL compliance. The purveyor shall determine compliance with the coliform MCL for each month the system provides drinking water to the public. In determining MCL compliance, the purveyor shall:

- (i) Include:
  - (A) Routine samples;
  - (B) Repeat samples; and
  - (C) Samples collected under WAC 246-290-300 (2)(d).
- (ii) Not include:
  - (A) Samples invalidated under WAC 246-290-320 (2)(d); and

TABLE 3  
MONITORING LOCATION

Sample Type	Sample Location
Asbestos	One sample from distribution system or if required by department, from the source.
Bacteriological	From representative points throughout distribution system.
Complete Inorganic Chemical	From a point representative of the source, after treatment, and prior to entry to the distribution system.
Lead/Copper	From the distribution system at targeted sample tap locations.
Nitrate/Nitrite	From a point representative of the source, after treatment, and prior to entry to the distribution system.
Turbidity - Surface Water	From a location at or before the entry point to the distribution system.
Trihalomethanes - Surface Water	From representative points in the distribution system.
- Ground Water	From the source before treatment.
Radionuclides	From the source.

(B) Special purpose samples.

(3) Inorganic chemical and physical.

The primary and secondary MCLs are listed in Table 4 and 5:

TABLE 4  
INORGANIC CHEMICAL CHARACTERISTICS

Substance	Primary MCLs (mg/L)
Antimony (Sb)	0.006
Arsenic (As)	0.05
Asbestos	7 million fibers/liter (longer than 10 microns)
Barium (Ba)	2.0
Beryllium (Be)	0.004
Cadmium (Cd)	0.005
Chromium (Cr)	0.1
Copper (Cu)	*
Cyanide (HCN)	0.2
Fluoride (F)	4.0
Lead (Pb)	*
Mercury (Hg)	0.002
Nickel (Ni)	0.1
Nitrate (as N)	10.0
Nitrite (as N)	1.0
Selenium (Se)	0.05
Sodium (Na)	*
Thallium (Tl)	0.002

Substance	Secondary MCLs (mg/L)
Chloride (Cl)	250.0
Fluoride (F)	2.0
Iron (Fe)	0.3
Manganese (Mn)	0.05
Silver (Ag)	0.1
Sulfate (SO <sub>4</sub> )	250.0
Zinc (Zn)	5.0

\* Although the state board of health has not established MCLs for copper, lead, and sodium, there is enough public health significance connected with copper, lead, and sodium levels to require inclusion in inorganic chemical and physical source monitoring.

TABLE 5  
PHYSICAL CHARACTERISTICS

Substance	Primary MCL
Turbidity	1 NTU

Substance	Secondary MCLs
Color	15 Color Units
Hardness	None established
Specific Conductivity	700 umhos/cm
Total Dissolved Solids (TDS)	500 mg/L

(4) Turbidity.

(a) The department shall consider standards under this subsection primary standards.

(b) The MCL for turbidity is in effect for systems using surface water or GWI sources until the treatment technique requirements of Part 6 of chapter 246-290 WAC become effective as listed in Table 9, 12, 13, or 14, whichever is applicable.

(c) The MCLs for turbidity are:

(i) 1.0 NTU, as determined by a monthly average of the daily turbidity, where the daily turbidity is defined as the average of the:

(A) Highest two hourly readings over a twenty-four hour period when continuous monitoring is used; or

(B) Daily grab samples taken the same hour every day when daily monitoring is used.

The department may increase the MCL to five NTUs if the purveyor can show the source is within a controlled watershed and the source meets the requirements under WAC 246-290-135.

(ii) 5.0 NTUs based on an average of the maximum daily turbidity for two consecutive days.

(5) Trihalomethanes.

(a) The department shall consider standards under this subsection primary standards.

(b) The MCL for total trihalomethanes (TTHM) is 0.10 mg/L calculated on the basis of a running annual average of quarterly samples. The concentrations of each of the trihalomethane compounds (trichloromethane, dibromochloromethane, bromodichloromethane, and tribromomethane) are added together to determine the TTHM level.

(c) There is no MCL for maximum total trihalomethane potential (MTTP). When the MTTP value exceeds 0.10 mg/L, the purveyor shall follow up as described under WAC 246-290-320(5).

(6) Radionuclides.

(a) The department shall consider standards under this subsection primary standards.

(b) The MCLs for radium-226, radium-228, and gross alpha particle radioactivity are:

TABLE 6

Substance	MCL (pCi/L)
Radium-226	3
Combined Radium-226 and Radium-228	5
Gross alpha particle activity (excluding uranium)	15

(c) The MCL for beta particle and photon radioactivity from man-made radionuclides is: The average annual concentration shall not produce an annual dose equivalent to the total body or any internal organ greater than four millirem/year.

The department shall assume compliance with the four millirem/year dose limitation if the average annual concentration for gross beta activity, tritium, and strontium-90 are less than 50 pCi/L, 20,000 pCi/L, and 8 pCi/L respectively. When both tritium and strontium-90 are present, the sum of

their annual dose equivalents to bone marrow shall not exceed four millirem/year.

(7) Organic chemicals.

(a) The department shall consider standards under this subsection primary standards.

(b) VOCs.

(i) The MCLs for VOCs shall be as listed in 40 CFR 141-61(a).

(ii) The department shall determine compliance with this subsection based on compliance with 40 CFR 141.24(f).

(c) SOCs.

(i) MCLs for SOCs shall be as listed in 40 CFR 141.61(c).

(ii) The department shall determine compliance with this subsection based on compliance with 40 CFR 141.24(h).

(8) Other chemicals.

(a) The state board of health shall determine maximum contaminant levels for any additional substances.

(b) Purveyors may be directed by the department to comply with state advisory levels (SALs) for contaminants that do not have a MCL established in chapter 246-290 WAC. SALs shall be:

(i) MCLs which have been promulgated by the EPA, but which have not yet been adopted by the state board of health; or

(ii) State board of health adopted levels for substances recommended by the department and not having an EPA established MCL. A listing of these may be found in the department document titled *Procedures and References for the Determination of State Advisory Levels for Drinking Water Contaminants* dated March 1991, which has been approved by the state board of health and is available on request.

[Statutory Authority: RCW 43.20.050. 94-14-001, § 246-290-310, filed 6/22/94, effective 7/23/94; 93-08-011 (Order 352B), § 246-290-310, filed 3/25/93, effective 4/25/93; 92-04-070 (Order 241B), § 246-290-310, filed 2/4/92, effective 3/6/92. Statutory Authority: Chapter 43.20 RCW. 91-07-031 (Order 150B), § 246-290-310, filed 3/15/91, effective 4/15/91. Statutory Authority: RCW 43.20.050. 91-02-051 (Order 124B), recodified as § 246-290-310, filed 12/27/90, effective 1/31/91. Statutory Authority: P.L. 99-339. 89-21-020 (Order 336), § 248-54-175, filed 10/10/89, effective 11/10/89. Statutory Authority: RCW 34.04.045. 88-05-057 (Order 307), § 248-54-175, filed 2/17/88. Statutory Authority: RCW 43.20.050. 83-19-002 (Order 266), § 248-54-175, filed 9/8/83.]

**WAC 246-290-320 Follow-up action.** (1) General.

(a) When an MCL violation occurs, the purveyor shall take follow-up action as described in this section.

(b) When a primary standard violation occurs, the purveyor shall:

(i) Notify the department in accordance with WAC 246-290-480;

(ii) Notify the consumers served by the system in accordance with WAC 246-290-330;

(iii) Determine the cause of the contamination; and

(iv) Take action as directed by the department.

(c) When a secondary standard violation occurs, the purveyor shall notify the department and take action as directed by the department.

(d) The department may require additional sampling for confirmation of results. A department guideline on confirmation sampling titled *Inorganic and Organic Monitoring Plans* is available on request.

(2) Bacteriological.

(a) When coliform bacteria are present in any sample and the sample is not invalidated under (d) of this subsection, the purveyor shall ensure the following actions are taken:

(i) The sample is analyzed for fecal coliform or *E. coli*. When a sample with a coliform presence is not analyzed for *E. coli* or fecal coliforms, the sample shall be considered as having a fecal coliform presence for MCL compliance purposes;

(ii) Repeat samples are collected in accordance with (b) of this subsection;

(iii) The department is notified in accordance with WAC 246-290-480; and

(iv) The cause of the coliform presence is determined and corrected.

(b) Repeat samples.

(i) The purveyor shall collect and submit for analysis a set of repeat samples for every sample in which the presence of coliforms is detected. A set of repeat coliform samples consists of:

(A) Four repeat samples for systems collecting one routine coliform sample each month; or

(B) Three repeat samples for all systems collecting more than one routine coliform sample each month.

(ii) The purveyor shall collect repeat sample sets according to Table 7;

(iii) The purveyor shall collect one set of repeat samples for each sample with a coliform presence. All samples in a set of repeat samples shall be collected on the same day and submitted for analysis within twenty-four hours after notification by the laboratory of a coliform presence. If the purveyor can demonstrate to the satisfaction of the department, that logistical problems beyond the purveyor's control make analysis of the samples in the repeat sample set impractical because the time between sample collection and analysis will exceed thirty hours, then the purveyor shall collect the required set of repeat samples as directed by the department.

(iv) When repeat samples have coliform presence, the purveyor shall:

(A) Contact the department and collect a minimum of one additional set of repeat samples as directed by the department; or

(B) Collect one additional set of repeat samples for each sample where coliform presence was detected.

(v) The purveyor of a system providing water to consumers via a single service shall collect repeat samples from the same location as the sample with a coliform presence. The set of repeat samples shall be collected:

(A) On the same collection date; or

(B) Over consecutive days with one sample collected each day until the required samples in the set of repeat samples are collected.

(vi) If a sample with a coliform presence was collected from the first two or last two active services, the purveyor shall monitor as directed by the department;

(vii) The purveyor may change a previously submitted routine sample to a sample in a set of repeat samples when the purveyor:

(A) Collects the sample within five adjacent service connections of the location from which the initial sample with a coliform presence was collected;

(B) Collects the sample after the initial sample with a coliform presence was submitted for analysis;

(C) Collects the sample on the same day as other samples in the set of repeat samples, except under (b)(iii) of this subsection; and

(D) Notifies the department of the change.

(viii) The department may determine that sets of repeat samples specified under this subsection are not necessary during a month when a nonacute coliform MCL violation is determined for the system.

Table 7  
REPEAT SAMPLE REQUIREMENTS

(SYSTEM GROUP - II) # OF ROUTINE SAMPLES COLLECTED EACH MONTH(III)	# OF SAMPLES IN A SET OF REPEAT SAMPLES	LOCATIONS FOR REPEAT SAMPLES (COLLECT AT LEAST ONE SAMPLE PER SITE)
(GROUP-A I) 1 (routine-sample -each-month)	4	<ul style="list-style-type: none"> <li>◆ Site of previous sample with a coliform presence</li> <li>◆ Within 5 active services upstream of site of sample with a coliform presence</li> <li>◆ Within 5 active services downstream of site of sample with a coliform presence</li> <li>◆ At any other active service</li> </ul>
(GROUP-A I) more than 1 (routine -sample-each-month)	3	<ul style="list-style-type: none"> <li>◆ Site of previous sample with a coliform presence</li> <li>◆ Within 5 active services upstream of site of sample with a coliform presence</li> <li>◆ Within 5 active services downstream of site of sample with a coliform presence</li> </ul>
(GROUP-B)	2	<ul style="list-style-type: none"> <li>◆ Site of the previous sample with a coliform presence</li> <li>◆ From active service other than the site of the previous sample with a coliform presence</li> </ul>

(c) Monitoring frequency following a coliform presence. Systems having one or more coliform presence samples that were not invalidated during the previous month shall collect and submit for analysis the minimum number of samples shown in the last column of Table 2.

(i) The department may reduce the monitoring frequency requirement when one or more samples with a coliform presence were collected during the previous month, if the purveyor proves to the satisfaction of the department;

(A) The cause of the sample with a coliform presence; and

(B) The problem is corrected before the end of the next month the system provides water to the public.

(ii) If the department reduces this monitoring frequency requirement:

(A) The purveyor shall collect and submit at least the minimum number of samples required when no samples with a coliform presence were collected during the previous month; and

(B) The department shall make available a written description explaining:

(I) The specific cause of the coliform presence; and

(II) Action taken by the purveyor to correct the cause of coliform presence.

(d) Invalid samples.

(i) The department shall consider coliform samples with no coliform presence detected invalid when:

(A) Multiple tube technique cultures are turbid without appropriate gas production;

(B) Presence-absence technique cultures are turbid in the absence of an acid reaction;

(C) There are confluent growth patterns or growth of TNTC (too numerous to count) colonies without a surface sheen using a membrane filter analytic technique; or

(D) There is excess debris in the sample.

(ii) The department may invalidate a coliform sample when:

(A) The analyzing laboratory establishes that improper sample analysis occurred;

(B) The department determines a domestic or nondistribution system problem is indicated by:

(I) All samples in the set of repeat samples collected at the same location as the original coliform presence sample also are coliform presence; and

(II) All other samples in the set of repeat samples are free of coliform.

(C) The department determines a coliform presence result is due to a circumstance or condition which does not reflect water quality in the distribution system. In this case, when the department invalidates a sample:

(I) The purveyor shall collect a set of repeat samples following the sample invalidation in accordance with Table 7; and

(II) The department's rationale for invalidating the sample shall be documented in writing and made available to the public. The documentation shall state the specific cause of the coliform presence, and what action the purveyor has taken, or will take.

(iii) When a coliform sample is determined invalid, the purveyor shall collect and submit for analysis:

(A) An additional coliform sample from the same location as each invalid sample within twenty-four hours of notification of the invalid sample; or

(B) Additional coliform samples as directed by the department.

(iv) When the department or laboratory invalidates a sample, the sample shall not count towards the purveyor's minimum coliform monitoring requirements.

(3) Inorganic chemical and physical follow-up monitoring shall be conducted in accordance with the following:

(a) For nonnitrate/nitrite inorganic chemicals, 40 CFR 141.23 (a)(4), 141.23 (b)(8), 141.23 (c)(7), 141.23 (f)(1), 141.23(g), 141.23(m) and 141.23(n);

(b) For nitrate, 40 CFR 141.23 (a)(4), 141.23 (d)(2), 141.23 (d)(3), 141.23 (f)(2), 141.23(g), 141.23(m), 141.23(n), and 141.23(o); or

(c) For nitrite, 40 CFR 141.23 (a)(4), 141.23 (e)(3), 141.23 (f)(2), and 141.23(g).

(4) Lead and copper follow-up monitoring shall be conducted in accordance with 40 CFR 141.85(d), 141.86 (d)(2), 141.86 (d)(3), 141.87(d) and 141.88(b) through 141.88(d).

(5) Turbidity.

(a) Purveyors using sources not subject to Part 6 of chapter 246-290 WAC and monitoring turbidity in accordance with WAC 246-290-300(4), shall notify the department as soon as possible, but in no case later than the end of the next business day, when:

(i) The turbidity is monitored continuously, and exceeds 1.0 NTU for longer than one hour; or

(ii) The results of turbidity analysis of grab samples exceeds 1.0 NTU, and a repeat sample taken within one hour also exceeds 1.0 NTU.

(b) Purveyors monitoring turbidity in accordance with Part 6 of chapter 246-290 WAC shall provide follow-up in accordance with WAC 246-290-634.

(6) Trihalomethanes. When the average of all samples taken during any twelve-month period exceeds the MCL for total trihalomethanes, the violation is confirmed and the purveyor shall take corrective action as required by the department. When the maximum trihalomethane potential (MTTP) result is equal to or greater than 0.10 mg/L and the result is confirmed by a repeat sample, the purveyor shall monitor according to WAC 246-290-300(5) for one year or more.

(7) Organic chemicals. Follow-up monitoring shall be conducted in accordance with the following:

(a) For VOCs, 40 CFR 141.24 (f)(11) through 141.24 (f)(15); or

(b) For SOCs, 40 CFR 141.24(b), 141.24(c) and 141.24 (h)(7) through 141.24 (h)(11).

(8) Unregulated inorganic and organic chemicals.

(a) Follow-up monitoring shall be conducted in accordance with 40 CFR 141.40 (n)(8) and 141.40 (n)(9).

(b) When an unregulated chemical is verified at a concentration above the detection limit, the purveyor shall:

(i) Submit the sample analysis results to the department within seven days of receipt from the laboratory; and

(ii) Sample the source a minimum of once every three months for one year and then annually thereafter during the three-month period when the highest previous measurement occurred.

(c) If the department determines that an unregulated chemical is verified at a level greater than a SAL, the department shall notify the purveyor in writing. The purveyor shall repeat sample the source as soon as possible after initial department notice that a SAL has been exceeded. The purveyor shall submit the analysis results to the department within seven days of receipt from the laboratory. If any repeat sample confirms that a SAL has been exceeded, the purveyor shall:

(i) Provide consumer information in accordance with WAC 246-290-330 (5)(b);

(ii) Investigate the cause of the contamination; and

(iii) Take follow-up or corrective action as required by the department.

(d) The department may reduce the purveyor's monitoring requirement for a source detecting an unregulated chemical if the source has been monitored annually for at least three years, and all analysis results are less than the SAL.

(9) The department shall determine the purveyor's follow-up action when a substance not included in this chapter is detected.

[Statutory Authority: RCW 43.20.050, 94-14-001, § 246-290-320, filed 6/22/94, effective 7/23/94; 93-08-011 (Order 352B), § 246-290-320, filed 3/25/93, effective 4/25/93; 92-04-070 (Order 241B), § 246-290-320, filed 2/4/92, effective 3/6/92. Statutory Authority: Chapter 43.20 RCW, 91-07-031 (Order 150B), § 246-290-320, filed 3/15/91, effective 4/15/91. Statutory Authority: RCW 43.20.050, 91-02-051 (Order 124B), recodified as § 246-290-320, filed 12/27/90, effective 1/31/91. Statutory Authority: P.L. 99-339, 89-21-020 (Order 336), § 248-54-185, filed 10/10/89, effective 11/10/89. Statutory Authority: RCW 34.04.045, 88-05-057 (Order 307), § 248-54-185, filed 2/17/88. Statutory Authority: RCW 43.20.050, 83-19-002 (Order 266), § 248-54-185, filed 9/8/83.]

**WAC 246-290-330 Public notification.** (1) Required notification.

The purveyor shall notify the water system users when the system:

(a) Has a MCL violation of a primary standard as described under WAC 246-290-310;

(b) Fails to comply with:

(i) Treatment technique requirements under Part 6 of chapter 246-290 WAC;

(ii) Monitoring requirements under WAC 246-290-300, 246-290-664, 246-290-674, or 246-290-694;

(iii) Analytical requirements of WAC 246-290-638 or chapter 246-390 WAC;

(iv) A departmental order; or

(v) A variance or exemption schedule prescribed by the state board of health.

(c) Is identified as a source of waterborne disease outbreak as determined by the department;

(d) Is issued a category red operating permit;

(e) Is issued a departmental order; or

(f) Is operating under a variance or exemption.

(2) Content. Notices shall provide:

(a) A clear, concise, and simple explanation of the violation;

(b) Discussion of potential adverse health effects and any segments of the population that may be at higher risk;

(c) Mandatory health effects information in accordance with subsection (4) of this section;

(d) A list of steps the purveyor has taken or is planning to take to remedy the situation;

(e) A list of steps the consumer should take, including advice on seeking an alternative water supply if necessary;

(f) The purveyor's name and phone number; and

(g) When appropriate, notices shall be multilingual.

The purveyor may provide additional information to further explain the situation.

(3) Distribution.

(a) Purveyors of **community** and NTNC systems with violations of a primary MCL, treatment technique or variance or exemption schedule shall provide:

(i) Newspaper notice to water system users as defined in (e) of this subsection, within fourteen days of violation;

(ii) Direct mail notice or hand delivery to all consumers served by the system within forty-five days of the violation. The department may waive the purveyor's mail or hand delivery if the violation is corrected within forty-five days. The waiver shall be in writing and made within the forty-five day period;

(iii) Notice to radio and television stations serving the area within seventy-two hours of violation of an acute coliform MCL under WAC 246-290-310 (3)(c), a nitrate MCL under WAC 246-290-310(4), occurrence of a waterborne disease outbreak or other acute violation as determined by the department; and

(iv) Repeat mail or hand delivery every three months until the violation is corrected.

(b) Purveyors of **community** and NTNC systems shall provide newspaper notice as defined in (e) of this subsection, to water system users within three months of the following:

(i) Violation of a monitoring requirement or testing procedure;

(ii) Receipt of a departmental order;

(iii) Receipt of a category red operating permit; or

(iv) Granting of a variance or exemption.

Purveyors shall also provide repeat notice by mail or hand delivery to all consumers served by the system every three months until the situation is corrected or for as long as the variance or exemption remains in effect.

(c) Purveyors of TNC systems shall post a notice within fourteen days of the following:

- (i) Violation of a primary MCL;
- (ii) Violation of a treatment technique requirement; or
- (iii) Violation of a variance or exemption schedule. If the violation is acute, the department shall require posting within seventy-two hours.

(d) Purveyors of TNC systems shall post a notice within three months of the:

- (i) Violation of a monitoring requirement or testing procedure;
- (ii) Receipt of a category red operating permit; or
- (iii) Granting of a variance or exemption.

(e) Newspaper notice, as used in this section, means publication in a daily newspaper of general circulation or in a weekly newspaper of general circulation if a daily newspaper does not serve the area. The purveyor may substitute a community or homeowner's association newsletter or similar periodical publication if the newsletter reaches all affected consumers within the specified time.

(f) The purveyor shall substitute a posted notice in the absence of a newspaper of general circulation or homeowner's association newsletter or similar periodical publication. The purveyor shall post the notice within the timeframe specified in this subsection.

(g) The purveyor shall place posted notices in conspicuous locations and present the notices in a manner making them easy to read. Notices shall remain posted until the violation is corrected or for as long as the variance or exemption remains in effect.

(h) The purveyor of a **community** or **NTNC** water system shall give a copy of the most recent public notice for all outstanding violations to all new billing units or new hookups before or at the time water service begins.

(i) The purveyor shall provide the department with a copy of the public notification at the time the purveyor notifies the public.

(4) Mandatory language.

(a) The purveyor shall provide specific health effects language in the notice when a violation involves:

- (i) A violation of a primary organic or inorganic chemical or physical MCL;
- (ii) A violation of a secondary fluoride MCL;
- (iii) A violation of an acute coliform MCL;
- (iv) A violation of a nonacute coliform MCL;
- (v) A treatment technique requirement;
- (vi) Granting or continuation of exemption or variance;

or

(vii) Failure to comply with a variance or exemption schedule.

(b) The purveyor shall provide specific mandatory language in its notification when the purveyor receives a category red operating permit.

(c) Required specific language is contained in the department guideline titled *Mandatory Language For Drinking Water Public Notification* and dated December 1993.

(5) Procedure for notification of organic chemical and unregulated chemical sample results.

(a) Availability of results. After receipt of the first analysis results, the purveyor of a **community** or **NTNC** water system shall notify persons served by the system of the availability of the results and shall supply the name and telephone number of a contact person. Purveyors with surface water sources shall include a statement that additional monitoring will be conducted for three more quarters, with results available on request.

(i) The purveyor shall initiate notification within three months of the purveyors receipt of the first analysis results. This notification is only required one time.

(ii) Notification shall occur by any of the following methods:

(A) Inclusion in the first set of water bills issued after receipt of the results;

(B) Newspaper notice which shall run at least one day each month for three consecutive months;

(C) Direct mail;

(D) Posting for at least one week if an **NTNC** system; or

(E) Any other method approved by the department.

(iii) Within three months of receipt of analysis results, purveyors selling water to other public water systems shall provide copies of the analysis results to the purchasing system.

(iv) Within thirty days of receipt of analysis results, purveyors purchasing water shall make results available to their customers. The purveyor's notification shall occur by the method outlined under (a)(i) of this subsection.

(b) Consumer information.

(i) The purveyor shall provide consumer information within twenty-one days of receipt of confirmation sample results when:

(A) A regulated chemical is confirmed at a concentration greater than a MCL, and the level will not cause the running annual average to exceed the MCL; or

(B) The department determines that an unregulated chemical is confirmed at a level greater than a SAL.

(ii) Consumer information shall include:

(A) Name and level of chemical detected;

(B) Location where the chemical was detected;

(C) Any health effects that the chemical could cause at its present concentration;

(D) Plans for follow-up activities; and

(E) Phone number to call for further information.

(iii) Consumer information shall be distributed by any of the following methods:

(A) Notice placed in the major newspaper in the affected area;

(B) Direct mail to customers;

(C) Posting for at least one week if an **NTNC** system; or

(D) Any other method approved by the department.

(6) Fluoride notification procedure.

When a primary or secondary MCL violation occurs or a variance or exemption is issued or a variance or exemption schedule is violated, the purveyor of a **community** water system shall send notice, including mandatory language, to:

(a) The department annually;

(b) Water system users annually; and

(c) New billing units added while the violation exists.

(7) When circumstances dictate the purveyor give a broader or more immediate notice to protect public health, the department may require the purveyor's notification by whatever means necessary.

(8) When the state board of health grants a public water system a waiver, the purveyor shall notify customers and new billing units or new hookups before water service begins. The purveyor shall provide a notice annually and send a copy to the department.

(9) The department may give notice to the water system users as required by this section on behalf of the water purveyor. However, the purveyor remains responsible for ensuring the department's requirements are met.

[Statutory Authority: RCW 43.20.050. 94-14-001, § 246-290-330, filed 6/22/94, effective 7/23/94; 93-08-011 (Order 352B), § 246-290-330, filed 3/25/93, effective 4/25/93; 92-04-070 (Order 241B), § 246-290-330, filed 2/4/92, effective 3/6/92. Statutory Authority: Chapter 43.20 RCW. 91-07-031 (Order 150B), § 246-290-330, filed 3/15/91, effective 4/15/91. Statutory Authority: RCW 43.20.050. 91-02-051 (Order 124B), recodified as § 246-290-330, filed 12/27/90, effective 1/31/91. Statutory Authority: P.L. 99-339. 89-21-020 (Order 336), § 248-54-187, filed 10/10/89, effective 11/10/89.]

## PART 5. WATER SYSTEM OPERATIONS

**WAC 246-290-410 Small water system management program.** (1) The purpose of a small water system management program is to assure the water system:

- (a) Is properly and reliably managed and operated, and
- (b) Continues to exist as a functional and viable entity.

(2) A small water system management program shall be developed and implemented for all systems not required to complete a water system plan as described under WAC 248-54-065.

(3) The department shall have the authority to require submission of this program for review and comment when:

- (a) A new water system is proposed;
- (b) A new project is proposed for an existing system;
- (c) An existing system has problems associated with inadequate or improper management or operations;

(d) Requested by the department for an existing system not having approved engineering documents, such as, or similar to, those described under WAC 248-54-086 and 248-54-096; or

(e) There is a change in ownership of the system.

(4) Department guidelines titled *Planning Handbook* and *"The Washington State Wellhead Protection Program"* are available to assist the purveyor in establishing the level of detail and content of the management program. Content and detail shall be consistent with the size, complexity, past performance, and use of the public water system. General content topics shall include, but not be limited to, the following elements:

- (a) Ownership and decision-making issues;
- (b) Financial viability;
- (c) Operations;

(d) Source protection, including a watershed control program or wellhead protection program when applicable under WAC 246-290-135; and

(e) Conservation.

(5) The department may require changes be made to a small water system management program if necessary to effectively accomplish the program's purpose.

[Statutory Authority: RCW 43.20.050. 94-14-001, § 246-290-410, filed 6/22/94, effective 7/23/94; 91-02-051 (Order 124B), recodified as § 246-290-410, filed 12/27/90, effective 1/31/91. Statutory Authority: P.L. 99-339. 89-21-020 (Order 336), § 248-54-196, filed 10/10/89, effective 11/10/89. Statutory Authority: RCW 34.04.045. 88-05-057 (Order 307), § 248-54-196, filed 2/17/88.]

**WAC 246-290-420 Reliability.** (1) All public water systems shall provide an adequate quantity and quality of water in a reliable manner at all times.

(a) In determining whether a proposed public water system or an expansion or modification of an existing system is capable of providing an adequate quantity of water, the department shall consider the immediate as well as the reasonably anticipated future needs of the system's consumers.

(b) In determining whether an existing public water system is providing an adequate quantity of water, the department shall consider the needs of the system's existing consumers exclusively, unless, in the department's discretion, consideration of the needs of potential consumers is in the public interest.

(2) The purveyor shall ensure the system is constructed, operated, and maintained to protect against failures of the power supply, treatment process, equipment, or structure with appropriate back-up facilities. Security measures shall be employed to assure the water source, water treatment processes, water storage facilities, and the distribution system are under the strict control of the purveyor.

(3) Where fire flow is required, a positive pressure at the water meter or property line shall be maintained throughout the system under fire flow conditions.

(4) Water pressure at the customer's service meter or property line if a meter is not used shall be maintained at the approved design pressure under peak hourly design flow conditions. In no case shall the pressure be less than twenty psi.

(5) Water use restrictions as a designed operation practice shall not be allowed. However, water use restrictions may be allowed in times of drought.

(6) No intake or other connection shall be maintained between a public water system and a source of water not approved by the department.

(7) A purveyor shall provide the department with the current names, addresses, and telephone numbers of the owners, operators, and emergency contact persons for the system, including any changes to this information. The purveyor shall also maintain twenty-four-hour phone availability and shall respond to customer concerns and service complaints in a timely manner.

[Statutory Authority: RCW 43.20.050. 93-08-011 (Order 352B), § 246-290-420, filed 3/25/93, effective 4/25/93; 91-02-051 (Order 124B), recodified as § 246-290-420, filed 12/27/90, effective 1/31/91. Statutory Authority: P.L. 99-339. 89-21-020 (Order 336), § 248-54-201, filed 10/10/89, effective 11/10/89. Statutory Authority: RCW 34.04.045. 88-05-057 (Order 307), § 248-54-201, filed 2/17/88.]

**WAC 246-290-430 Continuity of service.** (1) No purveyor shall transfer system ownership without providing



written notice to the department and all customers. Such notice shall be provided at least one year prior to the transfer, unless the new owner agrees to an earlier date. Notification shall include a time schedule for transferring responsibilities, identification of the new owner, and under what authority the new ownership will operate. If the system is a corporation, identification of the registered agent shall also be provided.

(2) It shall be the responsibility of the utility transferring ownership to ensure all health-related standards pursuant to chapter 248-54 WAC are met during transfer of the utility. It shall also be the responsibility of the utility transferring ownership to inform and train the new owner regarding operation of the utility.

(3) No purveyor shall end utility operations without providing written notice to all customers and the department at least one year prior to termination of service.

(4) Where this section may be in conflict with existing state statutes, the more stringent statute shall prevail.

[Statutory Authority: RCW 43.20.050. 91-02-051 (Order 124B), recodified as § 246-290-430, filed 12/27/90, effective 1/31/91. Statutory Authority: RCW 34.04.045. 88-05-057 (Order 307), § 248-54-205, filed 2/17/88. Statutory Authority: RCW 43.20.050. 83-19-002 (Order 266), § 248-54-205, filed 9/8/83.]

**WAC 246-290-440 Operations.** (1) The purveyor shall ensure that the system is operated:

(a) In accordance with the operations program as established in the approved water system plan required under WAC 246-290-100; and

(b) In accordance with good operations procedures such as those available in texts, handbooks, and manuals available from the following sources:

(i) American Water Works Association (AWWA), 666 West Quincy Avenue, Denver, Colorado 80235;

(ii) American Society of Civil Engineers (ASCE), 345 East 47th Street, New York, New York 10017-2398;

(iii) Ontario Ministry of the Environment, 135 St. Clair Avenue West, Toronto, Ontario M4V1B5, Canada;

(iv) The Chlorine Institute, 2001 "L" Street NW, Washington, D.C. 20036;

(v) California State University, 600 "J" Street, Sacramento, California 95819;

(vi) Health Research Inc., Health Education Services Division, P.O. Box 7126, Albany, New York 12224; and

(vii) Any other standards acceptable to the department.

(2) The purveyor shall ensure the development and implementation of an emergency response plan as part of the operations program pursuant to WAC 246-290-100. The emergency response plan shall include:

(a) General procedures for routine or major emergencies within the water system; and

(b) A vulnerability analysis and a contingency plan for facilities becoming inoperable in a major emergency.

The emergency response plan component of the operations program shall be maintained in such a manner as to be readily usable by personnel of the water system responsible for responding to emergencies.

(3) The purveyor shall not establish nor maintain a bypass to divert water around any feature of a treatment process, except by written approval from the department.

(4) The purveyor shall take preventive or corrective action as directed by the department when results of an inspection conducted by the department indicate conditions which are currently or may become a detriment to system operation.

(5) The purveyor of a system using ground water and required to disinfect, shall meet the following disinfection requirements, unless otherwise directed by the department:

(a) Minimum contact time at a point at or before the first customer of:

(i) Thirty minutes if 0.2 mg/L free chlorine residual is maintained, or

(ii) Ten minutes if 0.6 mg/L free chlorine residual is maintained.

(b) Detectable residual disinfectant concentration in all active parts of the distribution system, measured as total chlorine, free chlorine, combined chlorine, or chlorine dioxide;

(c) Water in the distribution system with an HPC level less than or equal to 500/mL is considered to have a detectable residual disinfectant concentration.

(6) The department may require the purveyor to provide longer contact times, higher chlorine residuals, or additional treatment to protect the health of consumers served by the public water system.

(7) The purveyor of a system using surface water or GWI shall meet disinfection requirements specified in Part 6 of chapter 246-290 WAC.

(8) The purveyor of a system providing disinfection shall monitor residual disinfectant concentration at representative points in the system on a daily basis, in accordance with WAC 246-290-674 or as approved by the department. The analyses shall be conducted in accordance with "standard methods." To assure adequate monitoring of chlorine residual, the department may require the use of continuous chlorine residual analyzers and recorders.

(9) A certified operator is required under chapter 70.119 RCW and chapter 246-292 WAC for public water systems:

(a) Serving one hundred services or more in use at any one time; or

(b) Using a surface water or GWI source.

[Statutory Authority: RCW 43.20.050. 94-14-001, § 246-290-440, filed 6/22/94, effective 7/23/94; 93-08-011 (Order 352B), § 246-290-440, filed 3/25/93, effective 4/25/93; 91-02-051 (Order 124B), recodified as § 246-290-440, filed 12/27/90, effective 1/31/91. Statutory Authority: RCW 34.04.045. 88-05-057 (Order 307), § 248-54-215, filed 2/17/88. Statutory Authority: RCW 43.20.050. 83-19-002 (Order 266), § 248-54-215, filed 9/8/83.]

**WAC 246-290-460 Fluoridation of drinking water.**

(1) Where fluoridation is practiced, the concentration of fluoride shall be maintained in the range 0.8 through 1.3 mg/L. Determination of fluoride concentration shall be made daily, and reports of such analyses shall be submitted to the department, in a format acceptable to the department, within ten days of the end of the reporting month. Such analyses shall be made in accordance with procedures listed in the most recently published edition of *Standard Methods for the Examination of Water and Waste Water*.

(2) Monthly check samples shall be taken downstream, at the first sample tap where adequate mixing has taken place, from each fluoride injection point. These samples

should be taken at the same place and time as the routine daily check samples. The samples along with a completed form shall be sent to the state public health laboratory, or a laboratory certified by the state, to test fluoride. A comparison of the results should then be made between samples analyzed in the field and the appropriate monthly check sample to assure the results are equivalent and field equipment is operating properly. An increased sampling schedule may be applied by the department if necessary to assure the adequacy and consistency of fluoridation.

[Statutory Authority: RCW 43.20.050, 91-02-051 (Order 124B), recodified as § 246-290-460, filed 12/27/90, effective 1/31/91. Statutory Authority: RCW 34.04.045, 88-05-057 (Order 307), § 248-54-235, filed 2/17/88. Statutory Authority: RCW 43.20.050, 83-19-002 (Order 266), § 248-54-235, filed 9/8/83.]

**WAC 246-290-470 Distribution reservoirs.** Existing uncovered distribution reservoirs shall be operated based on a plan of operation approved by the department. The plan of operation shall address the following elements as a minimum:

- (1) Continuous disinfection at all times water is being delivered to the public, including the reliability provisions outlined in WAC 246-290-420;
- (2) Control of debris and undesirable growths of algae or other aquatic organisms;
- (3) Control of surface water runoff;
- (4) Control of airborne contamination (atmospheric or avian-borne);
- (5) Construction;
- (6) Security; and
- (7) Monitoring and reporting.

[Statutory Authority: RCW 43.20.050, 93-08-011 (Order 352B), § 246-290-470, filed 3/25/93, effective 4/25/93; 91-02-051 (Order 124B), recodified as § 246-290-470, filed 12/27/90, effective 1/31/91; 83-19-002 (Order 266), § 248-54-245, filed 9/8/83.]

**WAC 246-290-480 Recordkeeping and reporting.**

(1) Records. The purveyor shall keep the following records of operation and water quality analyses:

(a) Bacteriological and turbidity analysis results shall be kept for five years. Chemical analysis results shall be kept for as long as the system is in operation. Records of daily source meter readings shall be kept for ten years. Other records of operation and analyses required by the department shall be kept for three years. All records shall bear the signature of the operator in responsible charge of the water system or his or her representative. Systems shall keep these records available for inspection by the department and shall send the records to the department if requested. Actual laboratory reports may be kept or data may be transferred to tabular summaries, provided the following information is included:

- (i) The date, place, and time of sampling, and the name of the person collecting the sample;
- (ii) Identification of the sample type (routine distribution system sample, repeat sample, source or finished water sample, or other special purpose sample);
- (iii) Date of analysis;
- (iv) Laboratory and person responsible for performing analysis;
- (v) The analytical method used; and

(vi) The results of the analysis.

(b) Records of action taken by the system to correct violations of primary drinking water standards. For each violation, copies of public notifications shall be kept for three years after the last corrective action taken.

(c) Copies of any written reports, summaries, or communications, relating to CSEs of the system conducted by system personnel, by a consultant or by any local, state, or federal agency, shall be kept for ten years after completion of the CSE involved.

(d) Copies of project reports, construction documents, and related drawings, inspection reports and approvals shall be kept for the life of the facility.

(e) Where applicable, daily records including:

- (i) Chlorine residual;
- (ii) Fluoride level;
- (iii) Water treatment plant performance including, but not limited to:
  - (A) Type of chemicals used and quantity,
  - (B) Amount of water treated, and
  - (C) Results of analyses.
- (iv) Turbidity;
- (v) Source meter readings; and
- (vi) Other information as specified by the department.

(2) Reporting.

(a) Unless otherwise specified in this chapter, the purveyor shall report to the department within forty-eight hours:

(i) The failure to comply with the primary standards or treatment technique requirements under this chapter;

(ii) The failure to comply with the monitoring requirements under this chapter; and

(iii) The violation of a primary MCL.

(b) The purveyor shall submit to the department reports required by this chapter, including tests, measurements, and analytic reports. Monthly reports are due before the tenth day of the following month, unless otherwise specified in this chapter.

(c) Daily source meter readings shall be made available to the department on request.

(d) Water facilities inventory and report form (WFI).

(i) Purveyors of **community** systems shall submit an annual WFI update to the department;

(ii) Purveyors of NTNC and TNC systems shall submit an updated WFI to the department as requested;

(iii) Purveyors shall submit an updated WFI to the department within thirty days of any change in name, category, ownership, or responsibility for management of the water system; and

(iv) At a minimum the completed WFI shall provide the current names, addresses, and telephone numbers of the owners, operators, and emergency contact persons for the system.

(e) Total annual water production. Purveyors shall report total annual water production for each source to the department upon request.

(f) Bacteriological.

(i) The purveyor shall notify the department of the presence of:

(A) Coliform in a sample, within ten days of notification by the laboratory; and

(B) Fecal coliform or E. coli in a sample, by the end of the business day in which the purveyor is notified by the laboratory. If the purveyor is notified of the results after normal close of business, then the purveyor shall notify the department before the end of the next business day.

(ii) When a coliform MCL violation is determined, the purveyor shall:

(A) Notify the department within twenty-four hours of determining acute coliform MCL violations;

(B) Notify the department before the end of the next business day when a nonacute coliform MCL is determined; and

(C) Notify water system users in accordance with WAC 246-290-330.

(iii) When a monitoring violation occurs, including invalid or expired CSEs, the purveyor shall:

(A) Notify the department of the violation within ten days; and

(B) Notify water system users in accordance with WAC 246-290-330.

(g) Systems monitoring for unregulated VOCs in accordance with WAC 246-290-300 (8)(b), shall send a copy of the results of such monitoring and any public notice to the department within thirty days of receipt of analytical results.

[Statutory Authority: RCW 43.20.050. 94-14-001, § 246-290-480, filed 6/22/94, effective 7/23/94; 93-08-011 (Order 352B), § 246-290-480, filed 3/25/93, effective 4/25/93; 92-04-070 (Order 241B), § 246-290-480, filed 2/4/92, effective 3/6/92; 91-02-051 (Order 124B), recodified as § 246-290-480, filed 12/27/90, effective 1/31/91. Statutory Authority: P.L. 99-339, 89-21-020 (Order 336), § 248-54-265, filed 10/10/89, effective 11/10/89. Statutory Authority: RCW 34.04.045. 88-05-057 (Order 307), § 248-54-265, filed 2/17/88. Statutory Authority: RCW 43.20.050. 83-19-002 (Order 266), § 248-54-265, filed 9/8/83.]

**WAC 246-290-490 Cross-connection control. (1) General.**

(a) Purveyors have the responsibility to protect public water systems from contamination due to cross-connections. Cross-connections which can be eliminated shall be eliminated. The purveyor shall work cooperatively with local authorities to eliminate or control potential cross-connections.

(b) The purveyor shall develop and implement a cross-connection control program acceptable to the department. The scope and complexity of the program shall be directly related to the size of the system and the potential public health risk. A department guideline titled *Planning Handbook* is available to assist the utility in developing this program. The most recently published edition of the manual titled *Accepted Procedure and Practice in Cross Connection Control - Pacific Northwest Section - American Waterworks Association* shall be used as a resource to establish:

(i) Minimum cross-connection control operating policies;

(ii) Backflow prevention assembly installation practices;

(iii) Backflow prevention assembly testing procedures;

and

(iv) Enforcement authority.

Purveyors and local authorities shall have the option of establishing more stringent requirements.

(c) The purpose of a cross-connection control program is to protect the health of water consumers and the potability of the public water system by assuring:

(i) The inspection and regulation of plumbing in existing and proposed piping networks; and

(ii) The proper installation and surveillance of backflow prevention assemblies when actual or potential cross-connections exist and cannot be eliminated.

(d) The cross-connection control program shall be included in the water system's plan under WAC 248-54-065 or small water system management program as outlined under WAC 248-54-196, whichever is appropriate.

(e) When an existing cross-connection poses a potential health or system hazard, the purveyor shall shut off water service to the premises until the cross-connection has been eliminated or controlled by the installation of a proper backflow prevention assembly. The cross-connection control program manager for the department shall be notified when a service has been shut off.

(2) Backflow prevention assembly installation and testing.

(a) If a cross-connection cannot be eliminated, then:

(i) An air-gap separation, reduced pressure principle backflow prevention assembly (RPBA) or a reduced pressure principle detector backflow prevention assembly (RPDA) shall be installed if the cross-connection creates an actual or potential health or system hazard.

(ii) An air-gap separation, RPBA, RPDA, double-check valve backflow prevention assembly (DCVA), or double-check detector backflow prevention assembly (DCDA) shall be installed if the cross-connection is objectionable, but does not pose an unreasonable risk to health.

(iii) A pressure vacuum breaker assembly (PVBA) or an atmospheric vacuum breaker may be installed where the substance which could backflow is objectionable but does not pose an unreasonable risk to health and where there is no possibility of backpressure in the downstream piping.

(iv) Backflow prevention assemblies, appropriate for the degree of hazard or air gaps and in some cases both, shall be installed at the service connection or within the following facilities, unless in the judgment of the water purveyor and the department, no hazard exists: Hospitals, mortuaries, clinics, laboratories, piers and docks, sewage treatment plants, food and beverage processing plants, chemical plants using water process, metal plating industries, petroleum processing or storage plants, radioactive material processing plants or nuclear reactors, car washes, facilities having a nonpotable auxiliary water supply, and others specified by the department.

(b) All installed RPBA's, RPDA's, DCVA's, DCDA's, and PVBA's shall be models included on the current list of backflow assemblies, approved for installation in Washington state, and maintained and published by the department. Backflow prevention assemblies in service, but not listed, shall remain in service provided the backflow prevention assemblies:

(i) Are listed on the current Washington state-approved cross-connection control assembly list at the time of installation;

(ii) Are properly maintained;

(iii) Are of a type appropriate for the degree of hazard; and

(iv) Are tested and successfully pass the test annually.

When unlisted assemblies are moved or require more than minimum maintenance, the unlisted assemblies shall be replaced by an assembly listed on the current approved model list.

(c) All air gaps and backflow prevention assemblies shall be installed in accordance with the cross-connection control manual referenced under WAC 248-54-285 (1)(b) of this section.

(d) The purveyor may permit the substitution of a properly installed air gap in lieu of an approved backflow prevention assembly. All such air gap substitutions shall be inspected annually by a Washington state certified backflow assembly tester.

(e) A Washington state certified backflow assembly tester shall inspect and test all:

- (i) RPBA's,
- (ii) RPDA's,
- (iii) DCVA's,
- (iv) DCDA's,
- (v) New PVBA installations, and
- (vi) Existing PVBA's discovered through routine inspections.

(f) Tests and/or inspections shall be conducted:

- (i) At the time of initial installation;
- (ii) Annually after initial installation, or more frequently if tests indicate repeated failures; and
- (iii) After the assembly is repaired.

(g) The assemblies shall be repaired, overhauled, or replaced whenever found to be defective. The purveyor shall require that improperly installed or altered air gaps be replumbed or replaced by an approved RPBA at their discretion. Inspections, tests, and repairs shall be made under the purveyor's supervision and records thereof kept as required by the purveyor.

(h) The purveyor shall deny or discontinue water service to any customer failing to cooperate in the installation, maintenance, testing, or inspection of backflow prevention assemblies required by the regulations of this chapter.

(3) Washington state certified backflow assembly testers.

(a) A backflow assembly tester shall become certified and maintain certification per department backflow assembly tester certification program guidelines.

(b) The department shall maintain a list of persons certified to test backflow prevention assemblies.

[Statutory Authority: RCW 43.20.050. 91-02-051 (Order 124B), recodified as § 246-290-490, filed 12/27/90, effective 1/31/91. Statutory Authority: P.L. 99-339. 89-21-020 (Order 336), § 248-54-285, filed 10/10/89, effective 11/10/89. Statutory Authority: RCW 34.04.045. 88-05-057 (Order 307), § 248-54-285, filed 2/17/88. Statutory Authority: RCW 43.20.050. 83-19-002 (Order 266), § 248-54-285, filed 9/8/83.]

**WAC 246-290-500 Severability.** If any provision of this chapter or its application to any person or circumstances is held invalid, the remainder of this chapter, or the application of the provision to other persons or circumstances, shall not be affected.

[Statutory Authority: RCW 43.20.050. 91-02-051 (Order 124B), recodified as § 246-290-500, filed 12/27/90, effective 1/31/91. Statutory Authority: RCW 34.04.045. 88-05-057 (Order 307), § 248-54-291, filed 2/17/88.]

## PART 6. SURFACE WATER TREATMENT

### Subpart A - Introduction and General Requirements

**WAC 246-290-601 Purpose of surface water treatment.** (1) Part 6 of chapter 246-290 WAC establishes filtration and disinfection as treatment technique requirements for water systems using surface or GWI sources. The Part 6 treatment technique requirements are established in lieu of maximum contaminant levels (MCLs) for the following contaminants:

- (a) *Giardia lamblia*;
- (b) Viruses;
- (c) Heterotrophic plate count bacteria;
- (d) *Legionella*; and
- (e) Turbidity.

(2) Turbidity MCLs found in WAC 246-290-310 shall remain in effect for systems using surface or GWI sources until applicable Part 6 treatment technique requirements become effective. The effective dates are indicated in Tables 9, 12, 13, or 14, whichever is applicable.

[Statutory Authority: RCW 43.20.050. 93-08-011 (Order 352B), § 246-290-601, filed 3/25/93, effective 4/25/93.]

**WAC 246-290-610 Definitions relating to surface water treatment.** Abbreviations and acronyms:

C - residual disinfectant concentration in mg/L;  
 CT - the mathematical product in mg/L - minutes of "C" and "T";  
 gpm - gallons per minute;  
 HPC - heterotrophic plate count;  
 T - disinfectant contact time in minutes; and  
 SWTR - Surface Water Treatment Rule.

"**Alternate filtration technology**" means a filtration process for substantial removal of particulates (generally  $\geq 2$  log *Giardia lamblia* cysts) by physical straining through a fixed medium. It does not include conventional, direct, diatomaceous earth, or slow sand filtration processes.

"**C**" means the residual disinfectant concentration in mg/L at a point before or at the first customer.

"**Coagulant**" means a chemical used in water treatment to destabilize particulates and accelerate the rate at which they aggregate into larger particles.

"**Coagulation**" means a process using coagulant chemicals and rapid mixing to destabilize colloidal and suspended particles and agglomerate them into flocs.

"**Completely treated water**" means water from a surface or GWI source which receives filtration or disinfection treatment that fully complies with the treatment technique requirements of Part 6 of chapter 246-290 WAC as determined by the department.

"**Continuous monitoring**" means determining water quality with automatic recording analyzers which operate without interruption twenty-four hours per day.

"**Conventional filtration treatment**" means a series of processes including coagulation, flocculation, sedimentation, and filtration which together result in substantial particulate removal ( $\geq 2.5$  log *Giardia lamblia* cysts).

"**CT**" or "**CT<sub>calc</sub>**" means the product of "residual disinfectant concentration" (C) and the corresponding "disinfectant contact time" (T) i.e., "C" x "T."

"**CT<sub>99.9</sub>**" means the CT value required for 99.9 percent (3 log) inactivation of *Giardia lamblia* cysts.

"CTreq" means the CT value a filtered system shall provide to achieve a specific percent inactivation of *Giardia lamblia* cysts as directed by the department.

"Diatomaceous earth filtration" means a filtration process for substantial removal of particulates ( $\geq 2$  log *Giardia lamblia* cysts) in which:

A precoat cake of graded diatomaceous earth filter media is deposited on a support membrane (septum); and

Water is passed through the cake on the septum while additional filter media, known as body feed, is continuously added to the feed water to maintain the permeability of the filter cake.

"Direct filtration" means a series of processes including coagulation, flocculation, and filtration (but excluding sedimentation) which together result in substantial particulate removal ( $\geq 2$  log *Giardia lamblia* cysts).

"Disinfectant contact time ("T" in CT)" means:

When measuring the first or only C, the time in minutes it takes water to move from the point of disinfectant application to a point where the C is measured; and For subsequent measurements of C, the time in minutes it takes water to move from one C measurement point to the C measurement point for which the particular T is being calculated.

"DOH SWTR Guidance Manual" means the departmental handbook which provides guidance on implementation of Part 6 of chapter 246-290 WAC.

"Emergency" means an unforeseen natural or man-made event which causes damage, disrupts normal operations, and requires prompt action to protect public health.

"Emergency source" means a department-approved source, physically disconnected from the system, and used only in emergencies.

"Filtration" means a process for removal of particulate matter from water by passage through porous media.

"Flocculation" means a process enhancing agglomeration and collection of colloidal and suspended particles into larger, more easily settleable or filterable particles by gentle stirring.

"Heterotrophic plate count bacteria (HPC)" means a broad class of bacteria, including innocuous, opportunistic, and pathogenic bacteria, which use organic nutrients for growth. The density of these bacteria in drinking water is measured as HPC.

"Inactivation" means a process which renders pathogenic microorganisms incapable of producing disease.

"Inactivation ratio" means:

$$\left[ \begin{array}{l} \text{CT}_{\text{calc}} \\ \text{CT}_{99.9} \end{array} \right] \quad \text{for unfiltered systems; and}$$

$$\left[ \begin{array}{l} \text{CT}_{\text{calc}} \\ \text{CT}_{\text{req}} \end{array} \right] \quad \text{for filtered systems.}$$

"Incompletely treated water" means water from a surface or GWI source which receives filtration and/or disinfection treatment that does not fully comply with the treatment technique requirements of Part 6 of chapter 246-290 WAC as determined by the department.

"In-line filtration" means a series of processes, including coagulation and filtration (but excluding flocculation and sedimentation) which together result in particulate removal.

"*Legionella*" means a genus of bacteria containing species which cause a type of pneumonia called Legionnaires' Disease.

"Peak hourly flow" means, for the purpose of CT calculations, the greatest volume of water passing through the system during any one hour in a day.

"Point of disinfectant application" means the point where the disinfectant is added, and where water downstream of that point is not subject to contamination by untreated surface water.

"Primary turbidity standard" means an accurately prepared formazin solution or commercially prepared polymer solution of known turbidity (prepared in accordance with "standard methods") which is used to calibrate bench model and continuous turbidimeters (instruments used to measure turbidity).

"Pressure filter" means an enclosed vessel containing properly sized and graded granular media through which water is forced under greater than atmospheric pressure.

"Removal credit" means the level (expressed as a percent or log) of *Giardia* and virus removal the department grants a system's filtration process.

"Sedimentation" means a process which uses gravity to remove suspended particles before filtration.

"Slow sand filtration" means a process involving passage of source water through a bed of sand at low velocity (generally less than 0.10 gpm/ft<sup>2</sup>) which results in substantial particulate removal ( $\geq 2$  log *Giardia lamblia* cysts) by physical and biological mechanisms.

"Source water" means untreated water which is not subject to recontamination by surface runoff and:

For unfiltered systems, enters the system immediately before the first point of disinfectant application; and

For filtered systems, enters immediately before the first treatment unit of a water treatment facility.

"Tracer study" means a field study conducted to determine the disinfectant contact time, T, provided by a water system component, such as a clearwell or storage reservoir, used for *Giardia lamblia* cyst and virus inactivation. The study involves introducing a tracer chemical at the inlet of the contact basin and measuring the resulting outlet tracer concentration as a function of time.

"Treatment technique requirement" means a department-established requirement for a public water system to provide treatment, such as filtration or disinfection, as defined by specific design, operating, and monitoring requirements. A "treatment technique requirement" is established in lieu of a primary MCL when monitoring for the contaminant is not economically or technologically feasible.

"Turbidity event" means a single day or series of consecutive days, not to exceed fourteen, when one or more turbidity measurement each day exceeds 5 NTU.

"T10" means the time it takes water with ten percent of an initial tracer concentration to appear at the outlet of the system component used for *Giardia lamblia* cyst and virus inactivation, when a tracer study is conducted at peak hourly flow.

"Water treatment facility" means, for the purposes of Part 6 of chapter 246-290 WAC, a facility which provides filtration and disinfection treatment to reduce physical contaminants and remove and inactivate pathogens; such facilities are designed and operated to achieve a water quality standard or comply with a treatment technique requirement to prevent acute or chronic health effects in consumers served by the system. Facilities which only add chemicals to the water for disinfection, corrosion control and/or dental prevention purposes are not included in this definition.

"Wellhead protection program" means a program designed to protect ground water based public water sources from contamination. A wellhead protection program includes elements such as:

- A delineated wellhead protection area;
- Identification of local jurisdictions having land use authority within the wellhead protection area;
- Inventory of contaminant sources;
- Contingency plans for the location and provision of alternate drinking water sources in the event of source contamination or loss; and

A spill response plan for the wellhead protection area.

"Virus" means a virus of fecal origin which is infectious to humans and transmitted through water.

[Statutory Authority: RCW 43.20.050. 93-08-011 (Order 352B), § 246-290-610, filed 3/25/93, effective 4/25/93.]

**WAC 246-290-620 Applicability of surface water treatment requirements.** (1) The requirements of Part 6 of chapter 246-290 WAC apply to **Group A** water systems which:

- (a) Use surface sources or ground water sources under the direct influence of surface water (GWI); or
- (b) Purchase surface or GWI water from an approved public water system or other entity acceptable to the department.

(2) The requirements of Part 6 of chapter 246-290 WAC do not apply to **Group A** water systems which use unfiltered surface or GWI sources as emergency sources, if the purveyor meets the following conditions:

- (a) Has a department-approved emergency response plan; and
- (b) Provides disinfection treatment which meets the requirements under WAC 246-290-662 (2)(e).

[Statutory Authority: RCW 43.20.050. 93-08-011 (Order 352B), § 246-290-620, filed 3/25/93, effective 4/25/93.]

**WAC 246-290-630 General requirements.** (1) The purveyor shall ensure that treatment is provided for surface and GWI sources consistent with the treatment technique requirements specified in Part 6 of chapter 246-290 WAC.

(2) The purveyor shall install and properly operate water treatment processes to ensure at least:

- (a) 99.9 percent (3 log) removal and/or inactivation of *Giardia lamblia* cysts; and
- (b) 99.99 percent (4 log) removal and/or inactivation of viruses.

(3) The purveyor shall ensure that the requirements of subsection (2) of this section are met between a point where

the source water is not subject to contamination by untreated surface water and a point at or before the first customer.

(4) The department may require higher levels of removal and/or inactivation of *Giardia lamblia* cysts and viruses than specified in subsection (2) of this section if deemed necessary to protect the health of consumers served by the system.

(5) The purveyor shall ensure that personnel operating a system subject to Part 6 of chapter 246-290 WAC meet the requirements under chapter 70.119 RCW and chapter 246-292 WAC.

(6) The purveyor of a **Group A community** system serving water to the public before January 1, 1991, shall comply with applicable minimum treatment requirements. The purveyor shall meet either the:

- (a) Filtration and disinfection requirements under WAC 246-290-660 and 246-290-662 respectively; or
- (b) Criteria to remain unfiltered under WAC 246-290-690 and the disinfection requirements under WAC 246-290-692.

(7) The purveyor of a **Group A noncommunity** system serving water to the public before January 1, 1991, shall install filtration and meet the filtration and disinfection requirements under WAC 246-290-660 and 246-290-662, respectively.

(8) The purveyor of a **Group A** system first serving water to the public after December 31, 1990, shall meet the filtration and disinfection requirements under WAC 246-290-660 and 246-290-662, respectively.

(9) The department shall provide notification to the purveyor of the requirement to install filtration. The purveyor of a system required to install filtration may abandon the surface or GWI source as a permanent or seasonal source and develop an alternate, department-approved source. Purveyors that choose this option and develop alternate ground water sources or purchase water from a department-approved public water system using a ground water source shall no longer be subject to Part 6 of chapter 246-290 WAC, once the alternate source is approved by the department and is on line.

(10) Part 6 compliance options are summarized in Table 8.

**Table 8**  
**COMPLIANCE OPTIONS FOR GROUP A SYSTEMS**  
**USING SURFACE OR GWI SOURCES**

SYSTEM TYPE	SURFACE WATER OPTIONS (system subject to Part 6)	ALTERNATE GROUND WATER SOURCE OPTIONS (system not subject to Part 6)
Community systems serving water to the public before January 1, 1991	<ul style="list-style-type: none"> <li>• Provide filtration and disinfection;</li> <li>• Remain unfiltered, meet all criteria to remain unfiltered, and provide disinfection; or</li> <li>• Purchase from a system using a surface or GWI source.</li> </ul>	Existing systems may abandon surface or GWI sources and develop alternate department-approved ground water sources.
All other Group A systems using surface or GWI sources	<ul style="list-style-type: none"> <li>• Provide filtration and disinfection; or</li> <li>• Purchase completely treated surface water or GWI water from an approved public water system.</li> </ul>	Existing systems which develop ground water sources or purchase ground water from a department-approved public water system shall not be subject to the requirements of Part 6, once the alternate source is approved by the department and is on-line.

[Statutory Authority: RCW 43.20.050. 93-08-011 (Order 352B), § 246-290-630, filed 3/25/93, effective 4/25/93.]

**WAC 246-290-632 Treatment technique violations.** (1) A treatment technique violation shall be considered a violation of a primary drinking water standard and in the



case of an unfiltered system, may result in the purveyor of an unfiltered system being required to install filtration.

(2) A treatment technique violation occurs when a system using a surface or GWI source is identified by the department as the source of a waterborne disease outbreak or any of the following occur as applicable:

(a) The purveyor providing filtration fails to meet one or more of the following requirements on June 29, 1993, or thereafter:

(i) Filtration treatment in accordance with WAC 246-290-660; or

(ii) Disinfection treatment in accordance with WAC 246-290-662.

(b) The purveyor required to install filtration:

(i) Fails to meet the interim disinfection requirements in accordance with WAC 246-290-672 or as otherwise directed by the department; or

(ii) Fails to install filtration or develop an alternate source by the applicable dates specified in WAC 246-290-670.

(c) The purveyor of an unfiltered surface water or GWI source:

(i) Delivers water with a turbidity level exceeding 5.0 NTU; or

(ii) Fails to meet one or more of the disinfection requirements in accordance with WAC 246-290-692 after the dates specified in WAC 246-290-686.

[Statutory Authority: RCW 43.20.050. 94-14-001, § 246-290-632, filed 6/22/94, effective 7/23/94; 93-08-011 (Order 352B), § 246-290-632, filed 3/25/93, effective 4/25/93.]

**WAC 246-290-634 Follow-up to treatment technique violations.** When a treatment technique violation occurs, the purveyor:

(1) Shall report to the department in accordance with:

(a) WAC 246-290-666 for purveyors providing filtration;

(b) WAC 246-290-674 for purveyors installing filtration; or

(c) WAC 246-290-696 for purveyors not providing filtration;

(2) Shall notify the public in accordance with WAC 246-290-330;

(3) Shall determine the cause of the violation;

(4) Shall take action as directed by the department; and

(5) May be subject to enforcement under WAC 246-290-050.

[Statutory Authority: RCW 43.20.050. 93-08-011 (Order 352B), § 246-290-634, filed 3/25/93, effective 4/25/93.]

**WAC 246-290-636 Determination of disinfectant contact time (T).** (1) The purveyor shall calculate T at peak hourly flow.

(2) For pipelines, the purveyor shall calculate T by dividing the internal volume of the pipe by the peak hourly flow rate through that pipe.

(3) For all other system components used for *Giardia lamblia* cyst and virus inactivation, the purveyor shall use tracer studies or empirical methods to determine T.

(4) The purveyor shall use the T10 value determined by tracer studies or other methods acceptable to the department as T in all CT calculations.

(a) For existing water treatment facilities, the purveyor shall ensure that the T10 value is determined by June 29, 1993; and

(b) For unfiltered systems, the purveyor shall ensure that the T10 value is determined before the purveyor begins conducting the monitoring under WAC 246-290-694 to demonstrate that the system meets the criteria to avoid filtration.

(5) Tracer studies.

(a) The purveyor shall conduct field tracer studies on all system components with configurations (geometry and/or baffling) for which analogous contact times are not documented.

(b) Before conducting tracer studies, the purveyor shall obtain the department's approval of a tracer study plan. The plan shall identify at a minimum:

(i) How the purveyor will conduct the study;

(ii) The tracer material to be used;

(iii) Flow rates to be used; and

(iv) The names, titles, and qualifications of the persons conducting the study.

(c) A professional engineer registered in the state of Washington shall direct the conduct of all tracer studies.

(d) Tracer studies shall be conducted in accordance with good engineering practices using methods acceptable to the department such as those described in the *DOH SWTR Guidance Manual*.

(e) The department may require the purveyor to conduct additional tracer studies when:

(i) Modifications impacting flow distribution or T are made; or

(ii) Increases in flow exceed the conditions of the previous tracer studies.

(6) Empirical methods.

(a) Empirical methods may be used to calculate T10, if the purveyor demonstrates to the department's satisfaction that system components have configurations analogous to components on which tracer studies have been conducted and results have been documented.

(b) The purveyor shall submit to the department for review and approval engineering justification for determining T10 using empirical methods. As-built drawings of system components in their current configurations shall be submitted with the engineering justification.

(c) A professional engineer registered in the state of Washington shall prepare the engineering justification for determining T10 using empirical methods.

[Statutory Authority: RCW 43.20.050. 93-08-011 (Order 352B), § 246-290-636, filed 3/25/93, effective 4/25/93.]

**WAC 246-290-638 Analytical requirements.** (1) The purveyor shall ensure that only qualified persons conduct measurements for pH, temperature, turbidity, and residual disinfectant concentrations. In this section, qualified shall mean:

(a) A person certified under chapter 246-292 WAC;



(b) An analyst, with experience conducting these measurements, from the state public health laboratory or another laboratory certified by the department;

(c) A state or local health agency professional experienced in conducting these measurements.

(2) The purveyor shall ensure that measurements for temperature, turbidity, pH, and residual disinfectant concentration are made in accordance with "standard methods."

(3) The purveyor shall ensure that samples for coliform and HPC analysis are:

(a) Collected and transported in accordance with department-approved methods; and

(b) Submitted to the state public health laboratory or another laboratory certified by the department to conduct such analyses.

(4) Turbidity monitoring.

(a) The purveyor shall equip the system's water treatment facility laboratory with a:

(i) Bench model turbidimeter; and

(ii) Continuous turbidimeter and recorder if required under WAC 246-290-664 or 246-290-694.

(b) The purveyor shall ensure that bench model and continuous turbidimeters are:

(i) Designed to meet the criteria in "standard methods"; and

(ii) Properly operated, calibrated, and maintained at all times in accordance with the manufacturer's recommendations.

(c) The purveyor shall validate continuous turbidity measurements for accuracy as follows:

(i) Calibrate turbidity equipment based upon a primary standard in the expected range of measurements; and

(ii) Verify continuous turbidimeter performance on a weekly basis, not on consecutive days, with grab sample measurements made using a properly calibrated bench model turbidimeter.

(d) When continuous turbidity monitoring equipment fails, the purveyor shall measure turbidity on grab samples collected at least every four hours while the system serves water to the public and the equipment is being repaired or replaced. The purveyor shall have continuous monitoring equipment on-line within five working days of failure.

[Statutory Authority: RCW 43.20.050. 93-08-011 (Order 352B), § 246-290-638, filed 3/25/93, effective 4/25/93.]

**WAC 246-290-639 SWTR records.** (1) Purveyors using surface or GWI sources shall maintain accurate and complete operations records.

(2) Operations records shall include, but not be limited to, the following as applicable:

(a) Results of all monitoring conducted under Part 6 of chapter 246-290 WAC;

(b) Quantity of water produced, plant flow rates, and hours of operation;

(c) Types and quantities of chemicals used;

(d) Dates and information pertaining to filter and/or disinfection system maintenance;

(e) Dates and results of filter and/or disinfection system inspections including records of filtration and backwash rates; and

(f) Dates and descriptions of major equipment and/or treatment process failures and corrective actions taken.

(3) Operations records not reported to the department under WAC 246-290-666 or 246-290-696 shall be maintained at the purveyor's treatment facility.

[Statutory Authority: RCW 43.20.050. 93-08-011 (Order 352B), § 246-290-639, filed 3/25/93, effective 4/25/93.]

#### **WAC 246-290-640 Determination of GWI sources.**

(1) For **Group A** systems, the department shall notify the purveyor when a source has been identified as a potential GWI source. Until the department has made a source determination, the purveyor shall monitor in accordance with the requirements for ground water sources in WAC 246-290-300 or as directed by the department and provide follow-up in accordance with WAC 246-290-320.

(2) The purveyor using a source identified as a potential GWI shall provide to the department all information necessary to determine whether the source is under direct surface water influence. Information shall include but not be limited to:

(a) Site-specific source water quality data;

(b) Documentation of source construction characteristics;

(c) Documentation of hydrogeology;

(d) Distance to surface water; and

(e) Water quality results from nearby surface water(s) if requested by the department.

(3) Based on information provided by the purveyor, the department shall determine which ground water sources are under the direct influence of surface water and notify the purveyor of the source determination.

(4) The purveyor may modify a department-determined GWI source to eliminate direct surface influence. In such cases, the purveyor shall, at a minimum:

(a) Submit a proposed schedule for source modification to the department for review and approval;

(b) Provide disinfection treatment and conduct monitoring and reporting as directed by the department to protect the health of consumers served by the water system until:

(i) Modification is complete; and

(ii) The department determines the source is no longer subject to direct surface influence.

(c) Comply with subsection (2) of this section upon completion of source modifications to be considered for source reclassification.

(5) The department may reevaluate a ground water source for direct surface influence, if conditions impacting source classification have changed.

[Statutory Authority: RCW 43.20.050. 93-08-011 (Order 352B), § 246-290-640, filed 3/25/93, effective 4/25/93.]

#### **Subpart B - Requirements for Filtered Systems**

**WAC 246-290-650 Compliance requirements for filtered systems.** (1) In addition to the requirements of Parts 1 through 5 of chapter 246-290 WAC, Subpart B of Part 6 of chapter 246-290 WAC applies to purveyors of systems using surface or GWI sources and providing filtration, including:

(a) Systems with water treatment facilities which produced water served to the public before January 1, 1991;

(b) Unfiltered systems installing filtration, once the new water treatment facilities are on-line; and

(c) New systems using surface or GWI sources. For the purpose of the Part 6 chapter 246-290 WAC requirements, new systems are defined as systems first serving water to the public after December 31, 1990.

(2) The purveyor shall be subject to the effective dates, compliance requirements and violations specified in Table 9.

(3) The purveyor of a new system using a surface or GWI source shall comply with the requirements of Part 6 subparts A and B chapter 246-290 WAC and be subject to the treatment technique violations specified in WAC 246-290-632 beginning when the system first serves water to the public and thereafter.

**Table 9**  
PART 6 COMPLIANCE REQUIREMENTS FOR SYSTEMS WITH EXISTING WATER TREATMENT FACILITIES

REQUIREMENTS EFFECTIVE FROM	APPLICABLE PART 6 REQUIREMENTS	VIOLATION TYPE	
		Turbidity MCL	Treatment Technique
Date specified in written department notification through June 28, 1993	Subpart A Analytical, Subpart B Monitoring and Reporting requirements only	Still in effect	Not in effect yet
June 29, 1993 and thereafter	Subparts A and B	No longer in effect	In effect

[Statutory Authority: RCW 43.20.050. 93-08-011 (Order 352B), § 246-290-650, filed 3/25/93, effective 4/25/93.]

**WAC 246-290-652 Filtration technology and design criteria for existing filtered systems.** (1) The purveyor shall treat all surface and GWI sources using one of the following filtration technologies unless another technology is acceptable to the department:

- (a) Conventional;
- (b) Direct;
- (c) Diatomaceous earth; or
- (d) Slow sand.

(2) Purveyors not using one of the filtration technologies in subsection (1) of this section or not complying with the design criteria specified in WAC 246-290-676 shall submit a project report to the department which demonstrate's to the department's satisfaction that the existing water treatment facility can be operated to reliably produce, by June 29, 1993, water meeting the operating and performance requirements of WAC 246-290-654 and 246-290-660, respectively. The project report shall comply with the requirements of WAC 246-290-110.

(3) The purveyor shall make the demonstration required under subsection (2) of this section using the latest twelve months of operating data, results of special studies conducted to test the performance of the water treatment facility under adverse water quality conditions or other means acceptable to the department.

(4) For water treatment facilities currently unable to meet the performance and operation requirements, the project report shall specify the modifications needed to upgrade the facility. Purveyors upgrading existing water treatment facilities shall comply with the design and reliability requirements under WAC 246-290-676 and 246-290-678, respectively.

(5) The purveyor of a new system using a surface or GWI source shall be subject to the:

(a) Design and reliability requirements under WAC 246-290-676 and 246-290-678, respectively; and

(b) Operating criteria for new water treatment facilities under WAC 246-290-680.

[Statutory Authority: RCW 43.20.050. 93-08-011 (Order 352B), § 246-290-652, filed 3/25/93, effective 4/25/93.]

**WAC 246-290-654 Treatment criteria for filtered systems.** (1) The purveyor shall operate filters such that maximum flow rates do not exceed those specified in Table 10. The purveyor may operate filters at higher flow rates, if the purveyor demonstrates to the department's satisfaction that filtration at the higher rate consistently achieves at least 99 percent (2 log) removal of *Giardia lamblia* cysts and meets the turbidity performance requirements of Table 11.

**Table 10**  
FILTRATION OPERATION CRITERIA

FILTRATION TECHNOLOGY/MEDIA	MAXIMUM FILTRATION RATE (gpm/ft <sup>2</sup> )
Conventional, Direct and In-Line	
Gravity Filters with Single Media	3
Gravity Filters with Deep Bed, Dual or Mixed Media	6
Pressure Filters with Single Media	2
Pressure Filters with Deep Bed, Dual or Mixed Media	3
Slow Sand	0.1
Diatomaceous Earth	1.0

(2) The purveyor using conventional, direct or in-line filtration shall ensure that effective coagulation is in use at all times the water treatment facility produces water served to the public.

(3) The purveyor using conventional, direct, or in-line filtration shall demonstrate treatment effectiveness for *Giardia lamblia* cyst removal by one of the following methods:

(a) Turbidity reduction method where source and filtered water turbidity measurements are made in accordance with WAC 246-290-664(2) and (3) respectively:

(i) When source turbidity is greater than or equal to 2.5 NTU, the purveyor shall achieve the turbidity performance requirements specified in WAC 246-290-660(1);

(ii) When source turbidity is less than 2.5 NTU, the purveyor shall achieve:

(A) An 80% reduction in source turbidity based on an average of the daily turbidity reductions measured in a calendar month; or

(B) A filtered water turbidity less than or equal to 0.1 NTU;

(b) Particle counting method. The purveyor shall:

(i) Use a particle counting protocol acceptable to the department; and

(ii) Demonstrate at a frequency acceptable to the department at least the following log reduction of *Giardia lamblia* cyst-sized particles as applicable;

(A) 2.5 log reduction for systems using conventional filtration;

(B) 2.0 log reduction for systems using direct or in-line filtration;

(c) Microscopic particulate analysis method. The purveyor shall:

(i) Use a protocol acceptable to the department; and

(ii) Demonstrate at a frequency acceptable to the department at least the following log reduction of *Giardia lamblia* cysts and/or *Giardia lamblia* cyst surrogate indicators as applicable;

(A) 2.5 log reduction for systems using conventional filtration; and

(B) 2.0 log reduction for systems using direct or in-line filtration.

(d) Other methods acceptable to the department.

(4) The purveyor shall ensure continuous disinfection of all water delivered to the public and shall:

(a) Maintain an adequate supply of disinfection chemicals and keep back-up system components and spare parts on hand;

(b) Develop, maintain, and post at the water treatment facility a plan detailing:

(i) How water delivered to the public will be continuously and adequately disinfected; and

(ii) The elements of an emergency notification plan to be implemented whenever the residual disinfectant concentration at entry to distribution falls below 0.2 mg/L for more than one hour.

(c) Implement such plan during an emergency affecting disinfection.

(5) Operations plan.

(a) For each water treatment facility treating a surface or GWI source, the purveyor shall develop an operations plan and make it available to the department for review upon request.

(b) The plan shall be submitted to the department as an addendum to the purveyor's water system plan (WAC 246-290-100) or small water system management program (WAC 246-290-410).

(c) The plan shall detail how the purveyor will produce optimal filtered water quality at all times the water treatment facility produces water to be served to the public.

(d) The purveyor shall operate the water treatment facility in accordance with the operations plan.

(e) The operations plan shall include, but not be limited to, a description of:

(i) For conventional, direct or in-line filtration, procedures used to determine and maintain optimized coagulation as demonstrated by meeting the requirements of WAC 246-290-654(3);

(ii) Procedures used to determine chemical dose rates;

(iii) How and when each unit process is operated;

(iv) Unit process equipment maintenance program;

(v) Treatment plant performance monitoring program;

(vi) Laboratory procedures;

(vii) Records;

(viii) Reliability features; and

(ix) Response plans for water treatment facility emergencies, including disinfection failure and watershed emergencies.

(f) The purveyor shall ensure the operations plan is:

(i) Readily available at the water treatment facility for use by operators and for department inspection;

(ii) Consistent with department guidelines for operations procedures such as those described in the *DOH SWTR Guidance Manual* and *Planning Handbook*; and

(iii) Updated as needed to reflect current water treatment facility operations.

(6) Pressure filters. Purveyors using pressure filters shall:

(a) Inspect and evaluate the filters, at least every six months, for conditions that would reduce their effectiveness in removing *Giardia lamblia* cysts;

(b) Maintain, and make available for department review, a written record of pressure filter inspections; and

(c) Be prepared to conduct filter inspections in the presence of a department representative, if requested.

[Statutory Authority: RCW 43.20.050. 94-14-001, § 246-290-654, filed 6/22/94, effective 7/23/94; 93-08-011 (Order 352B), § 246-290-654, filed 3/25/93, effective 4/25/93.]

**WAC 246-290-660 Filtration.** (1) Turbidity performance requirements.

(a) The purveyor shall ensure that the turbidity level of representative filtered water samples:

(i) Complies with the performance standards in Table 11; and

(ii) Never exceeds 5.0 NTU.

**Table 11  
TURBIDITY PERFORMANCE REQUIREMENTS**

Filtration Technology	Filtered water turbidity (in NTUs) shall be less than or equal to this value in at least 95% of the measurements made each calendar month
Conventional, Direct and In-line	0.5
Slow Sand	1.0
Diatomaceous Earth	1.0
Alternate Technology	1.0

(b) The department may allow the turbidity of filtered water from a system using slow sand filtration to exceed 1.0 NTU, but never 5.0 NTU, if the system demonstrates to the department's satisfaction that the higher turbidity level will not endanger the health of consumers served by the system. As a condition of being allowed to produce filtered water with a turbidity exceeding 1.0 NTU, the purveyor may be required to monitor one or more parameters in addition to the parameters specified under WAC 246-290-664. The Department shall notify the purveyor of the type and frequency of monitoring to be conducted.

(2) *Giardia lamblia* and virus removal credit.

(a) The purveyor shall notify the purveyor of the removal credit granted for the system's filtration process. The department shall specify removal credit for:

(i) Existing filtration facilities based on periodic evaluations of performance and operation; and

(ii) New or modified filtration facilities based on results of pilot plant studies or full scale operation.

(b) Conventional, direct, and in-line filtration.

(i) The removal credit the department may grant to a system using conventional, direct, or in-line filtration and demonstrating effective treatment is as follows:

Filtration Technology	Percent Removal Credit (log)	
	<i>Giardia</i>	Virus
Conventional	99.7 (2.5)	99 (2.0)
Direct and in-line	99 (2.0)	90 (1.0)

(ii) A system using conventional, direct, or in-line filtration shall be considered to provide effective treatment, if the purveyor demonstrates to the satisfaction of the department that the system meets the:

(A) Turbidity performance requirements under subsection (1) of this section; and

(B) Operations requirements of WAC 246-290-654.

(iii) The department may grant a higher level of *Giardia lamblia* and virus removal credit than listed under (b)(i) of this subsection, if the purveyor demonstrates to the department's satisfaction that the higher level can be consistently achieved.

(iv) As a condition of maintaining the maximum removal credit, purveyors may be required to periodically monitor one or more parameters not routinely monitored under WAC 246-290-664. The department shall notify the purveyor of the type and frequency of monitoring to be conducted.

(v) The department shall not grant removal credit to a system using conventional, direct, or in-line filtration which:

(A) Fails to meet the minimum turbidity performance requirements under subsection (1) of this section;

(B) Fails to meet the operating requirements under WAC 246-290-654.

(c) Slow sand filtration.

The department may grant a system using slow sand filtration 99 percent (2 log) *Giardia lamblia* cyst removal credit and 99 percent (2 log) virus removal credit, if the system meets the department design requirements under WAC 246-290-676 and meets the minimum turbidity performance requirements in subsection (1) of this section.

(d) Diatomaceous earth filtration.

The department may grant a system using diatomaceous earth filtration 99 percent (2 log) *Giardia lamblia* cyst removal credit and 90 percent (1 log) virus removal credit, if the system meets the department design requirements under WAC 246-290-676 and meets the minimum turbidity performance requirements in subsection (1) of this section.

(e) Alternate filtration technology.

The department shall grant, on a case-by-case basis, *Giardia lamblia* cyst and virus removal credit for systems using alternate filtration technology based on results of product testing acceptable to the department.

(f) The purveyor granted no removal credit shall:

(i) Provide treatment in accordance with WAC 246-290-662 (2)(e); and

(ii) Within ninety days of department notification regarding removal credit, submit an action plan to the department for review and approval. The plan shall:

(A) Detail how the purveyor plans to comply with the turbidity performance requirements in subsection (1) of this section and operating requirements of WAC 246-290-654; and

(B) Identify the proposed schedule for implementation.

[Statutory Authority: RCW 43.20.050, 94-14-001, § 246-290-660, filed 6/22/94, effective 7/23/94; 93-08-011 (Order 352B), § 246-290-660, filed 3/25/93, effective 4/25/93.]

#### **WAC 246-290-662 Disinfection for filtered systems.**

(1) General requirements.

(a) The purveyor shall provide continuous disinfection to ensure that filtration and disinfection together achieve, at all times the system serves water to the public, at least the following:

(i) 99.9 percent (3 log) inactivation and removal of *Giardia lamblia* cysts; and

(ii) 99.99 percent (4 log) inactivation and/or removal of viruses.

(b) Where sources receive sewage discharges and/or agricultural runoff, purveyors may be required to provide greater levels of removal and inactivation of *Giardia lamblia* cysts and viruses to protect the health of consumers served by the system.

(c) Regardless of the removal credit granted for filtration, purveyors shall, at a minimum, provide continuous disinfection to achieve at least 68 percent (0.5 log) inactivation of *Giardia lamblia* cysts and 99 percent (2 log) inactivation of viruses.

(2) Establishing the level of inactivation.

(a) The department shall establish the level of disinfection (log inactivation) to be provided by the purveyor.

(b) The required level of inactivation shall be based on source quality and expected levels of *Giardia lamblia* cyst and virus removal achieved by the system's filtration process.

(c) Based on period review, the department may adjust, as necessary, the level of disinfection the purveyor shall provide to protect the health of consumers served by the system.

(d) The purveyor using alternate filtration technology shall ensure that disinfection achieves at least the following at all times water is served to the public:

(i) 90 percent (1 log) inactivation of *Giardia lamblia* cysts when granted 99 percent (2 log) *Giardia lamblia* cyst removal credit, or 99.9 percent (3 log) inactivation of cysts when granted less than 99 percent (2 log) *Giardia lamblia* cyst removal credit; and

(ii) 99.9 percent (3 log) inactivation of viruses when granted 90 percent (1 log) virus removal credit, or 99.99 percent (4 log) inactivation of viruses when granted no virus removal credit.

(e) Systems granted no *Giardia lamblia* cyst removal credit.

(i) Unless directed otherwise by the department, the purveyor of a system granted no *Giardia lamblia* cyst removal credit shall provide interim disinfection:

(A) To ensure compliance with the monthly coliform MCL under WAC 246-290-310;

(B) Achieve at least 99.9 percent (3 log) inactivation of *Giardia lamblia* cysts; and

(C) Maintain a detectable residual disinfectant concentration, or an HPC level less than 500/ml, within the distribution system in accordance with subsection (6) of this section.

(ii) The purveyor shall comply with the interim disinfection requirements until the system can demonstrate to the department's satisfaction that it complies with the operating requirements and turbidity performance requirements under WAC 246-290-654 and 246-290-660(1), respectively.

(3) Determining the level of inactivation.

(a) Unless the department has approved a reduced CT monitoring schedule for the system, each day the system serves water to the public, the purveyor, using procedures and CT values acceptable to the department such as those

presented in the *DOH SWTR Guidance Manual*, shall determine:

(i) CTcalc values using the system's treatment parameters and calculate the total inactivation ratio achieved by disinfection; and

(ii) Whether the system's disinfection process is achieving the minimum levels of inactivation of *Giardia lamblia* cysts and viruses required by the department.

(b) The department may allow a purveyor to determine the level of inactivation using lower CT values than those specified in (a) of this subsection, provided the purveyor demonstrates to the department's satisfaction that the required levels of inactivation of *Giardia lamblia* cysts and viruses can be achieved.

(4) Determining compliance with the required level of inactivation.

(a) A purveyor shall be considered in compliance with the inactivation requirement when a total inactivation ratio equal to or greater than 1.0 is achieved.

(b) Failure to provide the required level of inactivation on more than one day in any calendar month shall be considered a treatment technique violation.

(5) Residual disinfectant concentration entering the distribution system.

(a) The purveyor shall ensure that all water entering the distribution system contains a residual disinfectant concentration, measured as free or combined chlorine, of at least 0.2 mg/L at all times the system serves water to the public; and

(b) Failure to provide a 0.2 mg/L residual at entry to distribution for more than four hours on any day shall be considered a treatment technique violation.

(6) Residual disinfectant concentration within the distribution system.

(a) The purveyor shall ensure that the residual disinfectant concentration in the distribution system, measured as total chlorine, free chlorine, combined chlorine, or chlorine dioxide, is detectable in at least 95 percent of the samples taken each calendar month.

(b) Water in the distribution system with an HPC less than or equal to 500/ml is considered to have a detectable residual disinfectant concentration.

[Statutory Authority: RCW 43.20.050, 94-14-001, § 246-290-662, filed 6/22/94, effective 7/23/94; 93-08-011 (Order 352B), § 246-290-662, filed 3/25/93, effective 4/25/93.]

#### **WAC 246-290-664 Monitoring for filtered systems.**

(1) Source coliform monitoring.

(a) The purveyor shall ensure that source water samples of each surface or GWI source are:

(i) Collected before the first point of disinfectant application and before coagulant chemical addition; and

(ii) Analyzed for fecal coliform density in accordance with methods acceptable to the department.

(b) At a minimum, the purveyor shall ensure source samples are collected for fecal coliform analysis at a frequency equal to 10 percent of the number of routine coliform samples collected within the distribution system each month under WAC 246-290-300, or once per calendar month, whichever is greater up to a maximum of one sample per day.

(2) Source turbidity monitoring.

(a) The purveyor using conventional, direct, or in-line filtration shall measure source turbidity at least once per day on a representative sample collected before disinfection and coagulant addition.

(b) Grab sampling or continuous turbidity monitoring and recording may be used to meet the requirement specified in (a) of this subsection.

(c) Purveyors using continuous turbidity monitoring shall record continuous turbidity measurements at equal intervals, at least every four hours, in accordance with a department-approved sampling schedule.

(3) Filtered water turbidity monitoring.

(a) The purveyor shall:

(i) Continuously monitor turbidity on representative samples of the system's combined filter effluent, prior to clearwell storage;

(ii) Record continuous turbidity measurements at equal intervals, at least every four hours, in accordance with a department-approved sampling schedule; and

(iii) Conduct monitoring in accordance with the analytical techniques under WAC 246-290-638.

(b) Purveyors using slow sand filtration or an alternate filtration technology may reduce filtered water turbidity monitoring to one grab sample per day with departmental approval. Reduced turbidity monitoring shall be allowed only where the purveyor demonstrates to the department's satisfaction that a reduction in monitoring will not endanger the health of consumers served by the water system.

(4) Monitoring the level of inactivation and removal.

(a) Each day the system is in operation, the purveyor shall determine the total level of inactivation and removal of *Giardia lamblia* cysts and viruses achieved.

(b) The purveyor shall determine the total level of inactivation and removal based on:

(i) *Giardia lamblia* cyst and virus removal credit granted by the department for filtration; and

(ii) Level of inactivation of *Giardia lamblia* cysts and viruses achieved through disinfection.

(c) At least once per day, purveyors shall monitor the following to determine the level of inactivation achieved through disinfection:

(i) Temperature of the disinfected water at each residual disinfectant concentration sampling point used for CT calculations; and

(ii) If using chlorine, pH of the disinfected water at each chlorine residual disinfectant concentration sampling point used for CT calculations.

(d) Each day during peak hourly flow (based on historical information), the purveyor shall:

(i) Determine disinfectant contact time, T, to the point at which C is measured; and

(ii) Measure the residual disinfectant concentration, C, of the water at the point for which T is calculated. The C measurement point shall be located before or at the first customer.

(e) The department may reduce CT monitoring requirements for purveyors which demonstrate to the department's satisfaction that the required levels of inactivation are consistently exceeded. Reduced CT monitoring shall only be allowed where the purveyor demonstrates to the department's satisfaction that a reduction in monitoring will not endanger the health of consumers.

(5) Monitoring the residual disinfectant concentration entering the distribution system.

(a) Systems serving more than thirty-three hundred (>3300) people per month.

(i) The purveyor shall continuously monitor and record the residual disinfectant concentration of water entering the distribution system and report the lowest value each day.

(ii) If the continuous monitoring equipment fails, the purveyor shall measure the residual disinfectant concentration on grab samples collected at least every four hours at the entry to the distribution system while the equipment is being repaired or replaced. The purveyor shall have continuous monitoring equipment back on-line within five working days following failure.

(b) Systems serving thirty-three hundred or less (< 3300) people per month.

(i) The purveyor shall collect grab samples or use continuous monitoring and recording to measure the residual disinfectant concentration entering the distribution system.

(ii) Purveyors of **community** systems choosing to take grab samples shall collect:

(A) Samples at the following minimum frequencies:

<u>Population Served</u>	<u>Number/day</u>
25 - 500	1
501 - 1,000	2
1,001 - 2,500	3
2,501 - 3,300	4

(B) At least one of the grab samples at peak hourly flow; and

(C) The remaining samples evenly spaced over the time the system is disinfecting water that will be delivered to the public.

(iii) Purveyors of **noncommunity** systems choosing to take grab samples shall collect samples for disinfectant residual concentration entering the distribution system as directed by the department.

(iv) When grab samples are collected and the residual disinfectant concentration at the entry to distribution falls below 0.2 mg/L, purveyors shall collect a grab sample every four hours until the residual disinfectant concentration is 0.2 mg/L or more.

(6) Monitoring residual disinfectant concentrations within the distribution system.

(a) The purveyor shall measure the residual disinfectant concentration at representative points within the distribution system on a daily basis or as otherwise approved by the department.

(b) At a minimum, the purveyor shall measure the residual disinfectant concentration within the distribution system at the same time and location that a routine or repeat coliform sample is collected in accordance with WAC 246-290-300(2) or 246-290-320(2).

(c) The purveyor may measure HPC within the distribution system in lieu of measuring the residual disinfectant concentration in accordance with this subsection.

[Statutory Authority: RCW 43.20.050, 94-14-001, § 246-290-664, filed 6/22/94, effective 7/23/94; 93-08-011 (Order 352B), § 246-290-664, filed 3/25/93, effective 4/25/93.]

#### **WAC 246-290-666 Reporting for filtered systems.**

(1) The purveyor shall notify the department, as soon as

(1997 Ed.)

possible, but no later than the end of the next business day, when:

(a) A waterborne disease outbreak potentially attributable to the water system occurs;

(b) The turbidity of the combined filter effluent exceeds 5.0 NTU at any time;

(c) The residual disinfection concentration falls below 0.2 mg/L at the entry point to the distribution system. The purveyor shall also report whether the residual was restored to 0.2 mg/L or more within four hours; or

(d) An event occurs which may affect the ability of the water treatment facility to produce drinking water which complies with this chapter including, but not limited to:

(i) Spills of hazardous materials in the watershed; and

(ii) Treatment process failures.

(2) The purveyor shall report results of monitoring conducted in accordance with WAC 246-290-664 to the department. Monthly report forms shall be submitted within ten days after the end of each month the system served water to the public.

(3) The purveyor shall report, at a minimum, all the information requested by the department using a department-approved form or format including:

(a) Water treatment facility operations information;

(b) Turbidity monitoring results. Continuous measurements shall be reported at equal intervals, at least every four hours, in accordance with a department-approved schedule;

(c) Disinfection monitoring information including:

(i) Level of inactivation achieved;

(ii) Residual disinfectant concentrations entering the distribution system; and

(iii) Residual disinfectant concentrations within the distribution system.

(d) Total level of removal and inactivation; and

(e) A summary of water quality complaints received from consumers served by the water system.

(4) A person certified under chapter 246-292 WAC shall complete and sign the monthly report forms required in this section.

[Statutory Authority: RCW 43.20.050, 94-14-001, § 246-290-666, filed 6/22/94, effective 7/23/94; 93-08-011 (Order 352B), § 246-290-666, filed 3/25/93, effective 4/25/93.]

**WAC 246-290-668 Watershed control.** (1) The purveyor shall, to the extent possible, exercise surveillance over conditions and activities in the watershed affecting source water quality. The purveyor shall develop and implement a department-approved watershed control program.

(2) The purveyor shall ensure that an evaluation of the watershed is completed at least every six years. Watershed evaluations shall be performed such that results of the survey are included in the purveyor's water system plan in accordance with WAC 246-290-100 or small water system management program in accordance with WAC 246-290-410, whichever is applicable.

(3) A professional engineer registered in the state of Washington shall direct the conduct of the watershed evaluation and develop a watershed evaluation report.

(4) The purveyor shall submit the report to the department within sixty days of completion of the watershed evaluation.

(5) The report shall describe the watershed, characterize the watershed hydrology, and discuss the purveyor's watershed control program. The report shall also describe:

- (a) Conditions/activities in the watershed which are adversely affecting source water quality;
- (b) Changes in the watershed which could adversely affect source water quality that have occurred since the last watershed evaluation;
- (c) The monitoring program the purveyor uses to assess the adequacy of watershed protection including an evaluation of sampling results; and
- (d) Recommendations for improved watershed control.

[Statutory Authority: RCW 43.20.050. 93-08-011 (Order 352B), § 246-290-668, filed 3/25/93, effective 4/25/93.]

**Subpart C - Requirements for Systems Installing Filtration Facilities**

**WAC 246-290-670 Compliance requirements for existing unfiltered systems installing filtration.** (1) The purveyor of an existing unfiltered system shall:

- (a) Install filtration by:
  - (i) June 29, 1993, for systems notified by the department before December 30, 1991, to install filtration; or
  - (ii) Eighteen months after department notification, for systems notified by the department after December 30, 1991, to install filtration.
- (b) Be subject to the effective dates, compliance requirements, and treatment technique violations specified in Table 12.

(2) The purveyor under an enforcement action or compliance agreement which is dated prior to the effective date of Part 6 of chapter 246-290 WAC, shall adhere to the compliance schedule for installation of filtration established in the departmental order or bilateral compliance agreement in lieu of the dates specified in subsection (1) of this section.

**Table 12**

**COMPLIANCE REQUIREMENTS FOR EXISTING UNFILTERED SYSTEMS NOTIFIED BY THE DEPARTMENT TO INSTALL FILTRATION**

EFFECTIVE DATE	APPLICABLE PART 6 REQUIREMENTS	VIOLATION TYPE	
		Turbidity MCL	Treatment Technique
Until June 29, 1993 or until the new water treatment facility produces filtered water served to the public, whichever is later.	Subpart C treatment, monitoring and reporting requirements	Still in effect	As defined in WAC 246-290-632
Beginning June 29, 1993 or when the new water treatment facility first serves filtered water to the public, whichever is later.	Subparts A and B	No longer in effect	As defined in WAC 246-290-632

(3) The purveyor required to install filtration shall submit an action plan and schedule to the department for review and approval. The plan shall:

- (a) Be submitted within ninety days of departmental notification; and
- (b) Document the purveyor's plan and implementation schedule to comply with one of the following:
  - (i) Subparts A and B of Part 6 of chapter 246-290 WAC, if continuing to use the surface or GWI source as a permanent source and installing filtration;
  - (ii) Subparts A and D of Part 6 of chapter 246-290 WAC, if abandoning the surface or GWI source and pur-

chasing completely treated water from a department-approved public water system using surface or GWI water; or  
 (iii) All other applicable sections of this chapter, if abandoning the surface or GWI source and developing an alternate department-approved ground water source.

(4) Between written departmental notification of the filtration requirement and installation of filtration, the purveyor shall meet:

- (a) The interim disinfection requirements under WAC 246-290-672 or as otherwise directed by the department;
- (b) The interim monitoring and reporting requirements under WAC 246-290-674; and
- (c) All other applicable requirements of this chapter.

(5) The purveyor installing filtration shall ensure that when completed, the final treatment processes, consisting of filtration and disinfection, will comply with the requirements under WAC 246-290-660 and 246-290-662, respectively.

[Statutory Authority: RCW 43.20.050. 94-14-001, § 246-290-670, filed 6/22/94, effective 7/23/94; 93-08-011 (Order 352B), § 246-290-670, filed 3/25/93, effective 4/25/93.]

**WAC 246-290-672 Interim treatment requirements.**

(1) Purveyors of existing unfiltered systems installing filtration shall provide interim disinfection treatment to:

- (a) Ensure compliance with the monthly coliform MCL under WAC 246-290-310;
- (b) Achieve at least 99 percent (2 log) inactivation of *Giardia lamblia* cysts on a daily basis each month the system serves water to the public unless otherwise directed by the department; and
- (c) Maintain a detectable residual disinfectant concentration in the distribution system, measured as total chlorine, free chlorine, or combined chlorine in 95 percent or more of the samples taken each calendar month. Water in the distribution system with an HPC level less than or equal to 500/ml is considered to have a detectable residual disinfectant concentration.

(2) Failure to provide the required level of inactivation in subsection (1)(b) of this section on more than one day in any calendar month shall be considered a treatment technique violation.

(3) The department may require the purveyor to provide higher levels of treatment than specified in subsection (1)(b) of this section when necessary to protect the health of consumers served by the public water system.

(4) Interim treatment requirements shall be met in accordance with a schedule acceptable to the department.

[Statutory Authority: RCW 43.20.050. 93-08-011 (Order 352B), § 246-290-672, filed 3/25/93, effective 4/25/93.]

**WAC 246-290-674 Interim monitoring and reporting.** (1) Monitoring. Unless directed otherwise by the department, the purveyor of an existing unfiltered system installing filtration shall:

- (a) Conduct interim monitoring in accordance with WAC 246-290-300 and 246-290-320; and
  - (b) Measure the residual disinfectant concentration within the distribution system at the same time and location that a routine or repeat sample is collected in accordance with WAC 246-290-300(2) or 246-290-320(2).
- (2) Reporting.



(a) The purveyor installing filtration shall report to the department as soon as possible, but no later than the end of the next business day, when:

- (i) A waterborne disease outbreak potentially attributable to the water system occurs;
- (ii) The turbidity of water delivered to the public exceeds 5.0 NTU; or
- (iii) The interim disinfection requirements under WAC 246-290-672 are not met.

(b) The purveyor shall report results of monitoring to the department. Monthly report forms shall be submitted within ten days after the end of each month the system served water to the public.

(c) The purveyor shall report, at a minimum, all the information requested by the department using a department-approved form or format including:

- (i) Water quality information, including results of monitoring in accordance with WAC 246-290-300 and 246-290-320;
- (ii) Disinfection monitoring information;
- (iii) A summary of water quality complaints received from consumers served by the system.

[Statutory Authority: RCW 43.20.050. 93-08-011 (Order 352B), § 246-290-674, filed 3/25/93, effective 4/25/93.]

**WAC 246-290-676 Filtration technology and design criteria.** (1) General.

(a) The purveyor proposing to construct new water treatment facilities or to make additions to existing water treatment facilities for surface and GWI sources shall ensure that the facilities comply with the treatment, design, and reliability requirements of Part 6 of chapter 246-290 WAC.

(b) The purveyor shall submit an engineering report to the department describing how the treatment facilities will be designed to comply with the requirements specified in Subparts A, B, and C of Part 6 of chapter 246-290 WAC.

(2) Filtration technology.

(a) The purveyor shall select a filtration technology acceptable to the department using criteria such as those outlined in the *DOH SWTR Guidance Manual*. The following filtration technologies are considered acceptable:

- (i) Conventional;
- (ii) Direct;
- (iii) Diatomaceous earth; and
- (iv) Slow sand.

(b) In addition to the technologies specified in subsection (1) of this section, alternate filtration technologies may be acceptable, if the purveyor demonstrates to the department's satisfaction all of the following:

(i) Through acceptable third party testing, that system components do not leach or otherwise add substances to the finished water that would violate drinking water standards or food and drug administration regulations, or otherwise pose a threat to public health;

(ii) The technology's effectiveness in achieving at least 99 percent (2 log) removal of *Giardia lamblia* cysts or cyst surrogate particles. On a case-by-case basis, the department may allow, with adequate engineering justification, installation of an alternate filtration technology which achieves less than 99 percent (2 log) removal. Alternate technologies which achieve less than 1.5 log removal shall be considered

unacceptable. The purveyor shall demonstrate the technology's removal capability through research conducted:

- (A) By a party acceptable to the department; and
  - (B) In accordance with protocol and standards acceptable to the department.
- (iii) Through on-site pilot plant studies or other means, that the filtration technology:
- (A) In combination with disinfection treatment consistently achieves 99.9 percent (3 log) removal and inactivation of *Giardia lamblia* cysts and 99.99 percent (4 log) removal and inactivation of viruses; and
  - (B) Meets the applicable turbidity performance requirements in Table 11.
- (3) Pilot studies.

(a) The purveyor shall ensure pilot studies are conducted for all proposed filtration facilities, except where waived based on engineering justification acceptable to the department.

(b) The purveyor shall obtain department approval for the pilot study plan before the pilot filter is constructed and before the pilot study is undertaken.

(c) The pilot study plan shall identify at a minimum:

- (i) Pilot filter design;
  - (ii) Water quality and operational parameters to be monitored;
  - (iii) Type of data to be collected, frequency of data collection, and length of pilot study; and
  - (iv) Pilot plant operator qualifications.
- (d) The purveyor shall ensure that the pilot study is:
- (i) Conducted to simulate proposed full-scale design conditions;
  - (ii) Conducted over a time period that will demonstrate the effectiveness and reliability of the proposed treatment system during changes in seasonal and climatic conditions; and
  - (iii) Designed and operated in accordance with good engineering practices and that ANSI/NSF standards 60 and 61 are considered.

(e) When the pilot study is complete, the purveyor shall submit a project report to the department for approval in accordance with WAC 246-290-110.

(4) Design criteria.

(a) The purveyor shall ensure that water treatment facilities for surface and GWI sources are designed and constructed in accordance with good engineering practices documented in references such as those identified in WAC 246-290-200.

(b) Filtration facilities.

(i) The purveyor shall ensure that all new filtration facilities and improvements to any existing filtration facilities (excluding disinfection) are designed to achieve at least:

- (A) 99 percent (2 log) removal of *Giardia lamblia* cysts; and
- (B) 90 percent (1 log) removal of viruses.

(ii) The purveyor proposing to use an alternate filtration technology which doesn't meet the requirements of (b)(i)(B) of this subsection shall demonstrate to the department's satisfaction that the potential for viral contamination of the source is low. The purveyor shall base the demonstration on results of a watershed evaluation acceptable to the department.

(iii) The purveyor shall ensure that all new filtration facilities contain provisions for filtering to waste with appropriate measures for backflow prevention.

(c) Disinfection systems.

(i) The purveyor shall ensure that disinfection systems for new filtration facilities using other than alternate filtration technologies and improvements to existing disinfection facilities are designed to achieve at least:

(A) 90 percent (1 log) inactivation of *Giardia lamblia* cysts; and

(B) 99.9 percent (3 log) inactivation of viruses.

(ii) The purveyor proposing to use an alternate filtration technology shall ensure that the disinfection system is designed to comply with the following requirements as applicable:

(A) If the department has rated the filtration technology as capable of achieving at least 99 percent (2 logs) removal of *Giardia lamblia* cysts, the purveyor shall ensure that the disinfection system provides at least 90 percent (1 log) inactivation of *Giardia lamblia* cysts; or

(B) If the department has rated the filtration technology as capable of achieving less than 99 percent (2 logs) removal of *Giardia lamblia* cysts, the purveyor shall ensure that the disinfection system provides at least 99.9 percent (3 logs) inactivation of *Giardia lamblia* cysts; and

(C) If the department has determined the filtration technology is not capable of removing viruses, the purveyor shall ensure that the disinfection system achieves at least 99.99 percent (4 log) inactivation of viruses.

[Statutory Authority: RCW 43.20.050. 93-08-011 (Order 352B), § 246-290-676, filed 3/25/93, effective 4/25/93.]

**WAC 246-290-678 Reliability for filtered systems.**

(1) The purveyor shall ensure that reliability features are included in all water treatment facilities used to treat surface or GWI sources.

(2) Reliability features shall include but not be limited to:

(a) Alarm devices to provide warning of treatment process failures including coagulation, filtration, and disinfection. Alarm devices shall warn individuals responsible for taking corrective action and/or provide for automatic plant shutdown until corrective action can be taken;

(b) Standby replacement equipment available to assure continuous operation and control of coagulation, filtration and disinfection processes;

(c) Multiple filter units which provide redundant capacity when filters are out of service for backwash or maintenance, except where waived based on engineering justification acceptable to the department.

(3) The department may accept alternatives to the requirements specified in subsection (2) of this section, if the purveyor demonstrates to the department's satisfaction that the proposed alternative will assure an equal degree of reliability.

[Statutory Authority: RCW 43.20.050. 93-08-011 (Order 352B), § 246-290-678, filed 3/25/93, effective 4/25/93.]

**WAC 246-290-680 Operating criteria for new water treatment facilities.** (1) The purveyor shall not serve water

produced by a new water treatment facility without departmental approval.

(2) To obtain department approval, the purveyor shall demonstrate to the department's satisfaction compliance with the requirements for filtered systems in Subparts A and B of Part 6 of chapter 246-290 WAC. The purveyor shall make such a demonstration by operating the facility for a department-determined trial period. During the trial period of operation, the purveyor shall, at a minimum, conduct monitoring in accordance with WAC 246-290-664 and as otherwise directed by the department.

[Statutory Authority: RCW 43.20.050. 93-08-011 (Order 352B), § 246-290-680, filed 3/25/93, effective 4/25/93.]

**Subpart D - Requirements for Other Unfiltered Systems**

**WAC 246-290-686 Compliance requirements for unfiltered systems.** (1) The purveyor using an unfiltered surface or GWI source shall comply with:

(a) Subparts A and D of Part 6 of chapter 246-290 WAC; and

(b) All other applicable sections of this chapter.

(2) The purveyor purchasing water from a system using a surface or GWI source shall comply with:

(a) The applicable requirements of Subpart A of Part 6 of chapter 246-290 WAC;

(b) The disinfection, monitoring and reporting requirements under WAC 246-290-692 (5)(b), 246-290-694 (6)(b) and 246-290-696(4) respectively when purchasing completely treated surface or GWI water; or

(c) The treatment technique, monitoring and reporting requirements of Subpart D of Part 6 of chapter 246-290 WAC as directed by the department when purchasing incompletely treated surface or GWI water.

(3) The purveyor shall be subject to the effective dates, compliance requirements, and violations specified in:

(a) Table 13, when using an unfiltered surface source; or

(b) Table 14, when using an unfiltered GWI source.

**Table 13  
COMPLIANCE REQUIREMENTS  
FOR SYSTEMS USING UNFILTERED SURFACE WATER SOURCES**

REQUIREMENTS EFFECTIVE	APPLICABLE PART 6 REQUIREMENTS	VIOLATION TYPE	
		Turbidity MCL	Treatment Technique
From January 1, 1991 through December 29, 1991	Only Analytical, Monitoring and Reporting Requirements (WAC 246-290-638, 246-290-694 and 246-290-696 respectively)	Still in effect	Not in effect yet
Beginning December 30, 1991 and thereafter	Subparts A and D	No longer in effect	In effect as defined in WAC 246-290-632

**Table 14  
COMPLIANCE REQUIREMENTS  
FOR SYSTEMS USING UNFILTERED GWI SOURCES**

REQUIREMENTS BECOME EFFECTIVE	APPLICABLE PART 6 REQUIREMENTS	VIOLATION TYPE	
		Turbidity MCL	Treatment Technique
Six months after GWI determination	Only Analytical, Monitoring and Reporting Requirements (WAC 246-290-638, 246-290-694 and 246-290-696 respectively)	Still in effect	Not in effect yet
Eighteen months after GWI determination	Subparts A and D	No longer in effect	In effect as defined in WAC 246-290-632

(4) Purveyors of **community** systems using surface water sources had the option to remain unfiltered if they demonstrated compliance with the department's criteria to remain unfiltered by December 30, 1991.

(5) A purveyor using a department-determined GWI may remain unfiltered, if within eighteen months of GWI determination, the purveyor complies with Part 6 of chapter 246-290 WAC and in particular source water quality and site-specific conditions under WAC 246-290-690 as demonstrated through monitoring conducted in accordance with WAC 246-290-694.

(6) After the department makes an initial determination that a system may remain unfiltered, the purveyor shall comply with the source water quality and site-specific conditions under WAC 246-290-690 as demonstrated through monitoring conducted in accordance with WAC 246-290-694.

(7) The purveyor shall install filtration when:

(a) The system fails to meet one or more of the source water quality and site-specific conditions under WAC 246-290-690; or

(b) The department determines that installation of filtration is necessary to protect the health of consumers served by the water system.

(8) The department shall provide written notification to the purveyor of:

(a) A filtration requirement; and

(b) An initial determination that the system may remain unfiltered.

(9) The purveyor may comply with the requirements to install filtration by abandoning the surface water or GWI source, and:

(a) Developing an alternate, department-approved ground water source; or

(b) Purchasing completely treated water from a department-approved public water system.

[Statutory Authority: RCW 43.20.050, 94-14-001, § 246-290-686, filed 6/22/94, effective 7/23/94; 93-08-011 (Order 352B), § 246-290-686, filed 3/25/93, effective 4/25/93.]

#### **WAC 246-290-690 Criteria to remain unfiltered.**

(1) For a system to remain unfiltered, the purveyor using a surface water or GWI source shall meet the source water quality and site-specific conditions under this section, as demonstrated through monitoring conducted in accordance with WAC 246-290-694.

(2) Source water quality conditions necessary to remain unfiltered.

(a) Coliform limits.

(i) The purveyor shall ensure that representative source water samples taken before the first point of disinfection have a fecal coliform density less than or equal to 20/100 ml in 90 percent or more of all samples taken during the six previous calendar months the system served water to the public. Samples collected on days when source water turbidity exceeds 1.0 NTU shall be included when determining compliance with this requirement.

(ii) The purveyor shall submit a written report to the department if no source fecal coliform data has been submitted for days when source turbidity exceeded 1.0 NTU. The report shall document why sample results are not available

and shall be submitted with the routine monitoring reports for the month in which the sample results are not available.

(b) Turbidity limits.

(i) The purveyor shall ensure that the turbidity level in representative source water samples taken immediately downstream from the intake and before disinfection does not exceed 5.0 NTU.

(ii) A system failing to meet the turbidity requirements in (b)(i) of this subsection may remain unfiltered, if:

(A) The purveyor demonstrates to the department's satisfaction that the most recent turbidity event was caused by unusual and unpredictable circumstances; and

(B) Including the most recent turbidity event, there have not been more than:

(I) Two turbidity events in the twelve previous calendar months the system served water to the public; or

(II) Five turbidity events in the one-hundred-twenty previous calendar months the system served water to the public.

(iii) The purveyor of a system experiencing a turbidity event shall submit a written report to the department documenting why the turbidity event(s) occurred. The purveyor shall submit the report with the routine monitoring reports for the month in which the turbidity event(s) occurred.

(iv) The purveyor of a system with alternate, department-approved sources or sufficient treated water storage may avoid a turbidity event by implementing operational adjustments to prevent water with a turbidity exceeding 5.0 NTU from being delivered to consumers.

(v) When an alternate source or treated water storage is used during periods when the turbidity of the surface or GWI source exceeds 5.0 NTU, the purveyor shall not put the surface or GWI source back on-line, until the source water turbidity is 5.0 NTU or less.

(3) Site-specific conditions to remain unfiltered.

(a) Level of inactivation.

(i) The purveyor shall ensure that the *Giardia lamblia* cyst and virus inactivation levels required under WAC 246-290-692(1) are met in at least eleven of the twelve previous calendar months that the system served water to the public.

(ii) A system failing to meet the inactivation requirements during two of the twelve previous calendar months that the system served water to the public may remain unfiltered, if the purveyor demonstrates to the department's satisfaction that at least one of the failures was caused by unusual and unpredictable circumstances.

(iii) To make such a demonstration, the purveyor shall submit to the department a written report documenting the reasons for the failure. The purveyor shall submit the report with the routine monitoring reports for the month in which the failure occurred.

(b) Redundant disinfection components or automatic shut-off.

The purveyor shall ensure that the requirement for redundant disinfection system components or automatic shut-off of water to the distribution system under WAC 246-290-692(3) is met at all times the system serves water to the public.

(c) Disinfectant residual entering the distribution system.

(i) The purveyor shall ensure that the requirement for having a residual entering the distribution system under

WAC 246-290-692(4) is met at all times the system serves water to the public.

(i) A system failing to meet the disinfection requirement under (c)(i) of this subsection may remain unfiltered, if the purveyor demonstrates to the department's satisfaction that the failure was caused by unusual and unpredictable circumstances.

(iii) To make such a demonstration, the purveyor shall submit to the department a written report documenting the reasons for the failure. The purveyor shall submit the report with the routine monitoring reports for the month in which the failure occurred.

(d) Disinfectant residuals within the distribution system.

(i) The purveyor shall ensure that the requirement for maintaining a residual within the distribution system under WAC 246-290-692(5) is met on an ongoing basis.

(ii) A system failing to meet the disinfection requirements under (d)(i) of this subsection may remain unfiltered, if the purveyor demonstrates to the department's satisfaction that the failure was caused by something other than a deficiency in source water treatment.

(iii) To make such a demonstration, the purveyor shall submit to the department a written report documenting the reasons for the failure. The purveyor shall submit the report with the routine monitoring reports for the month in which the failure occurred.

(e) Watershed control.

(i) The purveyor shall develop and implement a department-approved watershed control program.

(ii) The purveyor shall monitor, limit, and control all facilities and activities in the watershed affecting source quality to preclude degradation of the physical, chemical, microbiological (including viral), and radiological quality of the source. The purveyor shall demonstrate, through ownership and/or written agreements acceptable to the department, control of all human activities which may adversely impact source quality.

(iii) A department guideline, titled *DOH SWTR Guidance Manual*, is available to assist purveyors with development and implementation of a watershed control program. At a minimum, the purveyor's watershed control program shall:

(A) Characterize the watershed hydrology and land ownership;

(B) Identify watershed characteristics and activities which may adversely affect source water quality; and

(C) Monitor the occurrence of activities which may adversely affect source water quality.

(iv) If the department determines significant changes have occurred in the watershed, the purveyor shall submit, within ninety days of notification, an updated watershed control program to the department for review and approval.

(v) The department may require an unfiltered system to conduct additional monitoring to demonstrate the adequacy of the watershed control program.

(vi) A purveyor shall be considered out of compliance when failing to:

(A) Have a department-approved watershed control program;

(B) Implement the watershed control program to the satisfaction of the department; or

(C) Conduct additional monitoring as directed by the department.

(vii) The purveyor using a GWI source may use a department-approved wellhead protection program to meet the watershed control program requirements under (e) of this subsection with departmental approval.

(f) On-site inspections.

(i) The department shall conduct on-site inspections to assess watershed control and disinfection treatment.

(ii) The department shall conduct annual inspections unless more frequent inspections are deemed necessary to protect the health of consumers served by the system.

(iii) For a system to remain unfiltered, the on-site inspection shall indicate to the department's satisfaction that the watershed control program and disinfection treatment comply with (e) of this subsection and WAC 246-290-692, respectively.

(iv) The purveyor with unsatisfactory on-site inspection results shall take action as directed by the department in accordance with a department-established schedule.

(g) Waterborne disease outbreak.

(i) To remain unfiltered, a system shall not have been identified by the department as the cause of a waterborne disease outbreak attributable to a failure in treatment of the surface or GWI source.

(ii) The purveyor of a system identified by the department as the cause of a waterborne disease outbreak may remain unfiltered, if the purveyor demonstrates to the department's satisfaction that system facilities and/or operations have been sufficiently modified to prevent another waterborne disease outbreak.

(h) Total coliform MCL.

(i) For a system to remain unfiltered, the purveyor shall ensure that the MCL for total coliform under WAC 246-290-310 is met in at least eleven of the twelve previous calendar months the system served water to the public.

(ii) A system failing to meet the criteria in (i) of this subsection, may remain unfiltered, if the purveyor demonstrates to the department's satisfaction that the total coliform MCL violations were not caused by a deficiency in source water treatment.

(iii) The department shall determine the adequacy of source water treatment based on results of total coliform monitoring at the entry to the distribution system in accordance with WAC 246-290-694(2).

(i) THM MCL and monitoring.

For a system to remain unfiltered, the purveyor shall comply with the THM monitoring and MCL requirements under WAC 246-290-300 and 246-290-310, respectively.

(j) Laboratory services.

(i) For a system to remain unfiltered, the purveyor shall retain the services of the public health laboratory or another laboratory certified by the department to analyze samples for total and fecal coliform. Laboratory services shall be available on an as needed basis, seven days a week, including holidays. The purveyor shall identify in the annual comprehensive report required under WAC 246-290-696 the certified laboratory providing these services.

(ii) The department may waive this requirement, if the purveyor demonstrates to the department's satisfaction that an alternate, department-approved source is used when the turbidity of the surface or GWI source exceeds 1.0 NTU.

[Statutory Authority: RCW 43.20.050, 93-08-011 (Order 352B), § 246-290-690, filed 3/25/93, effective 4/25/93.]

**WAC 246-290-692 Disinfection for unfiltered systems.** (1) General requirements.

(a) The purveyor shall provide continuous disinfection treatment to ensure at least 99.9 percent (3 log) inactivation of *Giardia lamblia* cysts and 99.99 percent (4 log) inactivation of viruses at all times the system serves water to the public.

(b) The department may require the purveyor to provide greater levels of inactivation of *Giardia lamblia* cysts and viruses to protect the health of consumers.

(c) Failure to provide the required inactivation level on more than one day in any calendar month the system serves water to the public shall be considered a violation.

(2) Determining the level of inactivation.

(a) Each day the system serves water to the public, the purveyor, using procedures and  $CT_{99.9}$  values specified in 40 CFR 141.74, Vol. 54, No. 124, published June 29, 1989, copies of which are available from the department, shall determine:

(i) CT values using the system's treatment parameters and calculate the total inactivation ratio achieved by disinfection; and

(ii) Whether the system's disinfection treatment process is achieving the minimum levels of inactivation of *Giardia lamblia* cysts and viruses required by the department. For purposes of determining compliance with the inactivation requirements specified in subsection (1) of this section, no credit shall be granted for disinfection applied to a source water with a turbidity greater than 5.0 NTU.

(b) The purveyor shall be considered in compliance with the daily inactivation requirement when a total inactivation ratio equal to or greater than 1.0 is achieved.

(c) The purveyor of a system using a disinfectant other than chlorine may use CT values lower than those specified in (a) of this subsection, if the purveyor demonstrates to the department's satisfaction that the required levels of inactivation of *Giardia lamblia* cysts and viruses can be achieved using the lower CT values.

(d) The purveyor of a system using preformed chloramines or adding ammonia to the water before chlorine shall demonstrate to the department's satisfaction that the system achieves at least 99.99 percent (4 log) inactivation of viruses.

(3) The purveyor shall ensure that disinfection facilities provide either:

(a) Redundant components, including an auxiliary power supply with automatic start-up and alarm, to ensure continuous disinfection. Redundancy shall ensure that both the minimum inactivation requirements and the requirement for a 0.2 mg/L residual disinfectant concentration at entry to the distribution system are met at all times water is delivered to the distribution system; or

(b) Automatic shut-off of delivery of water to the distribution system when the residual disinfectant concentration in the water is less than 0.2 mg/L. Automatic shut-off shall be allowed only in systems where the purveyor demonstrates to the department's satisfaction that automatic shutoff will not endanger health or interfere with fire protection.

(4) Disinfectant residual entering the distribution system.

(a) The purveyor shall ensure that water entering the distribution system contains a residual disinfectant concentration, measured as free or combined chlorine, of at least 0.2 mg/L at all times the system serves water to the public; and

(b) Failure to provide a 0.2 mg/L residual at entry to distribution for more than four hours on any day shall be considered a treatment technique violation.

(5) Disinfectant residuals within the distribution system.

(a) The purveyor shall ensure that the residual disinfectant concentration in the distribution system, measured as total chlorine, free chlorine, combined chlorine, or chlorine dioxide, is detectable in at least 95 percent of the samples taken each calendar month.

(b) The purveyor of a system which purchases completely treated surface or GWI water as determined by the department shall comply with the requirements specified in (a) of this subsection.

(c) Water in the distribution system with an HPC level less than or equal to 500/ml is considered to have a detectable residual disinfectant concentration.

[Statutory Authority: RCW 43.20.050, 94-14-001, § 246-290-692, filed 6/22/94, effective 7/23/94; 93-08-011 (Order 352B), § 246-290-692, filed 3/25/93, effective 4/25/93.]

**WAC 246-290-694 Monitoring for unfiltered systems.** (1) Source coliform monitoring.

(a) The purveyor shall ensure that source water samples of each surface or GWI source are representative and:

(i) Collected before the first point of disinfectant application; and

(ii) Analyzed for fecal coliform density in accordance with methods acceptable to the department.

(b) The purveyor shall ensure source samples are collected for fecal coliform analysis each week the system serves water to the public based on the following schedule:

Population Served	Minimum Number/week*
25 - 500	1
501 - 3,300	2
3,301 - 10,000	3
10,001 - 25,000	4
>25,000	5

\* Must be taken on separate days.

(c) Each day the system serves water to the public and the turbidity of the source water exceeds 1.0 NTU, the purveyor shall ensure one representative source water sample is collected before the first point of disinfectant application and analyzed for fecal coliform density. This sample shall count towards the weekly source coliform sampling requirement.

(d) A purveyor shall not be considered in violation of (c) of this subsection, if the purveyor demonstrates to the department's satisfaction that, for valid logistical reasons outside the purveyor's control, the additional fecal coliform sample could not be analyzed within a timeframe acceptable to the department.

(2) Coliform monitoring at entry to distribution.

(a) The purveyor shall collect and have analyzed one coliform sample at the entry point to the distribution system each day that a routine or repeat coliform sample is collected

within the distribution system under WAC 246-290-300(2) or 246-290-320(2), respectively.

(b) The purveyor shall use the results of the coliform monitoring at entry to distribution along with inactivation ratio monitoring results to demonstrate the adequacy of source treatment.

(3) Source turbidity monitoring.

(a) The purveyor shall continuously monitor and record turbidity:

(i) On representative source water samples before the first point of disinfectant application; and

(ii) In accordance with the analytical techniques under WAC 246-290-638.

(b) If source water turbidity is not the same as the turbidity of water delivered to consumers, the purveyor shall continuously monitor and record turbidity of water delivered.

(4) Monitoring the level of inactivation.

(a) Each day the system is in operation, the purveyor shall determine the total level of inactivation of *Giardia lamblia* cysts and viruses achieved through disinfection.

(b) At least once per day, the purveyor shall monitor the following parameters to determine the total inactivation ratio achieved through disinfection:

(i) Temperature of the disinfected water at each residual disinfectant concentration sampling point used for CT calculations; and

(ii) If using chlorine, pH of the disinfected water at each chlorine residual disinfectant concentration sampling point used for CT calculations.

(c) Each day during peak hourly flow, the purveyor shall:

(i) Determine disinfectant contact time, T, to the point at which C is measured; and

(ii) Measure the residual disinfectant concentration, C, of the water at the point for which T is calculated. The C measurement point must be before or at the first customer.

(5) Monitoring the residual disinfectant concentration entering the distribution system.

(a) Systems serving more than thirty-three hundred (>3300) people.

(i) The purveyor shall continuously monitor and record the residual disinfectant concentration of water entering the distribution system and report the lowest value each day.

(ii) If the continuous monitoring equipment fails, the purveyor shall measure the residual disinfectant concentration on grab samples collected at least every four hours at the entry to the distribution system while the equipment is being repaired or replaced. The purveyor shall have continuous monitoring equipment back on-line within five working days following failure.

(b) Systems serving thirty-three hundred or less ( $\leq 3300$ ) people.

(i) The purveyor shall collect grab samples or use continuous monitoring and recording to measure the residual disinfectant concentration entering the distribution system.

(ii) A purveyor choosing to take grab samples shall collect:

(A) Samples at the following minimum frequencies:

Population Served	Number/day
25 - 500	1
501 - 1,000	2
1,001 - 2,500	3
2,501 - 3,300	4

(B) At least one of the grab samples at peak hourly flow based on historical flows for the system; and

(C) The remaining sample or samples at intervals evenly spaced over the time the system is disinfecting water that will be delivered to the public.

(iii) When grab samples are collected and the residual disinfectant concentration at the entry to distribution falls below 0.2 mg/L, the purveyor shall collect a grab sample every four hours until the residual disinfectant concentration is 0.2 mg/L or more.

(6) Monitoring residual disinfectant concentration within the distribution system.

(a) The purveyor shall measure the residual disinfectant concentration within the distribution system at the same time and location that a routine or repeat coliform sample is collected in accordance with WAC 246-290-300(2) or 246-290-320(2) or once per day, whichever is greater.

(b) The purveyor of a system which purchases completely treated surface or GWI water as determined by the department shall comply with the requirements of (a) of this subsection or as otherwise directed by the department under WAC 246-290-300 (1)(g). At a minimum, the purveyor shall measure the residual disinfectant concentration within the distribution system at the same time and location that a routine or repeat coliform sample is collected in accordance with WAC 246-290-300(2) or 246-290-320(2).

(c) The purveyor may measure HPC within the distribution system in lieu of measuring the residual disinfectant concentration in accordance with this subsection.

[Statutory Authority: RCW 43.20.050. 94-14-001, § 246-290-694, filed 6/22/94, effective 7/23/94; 93-08-011 (Order 352B), § 246-290-694, filed 3/25/93, effective 4/25/93.]

#### **WAC 246-290-696 Reporting for unfiltered systems.**

(1) The purveyor shall report to the department as soon as possible, but no later than the end of the next business day, when:

(a) A waterborne disease outbreak potentially attributable to the water system occurs;

(b) The turbidity of water delivered to the public exceeds 5.0 NTU;

(c) The minimum level of inactivation required by the department is not met;

(d) The residual disinfectant concentration falls below 0.2 mg/L at the entry point to the distribution system. The purveyor shall also report whether the residual was restored to 0.2 mg/L or more within four hours; or

(e) The surface or GWI source is taken off-line due to an emergency.

(2) The purveyor shall report results of monitoring conducted in accordance with WAC 246-290-694 to the department. Monthly report forms shall be submitted within ten days after the end of each month the system served water to the public.

(3) The purveyor shall report, at a minimum, all the information requested by the department using a department-approved form or format including:

(a) Water quality information, including the results of both:

- (i) Source coliform monitoring; and
- (ii) Source turbidity monitoring.
- (b) Disinfection monitoring information, including:
  - (i) Level of inactivation achieved;
  - (ii) Residual disinfectant concentrations entering the distribution system; and
  - (iii) Residual disinfectant concentrations within the distribution system.

(c) A summary of water quality complaints received from consumers served by the water system.

(4) The purveyor of a system which purchases completely treated water shall:

- (a) Report results of distribution system residual disinfectant concentration monitoring to the department using department-approved forms or format; and
- (b) Submit forms to the department in accordance with subsection (2) of this section or as otherwise directed by the department.

(5) A person certified under chapter 246-292 WAC shall complete and sign the monthly report forms required in this section.

(6) Beginning in 1992, by October 10th of each year, the purveyor shall submit to the department an annual comprehensive report which summarizes the:

- (a) Effectiveness of the watershed control program and identifies, at a minimum, the following:
  - (i) Activities in the watershed which are adversely affecting source water quality;
  - (ii) Changes in the watershed that have occurred within the previous year which could adversely affect source water quality;

(iii) Activities expected to occur in the watershed in the future and how the activities will be monitored and controlled;

(iv) The monitoring program the purveyor uses to assess the adequacy of watershed protection including an evaluation of sampling results; and

(v) Special concerns about the watershed and how the concerns are being addressed;

(b) System's compliance with the criteria to remain unfiltered under WAC 246-290-690; and

(c) Significant changes in system design and/or operation which have occurred within the previous year which impact the ability of the system to comply with the criteria to remain unfiltered.

(7) The purveyor of a system attempting to remain unfiltered shall submit a *Filtration Decision Report* at the request of the department. The report shall:

- (a) Provide the information needed by the department to initially determine whether a system meets the criteria to remain unfiltered; and
- (b) Be submitted by the deadline specified by the department.

[Statutory Authority: RCW 43.20.050. 94-14-001, § 246-290-696, filed 6/22/94, effective 7/23/94; 93-08-011 (Order 352B), § 246-290-696, filed 3/25/93, effective 4/25/93.]

**FEES**

**WAC 246-290-990 Water system evaluation and project review and approval fees.** (1) The fees for the review and approval of water system plans, project reports, construction documents, existing systems, and related evaluations required under chapters 246-290, 246-291, 246-293, and 246-295 WAC shall be as follows:

(a) Water system plans required under WAC 246-290-100, 246-293-220, and 246-293-230.

Project Type	Group B	Group A				
		<100 Services	100 to 500 Services	501 to 999 Services	1,000 to 9,999 Services	10,000 or more Services
Water system plan (New and Updated)	105.00	365.00	890.00	1,680.00	2,730.00	4,040.00
Minor water system plan alteration	26.00	89.00	220.00	420.00	680.00	995.00

(b) Satellite management agency (SMA) plans required under WAC 246-295-040.

Project Type	Group B	Group A				
		<100 Services	100 to 500 Services	501 to 999 Services	1,000 to 9,999 Services	10,000 or more Services
SMA plan for ownership (New and Updated)	No plan required	365.00	890.00	1,680.00	2,730.00	4,040.00
SMA approval amendment	No amendment required	78.00 per hour or appropriate fee from category above, whichever is less				
SMA plan for operation only (New and Updated)	No plan required	890.00	890.00	890.00	890.00	890.00

Note: SMAs owning water systems and submitting planning documents to the department for review shall be charged only the SMA fee.



(c) New plan elements required under WAC 246-290-100, 246-290-135, and 246-291-140 including:

- (i) Conservation; and
- (ii) Wellhead protection,

shall be reviewed separately by the department and the fee assessed shall reflect the time spent for this review and shall be calculated based on seventy-eight dollars per hour. After the initial submittal, updated information shall be reviewed as part of the updated water system plan and the review fee shall be included in the applicable updated plan review fee listed under (a) or (b) of this subsection.

(d) Project reports required under WAC 246-290-110.

Project Type	Group B	Group A				
		<100 Services	100 to 500 Services	501 to 999 Services	1,000 to 9,999 Services	10,000 or more Services
All types of filtration or other complex treatment processes	260.00	525.00	815.00	1,180.00	1,625.00	2,155.00
Chemical addition only, such as ion exchange, hypochlorination, or fluoridation	78.00	155.00	260.00	390.00	550.00	735.00
Complete water system (an additional fee shall be assessed for review of treatment facility, if any)	155.00	365.00	575.00	840.00	1,155.00	1,520.00
System modifications requiring a detailed evaluation to determine whether the system, as modified, will comply with regulations (an additional fee shall be assessed for review of treatment facility, if any)	105.00	260.00	420.00	630.00	890.00	1,200.00

(e) Special reports or plans required under WAC 246-290-115, 246-290-230, 246-291-230, 246-290-250, 246-290-470, 246-290-636, 246-290-654, and 246-290-676 including:

- (i) Corrosion control recommendation report;
- (ii) Corrosion control study;
- (iii) Plan to cover uncovered reservoirs;
- (iv) Predesign study;
- (v) Uncovered reservoir plan of operation;
- (vi) Tracer study plan;
- (vii) Surface water or GWI treatment facility operations plan; or
- (viii) Filtration pilot study,

shall be reviewed by the department and the fee assessed shall reflect the time spent for this review and shall be calculated based on seventy-eight dollars per hour.

(f) Construction documents required under WAC 246-290-120.

Project Type	Group B	Group A				
		<100 Services	100 to 500 Services	501 to 999 Services	1,000 to 9,999 Services	10,000 or more Services
All types of filtration or other complex treatment processes	260.00	525.00	815.00	1,180.00	1,625.00	2,155.00
Chemical addition only, such as ion exchange, hypochlorination, or fluoridation	78.00	155.00	260.00	390.00	550.00	735.00

Complete new water system except treatment (an additional fee shall be assessed for review of treatment facility, if any)	210.00	470.00	680.00	945.00	1,260.00	1,625.00
New source only (an additional fee shall be assessed for review of treatment facility, if any)	155.00	285.00	390.00	525.00	680.00	865.00
One or more of the following submitted as a package and not requiring a detailed evaluation as determined by the department: Water line installation, booster pump station, modifications to source pumping, piping-valving, controls or storage reservoir (an additional fee shall be assessed for review of treatment facility, if any)	105.00	180.00	285.00	420.00	575.00	760.00
Documents submitted for projects such as water line installation, booster pump stations, modifications to source pumping, piping/valving, controls or storage reservoirs as determined by the department where such projects: Comply with design standards established by the department; Are prepared by a professional engineer in accordance with WAC 246-290-040; and Do not require a detailed evaluation by the department.	50.00	90.00	150.00	210.00	290.00	380.00

(g) Existing system approval required under WAC 246-290-140. For the purpose of this subsection the department shall determine whether a system is expanding or nonexpanding.

Project Type	Group B	Group A				
		<100 Services	100 to 500 Services	501 to 999 Services	1,000 to 9,999 Services	10,000 or more Services
NONEXPANDING system not requiring a detailed evaluation by the department	200.00	400.00	600.00	800.00	1,000.00	1,200.00
NONEXPANDING system requiring a detailed evaluation as determined by the department	300.00	600.00	900.00	1,200.00	1,500.00	1,800.00
EXPANDING system not requiring a detailed evaluation by the department	400.00	800.00	1,200.00	1,600.00	2,000.00	2,400.00

EXPANDING system  
requiring a  
detailed evaluation  
as determined  
by the department

500.00      1,000.00      1,500.00      2,000.00      2,500.00      3,000.00

## (h) Monitoring waivers requested under WAC 246-290-300.

Project Type	Group B	Group A				
		<100 Services	100 to 500 Services	501 to 999 Services	1,000 to 9,999 Services	10,000 or more Services
Inorganic chemical monitoring waiver	Not applicable	70.00 per source	95.00 per source	120.00 per source	145.00 per source	170.00 per source
Organic chemical monitoring waiver	Not applicable	125.00 per source	175.00 per source	225.00 per source	275.00 per source	325.00 per source
Use waiver	Not applicable	150.00 per source	200.00 per source	255.00 per source	300.00 per source	350.00 per source
Area wide waiver renewal	Not applicable	200.00 per source	275.00 per source	350.00 per source	425.00 per source	500.00 per source
Inorganic chemical monitoring waiver renewal	Not applicable	40.00 per source	50.00 per source	60.00 per source	70.00 per source	80.00 per source
Organic chemical monitoring waiver renewal	Not applicable	75.00 per source	105.00 per source	135.00 per source	165.00 per source	195.00 per source
Use waiver renewal	Not applicable	105.00 per source	140.00 per source	175.00 per source	210.00 per source	245.00 per source
Coliform monitoring waiver including departmental inspection requested by purveyor	Not applicable	315.00	390.00	495.00	630.00	Not applicable
Coliform monitoring waiver with third-party inspection report	Not applicable	100.00	100.00	100.00	100.00	Not applicable

(i) Other evaluations and approvals. As applicable, these fees will be charged in addition to the basic fees assessed under (a) through (h) of this subsection.

Project Type	Group B	Group A				
		<100 Services	100 to 500 Services	501 to 999 Services	1,000 to 9,999 Services	10,000 or more Services
Well-site evaluation and approval including the site inspection and hydrogeologic information review.	155.00	230.00	270.00	335.00	420.00	525.00
Regulatory monitoring plan <sup>1</sup>	No plan required	150.00	200.00	250.00	300.00	350.00
Unfiltered system annual comprehensive report	Not applicable	300.00	500.00	700.00	900.00	1,100.00
Water system compliance report	52.00	89.00	89.00	89.00	89.00	89.00

<sup>1</sup> A comprehensive document containing coliform, inorganic chemical and organic chemical monitoring plans in accordance with WAC 246-290-300 (2)(b), (3)(f), and (7)(e).

(2) To determine the appropriate fee for a noncommunity system, calculate the service equivalent by taking the average population served each day of operation and dividing by twenty-five for a transient noncommunity (TNC) system and two and one-half for nontransient noncommunity (NTNC) system. Use the number of service equivalents to

find out what Group A size category to look under and submit the appropriate fee. (All noncommunity systems are Group A systems as described in WAC 246-290-020.)

(3) Additional review and approval fees may be assessed as follows:

(a) The basic fee covers an evaluation, or the review of an initial submittal and one resubmittal if required. If additional resubmittals are required, an additional twenty-five percent of the original fee will be assessed for each additional resubmittal. For water system plan and SMA plan preparation the basic fee also covers a preplanning conference. When the department is asked to participate in other meetings involving the plan such as community meetings, public hearings, or meetings with elected officials, the department is authorized to charge additional fees at the rate of seventy-eight dollars per hour;

(b) Fees for department project approval based on local technical review will be determined on a case-by-case basis as outlined in the applicable memorandum of understanding between the department and the respective local agency;

(c) Fees for services which the department determines are not described under subsection (1) of this section, will be calculated based on a rate of seventy-eight dollars per hour.

Examples of these services include, but are not limited to:

- (i) Review and inspection of water reuse projects;
- (ii) Collection of water quality samples requested by purveyor; or
- (iii) Review of alternate technologies requested by purveyor, manufacturer or authorized representative;
- (d) Additional fees assessed by the department shall be billed to the purveyor using an itemized invoice.

(4) All fees required under this section except as noted in subsection (3) of this section, shall be submitted prior to the department's approval. Payment of fees shall be in the form of a check or money order made payable to: The Department of Health. Payment of a fee shall not guarantee approval of the submitted document or evaluation request.

(5) Purveyors unable to determine the appropriate fee payment to submit should contact the department.

[Statutory Authority: RCW 43.20B.020, 95-20-079, § 246-290-990, filed 10/4/95, effective 11/4/95; 93-01-006 (Order 315), § 246-290-990, filed 12/3/92, effective 1/3/93. Statutory Authority: RCW 43.70.040, 91-02-049 (Order 121), recodified as § 246-290-990, filed 12/27/90, effective 1/31/91. Statutory Authority: RCW 43.20A.055, 87-14-066 (Order 2493), § 440-44-048, filed 7/1/87; 83-14-038 (Order 1980), § 440-44-048, filed 6/30/83.]

## Chapter 246-291 WAC

### GROUP B PUBLIC WATER SYSTEMS

#### WAC

246-291-001	Purpose and scope.
246-291-010	Definitions.
246-291-020	Applicability.
246-291-025	Bottled water.
246-291-030	General administration.
246-291-040	Requirements for engineers.
246-291-050	Enforcement.
246-291-060	Waivers.
246-291-100	Ground water source approval and protection.
246-291-110	Surface water and GWI source approval and protection.
246-291-120	Design report approval.
246-291-130	Existing system approval.
246-291-140	Water system planning requirements.
246-291-200	Design standards.
246-291-210	Distribution systems.
246-291-220	Disinfection of facilities.
246-291-230	Treatment design and operations.
246-291-240	Reliability.

246-291-250	Continuity of service.
246-291-260	Recordkeeping and reporting.
246-291-270	Cross-connection control.
246-291-300	General monitoring requirements.
246-291-310	General follow-up.
246-291-320	Bacteriological.
246-291-330	Inorganic chemical and physical.
246-291-340	Turbidity.
246-291-350	Other substances.
246-291-360	Public notification.
246-291-370	Severability.

**WAC 246-291-001 Purpose and scope.** (1) The purpose of these rules is to define basic regulatory requirements to protect the health of consumers using Group B public drinking water supplies. These rules are specifically designed to ensure the provision of high quality drinking water in a reliable manner and in a quantity suitable for intended use.

(2) The rules set forth are adopted under chapter 43.20 RCW and owners of Group B public water systems shall be responsible for ensuring compliance with these rules. Other statutes relating to this chapter are:

- (a) RCW 43.20B.020, Fees for services—Department of health and department of social and health services;
- (b) Chapter 43.70 RCW, Department of health;
- (c) Chapter 70.05 RCW, Local health departments, boards, officers—Regulations;
- (d) Chapter 70.116 RCW, Public Water System Coordination Act of 1977; and
- (e) Chapter 70.119A RCW, Public water systems—Penalties and compliance.

(3) Prior to expanding a Group B public water system to a Group A public water system, the entire system shall be brought into compliance with chapter 246-290 WAC.

[Statutory Authority: RCW 43.20.050, 94-14-002, § 246-291-001, filed 6/22/94, effective 7/23/94.]

#### **WAC 246-291-010 Definitions.** Abbreviations:

**CSE** - comprehensive system evaluation;  
**GW** - ground water under the direct influence of surface water;

**m** - meter;

**MCL** - maximum contaminant level;

**mg/L** - milligrams per liter;

**ml** - milliliter;

**mm** - millimeter;

**NTU** - nephelometric turbidity unit;

**psi** - pounds per square inch;

**umhos/cm** - micromhos per centimeter;

**VOC** - volatile organic chemical;

**WFI** - water facilities inventory form; and

**WHPA** - wellhead protection area.

**"Authorized agent"** means any person who:

Makes decisions regarding the operation and management of a public water system whether or not he or she is engaged in the physical operation of the system;

Makes decisions whether to improve, expand, purchase, or sell the system; or

Has discretion over the finances of the system.

**"Coliform sample"** means a sample of water collected from the distribution system at or after the first service and

analyzed for coliform presence in compliance with this chapter.

"**Comprehensive system evaluation (CSE)**" means a review, inspection and assessment of a public water system, including, but not limited to: Source; facilities; equipment; operation and administration; maintenance; records; planning documents and schedules; and monitoring, for the purpose of ensuring that safe and adequate drinking water is provided.

"**Confirmation**" means to demonstrate the results of a sample to be precise by analyzing a repeat sample. Confirmation occurs when analysis results fall within plus or minus thirty percent of the original sample.

"**Contaminant**" means a substance present in drinking water which may adversely affect the health of the consumer or the aesthetic qualities of the water.

"**Cross-connection**" means a physical arrangement connecting a public water system, directly or indirectly, with anything other than another potable water system, and capable of contaminating the public water system.

"**Department**" means the Washington state department of health or health officer as identified in a joint plan of operation in accordance with WAC 246-291-030(1).

"**Disinfection**" means the use of chlorine or other agent or process the department approves for killing or inactivating microbiological organisms, including pathogenic and indicator organisms.

"**Distribution system**" means that portion of a public water supply system which stores, transmits, pumps, and distributes water to consumers.

"**Expanding public water system**" means a public water system installing additions, extensions, changes, or alterations to their existing source, transmission, storage, or distribution facilities which will enable the system to increase in size its existing service area and/or its number of approved service connections.

"**Fire flow**" means the rate of water flow needed to fight fires under WAC 246-293-640 or adopted city, town, or county standards.

"**Generator disconnect**" means an electrical circuit arranged to allow connection of a generator to the power supply for the pumping equipment while prohibiting electrical current from flowing back into the main service line.

"**Ground water under the direct influence of surface water (GWI)**" means any water beneath the surface of the ground, which the department determines has the following characteristics:

Significant occurrence of insects or other macroorganisms, algae, or large-diameter pathogens such as *Giardia lamblia*; or

Significant and relatively rapid shifts in water characteristics such as turbidity, temperature, conductivity, or pH closely correlating to climatological or surface water conditions.

"**Group B water system**" means a public water system: Constructed to serve less than fifteen residential services regardless of the number of people; or

Constructed to serve an average nonresidential population of less than twenty-five per day for sixty or more days within a calendar year; or

Any number of people for less than sixty days within a calendar year.

"**Guideline**" means a department document assisting the owner in meeting a rule requirement.

"**Health officer**" means the health officer of the city, county, city-county health department or district, or an authorized representative.

"**Hydraulic analysis**" means the study of the water system network evaluating water flows within the distribution system under worst case conditions such as, peak hourly design flow plus fire flow, when required. Hydraulic analysis includes consideration of all factors affecting system energy losses.

"**Maximum contaminant level (MCL)**" means the maximum permissible level of a contaminant in water delivered to any public water system user.

"**Maximum contaminant level violation**" means a confirmed measurement above the MCL and for a duration of time, where applicable.

"**Owner**" means any agency, subdivision of the state, municipal corporation, firm, company, mutual or cooperative association, institution, partnership, or person or any other entity that holds as property, a public water system.

"**Peak hourly design flow**" means the maximum rate of water use, excluding fire flow, which can be expected to ever occur within a defined service area over a sixty minute time period.

"**Potable**" means water suitable for drinking by the public.

"**Pressure zone**" means a distribution system whereby an established minimum and maximum pressure range can be maintained without the use of ancillary control equipment (e.g., booster pumps, pressure reducing valves, etc.).

"**Primary standards**" means standards based on chronic, nonacute, or acute human health effects.

"**Public water system**" means any system, excluding a system serving only one single-family residence and a system with four or fewer connections all of which serve residences on the same farm, providing piped water for human consumption, including collection, treatment, storage, or distribution facilities used primarily in connection with such system.

"**Repeat sample**" means a sample collected to confirm the results of a previous analysis.

"**Same farm**" means a parcel of land or series of parcels which are connected by covenants and devoted to the production of livestock or agricultural commodities for commercial purposes and does not qualify as a Group A water system.

"**Secondary standards**" means standards based on factors other than health effects such as taste and odor.

"**Sell**" means to bill separately for drinking water or to include drinking water as part of an itemized listing in a bill delivered to customers, where the amount billed is an increase over what the purveyor pays for water. The presence of centralized source or individual service meters does not affect whether the water is being sold.

"**Service**" means a connection to a public water system designed to provide potable water.

"**Special purpose sample**" means a sample collected for reasons other than the monitoring compliance specified in this chapter.

"**Standard methods**" means the 18th edition of the book, titled *Standard Methods for the Examination of Water*

and Waste Water, jointly published by the American Public Health Association, American Water Works Association (AWWA), and Water Pollution Control Federation. This book is available through public libraries or may be ordered from AWWA, 6666 West Quincy Avenue, Denver, Colorado 80235.

"State board of health" and "board" means the board created by RCW 43.20.030.

"Surface water" means a body of water open to the atmosphere and subject to surface runoff.

"Volatile organic chemical (VOC)" means a manufactured carbon-based chemical that vaporizes quickly at standard pressure and temperature.

"Water facilities inventory form (WFI)" means the department form summarizing each public water system's characteristics.

"Well field" means a group of wells one system owns or controls which:

Draw from the same aquifer or aquifers as determined by comparable inorganic chemical analysis; and

Discharge water through a common pipe and the common pipe shall allow for collection of a single sample before the first distribution system connection.

[Statutory Authority: RCW 43.20.050, 95-20-078, § 246-291-010, filed 10/4/95, effective 11/4/95; 94-14-002, § 246-291-010, filed 6/22/94, effective 7/23/94.]

**WAC 246-291-020 Applicability.** (1) The rules of this chapter shall apply to all Group B public water systems except those systems meeting all of the following conditions:

(a) Consists only of distribution and/or storage facilities and does not have any source or treatment facilities;

(b) Obtains all water from, but is not owned by, a public water system where the rules of this chapter or chapter 246-290 WAC apply;

(c) Does not sell water directly to any person;

(d) Is not a passenger-conveying carrier in interstate commerce; and

(e) The distribution system is regulated under the Uniform Plumbing Code, chapter 51-26 WAC.

Examples of systems which shall not be exempt include, but are not limited to, water districts, public utility districts, cooperatives, mutuals and associations which serve residential short plats and subdivisions.

(2) Group B public water systems meeting all of the conditions under subsection (1) of this section may be required by the department to comply with such provisions of this chapter as are necessary to resolve a public health concern if the department determines a public health threat exists or is suspected.

[Statutory Authority: RCW 43.20.050, 95-20-078, § 246-291-020, filed 10/4/95, effective 11/4/95; 94-14-002, § 246-291-020, filed 6/22/94, effective 7/23/94.]

**WAC 246-291-025 Bottled water.** (1) Any water source used for bottling, regardless of size, shall meet the minimum requirements in accordance with chapter 246-290 WAC.

(2) In addition to the requirements imposed by the department, the processing of bottled water is regulated by

the state department of agriculture and the United States Food and Drug Administration.

[Statutory Authority: RCW 43.20.050, 95-20-078, § 246-291-025, filed 10/4/95, effective 11/4/95; 94-14-002, § 246-291-025, filed 6/22/94, effective 7/23/94.]

**WAC 246-291-030 General administration.** (1) The department and the health officer for each local health jurisdiction may develop a joint plan of operation. Responsibility for administering these rules shall remain with the department of health unless there is a joint plan of operation in place. This plan shall:

(a) List the roles and responsibilities and specifically designate those systems for which the department and local health officer have primary responsibility;

(b) Provide a list of water system requirements and procedures which the local board of health may waive for systems within its jurisdiction;

(c) Provide for a level of water system supervision necessary to effectively achieve listed responsibilities;

(d) Be signed by the department and the local health department or district; and

(e) Be reviewed at least once every five years and updated as needed.

Wherever in these rules the term "department" is used, the term "health officer" may be substituted based on the terms of this joint plan of operation.

(2) The local board of health may adopt rules pursuant to RCW 70.05.060 governing public water systems for which the health officer has assumed primary responsibility. Adopted local board of health rules shall be:

(a) No less stringent and may be more stringent than this chapter; and

(b) Revised, if necessary, within twelve months after the effective date of revised state board of health rules. During this time period, existing local rules shall remain in effect, except provisions of the revised state board of health rules which are more stringent than the local board of health rules shall apply.

(3) For residential systems with only two services, the department may eliminate any or all requirements of these rules.

(4) For any residential system, the department may eliminate all ongoing requirements of these rules, except for recordkeeping and reporting requirements under WAC 246-291-260, provided the system has been granted an initial approval or an existing system has been categorized as fully approved/adequate or provisionally approved.

(5) The health officer may approve design reports and water system plans which reflect good engineering practice such as those found in the department guideline titled *Group B Water System Approval*, for those public water systems where the health officer has assumed primary responsibility.

(6) The health officer may allow system owners to substitute results of a calculated fixed radius method and a ten year time of travel criteria instead of using the six hundred foot radius prescribed in WAC 246-291-100 (2)(f) and 246-291-110 (3)(f).

(7) The department may develop and distribute guidelines to clarify sections of the rules as needed.

(8) Fees may be charged by the department of health as authorized in RCW 43.20B.020 and by local health agencies as authorized in RCW 70.05.060 to recover all or a portion of the costs incurred in administering these rules.

[Statutory Authority: RCW 43.20.050. 95-20-078, § 246-291-030, filed 10/4/95, effective 11/4/95; 94-14-002, § 246-291-030, filed 6/22/94, effective 7/23/94.]

**WAC 246-291-040 Requirements for engineers.** (1) Owners shall ensure that all design reports are prepared by a professional engineer:

(a) Licensed in the state of Washington under chapter 18.43 RCW; and

(b) Having specific expertise regarding design, operation and maintenance of public water systems.

All documents shall bear the engineer's seal and signature.

(2) Until such date as regulations addressing professional engineering requirements for public water systems take effect after adoption by the state board of registration for professional engineers and land surveyors under authority of chapter 18.43 RCW, exceptions to the professional engineer requirement are:

(a) Minor improvements exempted from design report requirements under WAC 246-291-120(1); and

(b) Public water systems serving less than ten service connections consisting of a simple well and pressure tank with one pressure zone and not providing treatment other than simple chlorine disinfection or having special hydraulic considerations, where the local health officer has been delegated authority to:

(i) Approve plans and design reports; or

(ii) Review plans and design reports for completeness prior to forwarding to the department of health for approval.

(3) A "Construction Report For Public Water System Projects" shall be submitted to the department on a department approved form within sixty days of completion and before use of any approved project. The form shall:

(a) Be signed by a professional engineer, or in the case of projects not requiring a professional engineer as outlined in this section, the water system owner;

(b) State that the project is constructed and is completed in accordance with approved design reports; and

(c) State that, in the opinion of the engineer or the water system owner, based on information available, the installation, testing, and disinfection of the system was carried out in accordance with applicable sections of chapters 246-291 and 246-290 WAC.

(4) It shall be the responsibility of the owner to ensure the requirements of this section are fulfilled before the use of any completed project.

[Statutory Authority: RCW 43.20.050. 94-14-002, § 246-291-040, filed 6/22/94, effective 7/23/94.]

**WAC 246-291-050 Enforcement.** (1) When a system is out of compliance with these rules, the department may initiate appropriate enforcement actions, regardless of any prior approvals issued by the department, including, but not limited to:

(a) Issuance of a compliance schedule;

(b) Issuance of departmental orders requiring submission of water system plans, design reports, and construction report forms;

(c) Issuance of departmental orders requiring specific actions or ceasing unacceptable activities within a designated time period;

(d) Issuance of departmental orders to stop work and/or refrain from using any public water system or improvements thereto until all written approvals required by statute or rule are obtained;

(e) Imposition of civil penalties as authorized under chapter 70.119A RCW or local authority where applicable; and

(f) Legal action by the attorney general or local prosecutor.

(2) When enforcing the MCLs under this chapter, the department shall enforce compliance with the primary MCLs as its first priority.

[Statutory Authority: RCW 43.20.050. 94-14-002, § 246-291-050, filed 6/22/94, effective 7/23/94.]

**WAC 246-291-060 Waivers.** (1) The state board of health or the local health officer in those counties having a joint plan of operation, may grant waivers of the requirements of this chapter, provided that procedures used are consistent with WAC 246-290-060 (5)(b) and in the case where a local health officer is authorized to grant the waiver, procedures used shall be approved by the department of health as part of the joint plan of operation.

(2) Consideration by the board or local health officer of requests for waivers shall not be considered adjudicative proceedings as that term is defined in chapter 34.05 RCW.

(3) Statements and written material regarding the request may be presented to the board or local health officer wherein the application will be considered.

(4) The board or local health officer may grant a waiver if it determines the water system is unable to comply with the requirements and granting of the waiver will not result in an unreasonable risk to the health of consumers. No waivers may be granted for exceedance of a primary MCL.

(5) A waiver granted under this section shall lapse two years from the date of issuance unless the water system project has been completed or an extension is granted.

[Statutory Authority: RCW 43.20.050. 94-14-002, § 246-291-060, filed 6/22/94, effective 7/23/94.]

**WAC 246-291-100 Ground water source approval and protection.** (1) The owner shall ensure that drinking water is obtained from the highest quality source feasible. Existing sources shall conform to the primary water quality standards established in this chapter. Proposed sources shall conform to the primary and secondary water quality standards established in this chapter and the well construction standards established under chapter 173-160 WAC. The owner shall be responsible for submitting evidence required by the department to determine whether a proposed ground water source is a GWI.

(2) No new source, previously unapproved source, or modification of an existing source shall be used as a drinking water supply without department approval. A party



seeking approval shall ensure compliance with WAC 246-291-140 as applicable and provide:

(a) A copy of the water right permit, if required, obtained from the department of ecology for the source, quantity, type, and place of use;

(b) A copy of the source site inspection approval made by the department or local health jurisdiction representative;

(c) Well source development data establishing source capacity. Data shall include static water level, yield, amount of drawdown, recovery rate and duration of pumping. The source shall be pump tested to determine whether the well and aquifer are capable of supplying water at the rate desired and to provide information necessary to determine proper pump settings. A department guideline titled *Group B Water System Approval* is available to assist owners;

(d) Upgradient water uses affecting either water quality or quantity;

(e) A map showing the project location and vicinity including a six hundred foot radius around the well site designating the preliminary short term ground water contribution area;

(f) A map depicting topography, distances to well or spring from existing property lines, buildings, potential sources of contamination within the six hundred foot radius around the well, and any other natural or man-made features affecting the quality or quantity of water;

(g) The dimensions and location of sanitary control area;

(h) Copies of the recorded legal documents for the sanitary control area;

(i) A copy of the water well report;

(j) A general description of the spring and/or aquifer recharge area affecting the quantity or quality of flow. Seasonal variation shall also be included;

(k) Documentation of totalizing source meter installation;

(l) An initial analysis result of raw water quality from a certified lab, including as a minimum, a bacteriological, complete inorganic chemical and physical analysis of the source water quality;

(m) In areas where the department determines that other contamination may be present, or at the discretion of the department, sample results for these contaminants may be required;

(n) If water quality information from (l) and (m) of this subsection shows a contaminant level of concern, the department may require further action by the owner; and

(o) If water quality results taken from the proposed source confirm a primary MCL violation, the owner shall ensure that appropriate treatment is provided.

(3) The owner shall contact the department before developing or modifying a source, to identify any additional requirements the department deems necessary.

(4) Sanitary control area.

(a) The owner shall ensure that a sanitary control area is maintained around all sources for the purpose of protecting them from existing and potential sources of contamination. A department guideline titled *Group B Water System Approval* describes activities which should be precluded within the sanitary control area and is available from the department on request.

(b) The minimum sanitary control area shall have a radius of one hundred feet (thirty meters) for wells, and two hundred feet (sixty meters) for springs, unless engineering justification supports a smaller area. The justification must address geological and hydrological data, well construction details and other relevant factors necessary to assure adequate sanitary control.

(c) The department may require a larger sanitary control area if geological and hydrological data support such a decision. It shall be the owner's responsibility to obtain the protection needed.

(d) No source of contamination may be constructed, stored, disposed of, or applied within the sanitary control area without the permission of the department and the system owner.

(e) The sanitary control area shall be owned in fee simple, or the owner shall have the right to exercise complete sanitary control of the land through other legal provisions.

(f) The owner shall obtain a duly recorded restrictive covenant which shall run with the land, restricting the use of said land in accordance with these rules.

[Statutory Authority: RCW 43.20.050, 95-20-078, § 246-291-100, filed 10/4/95, effective 11/4/95; 94-14-002, § 246-291-100, filed 6/22/94, effective 7/23/94.]

**WAC 246-291-110 Surface water and GWI source approval and protection.** (1) The owner shall ensure that drinking water is obtained from the highest quality source feasible. Existing sources shall conform to the primary water quality standards established in this chapter. Proposed sources shall conform to the primary and secondary water quality standards established in this chapter. The owner shall be responsible for submitting evidence required by the department to determine whether a proposed ground water source is a GWI.

(2) No new source, previously unapproved source, or modification of an existing source shall be used as a drinking water supply without department approval. As of the effective date of these rules, the department shall no longer approve new or expanding surface water or GWI sources unless the department determines they meet the following conditions:

(a) The system is under the ownership and operation of a department of health approved satellite management agency; and

(b) Continuous effective treatment, including filtration, disinfection and any other measures required under chapter 246-290 WAC are provided.

(3) An owner seeking source approval shall provide the department:

(a) A copy of the water right permit, if required, obtained from the department of ecology for the source, quantity, type, and place of use;

(b) A copy of the source site inspection approval made by the department or local health jurisdiction representative;

(c) Upgradient water uses affecting either water quality or quantity;

(d) A map showing the project location and vicinity;

(e) A map depicting topography, distances to the surface water intake or GWI source from existing property lines,

buildings, potential sources of contamination, ditches, drainage patterns, and any other natural or man-made features affecting the quality or quantity of water;

(f) For GWI sources:

(i) A map depicting topography, distances to well or spring from existing property lines, buildings, potential sources of contamination within the six hundred foot radius around the well, and any other natural or man-made features affecting the quality or quantity of water;

(ii) Copies of the recorded legal documents for the sanitary control area;

(iii) A copy of the water well report if applicable;

(iv) A general description of the recharge area affecting the quantity or quality of flow. Seasonal variation shall also be included;

(v) Well development data establishing source capacity. Data shall include static water level, yield, amount of drawdown, recovery rate and duration of pumping. The source shall be pump tested to determine whether the well and aquifer are capable of supplying water at the rate desired and to provide information necessary to determine proper pump settings. A department guideline titled *Group B Water System Approval* is available to assist owners.

Existing and proposed sources shall conform to the well construction standards established under chapter 173-160 WAC if applicable.

(g) Documentation of totalizing source meter installation;

(h) An initial analysis result of raw water quality from a certified lab, including as a minimum, a bacteriological, and complete inorganic chemical and physical analysis of the source water quality;

(i) In areas where the department determines that other contamination may be present, or at the discretion of the department, sample results for these contaminants may also be required;

(j) If water quality information from (h) and (i) of this subsection shows a contaminant level of concern, the department may require further action by the owner; and

(k) If water quality results taken from the proposed source confirm a primary MCL violation, the owner shall ensure that appropriate treatment is provided which shall eliminate the public health risk to consumers served by the system.

(4) Watershed control program.

(a) Owners of new or expanding surface water or GWI sources shall ensure the development and submittal of a watershed control program to the department for review and approval. Once approved, the owner shall implement the program.

(b) This program shall be part of the water system plan required in WAC 246-291-140.

(c) The owner's watershed control program shall contain, at a minimum, the following elements:

(i) Watershed description and inventory, including location, hydrology, land ownership and activities which may adversely affect water quality;

(ii) Watershed control measures, including documentation of ownership and relevant written agreements, monitoring procedures and water quality;

(iii) System operation, including emergency provisions; and

(iv) Documentation of water quality trends.

Sections in the department guideline titled *Planning Handbook* and in the *DOH SWTR Guidance Manual* address watershed control and are available to owners.

(d) The owner shall ensure submittal of the watershed control program to the department for review and approval. Following department approval, the owner shall ensure implementation as approved.

(e) The owner shall update the watershed control program at least every six years, or more frequently if required by the department.

[Statutory Authority: RCW 43.20.050, 95-20-078, § 246-291-110, filed 10/4/95, effective 11/4/95; 94-14-002, § 246-291-110, filed 6/22/94, effective 7/23/94.]

**WAC 246-291-120 Design report approval.** (1)

Design reports shall be submitted to the department for written approval prior to installation of any new water system, or water system extension or improvement with the following exceptions:

(a) Installation of valves, fittings, and meters;

(b) Repair of a system component or replacement with a similar component of the same capacity; and

(c) Maintenance or painting of surfaces not contacting potable water.

(2) Design reports submitted for approval by owners of systems required to have a water system plan, will not be considered for approval unless there is a current approved water system plan and the plan adequately addresses the project.

(3) Design reports shall include, at a minimum, the following:

(a) Alternatives. Verify contacts with other water system owners as applicable in accordance with WAC 246-291-140(2);

(b) Legal considerations. Identify legal aspects such as ownership, right-of-way, sanitary control area, and restrictive covenants;

(c) Engineering calculations. Describe how the project complies with the design considerations;

(d) Drawings. Include detailed drawings of each project component;

(e) Material specifications. List detailed material specifications for each project component;

(f) Construction specifications. List detailed construction specifications and assembly techniques for carrying out the project;

(g) Testing. Identify testing criteria and procedures for each applicable portion of the project;

(h) Disinfection. Identify specific disinfection procedures which must conform with American Water Works Association standards or other standards acceptable by the department;

(i) Inspection. Identify provisions for inspection of the installation of each project component. See WAC 246-291-040 for construction reporting requirements; and

(j) Change orders. All changes except for minor field revisions must be submitted to and approved by the department in writing.

(4) Approval of design reports shall be in effect for two years unless the department determines a need to withdraw

the approval. An extension of the approval may be obtained by submitting a status report and a written schedule for completion. Extensions may be subject to additional terms and conditions imposed by the department.

[Statutory Authority: RCW 43.20.050. 94-14-002, § 246-291-120, filed 6/22/94, effective 7/23/94.]

**WAC 246-291-130 Existing system approval.** (1) At the discretion of the department, owners of existing systems without approved design reports shall, as determined by the department, provide information necessary to establish the extent of the water systems compliance with this chapter.

(2) After receipt of the required data, the department shall review the information and place the system into one of the following categories:

(a) Fully approved/adequate. A fully approved system has been found to be in full compliance with these regulations and may add services if designed accordingly; or

(b) Provisionally adequate. A provisionally adequate system complies with applicable MCL and treatment standards, fire flow requirements where applicable, and meets a twenty psi minimum pressure requirement under peak hourly design flow conditions but may not be in compliance with other regulatory requirements. A provisionally adequate system is considered satisfactory for its existing services, but may not expand to supply additional services; or

(c) Inadequate. Any system not identified in (a) or (b) of this subsection. The system is considered unsatisfactory and no additional service connections can be made to an inadequate system.

(3) After categorizing the system, the department shall notify the owner in writing of the following:

(a) The system's category;

(b) The relationship of the system's category with respect to adding service connections and potential comments on status request letters; and

(c) If the system is not fully approved, what additional actions the owner needs to complete before a full or provisional approval is granted.

(4) The department is authorized to take enforcement actions in accordance with WAC 246-291-050.

[Statutory Authority: RCW 43.20.050. 95-20-078, § 246-291-130, filed 10/4/95, effective 11/4/95; 94-14-002, § 246-291-130, filed 6/22/94, effective 7/23/94.]

**WAC 246-291-140 Water system planning requirements.** (1) Water system plan.

(a) The water system plan shall:

(i) Identify present and future needs;

(ii) Set forth means for meeting those needs; and

(iii) Do so in a manner consistent with other relevant plans and local, state, and federal laws.

(b) Owners of the following categories of systems shall ensure the development and submittal of a water system plan for review and approval by the department:

(i) All systems as required by chapter 70.116 RCW the Public Water System Coordination Act of 1977 and chapter 246-293 WAC;

(ii) Any system experiencing problems related to planning, operation, and/or management as determined by the department and outlined in a departmental order;

(iii) Any proposed or expanding system as determined by the department; and

(iv) Any system which installs treatment, other than simple chlorination disinfection equipment, after the effective date of these regulations.

(c) A department guideline titled *Group B Water System Approval* is available from the department to assist owners in developing this plan. Design reports may be combined with a water system plan. To the extent to which they are applicable, the water system plan shall address the following elements:

(i) Description of system management and ownership;

(ii) Description of appropriate water quality monitoring and reporting requirements;

(iii) Service area and identification of existing and proposed major facilities;

(iv) Maximum number of connections the system can safely and reliably support;

(v) Water conservation program. Systems which are developed or expanded after the effective date of this rule shall develop a conservation program;

(vi) Relationship and compatibility with other plans;

(vii) Description of water source(s) including compliance with applicable source approval and protection under WAC 246-291-100 and 246-291-110;

(viii) Source protection (including required protective covenants, wellhead protection and watershed control where applicable); and

(ix) Financial viability.

(2) Prior to developing a new water system, the developer of the proposed system shall follow the steps listed below as applicable:

(a) The developer shall ensure that the new system is owned or operated by a department-approved satellite management agency (SMA), or if a department-approved SMA is not available, that the proposed new system has a department-approved water system plan in accordance with WAC 246-291-140;

(b) Department approval of any system created after July 22, 1995, that is not owned or operated by a SMA shall be conditioned upon future management or ownership by a SMA, if such management or ownership can be made with reasonable economy and efficiency, or upon periodic review of the system's operational history to determine its ability to meet the department's financial viability and other operating requirements.

(c) If the proposed system is located within the boundaries of a critical water supply service area, the ability to develop an independent system shall be governed by the provisions of the Public Water System Coordination Act, chapter 70.116 RCW and chapter 246-293 WAC, and will be subject to the jurisdictional coordinated water system plan; or

(d) If the proposed system consists of a surface water or GWI source, ensure that the proposed system will be owned and operated by a department-approved satellite system management agency.

(3) For systems approved after the effective date of these rules, a summary of the following shall be recorded, by

the system owner, on all affected property titles as a means of providing information about the system to property owners, lending institutions, and other potentially affected parties:

- (a) Notice that the property is served by a public water system;
- (b) The initial water system plan, planning section of the *Group B Water System Guideline*, or equivalent information from other documents as determined by the department;
- (c) Notice that the system is subject to state and local rules;
- (d) Recommendation to check with the jurisdictional regulatory authority on the current system status;
- (e) Notice that fees may be assessed by the department for providing information on a public water system;
- (f) Requirement for satellite management, if applicable;
- (g) Notice of any waivers granted to the system; and
- (h) Other information required by the department.

[Statutory Authority: RCW 43.20.050, 95-20-078, § 246-291-140, filed 10/4/95, effective 11/4/95; 94-14-002, § 246-291-140, filed 6/22/94, effective 7/23/94.]

**WAC 246-291-200 Design standards.** (1) Water system owners shall ensure that good engineering practices are used in the design of all public water systems. Information on what is good engineering practice is available from the department in the guideline titled *Group B Water System Approval*.

(2) In addition, owners of new or expanding public water systems shall ensure the following factors are addressed:

- (a) Local conditions, plans and/or regulations;
  - (b) Public Water System Coordination Act considerations where appropriate; and
  - (c) Other requirements as determined by the department.
- (3) Any pipe, pipe fittings, solder, or flux used in the installation or repair of a public water system shall be lead-free. Within the context of this section, lead-free shall mean having no more than eight percent lead in pipes and pipe fittings, and no more than two-tenths of one percent lead in solder and flux. This prohibition shall not apply to leaded joints necessary for the repair of cast iron pipes.

[Statutory Authority: RCW 43.20.050, 94-14-002, § 246-291-200, filed 6/22/94, effective 7/23/94.]

**WAC 246-291-210 Distribution systems.** (1) All distribution reservoirs shall have suitable watertight roofs or covers preventing entry by birds, animals, insects, and dust and shall include appropriate provisions to safeguard against trespass, vandalism, and sabotage. All new distribution reservoirs shall be able to be drained by gravity to daylight.

(2) The owner shall ensure that the distribution system is sized and evaluated using a hydraulic analysis acceptable to the department.

(3) Systems designed to provide fire hydrants shall have a minimum distribution main size of six inches (150 mm).

(4) New water systems or additions to existing systems shall provide a design quantity of water at a positive pressure of at least thirty psi throughout the system under peak hourly design flow conditions measured at any

customer's water meter or at the property line if no meter exists.

(5) If fire flow is to be provided, the distribution system shall be designed to provide the required fire flow at a pressure of at least twenty psi throughout the system during peak hourly design flow conditions.

(6) Booster pumps needed for individual services shall be subject to review and approval by the department. Installation shall be made under the supervision of the owner to ensure cross-connection control requirements are met. Installation of booster pumps which are an integral part of the system design shall be inspected and certified by the engineer.

[Statutory Authority: RCW 43.20.050, 94-14-002, § 246-291-210, filed 6/22/94, effective 7/23/94.]

**WAC 246-291-220 Disinfection of facilities.** No portion of a public water system containing potable water shall be put into service, nor, if service has been terminated, shall service resume, until the facility has been effectively disinfected. The procedure used for disinfection shall conform to the American Water Works Association standards or other standards acceptable to the department. In cases of new construction, drinking water shall not be furnished to the consumer until satisfactory bacteriological samples have been analyzed by a laboratory certified by the state.

[Statutory Authority: RCW 43.20.050, 94-14-002, § 246-291-220, filed 6/22/94, effective 7/23/94.]

**WAC 246-291-230 Treatment design and operations.** (1) Finished water quality from existing and proposed sources of supply shall conform to the minimum water quality standards established in this chapter.

(2) Predesign studies shall be required for proposed surface water and GWI treatment and may be required for ground water treatment. The goal of the predesign study shall be to establish the most acceptable method to produce satisfactory finished water quality.

(3) Treatment of ground water sources shall be as determined by the department.

(4) The minimum level of treatment for new or expanding surface water and GWI sources approved after the effective date of these regulations shall be coagulation, flocculation, filtration, and disinfection unless otherwise approved by the department.

(5) The minimum level of treatment for existing nonexpanding surface water and GWI sources approved prior to the effective date of these regulations shall be filtration and disinfection.

(6) Disinfection methods, other than chlorination, i.e., ozonation or ultraviolet radiation, may be approved by the department with appropriate engineering justification.

(7) The owner shall ensure that the system is operated in accordance with good operations procedures such as those listed in the department guideline titled *Group B Water System Approval*.

(8) The owner shall ensure that no bypass is established or maintained to divert water around any feature of a treatment process, except by written approval from the department.

[Statutory Authority: RCW 43.20.050. 94-14-002, § 246-291-230, filed 6/22/94, effective 7/23/94.]

**WAC 246-291-240 Reliability.** (1) All public water systems shall provide an adequate quantity and quality of water in a reliable manner.

(a) In determining whether a proposed public water system or an expansion or modification of an existing system is capable of providing an adequate quantity of water, the department shall consider the immediate as well as the reasonably anticipated future needs of the system's consumers.

(b) In determining whether an existing public water system is providing an adequate quantity of water, the department shall consider the needs of the system's existing consumers exclusively, unless, in the department's discretion, consideration of the needs of potential consumers is in the public interest.

(2) The owner shall ensure the system is constructed, operated, and maintained to protect against failures. New and expanding systems shall be equipped with a generator disconnect. Security measures shall be employed to assure the water source, water treatment processes, water storage facilities, and the distribution system are under the strict control of the owner.

(3) Where fire flow is required, a positive pressure shall be maintained throughout the system under fire flow conditions.

(4) Water pressure at the customer's service meter or property line if a meter is not used, shall be maintained at the approved design pressure under peak hourly design flow conditions.

(5) No intake or other connection shall be maintained between a public water system and a source of water not approved by the department.

(6) Owners shall provide the department with the current names, addresses, and telephone numbers of the owners, operators, and emergency contact persons for the system, including any changes to this information. The owner shall ensure that customer concerns and service complaints are responded to in a timely manner.

[Statutory Authority: RCW 43.20.050. 94-14-002, § 246-291-240, filed 6/22/94, effective 7/23/94.]

**WAC 246-291-250 Continuity of service.** (1) No owner shall transfer system ownership without providing written notice to the department and all customers. Notification shall include a time schedule for transferring responsibilities, identification of the new owner, and under what authority the new ownership will operate. If the system is a corporation, identification of the registered agent shall also be provided.

(2) The system transferring ownership shall ensure all health-related standards are met during transfer and shall inform and train the new owner regarding operation of the system.

(3) No owner shall end utility operations without providing written notice to all customers and the department at least one year prior to termination of service.

(4) Nothing in these rules shall prohibit an owner from terminating service to a specific customer if the customer

fails to pay normal fees for service in a timely manner or if the customer allows or installs an unauthorized service connection to the system.

(5) Where this section may be in conflict with existing state statutes, the more stringent statute shall prevail.

[Statutory Authority: RCW 43.20.050. 94-14-002, § 246-291-250, filed 6/22/94, effective 7/23/94.]

**WAC 246-291-260 Recordkeeping and reporting.**

(1) The owner shall ensure that the following records of operation and water quality analyses are kept on file:

(a) Records of bacteriological and turbidity analyses shall be kept for five years. Records of chemical analyses shall be kept for as long as the system is in operation. Other records of operation and analyses required by the department shall be kept for three years. All records shall bear the signature of the owner of the water system or his or her representative.

(b) Records of action taken by the system to correct violations of primary drinking water regulations and copies of public notifications shall be kept for three years after the last action taken with respect to the particular violation involved.

(c) Copies of any written reports, summaries, or communications, relating to comprehensive system evaluations (CSEs) conducted by system personnel, by a consultant or by any local, state, or federal agency, shall be kept for ten years after completion of the CSE involved.

(d) Where applicable, records of operation and analyses shall include the following:

(i) Daily chlorine residual;

(ii) Water treatment plant performance including, but not limited to:

(A) Type of chemicals used and quantity;

(B) Amount of water treated; and

(C) Results of analyses.

(iii) Daily turbidity;

(iv) Monthly water use readings from totalizing source meters; and

(v) Other information as specified by the department.

(2) Reporting.

(a) The owner shall ensure that reports required by this chapter, are submitted to the department when requested by the department or as otherwise required by this section, including tests, measurements, and analytic reports.

(b) Water facilities inventory and report form (WFI).

(i) Owners shall ensure the submittal of an updated WFI to the department every three years or as requested; and

(ii) The owner shall also ensure the submittal of an updated WFI to the department within thirty days of any change in name, number of connections, ownership, or responsibility for management of the water system.

(c) Bacteriological.

(i) The owner shall ensure that the department is notified of the presence of:

(A) Coliform in a sample, within ten days of notification by the laboratory; and

(B) Fecal coliform or E. coli in a sample, by the end of the business day in which the owner is notified by the laboratory or as soon as possible.

(ii) When a coliform MCL violation occurs, the owner shall ensure that the following notifications are made:

(A) Notification of the department before the end of the next business day when a coliform MCL is determined; and

(B) Notification of the water system users in accordance with WAC 246-291-360.

(d) Water use data shall be reported upon request of the department.

[Statutory Authority: RCW 43.20.050. 94-14-002, § 246-291-260, filed 6/22/94, effective 7/23/94.]

**WAC 246-291-270 Cross-connection control.** (1) Owners have the responsibility to protect public water systems from contamination due to cross-connections.

(2) Cross-connections which can be eliminated shall be eliminated. The owner shall work cooperatively with local authorities to eliminate or control potential cross-connections in a manner acceptable to the department.

(3) When an existing cross-connection poses a potential health or system hazard, the owner shall shut off water service to the premises until the cross-connection has been eliminated or controlled by the installation of a proper backflow prevention assembly.

(4) Backflow prevention devices shall be approved by the department and tested in a manner prescribed by the department in WAC 246-290-490.

[Statutory Authority: RCW 43.20.050. 94-14-002, § 246-291-270, filed 6/22/94, effective 7/23/94.]

**WAC 246-291-300 General monitoring requirements.** (1) The department may require additional monitoring when it determines contamination is present or suspected in the water system or when it determines the source may be vulnerable to contamination.

(2) Special purpose samples shall not count toward fulfillment of the monitoring requirements of this chapter.

(3) The owner shall ensure samples required by this chapter are collected, transported, and submitted for analysis according to department-approved methods. The analyses shall be performed by the state public health laboratory or another laboratory certified by the department. Qualified water utility, certified laboratory, or department personnel may conduct measurements for pH, temperature, residual disinfectant concentration and turbidity as required by this chapter, provided, these measurements are made in accordance with *Standard Methods*.

(4) When one Group B water system sells water to another public water system and the cumulative number of services or population served meet the definition of a Group A system, the owner of the selling system shall ensure that source monitoring is conducted in accordance with the minimum requirements for Group A community systems found in chapter 246-290 WAC.

[Statutory Authority: RCW 43.20.050. 94-14-002, § 246-291-300, filed 6/22/94, effective 7/23/94.]

**WAC 246-291-310 General follow-up.** (1) If a water quality sample exceeds any MCLs listed in this chapter, the owner shall ensure notification of the department and take follow-up action as described in this chapter.

[Title 246 WAC—page 508]

(2) When a primary MCL violation occurs, the owner shall ensure that the following actions are taken:

(a) Notification of the department in accordance with WAC 246-291-260;

(b) Notification of the consumers served by the system in accordance with WAC 246-291-360;

(c) Determination of the cause of the contamination; and

(d) Other action as directed by the department.

(3) When a secondary MCL violation occurs, the owner shall ensure that the department is notified and that action is taken as directed by the department.

(4) The department shall determine the follow-up action when a substance not included in this chapter is detected.

[Statutory Authority: RCW 43.20.050. 94-14-002, § 246-291-310, filed 6/22/94, effective 7/23/94.]

**WAC 246-291-320 Bacteriological.** (1) Owners shall ensure the collection and submittal of a sample for coliform analysis at least once every twelve months from the furthest end of the distribution system or as directed by the department.

(2) When coliform bacteria are present in any sample the owner shall ensure that:

(a) The sample is analyzed for fecal coliform or E. coli;

(b) The department is notified in accordance with WAC 246-291-260; and

(c) Further action is taken as directed by the department.

(3) MCLs.

(a) MCLs under this subsection shall be considered primary standards.

(b) An MCL violation for coliform bacteria occurs when a routine and repeat sample have coliform presence.

(c) In determining MCL compliance, the owner shall:

(i) Include:

(A) Routine samples; and

(B) Repeat samples.

(ii) Not include:

(A) Invalidated samples; and

(B) Special purpose samples.

[Statutory Authority: RCW 43.20.050. 94-14-002, § 246-291-320, filed 6/22/94, effective 7/23/94.]

**WAC 246-291-330 Inorganic chemical and physical.** (1) Monitoring.

(a) A complete inorganic chemical and physical analysis shall consist of the primary and secondary chemical and physical standards.

(i) Primary chemical and physical standards are antimony, arsenic, barium, beryllium, cadmium, chromium, cyanide, fluoride, mercury, nickel, nitrate (as N), nitrite (as N), selenium, sodium, thallium, and turbidity.

(ii) Secondary chemical and physical standards are chloride, color, hardness, iron, manganese, silver, specific conductivity, sulfate\*, total dissolved solids\*, and zinc.

\*Required only when specific conductivity exceeds seven hundred micromhos/centimeter.

(b) Samples taken for inorganic chemical analyses shall be collected at the source before treatment.

(c) Owners shall ensure submittal of at least one initial complete analysis from each source or well field;



(d) After the initial complete analysis, owners shall ensure submittal to the department of results of at least one nitrate sample analyzed from each source or well field every thirty-six months; and

(e) When treatment is provided for one or more inorganic chemical or physical contaminants, samples shall be taken for the specific contaminant or contaminants before and after treatment. The department shall determine the frequency of sampling.

(2) Follow-up. When an initial analysis of a substance exceeds the MCL, the owner shall ensure that at least one additional sample is immediately taken from the same sampling point and analyzed for any substance which exceeded the MCL. If the average of the samples exceeds the MCL, a violation is confirmed.

(3) MCLs. The primary and secondary MCLs are listed in Tables 1 and 2:

Table 1

INORGANIC CHEMICAL CHARACTERISTICS

Substance	Primary MCLs (mg/L)
Antimony	0.006
Arsenic	0.05
Barium	2.0
Beryllium	0.004
Cadmium	0.005
Chromium	0.1
Cyanide	0.2
Fluoride	4.0
Mercury	0.002
Nickel	0.1
Nitrate (as N)	10.0
Nitrite (as N)	1.0
Selenium (Se)	0.05
Sodium (Na)	*
Thallium	0.002

Substance	Secondary MCLs (mg/L)
Chloride (Cl)	250.0
Fluoride (F)	2.0
Iron (Fe)	0.3
Manganese (Mn)	0.05
Silver (Ag)	0.1
Sulfate (SO <sub>4</sub> )	250.0
Zinc (Zn)	5.0

Note: Although the state board of health has not established an MCL for sodium, there is enough public health significance connected with sodium levels to require inclusion in inorganic chemical and physical monitoring.

Table 2

PHYSICAL CHARACTERISTICS

Substance	Primary MCL
Turbidity	1-0 NTU

Substance	Secondary MCLs
Color	15 Color Units
Hardness	None established
Specific Conductivity	700 umhos/cm
Total Dissolved Solids (TDS)	500 mg/L

[Statutory Authority: RCW 43.20.050. 94-14-002, § 246-291-330, filed 6/22/94, effective 7/23/94.]

**WAC 246-291-340 Turbidity.** (1) The department shall determine monitoring requirements on a case-by-case basis. New surface water and GWI sources shall comply with applicable turbidity monitoring requirements in accordance with Part 6 of chapter 246-290 WAC.

(2) MCLs.

(a) The department shall consider standards under this subsection primary standards.

(b) The MCLs for turbidity are:

(i) 1.0 NTU, based on a monthly average of the maximum daily turbidity, where the maximum daily turbidity is defined as the average of the:

(A) Highest two hourly readings over a twenty-four-hour period when continuous monitoring is used; or

(B) Daily grab samples taken within one hour when daily monitoring is used.

The department may increase the MCL to 5.0 NTUs if the owner can show the source is within a controlled watershed and the source meets the requirements under WAC 246-291-110.

(ii) 5.0 NTUs based on an average of the maximum daily turbidity for two consecutive days.

[Statutory Authority: RCW 43.20.050. 94-14-002, § 246-291-340, filed 6/22/94, effective 7/23/94.]

**WAC 246-291-350 Other substances.** (1) In areas known or suspected of being contaminated with other substances of public health concern, the department may require that an owner submit water samples to test for the suspected contamination at a frequency determined by the department.

(2) The department may require repeat samples for confirmation of results.

(3) Any substance confirmed in a water system that does not have an MCL listed in this chapter shall be subject to the MCLs, state advisory levels (SALs) and other provisions found in chapter 246-290 WAC.

[Statutory Authority: RCW 43.20.050. 94-14-002, § 246-291-350, filed 6/22/94, effective 7/23/94.]

**WAC 246-291-360 Public notification.** (1) Responsibility. Within fourteen days of the violation, the owner shall ensure that water system users are notified when the system has a violation of a primary MCL.

(2) Content. Notices shall provide:

(a) A clear, concise, and simple explanation of the violation;

(b) Discussion of potential adverse health effects and any segments of the population that may be at higher risk;

(c) A list of steps the owner has taken or is planning to take to remedy the situation;

(d) A list of steps the consumer should take, including advice on seeking an alternative water supply if necessary;

(e) The owner's and manager's names and phone numbers; and

(f) When appropriate, notices shall be multilingual.

The owner may provide additional information to further explain the situation.



(3) Distribution. Owners shall ensure that a written notice is distributed to all water system users within fourteen days of a violation unless otherwise directed by the department.

(4) When circumstances dictate the owner give a broader or more immediate notice to protect public health, the department may require notification by whatever means necessary.

(5) When a system is granted a waiver for reduction of water quality standards, the owner shall ensure that customers are notified. The owner shall provide a notice annually and send a copy to the department.

[Statutory Authority: RCW 43.20.050. 94-14-002, § 246-291-360, filed 6/22/94, effective 7/23/94.]

**WAC 246-291-370 Severability.** If any provision of this chapter or its application to any person or circumstances is held invalid, the remainder of this chapter, or the application of the provision to other persons or circumstances, shall not be affected.

[Statutory Authority: RCW 43.20.050. 94-14-002, § 246-291-370, filed 6/22/94, effective 7/23/94.]

## Chapter 246-292 WAC

### WATER WORKS OPERATOR CERTIFICATION

#### WAC

246-292-001	Purpose.
246-292-010	Definitions.
246-292-020	General system requirements.
246-292-040	Classification of public water systems.
246-292-050	Minimum certification requirements for public water systems.
246-292-055	Minimum requirements for contract operators.
246-292-060	Minimum education and experience requirements for water works operators.
246-292-070	Application and examination.
246-292-075	Reciprocity.
246-292-080	Temporary certification.
246-292-090	Renewal of certificates.
246-292-100	Revocation.
246-292-110	Enforcement.
246-292-160	Water works certification fees.
246-292-170	Severability.

#### DISPOSITION OF SECTIONS FORMERLY CODIFIED IN THIS CHAPTER

246-292-030	Certification board. [Statutory Authority: Chapter 70.119 RCW. 94-04-004, § 246-292-030, filed 1/20/94, effective 2/20/94. Statutory Authority: RCW 43.70.040. 91-02-049 (Order 121), recodified as § 246-292-030, filed 12/27/90, effective 1/31/91. Statutory Authority: RCW 70.119.050. 78-10-053 (Order 1343), § 248-55-040, filed 9/22/78.] Repealed by 96-19-041, filed 9/12/96, effective 10/13/96. Statutory Authority: RCW 43.70.040.
246-292-120	Purpose. [Statutory Authority: RCW 43.70.040. 91-02-049 (Order 121), recodified as § 246-292-120, filed 12/27/90, effective 1/31/91. Statutory Authority: RCW 70.119.050. 82-24-070 (Order 1917), § 248-55-210, filed 12/1/82.] Repealed by 94-04-004, filed 1/20/94, effective 2/20/94. Statutory Authority: Chapter 70.119 RCW.
246-292-130	Notice of decision—Adjudicative proceeding. [Statutory Authority: RCW 43.70.040. 91-02-049 (Order 121), recodified as § 246-292-130, filed 12/27/90, effective 1/31/91. Statutory Authority: Chapter 34.05 RCW, RCW 34.05.220 (1)(a) and 70.119.050. 90-06-019 (Order 039), § 248-55-220, filed 2/28/90, effective 3/1/90. Statutory

Authority: RCW 70.119.050. 82-24-070 (Order 1917), § 248-55-220, filed 12/1/82.] Repealed by 94-04-004, filed 1/20/94, effective 2/20/94. Statutory Authority: Chapter 70.119 RCW.

246-292-140 Certificate denial—Adjudicative procedure. [Statutory Authority: RCW 43.70.040. 91-02-049 (Order 121), recodified as § 246-292-140, filed 12/27/90, effective 1/31/91. Statutory Authority: Chapter 34.05 RCW, RCW 34.05.220 (1)(a) and 70.119.050. 90-06-019 (Order 039), § 248-55-235, filed 2/28/90, effective 3/1/90.] Repealed by 94-04-004, filed 1/20/94, effective 2/20/94. Statutory Authority: Chapter 70.119 RCW.

246-292-150 Certificate suspension, modification, or revocation—Adjudicative procedure. [Statutory Authority: RCW 43.70.040. 91-02-049 (Order 121), recodified as § 246-292-150, filed 12/27/90, effective 1/31/91. Statutory Authority: Chapter 34.05 RCW, RCW 34.05.220 (1)(a) and 70.119.050. 90-06-019 (Order 039), § 248-55-240, filed 2/28/90, effective 3/1/90. Statutory Authority: RCW 70.119.050. 82-24-070 (Order 1917), § 248-55-240, filed 12/1/82.] Repealed by 94-04-004, filed 1/20/94, effective 2/20/94. Statutory Authority: Chapter 70.119 RCW.

246-292-990 Waterworks operator certification fees. [Statutory Authority: RCW 43.70.040. 91-02-049 (Order 121), recodified as § 246-292-990, filed 12/27/90, effective 1/31/91. Statutory Authority: 1982 c 201. 82-13-011 (Order 1825), § 440-44-080, filed 6/4/82.] Repealed by 94-04-004, filed 1/20/94, effective 2/20/94. Statutory Authority: Chapter 70.119 RCW.

**WAC 246-292-001 Purpose.** Pursuant to the provisions of chapter 70.119 RCW, the regulations set forth in this chapter are adopted for the protection of public health through the establishment of minimum requirements and standards by which systems are operated and operators in charge of public water systems are examined and certified as to their competency. Certification under this chapter is available to all operators who can meet the minimum qualifications of a given classification.

[Statutory Authority: Chapter 70.119 RCW. 94-04-004, § 246-292-001, filed 1/20/94, effective 2/20/94. Statutory Authority: RCW 43.70.040. 91-02-049 (Order 121), recodified as § 246-292-001, filed 12/27/90, effective 1/31/91. Statutory Authority: RCW 70.119.050. 78-10-053 (Order 1343), § 248-55-010, filed 9/22/78.]

#### WAC 246-292-010 Definitions. Abbreviations:

BAT - backflow assembly tester.

BTO - basic treatment operator.

CCS - cross connection control specialist.

GW - ground water under the direct influence of surface water.

NTNC - nontransient noncommunity.

OIT - operator-in-training.

TNC - transient noncommunity.

WDM - water distribution manager.

WDS - water distribution specialist.

WTPO - water treatment plant operator.

"Basic filtration technology" means slow sand filtration and alternate filtration technologies such as cartridge filters, bag filters, and ultrafiltration.

"Board" means the water and wastewater operator certification board of examiners as established under RCW 70.95B.070 and 70.119.080.

"Certificate" means a certificate of competency issued by the secretary stating that the operator has met the requirements for the specified operator classification of the certification program.

"Certified operator" means a person who has met the applicable requirements of chapter 246-292 WAC and holds a valid certificate.

"Complex filtration technology" means conventional, direct, in-line or diatomaceous earth filtration.

"Continuing education unit (CEU)" means a nationally recognized unit of measurement similar to college credits. One CEU is awarded for every ten contact hours of participation in an organized continuing education experience under responsible sponsorship, capable direction and qualified instruction. Forty-five relevant CEUs equals forty-five relevant college quarter credits or thirty relevant college semester credits as determined by the department.

"Contract operator" means a person in charge of the active, daily, technical operation of more than two public water systems.

"Cross connection control program" means a program protecting the health of water consumers and the potability of the public water supply as required under WAC 246-290-490.

"Department" means the Washington state department of health.

"Distribution system" means that portion of a public water system which conveys water from the source and/or treatment facilities to consumers.

"Ground water under the direct influence of surface water (GWI)" means any water beneath the surface of the ground with:

Significant occurrence of insects or other macroorganisms, algae, or large diameter pathogens such as giardia lamblia; or

Significant and relatively rapid shifts in water characteristics such as turbidity, temperature, conductivity, or pH which closely correlate to climatological or surface water condition.

"Group A water system" means a public water system with fifteen or more service connections, regardless of the number of people; or a system serving an average of twenty-five or more people per day for sixty or more days within a calendar year, regardless of the number of service connections.

"Group B water system" means a public water system with less than fifteen service connections and serving:

An average of less than twenty-five people per day for sixty or more days within a calendar year; or

Any number of people for less than sixty days within a calendar year.

"Nationally recognized association of certification authorities" means an organization which: Serves as an information center for certification activities;

Recommends minimum standards and guidelines for classification of potable water treatment plants, water distribution systems, wastewater facilities and certification of operators;

Facilitates reciprocity between state programs; and

Assists authorities in establishing new and updating existing certification programs.

"Nontransient noncommunity water system (NTNC)" means a Group A water system regularly serving twenty-five or more of the same nonresidents for one hundred eighty or more days within a calendar year.

"Owner" means any agency, subdivision of the state, municipal corporation, firm, company, mutual or cooperative association, institution, partnership, or person or any other entity that holds as property, a public water system.

"Professional growth reporting period" means a designated time period of not less than three years, in which a certified operator shall demonstrate professional growth.

"Public water system" means any system, excluding a system serving only one single-family residence and a system with four or fewer connections all of which serve residences on the same farm, providing piped water for human consumption, including any collection, treatment, storage, or distribution facilities under control of the purveyor and used primarily in connection with the system; and collection or pretreatment storage facilities not under control of the purveyor but primarily used in connection with the system.

"Purification plant" means that portion of a public water system which treats or improves the physical, chemical or bacteriological quality of the system's water to bring the water into compliance with state board of health standards. Unit processes installed as necessary to perform water filtration, ion exchange, electro dialysis, reverse osmosis, or iron and manganese removal shall be included within the scope of the term purification plant. Unit processes installed as necessary to allow in-line fluoridation, in-line chlorination, or chemical addition to inhibit corrosion shall not be included within the scope of the term purification plant.

"Secretary" means the secretary of the department of health or the secretary's designee.

"Service" means a connection to a public water system designed to serve a single family residence or other residential or nonresidential population. When the connection is to a system without clearly defined single family residences or with a nonresident population, the following formulas shall be used in determining equivalent number of services:

For group home or barracks-type accommodation, divide the average population served each day by two and one-half;

For NTNC systems, divide the average population served each day by two and one-half; and

For TNC systems, divide the average population served each day by twenty-five.

"Surface water" means a body of water open to the atmosphere and subject to surface runoff.

"Transient noncommunity water system (TNC)" means a Group A water system:

Having fifteen or more services used less than one hundred eighty days within a calendar year; or

Serving twenty-five or more different nonresidents for sixty or more days within a calendar year; or

Serving twenty-five or more of the same nonresidents for sixty or more days, but less than one hundred eighty days within a calendar year; or

Serving twenty-five or more residents for sixty or more days, but less than one hundred eighty days within a calendar year.

[Statutory Authority: Chapter 70.119 RCW. 94-04-004, § 246-292-010, filed 1/20/94, effective 2/20/94. Statutory Authority: RCW 43.70.040. 91-02-049 (Order 121), recodified as § 246-292-010, filed 12/27/90, effective 1/31/91. Statutory Authority: RCW 70.119.050. 78-10-053 (Order 1343), § 248-55-020, filed 9/22/78.]

**WAC 246-292-020 General system requirements.**

(1) All Group A water systems shall have at least one certified operator as required under WAC 246-292-050 if the system:

- (a) Serves one hundred or more services in use at any one time; or
  - (b) Has a surface water or GWI source.
- (2) When a certified operator is required, the operator shall be in charge of the active, daily, technical operation of all portions of a public water system.
- (3) Where shift work is practiced, a certified operator shall be in charge of each operating shift. The certified operator shall be present or on call.
- (4) When a system apportions responsibility for segments of a public water system, the system shall ensure that a certified operator is responsible for each segment.

[Statutory Authority: Chapter 70.119 RCW. 94-04-004, § 246-292-020, filed 1/20/94, effective 2/20/94. Statutory Authority: RCW 43.70.040. 91-02-049 (Order 121), recodified as § 246-292-020, filed 12/27/90, effective 1/31/91. Statutory Authority: RCW 70.119.050. 78-10-053 (Order 1343), § 248-55-030, filed 9/22/78.]

**WAC 246-292-040 Classification of public water systems.**

(1) The secretary shall classify purification plants into groups according to the "Purification Plant Criteria" approved by the board in November 1993. Copies of the "Purification Plant Criteria" are available on request by contacting the Water Works Certification Program, Airdustrial Center #3, P.O. Box 47822, Olympia, Washington 98504-7822.

(2) The secretary shall classify distribution systems into groups as follows:

Classification	Population Served*
Group 1	less than 1,500
Group 2	1,501 - 15,000
Group 3	15,001 - 50,000
Group 4	greater than 50,000

\* If the population served is not known, apply this formula:  
 Number of Service Connections x 2.5 = Population Served

[Statutory Authority: Chapter 70.119 RCW. 94-04-004, § 246-292-040, filed 1/20/94, effective 2/20/94. Statutory Authority: RCW 43.70.040. 91-02-049 (Order 121), recodified as § 246-292-040, filed 12/27/90, effective 1/31/91. Statutory Authority: RCW 70.119.050. 78-10-053 (Order 1343), § 248-55-050, filed 9/22/78.]

**WAC 246-292-050 Minimum certification requirements for public water systems.**

(1) Owners shall have at least one certified operator in charge of the active, daily, technical operation of their system as follows:

- (a) A WTPO shall be responsible for the operation of a purification plant utilizing complex filtration technology;
- (b) A BTO shall be responsible for the operation of:
  - (i) A purification plant utilizing basic filtration technology; or
  - (ii) An unfiltered Group A surface water or GWI system with less than one hundred services in use at any one time.
- (c) A WDM shall be responsible for the operation of a Group A water system with:
  - (i) One hundred or more services in use at any one time; or

- (ii) A purification plant utilizing complex filtration technology.

(2) Owners required to develop a cross-connection control program shall ensure that a CCS is responsible for:

- (a) The system's cross-connection control program;
- (b) Initial inspection of premises served by the system, for cross-connections; and
- (c) Periodic reinspection of premises served by the system, for cross-connections.

(3) Owners shall ensure that a BAT is responsible for inspecting, testing, and monitoring backflow prevention assemblies in accordance with WAC 246-290-490.

(4) Owners may utilize a WDS to accomplish routine technical duties, provided they are under the supervision of an operator certified in accordance with WAC 246-292-020.

(5) A WTPO and WDM shall be certified at a level equal to or higher than the water system's classification rating assigned by the secretary in accordance with WAC 246-292-040.

(6) When the Group A water system practices shift work, the certified operator in charge of each shift shall be certified at a minimum of one level lower than the classification of the purification plant or distribution system.

[Statutory Authority: Chapter 70.119 RCW. 94-04-004, § 246-292-050, filed 1/20/94, effective 2/20/94. Statutory Authority: RCW 43.70.040. 91-02-049 (Order 121), recodified as § 246-292-050, filed 12/27/90, effective 1/31/91. Statutory Authority: RCW 70.119.050. 78-10-053 (Order 1343), § 248-55-060, filed 9/22/78.]

**WAC 246-292-055 Minimum requirements for contract operators.**

(1) Contract operators shall mean persons who are in charge of the active, daily, technical operation of more than two public water systems.

(2) Contract operators responsible for operation of a system shall be certified as follows:

- (a) At a minimum, a WDM and CCS, with the WDM level determined by the largest public water system operated;
- (b) A BTO for public water systems with basic filtration technology; and
- (c) A WTPO for public water systems with complex filtration technology.

(3) Contract operators shall maintain twenty-four-hour telephone availability.

(4) Contract operators shall submit two copies of all signed operations contracts to the department within thirty days of the effective date.

(5) Contract operators who are satellite management agencies shall also comply with the provisions of RCW 70.116.134.

[Statutory Authority: Chapter 70.119 RCW. 94-04-004, § 246-292-055, filed 1/20/94, effective 2/20/94.]

**WAC 246-292-060 Minimum education and experience requirements for water works operators.**

(1) Minimum education and experience requirements for the following water works operator classifications and levels shall be as indicated in Table 1:

Table 1  
MINIMUM EDUCATION AND EXPERIENCE REQUIREMENTS

WATER WORKS OPERATOR CLASSIFICATIONS	LEVEL									
	OIT*		1		2		3		4	
	Education	Experience	Education	Experience	Education	Experience	Education	Experience	Education	Experience
Water Distribution Manager (WDM)	12 years	3 months	12 years	1 year	12 years	2 years	14 years	4 years	16 years	4 years
Water Treatment Plant Operator (WTPO)	12 years	3 months	12 years	1 year	12 years	2 years	14 years	4 years	16 years	4 years
Water Distribution Specialist (WDS)	12 years	3 months	12 years	1 year	12 years	2 years	NA	NA	NA	NA
Cross-Connection Control Specialist (CCS)	NA	NA	12 years	3 months	12 years	3 years	NA	NA	NA	NA
Backflow Assembly Tester (BAT)	NA	NA	NA	NA	NA	NA	NA	NA	NA	NA
Basic Treatment Operator (BTO)	NA	NA	NA	NA	NA	NA	NA	NA	NA	NA

\* OIT experience may be fulfilled by three months operating experience or thirty hours of relevant classroom training (three CEUs or college credits).

(2) Minimum education shall be the acceptable level of education, or experience which may be substituted for education. A department guideline titled "Water Works Certification Program Guideline" is available to assist operators in determining acceptable education and experience.

(3) Minimum experience shall be the routine on-site performance of duties in a water purification plant or distribution system. Those duties shall affect plant or system performance and/or water quality.

(4) The board may allow substitutions of a person's relevant experience when the person cannot meet the formal education requirement, or vice versa in the WDM, WTPO, WDS and CCS classifications as outlined in the department guideline titled "Water Works Certification Program Guideline" available on request.

[Statutory Authority: Chapter 70.119 RCW. 94-04-004, § 246-292-060, filed 1/20/94, effective 2/20/94. Statutory Authority: RCW 43.70.040. 91-02-049 (Order 121), recodified as § 246-292-060, filed 12/27/90, effective 1/31/91. Statutory Authority: RCW 70.119.050. 78-10-053 (Order 1343), § 248-55-070, filed 9/22/78.]

**WAC 246-292-070 Application and examination.**

(1) Applicants for any classification of water works operator shall:

- (a) Meet the minimum education and experience criteria for the level of certification for which they are applying in accordance with WAC 246-292-060;
- (b) Submit a completed application and applicable fee to the secretary;
- (c) Pass the written examination for the appropriate classification and level; and
- (d) For the BAT and BTO classifications, pass the practical examination.

(2) The secretary shall:

- (a) Conduct examinations at least three times annually at convenient places and times as set by the board;
- (b) Provide notice of places and times of regularly scheduled examinations; and
- (c) Issue applicable certificates to applicants meeting all the conditions for certification.

(3) Applicants who fail or do not appear for their scheduled examination may reapply for a regularly scheduled examination by submitting a new application along with the applicable fee to the secretary.

[Statutory Authority: Chapter 70.119 RCW. 94-04-004, § 246-292-070, filed 1/20/94, effective 2/20/94. Statutory Authority: RCW 43.70.040. 91-02-049 (Order 121), recodified as § 246-292-070, filed 12/27/90, effective 1/31/91. Statutory Authority: RCW 70.119.050. 78-10-053 (Order 1343), § 248-55-080, filed 9/22/78.]

**WAC 246-292-075 Reciprocity.** The secretary may issue a certification without examination provided:

- (1) A completed application and applicable fee are submitted to the secretary; and
- (2) The applicant possesses a certificate from a state or province having substantially equivalent standards as determined by the secretary after consultation with the board.

[Statutory Authority: Chapter 70.119 RCW. 94-04-004, § 246-292-075, filed 1/20/94, effective 2/20/94.]

**WAC 246-292-080 Temporary certification.** (1) The secretary may issue a temporary certificate to an operator without examination, provided:

- (a) The public water system submits:
  - (i) A letter requesting a temporary certificate for the operator; and
  - (ii) The applicable fee.
- (b) The operator completes and submits a certification application; and
- (c) The operator meets or will meet the minimum education and experience requirements of the mandatory classification for the vacated position, prior to the expiration date of the temporary certificate.

(2) Only one temporary certificate may be issued in each instance of vacation of any position.

(3) The temporary certificate shall be valid for up to twelve months.

(4) The temporary certificate shall be specific to the designated system.

[Statutory Authority: Chapter 70.119 RCW. 94-04-004, § 246-292-080, filed 1/20/94, effective 2/20/94. Statutory Authority: RCW 43.70.040. 91-02-049 (Order 121), recodified as § 246-292-080, filed 12/27/90, effective 1/31/91. Statutory Authority: RCW 70.119.050. 78-10-053 (Order 1343), § 248-55-090, filed 9/22/78.]

**WAC 246-292-090 Renewal of certificates.** (1) The operator certificate shall be renewed by January 1st of each year.

(2) The secretary shall renew the operator certificate upon payment of the renewal fee and demonstration of professional growth in accordance with subsections (3), (4), and (5) of this section. The applicant shall provide evidence of professional growth acceptable to the department within the designated professional growth reporting period. A department guideline titled "Water Works Certification Program Guideline" is available to assist the applicant.

(3) To demonstrate professional growth, a holder of WDM, WTPO, WDS, or CCS certification shall accomplish one of the following activities during each professional growth reporting period:

(a) Accumulate a minimum of three CEUs, or college credits relevant to the operation, maintenance, or management of a water system;

(b) Advance by examination in the Washington water works operator certification program within the same classification to a level 2, 3, or 4; or

(c) Achieve certification by examination in a different classification as shown below:

- (i) WDM to WTPO;
- (ii) WTPO to WDM;
- (iii) WDS to WDM or WTPO; or
- (iv) CCS to WDM, WTPO, or WDS.

(4) To demonstrate professional growth, a holder of a BAT certification shall satisfactorily complete the board's backflow assembly tester practical and written examination during each professional growth reporting period.

(5) To demonstrate professional growth, a holder of a BTO certification shall satisfactorily complete the board's basic treatment operator refresher practical and written examinations during each professional growth reporting period.

(6) The secretary shall notify an operator failing to renew the operator certificate by December 31st, that the certificate is temporarily valid for two months beginning January 1st.

(7) A certificate not renewed during the two month period shall become invalid. The secretary shall notify the holder of an invalid certificate with a written notice.

(8) An operator failing to renew their certification under provisions of this section may reapply for certification and shall meet the requirements for a new applicant.

[Statutory Authority: Chapter 70.119 RCW. 94-04-004, § 246-292-090, filed 1/20/94, effective 2/20/94. Statutory Authority: RCW 43.70.040. 91-02-049 (Order 121), recodified as § 246-292-090, filed 12/27/90, effective 1/31/91. Statutory Authority: Chapter 201, Laws of 1982. 82-13-009 (Order 1823), § 248-55-110, filed 6/4/82. Statutory Authority: RCW 70.119.050. 78-10-053 (Order 1343), § 248-55-110, filed 9/22/78.]

**WAC 246-292-100 Revocation.** (1) The secretary may revoke an operator's certificate when the operator:

- (a) Obtains a certificate by fraud or deceit;
- (b) Demonstrates gross negligence in the operation of a purification plant or a distribution system; or
- (c) Intentionally violates the requirements of this chapter or any department rules or orders.

(2) The secretary shall provide written notice of violation and reasonable opportunity for correction prior to taking action on revocation of a certificate.

(3) No action to revoke a certificate shall be initiated by the secretary unless and until the board has conducted a hearing to consider the appropriateness of revocation and the board has recommended revocation to the secretary.

(4) A revocation action brought under this section shall be conducted in accordance with RCW 43.70.115, chapter 34.05 RCW, and chapter 246-10 WAC.

[Statutory Authority: Chapter 70.119 RCW. 94-04-004, § 246-292-100, filed 1/20/94, effective 2/20/94. Statutory Authority: RCW 43.70.040. 91-02-049 (Order 121), recodified as § 246-292-100, filed 12/27/90, effective 1/31/91. Statutory Authority: RCW 70.119.050. 78-10-053 (Order 1343), § 248-55-120, filed 9/22/78.]

**WAC 246-292-110 Enforcement.** When any Group A water system or operator is out of compliance with these regulations, the department may initiate appropriate enforcement actions as authorized under chapter 70.119 and 70.119A RCW. These actions may include any one or combination of the following:

- (1) Issuance of informal letters instructing or requiring appropriate corrective measures;
- (2) Issuance of a compliance schedule;
- (3) Issuance of a departmental order;
- (4) Issuance of civil penalties for up to five thousand dollars per day per violation;
- (5) Prosecution as a criminal misdemeanor with fines up to one hundred dollars per offense; and
- (6) Other legal action by the attorney general or local prosecutor.

[Statutory Authority: Chapter 70.119 RCW. 94-04-004, § 246-292-110, filed 1/20/94, effective 2/20/94. Statutory Authority: RCW 43.70.040. 91-02-049 (Order 121), recodified as § 246-292-110, filed 12/27/90, effective 1/31/91. Statutory Authority: RCW 70.119.050. 78-10-053 (Order 1343), § 248-55-130, filed 9/22/78.]

**WAC 246-292-160 Water works certification fees.**

- (1) Operator fees:
  - (a) Applicable fees shall be as indicated in Table 2;

Table 2  
WATER WORKS OPERATOR FEES

OPERATOR CLASSIFICATION	APPLICATION FEE	REAPPLICATION FEE	ANNUAL RENEWAL FEE	LATE FEE
WTPO	\$ 50.00	\$ 25.00	\$ 25.00 *	\$ 25.00 *
WDM	\$ 50.00	\$ 25.00	\$ 25.00 *	\$ 25.00 *
WDS	\$ 50.00	\$ 25.00	\$ 25.00 *	\$ 25.00 *
CCS	\$ 30.00	\$ 25.00	\$ 25.00 *	\$ 25.00 *
BAT	\$ 30.00	\$ 25.00	\$ 25.00	\$ 25.00
BTO	\$ 30.00	\$ 25.00	\$ 25.00	\$ 25.00

The annual renewal fee and late fee for a WTPO, WDM, WDS and CCS certification shall be twenty-five dollars regardless of the number of classifications held.

(b) A late fee shall be assessed to operators failing to submit the required fee within the time period specified on the renewal form; and

(c) The fee for application for reciprocity shall be one hundred dollars per classification.

(2) Group A system fees:

- (a) Applicable fees shall be as indicated in Table 3.

Table 3  
ANNUAL SYSTEM CERTIFICATION FEES

SYSTEM SIZE * (Number of Equivalent Services)	SYSTEM FEE
Less than 601 Services	\$ 75.00
601 through 6,000 Services	\$ 225.00
6,001 through 20,000 Services	\$ 300.00
More than 20,000 Services	\$ 450.00

Systems designated by the department as approved satellite management agencies (SMAs) shall pay a fee based on total services in all systems owned by the SMA.

(b) Group A system fees shall be paid in conjunction with the system's annual operating permit fee required in chapter 246-294 WAC.

(c) A late fee shall be assessed against any system not submitting the applicable fee to the department within the designated time period. The late fee shall be based on the water system's classification and shall be an additional ten percent of the applicable system fee or twenty-five dollars, whichever is greater.

(d) The system fee for issuance of a temporary certificate shall be fifty dollars for each temporary position.

(3) Fees shall be nonrefundable and transfers of fees shall not be allowed.

(4) Payment of fees required under this chapter shall be in the form of a check or money order made payable to the department of health and shall be mailed to Department of

Health, P.O. Box 1099, Olympia, Washington 98507-1099, or such successor organization or address as designated by the department.

[Statutory Authority: Chapter 70.119 RCW. 94-04-004, § 246-292-160, filed 1/20/94, effective 2/20/94.]

**WAC 246-292-170 Severability.** If any provision of this chapter or its application to any person or circumstances is held invalid, the remainder of this chapter, or the application of the provision to other persons or circumstances, shall not be affected.

[Statutory Authority: Chapter 70.119 RCW. 94-04-004, § 246-292-170, filed 1/20/94, effective 2/20/94.]

## Chapter 246-293 WAC WATER SYSTEM COORDINATION ACT

### WAC

246-293-001	Purpose.
<b>PART I. PROCEDURAL REGULATIONS</b>	
246-293-110	Definitions.
246-293-120	Preliminary assessment—Requirement.
246-293-130	Preliminary assessment—Procedures.
246-293-140	Declaration of critical water supply service area.
246-293-150	Water utility coordinating committee—Establishment.
246-293-160	Water utility coordinating committee—Purpose.
246-293-170	Establishment of external critical water supply service area boundaries—Procedures.
246-293-180	Establishment of external critical water supply service area boundaries—Criteria.
246-293-190	Establishment of critical water supply service area boundaries—Effect.
246-293-200	Alteration of external critical water supply service area boundaries.
246-293-210	Update of external critical water supply service area boundaries.
246-293-220	Coordinated water system plan—Requirement.
246-293-230	Coordinated water system plan—Water system plan.
246-293-240	Coordinated water system plan—Supplementary provisions.
246-293-250	Service area agreements—Requirement.
246-293-260	Coordinated water system plan—Procedures (water utility coordinating committee).
246-293-270	Coordinated water system plan—Effect.
246-293-280	Coordinated water system plan—Update.
246-293-290	Coordinated water system plan—Local review.
246-293-300	Coordinated water system plan—Department approval.
246-293-310	Severability.

### PART II. RESOLUTION OF SERVICE AREA CONFLICTS

246-293-401	Purpose.
246-293-420	Public hearing.
246-293-430	Initial decision.

### PART III. FIRE FLOW

246-293-601	Purpose.
246-293-602	Scope.
246-293-610	Definitions.
246-293-620	Administration.
246-293-630	Application.
246-293-640	Minimum standards for fire flow.
246-293-650	Minimum standards for fire hydrants.
246-293-660	Minimum standards for system reliability.
246-293-670	Alternate methods.
246-293-680	Local standards.
246-293-690	Severability.

### DISPOSITION OF SECTIONS FORMERLY CODIFIED IN THIS CHAPTER

246-293-440	Adjudicative proceeding. [Statutory Authority: RCW 43.70.040. 91-02-049 (Order 121), recodified as § 246-293-440, filed 12/27/90, effective 1/31/91. Statutory Authority: Chapter 34.05 RCW, RCW 34.05.220 (1)(a) and 70.116.050. 90-06-019 (Order 039), § 248-59-030, filed 2/28/90, effective 3/1/90. Statutory Authority: RCW 74.116.070 [70.116.070]. 83-01-015 (Order 1919), § 248-59-030, filed 12/6/82.] Repealed by 93-13-005 (Order 369), filed 6/3/93, effective 7/4/93. Statutory Authority: RCW 43.70.040.
-------------	--

**WAC 246-293-001 Purpose.** This chapter is promulgated pursuant to the authority granted in the Public Water System Coordination Act of 1977, chapter 70.116 RCW, for the purpose of implementing a program relating to public water system coordination within the state of Washington, for evaluation and determination of critical water supply service areas, and assistance for orderly and efficient public water system planning.

[Statutory Authority: RCW 43.70.040. 91-02-049 (Order 121), recodified as § 246-293-001, filed 12/27/90, effective 1/31/91. Statutory Authority: Chapter 70.116 RCW. 78-07-048 (Order 1309), § 248-56-100, filed 6/28/78.]

### PART I. PROCEDURAL REGULATIONS

**WAC 246-293-110 Definitions.** (1) "Public water system" - Any system or water supply intended or used for human consumption or other domestic uses including, but not limited to, source, treatment, storage, transmission and distribution facilities where water is furnished to any community, number of individuals or is made available to the public for human consumption or domestic use. This definition shall exclude any water system serving one single family residence, water systems existing prior to September 21, 1977 which are owner operated and serve less than ten single family residences, and water systems serving no more than one industrial plant.

(2) "Purveyor" - Any agency or subdivision of the state or any municipality, firm, company, mutual or cooperative association, institution, partnership, person, or any other entity that owns or operates a public water system for wholesale or retail service (or their authorized agent).

(3) "Municipality" - Any county, city, town, or any other entity having its own incorporated government for local affairs including, but not limited to, metropolitan municipal corporation, public utility district, water district, irrigation district, sewer district, and/or port district.

(4) "Inadequate water quality" - An excess of maximum contaminant levels established by the state board of health (chapter 248-54 WAC).

(5) "Unreliable service" - Low pressure or quantity problems, and/or frequent service interruption inconsistent with state board of health requirements (chapter 248-54 WAC).

(6) "Lack of coordinated planning" - Failure to resolve existing or potential areawide problems related to:

(a) Insufficient control over development of new public water systems.

(b) Adjacent or nearby public water systems constructed according to incompatible design standards.



(c) No future service area agreements, or conflicts in existing or future service areas.

(d) Adjacent public water systems which could benefit from emergency interties or joint-use facilities.

(e) Water system plans which have not been updated in accordance with chapter 248-54 WAC.

(f) Inconsistencies between neighboring water system plans, or failure to consider adopted county or city land use plans or policies.

(7) "Critical water supply service area" - A geographical area designated by the department or county legislative authority characterized by public water system problems related to inadequate water quality, unreliable service, and/or lack of coordinated water system planning. It may be further characterized by a proliferation of small, inadequate public water systems, or by water supply problems which threaten the present or future water quality or reliability of service in such a manner that efficient and orderly development may best be achieved through coordinated planning by public water systems in the area.

(8) "County legislative authority" - The board of county commissioners or that body assigned such duties by a county charter as enacting ordinances, passing resolutions, and appropriating public funds for expenditure.

(9) "Local planning agency" - The division of city or county government responsible for land use planning functions.

(10) "Coordinated water system plan" - A plan for public water systems within a critical water supply service area which identifies the present and future water system concerns and sets forth a means for meeting those concerns in the most efficient manner possible.

(11) "Existing service area" - A specific area within which direct service or retail service connections to customers of a public water system are currently available.

(12) "Future service area" - A specific area for which water service is planned by a public water system, as determined by written agreement between purveyors provided for in WAC 248-56-730.

(13) "Department" - The Washington state department of social and health services.

[Statutory Authority: RCW 43.70.040. 91-02-049 (Order 121), recodified as § 246-293-110, filed 12/27/90, effective 1/31/91. Statutory Authority: Chapter 70.116 RCW. 78-07-048 (Order 1309), § 248-56-200, filed 6/28/78.]

**WAC 246-293-120 Preliminary assessment—Requirement.** In areas where public water systems are suspected of having problems related to inadequate water quality, unreliable service, or lack of coordinated planning, a preliminary assessment shall be undertaken to determine if the geographical area should be designated a critical water supply service area. (See WAC 248-56-200 for definitions.)

[Statutory Authority: RCW 43.70.040. 91-02-049 (Order 121), recodified as § 246-293-120, filed 12/27/90, effective 1/31/91. Statutory Authority: Chapter 70.116 RCW. 78-07-048 (Order 1309), § 248-56-300, filed 6/28/78.]

**WAC 246-293-130 Preliminary assessment—Procedures.** (1) The preliminary assessment shall be conducted under the authority of the county legislative

authority(ies) and the department with assistance from affected state and local agencies and water purveyors.

(2) Notice that a preliminary assessment is being undertaken shall be made to all affected parties, those who have demonstrated an interest, and the local news media.

(3) The preliminary assessment shall be presented in report form, as short and factual as possible, and shall consider at least the following topics as they relate to public water systems in the potential critical water supply service area:

(a) Existing water systems, including:

(i) History of water quality, reliability and service,

(ii) General fire fighting capability of the utilities, and

(iii) Identification of major facilities which need to be expanded, altered, or replaced.

(b) Availability and adequacy of future water source(s).

(c) Service area boundaries, including a map of established boundaries and identification of systems without established boundaries.

(d) Present growth rate.

(e) Status of water system planning, land use planning, and coordination, including a list of land use plans and policies adopted by local general purpose governments.

(4) Upon completion, the preliminary assessment shall be submitted to the county legislative authority(ies) and the department for review. A copy shall also be transmitted to all potentially affected water purveyors and appropriate news media.

[Statutory Authority: RCW 43.70.040. 91-02-049 (Order 121), recodified as § 246-293-130, filed 12/27/90, effective 1/31/91. Statutory Authority: Chapter 70.116 RCW. 78-07-048 (Order 1309), § 248-56-310, filed 6/28/78.]

**WAC 246-293-140 Declaration of critical water supply service area.** (1) Based upon review of the preliminary assessment, if findings indicate that a geographical area does have problems related to inadequate water quality, unreliable service, or lack of coordinated planning, the county legislative authority(ies) or the department shall declare that area a critical water supply service area.

(2) The declaration shall be in the format of a legislative enactment signed by the county legislative authority(ies), or administrative declaration signed by the secretary of the department or his designee.

(3) The declaring agency shall file its declaration with the other agency(ies) and notify in writing the appropriate local planning agencies, affected water purveyors, and the local news media within ten days.

[Statutory Authority: RCW 43.70.040. 91-02-049 (Order 121), recodified as § 246-293-140, filed 12/27/90, effective 1/31/91. Statutory Authority: Chapter 70.116 RCW. 78-07-048 (Order 1309), § 248-56-400, filed 6/28/78.]

**WAC 246-293-150 Water utility coordinating committee—Establishment.** (1) Within thirty days following the declaration of a critical water supply service area, a water utility coordinating committee composed of not less than three voting members shall be appointed by the declaring authority.

(2) The water utility coordinating committee shall consist of one representative from each of the following:

(a) County legislative authority within the declared area;



(b) County planning agency having jurisdiction within the declared area;

(c) Health agency having jurisdiction within the declared area under chapters 70.08, 70.05, 43.20 RCW; and

(d) Water purveyor with over fifty services within the declared area.

(Other interested persons may be appointed as nonvoting members of the committee by the authority declaring the critical water supply service area if determined appropriate.)

(3) At the first meeting of the water utility coordinating committee, the following shall be determined:

(a) Chairperson; and

(b) Rules for conducting business, including voting procedure.

[Statutory Authority: RCW 43.70.040, 91-02-049 (Order 121), recodified as § 246-293-150, filed 12/27/90, effective 1/31/91. Statutory Authority: Chapter 70.116 RCW, 89-16-065 (Order 2840), § 248-56-500, filed 7/31/89, effective 8/31/89; 78-07-048 (Order 1309), § 248-56-500, filed 6/28/78.]

**WAC 246-293-160 Water utility coordinating committee—Purpose.** (1) The initial purpose of the water utility coordinating committee shall be to recommend external critical water supply service area boundaries to the county legislative authority(ies) within six months of appointment of the committee. (See WAC 248-56-600.)

(2) Following establishment of external critical water supply service area boundaries, the water utility coordinating committee shall be responsible for development of the coordinated water system plan. (See WAC 248-56-740.)

[Statutory Authority: RCW 43.70.040, 91-02-049 (Order 121), recodified as § 246-293-160, filed 12/27/90, effective 1/31/91. Statutory Authority: Chapter 70.116 RCW, 78-07-048 (Order 1309), § 248-56-510, filed 6/28/78.]

**WAC 246-293-170 Establishment of external critical water supply service area boundaries—Procedures.** (1) Proposed boundaries shall be documented by a written report which includes:

(a) A map and narrative description of the recommended boundary.

(b) A narrative statement outlining the reasons for the recommended boundary location, the criteria used and relative importance of each.

(2) Prior to submittal of recommended external boundaries to the county legislative authority(ies), the water utility coordinating committee shall conduct at least one informational meeting for the purpose of soliciting public input.

(3) The water utility coordinating committee shall make a formal report of its recommended external critical water supply service area boundaries to the county legislative authority(ies).

(4) The county legislative authority(ies) shall conduct at least two public hearings on the proposed boundaries within six months from the date the boundaries were submitted by the water utility coordinating committee, for the purpose of soliciting responses to the proposed boundaries.

(5) Within six months from the date proposed boundaries are submitted to the county legislative authority(ies), one of the following actions may be taken by the county legislative authority(ies):

(a) Ratify the proposed boundaries based on findings at the public hearings, or

(b) Modify the proposed boundaries in accordance with findings of the public hearings, and then ratify the revised boundaries.

If neither of the above actions are taken by the county legislative authority(ies) within six months, the boundaries as stated in the proposal submitted by the water utility coordinating committee to said county legislative authority(ies) shall be automatically ratified.

[Statutory Authority: RCW 43.70.040, 91-02-049 (Order 121), recodified as § 246-293-170, filed 12/27/90, effective 1/31/91. Statutory Authority: Chapter 70.116 RCW, 78-07-048 (Order 1309), § 248-56-600, filed 6/28/78.]

**WAC 246-293-180 Establishment of external critical water supply service area boundaries—Criteria.** (1) The water utility coordinating committee, in recommending, and county legislative authority(ies), in determining the location of external critical water supply service area boundaries shall consider factors including, but not limited to:

(a) Existing land use,

(b) Projected land use and permitted densities as documented in adopted county or city plans, ordinances and/or growth policies for at least 10 years into the future,

(c) Other planning activities or boundaries which may affect land use or water system planning,

(d) Physical factors limiting provision of water service,

(e) Existing political boundaries, including boundary agreements in effect and attitudes towards expanding those boundaries,

(f) Future service areas of existing utilities,

(g) Hydraulic factors, including potential pressure zones or elevations,

(h) Economic ability of the public water systems to meet minimum service requirements.

(2) External critical water supply service area boundaries shall not divide any purveyor's existing, contiguous service area. Areas served by a wholesale purveyor may be divided into as many existing service areas as may be justified by geography, engineering or other factors discussed in the preliminary assessment.

[Statutory Authority: RCW 43.70.040, 91-02-049 (Order 121), recodified as § 246-293-180, filed 12/27/90, effective 1/31/91. Statutory Authority: Chapter 70.116 RCW, 78-07-048 (Order 1309), § 248-56-610, filed 6/28/78.]

**WAC 246-293-190 Establishment of critical water supply service area boundaries—Effect.** (1) No new public water system shall be approved within a critical water supply service area subsequent to establishment of external boundaries unless specifically authorized by the department. Authorization shall be based upon compliance with the following:

(a) If unanticipated demand for water supply occurs within a purveyor's future service area, the following shall apply in the listed sequence:

(i) The existing purveyor shall provide service in a timely and reasonable manner consistent with state board of health regulations; or

(ii) A new public water system may be developed on a temporary basis. Before authorization, a legal agreement

will be required which includes a schedule for the existing purveyor to assume management and/or connect the new public water system to the existing system; or

(iii) A new public water system may be developed. Before authorization, a revised service area agreement establishing the new purveyor's future service area will be required.

(b) If a demand for water supply occurs outside any purveyor's future service area, the following shall apply in the listed sequence:

(i) Those persons anticipating the need for water service shall contact existing nearby purveyors within the critical water supply service area to determine whether any will be interested in expanding their system to provide water service in a timely and reasonable manner consistent with state board of health regulations.

(ii) A new public water system may be developed on a temporary basis. Before authorization, a legal agreement will be required which includes a schedule for an existing system to assume management and/or connect the new public water system to an existing system; or

(iii) A new public water system may be developed.

Any of the options listed in subdivisions (b)(i), (b)(ii), or (b)(iii) will require establishment of new or revised service area agreements.

(2) If a new public water system is developed, it shall have an approved water system plan pursuant to WAC 248-54-580 and the provisions of this chapter. The plan shall include a section addressing the outcome of subsections (1)(a), or (1)(b) along with documented confirmation by the appropriate existing purveyors(s).

(3) Any proposed new public water system shall not be inconsistent with local adopted land use plans, shoreline management programs, and/or development policies as determined by the appropriate county or city legislative authority(ies).

(4) If a coordinated water system plan has been approved for the affected area, all proposed new public water systems shall be consistent with the provisions of that plan.

[Statutory Authority: RCW 43.70.040. 91-02-049 (Order 121), recodified as § 246-293-190, filed 12/27/90, effective 1/31/91. Statutory Authority: Chapter 70.116 RCW. 78-07-048 (Order 1309), § 248-56-620, filed 6/28/78.]

**WAC 246-293-200 Alteration of external critical water supply service area boundaries.** (1) After establishment of external critical water supply service area boundaries, those boundaries may not be altered until the coordinated water system plan is completed.

(2) Alteration of external critical water supply service area boundaries may be initiated by the department or county legislative authority(ies) in accordance with the procedures and criteria identified in WAC 248-56-600 and 248-56-610. In addition:

(a) The department or county legislative authority(ies), whichever initiates alteration of external boundaries, shall prepare a brief report documenting the need for such alteration, and

(b) The department or county legislative authority(ies), whichever initiates preparation of the report, shall reconvene the water utility coordinating committee and present the

report to the committee, together with instructions for committee action.

(3) The coordinated water system plan shall be revised as necessary, due to alteration of external critical water supply service area boundaries, within six months of the date of such action taken by the county legislative authority(ies), unless an extended schedule is approved by the department.

[Statutory Authority: RCW 43.70.040. 91-02-049 (Order 121), recodified as § 246-293-200, filed 12/27/90, effective 1/31/91. Statutory Authority: Chapter 70.116 RCW. 78-07-048 (Order 1309), § 248-56-630, filed 6/28/78.]

**WAC 246-293-210 Update of external critical water supply service area boundaries.** External critical water supply service area boundaries shall be reviewed by the water utility coordinating committee and the county legislative authority(ies) at least once every five years, as part of the update of the coordinated water system plan. (See WAC 248-56-760.)

[Statutory Authority: RCW 43.70.040. 91-02-049 (Order 121), recodified as § 246-293-210, filed 12/27/90, effective 1/31/91. Statutory Authority: Chapter 70.116 RCW. 78-07-048 (Order 1309), § 248-56-640, filed 6/28/78.]

**WAC 246-293-220 Coordinated water system plan—Requirement.** (1) A coordinated water system plan shall be required for the entire area within the external critical water supply service area boundaries.

(2) In critical water supply service areas where more than one water system exists, a coordinated water system plan shall consist of either:

(a) A compilation of water system plans approved pursuant to WAC 248-54-580, together with supplementary provisions addressing water purveyor concerns relating to the entire critical water supply service area (fulfilling requirements of WAC 248-56-710 and 248-56-720 respectively), or

(b) A single plan covering all affected public water systems and areawide concerns within the external critical water supply service area boundaries (fulfilling requirements of both WAC 248-56-710 and 248-56-720).

(3) The coordinated water system plan shall provide for maximum integration and coordination of public water system facilities consistent with the protection and enhancement of the public health and well-being.

(4) The coordinated water system plan shall not be inconsistent with adopted county and city land use plans, ordinances, and/or growth policies addressing development within the critical water supply service area for at least five years beyond the date of establishment of external boundaries.

(5) If no land use plans, ordinances, or growth policies are in effect for all or a portion of the area within the critical water supply service area at the time the coordinated water system plan is being prepared, the coordinated water system plan shall be based upon the best planning data available from the appropriate local planning agency(ies).

(6) In critical water supply service areas where only one public water system exists, the coordinated water system plan shall consist of the water system plan for the water system. (See WAC 248-54-580 and 248-56-710.)

[Statutory Authority: RCW 43.70.040. 91-02-049 (Order 121), recodified as § 246-293-220, filed 12/27/90, effective 1/31/91. Statutory Authority:

Chapter 70.116 RCW. 78-07-048 (Order 1309), § 248-56-700, filed 6/28/78.]

**WAC 246-293-230 Coordinated water system plan—Water system plan.** (1) Each purveyor within the external critical water supply service area boundaries shall be responsible for completion of a water system plan for the purveyor's future service area, including provisions of WAC 248-56-730, if such a plan has not already been approved, with the following exception:

(a) Nonmunicipally owned public water systems shall be exempt from the planning requirements (except for the establishment of service area boundaries pursuant to WAC 248-56-730) if they:

- (i) Were in existence as of September 21, 1977; and
- (ii) have no plans for water service beyond their existing service area; and
- (iii) meet minimum state board of health requirements (chapter 248-54 WAC).

Note: If the county legislative authority permits a change in development that will increase the demand for water service of such a system beyond the existing system's ability to provide minimum water service, the purveyor shall develop a water system plan in accordance with this section.

(2) Each purveyors' water system plan shall be updated at the time the coordinated water system plan is prepared, which will eliminate the necessity of updating the water system plan prior to the mandatory five year update of the coordinated water system plan.

(3) The content of a water system plan shall be consistent with WAC 248-54-580 and shall comply with guidelines\* which may be obtained from the department. These guidelines have been compiled to further assist in meeting the purpose of this chapter, and address three levels of planning requirements varying in detail, based upon the size of the public water system.

[Statutory Authority: RCW 43.70.040. 91-02-049 (Order 121), recodified as § 246-293-230, filed 12/27/90, effective 1/31/91. Statutory Authority: Chapter 70.116 RCW. 78-07-048 (Order 1309), § 248-56-710, filed 6/28/78.]

**WAC 246-293-240 Coordinated water system plan—Supplementary provisions.** (1) All water purveyors within the external critical water supply service area boundaries (with the exception of the systems specifically exempted in WAC 248-56-710(1)) shall be notified and asked to participate in the development of the supplementary provisions.

(2) The supplementary provisions shall address areawide water system concerns relating to the entire critical water supply service area. The content of the supplementary provisions shall comply with guidelines\* which may be obtained from the department.

The supplementary provisions shall include, but not be limited to:

- (a) Assessment of related, adopted plans,
- (b) Identification of future service areas and service area agreements (WAC 248-56-730),
- (c) Minimum areawide water system design standards, including fireflow performance standards,
- (d) Procedures for authorizing new water systems in the critical water supply service area,

(e) Assessment of potential joint-use or shared water system facilities and/or management programs.

\*Copies of DSHS guidelines entitled, "Plan contents guidelines" may be obtained without charge from the Department of Social and Health Services, Water Supply and Waste Section, Mail Stop LD-11, Olympia, Washington 98504.

[Statutory Authority: RCW 43.70.040. 91-02-049 (Order 121), recodified as § 246-293-240, filed 12/27/90, effective 1/31/91. Statutory Authority: Chapter 70.116 RCW. 78-07-048 (Order 1309), § 248-56-720, filed 6/28/78.]

**WAC 246-293-250 Service area agreements—Requirement.** (1) The service area boundaries of public water systems within the critical water supply service area shall be determined by written agreement among the respective existing purveyors and approved by the appropriate legislative authority(ies).

(2) Future service area agreements shall be incorporated into the coordinated water system plan as provided for in the guidelines identified in WAC 248-56-720.

(3) Future service area boundaries of public water systems shall be determined by existing purveyors. Criteria used in the establishment of future service areas should include, but not be limited to: Topography, readiness and ability to provide water, local franchise areas, legal water system boundaries, city limits, future population, land use projections, and sewer service areas.

(4) All future service areas shall not be inconsistent with adopted land use plans, ordinances, and growth policies of cities, towns, and counties, located within the future service area boundaries.

(5) Failure of the legislative authority(ies) to file with the department objections to service area agreements within 60 days of receipt of the agreement shall indicate automatic approval.

(6) If no service area boundary agreement has been established after a conscientious effort by the purveyors within one year of establishment of the external critical water supply service area boundaries, or if the legislative authority(ies) has filed with the department objections in writing, the department shall hold a public hearing.

(7) If a public hearing is required for the establishment of service areas the following procedures shall apply:

(a) The department shall provide notice of the hearing by certified mail to:

- (i) Each purveyor providing service in the critical water supply service area,
- (ii) Each county legislative authority having jurisdiction in the area, and

(iii) The public pursuant to chapter 65.16 RCW.

(b) The hearing may be continued from time to time.

(c) At the termination of the public hearing, the department may restrict the expansion of service of any purveyor within the external critical water supply service area boundaries if the department finds such restriction necessary to provide the greatest protection of the public health and well-being. (Individual retail or direct service connections shall not be considered an expansion.)

[Statutory Authority: RCW 43.70.040. 91-02-049 (Order 121), recodified as § 246-293-250, filed 12/27/90, effective 1/31/91. Statutory Authority: Chapter 70.116 RCW. 78-07-048 (Order 1309), § 248-56-730, filed 6/28/78.]

**WAC 246-293-260 Coordinated water system plan—Procedures (water utility coordinating committee).**

(1) Following establishment of external critical water supply service area boundaries, the water utility coordinating committee shall be responsible for the development of a coordinated water system plan.

(2) No later than two months after establishment of the external critical water supply service area boundary the water utility coordinating committee shall meet for the purpose of formulating arrangements for:

(a) Preparation of the coordinated water system plan, and

(b) Public involvement.

(3) The water utility coordinating committee shall meet as necessary in order to:

(a) Collect and assemble water system plans,

(b) Provide input and direction for the preparation of the supplementary provisions,

(c) Serve as a forum for developing and/or negotiating future service area agreements (WAC 248-56-730),

(d) Accomplish other related business as determined by the committee.

(4) Prior to submittal of the coordinated water system plan to the county legislative authority(ies) for review, the water utility coordinating committee shall:

(a) Prepare written comments on the plan for the benefit of the reviewing authority(ies),

(b) Conduct at least one public informational meeting for the purpose of soliciting public input,

(c) Evaluate and respond to comments received at the hearing(s).

[Statutory Authority: RCW 43.70.040. 91-02-049 (Order 121), recodified as § 246-293-260, filed 12/27/90, effective 1/31/91. Statutory Authority: Chapter 70.116 RCW. 78-07-048 (Order 1309), § 248-56-740, filed 6/28/78.]

**WAC 246-293-270 Coordinated water system plan—Effect.**

(1) All purveyors constructing or proposing to construct public water system facilities within the area covered by the coordinated water system plan shall comply with the plan.

(2) At any time after two years of establishment of the external critical water supply service area boundaries, the department may deny proposals to establish or to expand any public water system within a critical water supply service area for which there is not an approved coordinated water system plan. (Individual retail or direct service connections shall not be considered an expansion.) (See WAC 248-56-620 for provisions pertaining to new public water systems in the interim two years.)

[Statutory Authority: RCW 43.70.040. 91-02-049 (Order 121), recodified as § 246-293-270, filed 12/27/90, effective 1/31/91. Statutory Authority: Chapter 70.116 RCW. 78-07-048 (Order 1309), § 248-56-750, filed 6/28/78.]

**WAC 246-293-280 Coordinated water system plan—Update.**

(1) The coordinated water system plan shall be reviewed and updated by the water utility coordinating committee at a minimum of every five years or sooner, if the water utility coordinating committee feels it is necessary, in accordance with both the provisions of WAC 248-54-580 and this section.

[Title 246 WAC—page 520]

(2) Changes in the coordinated water system plan shall be accomplished in accordance with procedures for developing a coordinated water system plan (WAC 248-56-740). If no changes are necessary, the water utility coordinating committee shall submit to the department a statement verifying that the coordinated water system plan is still current.

(3) If the external critical water supply service area boundaries are altered by the county legislative authority(ies) pursuant to WAC 248-54-630, the coordinated water system plan shall be updated as provided for in WAC 248-56-630.

[Statutory Authority: RCW 43.70.040. 91-02-049 (Order 121), recodified as § 246-293-280, filed 12/27/90, effective 1/31/91. Statutory Authority: Chapter 70.116 RCW. 78-07-048 (Order 1309), § 248-56-760, filed 6/28/78.]

**WAC 246-293-290 Coordinated water system plan—Local review.**

(1) Prior to submission of a coordinated water system plan to the department for approval, the plan shall be reviewed by the county legislative authority(ies) in the county(ies) in which the critical water supply service area is located. County review of the coordinated water system plan shall include at least one public hearing.

(2) If no comments have been received from the county legislative authority(ies) within 60 days of receipt of the coordinated water system plan, the department may consider the plan for approval.

(3) If within 60 days of receipt of the coordinated water system plan, the county legislative authority(ies) find any segment of the plan to be inconsistent with adopted land use plans, shorelines master programs, the following shall occur:

(a) The county legislative authority(ies) shall submit written description of their determination and justification supporting their determination prior to the end of the 60 day period to the department and all affected parties.

(b) The county legislative authority(ies) shall make every effort to resolve any inconsistencies within 60 days of submittal of written justification.

(c) The department may approve those portions of the coordinated water system plan found not to be inconsistent with adopted plans and policies at any time after the initial determination by the county legislative authority(ies).

(d) If after the 60 day period established for resolution of inconsistencies an inconsistency still exists, the affected parties shall each present their final recommended alternative solution to the department. The department shall then review all alternative solutions and discuss its recommendations with the county(ies) and the water utility coordinating committee. If after two years of the declaration of the critical water supply service area the inconsistencies persist, the department may deny proposals to establish or to expand any public water system facilities which affect that portion of the critical water supply service area being contested.

[Statutory Authority: RCW 43.70.040. 91-02-049 (Order 121), recodified as § 246-293-290, filed 12/27/90, effective 1/31/91. Statutory Authority: Chapter 70.116 RCW. 78-07-048 (Order 1309), § 248-56-800, filed 6/28/78.]

**WAC 246-293-300 Coordinated water system plan—Department approval.**

(1) A coordinated water system plan shall be submitted to the department for design

approval within two years of the establishment of external critical water supply service area boundaries.

(a) In its review of the coordinated water system plan, the department shall ensure that every topic in the guidelines identified in WAC 248-56-720 has been covered to the extent necessary based on the size and nature of the water system(s) and characteristics of the critical water supply service area.

(b) The department shall not approve those portions of a coordinated water system plan which fail to meet the requirements for future service area boundaries pursuant to WAC 248-56-730.

(2) The department shall either approve the coordinated water system plan, or respond within 60 days from the date the plan is received.

[Statutory Authority: RCW 43.70.040. 91-02-049 (Order 121), recodified as § 246-293-300, filed 12/27/90, effective 1/31/91. Statutory Authority: Chapter 70.116 RCW. 78-07-048 (Order 1309), § 248-56-810, filed 6/28/78.]

**WAC 246-293-310 Severability.** If any provision of this chapter or its application to any person or circumstance is held invalid, the remainder of this chapter, or the application of the provision to other persons or circumstances, shall not be affected.

[Statutory Authority: RCW 43.70.040. 91-02-049 (Order 121), recodified as § 246-293-310, filed 12/27/90, effective 1/31/91. Statutory Authority: Chapter 70.116 RCW. 78-07-048 (Order 1309), § 248-56-900, filed 6/28/78.]

## PART II. RESOLUTION OF SERVICE AREA CONFLICTS

**WAC 246-293-401 Purpose.** The purpose of this chapter is to provide a process for resolving service area conflicts which arise from implementation of the Public Water System Coordination Act, chapter 70.116 RCW, and its procedural regulations, chapter 248-56 WAC.

[Statutory Authority: RCW 43.70.040. 91-02-049 (Order 121), recodified as § 246-293-401, filed 12/27/90, effective 1/31/91. Statutory Authority: RCW 74.116.070 [70.116.070]. 83-01-015 (Order 1919), § 248-59-005, filed 12/6/82.]

**WAC 246-293-420 Public hearing.** (1) If no service area boundary agreement has been established after a conscientious effort by existing water purveyors within one year of establishment of external critical water supply service area boundaries, or if the legislative authority or authorities have filed written objections with the department, the water supply and waste section of the department of social and health services (DSHS) shall work with the affected parties in an informal manner in order to reach an agreement.

(2) If, in the judgment of the water supply and waste section of DSHS, informal negotiations with the affected parties fail to make progress toward reaching an agreement, the water supply and waste section of DSHS shall hold a public hearing to determine its course of action.

(3) The water supply and waste section of DSHS shall provide at least thirty days' notice of the public hearing; thus, giving the affected parties a final opportunity to agree upon service area boundaries prior to the public hearing.

(4) Notice of the public hearing shall be mailed by certified mail to:

(a) Each purveyor providing service in the area of conflict;

(b) Each legislative authority having jurisdiction in the area; and

(c) The public pursuant to chapter 65.16 RCW.

[Statutory Authority: RCW 43.70.040. 91-02-049 (Order 121), recodified as § 246-293-420, filed 12/27/90, effective 1/31/91. Statutory Authority: RCW 74.116.070 [70.116.070]. 83-01-015 (Order 1919), § 248-59-010, filed 12/6/82.]

**WAC 246-293-430 Initial decision.** (1) The public hearing may be continued from time to time if good cause can be shown for such a continuance.

(2) After conclusion of the hearing, the water supply and waste section of DSHS may decide to take no action or restrict any or all purveyors from carrying out improvements within the conflicting area. Affected parties shall be notified of the decision by certified mail. The decision shall be issued as a written report and include justification based upon:

(a) Compliance with DSHS regulations;

(b) A record of the hearing; and

(c) Criteria established in WAC 248-56-730.

[Statutory Authority: RCW 43.70.040. 91-02-049 (Order 121), recodified as § 246-293-430, filed 12/27/90, effective 1/31/91. Statutory Authority: RCW 74.116.070 [70.116.070]. 83-01-015 (Order 1919), § 248-59-020, filed 12/6/82.]

## PART III. FIRE FLOW

**WAC 246-293-601 Purpose.** This chapter is promulgated pursuant to the authority granted in the Public Water System Coordination Act of 1977, chapter 70.116 RCW, for the purpose of establishing minimum performance standards related to fire protection, including provisions for their application and enforcement, and incorporating them into the design and construction of new and expanding public water systems.

[Statutory Authority: RCW 43.70.040. 91-02-049 (Order 121), recodified as § 246-293-601, filed 12/27/90, effective 1/31/91. Statutory Authority: RCW 70.116.080. 79-04-007 (Order 1378), § 248-57-010, filed 3/12/79.]

**WAC 246-293-602 Scope.** These standards and regulations shall apply to the following new and expanding public water systems:

(1) Those having more than 1,000 services. (See WAC 248-54-580.)

(2) Those with less than 1,000 services located within the boundaries of a critical water supply service area and subject to the requirement for a coordinated water system plan. (See WAC 248-54-580 and 248-56-700.)

Note: Public water systems in existence prior to September 21, 1977, which are owner operated and serve less than ten single family residences; serving no more than one industrial plant; or are nonmunicipally owned with no plans for water service beyond their existing service area are exempt from the planning requirement.

[Statutory Authority: RCW 43.70.040. 91-02-049 (Order 121), recodified as § 246-293-602, filed 12/27/90, effective 1/31/91. Statutory Authority: RCW 70.116.080. 79-04-007 (Order 1378), § 248-57-200, filed 3/12/79.]

**WAC 246-293-610 Definitions.** (1) "Public water system" - Any system or water supply intended or used for human consumption or other domestic uses including, but not limited to, source, treatment, storage, transmission and distribution facilities where water is furnished to any community, number of individuals, or is made available to the public for human consumption or domestic use. This definition shall exclude any water system serving one single family residence, water systems existing prior to September 21, 1977, which are owner operated and serve less than ten single family residences, and water systems serving no more than one industrial plant.

(2) "Expanding public water systems" - Those public water systems installing additions, extensions, changes, or alterations to their existing source, transmission, storage, or distribution facilities which will enable the system to increase in size its existing service area. New individual retail or direct service connections onto an existing distribution system shall not be considered an expansion of the public water system.

(3) "Department" - The Washington state department of social and health services.

(4) "Critical water supply service area" - A geographical area designated by the department or county legislative authority characterized by public water system problems related to inadequate water quality, unreliable service, and/or lack of coordinated water system planning. It may be further characterized by a proliferation of small, inadequate water systems, or by water supply problems which threaten the present or future water quality or reliability of service in such a manner that efficient and orderly development may best be achieved through coordinated planning by public water systems in the area in accordance with chapter 248-56 WAC.

(5) "Fire flow" - The rate of water delivery needed for the purpose of fighting fires in addition to requirements for normal domestic maximum instantaneous demand as referenced in guidelines published by the department entitled "Design standards for public water supplies."

(6) "Local fire protection authority" - The fire district, city, town, or county directly responsible for the fire protection within a specified geographical area.

(7) "Water system plan" - A document identifying present and future water system needs and establishing a program for meeting those needs in the most efficient manner possible, and consistent with other relevant plans and policies affecting the area in which the system is located. (See WAC 248-54-580, 248-56-710 and 248-56-720, and the plan content guidelines for a detailed description of water system plans.)

(8) "Existing service area" - A specific area within which direct service or retail service connections to customers of a public water system are currently available.

(9) "Future service area" - A specific area for which water service is planned by a public water system as determined by written agreement between purveyors. (See WAC 248-56-730.)

(10) "Planning jurisdiction" - The city, town, county or other entity acting as the responsible agency for preparation and adoption of land use plans, policies or standards affecting development.

(11) "Development classifications" - Specific geographical areas within the existing and future service area of a public water system, identified for the purpose of determining the appropriate level of fire protection.

[Statutory Authority: RCW 43.70.040. 91-02-049 (Order 121), recodified as § 246-293-610, filed 12/27/90, effective 1/31/91. Statutory Authority: RCW 70.116.080. 79-04-007 (Order 1378), § 248-57-100, filed 3/12/79.]

**WAC 246-293-620 Administration.** (1) The department shall administer these regulations through its ongoing review and approval of water system plans and engineering reports as provided for in WAC 248-54-580, 248-54-590, and 248-56-810.

(2) In the event that plans and specifications for water system improvements are submitted to the department for approval under WAC 248-54-600 and the design of the proposed improvements is inconsistent with development classifications identified in the water system plan, (see WAC 248-57-400) the department shall not approve the plans and specifications.

(3) Plans and specifications for water system improvements (see WAC 248-54-600) proposed within those cities, towns, or counties which operate under local fire flow standards shall include written confirmation that they meet the requirements of adopted local standards from the authority administering those standards. (See WAC 248-57-900.)

[Statutory Authority: RCW 43.70.040. 91-02-049 (Order 121), recodified as § 246-293-620, filed 12/27/90, effective 1/31/91. Statutory Authority: RCW 70.116.080. 79-04-007 (Order 1378), § 248-57-300, filed 3/12/79.]

**WAC 246-293-630 Application.** (1) Water system plans prepared by those public water systems identified in WAC 248-57-200 shall include a section in their plans addressing fire flow, hydrant and system reliability standards in accordance with WAC 248-57-500, 248-57-600, and 248-57-700 respectively. The section shall include a map entitled development classifications consistent with the following:

(a) The map shall delineate the existing and future service area of the water system into the following categories:

(i) Rural - lot sizes greater than one acre (including parks, open space, agricultural lands, etc.)

(ii) Residential - lot sizes one acre or less, (including all single and multi-family structures less than 4000 square feet, and mobile home and recreational vehicle parks)

(iii) Commercial and multi-family residential structures with a floor area 4000 square feet or greater.

(iv) Industrial

(b) Assignment of the above categories shall be based upon:

(i) Existing development, and

(ii) Future development for a minimum of ten years as identified in proposed or adopted land use plans and policies applicable within the existing and future service area.

(c) The development classifications outlined in (a) above shall be determined by any method acceptable to the planning jurisdiction(s), provided that the criteria used is consistent within a given critical water supply service area.

(2) The water system plan shall identify and schedule improvements needed in order for the water system to be



capable of supplying required fire flow for new and expanding public water systems consistent with these regulations.

[Statutory Authority: RCW 43.70.040, 91-02-049 (Order 121), recodified as § 246-293-630, filed 12/27/90, effective 1/31/91. Statutory Authority: RCW 70.116.080, 79-04-007 (Order 1378), § 248-57-400, filed 3/12/79.]

**WAC 246-293-640 Minimum standards for fire flow.** (1) City, town, or county legislative authority shall set minimum fire flows where local standards are adopted under WAC 248-57-900.

(2) Where local standards are not adopted under WAC 248-57-900, Table 1 shall identify minimum fire flows. Contact with the county and local fire protection authority shall be made before applying these standards in a water system plan or to design of individual development.

**TABLE 1**  
**MINIMUM FIRE FLOWS\***

Development Classification	Minimum Fire Flow Requirement
(as described under WAC 248-57-400)	
Rural	None
Residential	500 gallons per minute for 30 minutes
Commercial and multifamily structures greater than 4000 sq. ft.	750 gallons per minute for 60 minutes**
Industrial	1000 gallons per minute for 60 minutes**

\* Minimum flows are in addition to requirements for normal domestic maximum use.

\*\* Commercial and industrial buildings may be subject to higher flow requirements when evaluated on an individual basis by the local fire protection authority.

Note: Minimum standards in most cases require less flow than categories in the guidelines published by the Insurance Services Office (Municipal Survey Service, 160 Water Street, New York, New York 10038) and therefore may not result in lower insurance rates.

[Statutory Authority: RCW 43.70.040, 91-02-049 (Order 121), recodified as § 246-293-640, filed 12/27/90, effective 1/31/91. Statutory Authority: Chapter 70.116 RCW, 89-16-065 (Order 2840), § 248-57-500, filed 7/31/89, effective 8/31/89. Statutory Authority: RCW 70.116.080, 79-04-007 (Order 1378), § 248-57-500, filed 3/12/79.]

**WAC 246-293-650 Minimum standards for fire hydrants.** (1) In those areas where minimum fire flow requirements must be met, fire hydrants shall be provided in accordance with WAC 248-57-600. If phased installation of water facilities are approved by the department, fire hydrants do not need to be installed until source, storage, and transmission capacity needed to meet the minimum flow requirements are operational: *Provided*, That in such instances a "T" shall be installed every 900 feet where fire hydrants will be located.

(2) Fire hydrants shall be located at roadway intersections wherever possible and the distance between them shall be no further than 900 feet.

(3) All fire hydrants shall conform to American Water Works Association specifications for dry barrel fire hydrants. Each hydrant shall have at least two hose connections of 2 1/2" diameter each and one pumper connection. All connections must have national standard threads or other connection

devices consistent with local fire protection authority requirements.

(4) Fire hydrants shall be installed plumb and be set to the finished grade. The bottom of the lowest outlet of the hydrant shall be no less than eighteen inches above the grade. There shall be thirty-six inches of clear area about the hydrant for operation of a hydrant wrench on the outlets and on the control valve. The pumper port shall face the most likely route of approach of the fire truck as determined by the local fire protection authority.

(5) Fire hydrants shall be located so as to be accessible by fire engines and not be obstructed by any structure or vegetation or have the visibility impaired for a distance of fifty feet in the direction of vehicular approach to the hydrant. Fire hydrants subject to vehicle damage (e.g., such as those located in parking lots) shall be adequately protected.

(6) Provisions shall be made to drain fire hydrant barrels to below the depth of maximum frost penetration.

(7) Out of service fire hydrants shall be repaired as soon as possible.

(8) Public water systems are encouraged to enter into contracts with local fire protection authorities to insure proper maintenance of fire hydrants.

[Statutory Authority: RCW 43.70.040, 91-02-049 (Order 121), recodified as § 246-293-650, filed 12/27/90, effective 1/31/91. Statutory Authority: RCW 70.116.080, 79-04-007 (Order 1378), § 248-57-600, filed 3/12/79.]

**WAC 246-293-660 Minimum standards for system reliability.** (1) The public water system shall be capable of supplying minimum fire flows either by gravity, or under the following conditions where fire flows are supplied by pumping:

(a) The largest pump out of service at any pumping level,

(b) The highest capacity treatment unit out of service, while maintaining minimum acceptable standards of water quality.

(c) A power outage in effect, unless the appropriate power utility(ies) records indicate a low incidence of electrical outage, defined as follows:

(i) Outages shall average three or less per year based on data for the three previous years with no more than six outages in a single year. Power must be lost for a minimum of 30 minutes in order to qualify as an "outage."

(ii) Outage duration shall average less than four hours based on data for the three previous years. Not more than one outage during the three previous year period shall have exceeded eight hours.

(2) In assessing system reliability, the department shall also give consideration to potential reliability hazards such as reservoir repair or cleaning and/or lack of parallel water transmission lines.

[Statutory Authority: RCW 43.70.040, 91-02-049 (Order 121), recodified as § 246-293-660, filed 12/27/90, effective 1/31/91. Statutory Authority: RCW 70.116.080, 79-04-007 (Order 1378), § 248-57-700, filed 3/12/79.]

**WAC 246-293-670 Alternate methods.** Fire protection may be provided by means other than those discussed in these regulations, provided that such alternate methods are



fully documented in the water system plan and approved by both the local fire protection authority and the department.

[Statutory Authority: RCW 43.70.040, 91-02-049 (Order 121), recodified as § 246-293-670, filed 12/27/90, effective 1/31/91. Statutory Authority: RCW 70.116.080, 79-04-007 (Order 1378), § 248-57-800, filed 3/12/79.]

**WAC 246-293-680 Local standards.** (1) Where standards in these regulations do not fully meet the fire protection needs of a city, town or county, the appropriate city, town or county legislative authority may promulgate fire flow and system reliability performance standards applicable within their respective jurisdiction. Such standards shall be fully documented and provide at least equal performance and protection as the minimum requirements contained in these regulations.

(2) Standards established by local jurisdictions shall be submitted to the department for review, and approval if they at least meet the minimum level of protection required by these regulations.

(3) The city, town, or county which adopts local fire flow or system reliability standards shall be responsible for administering those standards.

[Statutory Authority: RCW 43.70.040, 91-02-049 (Order 121), recodified as § 246-293-680, filed 12/27/90, effective 1/31/91. Statutory Authority: RCW 70.116.080, 79-04-007 (Order 1378), § 248-57-900, filed 3/12/79.]

**WAC 246-293-690 Severability.** If any provision of the chapter or its application to any person or circumstance is held invalid, the remainder of this chapter or the application of the provision to other persons or circumstances, shall not be affected.

[Statutory Authority: RCW 43.70.040, 91-02-049 (Order 121), recodified as § 246-293-690, filed 12/27/90, effective 1/31/91. Statutory Authority: RCW 70.116.080, 79-04-007 (Order 1378), § 248-57-990, filed 3/12/79.]

## Chapter 246-294 WAC

### DRINKING WATER OPERATING PERMITS

#### WAC

246-294-001	Purpose.
246-294-010	Definitions.
246-294-020	Applicability.
246-294-030	Application process.
246-294-040	Operating permit categories.
246-294-050	Permit issuance.
246-294-060	Transfer of ownership.
246-294-070	Fees.
246-294-080	Public notification.
246-294-090	Enforcement.
246-294-100	Severability.

**WAC 246-294-001 Purpose.** The rules set forth in this chapter are adopted for the purpose of implementing the provisions of chapter 70.119A RCW and to assure that Group A water systems provide safe and reliable drinking water to the public in accordance with chapter 246-290 WAC, state board of health drinking water regulations.

[Statutory Authority: Chapter 70.119A RCW, 93-03-047 (Order 325), § 246-294-001, filed 1/14/93, effective 2/14/93.]

**WAC 246-294-010 Definitions.** Abbreviations:

EPA - Environmental Protection Agency

MCL - maximum contaminant level  
 NTNC - nontransient noncommunity  
 SMA - satellite system management agency  
 SNC - significant noncomplier  
 TNC - transient noncommunity  
 VOC - volatile organic chemical  
 WFI - water facilities inventory

"Community water system" means any Group A water system:

With fifteen or more services used by residents for one hundred eighty or more days within a calendar year, regardless of the number of people; or

Regularly serving twenty-five or more residents for one hundred eighty or more days within the calendar year, regardless of the number of services.

"Department" means the Washington state department of health.

"Group A water system" and "system" means a public water system:

With fifteen or more service connections, regardless of the number of people; or

Serving an average of twenty-five or more people per day for sixty or more days within a calendar year, regardless of the number of service connections.

"Maximum permissible level (MCL)" means the maximum permissible level of a contaminant in water the purveyor delivers to any public water system user, measured at the locations identified under WAC 246-290-300, Table 4.

"New Group A water system" means a system designed for fifteen or more services or to serve twenty-five or more people which:

The department has not acknowledged receipt of the form titled *Construction Report for Public Water System Projects* before the effective date of this chapter; or

Has been in existence but has not received department as-built approval or does not have a WFI on record with the department.

"Nonresident" means a person without a permanent home or without a home served by the system, such as travelers, transients, employees, students, etc.

"Nontransient noncommunity water system (NTNC)" means a Group A water system regularly serving twenty-five or more of the same nonresidents for one hundred eighty or more days within a calendar year.

"Owner" means any agency, subdivision of the state, municipal corporation, firm, company, mutual or cooperative association, institution, partnership, or person or any other entity, that holds as property, a public water system.

"Public water system" means any system, excluding a system serving only one single-family residence and a system with four or fewer connections all of which serve residences on the same farm, providing piped water for human consumption, including any collection, treatment, storage, or distribution facilities under control of the purveyor and used primarily in connection with the system; and collection or pretreatment storage facilities not under control of the purveyor but primarily used in connection with the system, including:

Any collection, treatment, storage, and distribution facilities under control of the purveyor and used primarily in connection with such system; and

Any collection or pretreatment storage facilities not under control of the purveyor which are primarily used in connection with such system.

"Resident" means an individual living in a dwelling unit served by a public water system.

"Satellite system management agency (SMA)" means a person or entity that is certified by the department to own and/or operate more than one public water system on a regional or county-wide basis, without the necessity for a physical connection between such systems.

"Service" means a connection to a public water system designed to serve a single-family residence, dwelling unit, or equivalent use. When the connection is a group home or barracks-type accommodation, two and one-half persons shall be equivalent to one service.

"Significant noncomplier (SNC)" means a Group A water system that is in violation of state drinking water rules and such violation or violations may present an immediate risk to the health of consumers.

"Transient noncommunity (TNC)" means a Group A water system:

Having fifteen or more services used less than one hundred eighty days within a calendar year; or

Serving twenty-five or more different nonresidents for sixty or more days within a calendar year; or

Serving twenty-five or more of the same nonresidents for sixty or more days, but less than one hundred eighty days within a calendar year; or

Serving twenty-five or more residents for sixty or more days, but less than one hundred eighty days within a calendar year.

"Water facilities inventory (WFI)" means the department form summarizing each public water system's characteristics.

[Statutory Authority: Chapter 70.119A RCW. 93-03-047 (Order 325), § 246-294-010, filed 1/14/93, effective 2/14/93.]

**WAC 246-294-020 Applicability.** Owners of all Group A water systems and owners of satellite system management agencies (SMAs) shall obtain an annual operating permit from the department for each system owned. The operating permit shall be valid until the next renewal date in accordance with WAC 246-294-050. Any change in ownership of the permitted system shall require a new permit in accordance with WAC 246-294-060.

[Statutory Authority: Chapter 70.119A RCW. 93-03-047 (Order 325), § 246-294-020, filed 1/14/93, effective 2/14/93.]

**WAC 246-294-030 Application process.** (1) No person may operate and no owner shall permit the operation of a Group A water system unless the owner annually submits an application along with the required fee to the department and the department has issued an operating permit to the system owner. Any owner operating a system or SMA may continue to operate until the department takes final action on granting or denying the operating permit, in accordance with WAC 246-294-050.

(2) The department shall begin the operating permit application process for the initial and succeeding years based on size and type of system as follows:

(a) During the first calendar quarter of each year - community water systems greater than or equal to five

hundred services and SMAs shall be sent operating permit applications;

(b) During the second calendar quarter of each year - community water systems less than five hundred services shall be sent operating permit applications;

(c) During the third calendar quarter of each year - nontransient noncommunity (NTNC) and transient noncommunity (TNC) water systems shall be sent operating permit applications; and

(d) During the fourth calendar quarter of each year - all remaining Group A water systems.

(3) In addition to the schedule outlined in subsection (2) of this section, new or revised operating permits shall be required when:

(a) The owner of a new Group A system receives all required department approvals relating to water system operation (see WAC 246-294-030(4)); or

(b) Ownership of a Group A system changes (see WAC 246-294-060).

(4) New Group A systems shall be sent operating permit applications at the time construction documents are submitted to the department for approval. The deadline for submitting the completed application and full payment to the department shall be the same date as:

(a) The *Construction Report for Public Water System Projects* required by WAC 246-290-040(2); or

(b) The as-built approval required by WAC 246-290-140(4).

(5) Initial and renewal applications shall be based on information from the most recent WFIs on file with the department, and sent to owners according to the phase-in schedule in subsection (2) of this section. In the case of a SMA, a complete list of systems owned, along with the corresponding system identification numbers, shall also be included with the application.

(6) Upon receipt of the application, the owner shall:

(a) Complete portions of the form which need completing;

(b) Ensure that information on the form is accurate; and

(c) Return the application to the department within seventy days of the department's mailing date, accompanied by the applicable fee.

(7) The application shall be signed by the owner or other legally authorized person:

(a) In the case of a corporation, by an authorized corporate officer;

(b) In the case of a partnership, by a general partner;

(c) In the case of a sole proprietorship, by the proprietor;

(d) In the case of a municipal or other public facility, by a legally authorized officer; or

(e) In the case of an association, by the head of the association or a person responsible for operation of the system.

(8) The applicable fee shall be in the form of a check or money order made payable to the "Department of Health" and mailed to Department of Health, Revenue Unit, P.O. Box 1099, Olympia, Washington 98507-1099, or such successor organization or address as designated by the department.

(9) Systems which do not return operating permit applications along with the required fee by the deadline specified shall:

- (a) Not be issued an operating permit;
- (b) Be subject to the enforcement provisions in WAC 246-294-090.

(10) An additional charge of ten percent or twenty-five dollars, whichever is greater, shall be added to the applicable fee listed in WAC 246-294-070 if the owner fails to return the completed application with applicable fee to the department within seventy days.

(11) The department shall review each submitted application to verify the information contained in the application. Any changes made on the application by the applicant shall result in updating the system's WFI and shall be reflected on the next renewal application.

(12) If after issuing an operating permit, the department determines that the permit holder has made false statements, the department may, in addition to taking other actions provided by law, revise both current and previously granted permit fee determinations and charge the owner accordingly.

(13) If the department discovers that an owner has been operating a system without an operating permit and such system is covered by the requirements of this chapter, the department may charge the owner an operating permit fee that is the total of the one-time five-dollar per service fee for new Group A water systems plus permit fees owed for each year, including late fees, since the effective date of this chapter.

[Statutory Authority: Chapter 70.119A RCW. 93-03-047 (Order 325), § 246-294-030, filed 1/14/93, effective 2/14/93.]

**WAC 246-294-040 Operating permit categories.**

(1) The department shall evaluate each system for placement into one of the categories listed in Table 1, except as noted in subsection (3)(d) of this section. Each permit issued shall clearly identify the category into which the system is placed. The department shall provide a determination of system adequacy and the reasons for this determination, to any person on request.

(2) The criteria used for evaluation may include, but not be limited to the following:

- (a) Whether the system is subject to an order under WAC 246-290-050, for one or more of the following:
  - (i) Failure to have approved construction documents; or
  - (ii) Stopping work on system improvements; or
  - (iii) Failure to meet pressure requirements; or
  - (iv) Failure to meet water treatment requirements; or
  - (v) Failure to have a certified water treatment plant operator; or
  - (vi) Failure to meet water quality maximum contaminant levels; or
  - (vii) Placement of a moratorium on the system.
- (b) Whether the system is in violation of any departmental order issued under WAC 246-290-050 or federal administrative order issued under §1414(g) of the Safe Drinking Water Act, 42 U.S.C. §300g-3(g);
- (c) Whether the system is confirmed by the department as an unresolved significant noncomplier (SNC). Unresolved shall mean any system which:

(i) The department determines has not returned to compliance;

(ii) Does not have a signed compliance agreement with the department; or

(iii) Has not been issued a departmental order under WAC 246-290-050.

(d) Whether the system has reached the maximum number of services allowed in the distribution system by department approval;

(e) Whether the system has complied with water system plan provisions of WAC 246-290-100;

(f) Whether the system has complied with the water system financial viability provisions of RCW 70.119A.100 and WAC 246-290-100 (4)(d);

(g) Whether the system has complied with operator certification provisions of chapter 246-292 WAC;

(h) Whether the system has complied with coliform and inorganic chemical monitoring provisions of WAC 246-290-300; and

(i) Whether the system has complied with inorganic chemical and volatile organic chemical MCLs in accordance with WAC 246-290-310.

(3) Operating permit categories shall be as follows:

(a) Category green. This category shall identify systems which are substantially in compliance with all the applicable criteria in subsection (2) of this section. Placement in this category shall result in:

- (i) Permit issuance without conditions; and
- (ii) Determination that the system is adequate.

(b) Category yellow. This category shall represent systems which are substantially in compliance with the applicable criteria in subsection (2)(a), (b), (c), and (d) of this section, but which do not satisfy one or more of the criteria in subsection (2)(e) through (i) of this section and any additional criteria as determined by the department. Placement in this category shall result in:

- (i) Permit issuance with conditions; and
- (ii) Determination that the system is adequate or inadequate, depending on the nature of noncompliance.

(c) Category red. This category shall represent systems which do not satisfy one or more of the criteria in subsection (2)(a), (b), (c), or (d) of this section. Such systems shall also be evaluated against subsection (2)(e) through (i) of this section and any additional criteria as determined by the department. Placement in this category shall mean that the system is inadequate and result in:

- (i) Permit issuance with conditions; or
- (ii) Permit denial with appropriate enforcement.

(d) Category blue. This category shall identify systems which the department has elected to evaluate at a later date. Placement in this category shall result in no conditions and no determination that the system is adequate until the system is evaluated.

TABLE 1  
OPERATING PERMIT CATEGORIES

Category	Basic Description	Response to Adequacy Requests	Conditions
Green	Substantial Compliance	Yes	No

Yellow	Conditional Compliance	Yes or No <sup>1</sup>	Yes
Red	Substantial Noncompliance	No	Yes
Blue	Undetermined	(Will be evaluated at a later date)	

<sup>1</sup> Response will be determined on a case-by-case basis for each system and shall depend on the nature of noncompliance.

[Statutory Authority: Chapter 70.119A RCW. 93-03-047 (Order 325), § 246-294-040, filed 1/14/93, effective 2/14/93.]

**WAC 246-294-050 Permit issuance.** (1) The department shall grant or deny the operating permit within one hundred twenty days of receipt of the completed application and full payment.

(2) Issuance of an operating permit shall mean that the owner may operate the permitted system until the date specified on the permit unless protection of the public health, safety, and welfare requires immediate response or the imposition of conditions.

(3) At the time of permit issuance, the department may impose such permit conditions and compliance schedules as the department determines are reasonable and necessary to ensure that the system will provide safe and reliable drinking water, including, but not limited to, conditions necessary to ensure that the system is brought into compliance with the provisions of chapter 246-290 WAC.

(4) The department may modify an operating permit at any time based on review of the evaluation criteria in WAC 246-294-040(2). When modification occurs, a revised permit with the same expiration date will be sent to the owner. The appropriate local jurisdiction shall also be notified of the change in status.

(5) The department may revoke an operating permit or deny an operating permit application if the department determines that the system operation constitutes or would constitute a public health hazard to consumers.

(6) The department shall follow the steps outlined in RCW 43.70.115 when taking action to deny, condition, modify, or revoke an operating permit.

(7) An applicant for an operating permit shall be entitled to file an appeal in accordance with chapter 34.05 RCW if the department denies, conditions, modifies, or revokes the operating permit. To appeal, the owner shall file in writing with the department in a manner that shows proof of receipt within twenty-eight days of the applicant's receipt of the adverse notice.

The appeal shall state:

- (a) The issue or issues and law involved; and
- (b) The grounds for contesting the department decision.

(8) Any owner that requests a hearing under chapter 34.05 RCW may continue to operate the system until a final departmental decision is issued, unless protection of the public health, safety, and welfare requires summary action.

[Statutory Authority: Chapter 70.119A RCW. 93-03-047 (Order 325), § 246-294-050, filed 1/14/93, effective 2/14/93.]

**WAC 246-294-060 Transfer of ownership.** (1) A prospective new owner of a Group A water system shall not take possession of the system without first obtaining a new operating permit.

(2) The prospective new owner shall secure department approval of a new, updated, or altered water system plan as required by WAC 246-290-100 (2)(e) before the new permit is issued. The water system plan required under WAC 246-290-100 shall be prepared with special emphasis on sections dealing with implications of the change of ownership.

(3) The department shall send an application to the prospective new owner at the time the department is notified of transfer of ownership in accordance with WAC 246-290-430(1). The new owner shall proceed with the permit process in accordance with WAC 246-294-030, except the deadline for submitting the completed application to the department shall be the same date the water system plan is submitted for department approval.

(4) The department shall not charge a fee for a new permit resulting from a change in ownership. The permit shall be effective from the date of issuance by the department until the next scheduled permit renewal date, at which time a fee shall be charged.

(5) Change of ownership operating permit requirements of this section affect the prospective owner, and shall be in addition to the continuity of service requirements of WAC 246-290-430 affecting the owner transferring the system.

[Statutory Authority: Chapter 70.119A RCW. 93-03-047 (Order 325), § 246-294-060, filed 1/14/93, effective 2/14/93.]

**WAC 246-294-070 Fees.** (1) The fees for Group A water system operating permits shall be as indicated in Table 2.

TABLE 2  
OPERATING PERMIT FEES

Classification	Fee
0 - 14 services	None
15 - 49 services	\$25.00 per year
50 - 3,333 services	\$1.50 per service per year
3,334 - 53,333 services	\$4,999.50 + .10 per service over 3,333 services per year
53,334 or more services	\$10,000.00 per year
Satellite System Management Agency (based on total services in all systems owned by SMA)	\$1.00 per service per year or the fee from the appropriate category above, whichever is less
New Group A water system	One-time charge of \$5.00 per service
Late charge	Additional 10% of applicable charge stated above or \$25.00, whichever is greater

(2) For NTNC and TNC systems, owners shall pay the applicable fee from Table 2 based on equivalent number of services. Population information used in calculating equivalent number of services shall come from the WFI. The following formulas shall be used in determining equivalent number of services:

(a) For NTNC divide the average population served each day by two and one-half; and

(b) For TNC divide the average population served each day by twenty-five.

(3) Where systems serve both resident and nonresident populations, the permit fee category shall be determined by adding the number of services and an equivalent for the nonresident population served.

(4) In addition to submitting an annual fee, all new Group A water systems shall be charged a one-time fee of five dollars for each service or equivalent, based on the department approved design or as-built approval (see WAC 246-294-030(4)).

(5) Any county or SMA assuming ownership of a Group A water system, or court appointed receiver of a Group A water system shall be exempt from the operating permit fee for a period of one year after the next renewal date.

[Statutory Authority: Chapter 70.119A RCW. 93-03-047 (Order 325), § 246-294-070, filed 1/14/93, effective 2/14/93.]

**WAC 246-294-080 Public notification.** An owner issued a category red operating permit shall notify the water system users in accordance with WAC 246-290-330 and shall include mandatory language contained in the department publication titled *Mandatory Language For Drinking Water Public Notification*. The mandatory language will be included with issuance of a category red operating permit, or may be obtained from the department on request by contacting the Division of Drinking Water, Airdustrial Center #3, P.O. Box 47822, Olympia, Washington 98504-7822.

[Statutory Authority: Chapter 70.119A RCW. 93-03-047 (Order 325), § 246-294-080, filed 1/14/93, effective 2/14/93.]

**WAC 246-294-090 Enforcement.** When any owner is out of compliance with these rules or any conditions identified on the operating permit, the department may initiate appropriate enforcement actions. These actions may include any one or combination of the following:

- (1) Issuance of informal letters instructing or requiring appropriate corrective measures; or
- (2) Issuance of a compliance schedule; or
- (3) Issuance of departmental orders requiring any person to apply for an operating permit as required by these rules and RCW 70.119A.110 or to comply with any conditions or requirements imposed as part of an operating permit; or
- (4) Issuance of civil penalties for up to five thousand dollars per day per violation for failure to comply with departmental orders issued in accordance with subsection (3) of this section; or

(5) Legal action by the attorney general or local prosecutor.

[Statutory Authority: Chapter 70.119A RCW. 93-03-047 (Order 325), § 246-294-090, filed 1/14/93, effective 2/14/93.]

**WAC 246-294-100 Severability.** If any provision of this chapter or its application to any person or circumstances is held invalid, the remainder of this chapter, or the application of the provision to other persons or circumstances, shall not be affected.

[Statutory Authority: Chapter 70.119A RCW. 93-03-047 (Order 325), § 246-294-100, filed 1/14/93, effective 2/14/93.]

## Chapter 246-295 WAC

### SATELLITE SYSTEM MANAGEMENT AGENCIES

#### WAC

246-295-001	Purpose.
246-295-010	Definitions.
246-295-020	Applicability.
246-295-030	Potential satellite management agencies (SMAs).
246-295-040	SMA submittal and approval process.
246-295-050	SMA plan content for ownership.
246-295-060	SMA plan content for management and operation only.
246-295-070	Requests for water service.
246-295-080	Management and operations agreements.
246-295-090	Periodic review.
246-295-100	SMA compliance.
246-295-110	Special provisions.
246-295-120	Fees.
246-295-130	Severability.

**WAC 246-295-001 Purpose.** (1) The purpose of these rules is to:

(a) Establish criteria for approving satellite system management agencies hereafter referred to as satellite management agencies (SMAs) pursuant to RCW 70.116.134;

(b) Delineate the process organizations and/or individuals must follow to be considered an approved SMA; and

(c) Outline procedures for coordination between water users, purveyors, SMAs, local government and the department.

(2) This chapter is specifically designed to ensure:

(a) The enhancement of public health through the use of SMAs;

(b) SMAs are capable of providing high quality drinking water in a reliable manner and in a quantity suitable for intended use;

(c) SMAs are capable of meeting the requirements of the federal Safe Drinking Water Act, P.L. 93-523 and P.L. 99-339; and

(d) Uniformity in the SMAs determination and compliance processes.

(3) Other statutes relating to this chapter are:

(a) Chapter 43.20 RCW, State board of health;

(b) RCW 43.20B.020 Fees for services—Department of health and department of social and health services;

(c) Chapter 43.70 RCW, Department of health;

(d) Chapter 70.116 RCW, Public Water System Coordination Act of 1977;

(e) Chapter 70.119 RCW, Public water supply systems—Certification and regulation of operators; and

(f) Chapter 70.119A, Public water systems—Penalties and compliance.

[Statutory Authority: RCW 70.116.134. 94-18-108, § 246-295-001, filed 9/6/94, effective 10/7/94.]

**WAC 246-295-010 Definitions.** Abbreviations:

"IOU" - Investor owned utility;

"SMA" - Satellite management agency;

"UTC" - Utilities and transportation commission; and

"WSP" - Water system plan.

"Certified operator" means a person certified in accordance with chapter 246-292 WAC.

"Contract" means a written agreement between a SMA and a public water system identifying the responsibilities of system operation and management.

"Department" means the Washington state department of health.

"Investor owned utility" means a corporation, company, association, joint stock association, partnership and person, their lessees, trustees or receivers appointed by any court whatsoever, owning, controlling, operating or managing any public water system for hire.

"Public water system" means any system, excluding a system serving only one single-family residence and a system with four or fewer connections all of which serve residences on the same farm, providing piped water for human consumption, including any:

Collection, treatment, storage, or distribution facilities under control of the purveyor and used primarily in connection with such system; and

Collection or pretreatment storage facilities not under control of the purveyor primarily used in connection with such system.

"Purveyor" means an agency, subdivision of the state, municipal corporation, firm, company, mutual or cooperative association, institution, partnership, or person or other entity owning or operating a public water system. Purveyor also means the authorized agents of such entities.

"Satellite management agency (SMA)" means an individual, purveyor, or entity that is approved by the secretary to own or operate more than one public water system on a regional or county-wide basis, without the necessity for a physical connection between such systems.

"Satellite management and operation services" means all day-to-day responsibilities of a water system. Management responsibilities shall include planning and policy decision making. Operational responsibilities shall include normal day-to-day operations, preventative maintenance, water quality monitoring, troubleshooting, emergency response, response to complaints, public/press contact, and recordkeeping.

"Secretary" means the secretary of the department of health or their designee.

"Service area" means a specific area for which satellite management and operation services may be provided by a SMA.

"Service area policies" means pertinent policies that impact the provision of water and water system growth.

[Statutory Authority: RCW 70.116.134. 94-18-108, § 246-295-010, filed 9/6/94, effective 10/7/94.]

**WAC 246-295-020 Applicability.** The rules of this chapter shall apply to SMAs and all counties, and to public water system purveyors, individuals, or other entities requesting SMA approval.

[Statutory Authority: RCW 70.116.134. 94-18-108, § 246-295-020, filed 9/6/94, effective 10/7/94.]

**WAC 246-295-030 Potential satellite management agencies (SMAs).** (1) Pursuant to RCW 70.116.134(2), each county shall identify and submit a list of potential SMAs to the department by January 1, 1995, for areas within the county:

(a) Which are not within a designated future service area of any utility pursuant to the Water System Coordination Act; or

(b) Where an existing purveyor has agreed or where a legal determination has been made that an existing purveyor is unable or unwilling to provide service.

(2) After January 1, 1995, counties may submit names of additional potential SMAs to the department on an ongoing basis.

[Statutory Authority: RCW 70.116.134. 94-18-108, § 246-295-030, filed 9/6/94, effective 10/7/94.]

**WAC 246-295-040 SMA submittal and approval process.** (1) An individual, purveyor or other entity seeking approval as a SMA, shall:

(a) Submit a notice of intent to become an approved SMA to the department on a form provided by the department;

(b) Participate in a "presubmittal conference" to discuss the SMA plan content, and, if applicable, the water system plan;

(c) Submit a SMA application and plan which shall include all information required under WAC 246-295-050 or 246-295-060 at the level of detail agreed upon at the presubmittal conference.

(2) The department shall forward the SMA plan to affected counties for review and comment. To ensure consideration, the county must submit its comments to the department within sixty days.

(3) When all conditions listed in subsection (1) of this section have been completed, the secretary shall either approve or deny the proposed SMA based on the secretary's review and evaluation of information presented and comments received from the county.

(4) The secretary shall maintain a list of approved SMAs and make it available to counties, purveyors, individuals or other entities on request. A listing shall be distributed to each county at least annually and on approval of new SMAs by the secretary. The approved listing shall include a service area for each SMA and designate which SMAs are approved for:

(a) Ownership; and

(b) Management and operation only.

[Statutory Authority: RCW 70.116.134. 94-18-108, § 246-295-040, filed 9/6/94, effective 10/7/94.]

**WAC 246-295-050 SMA plan content for ownership.** The SMA plan shall address the following elements at a minimum in a manner acceptable to the department. A department guideline titled *Satellite Management Planning Handbook* is available to assist the potential SMA in adequately addressing these elements:

(1) SMA ownership, including at a minimum:

(a) A statement of intent to own public water systems;

(b) Current organizational structure of the SMA, legal authority, mailing address, responsible party, and contact person;

(c) Identification of existing public water systems the applicant currently owns, and/or manages and operates. The identification shall include the number of connections in each system, the department identification number and the system location.

(d) Documentation showing that at least one staff person has, at a minimum, three years of water utility ownership and/or management experience.

(2) SMA service area information, including at a minimum:

(a) A map of the SMA service area;

(b) A general written description of the SMA service area; and

(c) Future service area agreement(s) of systems owned by SMA if applicable.

(3) Service area policies/conditions of service where applicable, including at a minimum:

(a) Annexation policies consistent with local comprehensive plans;

(b) Ownership versus management and operation decision criteria;

(c) Policies related to new and existing public water systems, including the method of determining financial feasibility of adding new or existing systems to the SMA;

(d) Ordinances, resolutions and agreements related to the provision of drinking water;

(e) Service request process overview flowchart, including time frames; and

(f) A list of available services.

(4) System design standards for new and existing systems;

(5) Financial viability, including at a minimum:

(a) A written description of available revenue sources;

(b) A budget; and

(c) General financial policies.

(6) Operation and maintenance program, including at a minimum:

(a) Documentation that at least one staff person will, at a minimum, be certified at a water distribution manager 2 level or above and meet any additional department required certified operator requirements;

(b) Overall SMA routine and preventive maintenance program, including an emergency response plan;

(c) A copy of model contract for operation and maintenance services, if applicable; and

(d) Two copies of all applicable operations contracts in effect.

(7) Documentation from affected counties that the SMA plan is consistent with their plans and policies;

(8) Documentation that all Group A systems owned by the potential SMA on the date of request have obtained their operating permit and are not classified in the red operating permit category pursuant to chapter 246-294 WAC. If Group B systems are also owned by the potential SMA, provide documentation that such systems are in compliance with chapter 246-291 WAC. A special provision pursuant to WAC 246-295-110 may be utilized in the determination of compliance.

(9) Current water system plan(s) or department approved plan development schedule, if applicable.

[Statutory Authority: RCW 70.116.134. 94-18-108, § 246-295-050, filed 9/6/94, effective 10/7/94.]

**WAC 246-295-060 SMA plan content for management and operation only.** The SMA plan shall address the following elements at a minimum in a manner acceptable to

the department. A department guideline titled *Satellite Management Planning Handbook* is available to assist purveyors, individuals or other entities in adequately addressing these elements:

(1) SMA ownership, including at a minimum:

(a) A statement of intent to manage and operate public water systems;

(b) Current organizational structure of SMA, legal authority, mailing address, responsible party, and contact person;

(c) Documentation showing that at least one staff person has, at a minimum, three years of water utility ownership and/or management experience; and

(d) Identification of existing public water systems the applicant currently operates. The identification must include the number of connections in each system, the department identification number and the system location.

(2) SMA service area information, including at a minimum:

(a) A map of the SMA service area; and

(b) A general written description of the SMA service area.

(3) Conditions of service, including at a minimum:

(a) Operation decision criteria;

(b) Service request process overview flowchart including time frames; and

(c) A list of available services.

(4) Operation and maintenance program, including at a minimum:

(a) Documentation that at least one staff person will, at a minimum, be certified at a water distribution manager 2 level or above and meet any additional department required certified operator requirements;

(b) Overall SMA routine and preventive maintenance program, including an emergency response plan;

(c) A copy of the model contract for operation and maintenance services; and

(d) Two copies of all applicable operations contracts in effect.

(5) Documentation that all Group A systems managed and operated by the potential SMA on the date of request have obtained their operating permit and are not classified in the red operating permit category pursuant to chapter 246-294 WAC. If Group B systems are also managed and operated by the potential SMA, provide documentation that such systems are in compliance with chapter 246-291 WAC. A special provision pursuant to WAC 246-295-110 may be utilized in the determination of compliance.

[Statutory Authority: RCW 70.116.134. 94-18-108, § 246-295-060, filed 9/6/94, effective 10/7/94.]

**WAC 246-295-070 Requests for water service.** The county or city agency responsible for determining water availability shall direct an individual or other entity proposing a new system or requesting water service to contact one or more approved SMAs designated for the service area where the new system is proposed. Such contact shall take place prior to construction of a new public water system and shall be documented in writing to the appropriate county or city.



[Statutory Authority: RCW 70.116.134. 94-18-108, § 246-295-070, filed 9/6/94, effective 10/7/94.]

**WAC 246-295-080 Management and operations agreements.** (1) An SMA providing satellite management and operation services only shall have a written agreement with each public water system being served, which shall, at a minimum, address the necessary requirements to comply with applicable regulations regarding management and operation of a public water system; and

(2) The SMA shall submit two copies of all new and renewed agreements to the department within thirty days of the effective date of the contract.

[Statutory Authority: RCW 70.116.134. 94-18-108, § 246-295-080, filed 9/6/94, effective 10/7/94.]

**WAC 246-295-090 Periodic review.** The SMA shall ensure that a SMA plan is submitted to the department for review and approval every five years or more frequently as required by the secretary. The secretary shall review each approved SMA for compliance with the elements identified in WAC 246-295-050 and 246-295-060. The secretary may request that additional information be submitted to assist in the evaluation of the SMA.

[Statutory Authority: RCW 70.116.134. 94-18-108, § 246-295-090, filed 9/6/94, effective 10/7/94.]

**WAC 246-295-100 SMA compliance.** (1) A SMA:  
(a) Shall comply with all statutes and regulations governing public water systems including but not limited to chapters 70.116, 70.119 and 70.119A RCW and chapters 246-290, 246-291, 246-292, 246-293 and 246-294 WAC and the requirements of this chapter; and

(b) Shall adhere to its SMA plan.

(2) The department may revoke, suspend, modify or deny the certification or application of any SMA or applicant which:

(a) Fails to timely submit required information;

(b) Has been subject to departmental enforcement action for violation of statutes or regulations governing public water systems;

(c) Violates or has violated statutes or regulations governing public water systems;

(d) Fails to comply with its SMA plan;

(e) Fails to have or maintain required staff;

(f) Fails to comply with all applicable local ordinances, regulations, plans and policies;

(g) Fails to demonstrate financial viability whether at the time of application or subsequently;

(h) Fails to bring a noncomplying system into regulatory compliance within the time frame established under WAC 246-295-110; or

(i) Operates in a manner that threatens public health.

(3) Any SMA or applicant aggrieved by the department's decision to revoke, suspend, modify or deny their approval or application may appeal such decision in accordance with chapter 246-10 WAC and chapter 34.05 RCW.

(4) An approved SMA that files a timely appeal of a decision to revoke, suspend or modify its approval under chapter 246-10 WAC and/or chapter 34.05 RCW may continue to operate until a final departmental decision is

issued, unless protection of the public health, safety and welfare requires summary action.

(5) If a SMA is removed from the approved list and desires reinstatement, the SMA must submit a new notice of intent to become an approved SMA and follow the process outlined in WAC 246-295-040, provided that the reapplication shall be subject to any limitations imposed by final departmental order or if applicable, order on judicial review.

[Statutory Authority: RCW 70.116.134. 94-18-108, § 246-295-100, filed 9/6/94, effective 10/7/94.]

**WAC 246-295-110 Special provisions.** (1) SMAs willing to take ownership of systems which have not obtained their operating permit or are classified in the red operating permit category pursuant to chapter 246-294 WAC, may be allowed a "special provision" whereby they are given time to bring the system into regulatory compliance. This "special provision" is subject to an agreement among the SMA, the department and, if applicable, the public water system that documents how and within what time frame the SMA will bring the noncomplying system into compliance.

(2) Extensions to the time frame may be granted if agreed upon between the SMA and the secretary. If the agreed upon time frame passes and no extension has been granted, the system at issue shall remain out of compliance and the SMA shall be removed from the approved SMA list.

[Statutory Authority: RCW 70.116.134. 94-18-108, § 246-295-110, filed 9/6/94, effective 10/7/94.]

**WAC 246-295-120 Fees.** The secretary is authorized to assess reasonable fees to process applications for initial approval and for periodic review of SMAs.

[Statutory Authority: RCW 70.116.134. 94-18-108, § 246-295-120, filed 9/6/94, effective 10/7/94.]

**WAC 246-295-130 Severability.** If any provision of this chapter or its application to any person or circumstance is held invalid, the remainder of the chapter, or the application of the provision to other persons or circumstances, shall not be affected.

[Statutory Authority: RCW 70.116.134. 94-18-108, § 246-295-130, filed 9/6/94, effective 10/7/94.]

## Chapter 246-310 WAC CERTIFICATE OF NEED

### WAC

246-310-001	Purpose of certificate of need program.
246-310-010	Definitions.
246-310-020	Applicability of chapter 246-310 WAC.
246-310-035	Tertiary services identification.
246-310-040	Exemptions from requirements for a certificate of need for health maintenance organizations.
246-310-041	Exemption from requirements for a certificate of need for continuing care retirement communities' nursing home projects.
246-310-042	Rural hospital and rural health care facility exemptions from certificate of need review.
246-310-043	Exemption from requirements for a certificate of need for nursing home bed conversions to alternative use.
246-310-044	Exemption from requirements for a certificate of need for nursing home bed replacements.

246-310-050	Applicability determination.	246-310-030A	Tertiary services identification. [Statutory Authority: RCW 43.70.040. 91-02-049 (Order 121), recodified as § 246-310-030A, filed 12/27/90, effective 1/31/91. Statutory Authority: Chapter 70.38 RCW. 90-21-028 (Order 082), § 248-19-235, filed 10/9/90, effective 10/9/90.] Repealed by 92-02-018 (Order 224), filed 12/23/91, effective 1/23/92. Statutory Authority: RCW 70.38.135 and 70.38.919.
246-310-060	Sanctions for violations.		
246-310-080	Letter of intent.		
246-310-090	Submission and withdrawal of applications.		
246-310-100	Amendment of certificate of need applications.		
246-310-110	Categories of review.		
246-310-120	Concurrent review process.	246-310-070	Periodic reports on development of proposals. [Statutory Authority: RCW 43.70.040. 91-02-049 (Order 121), recodified as § 246-310-070, filed 12/27/90, effective 1/31/91. Statutory Authority: RCW 70.38.135. 86-06-030 (Order 2344), § 248-19-260, filed 2/28/86; 81-09-012 (Order 210), § 248-19-260, filed 4/9/81, effective 5/20/81. Statutory Authority: Chapter 70.38 RCW. 79-12-079 (Order 188), § 248-19-260, filed 11/30/79.] Repealed by 96-24-052, filed 11/27/96, effective 12/28/96. Statutory Authority: Chapter 70.38 RCW.
246-310-130	Nursing home concurrent review cycles.		
246-310-132	Open heart surgery concurrent review cycle.		
246-310-135	Ethnic minority nursing home bed pool—Procedures.		
246-310-136	Ethnic minority nursing home bed pool— Considerations for review of applications.	246-310-250	Open heart surgery. [Statutory Authority: RCW 70.38.135 and 70.38.919. 92-02-018 (Order 224), § 246-310-250, filed 12/23/91, effective 1/23/92. Statutory Authority: RCW 43.70.040. 91-02-049 (Order 121), recodified as § 246-310-250, filed 12/27/90, effective 1/31/91. Statutory Authority: Chapter 70.38 RCW. 90-13-116 (Order 67), § 248-19-600, filed 6/21/90, effective 7/1/90.] Repealed by 92-12-015 (Order 274), filed 5/26/92, effective 6/26/92. Statutory Authority: RCW 70.38.135(3).
246-310-140	Emergency review process.		
246-310-150	Expedited review process.		
246-310-160	Regular review process.	246-310-350	Nursing home and continuing care retirement community definitions. [Statutory Authority: RCW 70.38.135 and 70.38.919. 92-02-018 (Order 224), § 246-310-350, filed 12/23/91, effective 1/23/92. Statutory Authority: RCW 43.70.040. 91-02-049 (Order 121), recodified as § 246-310-350, filed 12/27/90, effective 1/31/91. Statutory Authority: RCW 70.38.919. 90-12-071 (Order 062), § 248-19-800, filed 6/1/90, effective 7/1/90.] Repealed by 96-24-052, filed 11/27/96, effective 12/28/96. Statutory Authority: Chapter 70.38 RCW.
246-310-170	Notification of beginning of review.		
246-310-180	Public hearings.		
246-310-190	Ex parte contacts.		
246-310-200	Bases for findings and action on applications.	246-310-400	AIDS long-term care pilot facility review standards. [Statutory Authority: RCW 70.38.135 and 70.38.919. 92-02-018 (Order 224), § 246-310-400, filed 12/23/91, effective 1/23/92. Statutory Authority: RCW 43.70.040. 91-02-049 (Order 121), recodified as § 246-310-400, filed 12/27/90, effective 1/31/91. Statutory Authority: RCW 70.38.919. 90-12-072 (Order 063), § 248-19-840, filed 6/1/90, effective 7/1/90.] Repealed by 96-24-052, filed 11/27/96, effective 12/28/96. Statutory Authority: Chapter 70.38 RCW.
246-310-210	Determination of need.		
246-310-220	Determination of financial feasibility.		
246-310-230	Criteria for structure and process of care.		
246-310-240	Determination of cost containment.		
246-310-260	Kidney transplantation.		
246-310-261	Open heart surgery standards and need forecasting method.		
246-310-262	Nonemergent interventional cardiology standard.		
246-310-270	Ambulatory surgery.		
246-310-280	Kidney disease treatment centers.		
246-310-360	Nursing home bed need method.		
246-310-370	Nursing home bed need method revision.		
246-310-380	Nursing home bed need standards.		
246-310-390	Nursing home bed need adjustments.		
246-310-395	Nursing home bed banking for alternative use notice requirements.		
246-310-396	Nursing home bed banking requirements for full facility closure.		
246-310-397	Nursing home bed replacement notice requirements.		
246-310-410	Swing bed review standards.		
246-310-470	Review and action on health maintenance organization projects.		
246-310-480	Projects proposed for the correction of deficiencies.		
246-310-490	Written findings and actions on certificate of need applications.		
246-310-500	Issuance, suspension, denial, revocation, and transfer of a certificate of need.		
246-310-560	Provision for reconsideration decision.		
246-310-570	Circumstances for which an amended certificate of need is required.		
246-310-580	Validity and extensions.		
246-310-590	Monitoring of approved projects.		
246-310-600	Withdrawal of a certificate of need.		
246-310-610	Adjudicative proceeding.		
246-310-620	Certificate of need program reports.		
246-310-630	Public access to records.		
246-310-900	Capital expenditure minimum adjustment procedures.		
246-310-990	Certificate of need review fees.		

#### DISPOSITION OF SECTIONS FORMERLY CODIFIED IN THIS CHAPTER

246-310-002	Purpose of chapter 248-156 WAC. [Statutory Authority: RCW 43.70.040. 91-02-049 (Order 121), recodified as § 246-310-002, filed 12/27/90, effective 1/31/91. Statutory Authority: RCW 70.38.025. 81-09-060 (Order 1641), § 248-156-010, filed 4/20/81.] Repealed by 92-02-018 (Order 224), filed 12/23/91, effective 1/23/92. Statutory Authority: RCW 70.38.135 and 70.38.919.
246-310-030	Index and procedures for adjustment. [Statutory Authority: RCW 43.70.040. 91-02-049 (Order 121), recodified as § 246-310-030, filed 12/27/90, effective 1/31/91. Statutory Authority: RCW 70.38.025. 81-09-060 (Order 1641), § 248-156-030, filed 4/20/81.] Repealed by 92-02-018 (Order 224), filed 12/23/91, effective 1/23/92. Statutory Authority: RCW 70.38.135 and 70.38.919.

#### WAC 246-310-001 Purpose of certificate of need program. The purpose of the certificate of need program has been established by the legislature in RCW 70.38.015.

[Statutory Authority: RCW 43.70.040. 91-02-049 (Order 121), recodified as § 246-310-001, filed 12/27/90, effective 1/31/91. Statutory Authority: RCW 70.38.135. 86-06-030 (Order 2344), § 248-19-210, filed 2/28/86; 81-09-012 (Order 210), § 248-19-210, filed 4/9/81, effective 5/20/81. Statutory Authority: Chapter 70.38 RCW. 79-12-079 (Order 188), § 248-19-210, filed 11/30/79.]

**WAC 246-310-010 Definitions.** For the purposes of chapter 246-310 WAC, the following words and phrases shall have the following meanings unless the context clearly indicates otherwise.

"Acute care facilities" means hospitals and ambulatory surgical facilities.

"Affected persons" means:

- The applicant;
- Health care facilities and health maintenance organizations providing services similar to the services under review and located in the health service area;

- Third-party payers reimbursing health care facilities in the health service area;
- Any agency establishing rates for health care facilities and health maintenance organizations in the health service area where the proposed project is to be located;
- Health care facilities and health maintenance organizations which, in the twelve months prior to receipt of the application, have submitted a letter of intent to provide similar services in the same planning area;
- Any person residing within the geographic area to be served by the applicant; and
- Any person regularly using health care facilities within the geographic area to be served by the applicant.

"Alterations," see "construction, renovation, or alteration."

"Ambulatory care facility" means any place, building, institution, or distinct part thereof not a health care facility as defined in this section and operated for the purpose of providing health services to individuals without providing such services with board and room on a continuous twenty-four-hour basis. The term "ambulatory care facility" includes the offices of private physicians, whether for individual or group practice.

"Ambulatory surgical facility" means any free-standing entity, including an ambulatory surgery center, that operates primarily for the purpose of performing surgical procedures to treat patients not requiring hospitalization. This term does not include a facility in the offices of private physicians or dentists, whether for individual or group practice, if the privilege of using such facility is not extended to physicians or dentists outside the individual or group practice.

"Applicant," means:

- Any person proposing to engage in any undertaking subject to review under the provisions of chapter 70.38 RCW.
- Any person or individual with a ten percent or greater financial interest in a partnership or corporation or other comparable legal entity engaging in any undertaking subject to review under the provisions of chapter 70.38 RCW.

"Base year" as used in the kidney dialysis station methodology means the last full calendar year preceding the first year of dialysis station need projections.

"Bed banking" means the process of retaining the rights to nursing home bed allocations which are not licensed as outlined in WAC 246-310-395.

"Bed supply" means within a geographic area the total number of:

- Nursing home beds which are licensed or certificate of need approved but not yet licensed or beds banked under the provisions of RCW 70.38.111 (8)(a) or where the need is deemed met under the provisions of RCW 70.38.115 (13)(b), excluding:

- Those nursing home beds certified as intermediate care facility for the mentally retarded (ICF-MR) the operators of which have not signed an agreement on or before July 1, 1990, with the department of social and health services department of social and health services to give appropriate notice prior to termination of the ICF-MR service;

- New or existing nursing home beds within a CCRC which are approved under the provisions of WAC 246-310-380(5); or

- Nursing home beds within a CCRC which is excluded from the definition of a health care facility per RCW 70.38.025(6); and

- Beds banked under the provisions of RCW 70.38.115 (13)(b) where the need is not deemed met.

- Licensed hospital beds used for long-term care or certificate of need approved hospital beds to be used for long-term care not yet in use, excluding swing-beds.

"Bed-to-population ratio" means the nursing home bed supply per one thousand persons of the estimated or forecasted resident population age sixty-five and older.

"Capital expenditure" means an expenditure, including a force account expenditure (i.e., an expenditure for a construction project undertaken by a nursing home facility as its own contractor), which, under generally accepted accounting principles, is not properly chargeable as an expense of operation or maintenance. The costs of any studies, surveys, designs, plans, working drawings, specifications, and other activities (including staff effort, consulting and other services which, under generally accepted accounting principles, are not properly chargeable as an expense of operation and maintenance) shall be considered capital expenditures. Where a person makes an acquisition under lease or comparable arrangement, or through donation, which would have required certificate of need review if the acquisition had been made by purchase, such acquisition shall be deemed a capital expenditure. Capital expenditures include donations of equipment or facilities to a nursing home facility, which if acquired directly by such facility, would be subject to review under the provisions of this chapter and transfer of equipment or facilities for less than fair market value if a transfer of the equipment or facilities at fair market value would be subject to such review.

"Certificate of need" means a written authorization by the secretary's designee for a person to implement a proposal for one or more undertakings.

"Certificate of need program" means that organizational program of the department responsible for the management of the certificate of need program.

"Commencement of the project" means whichever of the following occurs first: In the case of a construction project, giving notice to proceed with construction to a contractor for a construction project provided applicable permits have been applied for or obtained within sixty days of such notice; beginning site preparation or development; excavating or starting the foundation for a construction project; or beginning alterations, modification, improvement, extension, or expansion of an existing building. In the case of major medical equipment, installation. In the case of other projects, initiating a health service.

"Construction, renovation, or alteration" means the erection, building, remodeling, modernization, improvement, extension, or expansion of a physical plant of a health care facility, or the conversion of a building or portion thereof to a health care facility.

"Continuing care contract" means a contract providing a person, for the duration of that person's life or for a term in excess of one year, shelter along with nursing, medical, health-related, or personal care services. The contract is conditioned on the transfer of property, the payment of an entrance fee to the provider of such services, or the payment of periodic charges for the care and services involved. A

continuing care contract is not excluded from this definition because the contract is mutually terminable or because shelter and services are not provided at the same location.

"Continuing care retirement community (CCRC)" means any of a variety of entities, unless excluded from the definition of health care facility under RCW 70.38.025(6), which provides shelter and services based on continuing care contracts with its residents which:

- Maintains for a period in excess of one year a CCRC contract with a resident which provides or arranges for at least the following specific services:

- Independent living units;
- Nursing home care with no limit on the number of medically needed days;
- Assistance with activities of daily living;
- Services equivalent in scope to either state chore services or Medicaid home health services;
- Continues a contract, if a resident is no longer able to pay for services;
- Offers services only to contractual residents with limited exception during a transition period; and
- Holds the Medicaid program harmless from liability for costs of care, even if the resident depletes his or her personal resources.

"Days" means calendar days. Days are counted starting the day after the date of the event from which the designated period of time begins to run. If the last day of the period falls on a Saturday, Sunday, or legal holiday observed by the state of Washington, a designated period runs until the end of the first working day following the Saturday, Sunday, or legal holiday.

"Department" means the Washington state department of health.

"Effective date of facility closure" means:

- The date on which the facility's license was relinquished, revoked or expired; or
- The date the last resident leaves the facility, whichever comes first.

"End-of-the-year incenter patients" means the number of patients receiving incenter kidney dialysis at the end of the calendar year.

"End-stage renal dialysis (ESRD) service areas" means each individual county, designated by the department as the smallest geographic area for which kidney dialysis station need projections are calculated, or other service area documented by patient origin.

"Enhance the quality of life for residents" means, for the purposes of voluntary bed banking, those services or facility modifications which have a direct and immediate benefit to the residents. These shall include, but not be limited to: Resident activity and therapy facilities; family visiting rooms; spiritual rooms and dining areas. These services or facility modifications shall not include those that do not have direct and immediate benefit to the residents, such as: Modifications to staff offices; meeting rooms; and other staff facilities.

"Established ratio" means a bed-to-population ratio of forty-five beds per one thousand persons of the estimated or forecast resident population age sixty-five and older established for planning and policy-making purposes. The department may revise this established ratio using the process outlined in WAC 246-310-370.

"Estimated bed need" means the number of nursing home beds calculated by multiplying the planning area's forecasted resident population by the established ratio for the projection year.

"Estimated bed projection" means the number of nursing home beds calculated by the department state-wide or within a planning area, by the end of the projection period.

"Ex parte contact" means any oral or written communication between any person in the certificate of need program or any other person involved in the decision regarding an application for, or the withdrawal of, a certificate of need and the applicant for, or holder of, a certificate of need, any person acting on behalf of the applicant or holder, or any person with an interest regarding issuance or withdrawal of a certificate of need.

"Expenditure minimum" means one million dollars for the twelve-month period beginning with July 24, 1983, adjusted annually by the department according to the provisions of WAC 246-310-900.

"Health care facility" means hospitals, psychiatric hospitals, nursing homes, kidney disease treatment centers including freestanding dialysis units, ambulatory surgical facilities, continuing care retirement communities, hospices and home health agencies, and includes such facilities when owned and operated by a political subdivision or instrumentality of the state and such other facilities as required by federal law and implementing regulations, but does not include Christian Science sanatoriums operated or listed and certified by the First Church of Christ Scientist, Boston, Massachusetts. In addition, the term "health care facility" does not include any nonprofit hospital:

- Operated exclusively to provide health care services for children;
  - Which does not charge fees for such services; and
  - If not contrary to federal law as necessary to the receipt of federal funds by the state.
- In addition, the term "health care facility" does not include a continuing care retirement community which:
- Offers services only to contractual residents;
  - Provides its residents a contractually guaranteed range of services from independent living through skilled nursing, including some form of assistance with activities of daily living;
  - Contractually assumes responsibility for costs of services exceeding the resident's financial responsibility as stated in contract, so that, with the exception of insurance purchased by the retirement community or its residents, no third party, including the Medicaid program, is liable for costs of care even if the resident depletes personal resources;
  - Offers continuing care contracts and operates a nursing home continuously since January 1, 1988, or obtained a certificate of need to establish a nursing home;
  - Maintains a binding agreement with the department of social and health services assuring financial liability for services to residents, including nursing home services, shall not fall upon the department of social and health services;
  - Does not operate, and has not undertaken, a project resulting in a number of nursing home beds in excess of one for every four living units operated by the continuing care retirement community, exclusive of nursing home beds; and

- Has undertaken no increase in the total number of nursing home beds after January 1, 1988, unless a professional review of pricing and long-term solvency was obtained by the retirement community within the prior five years and fully disclosed to residents.

"Health maintenance organization" means a public or private organization, organized under the laws of the state, which:

- Is a qualified health maintenance organization under Title XIII, Section 1310(d) of the Public Health Service Act; or

- Provides or otherwise makes available to enrolled participants health care services, including at least the following basic health care services: Usual physician services, hospitalization, laboratory, x-ray, emergency and preventive services, and out-of-area coverage;

- Is compensated (except for copayments) for the provision of the basic health care services listed in this subsection to enrolled participants by a payment made on a periodic basis without regard to the date the health care services are provided and fixed without regard to the frequency, extent, or kind of health service actually provided; and

- Provides physicians' services primarily:

- Directly through physicians who are either employees or partners of such organization, or

- Through arrangements with individual physicians or one or more groups of physicians (organized on a group practice or individual practice basis).

"Health service area" means a geographic region appropriate for effective health planning including a broad range of health services.

"Health services" means clinically related (i.e., preventive, diagnostic, curative, rehabilitative, or palliative) services and includes alcoholism, drug abuse, and mental health services.

"Home health agency" means an entity which is, or has declared an intent to become, certified as a provider of home health services in the Medicaid or Medicare program.

"Hospice" means an entity which is, or has declared an intent to become, certified as a provider of hospice services in the Medicaid or Medicare program.

"Hospital" means any institution, place, building or agency or distinct part thereof which qualifies or is required to qualify for a license under chapter 70.41 RCW, or as a psychiatric hospital licensed under chapter 71.12 RCW.

"Inpatient" means a person receiving health care services with board and room in a health care facility on a continuous twenty-four-hour-a-day basis.

"Justified home training station" means a kidney dialysis station designated for home hemodialysis and/or peritoneal dialysis training. When no dialysis stations have been designated for home training at a given dialysis treatment center, one station for every six patients trained for home hemodialysis, and one station for every twenty patients for peritoneal dialysis, will be considered a justified home training station. In no case shall all stations at a given dialysis treatment center be designated as justified home training stations. To request justified home training stations at a new dialysis treatment center, the applicant must document that at least six patients are projected to be trained for home hemodialysis or twenty patients for peritoneal

dialysis for each such station requested for each of the first five years of projected operations.

"Kidney disease treatment center" means any place, institution, building or agency or a distinct part thereof equipped and operated to provide services, including outpatient dialysis and/or kidney transplantation, to persons who have end-stage renal disease (ESRD).

"Licensee" means an entity or individual licensed by the department of health or the department of social and health services. For the purposes of nursing home projects, licensee refers to the operating entity and those persons specifically named in the license application as defined under chapter 388-97 WAC.

"Net estimated bed need" means estimated bed need of a planning area changed by any redistribution as follows:

- Adding nursing home beds being redistributed from another nursing home planning area or areas; or

- Subtracting nursing home beds being redistributed to another nursing home planning area or areas.

"New nursing home bed" means a nursing home bed never licensed by the state or beds banked under the provisions of RCW 70.38.115(13), where the applicant must demonstrate need for the previously licensed nursing home beds. This term does not include beds banked under the provisions of RCW 70.38.111(8).

"Nursing home" means any entity licensed or required to be licensed under the provisions of chapter 18.51 RCW or distinct part long-term care units located in a hospital and licensed under chapter 70.41 RCW.

"Obligation," when used in relation to a capital expenditure, means the following has been incurred by or on behalf of a health care facility:

- An enforceable contract has been entered into by a health care facility or by a person on behalf of the health care facility for the construction, acquisition, lease, or financing of a capital asset; or

- A formal internal commitment of funds by a health care facility for a force account expenditure constituting a capital expenditure; or

- In the case of donated property, the date on which the gift is completed in accordance with state law.

"Offer," when used in connection with health services, means the health facility provides one or more specific health services.

"Over the established ratio" means the bed-to-population ratio is greater than the state-wide current established ratio.

"Person" means an individual, a trust or estate, a partnership, a corporation (including associations, joint stock companies, and insurance companies), the state, or a political subdivision or instrumentality of the state, including a municipal corporation or a hospital district.

"Planning area" means each individual county designated by the department as the smallest geographic area for which nursing home bed need projections are developed, except as follows:

- Clark and Skamania counties shall be one planning area.

- Chelan and Douglas counties shall be one planning area.

"Predevelopment expenditures" means capital expenditures, the total of which exceeds the expenditure minimum,

made for architectural designs, plans, drawings, or specifications in preparation for the acquisition or construction of physical plant facilities. "Predevelopment expenditures" exclude any obligation of a capital expenditure for the acquisition or construction of physical plant facilities and any activity which the department may consider the "commencement of the project" as this term is defined in this section.

"Professional review of continuing care retirement community pricing and long-term solvency" means prospective financial statements, supported by professional analysis and documentation, which:

- Conform to Principles and Practices Board Statement Number 9 of the Healthcare Financial Management Association, "Accounting and Reporting Issues Related to Continuing Care Retirement Communities"; and

- Project the financial operations of the continuing care retirement community over a period of ten years or more into the future; and

- Are prepared and signed by a qualified actuary as defined under WAC 284-05-060 or an independent certified public accountant, or are prepared by management of the continuing care retirement community and reviewed by a qualified actuary or independent certified public accountant who issues a signed examination or compilation report on the prospective financial statements; and

- Include a finding by management that the intended expansion project of the continuing care retirement project is financially feasible.

"Project" means all undertakings proposed in a single certificate of need application or for which a single certificate of need is issued.

"Project completion" for projects requiring construction, means the date the facility is licensed. For projects not requiring construction, project completion means initiating the health service.

"Projection period" means the three-year time interval following the projection year.

"Projection year" for nursing home purposes, means the one-year time interval preceding the projection period. For kidney dialysis station projection purposes, means the base year plus three years.

"Public comment period" means the time interval during which the department shall accept comments regarding a certificate of need application.

"Redistribution" means the shift of nursing home bed allocations between two or more planning areas or the shift of nursing home beds between two or more nursing homes.

"Replacement authorization" means a written authorization by the secretary's designee for a person to implement a proposal to replace existing nursing home beds in accordance with the eligibility requirements in WAC 246-310-044 and notice requirements in WAC 246-310-396.

"Resident population" for purposes of nursing home projects, means the number of residents sixty-five years of age and older living within the same geographic area which:

- Excludes contract holders living within a recognized CCRC:

- With approval for new nursing home beds under the provisions of WAC 246-310-380(5); or

- Excluded from the definition of a health care facility per RCW 70.38.025(6);

- Is calculated using demographic data obtained from:
- The office of financial management; and
- Certificate of need applications and exemption requests previously submitted by a CCRC.

"Secretary" means the secretary of the Washington state department of health or the secretary's designee.

"State Health Planning and Resources Development Act" means chapter 70.38 RCW.

"State-wide current ratio" means a bed-to-population ratio computed from the most recent state-wide nursing home bed supply and the most recent estimate of the state-wide resident population.

"Swing beds" means up to the first five hospital beds designated by an eligible rural hospital which are available to provide either acute care or nursing home services.

"Tertiary health service" means a specialized service meeting complicated medical needs of people and requires sufficient patient volume to optimize provider effectiveness, quality of service, and improved outcomes of care.

"Transition period" means the period of time, not exceeding five years, between the date a CCRC is inhabited by a member, and the date it fully meets the requirements of a CCRC.

"Under the established ratio" means the bed-to-population ratio is less than the state-wide current established ratio.

"Undertaking" means any action subject to the provisions of chapter 246-310 WAC.

"Working days" excludes Saturdays, Sundays, and legal holidays observed by the state of Washington. Working days are counted in the same way as calendar days.

[Statutory Authority: Chapter 70.38 RCW. 96-24-052, § 246-310-010, filed 11/27/96, effective 12/28/96. Statutory Authority: RCW 70.38.135 and 70.38.919. 92-02-018 (Order 224), § 246-310-010, filed 12/23/91, effective 1/23/92. Statutory Authority: RCW 43.70.040. 91-02-049 (Order 121), recodified as § 246-310-010, filed 12/27/90, effective 1/31/91. Statutory Authority: Chapter 70.38 RCW. 90-17-086 (Order 081), § 248-19-220, filed 8/17/90, effective 9/17/90; 90-02-093 (Order 023), § 248-19-220, filed 1/3/90, effective 2/3/90. Statutory Authority: RCW 70.38.135. 88-15-021 (Order 2639), § 248-19-220, filed 7/11/88; 86-06-030 (Order 2344), § 248-19-220, filed 2/28/86; 84-07-014 (Order 2082), § 248-19-220, filed 3/14/84; 81-09-012 (Order 210), § 248-19-220, filed 4/9/81, effective 5/20/81. Statutory Authority: Chapter 70.38 RCW. 79-12-079 (Order 188), § 248-19-220, filed 11/30/79.]

#### **WAC 246-310-020 Applicability of chapter 246-310**

WAC. (1) The following undertakings shall be subject to the provisions of chapter 246-310 WAC, with the exceptions provided for in this section.

(a) The construction, development, or other establishment of a new health care facility:

(i) No new health care facility may be initiated as a health service of an existing health care facility without certificate of need approval as a new health care facility;

(ii) The provision of services by a home health agency or hospice to a county, on a regular and ongoing basis, that was not previously included in the home health agency or hospice service area shall be considered the development of a new home health agency or hospice.

(b) The sale, purchase, or lease of part or all of any existing hospital licensed under chapter 70.41 RCW or a psychiatric hospital licensed under chapter 71.12 RCW;

(c) A change in bed capacity of a health care facility increasing the total number of licensed beds or redistributing



beds among acute care, nursing home care, and boarding home care, as defined under RCW 18.20.020, if the bed redistribution is effective for a period in excess of six months;

(d) Any new tertiary health services offered in or through a health care facility, and not offered on a regular basis by, in, or through such health care facility within the twelve-month period prior to the time the facility will offer such services:

(i) Tertiary services include the following:

(A) Specialty burn services. This is a service designed, staffed, and equipped to care for any burn patient regardless of the severity or extent of the burn. All staff and equipment necessary for any level of burn care are available;

(B) Intermediate care nursery and/or obstetric services level II. Intermediate care nursery is defined in chapter 246-318 WAC. A level II obstetric service is in an area designed, organized, equipped, and staffed to provide a full range of maternal and neonatal services for uncomplicated patients and for the majority of complicated obstetrical problems;

(C) Neonatal intensive care nursery and/or obstetric services level III. Neonatal intensive care nursery is defined in chapter 246-318 WAC. A level III obstetric service is in an area designed, organized, equipped, and staffed to provide services to the few women and infants requiring full intensive care services for the most serious type of maternal-fetal and neonatal illnesses and abnormalities. Such a service provides the coordination of care, communications, transfer, and transportation for a given region. Level III services provide leadership in preparatory and continuing education in prenatal and perinatal care and may be involved in clinical and basic research;

(D) Transplantation of specific solid organs, including, but not limited to, heart, liver, pancreas, lung, small bowel and kidney and including bone marrow. A transplantation service for each solid organ is considered a separate tertiary service;

(E) Open heart surgery and/or elective therapeutic cardiac catheterization including elective percutaneous transluminal coronary angioplasty (PTCA). Open heart surgery includes the care of patients who have surgery requiring the use of a heart lung bypass machine. Therapeutic cardiac catheterization means passage of a tube or other device into the coronary arteries or the heart chambers to improve blood flow. PTCA means the treatment of a narrowing of a coronary artery by means of inflating a balloon catheter at the site of the narrowing to dilate the artery;

(F) Inpatient physical rehabilitation services level I. Level I rehabilitation services are services for persons with usually nonreversible, multiple function impairments of a moderate-to-severe complexity resulting in major changes in the patient's lifestyle and requiring intervention by several rehabilitation disciplines. Services are multidisciplinary, including such specialists as a rehabilitation nurse; and physical, occupational, and speech therapists; and vocational counseling; and a physiatrist. The service is provided in a dedicated unit with a separate nurses station staffed by nurses with specialized training and/or experience in rehabilitation nursing. While the service may specialize (i.e., spinal cord injury, severe head trauma, etc.), the service is able to

treat all persons within the designated diagnostic specialization regardless of the level of severity or complexity of the impairments and include the requirements as identified in chapter 246-976 WAC relating to level I trauma rehabilitation services;

(G) Specialized inpatient pediatric services. The service is designed, staffed, and equipped to treat complex pediatric cases for more than twenty-four hours. The service has a staff of pediatric specialists and subspecialists.

(ii) The department shall review, periodically revise, and update the list of tertiary services. The department shall change the tertiary services list following the procedures identified in WAC 246-310-035;

(iii) The offering of an inpatient tertiary health service by a health maintenance organization or combination of health maintenance organizations is subject to the provisions under chapter 246-310 WAC unless the offering is exempt under the provisions of RCW 70.38.111.

(e) Any increase in the number of dialysis stations in a kidney disease center;

(f) Any capital expenditure in excess of the expenditure minimum for the construction, renovation, or alteration of a nursing home. However, a capital expenditure, solely for any one or more of the following, which does not substantially affect patient charges, is not subject to certificate of need review:

(i) Communications and parking facilities;

(ii) Mechanical, electrical, ventilation, heating, and air conditioning systems;

(iii) Energy conservation systems;

(iv) Repairs to, or the correction of, deficiencies in existing physical plant facilities necessary to maintain state licensure, however, other additional repairs, remodeling, or replacement projects that are not related to one or more deficiency citations and are not necessary to maintain state licensure are not exempt from certificate of need review except as otherwise permitted by (f)(vi) of this subsection or RCW 70.38.115(13);

(v) Acquisition of equipment, including data processing equipment, not for use in the direct provision of health services;

(vi) Construction or renovation at an existing nursing home involving physical plant facilities, including administrative, dining, kitchen, laundry, and therapy areas, or support facilities, by an existing licensee who has operated the beds for at least one year;

(vii) Acquisition of land;

(viii) Refinancing of existing debt; and

(ix) Nursing home project granted a replacement authorization under WAC 246-310-044.

(g) Any expenditure for the construction, renovation, or alteration of a nursing home or change in nursing home services in excess of the expenditure minimum made in preparation for any undertaking subject to the provisions under chapter 246-310 WAC and any arrangement or commitment made for financing such undertaking;

(h) No person may divide a project in order to avoid review requirements under any of the thresholds specified under this section; and

(i) The department may issue certificates of need authorizing only predevelopment expenditures, without



authorizing any subsequent undertaking for which the predevelopment expenditures are made.

(2) No person shall engage in any undertaking subject to certificate of need review unless:

(a) A certificate of need authorizing such undertaking is issued and remains valid; or

(b) An exemption is granted in accordance with the provisions of this chapter.

(3) If a nursing home or portion of a nursing home constructed or established under the authority of a certificate of need granted from the pool of nursing home beds for ethnic minorities according to the provisions of WAC 246-310-135 is sold or leased within ten years to a party not eligible for an award of such beds under the provisions of WAC 246-310-136(2):

(a) The purchaser or lessee may not operate those beds as nursing home beds without first obtaining a certificate of need for new beds; and

(b) The beds that were awarded from the special pool shall be returned to that pool.

[Statutory Authority: Chapter 70.38 RCW. 96-24-052, § 246-310-020, filed 11/27/96, effective 12/28/96. Statutory Authority: RCW 70.38.135 (3)(c). 92-05-057 (Order 244), § 246-310-020, filed 2/14/92, effective 3/16/92. Statutory Authority: RCW 70.38.135 and 70.38.919. 92-02-018 (Order 224), § 246-310-020, filed 12/23/92, effective 1/23/93. Statutory Authority: RCW 43.70.040. 91-02-049 (Order 121), recodified as § 246-310-020, filed 12/27/90, effective 1/31/91. Statutory Authority: Chapter 70.38 RCW. 90-21-028 (Order 082), § 248-19-231, filed 10/9/90, effective 10/9/90; 89-23-098 (Order 019), § 248-19-231, filed 11/21/89, effective 12/22/89.]

#### **WAC 246-310-035 Tertiary services identification.**

(1) The criteria in this section shall be used as guidelines when examining services to determine whether the service is considered a tertiary service.

(2) In determining whether a service is a tertiary service the department shall consider the degree to which the service meets the following criteria:

(a) Whether the service is dependent on the skills and coordination of specialties and subspecialties. Including, but not limited to, physicians, nurses, therapists, social workers;

(b) Whether the service requires immediate access to an acute care hospital;

(c) Whether the service is characterized by relatively few providers;

(d) Whether the service is broader than a procedure;

(e) Whether the service has a low use rate;

(f) Whether consensus supports or published research shows that sufficient volume is required to impact structure, process, and outcomes of care; and

(g) Whether the service carries a significant risk or consequence.

(3) Periodically the department shall request review of proposed changes to the list of tertiary services identified in WAC 246-310-020. The periodic review shall be conducted as follows:

(a) The department shall send notice to all persons who have sent the certificate of need program a written request to be notified of the annual review of tertiary services.

(b) The notice shall contain the following:

(i) Identification of the thirty-day period during which written comments may be received. This thirty-day period shall be called the comment period;

(ii) The criteria listed in this section; and

(iii) The name and address of the person in the department to whom written comments are to be addressed.

(c) The written comments must address whether a service meets or partially meets the criteria in this section.

(d) Within sixty days after the close of the comment period the department shall determine whether to propose any changes to the list of tertiary services in chapter 246-310 WAC. This sixty-day period shall be called the consideration period.

(e) During the consideration period information may be exchanged between the department and persons proposing changes to the list of tertiary services in chapter 246-310 WAC.

(4) The department shall convene a technical work group at least every three years to do the following:

(a) Review the criteria listed in this section to determine whether the criteria appropriately define a tertiary service; and

(b) Propose any necessary changes to the list of tertiary services in WAC 246-310-020.

[Statutory Authority: Chapter 70.38 RCW. 96-24-052, § 246-310-035, filed 11/27/96, effective 12/28/96. Statutory Authority: RCW 70.38.135 and 70.38.919. 92-02-018 (Order 224), § 246-310-035, filed 12/23/91, effective 1/23/92.]

#### **WAC 246-310-040 Exemptions from requirements for a certificate of need for health maintenance organizations.** (1) Provisions for exemptions.

The secretary's designee shall grant an exemption from the requirements for a certificate of need for the offering of an inpatient institutional health service, the acquisition of major medical equipment for the provision of an institutional health service, or the obligation of a capital expenditure in excess of the expenditure minimum for the provision of an inpatient institutional health service to any entity meeting the eligibility requirements set forth in subsection (1)(a) of this section for such an exemption and submitting an application for an exemption meeting the requirements of subsection (1)(b) of this section.

(a) Eligibility requirements.

To be eligible for an exemption from the requirements for a certificate of need for the offering of an inpatient institutional health service, the acquisition of major medical equipment for the provision of an inpatient institutional health service, or the obligation of a capital expenditure in excess of the expenditure minimum for the provision of an institutional health service, an applicant entity shall be one of the following:

(i) A health maintenance organization or a combination of health maintenance organizations if:

(A) The organization or combination of organizations has, in the service area of the organization or the service areas of the organizations in the combination, an enrollment of at least fifty thousand individuals;

(B) The facility in which the service will be provided is or will be geographically located so the service will be reasonably accessible to such enrolled individuals; and

(C) At least seventy-five percent of the patients reasonably expected to receive the institutional health service will be individuals enrolled in such organization or organizations in the combination;

(ii) A health care facility if:

(A) The facility primarily provides or will provide inpatient health services;

(B) The facility is or will be controlled, directly or indirectly, by a health maintenance organization or a combination of health maintenance organizations which has, in the service area of the organization or service areas of the organizations in the combination, an enrollment of at least fifty thousand individuals;

(C) The facility is or will be geographically located so the service will be reasonably accessible to such enrolled individuals; and

(D) At least seventy-five percent of the patients reasonably expected to receive the institutional health service will be individuals enrolled with such organization or organizations in the combination; or

(iii) A health care facility (or portion thereof) if:

(A) The facility is or will be leased by a health maintenance organization or combination of health maintenance organizations which has, in the service area of the organization or the service areas of the organizations in the combination, an enrollment of at least fifty thousand individuals and, on the date the application for an exemption is submitted, at least fifteen years remain in the term of the lease;

(B) The facility is or will be geographically located so the service will be reasonably accessible to such enrolled individuals; and

(C) At least seventy-five percent of the patients reasonably expected to receive the institutional health service will be individuals enrolled with such organization;

(b) Requirements for an application for exemption.

An application for an exemption from a certificate of need shall meet the following requirements:

(i) The application for an exemption shall have been submitted at least thirty days prior to the offering of the institutional health service, acquisition of major medical equipment, or obligation of the capital expenditure to which the application pertains. A copy of the application for the exemption shall be sent simultaneously to the appropriate advisory review agencies.

(ii) A complete application shall be submitted in such form and manner as has been prescribed by the department. The information which the department prescribes shall include:

(A) All of the information required to make a determination that the applicant entity qualifies in accordance with subsection (1)(a) of this section; and

(B) A complete description of the offering, acquisition, or obligation to which the application pertains.

(2) Action on an application for exemption.

(a) Within thirty days after receipt of a complete application for exemption from certificate of need requirements, the department shall send the applicant a written notice the exemption has been granted or denied. A copy of such written notice shall be sent simultaneously to the appropriate advisory review agencies.

(b) The secretary's designee shall deny an exemption if he or she finds the applicant has not met the requirements of subsections (1)(a) and (b) of this section. Written notice of the denial shall include the specific reasons for the denial.

(c) In the case of an application for a proposed health care facility (or portion thereof) which has not begun to provide institutional health services on the date the applica-

tion for an exemption is submitted, the secretary's designee shall grant the exemption if he or she determines the facility (or portion thereof) will meet the applicable requirements of subsection (1)(a) of this section when the facility first provides health services.

(d) If the secretary's designee fails to grant or deny an exemption in accordance with the provisions of this section within thirty days after receipt of a complete application for such exemption, the applicant for the exemption may seek a writ of mandamus from superior court pursuant to chapter 7.16 RCW.

(3) Subsequent sale, lease, or acquisition of exempt facilities or equipment.

Subsequent sale, lease, or acquisition of exempt health care facilities (or portions thereof) or medical equipment for which an exemption was granted under the provisions of subsection (2) of this section, any acquisition of a controlling interest in such facility or equipment, and any use of such facility or equipment by a person other than the one to whom the exemption was granted, shall meet one of the following conditions:

(a) A certificate of need for the purchase, lease, acquisition of controlling interest in, or use of such facility or equipment, shall have been applied for and issued by the department; or

(b) The department shall have determined, after receipt of an application for an exemption, submitted in accordance with subsection (1) of this section, that the requirements of either subsection (1)(a)(i) or subsection (1)(a)(ii)(A) and (B) are met.

(4) The method of payment for services (i.e., prepaid or fee for service) shall not be considered relevant in determining whether an undertaking of a health maintenance organization qualifies for an exemption under this section.

[Statutory Authority: RCW 43.70.040. 91-02-049 (Order 121), recodified as § 246-310-040, filed 12/27/90, effective 1/31/91. Statutory Authority: RCW 70.38.135. 86-06-030 (Order 2344), § 248-19-405, filed 2/28/86; 81-09-012 (Order 210), § 248-19-405, filed 4/9/81, effective 5/20/81.]

**WAC 246-310-041 Exemption from requirements for a certificate of need for continuing care retirement communities' nursing home projects.** (1) Provisions for exemptions.

The secretary's designee shall grant an exemption from the requirements for a certificate of need for the construction, development, or other establishment of a nursing home, or the addition of beds to an existing nursing home, that is owned and operated by a continuing care retirement community meeting the eligibility requirements of (a) of this subsection and submitting an application for an exemption meeting the requirements of (b) of this subsection.

(a) Eligibility requirements. To be eligible for an exemption under this section, an applicant entity shall demonstrate that:

(i) Nursing home services will be offered only to contractual residents;

(ii) Residents will be provided a contractually guaranteed range of services from independent living through skilled nursing, including some assistance with daily living activities;

(iii) The facility contractually assumes responsibility for the cost of services exceeding the resident's financial

responsibility under the contract, so that no third party, including the Medicaid program, is liable for the costs of care, even if the resident depletes his or her personal resources. This exclusion does not pertain to insurance purchased by the retirement community or its residents;

(iv) The entity has offered continuing care contracts and has operated a nursing home continuously since January 1, 1988, or has obtained a certificate of need to establish a nursing home;

(v) A binding agreement is maintained with the state assuring that financial liability for services to residents, including nursing home services, will not fall upon the state;

(vi) It does not operate, and has not undertaken a project that would result in the ratio of nursing home beds to independent living units exceeding one nursing home bed for every four independent living units, exclusive of nursing home beds; and

(vii) It has obtained a professional review of pricing and long-term solvency of the applicant entity within the prior five years which was fully disclosed to residents.

(b) Requirements for an application for exemption. An application for an exemption from a certificate of need shall meet the following requirements:

(i) The application for an exemption shall be submitted at least thirty days prior to the commencement of construction, submitting an application for nursing home licensure, or commencing operation of a nursing home, whichever occurs first;

(ii) A complete application shall be submitted in such form and manner as has been prescribed by the department. The information which the department prescribes shall include:

(A) All of the information required to make a determination that the applicant entity qualifies in accordance with (a) of this subsection; and

(B) A complete description of the construction, development or other establishment of a nursing home, or the addition of nursing home beds to which the exemption application pertains.

(2) Action on an application for exemption.

(a) Within thirty days after receipt of a complete application for exemption from certificate of need requirements, the department shall send the applicant a written notice whether the exemption has been granted or denied.

(b) The secretary's designee shall deny an exemption if it is determined the applicant has not met the requirements of subsection (1)(a) and (b) of this section. Written notice of the denial shall include the specific reasons for the denial.

(3) Subsequent sale, lease, acquisition, or use of, part or all, of an exempt continuing care retirement community.

Subsequent sale, lease, acquisition or use of exempt continuing care retirement communities shall require prior certificate of need approval to qualify for licensure as a nursing home unless the department determines such sale, lease, acquisition, or use is by a continuing care retirement community that meets the conditions identified in subsection (1)(a) and (b) of this section.

[Statutory Authority: Chapter 70.38 RCW. 96-24-052, § 246-310-041, filed 11/27/96, effective 12/28/96.]

#### **WAC 246-310-042 Rural hospital and rural health care facility exemptions from certificate of need review.**

(1) Provisions for exemptions of qualified rural hospitals and rural health care facilities.

The secretary's designee shall grant an exemption from the requirement for a certificate of need for an increase in licensed bed capacity to a rural hospital meeting the eligibility requirements of (a) of this subsection and submitting an application for an exemption meeting the requirements of (c) of this subsection. The secretary's designee shall grant an exemption from the requirement for a certificate of need for the construction, development, or other establishment of a new hospital to a rural health care facility meeting the eligibility requirements of (b) of this subsection and submitting an application for an exemption meeting the requirements of (c) of this subsection.

(a) Eligibility requirements for a rural hospital exemption. To be eligible for an exemption from the requirements under this section, a rural hospital, shall demonstrate that:

(i) The applicant hospital meets the definition of a rural hospital as defined by the department;

(ii) The request is being made within three years of the date the beds licensed under chapter 70.41 RCW were reduced;

(iii) The increase in licensed beds will result in no more than had previously been licensed; and

(iv) The rural hospital became a rural primary care hospital under the provisions of Part A Title XVIII of the Social Security Act Section 1820, 42 U.S.C., 1395c et seq. after its licensure reduction.

(b) Eligibility requirements for a rural health care facility exemption. To be eligible for an exemption from the requirements under this section, a rural health care facility, shall demonstrate that:

(i) The applicant facility meets the definition of a rural health care facility under RCW 70.175.100;

(ii) The applicant facility was previously licensed as a hospital under chapter 70.41 RCW;

(iii) The request is being made within three years of the effective date of the rural health care facility license;

(iv) There will be no increase in the number of beds previously licensed under chapter 70.41 RCW and there is no redistribution in the number of beds used for acute care or long-term care;

(v) The rural health care facility has been in continuous operation; and

(vi) The rural health care facility has not been purchased or leased.

(c) Requirements for an application for exemption by a rural hospital or rural health care facility. An application for an exemption from a certificate of need shall meet the following requirements:

(i) The application for a rural hospital exemption shall be submitted at least thirty days prior to the effective date of the hospital license that increases the number of beds at the rural hospital or at the time an application is made to the department to increase the number of licensed beds at the rural hospital, whichever occurs first.

(ii) The application for a rural health care facility exemption shall be submitted at least thirty days prior to the effective date of the hospital license that converts the rural health care facility back to a hospital or at the time an

application is made to the department to convert back to a hospital, whichever occurs first;

(iii) A complete application shall be submitted in such form and manner as has been prescribed by the department. The information which the department prescribes shall include:

All of the information required to make a determination that the rural hospital qualifies in accordance with (a) of this subsection or that the rural health care facility qualifies with (b) of this subsection.

(2) Action on an application for exemption by a rural hospital or rural health care facility.

(a) Within thirty days after receipt of a complete application for exemption from certificate of need requirements, the department shall send the applicant a written notice whether the exemption request has been granted or denied.

(b) The secretary's designee shall deny an exemption if it is determined the applicant entity has not met the requirements of subsection (1)(a), (b), or (c) of this section. Written notice of the denial shall include the specific reasons for the denial.

[Statutory Authority: Chapter 70.38 RCW. 96-24-052, § 246-310-042, filed 11/27/96, effective 12/28/96.]

**WAC 246-310-043 Exemption from requirements for a certificate of need for nursing home bed conversions to alternative use.** Provisions for exemptions.

The secretary's designee shall grant an exemption from the requirements for a certificate of need for the conversion of nursing home beds banked under the provisions of RCW 70.38.111(8) by a nursing home meeting the eligibility requirements of this section and submitting an application for an exemption which demonstrates the eligibility requirements have been met.

(1) Eligibility requirements. To be eligible for an exemption under this section, an applicant shall demonstrate that:

(a) The nursing home voluntarily reduced its licensed capacity to provide one or more alternative services, as identified in RCW 70.38.111(8), to reduce the number of beds per room to one or two in the nursing home, or otherwise enhance the quality of life for residents, as defined in WAC 246-310-010;

(b) The beds to be converted back to nursing home beds are to be licensed in the original facility;

(c) The nursing home has remained in continuous operation and has not been sold or leased during the bed banking time interval;

(d) Notice of intent to bank the nursing home beds was given as required by WAC 246-310-395; and

(e) The bed conversion occurs within four years of the bed banking, unless the department has granted a four year extension under WAC 246-310-580 in which case the bed conversion must occur within eight years of the original bed banking.

(2) Nursing homes proposing to establish, construct, or otherwise develop alternative services subject to certificate of need review under the provisions of RCW 70.38.105 shall obtain certificate of need approval prior to providing such services.

[Statutory Authority: Chapter 70.38 RCW. 96-24-052, § 246-310-043, filed 11/27/96, effective 12/28/96.]

**WAC 246-310-044 Exemption from requirements for a certificate of need for nursing home bed replacements.** (1) Provisions for exemptions.

The secretary's designee shall grant a replacement authorization exempting a facility from the requirements for a certificate of need for the replacement of existing nursing home beds under the provisions of RCW 70.38.115 (13)(a) by a nursing home meeting the eligibility requirements of this section and submitting an application, following the notice requirements in WAC 246-310-396, which demonstrates the eligibility requirements have been met.

(2) Nursing home construction or renovation projects for the purpose of replacing nursing home beds within the same planning area, and which meet the eligibility requirements in subsection (3) of this section and the notification requirements in WAC 246-310-396, shall not be subject to certificate of need review. Projects meeting the above requirements would include, but are not limited to:

(a) Replacement of an existing facility at the same location;

(b) Construction of a new nursing home or facilities for the purpose of replacing beds in the same planning area;

(c) Renovation of an existing facility for the purpose of replacing beds; and

(d) Redistribution of all or a portion of existing beds to an existing or new nursing home or facilities in the same planning area.

(3) Eligibility requirements. To be eligible for an exemption under this section, an applicant shall demonstrate that:

(a) The applicant is the existing licensee (as defined in WAC 246-310-010) of all affected facilities and has operated the beds at all affected facilities for at least one year immediately preceding the replacement exemption request fulfilling the requirements as specified in WAC 246-310-396;

(b) The applicant will be the licensee at all affected facilities at the completion of the project except as allowed under the provisions of RCW 70.38.115(14);

(c) The project will not increase the total bed capacity of a planning area; and

(d) The nursing home beds being replaced will not provide nursing home services once the replacement beds are licensed.

(4) Projects must be commenced within two years following replacement authorization with a possibility of one six-month extension provided that substantial and continuing progress had been made toward commencement of the project as referenced in WAC 246-310-580.

[Statutory Authority: Chapter 70.38 RCW. 96-24-052, § 246-310-044, filed 11/27/96, effective 12/28/96.]

**WAC 246-310-050 Applicability determination.** (1) Any person wanting to know whether an action the person is considering is subject to certificate of need requirements (chapter 246-310 WAC) may submit a written request to the certificate of need unit requesting a formal determination of

applicability of the certificate of need requirements to the action.

(a) The written request shall include the nature and extent of any construction, changes in services, and the estimated total costs of the action.

(2) The department may request any additional written information that is reasonably necessary to make an applicability determination on the action.

(3) The department shall respond in writing to a request for an applicability determination within thirty days of receipt of the complete information needed for such determination. In the written response, the department shall state the reasons for its determination that the action is or is not subject to certificate of need requirements.

(4) Information or advice given by the department as to whether an action is subject to certificate of need requirements shall not be considered an applicability determination unless it is in written form in response to a written request submitted in accordance with provisions of this section.

(5) A written applicability determination on an action in response to a written request and based on written information shall be binding upon the department: *Provided*, The nature, extent, or cost of the action does not significantly change.

[Statutory Authority: Chapter 70.38 RCW. 96-24-052, § 246-310-050, filed 11/27/96, effective 12/28/96. Statutory Authority: RCW 70.38.135 and 70.38.919. 92-02-018 (Order 224), § 246-310-050, filed 12/23/91, effective 1/23/92. Statutory Authority: RCW 43.70.040. 91-02-049 (Order 121), recodified as § 246-310-050, filed 12/27/90, effective 1/31/91. Statutory Authority: RCW 70.38.135. 86-06-030 (Order 2344), § 248-19-240, filed 2/28/86; 81-09-012 (Order 210), § 248-19-240, filed 4/9/81, effective 5/20/81. Statutory Authority: Chapter 70.38 RCW. 79-12-079 (Order 188), § 248-19-240, filed 11/30/79.]

**WAC 246-310-060 Sanctions for violations.** The department may take or cause to be taken any action against a person who has failed to comply with certificate of need regulations which is provided for in RCW 70.38.125.

[Statutory Authority: RCW 43.70.040. 91-02-049 (Order 121), recodified as § 246-310-060, filed 12/27/90, effective 1/31/91. Statutory Authority: RCW 70.38.135. 81-09-012 (Order 210), § 248-19-250, filed 4/9/81, effective 5/20/81. Statutory Authority: Chapter 70.38 RCW. 79-12-079 (Order 188), § 248-19-250, filed 11/30/79.]

**WAC 246-310-080 Letter of intent.** Any person planning to propose an undertaking subject to certificate of need review shall submit a letter of intent as follows:

(1) The letter of intent shall include the following information:

- (a) A description of the services proposed;
- (b) The estimated cost of the proposed project;
- (c) An identification of the service area.

(2) A letter of intent shall be valid for six months after the receipt of the letter by the department. If the applicant does not submit an application for the project as described in the letter within this time frame, a new letter of intent shall be required before the department accepts an application.

(3) In the event that the application proposes a project that is significantly different than that proposed in the letter of intent, the department shall consider the application the letter of intent and no further action shall be taken until the end of the thirty-day letter of intent period.

(4) Expedited or regular review. Any person proposing an undertaking subject to an expedited or regular review shall submit a letter of intent at least thirty days prior to the submission of the application.

(5) Concurrent review.

(a) Any person proposing undertakings subject to concurrent review shall submit a letter of intent according to the applicable schedule.

(b) Within thirty days following the last day of the letter of intent submittal period, the department shall determine which of the proposed undertakings compete with other proposed undertakings. Two or more undertakings within the same concurrent review cycle may be competing when the proposed undertaking would be located in the same county or planning area and/or the undertakings propose nursing home beds to be allocated from the same statewide continuing care retirement community (CCRC) bed pool as defined in WAC 246-310-380. The department shall notify applicants of competing undertakings.

[Statutory Authority: Chapter 70.38 RCW. 96-24-052, § 246-310-080, filed 11/27/96, effective 12/28/96. Statutory Authority: RCW 70.38.135 and 70.38.919. 92-02-018 (Order 224), § 246-310-080, filed 12/23/91, effective 1/23/92. Statutory Authority: RCW 43.70.040. 91-02-049 (Order 121), recodified as § 246-310-080, filed 12/27/90, effective 1/31/91. Statutory Authority: RCW 70.38.115. 87-10-023 (Order 2487), § 248-19-270, filed 5/1/87. Statutory Authority: RCW 70.38.135. 86-06-030 (Order 2344), § 248-19-270, filed 2/28/86; 81-09-012 (Order 210), § 248-19-270, filed 4/9/81, effective 5/20/81. Statutory Authority: Chapter 70.38 RCW. 79-12-079 (Order 188), § 248-19-270, filed 11/30/79.]

**WAC 246-310-090 Submission and withdrawal of applications.** (1) General.

(a) A person proposing an undertaking subject to review shall submit a certificate of need application in such form and manner and containing such information as the department has prescribed and published as necessary to such a certificate of need application.

(i) The information, which the department prescribes and publishes as required for a certificate of need application, shall be limited to the information necessary for the department to perform a certificate of need review and shall vary in accordance with and be appropriate to the category of review or the type of proposed project: *Provided however*, That the required information shall include what is necessary to determine whether the proposed project meets applicable criteria and standards.

(ii) Information regarding a certificate of need application submitted by an applicant after the department has given "notification of the beginning of review" in the manner prescribed by WAC 246-310-170 shall be submitted in writing to the department.

(iii) Except as provided in WAC 246-310-190, no information regarding a certificate of need application submitted by an applicant after the conclusion of the public comment period shall be considered by the department in reviewing and taking action on a certificate of need application. An exception to this rule shall be made when, during its final review period, the department finds an unresolved pivotal issue requires submission of further information by an applicant and the applicant agrees to an extension of the review period in order to resolve this issue as provided for in WAC 246-310-160 (2)(b), 246-310-150 (2)(c), and 246-310-140(4). The department shall furnish copies of its

request to the applicant for such additional information to the appropriate advisory review agencies. The department shall give public notice of such request for additional information through the same newspaper in which the "notification of beginning of review" for the project was published. The notice shall identify the project, the nature of the unresolved issue and the information requested of the applicant, and shall state the period of time allowed for receipt of written comments from interested persons.

(b) A person submitting a certificate of need application shall submit one original and one copy of the application to the certificate of need program of the department.

(c) On or before the last day of the applicable screening period for a certificate of need application, as prescribed in subsections (2) and (3) of this section, the department shall send a written notice to the person submitting the application stating whether or not the application has been declared complete. If an application has been found to be incomplete, the notice from the department shall specifically identify the portions of the application where the information provided has been found to be insufficient or indefinite and request supplemental information needed to complete the application.

(d) The department shall not request any supplemental information of a type not prescribed and published as being necessary to a certificate of need application for the type of project being proposed. The department may request clarification of information provided in the application.

(e) A response to the department's request for information to supplement an incomplete application shall be written.

(2) Screening and prereview activities.

(a) The department shall, within a fifteen working-day period for emergency, expedited, and regular reviews, screen the application to determine whether the information provided in the application is complete and as explicit as is necessary for a certificate of need review. This screening period shall begin on the first day after the department has received the application. In the event that the application is lacking significant information relating to the review criteria, the department may, upon notification, reserve the right to screen the application again upon receipt of the applicant's original response unless the applicant exercises option (c)(iii) of this subsection.

(b) The department shall return an incomplete certificate of need application to the person submitting the application if the department has not received a response to a request for the supplemental information sent in accordance with subsection (1)(c) of this section within forty-five days for emergency, expedited, and regular reviews unless extended by mutual agreement, and within one month for concurrent review after such request was sent.

(c) For emergency, expedited, and regular reviews, a person submitting a response to the department's request for supplemental information to complete a certificate of need application within forty-five days after the request was sent by the department, in accordance with subsection (1)(c) of this section, shall have the right to exercise one of the following options:

(i) Submission of written supplemental information and a written request that the information be screened and the applicant be given opportunity to submit further supplement-

tal information if the department determines that the application is still incomplete;

(ii) Submission of written supplemental information with a written request that review of the certificate of need application begin without the department notifying the applicant as to whether the supplemental information is adequate to complete the application; or

(iii) Submission of a written request that the application be reviewed without supplemental information.

(d) The department shall not accept responses to the department's screening letters later than ten days after the department has given "notification of beginning of review."

(e) For concurrent review a person submitting a response to the department's request for supplemental information to complete a certificate of need application within one month after the request was sent by the department, in accordance with subsection (1)(c) of this section, shall submit written supplemental information or a written request that the incomplete application be reviewed. The review shall begin in accordance with the published schedule.

(f) After receipt of a request for review of a certificate of need application, submitted in accordance with subsection (2)(c)(ii) or (iii) of this section, the department shall give notification of the beginning of review in the manner prescribed for a complete application in WAC 246-310-170.

(g) If a person requests the screening of supplemental information in accordance with subsection (2)(c)(i) of this section, such screening shall be carried out in the same number of days and in the same manner as required for an application in accordance with the provisions of subsection (1)(c) and (2)(a) of this section. The process of submitting and screening supplemental information may be repeated until the department declares the certificate of need application complete, the applicant requests that review of the incomplete application begin, or the one hundred twentieth day after the beginning of the first screening period for the application, whichever occurs first. The department shall return an application to the applicant if it is still incomplete on the one hundred twentieth day after the beginning of the first screening period and the applicant has not requested review of such incomplete application.

(3) Withdrawal of applications.

A certificate of need application shall be withdrawn from the certificate of need process if the department receives a written request for withdrawal of the application from the person submitting the application at any time before final action on such application has been taken by the secretary's designee.

(4) Resubmission of applications withdrawn or returned as incomplete.

A submission of a new certificate of need application shall be required for a certificate of need review of any undertaking for which the department has returned an incomplete application in accordance with subsection (2)(b) of this section, or for which a certificate of need application has been withdrawn in accordance with subsection (3) of this section. The content of the application should be updated as necessary before resubmission.

[Statutory Authority: Chapter 70.38 RCW. 96-24-052, § 246-310-090, filed 11/27/96, effective 12/28/96. Statutory Authority: RCW 70.38.135 and 70.38.919. 92-02-018 (Order 224), § 246-310-090, filed 12/23/91, effective 1/23/92. Statutory Authority: RCW 43.70.040. 91-02-049 (Order 121),



recodified as § 246-310-090, filed 12/27/90, effective 1/31/91. Statutory Authority: RCW 70.38.135. 86-06-030 (Order 2344), § 248-19-280, filed 2/28/86; 81-09-012 (Order 210), § 248-19-280, filed 4/9/81, effective 5/20/81. Statutory Authority: Chapter 70.38 RCW. 79-12-079 (Order 188), § 248-19-280, filed 11/30/79.]

**WAC 246-310-100 Amendment of certificate of need applications.** (1) The following changes to an application may be considered by the department an amendment of an application:

- (a) The addition of a new service or elimination of a service included in the original application.
  - (b) The expansion or reduction of a service included in the original application.
  - (c) An increase in the bed capacity.
  - (d) A change in the capital cost of the project or the method of financing the project.
  - (e) A significant change in the rationale used to justify the project.
  - (f) A change in the applicant.
- (2) Direct responses to screening questions will not be considered amendments.

(3) Amendments to certificate of need applications shall include information and documentation consistent with the requirements of WAC 246-310-090 (1)(a)(i) and (b).

(4) Application for emergency review. If an applicant changes an application during the screening period, the department shall determine whether the changed application constitutes a new application. An application changed during the review period shall be considered a new application.

(5) An application for expedited or regular review may be changed during the screening period or the public comment period.

(a) If an application is changed during the screening period or within the ten-day grace period following the beginning of review, the department shall determine whether the changed application constitutes an amended application. The applicant may submit written information to the department within five working days of receiving the department's determination indicating why the change should not be considered an amendment.

(b) The department shall respond within five working days of receiving the applicant's written information concerning whether the application changes constitute an amendment.

(c) When an application has been amended, the review period may be extended for a period not to exceed forty-five days.

(6) An application for concurrent review may be amended according to the following provisions:

(a) The department shall determine when an application has been amended.

(b) An amendment may be made through the first forty-five days of the concurrent review process. When the department determines an applicant has amended an application, the review period for all applications reviewed concurrently shall be extended by a single thirty-day period. The forty-five days for amendments shall be divided as follows:

(i) During the first thirty days an applicant or applicants may amend an application one or more times.

(ii) When an amendment has been made to an application in the first thirty days, all applicants may make one final amendment during the remaining fifteen days of the forty-five day period.

(iii) The department shall send written notice to all applicants when an amendment to an application is submitted.

(iv) If no amendment has been made to any application through the thirty-day period, no amendments may be made during the subsequent fifteen-day period.

(c) Any information submitted after the amendment period which has not been requested in writing by the department shall be returned to the person submitting the information and shall not be considered in the review of the application.

[Statutory Authority: Chapter 70.38 RCW. 96-24-052, § 246-310-100, filed 11/27/96, effective 12/28/96. Statutory Authority: RCW 70.38.135 and 70.38.919. 92-02-018 (Order 224), § 246-310-100, filed 12/23/91, effective 1/23/92. Statutory Authority: RCW 43.70.040. 91-02-049 (Order 121), recodified as § 246-310-100, filed 12/27/90, effective 1/31/91. Statutory Authority: RCW 70.38.135. 86-06-030 (Order 2344), § 248-19-295, filed 2/28/86.]

**WAC 246-310-110 Categories of review.** (1) In the review of any certificate of need application, one of the following review processes shall be used: Regular review, concurrent review, emergency review, or expedited review.

(2) Determination of review process.

The department shall determine which review process will be used in the review of a given certificate of need application.

(a) Emergency review.

(i) An emergency review may, with the written consent of the appropriate advisory review agencies, be conducted when an immediate capital expenditure is required in order for a health care facility to maintain or restore basic and essential patient services.

(ii) The department may determine an application submitted for emergency review does not qualify for such review. Such a determination and notification to the applicant shall be made within five days after receipt of the application. When the department makes a determination that an application is not subject to emergency review procedures, the application will be reviewed under another review process appropriate for the type of undertaking proposed. The department will notify the applicant of the other process under which the application will be reviewed.

(b) Expedited review.

An expedited review shall be conducted on a certificate of need application for the following:

(i) Projects proposed for the correction of deficiencies as described in WAC 246-310-480, except projects for the repair to or correction of deficiencies in the physical plant necessary to maintain state licensure, which are exempt from review by the provisions of WAC 246-310-020, if they do not substantially affect patient charges.

(ii) Demonstration or research projects: *Provided*, That such projects do not involve a change in bed capacity or the provision of a new tertiary health service.

(iii) Acquisition of an existing health care facility.

(iv) Projects limited to predevelopment expenditures.

(c) Regular review process.



The regular review process shall be used for any application unless the department has determined the emergency, expedited, or concurrent review process will be used in the review of such application. The regular review process will also be used to review applications for projects solely for the purposes listed in WAC 246-310-020 determined by the department to substantially affect patient charges, unless the project qualifies for an expedited review under subsection (2)(a)(i) of this section.

(d) Concurrent review process.

The concurrent review process shall be used for all applications determined to be competing in accordance with WAC 246-310-120.

[Statutory Authority: Chapter 70.38 RCW. 96-24-052, § 246-310-110, filed 11/27/96, effective 12/28/96. Statutory Authority: RCW 70.38.135 and 70.38.919. 92-02-018 (Order 224), § 246-310-110, filed 12/23/91, effective 1/23/92. Statutory Authority: RCW 43.70.040. 91-02-049 (Order 121), recodified as § 246-310-110, filed 12/27/90, effective 1/31/91. Statutory Authority: RCW 70.38.135. 86-06-030 (Order 2344), § 248-19-300, filed 2/28/86; 81-09-012 (Order 210), § 248-19-300, filed 4/9/81, effective 5/20/81. Statutory Authority: Chapter 70.38 RCW. 79-12-079 (Order 188), § 248-19-300, filed 11/30/79.]

**WAC 246-310-120 Concurrent review process. (1)**

Projects for which the department may establish concurrent review schedules are identified in RCW 70.38.115(7). An annual concurrent review has been scheduled for competing projects proposing:

(a) New nursing homes, not using bed allocations banked under the provisions of RCW 70.38.115(13);

(b) Nursing home bed additions, not using bed allocations banked under the provisions of RCW 70.38.115(13);

(c) The redistribution of beds from the following facility and service categories to nursing home beds:

(i) Acute care,

(ii) Boarding home, or

(iii) Intermediate care for the mentally retarded.

(2) Procedures for the concurrent review process shall be as follows:

(a) Submittal of initial applications.

(i) Each applicant shall submit one original and one copy of the application to the department.

(ii) Each applicant if requested in writing shall provide a copy of his or her application to the applicant of each other competing application.

(b) Screening of the initial applications.

(i) The department shall screen each initial application during the screening period of the applicable concurrent review cycle schedule.

(ii) The screening period shall begin on the first working day following the last day of the initial application submittal period for the applicable concurrent review cycle schedule.

(iii) The department by, the end of the screening period of the applicable concurrent review cycle schedule, shall send a written request for supplemental information to each applicant.

(iv) Each applicant, by the end of the final application submittal period, shall respond to the department's written request for supplemental information in one of the following ways:

(A) Submitting the requested written supplemental information, or

(B) Submitting a written request that the incomplete application be reviewed without supplemental information.

(c) Reviewing of final applications.

(i) The department shall commence the review of competing applications on the date prescribed for the applicable concurrent review cycle schedule.

(ii) The total number of days in the public comment and final review periods shall not exceed one hundred and thirty-five, unless extended in accordance with subsection (2)(d) of this section.

(iii) The public comment period shall be a maximum of ninety days from the beginning of the review period, unless the public comment period is extended in accordance with subsection (2)(d) of this section. The first sixty days of the public comment period is reserved for receiving public comment and conducting a public hearing, if requested. The remaining thirty days shall be reserved for the applicant or applicants to provide rebuttal statements to written or oral statements submitted during the first sixty-day period. Any interested party that:

(A) Is located or resides within the applicant's health service area;

(B) Testified or submitted evidence at a public hearing; and

(C) Requested in writing to be informed of the department's decision, shall also be provided the opportunity to provide rebuttal statements to written or oral statements submitted during the first sixty-day period.

(iv) The department shall conclude its final review and the secretary's designee shall take action on a certificate of need application within forty-five days after the end of the public comment period, unless extended in accordance with subsection (2)(d) of this section.

(d) Extending review of final applications.

(i) The public comment period shall be extended in accordance with the provisions of WAC 246-310-100.

(ii) The final review period may be extended by the department under the following provisions:

(A) The department informs each applicant of the competing applications of the existence of an unresolved pivotal issue.

(B) The department may make a written request for additional information from one or more of the applicants of the competing applications.

(C) The department shall specify in the written request a deadline for receipt of written responses.

(D) Each applicant receiving such written request may provide a written response within the specified deadline.

(E) The department may extend the final review period for all competing applications up to thirty days after the receipt of the last response to the department's request for additional information or after the specified deadline, whichever occurs first.

[Statutory Authority: Chapter 70.38 RCW. 96-24-052, § 246-310-120, filed 11/27/96, effective 12/28/96. Statutory Authority: RCW 70.38.135 and 70.38.919. 92-02-018 (Order 224), § 246-310-120, filed 12/23/91, effective 1/23/92. Statutory Authority: RCW 43.70.040. 91-02-049 (Order 121), recodified as § 246-310-120, filed 12/27/90, effective 1/31/91. Statutory Authority: RCW 70.38.115. 87-10-023 (Order 2487), § 248-19-327, filed 5/1/87. Statutory Authority: RCW 70.38.135. 86-06-030 (Order 2344), § 248-19-327, filed 2/28/86.]

**WAC 246-310-130 Nursing home concurrent review cycles.** (1) The department shall review concurrently during review cycles established under subsection (5) of this section the following:

(a) New nursing homes beds not using bed allocations banked under the provisions of RCW 70.38.115(13);

(b) Redistribution of beds from the following facility or service categories to skilled nursing care beds:

- (i) Acute care,
- (ii) Boarding home care.

(2) Undertakings by continuing care retirement communities (CCRCs), as defined in this section which do not propose or are not operating within a transition period as defined in this section during development, and which meet the following conditions, shall be reviewed under the regular review process per WAC 246-310-160:

(a) The number of nursing home beds requested in a single undertaking shall not exceed sixty; and

(b) After project completion, the number of nursing home beds, including those with which the CCRC contracts, shall not exceed one bed for each four independent living units within the CCRC. In computing this ratio, only independent living units of the CCRC already existing, and/or scheduled for completion at the same time as the proposed nursing home beds under the same financial feasibility plan, shall be counted.

(3) The annual nursing home concurrent review consists of the following cycles:

(a) One of the annual cycles is reserved for the review of competing applications submitted by or on behalf of:

(i) CCRCs applying for nursing home beds available from the statewide CCRC allotment as described in WAC 246-310-380(5); and

(ii) CCRCs which propose or are operating within a transition period during development and are not applying for nursing home beds available from any nursing home planning area.

(b) Two other cycles are established for review of competing applications for nursing home beds needed. The nursing home planning areas are divided into two separate groups.

(4) The department shall use the following nursing home concurrent review application filing procedures:

(a) Each applicant shall:

(i) File the required number of copies of each application as specified in the application information requirements, and

(ii) Mail or deliver the application so that the department receives it no later than the last day for initial application receipt as prescribed in the schedule for that concurrent review cycle.

(b) The department shall:

(i) Only review applications for which a letter of intent, as described in WAC 246-310-080, was mailed or delivered to the department before the last day for receipt of letters of intent as indicated below;

(ii) Begin screening all applications received during the initial application period on the first working day following the close of that period; and

(iii) Return to the applicant any application received after the last day of the initial application receipt period.

(5) The schedules for the annual nursing home bed concurrent review cycles shall be as follows:

(a) For those applications described in subsection (3)(a) of this section, the concurrent review cycle schedule shall be as follows:

(i) Period for receipt of letters of intent shall begin on the first working day of June and end on the first working day of July,

(ii) Period for receipt of initial applications shall begin on the first working day of July and end on the first working day of August,

(iii) End of initial application completeness screening period is the first working day of September,

(iv) End of final application receipt period is the first working day of October, and

(v) Beginning of concurrent review period is October 16 or first working day after that date.

(b) For competing applications submitted for nursing home beds available for the Chelan/Douglas, Clallam, Clark/Skamania, Cowlitz, Grant, Grays Harbor, Island, Jefferson, King, Kittitas, Klickitat, Okanogan, Pacific, San Juan, Skagit, Spokane, and Yakima nursing home planning areas, the concurrent review cycle schedule shall be as follows:

(i) Period for receipt of letters of intent shall begin on the first working day of July and end on the first working day of August,

(ii) Period for receipt of initial applications shall begin on the first working day of August and end on the first working day of September,

(iii) End of initial application completeness screening period is the first working day of October,

(iv) End of final application receipt period is the first working day of November, and

(v) Beginning of concurrent review period is November 16 or first working day after that date.

(c) For competing applications submitted for nursing home beds available for the Adams, Asotin, Benton, Columbia, Ferry, Franklin, Garfield, Kitsap, Lewis, Lincoln, Mason, Pend Oreille, Pierce, Snohomish, Stevens, Thurston, Wahkiakum, Walla Walla, Whatcom, and Whitman nursing home planning areas, the concurrent review cycle schedule shall be as follows:

(i) Period for receipt of letters of intent shall begin on the first working day of August and end on the first working day of September,

(ii) Period for receipt of initial applications shall begin on the first working day of September and end on the first working day of October,

(iii) End of initial application completeness screening period is the first working day of November,

(iv) End of final application receipt period is the first working day of December, and

(v) Beginning of concurrent review period is December 16 or first working day after that date.

[Statutory Authority: Chapter 70.38 RCW. 96-24-052, § 246-310-130, filed 11/27/96, effective 12/28/96. Statutory Authority: RCW 70.38.135 and 70.38.919. 92-02-018 (Order 224), § 246-310-130, filed 12/23/91, effective 1/23/92. Statutory Authority: RCW 43.70.040. 91-02-049 (Order 121), recodified as § 246-310-130, filed 12/27/90, effective 1/31/91. Statutory Authority: RCW 70.38.115. 88-24-026 (Order 2736), § 248-19-328, filed 12/2/88. Statutory Authority: RCW 70.38.115 and 70.38.135. 88-04-047 (Order 2591), § 248-19-328, filed 1/29/88. Statutory Authority: RCW 70.38.115. 87-10-023 (Order 2487), § 248-19-328, filed 5/1/87.]

**WAC 246-310-132 Open heart surgery concurrent review cycle.** (1) The department shall review new open heart surgery services using the concurrent review cycle in this section.

(2) Certificate of need applications shall be submitted and reviewed according to the following schedule and procedures.

(a) Letters of intent shall be submitted between the first working day and last working day of July of each year.

(b) Initial applications shall be submitted between the first working day and last working day of August of each year.

(c) The department shall screen initial applications for completeness by the last working day of September of each year.

(d) Responses to screening questions shall be submitted by the last working day of October of each year.

(e) The public review and comment period for applications shall begin on November 16 of each year. In the event that November 16 is not a working day in any year, then the public review and comment period shall begin on the first working day after November 16.

(f) The public comment period shall be limited to ninety days, unless extended according to the provisions of WAC 246-310-120 (2)(d). The first sixty days of the public comment period shall be reserved for receiving public comments and conducting a public hearing, if requested. The remaining thirty days shall be for the applicant or applicants to provide rebuttal statements to written or oral statements submitted during the first sixty-day period. Any interested party that:

(i) Is located or resides within the applicant's health service area;

(ii) Testified or submitted evidence at a public hearing; and

(iii) Requested in writing to be informed of the department's decision, shall also be provided the opportunity to provide rebuttal statements to written or oral statements submitted during the first sixty-day period.

(g) The final review period shall be limited to sixty days, unless extended according to the provisions of WAC 246-310-120 (2)(d).

(3) Any letter of intent or certificate of need application submitted for review in advance of this schedule, or certificate of need application under review as of the effective date of this section, shall be held by the department for review according to the schedule in this section.

[Statutory Authority: Chapter 70.38 RCW. 96-24-052, § 246-310-132, filed 11/27/96, effective 12/28/96. Statutory Authority: RCW 70.38.135. 92-16-081 (Order 293) § 246-310-132, filed 8/4/92 effective 9/4/92; 91-17-011 (Order 188), § 246-310-132, filed 8/12/91, effective 8/28/91.]

**WAC 246-310-135 Ethnic minority nursing home bed pool—Procedures.** (1) The department is establishing a pool of two hundred fifty nursing home beds to serve the special needs of ethnic minorities. This pool shall be made up of nursing home beds that have become available on or after March 15, 1991, due to:

(a) Loss of license or reduction in licensed bed capacity of existing nursing homes, if the beds are not otherwise obligated for replacement as evidenced by a certificate of need authorizing such replacement; or

(b) Expiration or surrender of a certificate of need.

(2) Applications for construction or establishment of ethnic minority nursing home beds shall be reviewed in concurrent review cycles published by the department in rules.

(3) The department may award up to one hundred nursing home beds to a qualified applicant or applicants in the first concurrent review, and before those beds are in the ethnic minority bed pool.

(4) A second concurrent review cycle shall not be conducted until at least two hundred beds are in the ethnic minority bed pool, including the number of beds awarded in the first concurrent review. In this review cycle the department shall award at least one hundred beds and may award as many as one hundred fifty beds to a qualified applicant or applicants. In addition, the department may award any beds not awarded in the first concurrent review, provided any decision not to award those beds is not under appeal. The schedule for the second concurrent review shall be published in rule after at least two hundred beds are in the ethnic minority bed pool.

(5) The department shall conduct additional concurrent review cycles to award beds to qualified applicants when fewer than two hundred fifty beds are awarded in the first and second concurrent reviews, or when beds are returned to the ethnic minority bed pool under the provisions of WAC 246-310-020(3). Such additional concurrent reviews shall be conducted according to schedules published in rules. The department shall schedule additional concurrent reviews when the department determines an adequate number of nursing home beds are in the pool to justify such reviews.

[Statutory Authority: Chapter 70.38 RCW. 96-24-052, § 246-310-135, filed 11/27/96, effective 12/28/96. Statutory Authority: RCW 70.38.135 (3)(c). 92-05-057 (Order 244), § 246-310-135, filed 2/14/92, effective 3/16/92.]

**WAC 246-310-136 Ethnic minority nursing home bed pool—Considerations for review of applications.** (1) The department shall consider the following factors in the course of reviewing and making decisions on applications for construction or establishment of nursing home beds for ethnic minorities.

(a) Conformance with applicable review criteria in WAC 246-310-210, 246-310-220, 246-310-230, and 246-310-240;

(b) Which competing applications best meet identified needs, consistent with the purpose of concurrent review as stated in RCW 70.38.115(7).

(c) The relative degree to which the long-term care needs of an ethnic minority among Washington residents are not otherwise being met. This includes consideration of the legislature's finding that certain ethnic minorities have special cultural, language, dietary, and other needs not generally met by existing nursing homes which are intended to serve the general population;

(d) The percentage of low-income persons who would be served by the proposed project; and

(e) The impact of the proposal on the area's total need for nursing home beds.

(2) To be eligible to apply for and receive an award of beds from the ethnic nursing home bed pool, an application

must be to construct, develop, or establish a new nursing home or add beds to an existing nursing home that:

(a) Shall be owned and operated by a nonprofit corporation. At least fifty percent of the board of directors of the corporation are members of the ethnic minority the nursing home is intended to serve;

(b) Shall be designed, managed, and administered to serve the special cultural, language, dietary, and other needs of the ethnic minority; and

(c) Shall not discriminate in admissions against persons who are not members of the ethnic minority whose special needs the nursing home is designed to serve.

(3) An applicant not awarded beds in a concurrent review shall not be given preference over other applicants in any subsequent concurrent review on the basis of the prior review and decision when that applicant submits a new application for another review.

[Statutory Authority: Chapter 70.38 RCW. 96-24-052, § 246-310-136, filed 11/27/96, effective 12/28/96. Statutory Authority: RCW 70.38.135 (3)(c). 92-05-057 (Order 244), § 246-310-136, filed 2/14/92, effective 3/16/92.]

**WAC 246-310-140 Emergency review process.** (1)

The emergency review process shall not exceed fifteen working days from the beginning of the review period.

(2) The department shall complete its final review and the secretary's designee shall make his or her decision on an emergency certificate of need application within fifteen working days after the beginning of the review period unless the department extends its final review period in accordance with the provisions of subsection (3) of this section.

(3) If an issue, which is pivotal to the decision of the secretary's designee remains unresolved, the department may make one request for additional information from the person submitting the application. The department may extend its final emergency review period up to but not exceeding ten days after receipt of the applicant's written response to the department's request for information.

[Statutory Authority: Chapter 70.38 RCW. 96-24-052, § 246-310-140, filed 11/27/96, effective 12/28/96. Statutory Authority: RCW 43.70.040, 91-02-049 (Order 121), recodified as § 246-310-140, filed 12/27/90, effective 1/31/91. Statutory Authority: RCW 70.38.135, 86-06-030 (Order 2344), § 248-19-350, filed 2/28/86; 82-19-055 (Order 244), § 248-19-350, filed 9/15/82; 81-09-012 (Order 210), § 248-19-350, filed 4/9/81, effective 5/20/81. Statutory Authority: Chapter 70.38 RCW. 79-12-079 (Order 188), § 248-19-350, filed 11/30/79.]

**WAC 246-310-150 Expedited review process.** (1)

The expedited review process shall not exceed fifty days from the beginning of the review period unless extended in accordance with the provisions of subsection (2) of this section.

(a) The public comment period shall be limited to thirty days. The first twenty days of the public comment period shall be reserved for receiving public comments. The remaining ten days shall be for the applicant or applicants to provide rebuttal statements to written or oral statements submitted during the first twenty-day period. Any interested party that:

(i) Is located or resides within the applicant's health service area;

(ii) Testified or submitted evidence at a public hearing; and

(iii) Requested in writing to be informed of the department's decision, shall also be provided the opportunity to provide rebuttal statements to written or oral statements submitted during the first twenty-day period.

(b) The department shall complete its final review and the secretary's designee shall make his or her decision on a certificate of need application under an expedited review within twenty days of the end of the public comment period.

(2) The review period for an expedited review may be extended according to the following provisions:

(a) The review period may be extended an additional forty-five days in accordance with WAC 246-310-100. The department may grant further extensions to this review period: *Provided*, The person submitting the certificate of need application gives written consent to further extension.

(b) If an issue, which is pivotal to the decision of the secretary's designee remains unresolved, the department may make one request for additional information from the person submitting the application. The department may extend its final expedited review period up to but not exceeding thirty days after receipt of the applicant's written response to the department's request for information.

(c) The department may extend its final review period upon receipt of a written request of the person submitting the application: *Provided however*, That such an extension shall not exceed sixty days.

[Statutory Authority: Chapter 70.38 RCW. 96-24-052, § 246-310-150, filed 11/27/96, effective 12/28/96. Statutory Authority: RCW 70.38.135 and 70.38.919, 92-02-018 (Order 224), § 246-310-150, filed 12/23/91, effective 1/23/92. Statutory Authority: RCW 43.70.040, 91-02-049 (Order 121), recodified as § 246-310-150, filed 12/27/90, effective 1/31/91. Statutory Authority: RCW 70.38.135, 86-06-030 (Order 2344), § 248-19-340, filed 2/28/86; 82-19-055 (Order 244), § 248-19-340, filed 9/15/82; 81-09-012 (Order 210), § 248-19-340, filed 4/9/81, effective 5/20/81. Statutory Authority: Chapter 70.38 RCW. 79-12-079 (Order 188), § 248-19-340, filed 11/30/79.]

**WAC 246-310-160 Regular review process.** (1)

The regular review process shall not exceed ninety days from the beginning of the review period and shall be conducted in accordance with this section unless the review period is extended in accordance with the provisions of subsection (2) of this section.

(a) The public comment period shall be limited to forty-five days. The first thirty-five days of the public comment period shall be reserved for receiving public comments and conducting a public hearing, if requested. The remaining ten days shall be reserved for the applicant to provide rebuttal statements to written or oral statements submitted during the first thirty-five day period. Any interested party that:

(i) Is located or resides within the applicant's health service area;

(ii) Testified or submitted evidence at a public hearing; and

(iii) Requested in writing to be informed of the department's decision, shall also be provided the opportunity to provide rebuttal statements to written or oral statements submitted during the first thirty-five day period.

(b) The department shall complete its final review and the secretary's designee shall make a decision on a certificate of need application within forty-five days of the end of the public comment period.

(2) The review period for a regular review may be extended according to the following provisions:

(a) The public comment period may be extended for up to an additional forty-five days in accordance with WAC 246-310-100. The department may grant further extensions to this review period: *Provided*, The person submitting the certificate of need application gives written consent to such further extensions.

(b) If an issue, which is pivotal to the decision of the secretary's designee remains unresolved, the department may make one request for additional information from the person submitting the application. The department may extend its final review period up to but not exceeding thirty days after receipt of the applicant's written response to the department's request for information.

(c) The department may extend either the public comment period or the department's final review period upon receipt of a written request of the person submitting the application: *Provided however*, That such an extension shall not exceed ninety days.

[Statutory Authority: Chapter 70.38 RCW. 96-24-052, § 246-310-160, filed 11/27/96, effective 12/28/96. Statutory Authority: RCW 70.38.135 and 70.38.919. 92-02-018 (Order 224), § 246-310-160, filed 12/23/91, effective 1/23/92. Statutory Authority: RCW 43.70.040. 91-02-049 (Order 121), recodified as § 246-310-160, filed 12/27/90, effective 1/31/91. Statutory Authority: RCW 70.38.135. 86-06-030 (Order 2344), § 248-19-330, filed 2/28/86; 82-19-055 (Order 244), § 248-19-330, filed 9/15/82; 81-09-012 (Order 210), § 248-19-330, filed 4/9/81, effective 5/20/81. Statutory Authority: Chapter 70.38 RCW. 79-12-079 (Order 188), § 248-19-330, filed 11/30/79.]

**WAC 246-310-170 Notification of beginning of review.** (1) Notice required.

The department shall provide written notification of the beginning of the review of a certificate of need application and notification of the beginning of the review of a proposed withdrawal of a certificate of need to affected persons and any other person submitting a written request that the person's name be on the mailing list for such notice. Notification of the beginning of the review of a certificate of need application shall be provided through a newspaper of general circulation in the health service area of the project.

(2) Specific notice requirements.

(a) The department shall give "notification of the beginning of review" of an application after the department has received an application or the applicant's request, submitted in accordance with WAC 246-310-090 (2)(c), that review of the application begin. Such notice shall be given according to the following requirements:

(i) Emergency review.

When an application is being reviewed under the emergency review process, required notices shall be given within five working days following the receipt of a complete application or the applicant's written request that review of the application begin.

(ii) Expedited and regular review.

When an application is being reviewed under the expedited or regular review process, required notices shall be given within five working days of a declaration that the application is complete or the applicant's request that review of the application begin.

(b) The department shall give notification of the beginning of the review of a proposed withdrawal of a

certificate of need when the department determines there may be good cause to withdraw a certificate of need.

(c) The notices shall include:

(i) The procedures for receiving copies of applications, supplemental information and department decisions;

(ii) A general description of the project;

(iii) In the case of a proposed withdrawal of a certificate of need, the reasons for the proposed withdrawal;

(iv) The proposed review schedule;

(v) The period within which one or more affected persons may request a public hearing;

(vi) The name and address of the agency to which a request for a public hearing should be sent;

(vii) The manner in which notification will be provided of the time and place of any hearing so requested;

(viii) Notice that any affected person wishing to receive notification of a meeting on the application called by the department after the end of the public comment period shall submit a written request to the department to receive notification of such meetings; and

(ix) The period within which any affected person may request notification of the meetings referenced in subsection (2)(c)(viii) of this section.

(d) The notices to other affected persons shall be mailed on the same date the notice to the public is mailed to the newspaper for publication.

(3) Beginning of review.

(a) Review of a certificate of need application under the expedited or regular review process shall begin on the day the department sends notification of the beginning of review to the general public and other affected persons unless the department has received a written request from the applicant pursuant to WAC 246-310-090 (2)(c)(iii), in which case review shall begin upon receipt of such request.

(b) Review of certificate of need applications under the concurrent review process shall begin fifteen days after the conclusion of the published time period for the submission of final applications subject to concurrent review.

(c) Review of a certificate of need application under emergency review shall begin on the first day after the date on which the department has determined the application is complete, or has received a written request to begin review submitted by the applicant in accordance with WAC 246-310-090 (2)(c).

(d) Review of a proposed withdrawal of a certificate of need shall begin on the day the department sends notification of the beginning of review to the general public and to other affected persons.

[Statutory Authority: Chapter 70.38 RCW. 96-24-052, § 246-310-170, filed 11/27/96, effective 12/28/96. Statutory Authority: RCW 70.38.135 and 70.38.919. 92-02-018 (Order 224), § 246-310-170, filed 12/23/91, effective 1/23/92. Statutory Authority: RCW 43.70.040. 91-02-049 (Order 121), recodified as § 246-310-170, filed 12/27/90, effective 1/31/91. Statutory Authority: RCW 70.38.135. 86-06-030 (Order 2344), § 248-19-310, filed 2/28/86; 81-09-012 (Order 210), § 248-19-310, filed 4/9/81, effective 5/20/81. Statutory Authority: Chapter 70.38 RCW. 79-12-079 (Order 188), § 248-19-310, filed 11/30/79.]

**WAC 246-310-180 Public hearings.** (1) "Opportunity for a public hearing," as used in this section, shall mean a public hearing will be conducted if a valid request for such a hearing has been submitted by one or more affected persons.

(2) The department shall provide opportunity to affected persons for a public hearing on:

(a) A certificate of need application under review, unless the application is being reviewed according to the emergency or expedited review processes; and

(b) The proposed withdrawal of a certificate of need.

(3) To be valid, a request for a public hearing on a certificate of need application or on the proposed withdrawal of a certificate of need shall:

(a) Be submitted in writing;

(b) Be received by the department within fifteen days after the date on which the department's "notification of beginning of review" for the particular certificate of need application or proposed withdrawal of a certificate of need was published in a newspaper of general circulation; and

(c) Include identification of the particular certificate of need application or proposed certificate of need withdrawal for which the public hearing is requested and the full name, complete address, and signature of the person making the request.

(4) The department shall give written notice of a public hearing conducted pursuant to this section.

(a) Written notice shall be given to affected persons and the public at least fifteen days prior to the beginning of the public hearing.

(b) The notices shall include: Identification of the certificate of need application or certificate of need on which the public hearing is to be conducted and the date, time, and location of the public hearing.

(c) Notice to the general public to be served by the proposed project to which the certificate of need application or certificate of need pertains shall be through a newspaper of general circulation in the health service area of the proposed project. The notices to other affected persons shall be mailed on the same date the notice to the public is mailed to the newspaper for publication.

(5) In a public hearing on a certificate of need application or on a proposed withdrawal of a certificate of need, any person shall have the right to be represented by counsel and to present oral or written arguments and evidence relevant to the subject matter of the hearing. Any person affected by the matter may conduct reasonable questioning of persons who make relevant factual allegations.

(6) The department shall maintain a verbatim record of a public hearing and shall not impose fees for the hearing.

(7) The department shall not be required to conduct a public hearing on a certificate of need application being reviewed according to the emergency or expedited review procedures.

(8) The department may conduct a public hearing in the absence of a request as identified in subsection (3) of this section, if the department determines it is in the best interest of the public.

[Statutory Authority: Chapter 70.38 RCW. 96-24-052, § 246-310-180, filed 11/27/96, effective 12/28/96. Statutory Authority: RCW 70.38.135 and 70.38.919. 92-02-018 (Order 224), § 246-310-180, filed 12/23/91, effective 1/23/92. Statutory Authority: RCW 43.70.040. 91-02-049 (Order 121), recodified as § 246-310-180, filed 12/27/90, effective 1/31/91. Statutory Authority: RCW 70.38.135. 86-06-030 (Order 2344), § 248-19-320, filed 2/28/86; 81-09-012 (Order 210), § 248-19-320, filed 4/9/81, effective 5/20/81. Statutory Authority: Chapter 70.38 RCW. 79-12-079 (Order 188), § 248-19-320, filed 11/30/79.]

**WAC 246-310-190 Ex parte contacts.** (1) There shall be no ex parte contacts as defined in WAC 246-310-010 after whichever of the following occurs last:

(a) The conclusion of a public hearing held in accordance with WAC 246-310-180, or

(b) The end of the public comment period.

(2) Any of the following communications shall not be considered ex parte contacts:

(a) A communication regarding the procedure or process of the review.

(b) A communication made in a meeting open to the public requested by the department and reasonable notice of the meeting has been given to the applicant, all applicants in a concurrent review, and all persons having previously requested in writing to be notified of all such meetings or written requests for information concerning a specific application for certificate of need or a specific proposed withdrawal of a certificate of need.

(c) A written request for information made by the department and provided to all persons specified in subsection (2)(b) of this section.

(d) A response to a request made by the department in a meeting held in accordance with subsection (2)(b) of this section or in response to subsection (2)(c) of this section, and submitted to the department and to all persons specified in subsection (2)(b) of this section.

[Statutory Authority: Chapter 70.38 RCW. 96-24-052, § 246-310-190, filed 11/27/96, effective 12/28/96. Statutory Authority: RCW 70.38.135 and 70.38.919. 92-02-018 (Order 224), § 246-310-190, filed 12/23/91, effective 1/23/92. Statutory Authority: RCW 43.70.040. 91-02-049 (Order 121), recodified as § 246-310-190, filed 12/27/90, effective 1/31/91. Statutory Authority: RCW 70.38.135. 86-06-030 (Order 2344), § 248-19-326, filed 2/28/86.]

**WAC 246-310-200 Bases for findings and action on applications.** (1) The findings of the department's review of certificate of need applications and the action of the secretary's designee on such applications shall, with the exceptions provided for in WAC 246-310-470 and 246-310-480 be based on determinations as to:

(a) Whether the proposed project is needed;

(b) Whether the proposed project will foster containment of the costs of health care;

(c) Whether the proposed project is financially feasible; and

(d) Whether the proposed project will meet the criteria for structure and process of care identified in WAC 246-310-230.

(2) Criteria contained in this section and in WAC 246-310-210, 246-310-220, 246-310-230, and 246-310-240 shall be used by the department in making the required determinations.

(a) In the use of criteria for making the required determinations, the department shall consider:

(i) The consistency of the proposed project with service or facility standards contained in this chapter;

(ii) In the event the standards contained in this chapter do not address in sufficient detail for a required determination the services or facilities for health services proposed, the department may consider standards not in conflict with those standards in accordance with subsection (2)(b) of this section; and



(iii) The relationship of the proposed project to the long-range plan (if any) of the person proposing the project.

(b) The department may consider any of the following in its use of criteria for making the required determinations:

(i) Nationally recognized standards from professional organizations;

(ii) Standards developed by professional organizations in Washington state;

(iii) Federal Medicare and Medicaid certification requirements;

(iv) State licensing requirements;

(v) Applicable standards developed by other individuals, groups, or organizations with recognized expertise related to a proposed undertaking; and

(vi) The written findings and recommendations of individuals, groups, or organizations with recognized expertise related to a proposed undertaking, with whom the department consults during the review of an application.

(c) At the request of an applicant, the department shall identify the criteria and standards it will use prior to the submission and screening of a certificate of need application: *Provided however*, That when a person requests identification of criteria and standards prior to the submission of an application, the person shall submit such descriptive information on a project as is determined by the department to be reasonably necessary in order to identify the applicable criteria and standards. The department shall respond to such request within fifteen working days of its receipt. In the absence of an applicant's request under this subsection, the department shall identify the criteria and standards it will use during the screening of a certificate of need application. The department shall inform the applicant about any consultation services it will use in the review of a certificate of need application prior to the use of such consultation services.

(d) Representatives of the department or consultants whose services are engaged by the department may make an on-site visit to a health care facility, or other place for which a certificate of need application is under review, or for which a proposal to withdraw a certificate of need is under review when the department deems such an on-site visit is necessary and appropriate to the department's review of a proposed project.

[Statutory Authority: Chapter 70.38 RCW. 96-24-052, § 246-310-200, filed 11/27/96, effective 12/28/96. Statutory Authority: RCW 70.38.135 and 70.38.919. 92-02-018 (Order 224), § 246-310-200, filed 12/23/91, effective 1/23/92. Statutory Authority: RCW 43.70.040. 91-02-049 (Order 121), recodified as § 246-310-200, filed 12/27/90, effective 1/31/91. Statutory Authority: RCW 70.38.135. 85-05-032 (Order 2208), § 248-19-360, filed 2/15/85; 81-09-012 (Order 210), § 248-19-360, filed 4/9/81, effective 5/20/81. Statutory Authority: Chapter 70.38 RCW. 79-12-079 (Order 188), § 248-19-360, filed 11/30/79.]

**WAC 246-310-210 Determination of need.** The determination of need for any project shall be based on the following criteria, except these criteria will not justify exceeding the limitation on increases of nursing home beds provided in WAC 246-310-810.

(1) The population served or to be served has need for the project and other services and facilities of the type proposed are not or will not be sufficiently available or accessible to meet that need. The assessment of the conformance of a project with this criterion shall include, but need not be limited to, consideration of the following:

(a) In the case of a reduction, relocation, or elimination of a service, the need the population presently served has for the service, the extent to which the need will be met adequately by the proposed relocation or by alternative arrangements, and the effect of the reduction, elimination, or relocation of the service on the ability of low-income persons, racial and ethnic minorities, women, handicapped persons, and other underserved groups and the elderly to obtain needed health care;

(b) In the case of health services or facilities proposed to be provided, the efficiency and appropriateness of the use of existing services and facilities similar to those proposed;

(c) In the case of an application by an osteopathic or allopathic facility the need for and the availability in the community of services and facilities for osteopathic and allopathic physicians and their patients, and the impact on existing and proposed institutional training programs for doctors of osteopathy and medicine at the student, internship, and residency training levels; and

(d) In the case of a project not involving health services, the contribution of the project toward overall management and support of such services.

(2) All residents of the service area, including low-income persons, racial and ethnic minorities, women, handicapped persons, and other underserved groups and the elderly are likely to have adequate access to the proposed health service or services. The assessment of the conformance of a project with this criterion shall include, but not be limited to, consideration as to whether the proposed services makes a contribution toward meeting the health-related needs of members of medically underserved groups which have traditionally experienced difficulties in obtaining equal access to health services, particularly those needs identified in the applicable regional health plan, annual implementation plan, and state health plan as deserving of priority. Such consideration shall include an assessment of the following:

(a) The extent to which medically underserved populations currently use the applicant's services in comparison to the percentage of the population in the applicant's service area which is medically underserved, and the extent to which medically underserved populations are expected to use the proposed services if approved;

(b) The past performance of the applicant in meeting obligations, if any, under any applicable federal regulations requiring provision of uncompensated care, community service, or access by minorities and handicapped persons to programs receiving federal financial assistance (including the existence of any unresolved civil rights access complaints against the applicant);

(c) The extent to which Medicare, Medicaid, and medically indigent patients are served by the applicant; and

(d) The extent to which the applicant offers a range of means by which a person will have access to its services (e.g., outpatient services, admission by house staff, admission by personal physician).

(3) The applicant has substantiated any of the following special needs and circumstances the proposed project is to serve.

(a) The special needs and circumstances of entities such as medical and other health professions schools, multidisciplinary clinics and specialty centers providing a substantial portion of their services or resources, or both, to individuals



not residing in the health service areas in which the entities are located or in adjacent health service areas.

(b) The special needs and circumstances of biomedical and behavioral research projects designed to meet a national need and for which local conditions offer special advantages.

(c) The special needs and circumstances of osteopathic hospitals and nonallopathic services.

(4) The project will not have an adverse effect on health professional schools and training programs. The assessment of the conformance of a project with this criterion shall include consideration of:

(a) The effect of the means proposed for the delivery of health services on the clinical needs of health professional training programs in the area in which the services are to be provided; and

(b) If proposed health services are to be available in a limited number of facilities, the extent to which the health professions schools serving the area will have access to the services for training purposes.

(5) The project is needed to meet the special needs and circumstances of enrolled members or reasonably anticipated new members of a health maintenance organization or proposed health maintenance organization and the services proposed are not available from nonhealth maintenance organization providers or other health maintenance organizations in a reasonable and cost-effective manner consistent with the basic method of operation of the health maintenance organization or proposed health maintenance organization. In assessing the availability of health services from these providers, the department shall consider only whether the services from these providers:

(a) Would be available under a contract of at least five years' duration;

(b) Would be available and conveniently accessible through physicians and other health professionals associated with the health maintenance organization or proposed health maintenance organization (for example - whether physicians associated with the health maintenance organization have or will have full staff privileges at a nonhealth maintenance organization hospital);

(c) Would cost no more than if the services were provided by the health maintenance organization or proposed health maintenance organization; and

(d) Would be available in a manner administratively feasible to the health maintenance organization or proposed health maintenance organization.

(6) For nursing home projects including distinct part long-term care units located in a hospital and licensed under chapter 70.41 RCW, the following criterion shall apply in addition to those found in WAC 246-310-380.

(a) In the case of an application for new nursing home beds, the department shall find no need if the state is at or above the state-wide estimated bed need, except as referenced in WAC 246-310-380(5). However, the department may put under review and subsequently approve or deny applications that propose to redistribute nursing home beds to a planning area under the established ratio. The department may also consider applications that propose to add beds in planning areas under the established ratio using beds banked and for which the need for the beds is not deemed met, under the provisions of RCW 70.38.115(13). For the above projects, the need for such projects, shall, in part, be

determined using individual planning area estimated bed need numbers.

(b) If the state is below the state-wide estimated bed need or for those projects referenced above, the department shall determine the need for nursing home beds, including distinct part long-term care units located in a hospital licensed under chapter 70.41 RCW, based on:

(i) The availability of other nursing home beds in the planning area to be served; and

(ii) The availability of other services in the planning area to be served. Other services to be considered include, but are not limited to: Assisted living (as defined in chapter 74.39A RCW); boarding home (as defined in chapter 18.20 RCW); enhanced adult residential care (as defined in chapter 74.39A RCW); adult residential care (as defined in chapter 74.39A RCW); adult family homes (as defined in chapter 70.128 RCW); hospice, home health and home care (as defined in chapter 70.127 RCW); personal care services (as defined in chapter 74.09 RCW); and home and community services provided under the community options program entry system waiver (as referenced in chapter 74.39A RCW). The availability of other services shall be based on data which demonstrates that the other services are capable of adequately meeting the needs of the population proposed to be served by the applicant. The following variables should be evaluated in this analysis when available:

(A) The current capacity of nursing homes and other long-term care services;

(B) The occupancy rates of nursing homes and other long-term care services over the previous two-year period;

(C) Proposed residential care projects scheduled to be completed within the same period of time indicated on the nursing home certificate of need application; and

(D) The ability of the other long-term care services to serve all people regardless of payor source.

[Statutory Authority: Chapter 70.38 RCW. 96-24-052, § 246-310-210, filed 11/27/96, effective 12/28/96. Statutory Authority: RCW 70.38.135 and 70.38.919. 92-02-018 (Order 224), § 246-310-210, filed 12/23/91, effective 1/23/92. Statutory Authority: RCW 43.70.040. 91-02-049 (Order 121), recodified as § 246-310-210, filed 12/27/90, effective 1/31/91. Statutory Authority: RCW 70.38.135. 85-05-032 (Order 2208), § 248-19-370, filed 2/15/85; 81-09-012 (Order 210), § 248-19-370, filed 4/9/81, effective 5/20/81. Statutory Authority: Chapter 70.38 RCW. 79-12-079 (Order 188), § 248-19-370, filed 11/30/79.]

**WAC 246-310-220 Determination of financial feasibility.** The determination of financial feasibility of a project shall be based on the following criteria.

(1) The immediate and long-range capital and operating costs of the project can be met.

(2) The costs of the project, including any construction costs, will probably not result in an unreasonable impact on the costs and charges for health services.

(3) The project can be appropriately financed.

[Statutory Authority: RCW 43.70.040. 91-02-049 (Order 121), recodified as § 246-310-220, filed 12/27/90, effective 1/31/91. Statutory Authority: Chapter 70.38 RCW. 79-12-079 (Order 188), § 248-19-380, filed 11/30/79.]

**WAC 246-310-230 Criteria for structure and process of care.** A determination that a project fosters an

acceptable or improved quality of health care shall be based on the following criteria.

(1) A sufficient supply of qualified staff for the project, including both health personnel and management personnel, are available or can be recruited.

(2) The proposed service(s) will have an appropriate relationship, including organizational relationship, to ancillary and support services, and ancillary and support services will be sufficient to support any health services included in the proposed project.

(3) There is reasonable assurance that the project will be in conformance with applicable state licensing requirements and, if the applicant is or plans to be certified under the Medicaid or Medicare program, with the applicable conditions of participation related to those programs.

(4) The proposed project will promote continuity in the provision of health care, not result in an unwarranted fragmentation of services, and have an appropriate relationship to the service area's existing health care system.

(5) There is reasonable assurance that the services to be provided through the proposed project will be provided in a manner that ensures safe and adequate care to the public to be served and in accord with applicable federal and state laws, rules, and regulations. The assessment of the conformance of a project to this criterion shall include but not be limited to consideration as to whether:

(a) The applicant or licensee has no history, in this state or elsewhere, of a criminal conviction which is reasonably related to the applicant's competency to exercise responsibility for the ownership or operation of a health care facility, a denial or revocation of a license to operate a health care facility, a revocation of a license to practice a health profession, or a decertification as a provider of services in the Medicare or Medicaid program because of failure to comply with applicable federal conditions of participation; or

(b) If the applicant or licensee has such a history, whether the applicant has affirmatively established to the department's satisfaction by clear, cogent and convincing evidence that the applicant can and will operate the proposed project for which the certificate of need is sought in a manner that ensures safe and adequate care to the public to be served and conforms to applicable federal and state requirements.

[Statutory Authority: Chapter 70.38 RCW. 96-24-052, § 246-310-230, filed 11/27/96, effective 12/28/96. Statutory Authority: RCW 43.70.040. 91-02-049 (Order 121), recodified as § 246-310-230, filed 12/27/90, effective 1/31/91. Statutory Authority: RCW 70.38.135. 81-09-012 (Order 210), § 248-19-390, filed 4/9/81, effective 5/20/81. Statutory Authority: Chapter 70.38 RCW. 79-12-079 (Order 188), § 248-19-390, filed 11/30/79.]

**WAC 246-310-240 Determination of cost containment.** A determination that a proposed project will foster cost containment shall be based on the following criteria:

(1) Superior alternatives, in terms of cost, efficiency, or effectiveness, are not available or practicable.

(2) In the case of a project involving construction:

(a) The costs, scope, and methods of construction and energy conservation are reasonable; and

(b) The project will not have an unreasonable impact on the costs and charges to the public of providing health services by other persons.

(3) The project will involve appropriate improvements or innovations in the financing and delivery of health services which foster cost containment and which promote quality assurance and cost effectiveness.

[Statutory Authority: RCW 43.70.040. 91-02-049 (Order 121), recodified as § 246-310-240, filed 12/27/90, effective 1/31/91. Statutory Authority: RCW 70.38.135. 86-06-030 (Order 2344), § 248-19-400, filed 2/28/86; 81-09-012 (Order 210), § 248-19-400, filed 4/9/81, effective 5/20/81. Statutory Authority: Chapter 70.38 RCW. 79-12-079 (Order 188), § 248-19-400, filed 11/30/79.]

**WAC 246-310-260 Kidney transplantation.** (1) Kidney transplantation is a tertiary service as listed in WAC 246-310-020.

(2) To receive approval a kidney transplant center must meet the following standards in addition to applicable review criteria in WAC 246-310-210, 246-310-220, 246-310-230, and 246-310-240.

(a) A center shall perform at least fifteen transplants annually by the fourth year of operation.

(b) A center shall document that it will meet the requirements of membership to the United Network for Organ Sharing (UNOS) or its successor organization.

[Statutory Authority: RCW 70.38.135 and 70.38.919. 92-02-018 (Order 224), § 246-310-260, filed 12/23/91, effective 1/23/92. Statutory Authority: RCW 43.70.040. 91-02-049 (Order 121), recodified as § 246-310-260, filed 12/27/90, effective 1/31/91. Statutory Authority: RCW 70.38.919. 90-16-058 (Order 073), § 248-19-601, filed 7/27/90, effective 8/27/90.]

**WAC 246-310-261 Open heart surgery standards and need forecasting method.** (1) Open heart surgery means a specialized surgical procedure (excluding organ transplantation) which utilizes a heart-lung bypass machine and is intended to correct congenital and acquired cardiac and coronary artery disease.

(2) Open heart surgery is a tertiary service as listed in WAC 246-310-020. To be granted a certificate of need, an open heart surgery program shall meet the standards in this section in addition to applicable review criteria in WAC 246-310-210, 246-310-220, 246-310-230, and 246-310-240.

(3) Standards.

(a) A minimum of two hundred fifty open heart surgery procedures per year shall be performed at institutions with an open heart surgery program.

(b) Hospitals applying for a certificate of need shall demonstrate that they can meet one hundred ten percent of the minimum volume standard. To do so, the applicant hospital must provide written documentation, which is verifiable, of open heart surgeries performed on patients referred by active medical staff of the hospital. The volume of surgeries counted must be appropriate for the proposed program (i.e., pediatric and recognized complicated cases would be excluded).

(c) No new program shall be established which will reduce an existing program below the minimum volume standard.

(d) Open heart surgery programs shall have at least two board certified cardiac surgeons, one of whom shall be available for emergency surgery twenty-four hours a day. The practice of these surgeons shall be concentrated in a single institution and arranged so that each surgeon performs

a minimum of one hundred twenty-five open heart surgery procedures per year at that institution.

(e) Institutions with open heart surgery programs shall have plans for facilitating emergency access to open heart surgery services at all times for the population they serve. These plans should, at minimum, include arrangements for addressing peak volume periods (such as joint agreements with other programs, the capacity to temporarily increase staffing, etc.), and the maintenance of or affiliation with emergency transportation services (including contingency plans for poor weather and known traffic congestion problems).

(f) In the event two or more hospitals are competing to meet the same forecasted net need, the department shall consider the following factors when determining which proposal best meets forecasted need:

(i) The most appropriate improvement in geographic access;

(ii) The most cost efficient service;

(iii) Minimizing impact on existing programs;

(iv) Providing the greatest breadth and depth of cardiovascular and support services; and

(v) Facilitating emergency access to care.

(g) Hospitals granted a certificate of need have three years from the date the program is initiated to establish the program and meet these standards.

(h) These standards should be reevaluated in at least three years.

(4) Steps in the need forecasting method. The department will develop a forecast of need for open heart surgery every year using the following procedures.

(a) Step 1. Based upon the most recent three years volumes reported for the hospitals within each planning area, compute the planning area's current capacity and the percent of out-of-state use of the area's hospitals. In those planning areas where a new program is being established, the assumed volume of that institution will be the greater of either the minimum volume standard or the estimated volume described in the approved application and adjusted by the department in the course of review and approval.

(b) Step 2. Patient origin adjust the three years of open heart surgery data, and compute each planning area's age-specific use rates and market shares.

(c) Step 3. Multiply the planning area's age-specific use rates by the area's corresponding forecast year population. The sum of these figures equals the forecasted number of surgeries expected to be performed on the residents of each planning area.

(d) Step 4. Apportion the forecasted surgeries among the planning areas in accordance with each area's average market share for the last three years of the four planning areas. This figure equals the forecasted number of state residents' surgeries expected to occur within the hospitals in each planning area. In those areas where a newly approved program is being established, an adjustment will be made to reflect anticipated market share shifts consistent with the approved application.

(e) Step 5. Increase the number of surgeries expected to occur within the hospitals in each planning area in accordance with the percent of surgeries calculated as occurring in those hospitals on out-of-state residents, based on the average of the last three years. This figure equals the

total forecasted number of surgeries expected to occur within the hospitals in each planning area.

(f) Step 6. Calculate the net need for additional open heart surgery services by subtracting the current capacity from the total forecasted surgeries.

(g) Step 7. If the net need is less than the minimum volume standard, no new programs shall be assumed to be needed in the planning area. However, hospitals may be granted certificate of need approval even if the forecasted need is less than the minimum volume standard, provided:

(i) The applying hospital can meet all the other certificate of need criteria for an open heart surgery program (including documented evidence of capability of achieving the minimum volume standard); and

(ii) There is documented evidence that at least eighty percent of the patients referred for open heart surgery by the medical staff of the applying hospital are referred to institutions more than seventy-five miles away.

(5) For the purposes of the forecasting method in this section, the following terms have the following specific meanings:

(a) Age-specific categories. The categories used in computing age-specific values will be fifteen to forty-four year olds, forty-five to sixty-four year olds, sixty-five to seventy-four year olds, and seventy-five and older.

(b) Current capacity. A planning area's current capacity for open heart surgeries equals the sum of the highest reported annual volume for each hospital within the planning area during the most recent available three years data.

(c) Forecast year. Open heart surgery service needs shall be based on forecasts for the fourth year after the certificate of need open heart surgery concurrent review process. The 1992 reviews will be based on forecasts for 1996.

(d) Market share. The market share of a planning area represents the percent of a planning area's total patient origin adjusted surgeries that were performed in hospitals located in that planning area. The most recent available three years data will be used to compute the age-specific market shares for each planning area.

(e) Open heart surgeries. Open heart surgeries are defined as DRGs 104 through 108, inclusive. All pediatric surgeries (ages fourteen and under) are excluded.

(f) Out-of-state use of planning area hospitals. The percent of out-of-state use of hospitals within a planning area will equal the percent of total surgeries occurring within the planning area's hospitals that were performed on patients from out-of-state (or on patients whose reported zip codes are invalid). The most recent available three years data will be used to compute out-of-state use of planning area hospitals.

(g) Patient origin adjustment. A patient origin adjustment of open heart surgeries provides a count of surgeries performed on the residents of a planning area regardless of which planning area the surgeries were performed in. (Surgeries can be patient origin adjusted by using the patient's zip code reported in the CHARS data base.)

(h) Planning areas. Four regional health service areas will be used as planning areas for forecasting open heart surgery service needs.

(i) Health service area "one" includes the following counties: Clallam, Island, Jefferson, King, Kitsap, Pierce, San Juan, Snohomish, Skagit, and Whatcom.

(ii) Health service area "two" includes the following counties: Cowlitz, Clark, Grays Harbor, Klickitat, Lewis, Mason, Pacific, Skamania, Thurston, and Wahkiakum.

(iii) Health service area "three" includes the following counties: Benton, Chelan, Douglas, Franklin, Grant, Kittitas, Okanogan, and Yakima.

(iv) Health service area "four" includes Adams, Asotin, Columbia, Ferry, Garfield, Lincoln, Pend Oreille, Stevens, Spokane, Walla Walla, and Whitman.

(v) Use rate. The open heart surgery use rate equals the number of surgeries performed on the residents of a planning area divided by the population of that planning area. The most recent available three years data is used to compute an averaged annual age-specific use rate for the residents of each of the four planning areas.

(6) The data source for open heart surgeries is the comprehensive hospital abstract reporting system (CHARS), office of hospital and patient data, department of health.

(7) The data source for population estimates and forecasts is the office of financial management population trends reports.

[Statutory Authority: RCW 70.38.135(3). 92-12-015 (Order 274), § 246-310-261, filed 5/26/92, effective 6/26/92.]

**WAC 246-310-262 Nonemergent interventional cardiology standard.** All nonemergent percutaneous transluminal coronary angioplasty (PTCA) procedures and all other nonemergent interventional cardiology procedures are tertiary services as defined in WAC 246-310-010 and shall be performed in institutions which have an established on-site open heart surgery program capable of performing emergency open heart surgery.

[Statutory Authority: Chapter 70.38 RCW. 96-24-052, § 246-310-262, filed 11/27/96, effective 12/28/96. Statutory Authority: RCW 70.38.135(3). 92-12-015 (Order 274), § 246-310-262, filed 5/26/92, effective 6/26/92.]

**WAC 246-310-270 Ambulatory surgery.** (1) To receive approval, an ambulatory surgical facility must meet the following standards in addition to applicable review criteria in WAC 246-310-210, 246-310-220, 246-310-230, and 246-310-240.

(2) The area to be used to plan for operating rooms and ambulatory surgical facilities is the secondary health services planning area.

(3) Secondary health services planning areas are: San Juan, Whatcom, East Skagit, Whidbey-Fidalgo, Western North Olympic, East Clallam, East Jefferson, North Snohomish, Central Snohomish, East Snohomish, Southwest Snohomish, Kitsap, North King, East King, Central King, Southwest King, Southeast King, Central Pierce, West Pierce, East Pierce, Mason, West Grays Harbor, Southeast Grays Harbor, Thurston, North Pacific, South Pacific, West Lewis, East Lewis, Cowlitz-Wahkiakum-Skamania, Clark, West Klickitat, East Klickitat, Okanogan, Chelan-Douglas, Grant, Kittitas, Yakima, Benton-Franklin, Ferry, North Stevens, North Pend Oreille, South Stevens, South Pend Oreille, Southwest Lincoln, Central Lincoln, Spokane,

Southwest Adams, Central Adams, Central Whitman, East Whitman, Walla Walla, Columbia, Garfield, and Asotin.

(4) Outpatient operating rooms should ordinarily not be approved in planning areas where the total number of operating rooms available for both inpatient and outpatient surgery exceeds the area need.

(5) When a need exists in planning areas for additional outpatient operating room capacity, preference shall be given to dedicated outpatient operating rooms.

(6) An ambulatory surgical facility shall have a minimum of two operating rooms.

(7) Ambulatory surgical facilities shall document and provide assurances of implementation of policies to provide access to individuals unable to pay consistent with charity care levels provided by hospitals affected by the proposed ambulatory surgical facility. The amount of an ambulatory surgical facility's annual revenue utilized to finance charity care shall be at least equal to or greater than the average percentage of total patient revenue, other than medicare or medicaid, that affected hospitals in the planning area utilized to provide charity care in the last available reporting year.

(8) The need for operating rooms will be determined using the method identified in subsection (9) of this section.

(9) Operating room need in a planning area shall be determined using the following method:

(a) Existing capacity.

(i) Assume the annual capacity of one operating room located in a hospital and not dedicated to outpatient surgery is ninety-four thousand two hundred fifty minutes. This is derived from scheduling forty-four hours per week, fifty-one weeks per year (allowing for five weekday holidays), a fifteen percent loss for preparation and clean-up time, and fifteen percent time loss to allow schedule flexibility. The resulting seventy percent productive time is comparable to the previously operating hospital commission's last definition of "billing minutes" which is the time lapse from administration of anesthesia until surgery is completed.

(ii) Assume the annual capacity of one operating room dedicated to ambulatory surgery is sixty-eight thousand eight hundred fifty minutes. The derivation is the same as (a)(i) of this subsection except for twenty-five percent loss for prep/clean-up time and scheduling is for a thirty-seven and one-half hour week. Divide the capacity minutes by the average minutes per outpatient surgery (see (a)(vii) of this subsection). Where survey data are unavailable, assume fifty minutes per outpatient surgery, resulting in a capacity for one thousand three hundred seventy-seven outpatient surgeries per room per year.

(iii) Calculate the total annual capacity (in number of surgeries) of all dedicated outpatient operating rooms in the area.

(iv) Calculate the total annual capacity (in number of minutes) of the remaining inpatient and outpatient operating rooms in the area, including dedicated specialized rooms except for twenty-four hour dedicated emergency rooms. When dedicated emergency operating rooms are excluded, emergency or minutes should also be excluded when calculating the need in an area. Exclude cystoscopic and other special purpose rooms (e.g., open heart surgery) and delivery rooms.

(b) Future need.

(i) Project number of inpatient and outpatient surgeries performed within the hospital planning area for the third year of operation. This shall be based on the current number of surgeries adjusted for forecasted growth in the population served and may be adjusted for trends in surgeries per capita.

(ii) Subtract the capacity of dedicated outpatient operating rooms from the forecasted number of outpatient surgeries. The difference continues into the calculation of (b)(iv) of this subsection.

(iii) Determine the average time per inpatient and outpatient surgery in the planning area. Where data are unavailable, assume one hundred minutes per inpatient and fifty minutes per outpatient surgery. This excludes preparation and cleanup time and is comparable to "billing minutes."

(iv) Calculate the sum of inpatient and remaining outpatient (from (b)(ii) of this subsection) operating room time needed in the third year of operation.

(c) Net need.

(i) If (b)(iv) of this subsection is less than (a)(iv) of this subsection, divide their difference by ninety-four thousand two hundred fifty minutes to obtain the area's surplus of operating rooms used for both inpatient and outpatient surgery.

(ii) If (b)(iv) of this subsection is greater than (a)(iv) of this subsection, subtract (a)(iv) of this subsection from the inpatient component of (b)(iv) of this subsection and divide by ninety-four thousand two hundred fifty minutes to obtain the area's shortage of inpatient operating rooms. Divide the outpatient component of (b)(iv) of this subsection by sixty-eight thousand eight hundred fifty to obtain the area's shortage of dedicated outpatient operating rooms.

[Statutory Authority: RCW 70.38.135 and 70.38.919. 92-02-018 (Order 224), § 246-310-270, filed 12/23/91, effective 1/23/92. Statutory Authority: RCW 43.70.040. 91-02-049 (Order 121), recodified as § 246-310-270, filed 12/27/90, effective 1/31/91. Statutory Authority: RCW 70.38.919. 90-16-058 (Order 073), § 248-19-700, filed 7/27/90, effective 8/27/90.]

**WAC 246-310-280 Kidney disease treatment centers.** (1) To receive approval, a kidney disease treatment center providing hemo or peritoneal dialysis, training, or backup must meet the following standards in addition to applicable review criteria in WAC 246-310-210, 246-310-220, 246-310-230, and 246-310-240.

(2) The number of dialysis stations needed in an ESRD service area shall be determined using the following data of the Northwest Renal Network:

(a) The ESRD service area's total number of in center dialyses provided for the previous five years.

(b) The number of end of year incenter patients for the ESRD service area for the previous five years.

(c) The number of patients trained for home hemo and peritoneal dialysis for the ESRD service area for the previous five years.

(3) The number of dialysis stations projected as needed in an ESRD service area shall be determined using the following methodology:

(a) Project the number of incenter dialyses needed in the ESRD service area through a three-year future regression analysis of the previous five years' data.

(b) Project the number of incenter dialyses needed to serve residents of the ESRD service area by projecting the

number of end of year incenter patients through a three-year future regression analysis of patient origin adjusted data for the previous five years. Multiply this result by one hundred fifty-six dialyses per year.

(c) Project the number of patients to be trained for home hemo and peritoneal dialysis in the service area through a three-year regression analysis of the previous five years' data.

(d) Determine the number of dialysis stations needed for incenter dialysis by dividing the result of (a) of this subsection by 748.8 (equivalent to eighty percent of a three-patient shift schedule).

(e) Determine the number of dialysis stations needed for incenter dialysis to serve residents of the service area by dividing the result of (b) of this subsection by 748.8 (equivalent to eighty percent of a three-patient shift schedule).

(f) Determine the number of stations needed for home hemo and peritoneal training in the service area by dividing the projected number of home hemo patients to be trained by six and peritoneal patients to be trained by twenty.

(g) Determine the number of dialysis stations needed in a service area by the projection year as the total of:

(i) The result of (e) of this subsection, designated as the number of resident stations;

(ii) The result of (d) of this subsection, minus the result of (e) of this subsection, designated as visitor stations;

(iii) The result of (f) of this subsection, designated as the number of training stations.

(h) To determine the net station need for an ESRD service area, subtract the number calculated in (g) of this subsection from the total number of certificate of need approved stations.

(4) All kidney disease treatment centers that would stand to lose market share by approval of the applicant's facility, must be operating at 748.8 dialyses per nontraining station per year before additional nontraining stations are approved.

(5) New incenter kidney disease treatment stations must reasonably project to be operating at 748.8 dialyses per nontraining station per year by the third year of operation.

(6) The department shall not issue certificates of need approving more than the number of stations identified as being needed in a given ESRD service area unless:

(a) The department finds such additional stations are needed to be located reasonably close to the people they serve; or

(b) Existing nontraining dialysis stations in the treatment facility are operating at nine hundred thirty-six dialyses per year (three-patient shifts); or

(c) The applicant can document a significant change in ESRD treatment practice has occurred, affecting dialysis station utilization in the service area; and

The department finds that an exceptional need exists and explains such approval in writing.

[Statutory Authority: Chapter 70.38 RCW. 96-24-052, § 246-310-280, filed 11/27/96, effective 12/28/96. Statutory Authority: RCW 70.38.135 (3)(c). 93-13-015 (Order 367), § 246-310-280, filed 6/7/93, effective 7/8/93. Statutory Authority: RCW 70.38.135 and 70.38.919. 92-02-018 (Order 224), § 246-310-280, filed 12/23/91, effective 1/23/92. Statutory Authority: RCW 43.70.040. 91-02-049 (Order 121), recodified as § 246-310-280, filed 12/27/90, effective 1/31/91. Statutory Authority: RCW 70.38.919. 90-16-058 (Order 073), § 248-19-701, filed 7/27/90, effective 8/27/90.]

**WAC 246-310-360 Nursing home bed need method.**

For all applications where the need for nursing home beds is not deemed met as identified in RCW 70.38.115(13), the following mathematical calculation will be used as a guideline and represent only one component of evaluating need:

(1) The department shall calculate the state-wide and planning area specific estimated bed need for the projection year by multiplying the estimated state-wide and planning area specific resident population for the projection year by the established ratio;

(2) The department shall then calculate the projected current supply ratio state-wide and for each planning area. The current supply ratio shall be computed from the most recent bed supply and the projection year estimate of resident population.

(3) The department shall next determine the areas of the state that will be under the established ratio, or over the established ratio in the projection year by comparing each planning area's projected current supply ratio to the established ratio.

(4) The department shall compare the most recent state-wide bed supply with the state-wide estimated bed need.

(a) If the current state-wide bed supply is greater than or equal to the state-wide estimated bed need, then calculation of state-wide need for new beds ends.

(b) If the current state-wide bed supply is less than the state-wide estimated bed need, the department shall determine the difference between the state-wide estimated bed need and the state-wide current bed supply, which shall be called state-wide available beds.

(i) If the number of state-wide available beds is large enough, the department shall assign to each planning area under the established ratio the number of beds necessary to bring it up to the established ratio in the projection year.

(ii) If the number of state-wide available beds is insufficient to assign each planning area under the established ratio the number of new beds necessary to bring it up to the established ratio, the department shall assign to each planning area under the established ratio a proportion of state-wide available beds equal to the ratio of that planning area's bed need to reach the established ratio to the total beds required for all planning areas under the established ratio to reach the established ratio in the projection year.

(iii) The department shall not assign more new beds to a planning area than the number which, when added to the planning area's bed supply, will raise the planning area's bed-to-population ratio to the greater of the established ratio and the state-wide current ratio.

[Statutory Authority: Chapter 70.38 RCW, 96-24-052, § 246-310-360, filed 11/27/96, effective 12/28/96. Statutory Authority: RCW 43.70.040, 91-02-049 (Order 121), recodified as § 246-310-360, filed 12/27/90, effective 1/31/91. Statutory Authority: RCW 70.38.919, 90-12-071 (Order 062), § 248-19-805, filed 6/1/90, effective 7/1/90.]

**WAC 246-310-370 Nursing home bed need method revision.** (1) The department shall review the projection method and may make changes in accordance with the following process:

(a) The appropriate consumer and provider representatives and the department of social and health services shall be notified of the department's plan to evaluate the projec-

tion method and be provided information on the process for participating in the evaluation;

(b) Proposed revisions to the projection method shall be developed in consultation with the responding representatives. An opportunity for public comment on the proposed revisions to the projection method will be provided prior to filing the proposed rules.

(2) When reviewing the projection method the department shall consider the following:

(a) The national bed-to-population ratio and the bed-to-population ratios of other states judged by the aging and adult services administration of the department of social and health services to have reasonable and progressive long-term care policies;

(b) Data and information provided by provider and consumer representatives;

(c) State governmental policy goals for distributing scarce resources between nursing homes and other institutional or community based services;

(d) The effects of developments in the delivery or financing of long-term care services on nursing home bed need; and

(e) Progress in developing other long-term care services for the state-wide resident population.

[Statutory Authority: Chapter 70.38 RCW, 96-24-052, § 246-310-370, filed 11/27/96, effective 12/28/96. Statutory Authority: RCW 43.70.040: 91-02-049 (Order 121), recodified as § 246-310-370, filed 12/27/90, effective 1/31/91. Statutory Authority: RCW 70.38.919, 90-12-071 (Order 062), § 248-19-806, filed 6/1/90, effective 7/1/90.]

**WAC 246-310-380 Nursing home bed need standards.** (1) The department shall use the following rules in conjunction with the certificate of need review criteria contained in WAC 246-310-210(1) for applications proposing the following:

(a) Construction, development, or other establishment of a new nursing home;

(b) Increase in the licensed bed capacity of a nursing home or a hospital long-term care unit;

(c) Change in license category of beds from the following to nursing home or hospital long-term care unit beds:

(i) Acute care, or

(ii) Boarding home care;

(2) The department shall comply with the following time schedule for developing bed need projections:

(a) By the last working day in January of each year, the department shall recalculate the estimated bed projection for each planning-area.

(b) By the last working day in January of each year, the department shall provide the aging and adult services administration of the department of social and health services with the estimated bed need for each planning-area, pending the department's decisions on applications submitted during the previous year's nursing home concurrent review cycles.

(c) By the last working day in January of each year, the department shall rank order planning-areas from lowest to highest by the projected current supply ratio.

(d) By the first working day of June of each year, the department shall calculate the net estimated bed need for each planning-area.

(3) The estimated bed projections for the projection period, listed by planning area will be updated annually and



distributed to interested parties. When a planning-area's estimated bed projection is less than the planning-area's bed supply as defined by WAC 246-310-350(4), no beds can be added until the state-wide established ratio is reached, except as allowed in this section.

(4) The department shall limit to three hundred the total number of nursing home beds approved for all CCRCs which propose or are operating within a transition period.

(a) These three hundred beds available for CCRCs during transition periods shall be in addition to the net nursing home beds needed in all of the planning-areas.

(b) All nursing home beds approved for CCRCs which propose or are operating within a transition period shall be counted as beds within this three hundred bed limitation unless and until the CCRC fully complies with all provisions of the CCRCs performance standards.

(5) The department shall not issue certificates of need approving more than the net estimated bed need indicated for a given planning-area, unless:

(a) The department finds such additional beds are needed to be located reasonably close to the people they serve; and

(b) The department explains such approval in writing.

[Statutory Authority: Chapter 70.38 RCW. 96-24-052, § 246-310-380, filed 11/27/96, effective 12/28/96. Statutory Authority: RCW 70.38.135. 91-15-018 (Order 179), § 246-310-380, filed 7/10/91, effective 8/10/91. Statutory Authority: RCW 43.70.040. 91-02-049 (Order 121), recodified as § 246-310-380, filed 12/27/90, effective 1/31/91. Statutory Authority: RCW 70.38.919. 90-12-072 (Order 063), § 248-19-810, filed 6/1/90, effective 7/1/90.]

**WAC 246-310-390 Nursing home bed need adjustments.** (1) The department shall use the procedures described in this section to make adjustments to planning area net estimated bed need.

(2) For planning areas for which a nursing home review is scheduled or is ongoing, the department shall use the following procedures to adjust a planning area's net estimated bed need between April tenth or the first working day thereafter and the last working day in January of the following year.

(a) Where an increase in the bed supply of a planning area results in a reduction in net estimated bed need, the department shall use the following procedures:

(i) When a reduction in net estimated bed need occurs prior to the date of beginning of review for the applicable concurrent review cycle, the department shall:

(A) Inform, in writing, all persons from whom the department has received an application and/or a valid letter of intent of the reduction; and

(B) Explain the procedures for withdrawing or amending a certificate of need application.

(ii) When a reduction in net estimated bed need occurs after the date of beginning of review for the applicable concurrent review cycle, the department shall use the need projected at the time the review began in reaching a decision on each affected application.

(b) Where a decrease in the bed supply of a planning area results in the increase in net estimated bed need, the department shall:

(i) Use the following policies:

(A) If such a decrease in the bed supply would result in a planning area being under the established ratio, the department shall:

(I) Assign to the planning area only enough beds for the planning area to reach the established ratio in the projection year, but not to exceed the number of beds which closed; and

(II) Redistribute any remaining beds to planning areas state-wide through the next scheduled recalculation of estimated projections for all planning areas.

(B) If such decrease in the bed supply would not make a planning area under the established ratio, the department shall redistribute any remaining beds to planning areas state-wide through the next scheduled recalculation of baseline projections for all planning areas.

(ii) Subject to the provisions of (b)(i) of this subsection, use the following procedures:

(A) When an increase in net estimated bed need can be made prior to the last day on which the department can accept amendments to applications under review, the department shall:

(I) Notify all affected applicants in writing; and

(II) Explain to each affected applicant the procedures for amending a certificate of need application.

(B) When an increase cannot be made prior to the last day on which the department can accept amendments to applications under review, the department shall include the increased net estimated bed need in any subsequent decisions on each affected application or the next applicable concurrent review cycle, whichever occurs first.

(3) For planning areas for which a nursing home review is not scheduled or ongoing, the department shall use the following procedures to adjust a planning area's net estimated bed need between April tenth or the first working day thereafter and the last working day in January of the following year:

(a) If a decrease in the bed supply would make a planning area under the established ratio, the department shall:

(i) Assign to the planning area only enough beds for the planning area to reach the established ratio in the projection year; and

(ii) Redistribute any remaining beds to planning areas state-wide through the next scheduled recalculation of baseline projections for all planning areas.

(b) If such decrease in the bed supply would not result in a planning area being under the established ratio, the department shall redistribute any remaining beds to planning areas state-wide through the next scheduled recalculation of baseline projections for all planning areas.

[Statutory Authority: Chapter 70.38 RCW. 96-24-052, § 246-310-390, filed 11/27/96, effective 12/28/96. Statutory Authority: RCW 43.70.040. 91-02-049 (Order 121), recodified as § 246-310-390, filed 12/27/90, effective 1/31/91. Statutory Authority: RCW 70.38.919. 90-12-072 (Order 063), § 248-19-811, filed 6/1/90, effective 7/1/90.]

**WAC 246-310-395 Nursing home bed banking for alternative use notice requirements.** In the case of a nursing home licensee, requesting to convert some of the nursing home beds to an alternative use, as defined in RCW 70.38.111(8), or reduce the number of beds per room to two or one, or otherwise enhance the quality of life for residents



and preserve the right to later convert the original portion of the facility back to skilled nursing care, the nursing home shall give notice of intent to preserve its conversion options to the department of health.

(1) Notice of the nursing home's intent to preserve conversion options shall be given to the department of health no later than thirty days after the effective date of the license modification made by the nursing home licensing authority. Such notices shall be signed by the licensee and include the following:

(a) A description of the alternative service to be provided or a description of how the proposed bed banking will have a direct and immediate benefit to the quality of life of the residents and a listing of the number of beds, by room number;

(b) A projected timeline for implementation; and

(c) In the event the nursing home licensee, as defined by WAC 246-310-010, is not the nursing home owner, the licensee shall provide a written statement indicating the building owner's approval of the bed reduction.

(2) The department shall notify the nursing home, as to whether the proposal meets the requirements of RCW 70.38.111 (8)(a) and if conversion rights are recognized. The nursing home does not forfeit its right to bank beds under this section if the department does not respond within this thirty-day time frame, nor does the nursing home obtain rights that it otherwise would not have under applicable statutes or rules if the department does not respond within the thirty-day time frame.

(3) The licensee shall notify the department of health at the time the alternative service or services commences.

(4) Notice of intent to convert beds back to nursing home bed use shall be given to the department of health and the department of social and health services no later than one year prior to the effective date of the licensure modification made by the nursing home licensing authority reflecting the restored beds unless construction is required to convert the beds back. In the event the beds are not converted back to nursing home beds within sixty days of the date stated in the notice of intent, a notice of intent will need to be resubmitted no later than one year prior to the effective date of the licensure modification.

(5) In the event construction is required to convert beds back to nursing home bed use, notice shall be given to the department of health and department of social and health services no later than two years prior to the effective date of licensure modification made by the nursing home licensing authority reflecting the restored beds. The same life and safety code requirements as existed at the time the nursing home voluntarily reduced its licensed beds shall be complied with unless waivers from such requirements were issued, in which case the converted beds shall reflect the conditions or standards that then existed pursuant to the approved waivers. In the event the beds are not converted back to nursing home beds within sixty days of the date stated in the notice of intent, a notice of intent will need to be resubmitted no later than two years prior to the effective date of the licensure modification.

(6) Prior to any license modification to convert beds back to nursing home beds under this section, the licensee must demonstrate that the nursing home meets the certificate of need exemption requirements under WAC 246-310-043.

[Statutory Authority: Chapter 70.38 RCW. 96-24-052, § 246-310-395, filed 11/27/96, effective 12/28/96.]

**WAC 246-310-396 Nursing home bed banking requirements for full facility closure.** In the case of a nursing home licensee, as defined in WAC 246-310-010 ceasing operation as a nursing home or any other party who has secured an interest in the beds and requesting to retain the nursing home bed allocation, pursuant to RCW 70.38.115 (13)(b), the licensee or other party who has secured an interest in the beds shall give notice to the department of health.

(1) Notice of the nursing home's intent to retain the nursing home bed allocation shall be given to the department of health no later than thirty days after the effective date of the home's closure. Such notices shall be signed by the licensee and include the following:

(a) The name of the facility ceasing operation;

(b) The number of beds in the bed allocation to be retained;

(c) Documentation of the effective date of the facility closure;

(d) The name, address, and telephone number of a contact person;

(e) Documentation as to whether the applicant is the licensee who has operated the beds for at least one year immediately preceding the reservation of the beds; and

(f) In the event the nursing home licensee, as defined by WAC 246-310-010, is not the nursing home owner, the licensee shall provide a written statement indicating the building owners approval of the facility's closure.

(2) Notice shall be in written form addressed to the certificate of need program and signed by an authorized representative of the nursing home or other party who has secured an interest in the beds.

(3) The department shall respond within thirty days of the notice confirming that the rights to the bed allocation have been retained and the date the retained bed right will expire, provided no certificate of need is issued to replace the beds. The nursing home does not forfeit its right to bank beds under this section if the department does not respond within the thirty-day time frame, nor does the nursing home obtain rights that it otherwise would not have under applicable statutes or rules if the department does not respond within the given time frame.

(4) Certificate of need review shall be required for any party who has reserved the nursing home beds except that the need criteria shall be deemed met when the applicant is the licensee who has operated the beds for at least one year immediately preceding the reservation of the beds, and who is replacing the beds in the same planning area.

[Statutory Authority: Chapter 70.38 RCW. 96-24-052, § 246-310-396, filed 11/27/96, effective 12/28/96.]

**WAC 246-310-397 Nursing home bed replacement notice requirements.** In the case of a nursing home licensee wanting to replace nursing home beds pursuant to WAC 246-310-044, the nursing home shall give notice of intent to replace the beds to the department of health.

Notice of the nursing home licensee's intent to replace the nursing home beds shall be given to the department a

minimum of thirty days prior to initiating the replacement project. Such notices shall be signed by the licensee and include the following:

(1) Documentation that the applicant is the existing licensee at all affected facilities and has operated the beds at all affected facilities for at least one year immediately preceding the replacement exemption request fulfilling the notice requirements of this section;

(2) An affidavit from the applicant that the applicant intends to be the licensee at all affected facilities at the time of project completion. This affidavit shall include a statement that the applicant acknowledges the project can not be completed if the applicant is not the licensee at the time of project completion except as allowed for under the provisions of RCW 70.38.115(14);

(3) In the event the nursing home licensee, as defined by WAC 246-310-010, is not the nursing home owner, the licensee shall document whether the building owner has a secured interest in the beds.

(a) If the building owner does have a secured interest in the beds, the licensee shall provide a written statement, signed by the building owner, indicating approval of the bed replacement. In the event that the licensee is unable to complete the replacement project, as referenced in RCW 70.38.115(14), the building owner shall be permitted to complete the project.

(b) If the building owner does not have a secured interest in the beds, the licensee shall provide documentation showing that the building owner has been notified of the proposed project. In the event that the licensee is unable to complete the replacement project, as referenced in RCW 70.38.115(14), the building owner shall not be permitted to complete the project.

(4) The number of beds currently licensed at each affected facility and the number of licensed beds to be replaced at each affected facility;

(5) Geographic location of both the existing nursing home beds and the proposed replacement beds;

(6) Documentation that the nursing home beds being replaced will not be used for nursing home services once the replacement beds are licensed; and

(7) A projected timeline for completion of the project.

[Statutory Authority: Chapter 70.38 RCW. 96-24-052, § 246-310-397, filed 11/27/96, effective 12/28/96.]

**WAC 246-310-410 Swing bed review standards.** (1) The department shall use the following rules, in addition to those under WAC 246-310-380 to interpret the certificate of need review criteria contained in WAC 246-310-210, 246-310-220, 246-310-230, and 246-310-240 for applications by hospitals proposing an increase in the number of designated swing beds.

(2) Swing beds are defined as up to the first five hospital beds, so designated by an eligible rural hospital, which are available to provide either acute care or long-term care nursing services as required.

(3) Hospitals proposing swing bed projects shall:

(a) Be located in geographic areas of the state defined by the United States Bureau of the Census as a nonstandardized metropolitan statistical area; and

(b) Have total licensed bed capacity not exceeding one hundred.

(4) Hospitals shall demonstrate ability to meet minimum Medicare standards of care for rural hospital swing beds.

[Statutory Authority: Chapter 70.38 RCW. 96-24-052, § 246-310-410, filed 11/27/96, effective 12/28/96. Statutory Authority: RCW 70.38.135 and 70.38.919. 92-02-018 (Order 224), § 246-310-410, filed 12/23/91, effective 1/23/92. Statutory Authority: RCW 43.70.040. 91-02-049 (Order 121), recodified as § 246-310-410, filed 12/27/90, effective 1/31/91. Statutory Authority: RCW 70.38.919. 90-12-072 (Order 063), § 248-19-860, filed 6/1/90, effective 7/1/90.]

**WAC 246-310-470 Review and action on health maintenance organization projects.** (1) Undertakings requiring a certificate of need.

A certificate of need shall be required for any undertaking which, in accordance with WAC 246-310-020, is subject to the provisions of chapter 246-310 WAC, unless an exemption has been granted for such undertaking under the provisions of WAC 246-310-040.

(2) Required approval.

The secretary's designee shall issue a certificate of need for a proposed project if the certificate of need applicant for the proposed project is a health maintenance organization or a health care facility controlled (directly or indirectly) by a health maintenance organization and the department finds the proposed project meets the criteria set forth in WAC 246-310-210(5).

(3) Sale, acquisition, or lease of facilities or equipment for which a certificate of need has been issued.

A health care facility (or portion thereof) for which a certificate of need has been issued under the provisions of this section shall not be sold or leased and a controlling interest in such facility or in a lease of the facility shall not be acquired unless an exemption or a certificate of need for such sale, lease, or acquisition has been granted by the secretary's designee.

[Statutory Authority: Chapter 70.38 RCW. 96-24-052, § 246-310-470, filed 11/27/96, effective 12/28/96. Statutory Authority: RCW 70.38.135 and 70.38.919. 92-02-018 (Order 224), § 246-310-470, filed 12/23/91, effective 1/23/92. Statutory Authority: RCW 43.70.040. 91-02-049 (Order 121), recodified as § 246-310-470, filed 12/27/90, effective 1/31/91. Statutory Authority: RCW 70.38.135. 86-06-030 (Order 2344), § 248-19-410, filed 2/28/86; 81-09-012 (Order 210), § 248-19-410, filed 4/9/81, effective 5/20/81. Statutory Authority: Chapter 70.38 RCW. 79-12-079 (Order 188), § 248-19-410, filed 11/30/79.]

**WAC 246-310-480 Projects proposed for the correction of deficiencies.** (1) For the purposes of this section, "correction of deficiencies" shall mean one or more of the following:

(a) Eliminating or preventing imminent safety hazards as defined by federal, state, or local fire, building, or life safety codes or regulations; or

(b) Complying with state licensing standards; or

(c) Complying with accreditation or certification standards which must be met to receive reimbursement under Titles XVIII or XIX of the Social Security Act.

(2) An application submitted for a project limited to the correction of deficiencies, as defined in subsection (1) of this section, shall be approved unless the department finds that:

(a) The applicant was provided sufficient advanced notification of such deficiencies to allow for ongoing correction; or

(b) The project would result in the substantial modification or replacement of an existing health care facility and the licensee would not be exempt under WAC 246-310-044.

(3) An application submitted for the correction of deficiencies shall be reviewed under the expedited review process, in accordance with WAC 246-310-150, unless it qualifies for emergency review in accordance with WAC 246-310-140.

(4) An application reviewed under the provisions of this section shall be approved only to the extent the capital expenditure is needed for the correction of the deficiency.

(5) If the department finds any portion of the project or the project as a whole is not needed for the correction of deficiencies, such portion or entire project shall be reviewed in accordance with WAC 246-310-200, 246-310-210, 246-310-220, 246-310-230, and 246-310-240.

(6) If the department finds a proposed capital expenditure is needed to correct deficiencies, as defined in subsection (1) of this section, the criteria in WAC 246-310-210 shall not be applied to the consideration of the project.

[Statutory Authority: Chapter 70.38 RCW. 96-24-052, § 246-310-480, filed 11/27/96, effective 12/28/96. Statutory Authority: RCW 70.38.135 and 70.38.919. 92-02-018 (Order 224), § 246-310-480, filed 12/23/91, effective 1/23/92. Statutory Authority: RCW 43.70.040. 91-02-049 (Order 121), recodified as § 246-310-480, filed 12/27/90, effective 1/31/91. Statutory Authority: RCW 70.38.135. 86-06-030 (Order 2344), § 248-19-415, filed 2/28/86; 81-09-012 (Order 210), § 248-19-415, filed 4/9/81, effective 5/20/81.]

**WAC 246-310-490 Written findings and actions on certificate of need applications.** (1) Written findings.

(a) The findings of the department's review of a certificate of need application shall be stated in writing and include the basis for the decision of the secretary's designee as to whether a certificate of need is to be issued or denied for the proposed project.

(b) In making its findings and taking action on a certificate of need application, the department shall use all criteria contained in chapter 246-310 WAC applicable to the proposed project.

(i) The written findings shall identify any criterion the department has decided is not applicable to the particular project and give the reason for such decision.

(ii) The secretary's designee may deny a certificate of need if the applicant has not provided the information which is necessary to a determination that the project meets all applicable criteria and which the department has prescribed and published as necessary to a certificate of need review of the type proposed: *Provided however*, That the department has requested such information in a screening letter sent in accordance with WAC 246-310-090 (1)(c).

(c) The department shall make written findings on the extent to which the project meets the criteria set forth in WAC 246-310-210 (1) and (2) when the secretary's designee issues a certificate of need directly related to the provision of health services, or beds: *Provided however*, That no such written finding shall be necessary for projects for the correction of deficiencies of the types described in WAC 246-310-480 and for projects proposed by or on behalf of a

health maintenance organization or a health care facility controlled, directly or indirectly, by a health maintenance organization.

(d) When, as a part of concurrent review proceedings, the secretary's designee makes a decision to approve an application or applications and to disapprove other competing applications, he or she shall provide a specific written statement of reasons for determining the approved application or applications to be superior.

(2) Separability of application and action.

When a certificate of need application is for multiple services or multiple components or the proposed project is to be multiphased, the secretary's designee may take individual and different action on separable portions of the proposed project.

(3) Conditional certificate of need.

(a) The secretary's designee in making his or her decision on a certificate of need application may decide to issue a conditional certificate of need if the department finds the project is justified only under specific circumstances: *Provided however*, That conditions shall relate directly to the project being reviewed and to review criteria.

(b) When the department finds a project for which a certificate of need is to be issued does not satisfy the review criteria set forth in WAC 246-310-210 (1) and (2), the secretary's designee may impose a condition or conditions that the applicant take affirmative steps so as to satisfy those review criteria. In evaluating the accessibility of the project, the current accessibility of the facility as a whole shall be taken into consideration.

(c) The conditions attached to a certificate of need may be released by the secretary's designee upon the request of the health care facility or health maintenance organization for which the certificate of need was issued.

(i) The request must include information needed by the department demonstrating the conditions are no longer valid and the release of such conditions would be consistent with the purpose of chapter 70.38 RCW.

(ii) A request for the removal of a condition must be submitted in accordance with WAC 246-310-090 and will be reviewed in accordance with the regular or expedited review procedures described in WAC 246-310-160 or 246-310-150.

(4) Distribution of written findings and statement of decision.

(a) A copy of the department's written findings and statement of the decision of the secretary's designee on a certificate of need application shall be sent to:

(i) The person submitting the certificate of need application;

(ii) In the case of a project proposed by a health maintenance organization, the appropriate regional office of the United States Department of Health and Human Services; and

(iii) When the secretary's designee issues a certificate of need for a project which does not satisfy the review criteria set forth in WAC 246-310-210 (1) and (2), the appropriate regional office of the Department of Health and Human Services.

(b) The written findings and statement of the decision of the secretary's designee on a certificate of need application shall be available to others requesting the certificate of

need unit to provide access to a copy of such findings and statement.

[Statutory Authority: Chapter 70.38 RCW. 96-24-052, § 246-310-490, filed 11/27/96, effective 12/28/96. Statutory Authority: RCW 70.38.135 and 70.38.919. 92-02-018 (Order 224), § 246-310-490, filed 12/23/91, effective 1/23/92. Statutory Authority: RCW 43.70.040. 91-02-049 (Order 121), recodified as § 246-310-490, filed 12/27/90, effective 1/31/91. Statutory Authority: RCW 70.38.135. 86-06-030 (Order 2344), § 248-19-420, filed 2/28/86; 81-09-012 (Order 210), § 248-19-420, filed 4/9/81, effective 5/20/81. Statutory Authority: Chapter 70.38 RCW. 79-12-079 (Order 188), § 248-19-420, filed 11/30/79.]

**WAC 246-310-500 Issuance, suspension, denial, revocation, and transfer of a certificate of need.** (1) The secretary's designee shall issue a certificate of need to the applicant.

(a) The secretary's designee shall issue a certificate of need for:

- (i) The proposed project, or
- (ii) A separable portion of the proposed project.

(b) When the certificate of need is issued for a separable portion of the proposed project, the secretary's designee shall provide written notice to the applicant stating the reasons for the department's action.

(c) The secretary's designee shall issue a certificate of need only when the department finds that the project or the separable portion of the proposed project is consistent with the applicable criteria contained in chapter 246-310 WAC.

(d) In issuing a certificate of need, the secretary's designee shall:

- (i) Specify the maximum capital expenditure which may be obligated under the certificate, and
- (ii) Prescribe the cost components to be included in determining the capital expenditure which may be obligated under such certificate.

(2) The secretary's designee may issue a conditional certificate of need for a proposed project or a separable portion of the proposed project.

(a) The conditions attached to a certificate of need must directly relate to the project being reviewed.

(b) The conditions must directly relate to criteria contained in chapter 246-310 WAC.

(3) The department shall apply the following provisions when suspending a certificate of need.

(a) The secretary's designee may suspend a certificate of need for cause which shall include, but not be limited to:

- (i) Suspicion of fraud,
- (ii) Misrepresentation,
- (iii) False statements,
- (iv) Misleading statements,
- (v) Evasion or suppression of material fact in the application for a certificate of need or any of its supporting materials.

(b) The secretary's designee shall issue an order which states the reason for any suspension of a certificate of need to the person to whom the certificate of need had been issued.

(c) A suspension of a certificate of need shall not exceed one hundred twenty calendar days.

(i) Prior to the expiration of the suspension the department shall:

(A) Review the facts and circumstances relevant to the suspension;

(B) Reinstate, amend, or revoke the certificate of need; and,

(i) Send written notice of its decision on a suspended certificate of need to the person to whom the certificate of need had been issued.

(4) The secretary's designee shall send written notification of denial of a certificate of need to the applicant submitting the certificate of need application stating the reasons for the denial.

(5) When a proposed project or separable portion of the proposed project is denied a certificate of need, the department shall not accept another certificate of need application for the same project or separable portion unless the department determines:

(a) There is a substantial change in existing or proposed health facilities or services in the area to be served by the project; or

(b) There is a substantial change in the need for the facilities or services of the type proposed in the area to be served by the project; or

(c) One year has lapsed since the submission of the application for the certificate of need subject to regular review which was denied or the next scheduled concurrent review cycle permits the submission of applications.

(6) The department shall apply the following provisions in the revocation of a certificate of need.

(a) The secretary's designee may revoke a certificate of need for cause which shall include the following:

- (i) Fraud,
- (ii) Misrepresentation,
- (iii) False statements,
- (iv) Misleading statements, and
- (v) Evasion or suppression of material facts in the application of a certificate of need, or in any of its supporting materials.

(b) When the secretary's designee revokes a certificate of need, the secretary's designee shall provide written notice of revocation to the person to whom the certificate of need was issued, including a statement of the reasons for such revocation.

(7) The department shall apply the following procedures in transferring or assigning a certificate of need.

(a) The department shall consider a request to transfer or assign a certificate of need valid only when:

(i) The person to whom the certificate of need was originally issued, or personal representative, where the holder is deceased, submits to the department a written request that the certificate of need be transferred to another person and gives the full name and complete address of the other person; and

(ii) The person to whom the current holder of the certificate of need wishes to transfer the certificate sends an application for such transfer on a form and in such a manner as prescribed and published by the department.

(b) The department shall review applications for transfer or assignment of a certificate of need according to the:

(i) Expedited review procedures in WAC 246-310-150; or

(ii) Regular review procedures in WAC 246-310-160.

(c) The secretary's designee shall base his or her decision to approve or deny an application to transfer or assign a certificate of need on:

(i) The demonstrated ability of the person wishing to acquire the certificate of need to undertake, complete, and operate the project in accordance with the following review criteria:

- (A) WAC 246-310-220 (1) and (3), and
- (B) WAC 246-310-230 (1), (3), and (5).

(ii) The continuing conformance of the project with all other applicable review criteria.

(d) When the person submitting an application to transfer or assign a certificate of need proposes to modify the project description or the maximum capital expenditure, the department shall inform in writing such person that a new or amended certificate of need is required.

(e) When the department denies an application for transfer or assignment of a certificate of need, the department shall inform in writing the person who submitted the application of the reasons for such denial.

(f) The department shall not transfer or assign any certificate of need issued after February 1, 1988, except when:

(i) Prior to completion of the project, death or divorce of one or more persons holding a certificate renders it impossible or impractical to complete the project in the absence of a transfer or assignment; or

(ii) After commencement, a substantial portion of the project has been completed by the original holder of the certificate.

(g) The department shall not transfer or assign a certificate of need under subsections (7)(f)(i) and (ii) of this section when the authorized project is to be relocated.

(h) When the department transfers a certificate of need for a project which has not been commenced, the transferred certificate of need shall have a validity period of two years from the date of issue with the provision for one six-month extension if the holder can demonstrate to the satisfaction of the secretary's designee that substantial and continuing progress towards commencement has been made.

[Statutory Authority: Chapter 70.38 RCW. 96-24-052, § 246-310-500, filed 11/27/96, effective 12/28/96. Statutory Authority: RCW 70.38.135. 91-05-093 (Order 143), § 246-310-500, filed 2/20/91, effective 3/23/91. Statutory Authority: RCW 43.70.040. 91-02-049 (Order 121), recodified as § 246-310-500, filed 12/27/90, effective 1/31/91. Statutory Authority: RCW 70.38.115. 89-02-040 (Order 2745), § 248-19-440, filed 12/30/88. Statutory Authority: RCW 70.38.135. 86-06-030 (Order 2344), § 248-19-440, filed 2/28/86; 81-09-012 (Order 210), § 248-19-440, filed 4/9/81, effective 5/20/81. Statutory Authority: Chapter 70.38 RCW. 79-12-079 (Order 188), § 248-19-440, filed 11/30/79.]

**WAC 246-310-560 Provision for reconsideration decision.** (1) Any person or affected person may, for good cause shown, request a public hearing for the purpose of reconsideration of the decision of the secretary's designee on a certificate of need application or withdrawal of a certificate of need.<sup>1</sup>

(2) The department shall conduct a reconsideration hearing if it finds the request is in accord with the following requirements:

(a) The request for a reconsideration hearing shall be written, be received by the department within twenty-eight days of the department's decision on the certificate of need application or withdrawal of the certificate of need, state in detail the grounds which the person requesting the hearing

believes to show good cause, and be signed by the person making the request.

(b) Grounds which the department may deem to show good cause for a reconsideration hearing shall include but not be limited to the following:

(i) Significant relevant information not previously considered by the department which, with reasonable diligence, could not have been presented before the department made its decision;

(ii) Information on significant changes in factors or circumstances relied upon by the department in making its findings and decision; or

(iii) Evidence the department materially failed to follow adopted procedures in reaching a decision.

(3) A reconsideration hearing shall commence within thirty days after receipt of the request for the hearing.

(4) Notification of a public reconsideration hearing on a certificate of need application or withdrawal of a certificate of need shall be sent prior to the date of such hearing by the department to the following:

(a) The person requesting the reconsideration hearing;

(b) The person submitting the certificate of need application which is under reconsideration or the holder of the certificate of need;

(c) Health care facilities and health maintenance organizations located in the health service area where the project is proposed to be located providing services similar to the services under review;

(d) In the case of a concurrent review, other applicants competing as described in WAC 246-310-080; and to

(e) Other persons requesting the department to send them such notification.

(5) The department shall, within forty-five days after the conclusion of a reconsideration hearing, make written findings stating the basis of the decision made after such hearing.

(6) The secretary's designee may, upon the basis of the department's findings on a reconsideration hearing, issue or reissue, amend, revoke, or withdraw a certificate of need or impose or modify conditions on a certificate of need for the project about which the reconsideration hearing was conducted.

(7) An applicant requesting a reconsideration hearing under the provisions of this section does not forfeit his or her rights to an adjudicative appeal under the provisions of WAC 246-310-610.

Note: <sup>1</sup>No fee will be charged for a reconsideration hearing.

[Statutory Authority: Chapter 70.38 RCW. 96-24-052, § 246-310-560, filed 11/27/96, effective 12/28/96. Statutory Authority: RCW 70.38.135 and 70.38.919. 92-02-018 (Order 224), § 246-310-560, filed 12/23/91, effective 1/23/92. Statutory Authority: RCW 43.70.040. 91-02-049 (Order 121), recodified as § 246-310-560, filed 12/27/90, effective 1/31/91. Statutory Authority: RCW 70.38.135. 86-06-030 (Order 2344), § 248-19-430, filed 2/28/86; 81-09-012 (Order 210), § 248-19-430, filed 4/9/81, effective 5/20/81. Statutory Authority: Chapter 70.38 RCW. 79-12-079 (Order 188), § 248-19-430, filed 11/30/79.]

**WAC 246-310-570 Circumstances for which an amended certificate of need is required.** (1) An amended certificate of need shall be required for any of the following modifications of a project for which a certificate of need was

issued and has been submitted in accordance with subsection (2) of this section:

- (a) An addition of a new service;
  - (b) An expansion of a service beyond that which was included in the certificate of need application on which the issuance of the certificate of need was based;
  - (c) An increase in the inpatient bed capacity;
  - (d) The modification or release of a condition placed on a certificate of need;
  - (e) A significant reduction in the scope of a project for which a certificate of need has been issued without a commensurate reduction in the cost of the project, or the project cost increases (as represented in bids on a construction project or final cost estimate or estimates acceptable to the person to whom the certificate of need was issued) when the total of such increases exceeds twelve percent or fifty thousand dollars, whichever is greater, over the maximum capital expenditure specified by the secretary's designee in issuing the certificate of need: *Provided however*, That the review of such reductions or cost increases shall be restricted to the continued conformance of the project with the criteria contained in WAC 246-310-220 and 246-310-240; or
  - (f) A change in the approved site.
- (2) An application to amend a certificate of need shall be submitted and the certificate of need will be issued or denied prior to project completion except for projects involving construction. For projects involving construction, an amendment application may be submitted up to ninety days after project completion provided the applicant meets the following eligibility requirements:
- (a) Eligibility requirements for a ninety-day extension to submit an application to amend a certificate of need.
    - (i) The applicant has submitted quarterly reports and updated the capital expenditures as required in WAC 246-310-590;
    - (ii) The quarterly progress reports identified that the actual construction costs had exceeded twelve percent or fifty thousand dollars (whichever is greater) of the approved capital expenditure; and
    - (iii) The department did not notify the applicant in writing that an amended certificate of need was needed.
  - (b) In the event the applicant has submitted quarterly progress reports as identified in (a)(i) of this subsection and the reports did not reflect that the actual construction costs had exceeded the approved capital expenditure, the applicant would only be eligible for a ninety-day extension if the applicant can document:
    - (i) All costs in excess of twelve percent or fifty thousand dollars (whichever is greater) of the approved capital expenditure were totally unforeseen as documented by a signed affidavit from the contractor; and
    - (ii) That all the excess costs were incurred after the submission of the last quarterly progress report preceding the projects' completion.
- (3) An application for an amended certificate of need shall be submitted in accordance with the provisions of WAC 246-310-090.
- (4) An application for an amended certificate of need may be reviewed under the expedited review process set forth in WAC 246-310-150.
- (5) The department shall provide a written determination as to the requirement for an amended certificate of need

within twenty-one days after receipt of a request for such determination.

[Statutory Authority: Chapter 70.38 RCW. 96-24-052, § 246-310-570, filed 11/27/96, effective 12/28/96. Statutory Authority: RCW 70.38.135 and 70.38.919. 92-02-018 (Order 224), § 246-310-570, filed 12/23/91, effective 1/23/92. Statutory Authority: RCW 43.70.040. 91-02-049 (Order 121), recodified as § 246-310-570, filed 12/27/90, effective 1/31/91. Statutory Authority: RCW 70.38.135. 86-06-030 (Order 2344), § 248-19-450, filed 2/28/86; 81-09-012 (Order 210), § 248-19-450, filed 4/9/81, effective 5/20/81. Statutory Authority: Chapter 70.38 RCW. 79-12-079 (Order 188), § 248-19-450, filed 11/30/79.]

**WAC 246-310-580 Validity and extensions.** (1) A certificate of need shall be valid for two years: *Provided*, That one six-month extension may be made if the certificate holder can demonstrate that substantial and continuing progress toward commencement of the project has been made.

(2) In the case of a project involving construction, substantial and continuing progress shall include one of the following:

(a) When review and approval by the department of the final plans for construction is required, the submission of working drawings;

(b) When plan approval is not required by the department, receipt of copies of the working drawings for construction; or

(c) In the event working drawings have not been submitted, the applicant must demonstrate that he or she has made continuous progress toward commencement of the project.

(3) A project for which a certificate of need has been issued shall be commenced during the validity period for the certificate of need.

(4) Applications for extensions of the validity period of certificates of need shall be submitted to the department at least one hundred twenty calendar days before the expiration of the certificate of need, and shall contain such information as may be required by the department to determine the extent of progress toward commencement of construction or other action necessary to a project.

(5) An application for an extension of a certificate of need submitted less than one hundred twenty calendar days before the expiration of the certificate of need shall not be reviewed, unless the applicant can demonstrate to the satisfaction of the department unforeseen occurrences during the last one hundred twenty days of the validity period of the certificate of need prevented commencement of construction as previously anticipated by the applicant.

(6) Commencement of the project shall not be undertaken after the expiration of the certificate of need unless a new certificate of need application has been reviewed and a new certificate of need has been issued by the secretary's designee.

(7)(a) In the case of a request by a nursing home to extend its conversion rights to beds banked under the provisions of RCW 70.38.111(8) for an additional four years, the nursing home must meet the following requirements:

(i) The request shall be made a minimum ninety days prior to the end of the four-year validity period of the original bed banking request.



(ii) The nursing home shall demonstrate it has complied with the applicable notification requirements under WAC 246-310-395;

(iii) The nursing home has and is currently meeting the exemption requirements in WAC 246-310-043; and

(iv) The nursing home has implemented the alternative service or services identified in the bed banking request. If the service or services have not been implemented, an explanation of why such services have not been implemented and rationale for why the department should grant its extension request.

(b) The department shall notify the nursing home within thirty days of the extension request as to whether an extension of the nursing home's conversion rights is recognized. The nursing home does not forfeit its right to extend its conversion rights under this section if the department does not respond within this time frame, nor does the nursing home obtain rights that it otherwise would not have under applicable statutes or rules if the department does not respond within the time frame.

[Statutory Authority: Chapter 70.38 RCW. 96-24-052, § 246-310-580, filed 11/27/96, effective 12/28/96. Statutory Authority: RCW 43.70.040. 91-02-049 (Order 121), recodified as § 246-310-580, filed 12/27/90, effective 1/31/91. Statutory Authority: RCW 70.38.135. 86-06-030 (Order 2344), § 248-19-460, filed 2/28/86. Statutory Authority: Chapter 70.38 RCW. 79-12-079 (Order 188), § 248-19-460, filed 11/30/79.]

**WAC 246-310-590 Monitoring of approved projects.** (1) The department shall monitor the costs and components of approved projects to assure conformance with certificates of need that have been issued.

(2) The department shall require periodic progress reports from those applicants to whom certificates of need have been issued.

(a) Progress reports shall be required quarterly.

(b) Progress reports shall be submitted in the form and manner prescribed and published by the department.

(3) Information required on approved projects may include:

(a) Actual project costs;

(b) Changes in the project;

(c) Financing arrangements, different than approved under the certificate of need;

(d) Project commencement date;

(e) Progress toward completion of construction; and

(f) Project completion date.

(4) The information required on approved projects may vary according to the nature of the projects.

(5) Progress reports on a project for which a particular certificate of need has been issued shall terminate when the project has been completed and the department finds it has received all the information necessary to determine the project has been completed in accordance with the certificate of need which had been issued and the provisions of chapter 246-310 WAC.

[Statutory Authority: Chapter 70.38 RCW. 96-24-052, § 246-310-590, filed 11/27/96, effective 12/28/96. Statutory Authority: RCW 70.38.135 and 70.38.919. 92-02-018 (Order 224), § 246-310-590, filed 12/23/91, effective 1/23/92. Statutory Authority: RCW 43.70.040. 91-02-049 (Order 121), recodified as § 246-310-590, filed 12/27/90, effective 1/31/91. Statutory Authority: RCW 70.38.135. 86-06-030 (Order 2344), § 248-19-470, filed 2/28/86. Statutory Authority: Chapter 70.38 RCW. 79-12-079 (Order 188), § 248-19-470, filed 11/30/79.]

**WAC 246-310-600 Withdrawal of a certificate of need.** (1) The secretary's designee may withdraw a certificate of need if the department determines that the holder of a certificate is not meeting the timetable specified in the certificate of need application for completing the project and is not making a good-faith effort to meet such timetable.

(2) In reviewing a proposed withdrawal of a certificate of need, the department shall adhere to the provisions of WAC 246-310-170, 246-310-180, 246-310-190, and 246-310-560.

(3) The review period for a proposed withdrawal of a certificate of need shall not exceed ninety days unless extended by the department to allow sufficient time for the conduct of a public hearing pursuant to the provisions of WAC 246-310-180. Such extension shall not exceed thirty days.

(4) The findings of the department's review of a proposed withdrawal of a certificate of need shall be stated in writing and include the basis for the decision of the secretary's designee as to whether the certificate of need is to be withdrawn for a proposed project. A copy of the department's written findings and statement of the decision of the secretary's designee on the proposed withdrawal of a certificate of need shall be sent to:

(a) The holder of the certificate of need;

(b) In the case of a project proposed by a health maintenance organization, the appropriate regional office of the United States Department of Health and Human Services.

(5) The written findings and statement of the decision of the secretary's designee on the proposed withdrawal of a certificate of need shall be available to others requesting the certificate of need unit to provide access to a copy of such findings and statement.

(6) When a certificate of need is for multiple services or multiple components or the proposed project is to be multiphased, the secretary's designee may take individual and different action regarding withdrawal of the certificate of need on separable portions of the certificate of need.

[Statutory Authority: Chapter 70.38 RCW. 96-24-052, § 246-310-600, filed 11/27/96, effective 12/28/96. Statutory Authority: RCW 70.38.135 and 70.38.919. 92-02-018 (Order 224), § 246-310-600, filed 12/23/91, effective 1/23/92. Statutory Authority: RCW 43.70.040. 91-02-049 (Order 121), recodified as § 246-310-600, filed 12/27/90, effective 1/31/91. Statutory Authority: RCW 70.38.135. 86-06-030 (Order 2344), § 248-19-475, filed 2/28/86; 81-09-012 (Order 210), § 248-19-475, filed 4/9/81, effective 5/20/81.]

**WAC 246-310-610 Adjudicative proceeding.** (1) An applicant denied a certificate of need or a certificate holder whose certificate was suspended or revoked has the right to an adjudicative proceeding.

(2) A certificate applicant or holder contesting a department certificate decision shall within twenty-eight days of receipt of the department's decision or reconsidered decision:

(a) File a written application for an adjudicative proceeding by a method showing proof of receipt with the Office of Professional Standards, Department of Health, 2413 Pacific Avenue, P.O. Box 47872, Olympia, WA 98504-7872; and

(b) Include in or with the application:



- (i) A specific statement of the issue or issues and law involved;
- (ii) The grounds for contesting the department decision; and
- (iii) A copy of the contested department decision.

(3) The proceeding is governed by the Administrative Procedure Act (chapter 34.05 RCW), this chapter, and chapter 246-08 WAC. If a provision in this chapter conflicts with chapter 246-08 WAC, the provision in this chapter governs.

(4) Any health care facility or health maintenance organization that:

- (a) Provides services similar to the services provided by the applicant and under review pursuant to this subsection;
- (b) Is located within the applicant's health service area; and

(c) Testified or submitted evidence at a public hearing held pursuant to RCW 70.38.115(9), shall be provided an opportunity to present oral or written testimony and argument in a proceeding under RCW 70.38.115 (10)(a) provided that the health care facility or health maintenance organization had, in writing, requested to be informed of the department's decision. If the department desires to settle with the applicant prior to the conclusion of the adjudicative proceeding, the department shall so inform the health care facility or health maintenance organization and afford them the opportunity to comment, in advance, on the proposed settlement.

[Statutory Authority: Chapter 70.38 RCW. 96-24-052, § 246-310-610, filed 11/27/96, effective 12/28/96. Statutory Authority: RCW 70.38.135 and 70.38.919. 92-02-018 (Order 224), § 246-310-610, filed 12/23/91, effective 1/23/92. Statutory Authority: RCW 43.70.040. 91-02-049 (Order 121), recodified as § 246-310-610, filed 12/27/90, effective 1/31/91. Statutory Authority: Chapter 34.05 RCW, RCW 34.05.220 (1)(a), 70.38.135 and 1989 1st ex.s. c 9 § 607. 90-06-019 (Order 039), § 248-19-480, filed 2/28/90, effective 3/1/90. Statutory Authority: RCW 70.38.135. 86-06-030 (Order 2344), § 248-19-480, filed 2/28/86; 82-19-055 (Order 244), § 248-19-480, filed 9/15/82; 81-09-012 (Order 210), § 248-19-480, filed 4/9/81, effective 5/20/81. Statutory Authority: Chapter 70.38 RCW. 79-12-079 (Order 188), § 248-19-480, filed 11/30/79.]

**WAC 246-310-620 Certificate of need program reports.** (1) The department shall prepare and publish annual reports containing information on certificate of need reviews in progress, reviews completed in the preceding twelve month period, and a general statement of the findings and decisions made in the course of those reviews.

(2) Upon request, the department shall provide notification to health care facilities and to other persons of the status of the department's review of projects subject to review and the findings made in the course of such review.

[Statutory Authority: RCW 43.70.040. 91-02-049 (Order 121), recodified as § 246-310-620, filed 12/27/90, effective 1/31/91. Statutory Authority: RCW 70.38.135. 81-09-012 (Order 210), § 248-19-490, filed 4/9/81, effective 5/20/81. Statutory Authority: Chapter 70.38 RCW. 79-12-079 (Order 188), § 248-19-490, filed 11/30/79.]

**WAC 246-310-630 Public access to records.** The general public shall have access in accordance with the provisions of chapter 42.17 RCW to all applications reviewed by the department and to all other written materials essential to any review by the department pursuant to the provisions of chapter 246-310 WAC.

[Statutory Authority: RCW 70.38.135 and 70.38.919. 92-02-018 (Order 224), § 246-310-630, filed 12/23/91, effective 1/23/92. Statutory Authority: RCW 43.70.040. 91-02-049 (Order 121), recodified as § 246-310-630, filed 12/27/90, effective 1/31/91. Statutory Authority: RCW 70.38.135. 81-09-012 (Order 210), § 248-19-500, filed 4/9/81, effective 5/20/81. Statutory Authority: Chapter 70.38 RCW. 79-12-079 (Order 188), § 248-19-500, filed 11/30/79.]

**WAC 246-310-900 Capital expenditure minimum adjustment procedures.** These rules and regulations are adopted pursuant to RCW 70.38.025 (6) and (12) for the purpose of establishing the index to be used and procedures for making adjustments to the "expenditure minimum" for capital expenditures which are subject to the requirements of the certificate of need program established under the provisions of chapter 70.38 RCW.

(1) Index to be used. For the purposes of the certificate of need program, the United States Department of Commerce Composite Construction Cost Index shall be used in the annual adjustments of the following:

The "expenditure minimum" as this term is defined in RCW 70.38.025 and WAC 246-310-010.

(2) Procedure for adjustment.

(a) On or before the first day of each January, the department shall adjust and publish the adjusted expenditure minimum for capital expenditures. Such adjusted minimums shall be in effect during the entire calendar year for which they are established.

(b) The adjustments in the minimums shall be based on the changes which occurred in the Department of Commerce Composite Construction Cost Index during the twelve month period ending the preceding October.

(c) The adjusted minimums shall be published by the department by public notice in one or more newspapers of general circulation within the state and through a written notice sent to each health care facility subject to the requirements of the certificate of need program, and each state-wide organization of such health care facilities.

[Statutory Authority: Chapter 70.38 RCW. 96-24-052, § 246-310-900, filed 11/27/96, effective 12/28/96. Statutory Authority: RCW 70.38.135 and 70.38.919. 92-02-018 (Order 224), § 246-310-900, filed 12/23/91, effective 1/23/92.]

**WAC 246-310-990 Certificate of need review fees.**

(1) An application for a certificate of need under chapter 246-310 WAC shall include payment of a fee consisting of the following:

(a) A nonrefundable application processing fee in the amount of seven hundred fifty dollars;

(b) A review fee based on the project description and the total capital expenditure.

Project Description	Capital Expenditure Range	Review Fee
Additional kidney disease treatment center stations	\$ 0 - 100,001 250,001 or more	\$ 4,300 5,700 7,600
Administrative or emergency review	0 - 250,000 250,001 or more	5,400 8,100
Amendment to a certificate of need		5,000
Bed addition of less than 10 beds	0 - 100,000 100,001 - 5,000,000 5,000,001 or more	4,300 5,700 7,600

Bed addition of 10 beds or more	0 - 500,000 500,001 - 5,000,000 5,000,001 or more	8,100 11,900 15,700
Bed redistribution or bed relocation	0 - 100,000 100,001 - 2,000,000 2,000,001 or more	7,000 10,600 13,200
Capital expenditure over the minimum expenditure	Exp. min. - 5,000,000 5,000,001 - 10,000,000 10,000,001 or more	7,600 9,600 13,600
Establishment of a new hospital, nursing home, or continuing care retirement community	0 - 2,000,000 2,000,001 or more	10,600 15,700
Establishment of a new home health agency, hospice, ambulatory surgery facility, or kidney disease treatment center	0 1 - 100,000 100,001 or more	3,700 5,700 7,600
Extension of the certificate of need validity period (projects involving plans review by construction review unit) or extension of nursing home bed banking		150
Extension of the certificate of need validity period (other projects)		900
Replacement of an existing health care facility	1 - 2,000,000 2,000,001 - 5,000,000 5,000,001 or more	5,400 8,100 9,600
Sale, purchase, or lease of part or all of an existing hospital	1 - 5,000,000 5,000,001 or more	7,600 11,500
Substantial change in services, or offering a new tertiary health service	0 - 100,000 100,001 - 2,000,000 2,000,001 or more	8,100 10,600 15,700
Transfer of a certificate of need		2,700

(c) A nonrefundable two thousand dollar actuarial review fee surcharge for an application sponsored by an existing or proposed continuing care retirement community (CCRC) as defined in WAC 246-310-130 (3)(b).

(2) For purposes of subsection (1)(b) of this section, "total capital expenditure" means the total project costs to be capitalized according to generally accepted accounting principles consistently applied, and includes, but is not limited to, the following:

- (a) Legal fees;
- (b) Feasibility studies;
- (c) Site development;
- (d) Soil survey and investigation;
- (e) Consulting fees;
- (f) Interest expenses during construction;
- (g) Temporary relocation;
- (h) Architect and engineering fees;
- (i) Construction, renovation, or alteration;
- (j) Total costs of leases of capital assets;

- (k) Labor;
- (l) Materials;
- (m) Equipment;
- (n) Sales taxes;
- (o) Equipment delivery; and
- (p) Equipment installation.

(3) Where more than one project description under subsection (1)(b) of this section applies to an application, the applicant shall use the project description and capital expenditure range with the highest review fee in calculating the payment to accompany the application submittal.

(4) The applicant shall accompany the submittal of an amendment to a certificate of need application with a fee consisting of the following:

(a) A nonrefundable processing fee of five hundred dollars;

(b) When the amendment increases the capital expenditure, or results in a project description with a larger review fee, an additional review fee based on the difference between the review fee previously paid when the application was submitted and the review fee applicable to the greater capital expenditure or new project description; and

(c) When the amendment decreases the capital expenditure, or results in a project description with a smaller review fee, the department shall refund to the applicant the difference between the review fee previously paid when the application was submitted and the review fee applicable to the smaller capital expenditure or new project description.

(5) When an application for a certificate of need is returned by the department in accordance with the provisions of WAC 246-310-090 (2)(b) or (e), the department shall refund all review fees paid.

(6) When an applicant submits a written request to withdraw an application before the beginning of review, the department shall refund any review fees paid by the applicant.

(7) When an applicant submits a written request to withdraw an application after the beginning of review, but before the beginning of the ex parte period as determined by the department consistent with WAC 246-310-190, the department shall refund one-half of all review fees paid.

(8) When an applicant submits a written request to withdraw an application after the beginning of the ex parte period as determined by the department consistent with WAC 246-310-190, the department shall not refund any of the review fees paid.

(9) Other certificate of need program fees are:

(a) A nonrefundable two hundred fifty dollar processing fee for each request for an exemption from certificate of need review submitted under the provisions of WAC 246-310-040, 246-310-041, 246-310-042, 246-310-043; and

(b) A nonrefundable two hundred fifty dollar processing fee for each request for an exemption from certificate of need review submitted under the provisions of RCW 70.38.105 (4)(d).

[Statutory Authority: Chapter 70.38 RCW. 96-24-052, § 246-310-990, filed 11/27/96, effective 12/28/96. Statutory Authority: RCW 70.38.135, 43.70.250 and 70.38.919. 92-02-018 (Order 224), § 246-310-990, filed 12/23/91, effective 1/23/92. Statutory Authority: RCW 43.70.040. 91-02-049 (Order 121), recodified as § 246-310-990, filed 12/27/90, effective 1/31/91. Statutory Authority: Chapter 70.38 RCW. 90-15-001 (Order 070), § 440-44-030, filed 7/6/90, effective 8/6/90. Statutory Authority: RCW 43.20A.055. 89-21-042 (Order 2), § 440-44-030, filed 10/13/89,

effective 11/13/89; 87-16-084 (Order 2519), § 440-44-030, filed 8/5/87; 87-12-049 (Order 2494), § 440-44-030, filed 6/1/87; 84-13-006 (Order 2109), § 440-44-030, filed 6/7/84; 83-21-015 (Order 2037), § 440-44-030, filed 10/6/83. Statutory Authority: 1982 c 201. 82-13-011 (Order 1825), § 440-44-030, filed 6/4/82.]

[Statutory Authority: RCW 43.70.110. 91-16-107 (Order 185), § 246-314-010, filed 8/7/91, effective 9/7/91. Statutory Authority: RCW 43.70.040. 91-02-050 (Order 122), § 246-314-010, filed 12/27/90, effective 1/31/91.]

**Chapter 246-314 WAC  
FACILITY CONSTRUCTION REVIEW**

**WAC**

- 246-314-001 Purpose.
- 246-314-010 Definitions.
- 246-314-990 Construction review fees.

**WAC 246-314-001 Purpose.** The purpose of this chapter is to establish fees for reviewing and approving health and residential care facility construction projects.

[Statutory Authority: RCW 43.70.110. 91-16-107 (Order 185), § 246-314-001, filed 8/7/91, effective 9/7/91. Statutory Authority: RCW 43.70.040. 91-02-050 (Order 122), § 246-314-001, filed 12/27/90, effective 1/31/91.]

**WAC 246-314-010 Definitions.** (1) "Department" means the Washington state department of health.

(2) "Project" means a construction endeavor including new construction, replacement, alterations, additions, expansions, conversions, improvements, remodeling, renovating, and upgrading of the following types of facilities:

(a) "Adult residential rehabilitation center" as defined under chapters 71.12 RCW and 246-325 WAC;

(b) "Boarding homes" as defined under chapters 18.20 RCW and 246-316 WAC;

(c) "Maternity homes" and "childbirth centers" as defined under chapters 18.46 RCW and 246-329 WAC;

(d) "Nursing homes" as defined under chapters 18.51 RCW and 248-14 WAC;

(e) "Private psychiatric hospitals" as defined under chapters 71.12 RCW and 246-322 WAC;

(f) "Private alcoholism hospitals" as defined under chapters 71.12 RCW and 246-324 WAC;

(g) "Private alcoholism treatment facilities" as defined under chapters 71.12 RCW and 246-326 WAC;

(h) "Residential treatment facilities for psychiatrically impaired children and youth" as defined under chapters 71.12 RCW and 246-323 WAC;

(i) "Hospitals" as defined under chapters 70.41 RCW and 246-318 WAC; and

(j) "Hospice care center" as defined under chapters 70.126 RCW and 246-321 WAC.

(3) "Project sponsor" means the person, persons or organization, planning and contracting for the design and construction of facilities, generally the owner or the owner's representative.

(4) "Project cost" means all costs, except taxes, directly associated with the project, initially estimated and corrected by certification to the date of completion of the project and including:

(a) All architectural-engineering designs, plans, drawings, and specifications;

(b) All fixed and installed equipment in the project; and

(c) Contractor supervision, inspection, and overhead.

**WAC 246-314-990 Construction review fees.** (1) The project sponsor shall submit to the department:

(a) A completed project review application form along with project documents for review; and

(b) The appropriate fee based upon the initial project construction cost as determined from the following construction fee table:

**CONSTRUCTION FEE TABLE**

Project Cost	Project Review Fee
\$ 0 to \$ 999	\$ 120
1,000 to 1,999	250
2,000 to 2,999	325
3,000 to 4,999	410
5,000 to 9,999	530
10,000 to 19,999	665
20,000 to 29,999	820
30,000 to 39,999	975
40,000 to 49,999	1,125
50,000 to 64,999	1,325
65,000 to 79,999	1,535
80,000 to 99,999	1,845
100,000 to 124,999	2,200
125,000 to 149,999	2,550
150,000 to 199,999	2,970
200,000 to 249,999	3,325
250,000 to 324,999	3,650
325,000 to 449,999	4,100
450,000 to 574,999	4,600
575,000 to 699,999	5,200
700,000 to 849,999	5,825
850,000 to 999,999	6,550
1,000,000 to 1,249,999	7,150
1,250,000 to 2,499,999	7,850
2,500,000 to 2,999,999	8,550
3,000,000 to 3,499,999	9,300
3,500,000 to 4,999,999	10,750
5,000,000 to 6,999,999	12,200
7,000,000 to 9,999,999	13,800
10,000,000 to 14,999,999	15,850
15,000,000 to 19,999,999	17,850
20,000,000 to 29,999,999	19,900
30,000,000 to 39,999,999	23,000
40,000,000 to 59,999,999	25,600
60,000,000 and over	28,700

(2) The department shall charge a flat fee of eighty dollars for a project involving installation of carpet only.

(3) The project sponsor may request a reduction in the project review fee for fixed or installed technologically advanced diagnostic or treatment equipment projects including lithotripters, CT scans, linear accelerators, or MRI's.

(4) The department may adjust the project review fee if:  
(a) The final project cost changes as evidenced on the certificate of project completion card; or

(b) The project sponsor requests a reduction in the fee according to subsection (3) of this section.

[Statutory Authority: RCW 43.70.250, 43.70.110 and 43.20B.020. 95-12-097, § 246-314-990, filed 6/7/95, effective 7/8/95. Statutory Authority: RCW 43.70.110. 91-16-107 (Order 185), § 246-314-990, filed 8/7/91, effective 9/7/91. Statutory Authority: RCW 43.70.040. 91-02-050 (Order 122), § 246-314-990, filed 12/27/90, effective 1/31/91.]

**Chapter 246-316 WAC  
BOARDING HOMES**

**WAC**

246-316-001	Purpose and scope.
246-316-010	Definitions.
246-316-020	Licensure—Initial, renewal, day care approval respite care, modifications.
246-316-030	Responsibilities and rights—Licensee and department.
246-316-040	Administrator.
246-316-045	Criminal history, disclosure, and background inquiries.
246-316-050	Staff.
246-316-055	Policies and procedures.
246-316-060	HIV/AIDS education and training.
246-316-070	Construction.
246-316-080	Communication system.
246-316-090	Water supply.
246-316-100	Sewage and liquid waste disposal.
246-316-110	Garbage and refuse disposal.
246-316-120	Lighting.
246-316-130	Heating—Temperature.
246-316-140	Ventilation.
246-316-150	Resident room—Room furnishings—Storage.
246-316-160	Toilet rooms and bathrooms.
246-316-170	Food and nutrition services.
246-316-180	Day rooms.
246-316-190	Laundry.
246-316-200	Storage space.
246-316-210	Stairs—Ramps.
246-316-220	Guardrails—Handrails.
246-316-230	Maintenance and housekeeping.
246-316-240	Criteria for accepting and retaining residents.
246-316-250	Resident rights.
246-316-260	Resident services.
246-316-265	Limited nursing services.
246-316-268	Health care services—Resident-arranged.
246-316-280	Notification—Change in resident's condition.
246-316-290	Safety measures and quality assurance.
246-316-300	Medication services.
246-316-310	Resident register.
246-316-320	Resident health record.
246-316-330	Adult day care.
246-316-335	Residents—Dementia care.
246-316-340	Exemptions.
246-316-990	Fees.

**DISPOSITION OF SECTIONS FORMERLY  
CODIFIED IN THIS CHAPTER**

246-316-270	First aid services. [Statutory Authority: RCW 43.70.040. 91-02-049 (Order 121), recodified as § 246-316-270, filed 12/27/90, effective 1/31/91. Statutory Authority: RCW 18.20.090. 89-09-034 (Order 2786), § 248-16-222, filed 4/14/89; 83-13-068 (Order 264), § 248-16-222, filed 6/16/83; Order 147, § 248-16-222, filed 6/29/77.] Repealed by 94-13-180, filed 6/21/94, effective 7/22/94. Statutory Authority: RCW 18.20.090.
-------------	--

**WAC 246-316-001 Purpose and scope.** Chapter 246-316 WAC implements chapter 18.20 RCW by establishing minimum standards for boarding homes.

[Statutory Authority: RCW 18.20.090. 94-13-180, § 246-316-001, filed 6/21/94, effective 7/22/94. Statutory Authority: RCW 43.70.040. 91-02-049 (Order 121), recodified as § 246-316-001, filed 12/27/90, effective 1/31/91. Statutory Authority: 1985 c 213. 86-08-002 (Order 2348), § 248-16-999, filed 3/20/86; Regulation .16.999, effective 3/11/60.]

**WAC 246-316-010 Definitions.** For the purpose of this chapter, the following words and phrases shall have the following meanings unless the context clearly indicates otherwise.

(1) "Abuse" means an act by any individual which injures, exploits or in any way jeopardizes a resident's health, welfare, or safety, including but not limited to:

(a) Physically damaging or potentially damaging nonaccidental acts;

(b) Emotionally damaging verbal behavior and harassment; and

(c) Sexual use, exploitation and mistreatment through inappropriate touching, inappropriate remarks or encouraging participation in pornography or prostitution.

(2) "Activities of daily living" means those tasks related to basic personal care such as bathing, toileting, dressing, grooming, hygiene, ambulation, and eating.

(3) "Aged person" means, according to RCW 18.20.020, a person of the age of sixty-five years or more, or a person of less than sixty-five years who by reason of infirmity requires domiciliary care.

(4) "Ambulatory" means capable of walking or traversing a normal path to safety without the physical assistance of another individual;

(a) "Semi-ambulatory" means physically and mentally capable of traversing a normal path to safety with the use of mobility aids, but unable to ascend or descend stairs without the physical assistance of another individual;

(b) "Nonambulatory" means unable to walk or traverse a normal path to safety without the physical assistance of another individual.

(5) "Bathing fixture" means a bathtub, shower or sit-down shower.

(6) "Bathroom" means a room containing at least one bathing fixture.

(7) "Board" means, in the definition of boarding home, the provision of meal service and lodging.

(8) "Boarding home" means any home or other institution, however named, which is advertised, announced or maintained for the express or implied purpose of providing board and domiciliary care to three or more aged persons not related by blood or marriage to the operator. It shall not include facilities certified as group training homes pursuant to RCW 71A.22.040, nor any home, institution or section thereof which is otherwise licensed and regulated under the provisions of state law providing specifically for the licensing and regulation of such home, institution or section thereof. Nor shall it include any independent senior housing, independent living units in continuing care retirement communities, or other similar living situations including those subsidized by the department of housing and urban development.

(9) "Colostomy care, uncomplicated routine" means an act of changing a colostomy bag and dressing according to boarding home procedures approved by a RN or physician, when the resident does not:

(a) Have colostomy complications, including but not limited to obvious infection, constipation, diarrhea, painful, cracked or bleeding skin; or

(b) Need colostomy irrigations.

(10) "Construction" means:

(a) A new building to be used as a boarding home or part of a boarding home;

(b) An addition, modification or alteration to the facility which changes the department-approved use of an existing boarding home or portion of a boarding home; and

(c) An existing building or portion thereof to be converted for use as a boarding home.

(11) "Continuing care contract" means, as stated in RCW 70.38.025, a contract providing a person, for the duration of that person's life or for a term in excess of one year, shelter along with nursing, medical, health-related, or personal care services, which is conditioned upon the transfer of property, the payment of an entrance fee to the provider of such services, or the payment of periodic charges for the care and services involved. A continuing care contract is not excluded from this definition because the contract is mutually terminable or because shelter and services are not provided at the same location.

(12) "Continuing care retirement community" means, as stated in RCW 70.38.025, an entity which provides shelter and services under continuing care contracts with its members and which sponsors or includes a health care facility or a health service.

(13) "Contractor" means an agency or person who contracts with a licensee to provide resident-care services or equipment.

(14) "Dementia care" means a form of care unique to the needs of residents with dementia of the alzheimer type exhibiting symptoms such as impaired cognition, confusion, memory loss, personality change, disorientation, chronic wandering, loss of inhibitions, and other intellectual losses diminishing the ability to perform basic personal care functions, which:

(a) May or may not be provided in a dementia care unit; and

(b) Is not normally applied to developmentally disabled individuals as defined in chapter 71A.10 RCW.

(15) "Dementia care unit" means an area of a boarding home staffed by individuals trained in dementia care and designed to facilitate the provision of such care to residents with dementia of the alzheimer type.

(16) "Department" means the Washington state department of health.

(17) "Dietitian" means an individual certified under chapter 18.138 RCW.

(18) "Document" means to record, with signature, title, date and time:

(a) Information about medication administration or disposal, a nursing care procedure, accident, occurrence or change in resident condition that may impact the care or needs of a resident; and

(b) Processes, events or activities that are required by law, rule or policy.

(19) "Domiciliary care" means:

(a) Assistance with activities of daily living provided by the licensee either directly or by contract;

(b) Assuming general responsibility for the safety and well-being of the resident; and

(c) Limited nursing services, if provided by the licensee.

(20) "Exploitation" means the illegal or improper use of a resident's resources, labor, or services for another person's profit or advantage.

(21) "Functional abilities" means the physical, mental, emotional and social abilities of a resident to cope with the affairs and activities of daily living.

(22) "Health care practitioner" means any individual authorized by Washington state law to provide health care,

including but not limited to a physician, dentist, chiropractor, naturopath, advanced registered nurse practitioner or physician's assistant.

(23) "Incident report" means a written record of an event involving a resident including but not limited to injury, abuse, neglect, or exploitation.

(24) "Infectious" means capable of causing infection or disease by entrance of organisms into the body which grow and multiply there, including but not limited to bacteria, viruses, protozoans, and fungi.

(25) "Independent living unit" means an apartment, condominium or other self-sufficient dwelling unit occupied by an individual or individuals not receiving domiciliary care.

(26) "Independent senior housing" means an independent living unit occupied by an individual or individuals sixty or more years of age.

(27) "Individual's resident plan" means a statement, written by the licensee and approved by the resident or resident's representative, of services to be provided based on an evaluation of the resident's needs.

(28) "Infirmity" means a disability which materially limits normal activity without requiring inpatient medical or nursing care. An infirmity may be based on conditions, including but not limited to physical handicap, mental illness, developmental disability, mental confusion, disability or disturbance.

(29) "Licensee" means the person to whom the department issues the boarding home license.

(30) "Licensed resident bed capacity" means the resident occupancy level requested by the licensee and approved by the department.

(31) "Licensed room list" means a department-approved list identifying resident rooms, the dimensions and calculated square footage of each room, the number of approved bed spaces, and other information relative to the licensed resident bed capacity of a boarding home.

(32) "Limited nursing services" means nursing care, consistent with chapters 18.78 and 18.88 RCW, provided by the licensee which does not include continuous skilled nursing care and supervision of the type provided in nursing homes licensed pursuant to chapter 18.51 RCW.

(33) "Medication" means "drugs" as defined in RCW 18.64.011.

(34) "Medication administration" means the act of an authorized individual giving medication to a resident in accordance with the laws and regulations governing such acts and entails:

(a) Comparing the label on the container with the prescriber's order or with a direct copy of a verified transcription of the order;

(b) Removing an individual dose from a previously dispensed, properly labeled container;

(c) Giving an individual dose to the proper resident; and

(d) Properly recording the medication, dose, and time given in the resident record.

(35) "Neglect" means conduct resulting in the deprivation of care necessary to maintain the resident's minimum physical and mental health including:

(a) Physical and material deprivation;

(b) Lack of medical care;

(c) Inadequate food, clothing or cleanliness;

- (d) Rejection;
- (e) Lack of social interaction and physical activity;
- (f) Lack of personal care; and
- (g) Lack of supervision appropriate for the resident's level of functioning.

(36) "Nurse" means an individual licensed either as a:

(a) "Licensed practical nurse" or "LPN" under chapter 18.78 RCW; or

(b) "Registered nurse" or "RN" under chapter 18.88 RCW.

(37) "Person" means any individual, firm, partnership, corporation, company, association, joint stock association, and the legal successor thereof.

(38) "Physician" means an individual licensed under chapter 18.57 or 18.71 RCW.

(39) "Prescriber" means a health care practitioner authorized by Washington state law to prescribe drugs.

(40) "Resident-care staff person" means any employee, temporary employee, volunteer, or contractor who provides direct care services to a resident.

(41) "Resident" means an individual living in a boarding home who is not related by blood or marriage to the operator of the boarding home and, by reason of age or infirmity, requires domiciliary care.

(42) "Resident's representative" means an individual legally appointed, or designated by the resident in writing, to act in the resident's behalf.

(43) "Respite care" means short term care of an aged person to temporarily relieve the family or other care-giver of providing that care.

(44) "Restraint" means any methods used to prevent or limit free body movement, including but not limited to:

(a) Confinement, unless agreed to as provided in WAC 246-316-335(3);

(b) An apparatus; and

(c) A drug given without, or contrary to, a legally prescribed order.

(45) "Room" means a space set apart by floor to ceiling partitions on all sides with all openings provided with doors or windows.

(46) "Staff person" means any employee, temporary employee, volunteer, or contractor.

(47) "State Building Code" means chapter 51-20 WAC, State Building Code adoption and amendment of the Uniform Building Code; chapter 51-22 WAC, State Building Code adoption and amendment of the Uniform Mechanical Code; chapter 51-24 WAC, State Building Code adoption and amendment of the Uniform Fire Code; and chapter 51-25 WAC, State Building Code adoption and amendment of the Uniform Fire Code.

(48) "Toilet" means a disposal apparatus fitted with a seat and flushing device used for urination and defecation.

(49) "Urethral catheter care, uncomplicated routine" means an act of performing perineal care, emptying the drainage bag, measuring the contents as required, and replacing and repositioning the drainage bag; but does not mean the act of inserting, irrigating, or removing the catheter.

(50) "Usable floor space" means:

(a) For boarding homes licensed prior to January 1, 1989, and continuously thereafter, floor area in resident bedrooms excluding walk-in closets; or

(b) For boarding homes licensed after December 31, 1988, floor area in living and sleeping rooms excluding bathrooms, toilets, toilet compartments, closets, halls, storage, and utility spaces.

(51) "Volunteer" means an individual who regularly provides planned and organized services within the boarding home without reimbursement, but does not mean an individual who visits residents or provides occasional entertainment.

(52) "Vulnerable adult" means an individual sixty years of age or older who has the functional, mental, or physical inability to care for himself or herself.

(53) "WISHA" means the Washington Industrial Safety and Health Act, chapter 49.17 RCW administered by the Washington state department of labor and industries.

[Statutory Authority: RCW 18.20.090. 94-13-180, § 246-316-010, filed 6/21/94, effective 7/22/94; 92-02-018 (Order 224), § 246-316-010, filed 12/23/91, effective 1/23/92. Statutory Authority: RCW 43.70.040. 91-02-049 (Order 121), recodified as § 246-316-010, filed 12/27/90, effective 1/31/91. Statutory Authority: RCW 18.20.090. 89-09-034 (Order 2786), § 248-16-001, filed 4/14/89; 83-13-068 (Order 264), § 248-16-001, filed 6/16/83; Order 147, § 248-16-001, filed 6/29/77; Order 97, § 248-16-001, filed 4/5/74; § 248-16-001, filed 10/3/67; Emergency Regulation filed 8/4/67; Regulation .16.001, effective 3/11/60; Subsec. 6, Rule 1 and Subsec. 7, Rule 2, filed 5/31/61.]

**WAC 246-316-020 Licensure—Initial, renewal, day care approval respite care, modifications.** (1) A person shall have a current license issued by the department before operating or advertizing a boarding home.

(2) An applicant for initial licensure shall submit to the department, forty-five days or more before commencing business:

(a) A completed application on forms provided by the department;

(b) Verification of department approval of facility plans submitted for construction review;

(c) A criminal history background check in accordance with WAC 246-316-045(2);

(d) The fee specified in WAC 246-316-990; and

(e) Other information as required by the department.

(3) A licensee shall apply for license renewal annually at least thirty days before the expiration date of the current license by submitting to the department:

(a) A completed application on forms provided by the department;

(b) A criminal history background check in accordance with WAC 246-316-045(2);

(c) The fee specified in WAC 246-316-990; and

(d) Other information as required by the department.

(4) A licensee, prior to accepting adults for day care, shall:

(a) Submit a letter to the department which includes:

(i) The maximum number of adults in the proposed day care program; and

(ii) An attestation of meeting the requirements in WAC 246-316-330;

(b) Obtain written department approval, including the maximum approved capacity for day care adults; and

(c) Maintain and post written approval in a conspicuous place on the boarding home premises.

(5) A licensee may provide respite care within the licensed bed capacity.

(6) A licensee, prior to changing the licensed bed capacity, shall:

(a) Submit a letter requesting approval to the department at least thirty days before the intended change;

(b) Submit the prorated fee as determined by the department; and

(c) Obtain an amended license indicating the new bed capacity.

(7) A licensee, prior to changing the location or use of rooms listed on the licensed room list shall:

(a) Notify the department in writing thirty days or more before the intended change; and

(b) Maintain a copy of the licensed room list.

(8) At least thirty days before selling, leasing, or renting the boarding home or changing officers or partners, and immediately upon a change of administrator, the licensee shall submit to the department:

(a) Name and address of the boarding home;

(b) Type of change;

(c) Full names of the present and prospective licensee;

(d) Date of proposed change;

(e) Names and addresses of all responsible officers or controlling partners; and

(f) A signed statement attesting that any new controlling officers are in compliance with this chapter.

[Statutory Authority: RCW 18.20.090, 94-13-180, § 246-316-020, filed 6/21/94, effective 7/22/94. Statutory Authority: RCW 43.43.830 through 43.43.842, 93-16-030 (Order 381), § 246-316-020, filed 7/26/93, effective 8/26/93. Statutory Authority: RCW 18.20.090 and 34.05.220, 92-02-018 (Order 224), § 246-316-020, filed 12/23/91, effective 1/23/92. Statutory Authority: RCW 43.70.040, 91-02-049 (Order 121), recodified as § 246-316-020, filed 12/27/90, effective 1/31/91. Statutory Authority: Chapter 34.05 RCW, RCW 34.05.220 (1)(a) and 18.20.909 [18.20.090], 90-06-019 (Order 039), § 248-16-031, filed 2/28/90, effective 3/1/90. Statutory Authority: RCW 18.20.090, 89-09-034 (Order 2786), § 248-16-031, filed 4/14/89.]

**WAC 246-316-030 Responsibilities and rights—Licensee and department.** (1) The licensee shall:

(a) Comply with the provisions of chapter 18.20 RCW and this chapter;

(b) Maintain and post in a conspicuous place on the boarding home premises:

(i) A current boarding home license; and

(ii) The name, address and telephone number of the department, appropriate resident advocacy groups, and state and local long-term care ombudsman with a brief description of ombudsman services;

(c) Maintain the occupancy level at or below the licensed resident bed capacity of the boarding home;

(d) Cooperate with the department during on-site surveys and investigations;

(e) Respond to a statement of deficiencies by submitting to the department, according to the dates specified on the statement of deficiencies form:

(i) A written plan of correction for each deficiency stated in the report; and

(ii) A progress report of corrections.

(2) An applicant or licensee may contest a disciplinary decision or action of the department according to the provisions of RCW 43.70.115, chapter 34.05 RCW and chapter 246-10 WAC.

(3) The department shall:

(a) Issue or renew a license when the applicant or licensee and the boarding home facilities meet the requirements in chapter 18.20 RCW and this chapter;

(b) Verify with the state director of fire protection that the boarding home complies with the fire protection standards, chapter 212-12 WAC, before issuing a license;

(c) Evaluate qualifications of individuals named in each license application prior to granting an initial or renewal license;

(d) Conduct unannounced on-site surveys and investigations at any time to determine compliance with chapter 18.20 RCW and this chapter;

(e) Give the administrator a written statement of deficiencies of chapter 18.20 RCW and this chapter observed during on-site surveys and investigations;

(f) Provide the licensee with a licensed room list; and

(g) Deny, suspend, modify, or revoke a boarding home license in accordance with RCW 43.70.115, chapter 34.05 RCW and chapter 246-10 WAC.

(4) The department may:

(a) Deny, suspend, or revoke a boarding home license if the department finds any individual named in the license application is unqualified or unable to operate or direct operation of the boarding home according to chapter 18.20 RCW and this chapter; and

(b) Deny, suspend, or revoke a boarding home license if the department finds the applicant, any individual named in the application, or the licensee:

(i) Knowingly or with reason to know, makes false statements of material fact in the application for the license or the renewal of the license;

(ii) Obtains or attempts to obtain a license by fraudulent means or misrepresentation;

(iii) Fails or refuses to comply with the requirements of chapter 18.20 RCW or this chapter;

(iv) Fails to meet other applicable state and local regulations;

(v) Had a license to operate an agency for the treatment or care of children, aged, ill, or infirm denied, revoked or suspended;

(vi) Has a record of a criminal or civil conviction for:

(A) Operating an agency for care of aged, children, ill, or infirm without an applicable license; or

(B) Any crime involving physical harm to another individual; or

(C) Any crime or disciplinary board final decision specified in RCW 43.43.830;

(vii) Commits, permits, aids, or abets an illegal act on boarding home premises;

(viii) Demonstrates cruelty, abuse, negligence, assault, or indifference to the welfare and well-being of a resident;

(ix) Abandons a resident by:

(A) Leaving the resident without the means or ability to obtain food, clothing, shelter, or health care; or

(B) Neglecting to provide thirty days written notice to the department and resident or the resident's representative of intent to close or leave the boarding home;

(x) Fails to exercise fiscal accountability and responsibility involving:

(A) A resident;

(B) The department;

(C) Public agencies; or



(D) The business community;

(xi) Refuses to allow department representatives to examine any part of the licensed premises including records required under this chapter;

(xii) Fails to take immediate corrective action in any instance of cruelty, assault, abuse, neglect, or indifference to the welfare of a resident; or

(xiii) Retaliates against a staff person, resident or other individual for reporting suspected abuse or other alleged improprieties.

(5) The department may summarily suspend a license pending proceeding for revocation or other action if the department determines a deficiency is an imminent threat to a resident's health, safety or welfare.

[Statutory Authority: RCW 18.20.090. 94-13-180, § 246-316-030, filed 6/21/94, effective 7/22/94; 92-02-018 (Order 224), § 246-316-030, filed 12/23/91, effective 1/23/92. Statutory Authority: RCW 43.70.040. 91-02-049 (Order 121), recodified as § 246-316-030, filed 12/27/90, effective 1/31/91. Statutory Authority: RCW 18.20.090. 89-09-034 (Order 2786), § 248-16-033, filed 4/14/89.]

**WAC 246-316-040 Administrator.** (1) The licensee shall employ an administrator and designate an alternate administrator who are twenty-one or more years of age, and:

(a) Hold an associate degree in health, personal care, or business administration, such as:

- (i) Social work;
- (ii) Nursing;
- (iii) Nutrition;
- (iv) Physical therapy;
- (v) Occupational therapy; or
- (vi) Management; or

(b) Hold an advanced degree in a field specified in (a) of this subsection; or

(c) Are certified by a department-recognized national accreditation health or personal care organization, such as the American Association of Homes for the Aging; or

(d) Have a high school diploma or equivalent and two years experience as a resident-care staff person, including one year of caring for residents representative of the population in the boarding home; or

(e) Held the position of an administrator in a Washington state licensed boarding home or nursing home prior to August 1, 1994.

(2) The administrator, or alternate administrator when acting as the administrator, shall:

(a) Be responsible for the overall twenty-four-hour-per-day operation of the boarding home; and

(i) Provide for the care of residents; and

(ii) Comply with this chapter and policies of the licensee; and

(b) Be available in person or by telephone or electronic pager at all times.

(3) The administrator and alternate administrator shall meet the requirements for criminal history background checks in WAC 246-316-045.

(4) Upon the appointment of a new administrator or alternate administrator, the licensee shall provide in writing to the department:

(a) The full name of the new administrator or alternate administrator; and

(b) A statement that the new administrator or alternate administrator is in compliance with this chapter.

[Statutory Authority: RCW 18.20.090. 94-13-180, § 246-316-040, filed 6/21/94, effective 7/22/94. Statutory Authority: RCW 43.43.830 through 43.43.842. 93-16-030 (Order 381), § 246-316-040, filed 7/26/93, effective 8/26/93. Statutory Authority: RCW 18.20.090. 92-02-018 (Order 224), § 246-316-040, filed 12/23/91, effective 1/23/92. Statutory Authority: RCW 43.70.040. 91-02-049 (Order 121), recodified as § 246-316-040, filed 12/27/90, effective 1/31/91. Statutory Authority: RCW 18.20.090. 89-09-034 (Order 2786), § 248-16-036, filed 4/14/89.]

**WAC 246-316-045 Criminal history, disclosure, and background inquiries.** (1) The licensee or license applicant shall require a disclosure statement as defined in RCW 43.43.834 for each prospective employee, volunteer, contractor, student, and any other individual associated with the boarding home having direct contact with vulnerable adults as defined under RCW 43.43.830.

(2) The license applicant having direct contact with vulnerable adults shall obtain a Washington state patrol criminal history background disclosure statement and submit it to the department either:

(a) With the initial application for licensure; or

(b) For current licensees, with the first application for renewal of license submitted after September 1, 1993.

(3) The licensee or license applicant shall:

(a) Require a Washington state patrol criminal history background inquiry, as specified in RCW 43.43.842(1), from the Washington state patrol or the department of social and health services for each:

(i) Staff person, student, and any other individual currently associated with the boarding home, having direct contact with vulnerable adults, when engaged on or since July 22, 1989; and

(ii) Prospective staff person, student, and individual applying for association with the boarding home prior to allowing the individual direct contact with vulnerable adults, except as allowed by subsection (4) of this section;

(b) Inform each individual identified in (a) of this subsection of the requirement for a background inquiry;

(c) Require the individual to sign an acknowledgement statement that a background inquiry will be made;

(d) Verbally inform the individual of the background inquiry results within seventy-two hours of receipt; and

(e) Offer to provide a copy of the background inquiry results to the individual within ten days of receipt.

(4) The licensee may conditionally employ, contract with, accept as a volunteer or associate, an individual having direct contact with vulnerable adults pending a background inquiry, provided the licensee:

(a) Immediately obtains a disclosure statement from the individual; and

(b) Requests a background inquiry within three business days of the conditional acceptance of the individual.

(5) Except as provided in RCW 43.43.842 and in subsection (4) of this section, a licensee shall not hire or retain, directly or by contract, any individual having direct contact with vulnerable adults, if that individual has been:

(a) Convicted of a crime against individuals as defined in RCW 43.43.830;

(b) Convicted of a crime relating to financial exploitation as defined in RCW 43.43.830;

(c) Found in any disciplinary board final decision to have abused a vulnerable adult under RCW 43.43.830; or

(d) The subject in a protective proceeding under chapter 74.34 RCW.

(6) The licensee shall establish and implement procedures ensuring that all disclosure statements and background inquiry responses are:

(a) Maintained in a confidential and secure manner;

(b) Used for employment purposes only;

(c) Not disclosed to any individual except:

(i) The individual about whom the licensee made the disclosure or background inquiry;

(ii) Authorized state and federal employees; and

(iii) The Washington state patrol auditor; and

(d) Retained and available for department review:

(i) During the individual's employment or association with a facility; and

(ii) At least two years following termination of employment or association with a facility.

(7) The department shall:

(a) Review records required under this section;

(b) Investigate allegations of noncompliance with RCW 43.43.830 through 43.43.842, when necessary, in consultation with law enforcement personnel; and

(c) Use information collected under this section solely for the purpose of determining eligibility for licensure or relicensure as required under RCW 43.43.842.

(8) The department may require licensees to complete additional disclosure statements or background inquiries for an individual associated with the licensed boarding home having direct contact with vulnerable adults if the department has reason to believe that offenses specified under RCW 43.43.830 have occurred since completion of the previous disclosure statement or background inquiry.

[Statutory Authority: RCW 18.20.090. 94-13-180, § 246-316-045, filed 6/21/94, effective 7/22/94. Statutory Authority: RCW 43.43.830 through 43.43.842. 93-16-030 (Order 381), § 246-316-045, filed 7/26/93, effective 8/26/93.]

**WAC 246-316-050 Staff.** (1) The licensee shall:

(a) Develop and maintain written job descriptions for the administrator and each staff position;

(b) Verify work references;

(c) Verify required credentialing is current and in good standing for licensed and certified staff;

(d) Document and retain weekly staffing schedules, as planned and worked, for the last twelve months;

(e) Provide sufficient, trained staff in each boarding home to:

(i) Furnish the services and care needed by residents;

(ii) Maintain the boarding home free of safety hazards; and

(iii) Implement fire and disaster plans;

(f) Assure one or more resident-care staff eighteen years of age or older, with current cardiopulmonary resuscitation and first-aid cards, is present to assist residents at all times:

(i) On the boarding home premises when one or more residents are present;

(ii) Off the boarding home premises during boarding home activities; and

(iii) When staff transport a resident;

(g) Assure staff provide "on-premises" supervision when any resident is working for, or employed by, the boarding home; and

(h) Provide staff orientation and appropriate training for expected duties, including:

(i) Organization of boarding home;

(ii) Physical boarding home layout;

(iii) Specific duties and responsibilities; and

(iv) Policies, procedures, and equipment necessary to perform duties.

(2) The licensee shall, in addition to following WISHA requirements, protect residents from tuberculosis by requiring each staff person to have, upon employment:

(a) A tuberculin skin test by the Mantoux method, unless the staff person:

(i) Documents a previous positive Mantoux skin test, which is ten or more millimeters of induration read at forty-eight to seventy-two hours;

(ii) Documents meeting the requirements of this subsection within the six months preceding the date of employment; or

(iii) Provides a written waiver from the department or authorized local health department stating the Mantoux skin test presents a hazard to the staff person's health;

(b) A second test one to three weeks after a negative Mantoux skin test for staff thirty-five years of age or older;

(c) A chest x-ray within seven days of any positive Mantoux skin test.

(3) The licensee shall report positive chest x-rays to the appropriate public health authority, and follow precautions ordered by a physician or public health authority.

(4) The licensee shall retain records of tuberculin test results, reports of x-ray findings, exceptions, physician or public health official orders, and waivers in the boarding home.

(5) The licensee shall assure that all resident-care staff including those transporting residents and supervising resident activities, except licensed staff whose professional training exceeds first-responder training, have within thirty days of employment:

(a) Current cardiopulmonary resuscitation cards from instructors certified by:

(i) American Red Cross;

(ii) American Heart Association;

(iii) United States Bureau of Mines; or

(iv) Washington state department of labor and industries; and

(b) Current first-aid cards from instructors certified as in (a) of this subsection, except nurses do not need first-aid cards.

(6) The licensee shall restrict a staff person's contact with residents when the staff person has a known communicable disease in the infectious stage which is likely to be spread in the boarding home setting or by casual contact.

(7) The licensee shall assure any staff person suspected or accused of abuse does not have access to any resident until the licensee investigates and takes action to assure resident safety to the satisfaction of the department.

(8) The licensee shall not interfere with the investigation of a complaint, coerce a resident, or conceal evidence of alleged improprieties occurring within the boarding home.

(9) The licensee shall prohibit an employee from being directly employed by a resident or a resident's family during the hours the employee is working for the boarding home.

(10) The licensee shall maintain the following documentation on the boarding home premises, during employment, and at least two years following termination of employment:

(a) Staff orientation and training pertinent to duties, including cardiopulmonary resuscitation, first-aid, tuberculin skin testing and HIV/AIDS training;

(b) Criminal history disclosure and background checks as required in WAC 246-316-045; and

(c) Verification of contacting work references and professional licensing and certification boards as required by subsection (1) of this section.

[Statutory Authority: RCW 18.20.090. 94-13-180, § 246-316-050, filed 6/21/94, effective 7/22/94. Statutory Authority: RCW 43.43.830 through 43.43.842. 93-16-030 (Order 381), § 246-316-050, filed 7/26/93, effective 8/26/93. Statutory Authority: RCW 43.70.040. 91-02-049 (Order 121), recodified as § 246-316-050, filed 12/27/90, effective 1/31/91. Statutory Authority: RCW 18.20.090. 89-09-034 (Order 2786), § 248-16-046, filed 4/14/89.]

**WAC 246-316-055 Policies and procedures.** (1) The licensee shall establish and observe the following written policies and procedures, consistent with this chapter and services provided:

(a) Accepting and retaining residents, including specific policies, if any, for accepting or retaining residents needing state income assistance;

(b) Anti-discrimination;

(c) Limited nursing services consistent with WAC 246-316-265;

(d) Health care services arranged by a resident under the provisions of WAC 246-316-268, specifying the types of services allowed in the boarding home, and who has the responsibility for each aspect of the resident's care;

(e) Infection control, including:

(i) Cleaning and disinfecting toilets, bathing fixtures, floors, furniture, and common areas;

(ii) Cleaning resident rooms and furnishings;

(iii) Handwashing;

(iv) Managing staff and residents with communicable disease;

(v) Reporting communicable diseases in accordance with the requirements in chapter 246-100 WAC;

(vi) Handling and storing supplies and equipment used for resident services;

(vii) Infectious waste disposal;

(viii) Bloodborne pathogens in accordance with chapter 296-62 WAC; and

(ix) Laundry and handling of soiled and clean linens;

(f) Supervising and monitoring residents;

(g) Managing aggressive, assaultive residents, including but not limited to:

(i) Controlling violent residents; and

(ii) When and how to seek outside intervention;

(h) Food services, including but not limited to:

(i) Food service sanitation;

(ii) Procuring and storing food;

(iii) Meal times;

(iv) Modified diets;

(v) Food preparation;

(vi) Nutrient supplements; and

(vii) Food and meal substitution;

(i) Maintaining resident records and register;

(j) Medication services for each service category offered in the boarding home;

(k) Boarding home safety;

(l) Adult day care;

(m) Care of residents with dementia, delineating special services required;

(n) Emergency medical care and first-aid, including:

(i) Major emergencies;

(ii) Minor emergencies; and

(iii) Staff actions upon finding a resident not responsive to appropriate stimuli;

(o) Death of a resident;

(p) Suspected abuse, neglect, or exploitation including but not limited to:

(i) Reporting requirements according to chapters 26.44 and 74.34 RCW;

(ii) Responsibility of staff to immediately contact the department directly regarding suspected or alleged abuse or other improprieties, without retaliation from the licensee or administrator;

(iii) Protocol to protect residents according to WAC 246-316-050(7); and

(iv) Additional steps to take in the event of suspected rape or sexual abuse, including:

(A) Immediate medical examination of the alleged victim, with prior notice to the examining physician that the patient may have been raped or sexually abused;

(B) Arranging for a counselor or other professional knowledgeable in the field of rape and sexual assault to question or interview the resident, and provide counseling or intervention, when appropriate; and

(C) Allowing only staff with special training in the field of rape and sexual assault to question the victim or the suspected perpetrator regarding the alleged incident, unless the department, police or prosecutor's office instructs otherwise;

(q) Protecting residents and maintaining living accommodations during internal and external disasters, such as fires, explosions, earthquakes, flooding, hazardous environmental contamination, and other events that jeopardize the safety of residents, describing:

(i) On-duty staff responsibilities;

(ii) Provisions for summoning emergency assistance;

(iii) Plans for evacuating residents from area or building;

(iv) Alternative resident accommodations;

(v) Provisions for essential resident needs, supplies and equipment; and

(vi) Emergency communication plan;

(r) Advance directives as described in chapter 70.122 RCW, Natural Death Act;

(s) Resident's temporary absence from the boarding home;

(t) Confidentiality of resident information;

(u) Criminal history background checks in accordance with WAC 246-316-045;

(v) Resident trust funds; and

(w) Smoking, including means to protect nonsmokers.

(2) The licensee shall make the policies and procedures specified in subsection (1) of this section available to staff at all times and residents and residents' representatives upon request.

[Statutory Authority: RCW 18.20.090, 94-13-180, § 246-316-055, filed 6/21/94, effective 7/22/94.]

**WAC 246-316-060 HIV/AIDS education and training.** The licensee shall:

(1) Verify or arrange appropriate education and training of staff within thirty days of employment on the prevention, transmission, and treatment of human immunodeficiency virus (HIV) and acquired immunodeficiency syndrome (AIDS) consistent with RCW 70.24.310; and

(2) Use infection control standards and educational material consistent with:

(a) The approved curriculum manual *KNOW - HIV/AIDS Prevention Education for Health Care Facility Employees*, January 1991, or subsequent editions published by the department; and

(b) WAC 296-62-08001, Bloodborne pathogens implementing WISHA.

[Statutory Authority: RCW 18.20.090, 94-13-180, § 246-316-060, filed 6/21/94, effective 7/22/94. Statutory Authority: RCW 43.70.040, 91-02-049 (Order 121), recodified as § 246-316-060, filed 12/27/90, effective 1/31/91. Statutory Authority: RCW 70.24.310, 89-21-038 (Order 3), § 248-16-048, filed 10/12/89, effective 11/12/89.]

**WAC 246-316-070 Construction.** (1) The licensee shall comply with chapter 31 of the Washington State Building Code for all construction.

(2) Prior to starting new construction, the licensee shall submit the following documentation to the department:

(a) A completed application form, a copy of which is provided in the *Submissions Guide for Health and Residential Facility Construction Projects*, which may be obtained from the department;

(b) The fee as specified in chapter 246-314 WAC;

(c) A functional program which describes the services and operational methods affecting the boarding home building, premises, and residents;

(d) One set of preliminary documents including, when applicable:

(i) Plot plans drawn to scale showing:

(A) Streets, driveways, parking, vehicle and pedestrian circulation;

(B) Site utilities, water service system, sewage disposal system, electrical service system, elevations; and

(C) Location of existing and new buildings and other fixed equipment;

(ii) Building plans drawn to scale showing:

(A) Floor plans designating function of each room and fixed equipment;

(B) Typical building sections and exterior elevations;

(iii) Outline specifications generally describing the construction and materials including mechanical and electrical systems; and

(e) Three sets of final construction drawings, stamped by a Washington state licensed architect or engineer, complying with the requirements of this chapter including, when applicable:

(i) Plot plans drawn to scale showing all items required in the preliminary plan in final form;

(ii) Building plans drawn to scale showing:

(A) Floor plans designating function of each room and fixed equipment;

(B) Interior and exterior elevations;

(C) Building sections and construction details;

(D) Schedules of room finishes, doors, finish hardware and windows;

(E) Mechanical, including plumbing, heating, venting and air conditioning; and

(F) Electrical, including lighting, power, and communication systems; and

(iii) Specifications fully describing the workmanship and finishes;

(f) Three copies of specifications, radiant panel and smoke density test reports for each carpet type used in corridors and exitways;

(g) Three copies of fire sprinkler system shop drawings, hydraulic calculations and equipment specifications, stamped by the fire sprinkler contractor; and

(h) Three copies of fire alarm system shop drawings and equipment specifications.

(3) The licensee shall:

(a) Obtain department approval of final construction documents prior to starting construction;

(b) Conform with the approved plans during construction;

(c) Consult with the department prior to deviating from approved documents;

(d) Provide a written construction project completion notice to the department indicating:

(i) The expected completion date; and

(ii) Compliance with the approved construction documents, requirements of chapter 18.20 RCW and this chapter;

(e) Make adequate provisions for the health, safety and comfort of residents during construction projects;

(f) Obtain authorization from the department prior to occupying or using new construction; and

(g) Obtain approval of the Washington state fire protection services division prior to new construction, modification, and alteration consistent with RCW 18.20.130.

[Statutory Authority: RCW 18.20.090, 94-13-180, § 246-316-070, filed 6/21/94, effective 7/22/94; 92-02-018 (Order 224), § 246-316-070, filed 12/23/91, effective 1/23/92. Statutory Authority: RCW 43.70.040, 91-02-049 (Order 121), recodified as § 246-316-070, filed 12/27/90, effective 1/31/91. Statutory Authority: RCW 18.20.090, 89-09-034 (Order 2786), § 248-16-057, filed 4/14/89.]

**WAC 246-316-080 Communication system.** (1) The licensee shall provide one or more nonpay telephones:

(a) In each building located for ready access by staff; and

(b) On the premises for reasonable access and privacy by residents.

(2) By January 1, 1995, a licensee with a boarding home exceeding four thousand square feet total floor area, more than one building, or more than one floor shall have a means for staff and residents to communicate by voice or call system, which may be wired or wireless, from all common areas and corridors to on-duty staff in an emergency.

(3) The licensee shall have a mechanism in the room of, and easily accessible to, each resident whose medical or physical condition does not enable the resident to otherwise summon staff for assistance.

[Statutory Authority: RCW 18.20.090. 94-13-180, § 246-316-080, filed 6/21/94, effective 7/22/94. Statutory Authority: RCW 43.70.040. 91-02-049 (Order 121), recodified as § 246-316-080, filed 12/27/90, effective 1/31/91. Statutory Authority: RCW 18.20.090. 89-09-034 (Order 2786), § 248-16-060, filed 4/14/89; 83-13-068 (Order 264), § 248-16-060, filed 6/16/83; Order 147, § 248-16-060, filed 6/29/77; Regulation .16.060, effective 3/11/60.]

**WAC 246-316-090 Water supply.** The licensee shall:

(1) Provide water meeting the provisions of chapter 246-290 WAC;

(2) Maintain the boarding home water systems free of cross-connections;

(3) Provide hot and cold water under adequate pressure readily available throughout the boarding home;

(4) Provide all sinks and bathing fixtures used by residents with hot water between one hundred five and one hundred twenty degrees Fahrenheit at all times;

(5) Label or color code nonpotable water supplies "unsafe for domestic use"; and

(6) Meet laundry and dishwashing water temperature requirements of this chapter.

[Statutory Authority: RCW 18.20.090. 94-13-180, § 246-316-090, filed 6/21/94, effective 7/22/94; 92-02-018 (Order 224), § 246-316-090, filed 12/23/91, effective 1/23/92. Statutory Authority: RCW 43.70.040. 91-02-049 (Order 121), recodified as § 246-316-090, filed 12/27/90, effective 1/31/91. Statutory Authority: RCW 18.20.090. 89-09-034 (Order 2786), § 248-16-070, filed 4/14/89; 83-13-068 (Order 264), § 248-16-070, filed 6/16/83; Order 147, § 248-16-070, filed 6/29/77; Regulation .16.070, effective 3/11/60.]

**WAC 246-316-100 Sewage and liquid waste disposal.** The licensee shall:

(1) Ensure all sewage and waste water drain into a municipal sewage disposal system if available; or

(2) Provide on-site sewage disposal systems designed, constructed, and maintained as required by chapter 246-272 WAC, chapter 173-240 WAC, and local ordinances.

[Statutory Authority: RCW 18.20.090. 94-13-180, § 246-316-100, filed 6/21/94, effective 7/22/94; 92-02-018 (Order 224), § 246-316-100, filed 12/23/91, effective 1/23/92. Statutory Authority: RCW 43.70.040. 91-02-049 (Order 121), recodified as § 246-316-100, filed 12/27/90, effective 1/31/91. Statutory Authority: RCW 18.20.090. 89-09-034 (Order 2786), § 248-16-080, filed 4/14/89; Order 147, § 248-16-080, filed 6/29/77; Regulation .16.080, effective 3/11/60.]

**WAC 246-316-110 Garbage and refuse disposal.** The licensee shall:

(1) Provide an adequate number of garbage containers to store refuse generated by the boarding home:

(a) Located in a storage area convenient for resident and staff use;

(b) Constructed of nonabsorbent material;

(c) Cleaned and maintained to prevent:

(i) Entrance of insects, rodents, birds, or other pests;

(ii) Odors; and

(iii) Other nuisances;

(2) Provide only noncombustible waste containers in common use areas;

(3) Assure garbage and waste containers are emptied frequently to prevent hazards and nuisances;

(4) Use safe and sanitary garbage collection and disposal practices; and

(5) Use appropriate containers and collection/disposal services if infectious wastes are generated.

[Statutory Authority: RCW 18.20.090. 94-13-180, § 246-316-110, filed 6/21/94, effective 7/22/94. Statutory Authority: RCW 43.70.040. 91-02-049 (Order 121), recodified as § 246-316-110, filed 12/27/90, effective 1/31/91. Statutory Authority: RCW 18.20.090. 89-09-034 (Order 2786), § 248-16-090, filed 4/14/89; 83-13-068 (Order 264), § 248-16-090, filed 6/16/83; Order 147, § 248-16-090, filed 6/29/77; Regulation .16.090, effective 3/11/60.]

**WAC 246-316-120 Lighting.** The licensee shall maintain electric light fixtures and lighting necessary for the comfort and safety of residents, with minimum intensities of:

(1) Five foot-candles of light measured thirty inches from the floor in all areas;

(2) Thirty foot-candles of light measured at reading, work, and recreation surfaces in any room or area used by residents for reading, work, or recreation; and

(3) Ten foot-candles of light measured thirty inches from the floor in toilet rooms and bathrooms.

[Statutory Authority: RCW 18.20.090. 94-13-180, § 246-316-120, filed 6/21/94, effective 7/22/94. Statutory Authority: RCW 43.70.040. 91-02-049 (Order 121), recodified as § 246-316-120, filed 12/27/90, effective 1/31/91. Statutory Authority: RCW 18.20.090. 89-09-034 (Order 2786), § 248-16-105, filed 4/14/89; 83-13-068 (Order 264), § 248-16-105, filed 6/16/83.]

**WAC 246-316-130 Heating—Temperature.** The licensee shall:

(1) Equip each resident-occupied building with an approved heating system which maintains a minimum temperature of:

(a) Sixty degrees Fahrenheit during sleeping hours; and

(b) Sixty-eight degrees Fahrenheit during waking hours, except when:

(i) A room is designated for activities requiring physical exertion; or

(ii) Residents can control temperature in their own units, independent from other areas;

(2) Equip each resident-occupied building with a mechanical air cooling system or equivalent in communities where the design dry bulb temperature exceeds eighty-five degrees Fahrenheit for one hundred seventy-five hours per year or two percent of the time, as specified in the latest edition of *Recommended Outdoor Design Temperatures—Washington State*, published by Puget Sound chapter of *American Society of Heating, Refrigeration, and Air-Conditioning Engineers*; and

(3) Prohibit the use of portable space heaters unless approved in writing by the Washington state director of fire protection.

[Statutory Authority: RCW 18.20.090. 94-13-180, § 246-316-130, filed 6/21/94, effective 7/22/94. Statutory Authority: RCW 43.70.040. 91-02-049 (Order 121), recodified as § 246-316-130, filed 12/27/90, effective 1/31/91. Statutory Authority: RCW 18.20.090. 89-09-034 (Order 2786), § 248-16-110, filed 4/14/89; 83-13-068 (Order 264), § 248-16-110, filed 6/16/83; Order 147, § 248-16-110, filed 6/29/77; Regulation .16.110, effective 3/11/60.]

**WAC 246-316-140 Ventilation.** The licensee shall:

- (1) Ventilate rooms to:
  - (a) Provide adequate air circulation without drafts;
  - (b) Prevent excessive odors or moisture; and
  - (c) Remove smoke;
- (2) Designate and ventilate smoking areas, if smoking is permitted in the boarding home, to prevent air contamination throughout the boarding home;
- (3) Provide sixteen mesh screens on operable windows and openings used for ventilation; and
- (4) Prohibit screens that may restrict or hinder escape or rescue through emergency exit openings.

[Statutory Authority: RCW 18.20.090. 94-13-180, § 246-316-140, filed 6/21/94, effective 7/22/94. Statutory Authority: RCW 43.70.040. 91-02-049 (Order 121), recodified as § 246-316-140, filed 12/27/90, effective 1/31/91. Statutory Authority: RCW 18.20.090. 89-09-034 (Order 2786), § 248-16-115, filed 4/14/89; 83-13-068 (Order 264), § 248-16-115, filed 6/16/83.]

**WAC 246-316-150 Resident room—Room furnishings—Storage.** (1) The licensee shall provide each resident sleeping room or area, except as permitted in subsection (3) of this section, with:

- (a) Eighty or more square feet of usable floor space in a one-person room or area;
- (b) Seventy or more square feet of usable floor space per individual in a room occupied by two or more individuals;
- (c) A minimum ceiling height of seven feet six inches over all square footage considered usable floor space;
- (d) A maximum room occupancy of:
  - (i) Four individuals if the boarding home was licensed before July 1, 1989, and licensed continuously thereafter; and
  - (ii) Two individuals if the boarding home applied for initial licensure or to increase the number of resident sleeping rooms after June 30, 1989;
- (e) Room identification and resident capacity consistent with the licensed room list;
- (f) Unrestricted direct access to a hallway, living room, outside, or other common-use area;
- (g) One or more outside windows with:
  - (i) A total clear glass area equal to at least one-tenth of the room area;
  - (ii) Minimum area of ten square feet;
  - (iii) Window sills no more than three feet eight inches from the floor; and
  - (iv) Window sills at or above grade, with grade extending horizontally ten or more feet from the building;
  - (v) Easy operation if necessary for fire exit or ventilation; and
  - (vi) Adjustable curtains, shades, blinds, or equivalent for visual privacy;
- (h) One or more duplex electrical outlets per bed if the boarding home was initially licensed after July 1, 1983;
- (i) A light control switch located by the entrance for a light fixture in the room;
- (j) Lighting at bedside when requested by a resident;
- (k) One or more noncombustible waste containers, and no combustible waste containers;
- (l) An individual towel and washcloth rack or equivalent;

(m) When requested by the resident, a lockable drawer, cupboard or other secure space measuring at least one-half cubic foot with a minimum dimension of four inches;

(n) Storage facilities in or immediately adjacent to the resident's sleeping room to adequately store a reasonable quantity of clothing and personal possessions;

(o) A comfortable bed, thirty-six or more inches wide, appropriate for size, age and physical condition of the resident and room dimensions, including but not limited to:

- (i) Standard household bed;
- (ii) Studio couch;
- (iii) Hide-a-bed;
- (iv) Day bed; or
- (v) Water bed, if structurally and electrically safe;
- (p) A bed mattress which:
  - (i) Fits the bed frame;
  - (ii) Is in good condition; and
  - (iii) Is at least four inches thick unless otherwise requested or necessary for resident health or safety;
- (q) Beds spaced at least three feet from other beds unless otherwise requested by all affected residents;
- (r) One or more comfortable pillows;
- (s) Bedding, in good repair, changed weekly or more often as necessary to maintain cleanliness;
- (t) Clean towels and washcloths provided weekly or more often as necessary to maintain cleanliness; and
- (u) A sturdy, comfortable chair, appropriate for the age and physical condition of the resident.

(2) The licensee shall not allow the use of a resident room for a passageway or corridor.

(3) The licensee may, upon a resident's request, permit the resident to use personal furniture and furnishings when such usage does not jeopardize the health and safety of any resident.

(4) The licensee shall:

- (a) Document the functional ability of each resident to use cooking facilities safely; and
- (b) Limit access to cooking facilities by any resident deemed by the licensee unable to cook safely.

(5) The licensee may use or allow use of carpets and other floor coverings when:

- (a) Securely fastened to the floor or provided with nonskid backing; and
- (b) Kept clean and free of hazards such as curling edges or tattered sections.

(6) The licensee shall, prior to the purchase and installation of carpeting, submit samples to the department for approval in accordance with WAC 246-316-070.

[Statutory Authority: RCW 18.20.090. 94-13-180, § 246-316-150, filed 6/21/94, effective 7/22/94; 92-02-018 (Order 224), § 246-316-150, filed 12/23/91, effective 1/23/92. Statutory Authority: RCW 43.70.040. 91-02-049 (Order 121), recodified as § 246-316-150, filed 12/27/90, effective 1/31/91. Statutory Authority: RCW 18.20.090. 89-09-034 (Order 2786), § 248-16-121, filed 4/14/89.]

**WAC 246-316-160 Toilet rooms and bathrooms.**

(1) The licensee shall provide private or common-use toilet rooms and bathrooms meeting the needs of residents.

(2) The licensee shall provide each toilet room and bathroom with:

- (a) Water resistant, smooth, low gloss, nonslip and easily cleanable materials;

(b) Washable walls to the height of splash or spray;  
 (c) Grab bars installed and located to minimize accidental falls including one or more grab bars at each:

(i) Bathing fixture; and

(ii) Toilet, if needed by residents;

(d) Plumbing fixtures designed for easy cleaning and kept in good repair; and

(e) Adequate ventilation to outside.

(3) Provide each toilet room with a:

(a) Toilet with a clean, nonabsorbent seat free of cracks;

(b) Handwashing sink in or adjacent to the toilet room;

(c) Suitable mirror with adequate lighting for general illumination.

(4) For boarding homes approved for construction or initially licensed after August 1, 1994, the licensee shall provide a toilet and handwashing sink in, or adjoining, each bathroom.

(5) The licensee providing common-use toilet rooms and bathrooms shall:

(a) Provide a minimum of one toilet and one handwashing sink for each eight individuals or fraction thereof, with two or more toilets contained in a single bathroom counted as one toilet;

(b) Provide a minimum of one bathing fixture for every twelve individuals or fraction thereof;

(c) Designate toilet rooms containing more than one toilet for use by one sex at a time;

(d) Designate bathrooms containing more than one bathing fixture for use by one sex at a time;

(e) Provide a handwashing sink with soap and single use or disposable towels, blower or equivalent hand-drying device in each toilet room;

(f) Provide reasonable access to bathrooms and toilet rooms for each resident by:

(i) Locating a toilet room on the same floor or level as the sleeping room of the resident served;

(ii) Locating a bathroom on the same floor or level, or adjacent floor or level, as the sleeping room of the resident served; and

(iii) Providing access without passage through any kitchen, pantry, food preparation, food storage, or dishwashing area, or from one bedroom through another bedroom.

[Statutory Authority: RCW 18.20.090. 94-13-180, § 246-316-160, filed 6/21/94, effective 7/22/94. Statutory Authority: RCW 43.70.040. 91-02-049 (Order 121), recodified as § 246-316-160, filed 12/27/90, effective 1/31/91. Statutory Authority: RCW 18.20.090. 89-09-034 (Order 2786), § 248-16-131, filed 4/14/89.]

#### **WAC 246-316-170 Food and nutrition services.** (1)

The licensee shall maintain food service facilities on site in compliance with chapter 246-215 WAC, food service sanitation, except the licensee may:

(a) Serve home-canned jams, jellies and fruit with a pH of less than 4.6; and

(b) In boarding homes licensed for sixteen or fewer beds, use domestic or home-type kitchen appliances including mechanical dishwashers, provided the licensee:

(i) Operates appliances according to manufacturer directions; and

(ii) Uses water heated to one hundred fifty-five degrees Fahrenheit or more in dishwashers.

(2) The licensee shall:

(a) Provide a minimum of three meals a day at regular intervals, with fourteen or fewer hours between the evening meal and breakfast, unless the licensee provides a nutritious snack between the evening meal and breakfast;

(b) Provide sufficient time for residents to consume meals; and

(c) Ensure all menus:

(i) Are written at least one week in advance;

(ii) Indicate the date, day of week, month and year;

(iii) Include all food and snacks served that contribute to nutritional requirements;

(iv) Are retained at least six months;

(v) Provide a variety of foods; and

(vi) Are not repeated for at least three weeks;

(d) Prepare palatable, attractively served meals and nourishments that meet the current recommended dietary allowances of the National Research Council, 1989, adjusted for:

(i) Age, sex and activities, unless medically contraindicated; and

(ii) Individual and ethnic preferences to the extent reasonably possible;

(e) Substitute foods, when necessary, of comparable nutrient value and record changes on the menu; and

(f) Maintain a dining area approved by the department with a seating capacity for fifty percent or more of the residents per meal setting.

(3) The licensee shall prepare and serve:

(a) Resident specific, modified, or therapeutic diets when and as prescribed by a health care practitioner using a dietitian-approved menu or diet manual; and

(b) Nutrient concentrates and supplements only when prescribed in writing by a health care practitioner.

[Statutory Authority: RCW 18.20.090. 94-13-180, § 246-316-170, filed 6/21/94, effective 7/22/94; 92-02-018 (Order 224), § 246-316-170, filed 12/23/91, effective 1/23/92. Statutory Authority: RCW 43.70.040. 91-02-049 (Order 121), recodified as § 246-316-170, filed 12/27/90, effective 1/31/91. Statutory Authority: RCW 18.20.090. 89-09-034 (Order 2786), § 248-16-141, filed 4/14/89.]

**WAC 246-316-180 Day rooms.** (1) The licensee shall provide one or more day room areas for residents to participate in social and recreational activities. Day room areas include, but are not limited to:

(a) Solariums;

(b) Enclosed sun porches;

(c) Recreation rooms;

(d) Dining rooms; and

(e) Living rooms.

(2) The licensee shall provide a total minimum floor space for day room areas of:

(a) One hundred fifty square feet, or ten square feet per resident, whichever is larger, in boarding homes licensed on or before December 31, 1988; or

(b) One hundred fifty square feet, or twenty square feet per resident, whichever is larger, in boarding homes licensed after December 31, 1988.

(3) The licensee shall provide day room areas with comfortable furniture and furnishings meeting resident needs.

[Statutory Authority: RCW 18.20.090. 94-13-180, § 246-316-180, filed 6/21/94, effective 7/22/94. Statutory Authority: RCW 43.70.040. 91-02-



049 (Order 121), recodified as § 246-316-180, filed 12/27/90, effective 1/31/91. Statutory Authority: RCW 18.20.090, 89-09-034 (Order 2786), § 248-16-150, filed 4/14/89; 83-13-068 (Order 264), § 248-16-150, filed 6/16/83; Order 147, § 248-16-150, filed 6/29/77; § 248-16-150, filed 10/3/67; Emergency Regulation, filed 8/4/67; Regulation .16.150, effective 3/11/60.]

**WAC 246-316-190 Laundry.** (1) The licensee shall provide laundry and linen services on the premises or by commercial laundry and appropriate handling, cleaning, and storage of linen and washable goods.

(2) A licensee washing boarding home laundry and residents' laundry in a single load or more than one resident's laundry in a single load, shall provide, maintain and equip a laundry room with:

(a) Washing machines with hot water intake temperature of one hundred forty degrees Fahrenheit for each load; and

(b) A means of separating clean and soiled items.

(3) A licensee or resident washing a resident's personal laundry, separate from other laundry, may wash at temperatures below one hundred forty degrees Fahrenheit.

(4) The licensee shall ventilate, to the outside, laundry rooms and areas.

(5) The licensee shall locate laundry equipment in rooms other than those used for open food storage, food preparation or food service.

[Statutory Authority: RCW 18.20.090, 94-13-180, § 246-316-190, filed 6/21/94, effective 7/22/94. Statutory Authority: RCW 43.70.040, 91-02-049 (Order 121), recodified as § 246-316-190, filed 12/27/90, effective 1/31/91. Statutory Authority: RCW 18.20.090, 89-09-034 (Order 2786), § 248-16-160, filed 4/14/89; 83-13-068 (Order 264), § 248-16-160, filed 6/16/83; Regulation .16.160, effective 3/11/60.]

**WAC 246-316-200 Storage space.** The licensee shall:

(1) Provide adequate storage space for supplies, equipment and linens;

(2) Provide separate, locked storage for disinfectants and poisonous compounds to prevent access by residents; and

(3) Maintain storage space to prevent fire or safety hazards.

[Statutory Authority: RCW 18.20.090, 94-13-180, § 246-316-200, filed 6/21/94, effective 7/22/94; 92-02-018 (Order 224), § 246-316-200, filed 12/23/91, effective 1/23/92. Statutory Authority: RCW 43.70.040, 91-02-049 (Order 121), recodified as § 246-316-200, filed 12/27/90, effective 1/31/91. Statutory Authority: RCW 18.20.090, 89-09-034 (Order 2786), § 248-16-170, filed 4/14/89; 83-13-068 (Order 264), § 248-16-170, filed 6/16/83; Regulation .16.170, effective 3/11/60.]

**WAC 246-316-210 Stairs—Ramps.** The licensee shall:

(1) Maintain nonskid surfaces on all stairways and ramps used by residents; and

(2) Construct and maintain stairs and ramps in compliance with current Washington State Building Code requirements.

[Statutory Authority: RCW 18.20.090, 94-13-180, § 246-316-210, filed 6/21/94, effective 7/22/94. Statutory Authority: RCW 43.70.040, 91-02-049 (Order 121), recodified as § 246-316-210, filed 12/27/90, effective 1/31/91. Statutory Authority: RCW 18.20.090, 89-09-034 (Order 2786), § 248-16-180, filed 4/14/89; 83-13-068 (Order 264), § 248-16-180, filed 6/16/83; Regulation .16.180, effective 3/11/60.]

**WAC 246-316-220 Guardrails—Handrails.** (1) The licensee shall install and maintain sturdy handrails according to Washington State Building Code requirements, located:

(a) In halls and corridors if necessary for resident safety;

(b) On each side of interior and exterior stairways with more than one step riser, unless the department approves in writing having a handrail on one side only; and

(c) On each side of interior and exterior ramps with slopes greater than one to twenty.

(2) The licensee shall install guardrails if the department determines guardrails are necessary for resident safety.

[Statutory Authority: RCW 18.20.090, 94-13-180, § 246-316-220, filed 6/21/94, effective 7/22/94. Statutory Authority: RCW 43.70.040, 91-02-049 (Order 121), recodified as § 246-316-220, filed 12/27/90, effective 1/31/91. Statutory Authority: RCW 18.20.090, 89-09-034 (Order 2786), § 248-16-190, filed 4/14/89; 83-13-068 (Order 264), § 248-16-190, filed 6/16/83; Regulation .16.190, effective 3/11/60.]

**WAC 246-316-230 Maintenance and housekeeping.** The licensee shall:

(1) Provide a safe, sanitary and well maintained environment for residents;

(2) Keep exterior grounds, boarding home structure, and component parts safe, sanitary and in good repair;

(3) Keep facilities, equipment and furnishings clean and in good repair;

(4) Assure each resident or staff person maintains the resident's quarters in a safe and sanitary condition;

(5) Equip a housekeeping supply area with:

(a) A utility sink or equivalent means of obtaining and disposing of mop water away from food preparation and service areas;

(b) Storage for wet mops, ventilated to outside air; and

(c) Locked storage for cleaning supplies.

[Statutory Authority: RCW 18.20.090, 94-13-180, § 246-316-230, filed 6/21/94, effective 7/22/94. Statutory Authority: RCW 43.70.040, 91-02-049 (Order 121), recodified as § 246-316-230, filed 12/27/90, effective 1/31/91. Statutory Authority: RCW 18.20.090, 89-09-034 (Order 2786), § 248-16-202, filed 4/14/89; 83-13-068 (Order 264), § 248-16-202, filed 6/16/83; Order 147, § 248-16-202, filed 6/29/77.]

**WAC 246-316-240 Criteria for accepting and retaining residents.** (1) The licensee shall evaluate the ability of staff and facilities to meet a prospective resident's housing, domiciliary, dementia, and nursing care needs, based on:

(a) Space, equipment and furniture requirements;

(b) General behavior including the tendency to wander, fall, act verbally or physically abusive or socially inappropriate;

(c) Current medication status and need for assistance in obtaining or administering medications;

(d) Height, weight and age;

(e) Functional abilities, including but not limited to:

(i) Ambulatory status and need for mobility aides;

(ii) Mental status and behavioral problems;

(iii) Ability to perform activities of daily living independently or with assistance; and

(iv) Conditions requiring staff monitoring or care of the resident.

(2) If the licensee accepts residents requiring limited nursing services, in addition to the information specified in subsection (1) of this section, the licensee shall consider:

- (a) Medical diagnosis;
- (b) Blood pressure;
- (c) Any chewing, swallowing, mouth and dental problems and treatments;
- (d) Any infections, skin rashes, ulcers and open lesion problems and treatments;
- (e) Appetite and hydration status;
- (f) Need for chemotherapy, radiation and dialysis; and
- (g) Any urethral catheter use and type.

(3) The licensee shall accept and retain an individual as a resident only when:

(a) The individual is ambulatory unless the boarding home is approved by the Washington state director of fire protection to care for semi-ambulatory or nonambulatory residents;

(b) The individual does not need medical or nursing care exceeding that allowed by WAC 246-316-265 and 246-316-268;

(c) A nonsmoking individual can be accommodated with a smoke-free room and smoke-free common-use areas;

(d) A smoking individual can be accommodated by areas meeting the requirements in WAC 246-316-140(2);

(e) The individual can be accommodated by:

(i) The physical plant, facilities and spaces;

(ii) Furniture and equipment;

(iii) Staff who are available and sufficient to provide the type of domiciliary care required and desired by the individual; and

(iv) Staff who are available and sufficient to provide limited nursing services, as required by the individual, if the boarding home provides such services;

(f) The appropriate medication service type pursuant to RCW 18.20.160 and WAC 246-316-300 is available in the boarding home; and

(g) The individual meets the acceptance criteria defined in the boarding home policies and procedures.

(4) The licensee shall not accept or retain individuals:

(a) Exhibiting continuing overt acts which present a risk of harming self or others, including but not limited to self-mutilation, suicide attempts, and hitting or striking out at others;

(b) Having major areas of skin breakdown and open wounds; or

(c) Whose needs can only be met by inpatient care in a hospital, nursing home, or other facility licensed under chapter 18.51, 71.12, or 70.41 RCW; and

(5) Upon admitting a resident, the licensee shall document in the resident's health record, the resident's choice regarding:

(a) Definite arrangements with a health care practitioner; and

(b) The identity of individuals to contact in case of an emergency, illness or death.

[Statutory Authority: RCW 18.20.090. 94-13-180, § 246-316-240, filed 6/21/94, effective 7/22/94; 94-01-058, § 246-316-240, filed 12/8/93, effective 1/8/94; 92-02-018 (Order 224), § 246-316-240, filed 12/23/91, effective 1/23/92. Statutory Authority: RCW 43.70.040. 91-02-049 (Order 121), recodified as § 246-316-240, filed 12/27/90, effective 1/31/91. Statutory Authority: RCW 18.20.090. 89-09-034 (Order 2786), § 248-16-

213, filed 4/14/89; 83-13-068 (Order 264), § 248-16-213, filed 6/16/83; Order 147, § 248-16-213, filed 6/29/77.]

**WAC 246-316-250 Resident rights.** The licensee shall comply with chapter 214, Laws of 1994, long-term care facilities—resident rights.

[Statutory Authority: RCW 18.20.090. 94-13-180, § 246-316-250, filed 6/21/94, effective 7/22/94. Statutory Authority: RCW 43.70.040. 91-02-049 (Order 121), recodified as § 246-316-250, filed 12/27/90, effective 1/31/91. Statutory Authority: RCW 18.20.090. 89-09-034 (Order 2786), § 248-16-215, filed 4/14/89; 83-13-068 (Order 264), § 248-16-215, filed 6/16/83; Order 147, § 248-16-215, filed 6/29/77; Order 116, § 248-16-215, filed 5/23/75; § 248-16-215, filed 10/3/67; Emergency Regulation, filed 8/4/67.]

**WAC 246-316-260 Resident services.** (1) The licensee shall:

(a) Prepare a brief individual's resident plan upon admission, and a comprehensive individual's resident plan within thirty days of admission;

(b) Monitor and document any significant changes in a resident's physical, mental, or emotional functioning, as necessary, and review and document the resident's physical, mental and emotional functioning at least semi-annually;

(c) Ensure staff, who observe a change in a resident's functioning, immediately describe and document the change; and

(d) Take appropriate action when changes are noted which would alter the individual's resident plan.

(2) The licensee shall provide basic domiciliary care, including:

(a) Assisting each resident to attain and maintain the highest functional ability possible; and

(b) Providing general health supervision and assistance with:

(i) Self-administering prescribed drugs and treatments;

(ii) Following any prescribed modified diet, rest or activity regimen;

(iii) Making and keeping appointments for health care services;

(iv) Arranging health care when necessary;

(v) Maintaining personal hygiene, including bathing, oral care, dressing, grooming, and changing to clean clothing;

(vi) Obtaining and maintaining functional aids and equipment, including but not limited to glasses, hearing aids, dentures, canes, crutches, walkers and wheelchairs;

(vii) Keeping clothing and other personal effects clean and in good repair;

(viii) Maintaining safe and comfortable personal living quarters;

(ix) Arranging for social, recreational, religious, or other activities in the boarding home and the community;

(x) Resident mobility; and

(xi) Incontinence care.

(3) The licensee shall provide planned social and recreational activities for residents at least three times per week and post a calendar of daily activities and events.

[Statutory Authority: RCW 18.20.090. 94-13-180, § 246-316-260, filed 6/21/94, effective 7/22/94; 94-01-058, § 246-316-260, filed 12/8/93, effective 1/8/94. Statutory Authority: RCW 43.70.040. 91-02-049 (Order 121), recodified as § 246-316-260, filed 12/27/90, effective 1/31/91. Statutory Authority: RCW 18.20.090. 89-09-034 (Order 2786), § 248-16-216, filed 4/14/89.]

**WAC 246-316-265 Limited nursing services.** This section applies only to licensees who choose to provide limited nursing services. This section does not apply when residents care for themselves or arrange for independent nursing or health care services pursuant to WAC 246-316-268.

(1) The licensee shall employ or contract directly or indirectly with a RN or physician to:

(a) Provide or supervise limited nursing services;

(b) Assess, or supervise a LPN's assessment of each resident needing limited nursing services upon admittance, and develop the nursing component of the individual's resident plan;

(c) Reassess, or supervise a LPN's reassessment of the resident's nursing needs when staff notice a change in the resident's functional ability or health status, and amend the nursing component of the individual's resident plan accordingly; and

(d) Be available in person, by pager, or by telephone during hours of limited nursing services.

(2) A licensee shall ensure the following services are only provided by a RN, or a LPN under the supervision of a RN:

(a) Insertion of urethral catheters, including indwelling;

(b) Any other nursing service requested by the licensee and approved in writing by the department.

(3) The licensee may allow unlicensed staff to provide the following services under the delegation and supervision of a RN:

(a) Routine ostomy care that is well-established, with no breakdown or maintenance care;

(b) Enema;

(c) Uncomplicated routine colostomy and urethral care when the resident is unable to supervise these activities;

(d) Care of wounds that are superficial without drainage or infection; and

(e) Assistance with glucometer testing if the resident can perform the finger stick.

(4) The licensee shall not provide the following nursing services on the premises:

(a) Respiratory ventilation;

(b) Intravenous procedures;

(c) Suctioning;

(d) Feeding tube insertion or site maintenance; and

(e) Care of residents who are bed-bound for more than fourteen consecutive days as a result of a medical condition.

(5) A licensee providing limited nursing services shall assure that employed or contracted nursing services are consistent with chapters 18.78 and 18.88 RCW.

(6) A licensee providing limited nursing services shall provide for safe and sanitary:

(a) Storage and handling of clean and sterile nursing equipment and supplies;

(b) Storage and handling of soiled laundry and linens;

(c) Cleaning and disinfecting soiled equipment; and

(d) Refuse and infectious waste disposal.

(7) In new construction designed for limited nursing services, or upon starting a limited nursing services program within an existing boarding home, the licensee shall provide the following, accessible only by staff:

(a) A clean utility area for the purposes of storing and preparing clean and sterile nursing supplies, equipped with:

(i) A work counter or table; and

(ii) Adjacent handwashing sink, with soap and paper towels or other approved hand-drying device; and

(b) A soiled utility area for the purposes of storing soiled linen, cleaning and disinfecting soiled nursing care equipment, and disposing of refuse and infectious waste, equipped with:

(i) A work counter or table;

(ii) Sinks for handwashing and cleaning/sanitizing, with soap and paper towels or other approved hand-drying device.

[Statutory Authority: RCW 18.20.090. 94-13-180, § 246-316-265, filed 6/21/94, effective 7/22/94.]

**WAC 246-316-268 Health care services—Resident-arranged.** (1) The licensee shall allow a resident to arrange for on-site health care services, consistent with Title 18 RCW regulating health care professions, and the policies and procedures of the boarding home except as specified in subsection (2) of this section.

(2) Only when the resident resides in lockable quarters with a private toilet, handwashing sink, bathing fixture, refrigerator, and emergency power if necessary for life-support equipment, shall the licensee allow the following nursing services on-site:

(a) Respiratory ventilation;

(b) Intravenous procedures;

(c) Suctioning;

(d) Feeding tube insertion or site maintenance; and

(e) Care of residents who are bed-bound for more than fourteen consecutive days as a result of a medical condition.

[Statutory Authority: RCW 18.20.090. 94-13-180, § 246-316-268, filed 6/21/94, effective 7/22/94.]

**WAC 246-316-280 Notification—Change in resident's condition.** The licensee shall:

(1) Notify a resident's next of kin, guardian, or other individual or agency responsible for, or designated by, the resident as soon as possible regarding:

(a) A serious or significant change in the resident's condition;

(b) The relocation of the resident to a hospital or other health care facility; or

(c) Death of the resident.

(2) In case of death, notify the coroner if required by RCW 68.50.010.

(3) Document in the resident's health record, the date and time individuals were notified, and the relationship of those individuals to the resident.

[Statutory Authority: RCW 18.20.090. 94-13-180, § 246-316-280, filed 6/21/94, effective 7/22/94. Statutory Authority: RCW 43.70.040. 91-02-049 (Order 121), recodified as § 246-316-280, filed 12/27/90, effective 1/31/91. Statutory Authority: RCW 18.20.090. 89-09-034 (Order 2786), § 248-16-223, filed 4/14/89; 83-13-068 (Order 264), § 248-16-223, filed 6/16/83; Order 147, § 248-16-223, filed 6/29/77.]

**WAC 246-316-290 Safety measures and quality assurance.** (1) The licensee shall:

(a) Maintain the premises free of hazards;

(b) Investigate and prepare an incident report for any neglect, abuse, exploitation, accident, or incident jeopardizing or affecting a resident's health or life to:

- (i) Determine the circumstances of the event; and
- (ii) Institute and document appropriate measures to prevent similar future situations;
- (c) Provide appropriate hardware on doors of storage rooms, closets and other rooms to prevent residents from being accidentally locked in;
- (d) Provide and advise staff of a means of emergency access to resident-occupied bedrooms, toilets, showers, bathrooms, and other rooms;
- (e) Sanitize, handle and store resident-care supplies and equipment to prevent the transmission of infection;
- (f) Provide emergency lighting or flashlights in all areas of the boarding home;
- (g) Maintain a first-aid kit and manual which are:
  - (i) Equivalent to that required by the department of labor and industries in WAC 296-24-065;
  - (ii) Readily available to all staff and residents;
- (h) Develop and maintain a current disaster plan describing measures to take in the event of internal or external disasters; and
  - (i) Ensure residents are safe and warm during inclement weather and catastrophic events.
  - (2) The licensee may develop and implement a coordinated quality improvement program approved by the department according to RCW 43.70.510 and chapter 246-50 WAC.

[Statutory Authority: RCW 18.20.090, 94-13-180, § 246-316-290, filed 6/21/94, effective 7/22/94. Statutory Authority: RCW 43.70.040, 91-02-049 (Order 121), recodified as § 246-316-290, filed 12/27/90, effective 1/31/91. Statutory Authority: RCW 18.20.090, 89-09-034 (Order 2786), § 248-16-226, filed 4/14/89; 83-13-068 (Order 264), § 248-16-226, filed 6/16/83; Order 147, § 248-16-226, filed 6/29/77.]

**WAC 246-316-300 Medication services.** (1) The licensee shall:

- (a) Determine the medication service category or categories, specified in this section, best suited to the needs of each resident by:
  - (i) Consulting with the physician, family, and caregivers; and
  - (ii) Considering the resident's abilities, preferences, health and safety;
- (b) Document the medication service category assigned to each resident in the resident's health record; and
- (c) Reevaluate the resident's medication service category upon any change in the resident's condition, and if necessary:
  - (i) Reassign the resident a new medication service category; or
  - (ii) When the appropriate medication service category is unavailable in the boarding home, transfer the resident to a setting where the appropriate medication service can be provided.
- (2) The licensee shall assign a resident to medication service category A when the licensee determines the resident can safely and securely store medications, and:
  - (a) Can fully understand the appropriate use of the medication and can self-administer the medication according to the prescribed dosage, time and any special instructions; or
  - (b) Cannot physically self-administer the medication, but can accurately direct others to assist with:

- (i) Opening the container; and
- (ii) Applying or instilling oral, skin, nose, eye, and ear preparations.
- (3) The licensee shall assign a resident to category B when the licensee determines that the resident needs reminding, guiding or coaching limited to:
  - (a) Opening a container;
  - (b) Reading the label or prescriber's order, and explaining it in a manner to assure proper self-administration; and
  - (c) Assistance with applying or instilling skin, nose, eye, and ear preparations consistent with Washington state law.
- (4) The licensee providing medication service category B shall:
  - (a) Store medications in a manner prohibiting access by other residents; and
  - (b) Document the medication name, time and dosage taken by the resident; and
  - (c) Document a resident's refusal or inability to take medication according to the prescription.
- (5) A licensee shall assign a resident to category C when:
  - (a) The licensee determines a resident cannot safely self-administer medication or accurately self-perform a glucometer test; and
  - (b) A physician orders medication to be administered by a nurse or other individual authorized to administer medications by Washington state law.
- (6) A licensee providing medication service category C shall:
  - (a) Assure the service is planned, directed and supervised by a RN or physician who:
    - (i) Documents a review of each resident's condition and medication regimen quarterly, or more often as needed;
    - (ii) Provides training for all medication administration staff and documents training in staff records; and
    - (iii) Observes, evaluates and documents each staff person administering medication annually, or more often as necessary, to assure medications are administered according to the resident's needs;
  - (b) Document the medication name, time and dosage administered to the resident;
  - (c) Document a resident's refusal or inability to take medication according to the prescription;
  - (d) Assure medications and glucometer tests are administered by nurses or other individuals authorized to administer medications and glucometer tests by Washington state law; and
  - (e) Provide an area for storing, handling, and preparing medications consistent with board of pharmacy requirements, including a sink, table or counter space, and secure storage.
- (7) The licensee shall assure staff follow the written policies and procedures for each medication service category provided in the boarding home including:
  - (a) Limitations of staff assistance;
  - (b) Requirements for staff providing assistance with medications;
  - (c) Storing resident medications:
    - (i) In original containers with pharmacist-prepared or manufacturer's label;
    - (ii) Together for each resident and physically separated from other residents' medications;
    - (iii) Separate from food or toxic chemicals;

(iv) Accessible only to designated responsible staff or appropriate resident; and

(v) In environments recommended on the medication label;

(d) Assuring the resident obtains medication as prescribed;

(e) Documenting and recording current prescriber's order for any medications managed and controlled by the licensee under categories B and C;

(f) Managing medications administered in medication service category B and C in accordance with the pharmacist's recommendations including:

(i) Disposing of outdated, contaminated, damaged, or discontinued medications, and medications left behind when a resident leaves or dies;

(ii) Documenting date, method, signature of person who disposed of medication and person who witnessed the disposal;

(iii) Maintaining prescribers' orders to discontinue medications; and

(iv) Sending the resident's medication with the resident when moving out or leaving temporarily; and

(g) Retaining completed medication records for five years after the resident moves from the boarding home.

[Statutory Authority: RCW 18.20.090. 94-13-180, § 246-316-300, filed 6/21/94, effective 7/22/94. Statutory Authority: RCW 43.70.040. 91-02-049 (Order 121), recodified as § 246-316-300, filed 12/27/90, effective 1/31/91. Statutory Authority: RCW 18.20.090. 89-09-034 (Order 2786), § 248-16-229, filed 4/14/89.]

**WAC 246-316-310 Resident register.** The licensee shall maintain a readily available permanent, current book, computer file, or register, with entries in ink or typewritten, of all residents including:

- (1) Date of moving in;
- (2) Full name;
- (3) Date of birth;
- (4) Date of moving out;
- (5) Reason for moving out; and
- (6) New address if known.

[Statutory Authority: RCW 18.20.090. 94-13-180, § 246-316-310, filed 6/21/94, effective 7/22/94. Statutory Authority: RCW 43.70.040. 91-02-049 (Order 121), recodified as § 246-316-310, filed 12/27/90, effective 1/31/91. Statutory Authority: RCW 18.20.090. 89-09-034 (Order 2786), § 248-16-230, filed 4/14/89; 83-13-068 (Order 264), § 248-16-230, filed 6/16/83; Order 147, § 248-16-230, filed 6/29/77; Order 116, § 248-16-230, filed 5/23/75; § 248-16-230, filed 10/3/67; Emergency Regulation, filed 8/4/67; Regulation .16.230, effective 3/11/60; Subsection 1, filed 5/31/61.]

**WAC 246-316-320 Resident health record.** (1) The licensee shall maintain a health record with entries in ink, typewritten or equivalent, for each resident including:

- (a) Full name, date of birth, and former address of resident;
- (b) Date of moving in and moving out;
- (c) The name, address, and telephone number of individuals to contact in case of an emergency, illness or death;
- (d) Resident's representative, if any;
- (e) Name, address, and telephone number of resident's personal physician or health care practitioner;

(f) Resident admitting information, including any medical diagnoses pertinent to care services needed by the resident and provided by the boarding home;

(g) Documented staff entries about:

(i) Dates and descriptions of the resident's illnesses, accidents, and incidents;

(ii) Changes in the resident's physical, mental, emotional and social abilities to cope with the affairs and activities of daily living, physical and mental coordination; and

(iii) Actions of staff related to (g)(i) and (ii) of this subsection;

(h) Orders documented by the resident's health care practitioner for any modified diet, concentrate or supplement provided by the boarding home;

(i) Medication orders and records as specified in WAC 246-316-300;

(j) Clinical information such as weight, temperature, blood pressure, blood sugar and other laboratory tests that are ordered or required by the individual's resident plan;

(k) Advance notice for relocation as specified in chapter 214, Laws of 1994, long-term care facilities—resident rights;

(l) Notice of relocation as specified in WAC 246-316-280; and

(m) Proof of resident's receipt of the list of resident rights and rules and regulations governing resident conduct and responsibilities as required by chapter 214, Laws of 1994, long-term care facilities—resident rights.

(2) The licensee shall:

(a) Maintain a systematic and secure method of identifying and filing resident health records for easy access;

(b) Allow authorized representatives of the department and other authorized regulatory agencies access to resident records;

(c) Provide any individual or organization access to resident records upon written consent of the resident or the resident's representative, unless state or federal law provide for broader access;

(d) Maintain resident records and health care information for residents receiving category B or C medication services or limited nursing services in accordance with chapter 70.02 RCW; and

(e) Retain each resident health record at least five years after the resident moves from the boarding home.

[Statutory Authority: RCW 18.20.090. 94-13-180, § 246-316-320, filed 6/21/94, effective 7/22/94; 92-02-018 (Order 224), § 246-316-320, filed 12/23/91, effective 1/23/92. Statutory Authority: RCW 43.70.040. 91-02-049 (Order 121), recodified as § 246-316-320, filed 12/27/90, effective 1/31/91. Statutory Authority: RCW 18.20.090. 89-09-034 (Order 2786), § 248-16-235, filed 4/14/89; 83-13-068 (Order 264), § 248-16-235, filed 6/16/83.]

**WAC 246-316-330 Adult day care.** A licensee approved by the department to provide adult day care services for less than a contiguous twenty-four-hour period shall:

(1) Accept only those adults meeting the resident criteria in WAC 246-316-240;

(2) Provide dining room and day room facilities according to WAC 246-316-170 and 246-316-180;

(3) Provide toilets and handwashing sinks according to WAC 246-316-160;

(4) Provide sufficient furniture for the comfort of day care adults, in addition to furniture provided for residents, including:

(a) Sturdy comfortable chairs, appropriate for the age and physical condition of the day care adults; and

(b) Napping furniture such as lounge chairs, recliners, or couches which are placed three or more feet apart if needed or requested;

(5) Provide staff to supervise and assist day care adults in activities of daily living, limited nursing services and medication services as described in WAC 246-316-260, 246-316-265 and 246-316-300;

(6) Provide a meal, which meets at least one-third of the recommended dietary allowance described in WAC 246-316-170(2), during every five-hour period of stay or no more than fourteen hours between the evening meal and breakfast;

(7) Ensure rights according to WAC 246-316-250;

(8) Provide services, notification, and safety as described in WAC 246-316-260, 246-316-265, 246-316-280, and 246-316-290;

(9) Maintain a separate register of all day care adults using the format described in WAC 246-316-310; and

(10) Maintain a health record for each day care adult as described for residents in WAC 246-316-320.

[Statutory Authority: RCW 18.20.090. 94-13-180, § 246-316-330, filed 6/21/94, effective 7/22/94; 92-02-018 (Order 224), § 246-316-330, filed 12/23/91, effective 1/23/92. Statutory Authority: RCW 43.70.040. 91-02-049 (Order 121), recodified as § 246-316-330, filed 12/27/90, effective 1/31/91. Statutory Authority: RCW 18.20.090. 89-09-034 (Order 2786), § 248-16-300, filed 4/14/89.]

**WAC 246-316-335 Residents—Dementia care.** (1) If a licensee accepts residents with dementia care needs, the licensee shall:

(a) Provide qualified staff, present at all times, to care for and supervise residents with dementia care needs including:

(i) Dressing, grooming and personal hygiene;

(ii) Eating;

(iii) Orientation and activities;

(iv) Ensuring the safety of all residents; and

(v) Assisting residents during an emergency; and

(b) Take one or more of the following measures to prevent wandering from the boarding home:

(i) Staff sufficient to monitor and care for residents with dementia care needs;

(ii) An alarm and monitoring system to alert staff when a resident exits the building or enclosed outdoor area; or

(iii) A dementia care unit meeting the standards described in subsection (2) of this section.

(2) A licensee providing a dementia care unit shall, except as provided in subsection (4) of this section:

(a) Assure the dementia care unit meets the fire and life safety requirements for boarding homes according to the Washington State Building Code;

(b) Provide a room which may be used for dining, socializing and recreation;

(c) Design floor and wall surfaces in such a way to augment resident orientation;

(d) Provide slip-resistant floors free of abrupt changes;

(e) Provide access to a secured outdoor space with:

(i) Walls or fences at least seventy-two inches high;

(ii) Walking surfaces that are firm, stable, slip-resistant and free from abrupt changes;

(iii) Outdoor furniture; and

(iv) Nontoxic plants;

(f) Provide an approved supervised automatic fire detection system and supervised automatic sprinkler system electrically interconnected with the fire alarm system;

(g) If exiting doors restrict egress, provide automatic locking and unlocking exiting doors from the dementia care unit, which:

(i) Release automatically when:

(A) The fire alarm is activated;

(B) Primary power to the building is lost; and

(C) An override switch is used in case of emergency;

(ii) Are equipped with alarms;

(iii) Have directions for lock releasing devices posted by doors and accessible to residents; and

(iv) Are approved for use by the local official enforcing the Uniform Building Code and the Uniform Fire Code prior to approval by the Washington state director of fire protection.

(3) A licensee shall obtain written consent from a resident, or if the resident is unable to give informed consent as defined in RCW 11.88.010 (1)(e), from an individual as set forth in RCW 7.70.065, prior to placing the resident in a dementia care unit.

(4) A licensee using a dementia care unit as of August 1, 1994, shall:

(a) Assure the unit is designed and maintained for safe and adequate care of residents; and

(b) Meet the requirements in subsection (2) of this section upon construction of a new dementia care unit or January 1, 2000, whichever occurs first.

[Statutory Authority: RCW 18.20.090. 94-13-180, § 246-316-335, filed 6/21/94, effective 7/22/94.]

**WAC 246-316-340 Exemptions.** (1) The department may exempt the licensee from meeting a specific requirement in this chapter if the department determines the exemption will not jeopardize the health or safety of residents.

(2) A licensee wishing to request an exemption shall submit a written request to the department, including:

(a) A description of the requested exemption;

(b) Reason for the exemption; and

(c) Impact of the exemption on resident health and safety.

(3) The licensee shall retain a copy of each approved exemption in the boarding home.

[Statutory Authority: RCW 18.20.090. 94-13-180, § 246-316-340, filed 6/21/94, effective 7/22/94. Statutory Authority: RCW 43.70.040. 91-02-049 (Order 121), recodified as § 246-316-340, filed 12/27/90, effective 1/31/91. Statutory Authority: RCW 18.20.090. 89-09-034 (Order 2786), § 248-16-900, filed 4/14/89. Statutory Authority: 1985 c 213. 86-08-002 (Order 2348), § 248-16-900, filed 3/20/86; Order 147, § 248-16-900, filed 6/29/77.]

**WAC 246-316-990 Fees.** The licensee or applicant shall:

(1) Submit an annual license fee of thirty-seven dollars and thirty-five cents per bed of the licensed resident bed capacity for initial and renewed licenses;

(2) Submit an additional one hundred fifty dollars when billed by the department for:

(a) A third on-site visit resulting from failure of the licensee or applicant to adequately respond to a statement of deficiencies; and

(b) A complete on-site survey resulting from a substantiated complaint; and

(3) Submit an additional late fee in the amount of ten dollars per day from the license renewal date until the date of mailing the fee, as evidenced by the postmark.

[Statutory Authority: RCW 18.20.050, 43.70.110 and 43.70.250. 96-12-027, § 246-316-990, filed 5/30/96, effective 6/30/96. Statutory Authority: RCW 43.70.250, 43.70.110 and 43.20B.020. 95-12-097, § 246-316-990, filed 6/7/95, effective 7/8/95. Statutory Authority: RCW 43.70.110 and 43.70.250. 94-13-180, § 246-316-990, filed 6/21/94, effective 7/22/94. Statutory Authority: RCW 43.70.250. 92-12-086 (Order 276), § 246-316-990, filed 6/2/92, effective 7/1/92. Statutory Authority: RCW 43.70.040. 91-02-050 (Order 122), § 246-316-990, filed 12/27/90, effective 1/31/91.]

## Chapter 246-318 WAC HOSPITALS

### WAC

246-318-010	Definitions.
246-318-013	License expiration dates—Notice of decision—Adjudicative proceeding.
246-318-015	Exemptions and interpretations.
246-318-017	Single license to cover two or more buildings—When permissible.
246-318-018	Hospital license to cover attached nursing home building—When permissible.
246-318-020	Approval of plans.
246-318-025	Required approval for occupancy after completion of new construction.
246-318-030	Governing body and administration.
246-318-033	Medical staff.
246-318-035	Infection control program.
246-318-040	Personnel.
246-318-042	Criminal history, disclosure, and background inquiries.
246-318-050	Water supply.
246-318-060	Plumbing.
246-318-070	Staff facilities.
246-318-080	Storage.
246-318-090	Heating.
246-318-100	Lighting and wiring.
246-318-110	Emergency light and power.
246-318-120	Ventilation.
246-318-130	Corridors and doors.
246-318-135	Carpets.
246-318-140	Stairways, ramps, and elevators.
246-318-150	Maintenance.
246-318-155	Housekeeping.
246-318-160	Laundry.
246-318-170	Sewage, garbage, and waste.
246-318-180	Dietary and/or food service.
246-318-190	Patient care services, general.
246-318-200	Abuse reports—Children and developmentally disabled adults.
246-318-210	Pediatric services.
246-318-220	Obstetrical services.
246-318-230	Intermediate care nursery service—Neonatal intensive care nursery service.
246-318-240	Critical care service.
246-318-250	Renal dialysis services.
246-318-260	Long-term care services.
246-318-270	Alcoholism and/or substance abuse unit.
246-318-280	Psychiatric units and services.
246-318-290	Surgery—Operating rooms and areas—Special procedure rooms—Surgical treatment or diagnostic areas.
246-318-300	Anesthesia services.

[Title 246 WAC—page 586]

246-318-310	Post-anesthesia recovery areas.
246-318-320	Processing and sterilizing services.
246-318-330	Use of medical gases, combustible anesthetics.
246-318-340	Nonflammable medical gases.
246-318-350	Emergency care services.
246-318-360	Diagnostic and treatment facilities, outpatient services.
246-318-370	Laboratory.
246-318-380	Diagnostic and therapeutic radiology and other imaging services.
246-318-390	Physical and occupational therapy services.
246-318-400	Respiratory care services.
246-318-410	Other services.
246-318-420	Hospital pharmacy.
246-318-430	Intravenous preparation.
246-318-435	Intravenous administration.
246-318-440	Records and reports—Medical record system.
246-318-450	Discharge planning.

### NEW CONSTRUCTION REGULATIONS

246-318-500	Applicability of WAC 246-318-500 through 246-318-99902.
246-318-501	Legal authority of the department.
246-318-510	Programs, drawings and construction.
246-318-520	Design and construction standards, general.
246-318-530	Site and site development.
246-318-540	General design requirements.
246-318-550	General requirements for support facilities.
246-318-560	Maintenance and mechanical facilities.
246-318-570	Administrative facilities.
246-318-580	Receiving, storage and distribution facilities.
246-318-590	Central sterilizing and processing service facilities.
246-318-600	Environmental services facilities.
246-318-610	Laundry facilities.
246-318-620	Dietary facilities.
246-318-630	Laboratory and pathology facilities.
246-318-640	Pharmacy.
246-318-650	Radiology and other imaging facilities.
246-318-660	Nuclear medicine facilities.
246-318-670	Electrocardiography facilities.
246-318-680	Electroencephalography facilities.
246-318-690	Nursing unit.
246-318-700	Pediatric nursing unit.
246-318-710	Emergency facilities.
246-318-720	Surgery suite.
246-318-730	Recovery/post anesthesia care unit (PACU).
246-318-740	Critical care facilities.
246-318-750	Facilities for care of patients in labor.
246-318-760	Obstetrical delivery facilities.
246-318-770	Birthing rooms.
246-318-780	Obstetrical recovery unit.
246-318-790	Newborn nursery facilities.
246-318-800	Intermediate care nursery and neonatal intensive care nursery.
246-318-810	Alcoholism and substance abuse nursing unit.
246-318-820	Psychiatric facilities.
246-318-830	Rehabilitation facilities.
246-318-840	Outpatient care facilities.
246-318-850	Special procedure facilities.
246-318-860	Dialysis facilities.
246-318-870	Long-term care unit.
246-318-990	Fees.
246-318-99902	Appendix B—Dates of documents adopted by reference in chapter 246-318 WAC.
246-318-99910	Appendix J—Guidelines for laboratory quality assurance program in hospitals.

### DISPOSITION OF SECTIONS FORMERLY CODIFIED IN THIS CHAPTER

246-318-799	Infant formula facilities. [Statutory Authority: RCW 43.70.040. 91-02-049 (Order 121), recodified as § 246-318-799, filed 12/27/90, effective 1/31/91. Statutory Authority: Chapter 70.41 RCW. 90-12-014 (Order 061), § 248-18-640, filed 5/30/90, effective 6/30/90. Statutory Authority: RCW 70.41.030 and 43.20.050. 83-19-058
-------------	---



(Order 269), § 248-18-640, filed 9/20/83; Order 119, § 248-18-640, filed 5/23/75; Regulation 18.620, filed 1/25/62.] Repealed by 93-07-011 (Order 338), filed 3/5/93, effective 4/5/93. Statutory Authority: RCW 70.41.030.

**WAC 246-318-010 Definitions.** For the purposes of this chapter and chapter 70.41 RCW, the following words and phrases shall have the following meanings unless the context clearly indicates otherwise. All adjectives and adverbs such as adequate, approved, suitable, properly, or sufficient used in these regulations to qualify a requirement shall be determined by the department.

(1) "Abuse" means the injury or sexual abuse of a patient under circumstances indicating the health, welfare, and safety of the patient is harmed. Person "legally responsible" shall include a parent, guardian, or an individual to whom parental or guardian responsibility is delegated (e.g., teachers, providers of residential care and treatment, and providers of day care):

(a) "Physical abuse" means damaging or potentially damaging nonaccidental acts or incidents which may result in bodily injury or death.

(b) "Emotional abuse" means verbal behavior, harassment, or other actions which may result in emotional or behavioral problems, physical manifestations, disordered or delayed development.

(2) "Accredited" means approved by the joint commission on accreditation of hospitals or the bureau of hospitals of the American Osteopathic Association.

(3) "Adolescent" means an individual during that period of life beginning with the appearance of secondary sex characteristics and ending with the cessation of somatic growth.

(4) "Agent," when used in a reference to a medical order or a procedure for a treatment, means any power, principle, or substance, whether physical, chemical, or biological, capable of producing an effect upon the human body.

(5) "Alterations":

(a) "Alterations" means changes requiring construction in existing hospitals.

(b) "Minor alterations" means any physical or functional modification within existing hospitals not changing the approved use of the room or area. (Minor alterations performed under this definition do not require prior review of the department as specified in WAC 246-318-510 (3)(a); however, this does not constitute a release from other applicable requirements.)

(6) "Area" means a portion of a room containing the equipment essential to carrying out a particular function and separated from other facilities of the room by a physical barrier or adequate space, except when used in reference to a major section of the hospital.

(7) "Authenticate" means to authorize or validate an entry in a record by:

(a) A signature including first initial, last name, and discipline; or

(b) A unique identifier allowing identification of the responsible individual.

(8) "Bathing facility" means a bathtub or shower and does not include sitz baths or other fixtures designated primarily for therapy.

(9) "Birthing room" or "labor, delivery, recovery (LDR) room" or "labor-delivery-recovery-postpartum (LDRP) room" means a room designed and equipped to provide care of a woman, fetus, and newborn and to accommodate her support persons during the complete process of vaginal childbirth.

(10) "Children" means young persons of either sex between infancy and adolescence.

(11) "Clean" means space or spaces and/or equipment for storage and handling of supplies and/or equipment which are in a sanitary or sterile condition, when the word is used in reference to a room, area, or facility.

(12) "Critical care" means a special physical and functional nursing unit for the segregation, concentration, and close or continuous observation and care of patients critically, acutely, or seriously ill and in need of intensive, highly skilled services.

(13) "Department" means the Washington state department of health.

(14) "Dentist" means an individual licensed under chapter 18.32 RCW.

(15) "Diagnostic radiologic technician" means an individual:

(a) Certified or eligible for certification as a diagnostic radiologic technologist under chapter 18.84 RCW; or

(b) Trained by a radiologist and approved by a radiologist member of medical staff to perform specified diagnostic radiologic procedures.

(16) "Dialysis facility" means a separate physical and functional nursing unit of the hospital serving patients receiving renal dialysis.

(17) "Dialysis station" means an area designed, equipped, and staffed to provide dialysis services for one patient.

(18) "Dietitian" means an individual meeting the eligibility requirements for active membership in the American Dietetic Association described in *Directory of Dietetic Programs Accredited and Approved*, American Dietetic Association, edition 100, 1980.

(19) "Double-checking" means verification of patient identity, agent to be administered, route, quantity, rate, time, and interval of administration by two persons legally qualified to administer prior to administration of the agent.

(20) "Drug administration" means an act in which a single dose of a prescribed drug or biological is given to a patient by an authorized person in accordance with all laws and regulations governing such acts. The complete act of administration entails:

(a) Removing an individual dose from a previously dispensed, properly labeled container (including a unit dose container);

(b) Reviewing the label on the container with a verified transcription, a direct copy or the original medical practitioner's orders;

(c) Giving the individual dose to the proper patient; and

(d) Properly recording the time and dose given.

(21) "Drug dispensing" means an act entailing the interpretation of an order for a drug or biological and, pursuant to that order, proper selection, measuring, labeling,

packaging, and issuance of the drug for a patient or for a service unit of the facility.

(22) "Easily cleanable" means of material or finish and so fabricated to allow complete removal of residue by normal cleaning methods.

(23) "Electrical receptacle outlet" means an outlet where one or more electrical receptacles are installed.

(24) "Facilities" means a room or area and equipment serving a specific function.

(25) "Faucet controls" means wrist, knee, or foot control of the water supply:

(a) "Wrist control" means water supply controls not exceeding four and one-half inches overall horizontal length designed and installed to be operated by the wrists;

(b) "Knee control" means the water supply is controlled through a mixing valve designed and installed to be operated by the knee;

(c) "Foot control" means the water supply control is through a mixing valve designed and installed to be operated by the foot.

(26) "Governing body" means the person or persons responsible for establishing the purposes and policies of the hospital.

(27) "Grade" means the level of the ground adjacent to the building measured at required windows. The ground must be level or slope downward for a distance of at least ten feet from the wall of the building. From there the ground may slope upward not greater than an average of one foot vertical to two feet horizontal within a distance of eighteen feet from the building.

(28) "He, him, his, or himself" means a person of either sex, male, or female, and does not mean preference for nor exclude reference to either sex.

(29) "High-risk infant" means an infant, regardless of gestational age or birth weight, whose extrauterine existence is compromised by a number of factors, prenatal, natal, or postnatal needing special medical or nursing care.

(30) "Hospital" means any institution, place, building, or agency providing accommodations, facilities and services over a continuous period of twenty-four hours or more, for observation, diagnosis, or care of two or more individuals not related to the operator who are suffering from illness, injury, deformity, or abnormality, or from any other condition for which obstetrical, medical, or surgical services would be appropriate for care or diagnosis. "Hospital" as used in this chapter does not include:

(a) Hotels, or similar places furnishing only food and lodging, or simply domiciliary care;

(b) Clinics, or physicians' offices where patients are not regularly kept as bed patients for twenty-four hours or more;

(c) Nursing homes, as defined and which come within the scope of chapter 18.51 RCW;

(d) Maternity homes, which come within the scope of chapter 18.46 RCW;

(e) Psychiatric or alcoholism hospitals, which come within the scope of chapter 71.12 RCW; nor

(f) Any other hospital or institution specifically intended for use in the diagnosis and care of those suffering from mental illness, mental retardation, convulsive disorders, or other abnormal mental conditions.

(g) Furthermore, nothing in this chapter shall be construed as authorizing the supervision, regulation, or

control of the remedial care or treatment of residents or patients in any hospital conducted for those who rely primarily upon treatment by prayer or spiritual means in accordance with the creed or tenets of any well-recognized church or religious denominations.

(31) "Infant" means a baby or very young child up to one year of age.

(32) "Infant station" means a space for a bassinet, incubator, or equivalent, including support equipment used for the care of an individual infant.

(33) "Intermediate care nursery" means an area designed, organized, staffed, and equipped to provide constant care and treatment for mild to moderately ill infants not requiring neonatal intensive care, but requiring or may require physical support and treatment beyond support required for a normal neonate and may include the following:

(a) Electronic cardiorespiratory monitoring;

(b) Gavage feedings;

(c) Parenteral therapy for administration of drugs; and

(d) Respiratory therapy with intermittent mechanical ventilation not to exceed a continuous period of twenty-four hours for stabilization when trained staff are available.

(34) "Investigational drug" means any article not approved for use in the United States, but for which an investigational drug application (IND) is approved by the Food and Drug Administration.

(35) "Island tub" means a bathtub placed in a room to permit free movement of a stretcher, patient lift, or wheelchair to at least one side of the tub, and movement of people on both sides and at the end of the tub.

(36) "Lavatory" means a plumbing fixture of adequate design and size for washing hands.

(37) "Legend drugs" means any drugs required by state law or regulation of the state board of pharmacy to be dispensed on prescription only or are restricted to use by practitioners only.

(38) "Licensed practical nurse," abbreviated L.P.N., means an individual licensed under provisions of chapter 18.78 RCW.

(39) "May" means permissive or discretionary on the part of the board or the department.

(40) "Medical staff" means physicians and may include other practitioners appointed by the governing body to practice within the parameters of governing body and medical staff bylaws.

(41) "Movable equipment" means equipment not built-in, fixed, or attached to the building.

(42) "Neglect" means mistreatment or maltreatment; an act or omission evincing; a serious disregard of consequences of a magnitude constituting a clear and present danger to an individual patient's health, welfare, and safety.

(a) "Physical neglect" means physical or material deprivation (e.g., lack of medical care, lack of supervision necessary for patient level of development, inadequate food, clothing, or cleanliness).

(b) "Emotional neglect" means acts such as rejection, lack of stimulation, or other acts of commission or omission which may result in emotional or behavioral problems, physical manifestations, and disordered development.

(43) "Nuclear medicine technologist" means an individual certified or eligible for certification as a nuclear medicine technologist under chapter 18.84 RCW.

(44) "Neonate" or "newborn" means a newly born infant through the twenty-seventh day of life or under twenty-eight days of age.

(45) "Neonatal intensive care nursery" means an area designed, organized, equipped, and staffed to provide constant nursing and medical care and treatment for high-risk infants who may require:

(a) Continuous ventilatory support, twenty-four hours per day;

(b) Intravenous fluids or parenteral nutrition;

(c) Preoperative and postoperative monitoring when anesthetic other than local is administered; or

(d) Cardiopulmonary or other life support on a continuing basis.

(46) "Neonatologist" means a pediatrician who is board certified in neonatal-perinatal medicine or board eligible in neonatal-perinatal medicine, provided the period of eligibility does not exceed three years, as defined and described in *Directory of Residency Training Programs by the Accreditation Council for Graduate Medical Education*, American Medical Association, 1981-1982 or the *American Osteopathic Association Yearbook and Directory*, 1981-1982.

(47) "Newborn care" means provision of nursing and medical services described by the hospital and appropriate for well and convalescing infants including supportive care, ongoing physical assessment, and resuscitation.

(48) "New construction" means any of the following:

(a) New buildings to be used as hospitals;

(b) Additions to existing buildings to be used as hospitals;

(c) Conversion of existing buildings or portions thereof for use as hospitals;

(d) Alterations.

(49) "Nursing home unit" or "long-term care unit" means a group of beds for the accommodation of patients who, because of chronic illness or physical infirmities, require skilled nursing care and related medical services but are not acutely ill and not in need of the highly technical or specialized services ordinarily a part of hospital care.

(50) "Nursing unit, general" means a separate physical and functional unit of the hospital including a group of patient rooms, ancillary and administrative, and service facilities necessary to provide nursing service to the occupants of these patient rooms. Facilities serving other areas of the hospital and creating traffic unnecessary to the functions of the nursing unit are excluded.

(51) "Observation room" means a room for close nursing observation and care of one or more outpatients for a period of less than twenty-four consecutive hours.

(52) "Obstetrical area" means the portions or units of the hospital designated or designed for care and treatment of women during the antepartum, intrapartum, and postpartum periods, and/or areas designed as nurseries for care of newborns.

(53) "Occupational therapist" means an individual licensed under the provisions of chapter 18.59 RCW.

(54) "Operating room" means a room within the sterile surgical department intended for invasive and noninvasive procedures requiring anesthesia.

(55) "Outpatient" means a patient receiving services that generally do not require admission to a hospital bed for twenty-four hours or more.

(56) "Patient" means an individual receiving (or has received) preventive, diagnostic, therapeutic, rehabilitative, maintenance, or palliative health services at the hospital.

(57) "Patient care areas" means all nursing service areas of the hospital where direct patient care is rendered and all other areas of the hospital where diagnostic or treatment procedures are performed directly upon a patient.

(58) "Pediatrician" means a physician:

(a) Having successfully completed a residency program approved by the American Board of Pediatrics as described in the *Directory of Residency Training Programs Accredited by the Accreditation Council for Graduate Medical Education*, American Medical Association, 1981-1982; or

(b) Approved by the American Osteopathic Board of Pediatrics as described in the *American Osteopathic Association Yearbook and Directory*, 1981-1982; and

(c) Board certified or board eligible for period not to exceed three years.

(59) "Pediatric service" means any diagnostic, treatment, or care service provided for infants, children, or adolescents.

(60) "Person" means any individual, firm, partnership, corporation, company, association, or joint stock association, and the legal successor thereof.

(61) "Pharmacist" means an individual licensed by the state board of pharmacy to engage in the practice of pharmacy under the provisions of chapter 18.64 RCW as now or hereafter amended.

(62) "Pharmacy" means the central area in a hospital where drugs are stored and are issued to hospital departments or where prescriptions are filled.

(63) "Physical barrier" means a partition or similar space divider designed to prevent splash or spray between room areas.

(64) "Physical therapist" means an individual licensed under provisions of chapter 18.74 RCW.

(65) "Physician" means an individual licensed under provisions of chapter 18.71 RCW, Physicians, or chapter 18.57 RCW, Osteopathy—Osteopathic medicine and surgery.

(66) "Physician's assistant" means an individual who is not a physician but practices medicine under provisions, rules, and regulations of chapter 18.71A RCW, or provisions, rules, and regulations under chapter 18.57A RCW.

(67) "Physician member of medical staff qualified in nuclear medicine" means a physician with staff privileges who is:

(a) Certified or eligible for certification by the American Board of Radiology (ABR) or the American Board of Nuclear Medicine (ABNM) in radiologic physics including diagnostic, therapeutic, and medical nuclear physics; and

(b) Included in the 1987-1989 list of board-certified physicians maintained by ACR Professional Bureau, 1899 Preston White Drive, Reston, VA 22091.

(68) "Prescription" means an order for drugs for a specific patient given by a licensed physician, dentist, or other individual legally authorized to write prescriptions, transmitted to a pharmacist for dispensing to the specific patient.

(69) "Procedure" means an activity to relieve pain, diagnose, cure, improve, or treat a patient's condition usually requiring specialized equipment.

(70) "Protocols" and "standing order" mean written descriptions of actions and interventions for implementation by designated hospital personnel under defined circumstances and authenticated by a legally authorized person under hospital policy and procedure.

(71) "Psychiatric unit" means a separate portion of the hospital specifically reserved for the care of psychiatric patients (a part of which may be unlocked and a part locked), as distinguished from "seclusion rooms" or "security rooms" as defined in this section.

(72) "Psychiatrist" means a physician having successfully completed a three-year residency program in psychiatry and is eligible for certification by the American Board of Psychiatry and Neurology as described in the *Directory of Residency Training Programs Accredited by the Accreditation Council for Graduate Medical Education*, American Medical Association, 1981-1982, or eligible for certification by the American Osteopathic Board of Neurology and Psychiatry as described in the *American Osteopathic Association Yearbook and Directory*, 1981-1982.

(73) "Psychologist" means an individual licensed as a psychologist in the state of Washington under provisions of chapter 18.83 RCW.

(74) "Radiation oncologist" means a physician who successfully completed an approved residency program in therapeutic radiology and is either board certified or eligible for board certification in radiation oncology by:

(a) The American Board of Radiology described under *Directory of Residency Programs Accredited by the Accreditation Council for Graduate Medical Education*, American Medical Association, 1981-82, with:

(i) Certification in use of both external and brachytherapy techniques; and

(ii) Continuing education requirements of the board met; or

(b) The American Osteopathic Board of Radiology described in the *American Osteopathic Association Yearbook and Directory*, 1981-82 with:

(i) Certification in use of both external and brachytherapy techniques; and

(ii) Continuing education requirements of the board met.

(75) "Radiologist" means a physician who is board certified or eligible for certification in radiology and meeting continuing education requirements of:

(a) The American Board of Radiology described under *Directory of Residency Programs Accredited by the Accreditation Council for Graduate Medical Education*, American Medical Association, 1981-82; or

(b) The American Osteopathic Board of Radiology described under *American Osteopathic Association Yearbook and Directory*, 1981-82.

(76) "Recreational therapist" means an individual with a bachelors degree including a major or option in therapeutic recreation or recreation for the ill and handicapped.

(77) "Recovery unit" means a special physical and functional unit for the segregation, concentration, and close or continuous nursing observation and care of patients for a period of less than twenty-four hours immediately following anesthesia, obstetrical delivery, surgery, or other diagnostic

or treatment procedures which may produce shock, respiratory obstruction or depression, or other serious states.

(78) "Referred outpatient diagnostic service" means a service provided to an individual receiving medical diagnosis, treatment, and other health care services from one or more sources outside the hospital limited to diagnostic tests and examinations:

(a) Not involving administration of a parenteral injection, the use of a local or general anesthesia or the performance of a surgical procedure; and

(b) Ordered by a health care practitioner, legally permitted to order such tests and examinations, to whom the hospital reports the findings and results of the tests and examinations.

(79) "Registered nurse" means an individual licensed under the provisions of chapter 18.88 RCW and practicing in accordance with the rules and regulations promulgated thereunder.

(80) "Restraint" means any apparatus used for the purpose of preventing or limiting free body movement. This shall not be interpreted to include a safety device as defined herein.

(81) "Room" means a space set apart by floor-to-ceiling partitions on all sides with proper access to a corridor and with all openings provided with doors or windows.

(82) "Rooming-in" means an arrangement for mother and infant to room together with provision for family interaction within the hospital setting.

(83) "Safety device" means a device used to safeguard a patient who, because of developmental level or condition, is particularly subject to accidental self-injury.

(84) "Seclusion room" means a small, secure room specifically designed and organized to provide for temporary placement, care, and observation of one patient and further providing an environment with minimal sensory stimuli, maximum security and protection, and visualization of the patient by authorized personnel and staff. Doors of seclusion rooms shall be provided with staff-controlled locks. There shall be security relites in the door or equivalent means affording visibility of the occupant at all times. Inside or outside rooms may be acceptable.

(85) "Security room" means a patient sleeping room designed, furnished, and equipped to provide maximum safety and security, including window protection or security windows and a lockable door with provision for observation of room occupant.

(86) "Self-administration of drugs" means a patient administering or taking his or her own drugs from properly labeled containers: *Provided*, That the facility maintains the responsibility for seeing the drugs are used correctly and the patient is responding appropriately.

(87) "Sensitive area" means a room used for surgery, obstetrical delivery, nursery, post-anesthesia recovery, special procedures where invasive techniques are used, or critical care including, but not limited to, intensive and cardiac care.

(88) "Shall" means compliance is mandatory.

(89) "Should" means a suggestion or recommendation, but not a requirement.

(90) "Sinks":

(a) "Clinic service sink (siphon jet)" means a plumbing fixture of adequate size and proper design for waste disposal

with siphon jet or similar action sufficient to flush solid matter of at least two and one-eighth inch diameter.

(b) "Scrub sink" means a plumbing fixture of adequate size and proper design for thorough washing of hands and arms, equipped with knee, foot, electronic, or equivalent control, and gooseneck spout.

(c) "Service sink" means a plumbing fixture of adequate size and proper design for filling and emptying mop buckets.

(d) "Handwash sink" means a plumbing fixture of adequate size and proper design for washing hands, equipped with soap dispenser and single service hand drying device.

(91) "Social worker" means an individual holding a masters degree in social work from a graduate school of social work approved by the council on social work education.

(92) "Soiled" (when used in reference to a room, area, or facility) means space and equipment for collection or cleaning of used or contaminated supplies and equipment or collection or disposal of wastes.

(93) "Special procedure" means a distinct and/or special diagnostic exam or treatment, such as, but not limited to, endoscopy, angiography, and cardiac catheterization.

(94) "Stretcher" means a four-wheeled cart designed to serve as a litter for the transport of an ill or injured individual in a horizontal or recumbent position.

(95) "Surgical procedure" means any manual or operative procedure performed upon the body of a living human being for the purpose of preserving health, diagnosing or curing disease, repairing injury, correcting deformity or defect, prolonging life or relieving suffering, and involving any of the following:

(a) Incision, excision, or curettage of tissue or an organ;

(b) Suture or other repair of tissue or an organ including a closed as well as an open reduction of a fracture;

(c) Extraction of tissue including the premature extraction of the products of conception from the uterus; or

(d) An endoscopic examination with use of a local or general anesthesia.

(96) "Therapeutic radiologic technologist" means an individual certified or eligible for certification as a therapeutic radiologic technologist under chapter 18.84 RCW.

(97) "Through traffic" means traffic for which the origin and destination are outside the room or area serving as a passageway.

(98) "Toilet" means a room containing at least one water closet.

(99) "Treatment" means the care and management of a patient to combat, improve, or prevent a disease, disorder, or injury, and may be:

(a) Pharmacologic, surgical, or supportive;

(b) Specific for a disorder; or

(c) Symptomatic to relieve symptoms without effecting a cure.

(100) "Tuberculous patient" means an individual receiving diagnostic or treatment services because of suspected or known tuberculosis.

(101) "Water closet" means a plumbing fixture for defecation fitted with a seat and device for flushing the bowl of the fixture with water.

(102) "Window" means a glazed opening in an exterior wall.

(a) "Maximum security window" means a window that can only be opened by keys or tools under the control of personnel. The operation shall be restricted to prohibit escape or suicide. Where glass fragments may create a hazard, safety glazing and other appropriate security features shall be incorporated. Approved transparent materials other than glass may be used.

(b) "Relite" means a glazed opening in an interior partition between a corridor and a room or between two rooms to permit viewing.

(c) "Security window" means a window designed to inhibit exit, entry, and injury to a patient, incorporating approved, safe transparent material.

[Statutory Authority: RCW 70.41.030. 93-07-011 (Order 338), § 246-318-010, filed 3/5/93, effective 4/5/93; 92-02-018 (Order 224), § 246-318-010, filed 12/23/91, effective 1/23/92. Statutory Authority: RCW 43.70.040. 91-02-049 (Order 121), recodified as § 246-318-010, filed 12/27/90, effective 1/31/91. Statutory Authority: RCW 70.41.030. 90-24-044 (Order 115), § 248-18-001, filed 11/30/90, effective 12/31/90; 89-22-106 (Order 010), § 248-18-001, filed 11/1/89, effective 12/2/89; 88-18-021 (Order 2680), § 248-18-001, filed 8/30/88. Statutory Authority: 1985 c 213. 86-08-002 (Order 2348), § 248-18-001, filed 3/20/86. Statutory Authority: RCW 70.41.030 and 43.20.050. 84-17-077 (Order 275), § 248-18-001, filed 8/16/84; 83-19-058 (Order 269), § 248-18-001, filed 9/20/83; 83-01-003 (Order 245), § 248-18-001, filed 12/2/82. Statutory Authority: RCW 70.41.030. 81-05-029 (Order 209), § 248-18-001, filed 2/18/81; Order 135, § 248-18-001, filed 12/6/76; Order 119, § 248-18-001, filed 5/23/75; Order 106, § 248-18-001, filed 1/13/75; Order 91, § 248-18-001, filed 10/3/73; Order 83, § 248-18-001, filed 4/9/73; Order 50, § 248-18-001, filed 12/17/70; Regulation 18.001, effective 3/11/60.]

**WAC 246-318-013 License expiration dates—Notice of decision—Adjudicative proceeding.** (1) The department shall issue hospital licenses initially and reissue hospital licenses as often thereafter as necessary to stagger license expiration dates throughout the calendar year so as to cause approximately one-twelfth of the total number of hospital licenses to expire on the last day of each month, but no license issued pursuant to this chapter shall exceed thirty-six months in duration. If there is failure to comply with the provisions of chapter 70.41 RCW or this chapter, the department may, in its discretion, issue a provisional license to permit the operation of the hospital for a period of time to be determined by the department.

(2) The department may deny, suspend, modify, or revoke a license for cause.

(3)(a) The department's notice of a denial, suspension, modification, or revocation of a license shall be consistent with RCW 43.70.115. An applicant or license holder has the right to an adjudicative proceeding to contest a license decision.

(b) A license applicant or holder contesting a department license decision shall within twenty-eight days of receipt of the decision:

(i) File a written application for an adjudicative proceeding by a method showing proof of receipt with the Administrative Hearings Unit, Department of Health, 1300 Quince Street S.E., P.O. Box 47851, Olympia, WA 98504-7851; and

(ii) Include in or with the application:

(A) A specific statement of the issue or issues and law involved;

(B) The grounds for contesting the department decision; and

(C) A copy of the contested department decision.

(c) The proceeding is governed by the Administrative Procedure Act (chapter 34.05 RCW), this chapter, and chapter 246-08 WAC. If a provision in this chapter conflicts with chapter 246-08 WAC, the provision in this chapter governs.

[Statutory Authority: RCW 70.41.030. 92-02-018 (Order 224), § 246-318-013, filed 12/23/91, effective 1/23/92. Statutory Authority: RCW 43.70.040. 91-02-049 (Order 121), recodified as § 246-318-013, filed 12/27/90, effective 1/31/91. Statutory Authority: Chapter 34.05 RCW, RCW 34.05.220 (1)(a) and 70.41.030. 90-06-019 (Order 039), § 248-18-015, filed 2/28/90, effective 3/1/90. Statutory Authority: RCW 70.41.030 and 43.20.050. 82-24-002 (Order 249), § 248-18-015, filed 11/18/82; Order 119, § 248-18-015, filed 5/23/75; Order 69, § 248-18-015, filed 1/13/72.]

#### **WAC 246-318-015 Exemptions and interpretations.**

(1) If a hospital that is required to be licensed under this act does not normally provide a particular service or department, the section or sections of these regulations relating to such service or department will not be applicable.

(2) The department may, in its discretion, exempt certain hospitals from complying with parts of these regulations when it has been found after thorough investigation and consideration that such exemption may be made in an individual case without placing the safety or health of the patients in the hospitals involved in jeopardy.

(3) The secretary of the department or his or her designee may, upon written application of a hospital, allow the substitution of procedures, materials, or equipment for those specified in these regulations when such procedures, materials, or equipment have been demonstrated to his or her satisfaction to be at least equivalent to those prescribed. The secretary or his or her designee shall send a written response to a hospital which has applied for approval of a substitution. The response shall approve or disapprove the substitution and shall be issued within thirty working days after the department has received all the information necessary to the review of the application.

(4) A hospital may, upon submission of a written request to the secretary of the department or his or her designee, obtain an interpretation of a rule or regulation contained in this chapter. The secretary or his or her designee shall, in response to such a request, send a written interpretation of the rule or regulation within thirty working days after the department has received complete information relevant to the requested interpretation.

(5) A copy of each exemption or substitution granted or interpretation issued pursuant to the provisions of this section shall be reduced to writing and filed with the department and the hospital.

[Statutory Authority: RCW 70.41.030. 92-02-018 (Order 224), § 246-318-015, filed 12/23/91, effective 1/23/92. Statutory Authority: RCW 43.70.040. 91-02-049 (Order 121), recodified as § 246-318-015, filed 12/27/90, effective 1/31/91. Statutory Authority: Chapter 70.41 RCW. 90-12-014 (Order 061), § 248-18-010, filed 5/30/90, effective 6/30/90. Statutory Authority: 1985 c 213. 86-08-002 (Order 2348), § 248-18-010, filed 3/20/86. Statutory Authority: RCW 70.41.30 [70.41.030]. 81-05-029 (Order 209), § 248-18-010, filed 2/18/81; Order 142, § 248-18-010, filed 2/8/77; Order 119, § 248-18-010, filed 5/23/75; Order 50, § 248-18-010, filed 12/17/70; Order 22, § 248-18-010, filed 6/27/69; Order 10, § 248-18-010, filed 1/2/69; Regulation 18.010, effective 3/1/60; Subsection (3), filed 2/17/61.]

**WAC 246-318-017 Single license to cover two or more buildings—When permissible.** When an applicant

and the hospital facility for which such application is submitted meet the licensure requirements of chapter 70.41 RCW and this chapter, the department may issue a single hospital license to include two or more buildings, provided:

(1) The licensee shall operate the multiple buildings as a single integrated system.

(a) All buildings or portions of buildings under a single license shall be governed by a single governing body and under administrative control of a single administrator, and

(b) All hospital facilities operating under a single license shall have a single medical staff.

(2) Buildings connected by a heated, enclosed passageway are considered a single building and the passageway shall be constructed and maintained to permit the safe transfer of patients, equipment, and supplies.

(3) Safe, appropriate, and adequate transport of patients between buildings shall be provided.

(4) Hospital buildings included under one license shall not be located more than ten surface miles apart.

[Statutory Authority: RCW 70.41.030. 92-02-018 (Order 224), § 246-318-017, filed 12/23/91, effective 1/23/92. Statutory Authority: RCW 43.70.040. 91-02-049 (Order 121), recodified as § 246-318-017, filed 12/27/90, effective 1/31/91. Statutory Authority: RCW 70.41.030. 85-23-020 (Order 2305), § 248-18-017, filed 11/13/85; Order 119, § 248-18-017, filed 5/23/75.]

**WAC 246-318-018 Hospital license to cover attached nursing home building—When permissible.** A building meeting the requirements of this chapter and which has been approved by the department of social and health services as a nursing home may be licensed as a part of a hospital by means of a hospital license rider provided:

(1) The hospital makes application for license of the nursing home facility as a part of the hospital;

(2) The hospital and nursing home facility organization, administration and operation are integrated;

(3) The nursing home facility is connected to the hospital by an enclosed, heated passageway which has been approved by the department for the transport of patients, equipment and supplies; and

(4) The hospital establishes and maintains a mechanism whereby placement and retention of patients in the nursing home facility are reviewed by a professional group representative of the hospital's administrative, medical and nursing staffs to assure that use of the nursing home facility is limited to patients who require nonacute, convalescent or chronic care only.

And further provided that where requirements of this chapter affecting only the maintenance and operation of the nursing home facility are in conflict with this chapter, then such conflicts may be resolved by each hospital individually: *Provided*, That maintenance and operation of the facility meet either chapter 248-14 WAC or or this chapter.

[Statutory Authority: RCW 70.41.030. 92-02-018 (Order 224), § 246-318-018, filed 12/23/91, effective 1/23/92. Statutory Authority: RCW 43.70.040. 91-02-049 (Order 121), recodified as § 246-318-018, filed 12/27/90, effective 1/31/91. Statutory Authority: Chapter 70.41 RCW. 90-12-014 (Order 061), § 248-18-018, filed 5/30/90, effective 6/30/90; Order 119, § 248-18-018, filed 5/23/75.]

**WAC 246-318-020 Approval of plans.** (1) Plans and specifications for new construction other than minor alter-



ations, shall be prepared by or under the direction of an architect duly registered in the state of Washington. It is strongly recommended that a narrative description of any proposed construction or alterations be submitted to the department prior to the preparation of any preliminary drawings.

(2) All new construction, other than minor alterations, shall be done in accordance with at least the specific minimum requirements of the department covering new construction in hospitals, including submission of preliminary plans and the submission and approval of final working drawings and specifications.

(3) Compliance with these standards and regulations does not relieve the hospital of the need to comply with applicable state and local building and zoning codes.

[Statutory Authority: RCW 43.70.040. 91-02-049 (Order 121), recodified as § 246-318-020, filed 12/27/90, effective 1/31/91. Statutory Authority: Chapter 70.41 RCW. 90-12-014 (Order 061), § 248-18-020, filed 5/30/90, effective 6/30/90; Order 119, § 248-18-020, filed 5/23/75; Regulation 18.020, effective 3/11/60.]

**WAC 246-318-025 Required approval for occupancy after completion of new construction.** (1) Prior to occupancy and use of a building or any room or other portion of a building constituting the whole or part of a new construction project, a hospital shall have obtained written authorization for such occupancy from the department.

(2) The hospital shall notify the department when either of the following has been substantially completed: An entire new construction project, or any room or other portion of a new construction project the hospital plans to occupy before the entire new construction project is finished.

(3) The department shall authorize occupancy if the new construction has been completed in accordance with this chapter and the department has received written approval of such occupancy from the state fire marshal.

(4) The department may authorize occupancy of a building or any room or other portion of a building when the new construction is deficient in relation to this chapter: *Provided*, That the department has determined, after thorough investigation and consideration, the deficiencies will not impair services to patients or otherwise jeopardize the safety or health of patients, the hospital has provided written assurance of completion or correction of deficient items within a period of time acceptable to the department, and the department has received written approval of such occupancy from the state fire marshal.

[Statutory Authority: RCW 70.41.030. 92-02-018 (Order 224), § 246-318-025, filed 12/23/91, effective 1/23/92. Statutory Authority: RCW 43.70.040. 91-02-049 (Order 121), recodified as § 246-318-025, filed 12/27/90, effective 1/31/91. Statutory Authority: RCW 70.41.030 and 43.20.050. 82-13-084 (Order 230), § 248-18-025, filed 6/22/82; Order 123, § 248-18-025, filed 3/18/76.]

**WAC 246-318-030 Governing body and administration.** (1) The hospital shall have a governing body responsible for adoption of policies concerning the purposes, operation and maintenance of the hospital, including safety, care, and treatment of patients.

(2) The hospital governing body shall:

(i) Provide personnel, facilities, equipment, supplies, and services to meet the needs of patients within the purposes of the hospital.

(ii) Appoint an administrator responsible for implementing the policies adopted by the governing body.

(iii) Have authority and responsibility for the appointment and periodic reappointment of the medical staff.

(iv) Require medical staff accountability to the governing body through approval under the medical staff organization bylaws and rules as applied by the governing body.

(v) Require evidence that each individual granted clinical privileges pursuant to medical staff bylaws has appropriate and current qualifications.

(vi) Require that each person admitted to the hospital is under the care of a member of the medical staff possessing clinical privileges.

(3) The hospital shall establish and maintain a coordinated program for identification and prevention of malpractice according to RCW 70.41.200 to include:

(a) Quality assurance committee including at least one member of the governing body with functions described in RCW 70.41.200;

(b) Policies, procedures, systems, and practices to comply with RCW 70.41.200 related to:

(i) Medical staff privileges sanction and individual physician review.

(ii) Review of qualifications of persons delivering care in the hospital.

(iii) Resolution of grievances by patients.

(iv) Continuous collection of information related to negative health care outcomes and injuries to patients.

(v) Education programs and compliance with reporting requirements of RCW 70.41.200.

(vi) Access by medical and osteopathic licensing and disciplinary boards to appropriate records of hospital decisions on restriction or termination of physician privileges.

(4) Each hospital shall develop procedures for identifying potential organ and tissue donors as required in RCW 68.08.650.

[Statutory Authority: RCW 43.70.040. 91-02-049 (Order 121), recodified as § 246-318-030, filed 12/27/90, effective 1/31/91. Statutory Authority: RCW 70.41.030. 87-03-020 (Order 2463), § 248-18-031, filed 1/13/87. Statutory Authority: RCW 70.41.030 and 43.20.050. 84-17-077 (Order 275), § 248-18-031, filed 8/16/84.]

**WAC 246-318-033 Medical staff.** (1) There shall be a medical staff appointed by the governing body.

(2) Medical staff bylaws, rules, and regulations shall be subject to approval by the governing body. These bylaws and rules shall include qualifications for medical staff membership, procedures for delineation of hospital specific clinical privileges, and organization of the medical staff.

[Statutory Authority: RCW 43.70.040. 91-02-049 (Order 121), recodified as § 246-318-033, filed 12/27/90, effective 1/31/91. Statutory Authority: RCW 70.41.030 and 43.20.050. 84-17-077 (Order 275), § 248-18-033, filed 8/16/84.]

**WAC 246-318-035 Infection control program.** Each hospital shall maintain an effective hospital wide program for the surveillance, prevention, and control of infection including:



(1) Designation of an infection control committee to oversee the program with:

(a) Multidisciplinary membership on the committee including representatives from medical staff, nursing, administration, and persons directly responsible for management of the infection control program;

(b) Description of the program approved by the committee and including surveillance, prevention, and control activities;

(c) Delegation of authority, approved in writing by administrative and medical staff, to institute surveillance, prevention, and control measures when there is reason to believe any patient or personnel may be at risk of infection;

(d) Regularly scheduled meetings at least quarterly;

(e) Maintenance of written minutes and reports of findings presented during committee meetings; and

(f) A method for forwarding recommendations to the medical staff, nursing, administration, quality assurance, and other committees and departments as appropriate.

(2) Management of the infection control program by one or more persons with documented evidence of qualifications related to infection surveillance, prevention, and control including:

(a) Education;

(b) Training;

(c) Certification; or

(d) Supervised experience.

(3) Establishing the following components of the infection control program:

(a) Review of patient and personnel infections, as appropriate, to determine whether an infection is nosocomial using definitions and criteria established by the committee;

(b) Written policies and procedures describing the types of surveillance carried out to monitor:

(i) Rates of nosocomial infections;

(ii) Systems used to collect and analyze data; and

(iii) Activities to prevent and control infections;

(c) A system for reporting communicable diseases and following requirements under chapter 246-100 WAC, Communicable and certain other diseases;

(d) A procedure for reviewing and approving infection control aspects of policies and procedures used in each area of the hospital;

(e) Provision of consultation regarding patient care practices, equipment, and supplies influencing risk of infection;

(f) Provision of consultation regarding appropriate procedures and products used for cleaning, disinfection, and sterilization;

(g) Provision of information on infection control for orientation and in-service education of employees, and nonemployees performing direct patient care;

(h) Development of recommendations, consistent with federal, state, and local laws and rules, on methods for the proper disposal to prevent unsafe or unsanitary conditions related to:

(i) Sewage;

(ii) Solid and liquid wastes; and

(iii) Infectious wastes including safe management of sharps;

(i) Defining indications for specific precautions to prevent transmission of infections;

(j) Coordinating of or cooperating with the employee health activities relating to control of hospital exposure and transmission of infections to or from employees and others performing patient services;

(k) Designing and monitoring of the physical environment of the hospital for infectious disease control.

(4) Provision of the following in any hospital providing inpatient services for tuberculous patients:

(a) Designated patient rooms for patients with suspected or known infectious tuberculosis including:

(i) Ventilation to maintain a negative pressure condition in each patient room relative to adjacent spaces, except bath and toilet areas with:

(A) Air movement or exhaust from the patient room to the out-of-doors;

(B) Ventilation at the rate of six air changes per hour, exhaust; and

(C) Make-up or supply air from adjacent ventilated spaces permitted only when a minimum of two air changes is tempered with outside air;

(ii) Ultraviolet generator irradiation as follows:

(A) Use of ultraviolet fluorescent fixtures with lamps emitting wave length of 253.7 nanometers to irradiate ceiling and upper space of patient room;

(B) The average reflected irradiance approximately 0.2 microwatts per square centimeter in the room at the five foot level;

(C) Fixture installation conforming to the recommendations of the Illuminating Engineering Society Handbook, 5th edition, section 25, "Ultraviolet Energy";

(D) Lamps changed as recommended by the manufacturer;

(b) Transfer of discharge information to the health department of the patient's county of residence;

(c) Mantoux tuberculin skin testing of employees in contact with infectious tuberculosis cases within one year of contact if regularly working in areas described under subsection (4)(a)(i) and (ii) of this section.

(d) Tuberculin skin testing employees as required by the local health officer or the department for contact investigations. Positive skin tests for contact investigations are 5 mm induration read at forty-eight to seventy-two hours.

(5) Implementation of a human immunodeficiency virus (HIV) and acquired immunodeficiency syndrome (AIDS) education plan including:

(a) Verifying or arranging for appropriate education and training of personnel on the prevention, transmission, and treatment of HIV and AIDS consistent with RCW 70.24.310; and

(b) Use of infection control standards and educational material consistent with the department-approved curriculum manual KNOW - HIV/AIDS, Prevention Education for Health Care Facility Employees, January 1991, published by the office on HIV/AIDS.

[Statutory Authority: RCW 70.41.030. 92-02-018 (Order 224), § 246-318-035, filed 12/23/91, effective 1/23/92. Statutory Authority: RCW 43.70.040. 91-02-049 (Order 121), recodified as § 246-318-035, filed 12/27/90, effective 1/31/91. Statutory Authority: RCW 70.41.030. 90-24-044 (Order 115), § 248-18-035, filed 11/30/90, effective 12/31/90. Statutory Authority: RCW 70.41.030 and 43.20.050. 89-21-039 (Order 4), § 248-18-035, filed 10/12/89, effective 11/12/89; Order 119, § 248-18-035, filed 5/23/75; Order 107, § 248-18-035, filed 1/13/75.]

**WAC 246-318-040 Personnel.** (1) Hospitals shall employ sufficient qualified personnel to operate each department of the hospital with verification of required license, certification, or registration.

(2) Hospitals shall ensure that nonemployees providing direct patient care comply with hospital policies and procedures.

(3) Hospitals shall establish written job descriptions for each job classification, minimally including:

(a) Job title, reporting relationships, summary of duties and responsibilities, and qualifications; and

(b) Provisions for review every two years with revision when necessary.

(4) Hospitals shall:

(a) Ensure a periodic performance appraisal of employees and volunteers related to:

(i) Satisfactory performance of assigned tasks; and

(ii) Competence in delivering health care services;

(b) Designate an employee responsible for volunteer services and activities;

(c) Plan and implement orientation and education programs minimally to include:

(i) New employee and volunteer orientation for:

(A) Organizational structure;

(B) Building layout;

(C) Infection control;

(D) Safety, including the fire and disaster plan;

(E) Policies and procedures; and

(F) Equipment pertinent to the job;

(ii) Employee continuing education for maintaining and improving skills;

(iii) Documentation of orientation, in-service, and continuing education for employees; and

(iv) HIV/AIDS training for employees as specified under WAC 246-318-035;

(d) Establish a nursing service under the direction of a registered nurse to:

(i) Provide for adequate numbers of registered nurses on duty at all times; and

(ii) Require registered nurse supervision of employees and others performing nursing service functions;

(e) Ensure adequate supervision of employees and nonemployees;

(f) Maintain a current employee call back list for disasters;

(g) Require each employee to have on employment a tuberculin skin test by the Mantoux method within thirty days of employment and as follows:

(i) For new employees, a negative skin test is defined as less than ten millimeters of induration read at forty-eight to seventy-two hours. Employees with negative reactions to the first test and thirty-five years of age or older shall have a second test one to three weeks after the first test;

(ii) New employees with positive reactions to either test shall have a chest x-ray within thirty days. Hospitals shall:

(A) Retain records of test results, reports of x-ray findings, exceptions, or exemptions in the facility; and

(B) Provide a copy of test results to the employee;

(iii) Exclude from skin testing:

(A) New employees documenting a positive Mantoux test in the past;

(B) New employees providing documentation of meeting requirements under subsection (4)(h)(i) and (ii) of this section within the six months preceding the date of employment; and

(C) An employee with a written waiver from the department after stating the tuberculin skin test by the Mantoux method presents a hazard to his or her health and presenting supportive medical data to the department tuberculosis control program;

(h) Document the following when individuals request tuberculosis skin test waivers from the department:

(i) Department notification of the individual requesting a waiver from tuberculosis skin testing and department decision; and

(ii) Department advice to the individual employee and the hospital regarding department screening requirements if a waiver is granted.

[Statutory Authority: RCW 43.43.830 through 43.43.842. 93-16-030 (Order 381), § 246-318-040, filed 7/26/93, effective 8/26/93. Statutory Authority: RCW 70.41.030. 92-02-018 (Order 224), § 246-318-040, filed 12/23/91, effective 1/23/92. Statutory Authority: RCW 43.70.040. 91-02-049 (Order 121), recodified as § 246-318-040, filed 12/27/90, effective 1/31/91. Statutory Authority: RCW 70.41.030. 90-24-044 (Order 115), § 248-18-040, filed 11/30/90, effective 12/31/90; 86-08-086 (Order 2362), § 248-18-040, filed 4/2/86. Statutory Authority: RCW 70.41.030 and 43.20.050. 82-24-003 (Order 250), § 248-18-040, filed 11/18/82. Statutory Authority: RCW 43.20.050. 80-02-003 (Order 191), § 248-18-040, filed 1/4/80; Order 121, § 241-18-040, filed 9/18/75; Order 119, § 248-18-040, filed 5/23/75; Order 91, § 248-18-040, filed 10/3/73; Order 76, § 248-18-040, filed 1/9/73; Regulation 18.040, effective 3/11/60.]

**WAC 246-318-042 Criminal history, disclosure, and background inquiries.** (1) A licensee or license applicant shall require a disclosure statement as specified under RCW 43.43.834 for each prospective employee, volunteer, contractor, student, and any other person associated with the licensed hospital having direct contact with:

(a) Children under sixteen years of age;

(b) Vulnerable adults as defined under RCW 43.43.830; and

(c) Developmentally disabled individuals.

(2) A license applicant having direct contact with vulnerable adults shall obtain a Washington state patrol criminal history background disclosure statement and submit it to the department either:

(a) With the initial application for licensure; or

(b) For current licensees, with the first application for renewal of license submitted after September 1, 1993.

(3) A licensee or license applicant shall:

(a) Require a Washington state patrol background inquiry as specified in RCW 43.43.842(1) for each:

(i) Employee, volunteer, contractor, student, and any other person currently associated with the licensed hospital, having direct contact with vulnerable adults, when engaged on or since July 22, 1989; and

(ii) Prospective employee, volunteer, contractor, student, and person applying for association with the licensed hospital prior to allowing the person direct contact with vulnerable adults, except as allowed by subsection (4) of this section;

(b) Inform each person identified in (a) of this subsection of the requirement for a background inquiry;

(c) Require the person to sign an acknowledgement statement that a background inquiry will be made;

(d) Verbally inform the person of the background inquiry results within seventy-two hours of receipt; and

(e) Offer to provide a copy of the background inquiry results to the person within ten days of receipt.

(4) A licensee may conditionally employ, contract with, accept as a volunteer or associate, a person having direct contact with vulnerable adults pending a background inquiry, provided the licensee:

(a) Immediately obtains a disclosure statement from the person; and

(b) Requests a background inquiry within three business days of the conditional acceptance of the person.

(5) Except as provided in RCW 43.43.842 and in subsection (4) of this section, a licensee shall not hire or retain, directly or by contract, any person having direct contact with vulnerable adults, if that person has been:

(a) Convicted of a crime against persons as defined in RCW 43.43.830;

(b) Convicted of a crime relating to financial exploitation of a vulnerable adult;

(c) Found in any disciplinary board final decision to have abused a vulnerable adult under RCW 43.43.830; or

(d) The subject in a protective proceeding under chapter 74.34 RCW.

(6) The licensee shall establish and implement procedures ensuring that all disclosure statements and background inquiry responses are:

(a) Maintained in a confidential and secure manner;

(b) Used for employment purposes only;

(c) Not disclosed to any person except:

(i) The person about whom the licensee made the disclosure or background inquiry;

(ii) Authorized state and federal employees; and

(iii) The Washington state patrol auditor.

(d) Retained and available for department review during and at least two years following termination of employment.

(7) The department shall:

(a) Review records required under this section;

(b) Investigate allegations of noncompliance with RCW 43.43.830 through 43.43.842, when necessary, in consultation with law enforcement personnel; and

(c) Use information collected under this section solely for the purpose of determining eligibility for licensure or relicensure as required under RCW 43.43.842.

(8) The department may require licensees to complete additional disclosure statements or background inquiries for a person associated with the licensed facility having direct contact with vulnerable adults if the department has reason to believe that offenses specified under RCW 43.43.830 have occurred since completion of the previous disclosure statement or background inquiry.

[Statutory Authority: RCW 43.43.830 through 43.43.842. 93-16-030 (Order 381), § 246-318-042, filed 7/26/93, effective 8/26/93.]

**WAC 246-318-050 Water supply.** (1) There shall be an adequate supply of hot and cold water under pressure which conforms to the quality standards of the department.

(2) Hot water supplied for bathing and handwashing purposes shall be at a safe temperature.

[Statutory Authority: RCW 43.70.040. 91-02-049 (Order 121), recodified as § 246-318-050, filed 12/27/90, effective 1/31/91; Order 119, § 248-18-055, filed 5/23/75.]

**WAC 246-318-060 Plumbing.** The water supply plumbing, the fixtures, and the waste and drainage system of the hospital shall be maintained so as to avoid insanitary conditions.

[Statutory Authority: RCW 43.70.040. 91-02-049 (Order 121), recodified as § 246-318-060, filed 12/27/90, effective 1/31/91. Statutory Authority: RCW 70.41.030. 79-04-004 (Order 175), § 248-18-060, filed 3/9/79; Order 119, § 248-18-060, filed 5/23/75; Regulation 18.060, effective 3/11/60.]

**WAC 246-318-070 Staff facilities.** (1) Adequate and conveniently located toilet and lavatory facilities shall be provided for employees separate from patient facilities.

(2) Paper towels in a satisfactory dispenser or some other acceptable type of single use towels and a satisfactory receptacle for used towels shall be provided at all plumbing fixtures used for handwashing.

(3) Dressing rooms for surgical, delivery, and nursery department personnel should be provided within these areas to facilitate changing to scrub uniforms.

[Statutory Authority: RCW 43.70.040. 91-02-049 (Order 121), recodified as § 246-318-070, filed 12/27/90, effective 1/31/91; Order 119, § 248-18-070, filed 5/23/75; Regulation 18.070, effective 3/11/60.]

**WAC 246-318-080 Storage.** There shall be a sufficient amount of suitable storage space throughout the hospital for all supplies and equipment.

[Statutory Authority: RCW 43.70.040. 91-02-049 (Order 121), recodified as § 246-318-080, filed 12/27/90, effective 1/31/91; Order 119, § 248-18-080, filed 5/23/75; Regulation 18.080, effective 3/11/60.]

**WAC 246-318-090 Heating.** All heating systems shall be maintained and operated in a manner to provide a comfortable temperature for patients and personnel.

[Statutory Authority: RCW 43.70.040. 91-02-049 (Order 121), recodified as § 246-318-090, filed 12/27/90, effective 1/31/91. Statutory Authority: RCW 70.41.030. 79-04-004 (Order 175), § 248-18-090, filed 3/9/79; Order 119, § 248-18-090, filed 5/23/75; Regulation 18.090, effective 3/11/60.]

**WAC 246-318-100 Lighting and wiring.** All usable rooms and areas of the hospital shall be lighted adequately by natural and/or artificial light. Appropriate electrical service shall be provided in all areas of the hospital adequate to meet the electrical demand of the equipment or fixtures used in these areas.

[Statutory Authority: RCW 43.70.040. 91-02-049 (Order 121), recodified as § 246-318-100, filed 12/27/90, effective 1/31/91; Order 119, § 248-18-100, filed 5/23/75; Regulation 18.100, effective 1/11/61.]

**WAC 246-318-110 Emergency light and power.** (1) Flashlights or battery-operated lamps shall be available to employees and kept in operating condition.

(2) Adequate emergency lighting and power shall be available.

[Statutory Authority: RCW 43.70.040. 91-02-049 (Order 121), recodified as § 246-318-110, filed 12/27/90, effective 1/31/91. Statutory Authority:

RCW 70.41.030. 79-04-081 (Order 176), § 248-18-110, filed 4/2/79; Order 119, § 248-18-110, filed 5/23/75; Regulation 18.110, effective 3/11/60.]

**WAC 246-318-120 Ventilation.** All patient rooms, all rooms in which personnel routinely work and the rooms which, because of use, might have objectionable odors and/or excessive condensation shall be adequately ventilated by windows, ducts or mechanical means.

[Statutory Authority: RCW 43.70.040. 91-02-049 (Order 121), recodified as § 246-318-120, filed 12/27/90, effective 1/31/91; Order 119, § 248-18-120, filed 5/23/75; Regulation 18.120, effective 1/11/61.]

**WAC 246-318-130 Corridors and doors.** (1) Corridor and door widths shall be adequate to permit the free movement of patients on standard size wheeled stretchers.

(2) Doors shall not swing into the corridors so as to constitute a hazard.

[Statutory Authority: RCW 43.70.040. 91-02-049 (Order 121), recodified as § 246-318-130, filed 12/27/90, effective 1/31/91; Order 119, § 248-18-130, filed 5/23/75; Regulation 18.130, effective 3/11/60.]

**WAC 246-318-135 Carpets.** (1) Carpets may be used in the following nonpatient occupied areas: Administrative areas; lobbies, lounges; waiting area; chapels, nurses' station; dining rooms; corridors; equipment alcoves opening onto carpeted corridors. Carpets may be used in other areas only upon written approval of such use by the department.

(2) Carpets may be used in the following patient occupied areas: Patient rooms (excluding toilets and bathrooms); coronary care units; recovery rooms (not within surgical suites); labor rooms (not within delivery suites); corridors within patient occupied areas; dayrooms; equipment alcoves opening onto carpeted corridors. Carpets may be used in other areas only upon written approval of such use by the department. Carpets should not be used in dialysis units or wet patient care areas.

(3) Specifications for carpeting in the above patient occupied areas and nonpatient occupied areas:

(a) Fiber and pads which meet the standards of state and local fire codes are acceptable provided the fiber is easily cleanable.

(b) Carpets shall be constructed or treated to prevent or reduce static electricity build up.

(4) The installation of carpets shall be such as to assure the safety of patients, staff and visitors.

[Statutory Authority: RCW 43.70.040. 91-02-049 (Order 121), recodified as § 246-318-135, filed 12/27/90, effective 1/31/91. Statutory Authority: RCW 70.41.030. 79-04-004 (Order 175), § 248-18-135, filed 3/9/79; Order 119, § 248-18-135, filed 5/23/75; Order 9, § 248-18-135, filed 1/2/69; Regulation 18.135, filed 8/4/67.]

**WAC 246-318-140 Stairways, ramps, and elevators.**

(1) When vertical transportation of patients is necessary, adequate elevators or ramps shall be provided.

(2) All stairways and ramps shall have nonskid surfaces.

(3) Stairways and ramps shall have handrails on both sides.

(4) Open stairs and ramps shall have adequate protection.

[Statutory Authority: RCW 43.70.040. 91-02-049 (Order 121), recodified as § 246-318-140, filed 12/27/90, effective 1/31/91; Order 119, § 248-18-140, filed 5/23/75; Regulation 18.140, effective 3/11/60.]

**WAC 246-318-150 Maintenance.** (1) The hospital, its component parts, facilities, and equipment shall be kept clean and in good repair and be maintained with consideration for the safety and well-being of the patients, staff, and visitors. The maintenance department shall function in accordance with written hospital policies and procedures.

(2) Responsibility for maintenance shall be delegated to qualified personnel familiar with the hospital's equipment and/or systems. Personnel policies, job descriptions, records of orientation and in-service training shall be documented.

(3) A scheduled preventive maintenance program with a system of equipment identification shall be established for patient care and physical plant equipment.

(a) Equipment shall be kept clean, calibrated, adjusted, and in good repair.

(b) A written plan shall define the inspection and inspection interval for items and/or categories of equipment. Records shall be maintained to reflect the dates of inspection and maintenance of equipment and the name of the person who did the inspection.

(4) Written procedures shall specify the action to be taken in the event of failure of essential equipment and major utility services. The written procedures shall include a system for summoning essential personnel and outside assistance when required.

(5) Manufacturer's specifications, maintenance and operation procedures appropriate for the hospital's maintenance policies should be retained and filed for access and reference.

(6) Written procedures shall specify areas and equipment requiring specific infection control measures.

[Statutory Authority: RCW 43.70.040. 91-02-049 (Order 121), recodified as § 246-318-150, filed 12/27/90, effective 1/31/91. Statutory Authority: RCW 70.41.030. 79-04-004 (Order 175), § 248-18-150, filed 3/9/79; Order 119, § 248-18-150, filed 5/23/75; Order 9, § 248-18-150, filed 1/2/69; Regulation 18.150, filed 8/4/67; Regulation 18.150, effective 3/11/60.]

**WAC 246-318-155 Housekeeping.** (1) A safe and sanitary environment shall be maintained for all areas of the hospital through the use of sufficient personnel, equipment and procedures.

(2) Adequate, clean housekeeping equipment shall be provided and maintained to meet the needs of the hospital. Carpet vacuum equipment used in patient occupied areas must be equipped with a fine particle retention filter.

(3) Written policies and procedures shall specify daily and periodic cleaning schedules and routines and cleaning between occupancies. There shall be written policies and procedures for cleaning of isolation rooms and other specialized areas.

(4) There shall be effective, safe cleaning and disinfecting agents used with written procedures available.

(5) An effective insect and rodent control program shall be maintained.

[Statutory Authority: RCW 43.70.040. 91-02-049 (Order 121), recodified as § 246-318-155, filed 12/27/90, effective 1/31/91. Statutory Authority: RCW 70.41.030. 79-04-004 (Order 175), § 248-18-155, filed 3/9/79.]

**WAC 246-318-160 Laundry.** (1) The laundry and linen service shall have adequate space and equipment for storage, sorting and processing of clean and soiled linen/laundry.

(a) Separation between clean and soiled linen/laundry shall be maintained during sorting, processing, transporting, and storage of linen/laundry.

(b) Soiled and clean linen/laundry shall be handled in a way which minimizes contamination risks.

(i) Soiled linen/laundry from isolation and septic surgical cases shall be bagged and marked for special handling.

(ii) There shall be an adequate supply of hot water at a minimum temperature of 160 degrees F.; 71.1 degrees C., with use of appropriate disinfecting agents.

(c) Procedures shall be established to provide for clean linen/laundry free of toxic residues.

(2) The hospital shall maintain an adequate supply of linen/laundry through a linen/laundry control system.

(3) A clean and safe environment with adequate ventilation and lighting shall be maintained.

(a) Positive clean air flow shall be maintained in clean linen/laundry areas which are within the laundry.

(b) Negative soiled air flow shall be maintained in soiled linen/laundry areas which are within the laundry.

(c) Chemical or soap product containers shall be clearly labeled.

(d) The use and precautionary procedures shall be defined and posted for chemical agents and soap products.

(4) The laundry and linen service shall be adequately staffed.

(a) Orientation and in-service, including infection control and safe laundry practices, shall be provided for laundry and linen service personnel.

(b) Written policies and procedures shall specify scheduled activities and routines of personnel working in the laundry and/or linen areas.

(5) If contracted services are used, the hospital shall insure that all requirements, except requirements in subsection (4) of this section, are met through:

(a) An annual on-site visit (inspection), of the complete physical plant(s) of any contract laundry which provides any service to or for the hospital shall be conducted by (a) member(s) of the hospital infection control committee (or the equivalent designated committee). This annual visit (inspection), as a minimum requirement, shall be done by that member of the hospital infection control committee (or equivalent designated committee), who has the most expertise in the field of infection control and shall be documented by that committee in a record which the hospital shall retain.

(b) A written agreement between the hospital and any facility which provides laundry services to and for the hospital requiring that applicable provisions of this section (see subsection (5) of this section), be met by the laundry provider, and allowing for immediate termination of the contract for failure to comply with any of the applicable provisions hereof, provided this subsection shall not be effective relative to any contract which was in existence prior to the effective date of this subsection, provided, however, that no such contract may be extended, renewed or otherwise held in effect beyond its termination date, as stated on the effective date hereof.

(c) The hospital which uses contract laundry services shall meet the requirements specified in subsection (4) of this section, as applicable, for any hospital employees who

are involved with distribution, handling or storage of the linen/laundry, whether cleaned or soiled.

[Statutory Authority: RCW 43.70.040. 91-02-049 (Order 121), recodified as § 246-318-160, filed 12/27/90, effective 1/31/91. Statutory Authority: RCW 70.41.030. 79-04-081 (Order 176), § 248-18-160, filed 4/2/79; Order 119, § 248-18-160, filed 5/23/75; Regulation 18.160, effective 3/11/60.]

#### **WAC 246-318-170 Sewage, garbage, and waste.** (1)

All sewage, garbage, refuse, and liquid wastes shall be collected and disposed of in a manner to prevent the creation of an unsafe or insanitary condition or nuisance.

(2) Contaminated dressings, used dressings, surgical and obstetrical wastes, and other similar materials shall be handled in a satisfactory manner and finally disposed of in an incinerator or by another approved method.

(3) Procedures shall be developed which specify the safe disposal of needles, knife blades, chemicals, and other potentially dangerous wastes.

[Statutory Authority: RCW 43.70.040. 91-02-049 (Order 121), recodified as § 246-318-170, filed 12/27/90, effective 1/31/91. Statutory Authority: RCW 70.41.030. 79-04-004 (Order 175), § 248-18-170, filed 3/9/79; Order 119, § 248-18-170, filed 5/23/75; Regulation 18.170, effective 3/11/60.]

#### **WAC 246-318-180 Dietary and/or food service.**

Each hospital shall have an organized dietary and/or food service.

(1) There shall be a designated individual responsible for management of dietary and/or food service. Personnel from dietary and/or food service shall be present in the hospital during all patient meal times.

(2) The dietary and/or food service shall incorporate the ongoing and regularly scheduled input of a dietitian. A dietitian shall be responsible for developing policies and procedures for adequate nutritional and dietary consultation services for patients and food service. Patient consultation shall be documented in the medical record.

(3) At least three scheduled meals a day shall be served at regular intervals with not more than fifteen hours between the evening meal and breakfast. Snacks of nourishing quality shall be available at all times.

(4) Meals and nourishments shall provide a variety of food of sufficient quantity and quality to meet the nutritional needs of each patient. Unless contraindicated, *Recommended Dietary Allowances*, Ninth edition, 1980, the Food and Nutrition Board of the National Research Council, adjusted for activity, shall be used.

(5) Written menus shall be planned in advance and approved by a dietitian. Substitutes shall be of similar nutritional value, as approved by a dietitian. A record of the planned menus, with substitutions as served, shall be retained for one month.

(6) There shall be written orders (by an authorized individual) for all patient diets. Diets shall be prepared and served as prescribed. A current diet manual, approved in writing by the dietitian and medical staff, shall be used for planning and preparing diets.

(7) Food service sanitation shall be in compliance with chapter 246-215 WAC Food service sanitation, except for WAC 246-215-149.

(8) There shall be current written policies and procedures to include safety, infection control, food acquisition, food storage, food preparation, management of food not

provided or purchased by dietary/food service, serving of food, and scheduled cleaning of all food service equipment and work areas.

(9) There shall be current written policies and procedures, with documentation of orientation and inservice, of dietary and food service employees.

[Statutory Authority: RCW 70.41.030. 92-02-018 (Order 224), § 246-318-180, filed 12/23/91, effective 1/23/92. Statutory Authority: RCW 43.70.040. 91-02-049 (Order 121), recodified as § 246-318-180, filed 12/27/90, effective 1/31/91. Statutory Authority: RCW 70.41.030 and 43.20.050. 83-07-048 (Order 257), § 248-18-180, filed 3/18/83; Order 119, § 248-18-180, filed 5/23/75; § 248-18-180, filed 12/6/67; Regulation 18.180, effective 3/1/60.]

#### **WAC 246-318-190 Patient care services, general.**

(1) Policies, procedures, and techniques.

(a) Hospitals shall establish written policies and procedures which specify the criteria for admission of patients to general and specialized patient care service areas and conditions requiring transfer. These policies and procedures shall be based upon the availability of sufficient and appropriate personnel, space, equipment, and supplies to provide care and treatment of patients.

(b) There shall be written patient care policies and procedures designed to guide personnel. The policies and procedures should be reviewed at least one time every two years, revised as necessary, and approved in writing by appropriate representatives of the administrative, medical, and nursing service.

(c) There shall be procedures and provision for personnel to gain immediate access to patient rooms, toilets, showers, and bathrooms should any emergency occur to a patient in any one of these areas.

(d) The hospital shall establish safety policies and procedures for the care of all patients with special consideration for patients who because of age or condition are not responsible for his or her acts.

(e) There shall be policies and procedures addressing protection of patients from assault, abuse, and neglect. All patient care personnel and staff should be oriented and educated regarding preventing and reporting abuse of patients.

(f) Written policies and procedures shall address immediate actions or behaviors of personnel and staff when patient behavior indicates that he or she is assaultive, out of control, or destructive.

(g) Adequate nursing care shall be provided to all patients:

(i) A patient care plan and/or nursing care plan shall be developed by or in conjunction with a registered nurse. There shall be documentation in the medical record of discharge planning.

(ii) Discharge assessment shall be completed on all patients with discharge planning as indicated.

(h) There shall be a reliable method for personal identification of each patient.

(i) A recognized standard procedure for the handling and administration of blood and blood products shall be established. This procedure shall be written and readily available to all personnel responsible for the administration of blood and/or blood products.

(j) A standard isolation technique shall be established and practiced.

(k) There shall be written policies governing smoking by personnel, patients, visitors, and others within the hospital. Policies shall be designed to prohibit smoking where or when smoking may cause discomfort to a patient or constitute a safety hazard.

(l) A physical examination and medical history shall be documented within forty-eight hours of admission unless completed within one week prior to admission and incorporated into the medical record.

(m) Each patient care service area shall have available current references which are appropriate to the general and specific care provided in that area or unit.

(n) Written policies and procedures shall be established, available to, and followed by personnel and medical staff in patient care areas who handle, manage, control, prescribe, dispense, or administer medications or drugs. Drugs are those substances and articles defined in chapter 69.41 RCW.

(i) All policies and procedures related to drugs shall be approved by the appropriate medical staff committee in collaboration with the pharmacist who directs the hospital pharmacy with evidence of discussion of and attention to concerns of an advisory interdisciplinary group minimally to include representatives from medical staff, hospital administration, and nursing service. Policies and procedures need not be identical in all patient care areas.

(ii) Written order or prescription by members of medical staff authorized by state rule or law to prescribe drugs pursuant to chapter 69.41 RCW shall be required for all medications administered to patients or self-administered by patients within the hospital.

(iii) Medication administration policies and procedures shall be established and followed in patient care areas minimally to address:

(A) Composition of a medication or drug order, i.e., date, type and amount of drug, route, frequency of administration, and authentication by medical staff authorized to prescribe drugs pursuant to chapter 69.41 RCW.

(B) Requirements for authorized personnel administering drugs or medications in accordance with state laws and regulations governing such acts.

(C) Requirements for personnel authorized to receive and record or transcribe verbal or telephone drug orders, in accordance with laws and regulations governing such acts, e.g., pharmacists, physicians, and licensed nurses.

(D) Timely authentication of verbal and telephone orders by medical staff authorized to prescribe drugs, not to exceed forty-eight hours for inpatient orders.

(E) Requirements for specific written orders, identification of drug, administration, handling, proper storage, control, or disposition of medications (drugs) owned by the patient, other than those dispensed by the hospital pharmacy.

(F) Requirements for self-administration of medications.

(iv) Medications located in patient care areas shall:

(A) Be the responsibility of the pharmacist directing the hospital pharmacy;

(B) Bear a legible label including generic and/or trade name and strength according to federal and state law;

(C) Be stored under appropriate conditions and in accordance with general or specific directions of a hospital pharmacist; and



(D) Be accessible only to those personnel authorized access by hospital policy.

(v) Outdated or deteriorated drugs, as indicated by label, shall be prohibited in patient care areas.

(vi) A hospital pharmacist shall be responsible for assuring appropriate disposition, destruction, and disposal of drugs intended for patient use in patient care areas.

(vii) Storage, distribution, record keeping, appropriate dissemination of information, and control of approved investigational drugs or medications used in the hospital shall be the responsibility of the pharmacist who directs hospital pharmacy.

(2) Patient care.

(a) Space or spaces of adequate size shall be designated on each nursing unit which has provisions for medical records, access to telephones, a place for recording and reviewing medical records, and provision for confidential communication among personnel and staff.

(b) Utility or materials room or rooms or space. On or adjacent to each nursing unit an adequate, properly equipped, utility or materials room shall be provided for the preparation, cleaning, and storage of nursing supplies and equipment used on the nursing unit. This utility or materials room shall be so arranged as to provide for separation of clean and soiled supplies and equipment.

(c) Toilet and bathing facilities.

(i) There shall be at least one water closet, lavatory, and bathing facility reserved for patient use on each patient floor, and such additional toilets, lavatories, and bathing facilities to adequately meet the needs of the patients.

(ii) Grab bars properly located and securely mounted shall be provided at patient bathing facilities and water closets.

(iii) Some means of signalling by the patient while in the toilet, tub, or shower room shall be provided in a proper location and shall provide an audio and/or visual signal in the nurses' station or an equivalent area.

(iv) A lavatory shall be provided in or convenient to every toilet room.

(v) Paper towels or some other acceptable type of single use towel and a satisfactory receptacle for used towels shall be provided at all lavatories.

(vi) Soap or equivalent shall be immediately available at sink or lavatory.

(d) Isolation room or unit. Rooms or units which are used for isolation of patients with known or suspected infectious diseases shall contain a lavatory.

(e) Seclusion and/or security room. When special accommodations are provided for seriously disturbed patients, the layout, design of details, equipment, and furnishings shall be such that patients are under close observation and are not afforded opportunities for hiding, escape, injury to self or others.

(f) Storage and handling of drugs in patient care areas.

(i) Medicines, poisons, and other drugs shall be stored in a specifically designated, well-illuminated, secure space. Drugs shall be accessible only to hospital authorized individuals. A means for separation of internal and external stock drugs shall be provided.

(ii) A separate locked drawer, compartment, cabinet, or safe shall be provided for the storage of Schedule II drugs.

(iii) Suitable facilities including ample light, ventilation, sink or lavatory, and sufficient work areas shall be provided for the preparation and storage of drugs for patients.

(g) Patient room facilities.

(i) All patient rooms shall be outside rooms with adequate windows of clear glass or other approved transparent material.

(ii) Single rooms shall contain at least eighty square feet and multi-bed rooms shall contain at least seventy square feet per adult bed and youth bed or crib, and forty square feet per pediatric bassinets.

(iii) Rooms shall have at least seven and one-half foot ceiling height over the required square feet area.

(iv) The floor of any room used for accommodation of a patient shall be less than three feet six inches below grade.

(v) There shall be at least three feet between beds.

(vi) Rooms shall be arranged to allow for movement of necessary equipment to the side of each bed.

(vii) There shall be sufficient and satisfactory storage space for clothing, toilet articles, and other personal belongings of patients.

(viii) Sufficient electrical outlets shall be provided to permit the use of electrical equipment as required.

(h) Patient room furnishings.

(i) An appropriate bed with mattress, pillow, and necessary coverings shall be provided for each patient. Mattresses, blankets, and pillows shall be clean and in good repair.

(ii) There shall be a bedside stand or cabinet and chair for use in each patient room, when appropriate.

(iii) Means for signalling nurses shall be provided within easy reach of each bed, when appropriate.

(iv) A sufficient number of cubicle curtains or screens shall be available to assure privacy for patients, when indicated.

(v) A properly designed bed lamp shall be provided at each bed, when appropriate.

(3) Supplies and equipment for patient care.

(a) There shall be sufficient, safe, and appropriately maintained equipment and supplies for patient care.

(b) Bedside utensils supplied to patients shall be for individual use only.

(c) All supplies and equipment used in patient care shall be properly cleaned and/or sterilized between use for different patients.

(d) Methods for cleaning, handling, and storing all supplies and equipment shall be such as to prevent the transmission of infection through use.

(e) Equipment and furnishings, including medical and nonmedical devices, shall be safe, located, and arranged in a manner which does not endanger patients.

[Statutory Authority: RCW 43.70.040, 91-02-049 (Order 121), recodified as § 246-318-190, filed 12/27/90, effective 1/31/91. Statutory Authority: RCW 43.20.050 and 70.41.030, 84-02-036 (Order 271), § 248-18-190, filed 12/30/83. Statutory Authority: RCW 43.20.050 and chapter 70.41 RCW, 81-22-014 (Order 216), § 248-18-190, filed 10/23/81; Order 119, § 248-18-190, filed 5/23/75; Regulation 18.190, effective 3/11/60.]

**WAC 246-318-200 Abuse reports—Children and developmentally disabled adults.** A suspected incident of nonaccidental injury, neglect, sexual abuse, or cruelty to a child or developmentally disabled person by a person who



appears to be legally responsible for that individual's welfare shall be reported to a law enforcement agency or the department.

(1) Practitioners obligated to report suspected abuse include licensed practical and registered nurses, physicians and their assistants, podiatrists, optometrists, chiropractors, dentists, social workers, psychologists, and pharmacists.

(2) The hospital shall make orientation materials, which inform practitioners of their reporting responsibilities, available to practitioners who are employees or who practice within the hospital. The department shall prepare and distribute these materials.

(3) The hospital shall post in each primary patient care unit notices provided by the department which include appropriate local police and department phone numbers and which state the reporting requirements.

(4) The medical record of the person who may have been abused by a responsible individual shall reflect the fact that an oral or written report has been made to the department or a law enforcement agency. This note shall contain the date and time that the report was made, the agency to which it was made, and be signed by the person making the report. The contents of the report need not be included in the medical record.

(5) Conduct conforming with reporting requirements of this section or chapter 26.44 RCW shall not be deemed a violation of the confidential communication privilege of RCW 5.60.060(3) and (4) and 18.83.110.

[Statutory Authority: RCW 43.70.040. 91-02-049 (Order 121), recodified as § 246-318-200, filed 12/27/90, effective 1/31/91. Statutory Authority: RCW 70.41.030. 78-08-060 (Order 162), § 248-18-202, filed 7/24/78.]

**WAC 246-318-210 Pediatric services.** (1) Hospitals admitting, treating, or diagnosing infants, children, and adolescents shall have readily available equipment and supplies of appropriate sizes including:

- (a) Intubation equipment;
- (b) Oxygen masks and ventilatory bags;
- (c) Blood pressure cuffs;
- (d) Stethoscope;
- (e) Defibrillator and paddles;
- (f) Emergency medications;
- (g) Intravenous equipment and supplies; and
- (h) Measuring devices for length, height, weight, and circumferences.

(2) Hospitals providing services for infants, children, and adolescents shall establish written policies and procedures specific to pediatric services, consistent with WAC 246-318-190 (2)(g), 246-318-200, and 246-318-435 and minimally including:

- (a) Admission criteria;
- (b) Conditions requiring transfer or transport;
- (c) Room assignment of infants and children considering requirements for observation and developmental age level needs;
- (d) Safety measures in terms of equipment, including but not limited to:
  - (i) Cribs, bassinets, and beds;
  - (ii) Restraint use;
  - (iii) Side rails;
  - (iv) Electrical outlet protection; and

(v) Toys.

(e) Placement of infants, children, and adolescents with infection, suspected infection, or exposure to infection;

(f) Nutritional guidelines for infants, children, and adolescents to include normal diets and diets for special nutritional needs;

(g) Safe administration of pediatric doses of blood, blood products, medications, intravenous fluids, and admixtures including:

- (i) Intake and output;
- (ii) Precalculated dosages of emergency drugs immediately available or posted;
- (iii) An established list of pediatric dosages approved by the hospital pharmacist and the physician responsible for medical policies in pediatric services;
- (iv) List of agents requiring double checking prior to administration; and
- (v) Hospital-approved method of double checking by appropriately licensed personnel or medical staff which include nurses, physicians, or pharmacists.

(3) Hospitals providing organized, distinct pediatric units or service areas shall provide and establish:

- (a) An accessible examination or treatment area;
- (b) A sufficient area for diversionary play activities;
- (c) Criteria and procedures for use of established areas for isolation;
- (d) Medical services directed by a physician member of medical staff having experience in treatment of infants, children, and adolescents whose functions and scope of responsibility are delineated by medical staff;

(e) Review of policies, procedures, protocols, and standing orders as necessary and at least every two years with revision as necessary;

(f) A registered nurse responsible for implementation of nursing policies and procedures;

(g) Adequate nursing staff for the pediatric unit or service area available to perform all the specialized nursing skills required.

(4) Hospitals providing nurseries in pediatric services or elsewhere in the hospital shall meet requirements for intermediate care nursery or neonatal intensive care nursery under WAC 246-318-230.

[Statutory Authority: RCW 70.41.030. 92-02-018 (Order 224), § 246-318-210, filed 12/23/91, effective 1/23/92. Statutory Authority: RCW 43.70.040. 91-02-049 (Order 121), recodified as § 246-318-210, filed 12/27/90, effective 1/31/91. Statutory Authority: RCW 70.41.030. 89-22-106 (Order 010), § 248-18-216, filed 11/1/89, effective 12/2/89.]

**WAC 246-318-220 Obstetrical services.** (1) Hospitals providing obstetrical services shall provide:

(a) Medical services directed by a physician member or members of the medical staff having experience in obstetrics and newborn care, whose functions and scope of responsibility are delineated by the medical staff;

(b) Adequate staff supervised by a registered nurse, prepared by education and experience in obstetrical and newborn care nursing;

(c) Capability for performing caesarean sections twenty-four hours per day.

(2) Hospitals providing obstetrical services shall establish written policies and procedures to include:

(a) Infection control principles under WAC 246-318-035 including:

- (i) Room assignment and placement of obstetrical patients and newborns;
  - (ii) Visitors;
  - (iii) Special clothing requirements for staff and visitors;
  - (iv) Handwashing, posted as appropriate;
  - (v) Isolation;
  - (vi) Employee health; and
  - (vii) Handling and storage of breast milk and formula.
- (b) Screening criteria to ascertain patients appropriate for each option of labor, delivery, postpartum, and newborn care;

(c) Provisions for transfer and transport of a woman or a newborn to obtain a more intensive level of medical and nursing care;

(d) Deliveries occurring outside the obstetrical service area or areas;

(e) Requirement for authentication of all orders, standing orders, and protocols with:

- (i) Delineation of the circumstances when a particular protocol is used;
- (ii) Provisions for notification of appropriate medical staff;

(iii) Description of minimum qualifications or training of persons required to execute a particular order or protocol;

(iv) Written approval of policies, standing orders, and protocols by appropriate representatives of the medical, nursing, and administrative staffs;

(v) Orders for drug or treatment administration including:

- (A) A description of the treatment with the name of each drug or agent;
- (B) The dosage and concentration of the drug or agent;
- (C) The route or method of administration; and
- (D) Where pertinent, the time interval, frequency, or duration of administration.

(f) Requirements for documenting orders and protocols in the patient's medical record;

(g) Provision for maintaining body heat of each newborn;

(h) Provision for intrapartum evaluation of fetal heart rate;

(i) Procedures and protocols for the management of obstetrical and newborn emergencies, including resuscitation;

(j) Review of policies, procedures, protocols, and standing orders as necessary and at least every two years with revisions if necessary; and

(k) Recordkeeping including, but not limited to:

- (i) Specific notes describing the status of mother, fetus, and newborn during labor, birth, and postpartum;
- (ii) Completion of birth and death certificates as necessary;
- (iii) Hospital staff's verification of initial and discharge identification of the newborn;

(iv) Documentation that the newborn screening test was obtained and forwarded, as required under RCW 70.83.020 and chapter 246-650 WAC, now or as hereafter amended;

(v) Documentation of newborn eye treatment, required under WAC 246-100-206, now or as hereafter amended; and

(vi) Medical records register or registers and index or indexes described under WAC 246-318-440.

(3) A hospital providing obstetrical services shall:

(a) Designate and maintain facilities and equipment for care of woman, fetus, and newborn either in:

(i) Labor rooms with birth occurring in a delivery room; or

(ii) Birthing rooms including labor, delivery, recovery and labor, delivery, recovery, post partum services; or

(iii) A combination of labor, delivery, and birthing rooms; or

(iv) Rooming-in, if provided.

(b) Locate any hospital room designated by the hospital as a labor room within the obstetrical service area;

(c) Utilize rooms designated by the hospital as labor rooms:

(i) For short-term patient occupancy of twenty-four hours or less; or

(ii) For patients in labor only unless the room meets the requirements for a patient room described under WAC 246-318-190.

(d) Maintain accommodations and environment in obstetrical delivery rooms, if present, including:

(i) Lighting and equipment for care of woman, fetus, and newborn during delivery including requirements described under WAC 246-318-290(2);

(ii) A minimum area of two hundred and seventy square feet with a minimum linear dimension of fifteen feet; and

(iii) A minimum room temperature of at least sixty-eight degrees Fahrenheit with a reliable method for monitoring temperature.

(e) Maintain systems for scrub up, clean up, sterilization, storage, housekeeping, and staff change room facilities; and

(f) Meet requirements described under WAC 246-318-300 and 246-318-310 for anesthesia and post-anesthesia recovery.

(4) Hospitals providing birthing or delivery services shall provide sufficient and appropriate area in rooms to accommodate not only patients, staff, and designated attendants, but also furnishings and equipment for the care of the woman, fetus, and newborn including:

(a) Adequate and appropriate equipment and supplies as follows:

(i) A bed or equivalent suitable for labor, birth, and post partum;

(ii) Oxygen with individual flow meters and mechanical suction for woman and newborn;

(iii) Newborn resuscitation bag, masks, endotracheal tubes, laryngoscopes, oral airways, and mechanical suction in the room for each birth;

(iv) Emergency equipment, medications, and supplies for care of newborn and woman required under WAC 246-318-290 (2)(b)(ii);

(v) Newborn beds available;

(vi) Radiant heat source available for the newborn;

(vii) General lighting source and provision for examination lights;

(viii) A clock with a sweep hand or equivalent second indicator visible from each patient's bedside;

(ix) Provision for receiving, covering, and transporting soiled linens and waste materials;

(x) Appropriate storage for necessary linens, instruments, supplies, medications, and equipment;

- (xi) Work surfaces;
- (xii) A signal device for use by staff and accessible to summon emergency back-up personnel when needed;
- (xiii) Emergency power for lighting and operation of equipment;

(xiv) Easily cleanable floors, walls, cabinets, ceilings, and furnishings; and

(xv) Fetal monitoring equipment.

(b) Additional requirements if birthing rooms are provided including:

(i) A lavatory located within each birthing room;

(ii) A designated lavatory and water closet conveniently located for use of patient and support person or persons;

(iii) A bathing facility convenient for patient use;

(iv) Wardrobe unit or closets in the vicinity for the belongings of the patient and her support person or persons;

(v) A signaling device accessible for each woman; and

(vi) Room temperature of at least sixty-eight degrees Fahrenheit maintained with a reliable method for monitoring.

(5) Hospitals may use an operating room as a delivery room if the hospital has established policy and procedures about use of operating rooms including establishing priority over routine obstetrical procedures and nonemergent surgical procedures for:

(a) Patients with parturition imminent;

(b) Patients with obstetrical emergencies requiring immediate medical intervention to preserve life and health of woman and infant.

(6) Any hospital providing obstetrical services shall provide appropriate newborn care including, but not limited to:

(a) Devices for measuring weight, length, and circumference;

(b) Access to and availability of portable x-ray;

(c) Provisions for stabilization, transfer, and transport of high-risk newborns and infants;

(d) An established system to identify newborns prior to separation from mother;

(e) Established policies and procedures minimally including:

(i) Ongoing clinical assessment of newborn or infant;

(ii) Provisions for direct supervision of each newborn by nursing staff and family in a nonpublic area, considering:

(A) Physical well being;

(B) Safety; and

(C) Security, including prevention from abduction.

(f) Access to oxygen, oxygen analyzers, warmed and humidified oxygen, resuscitation equipment, emergency equipment, measuring devices, mechanical suction, medical air and supplies specifically for infants and newborns.

(7) Hospitals with a newborn and infant nursery shall provide services, facilities, and equipment including:

(a) Requirements in subsection (6) of this section;

(b) Wall clock with sweep second hand or equivalent second indicator visible from each nursery room;

(c) Oxygen source with provision for warming, humidifying, analyzing, and blending oxygen;

(d) A nursery room or rooms with at least twenty square feet per bassinets and with sufficient room to move between bassinets;

(e) Handwashing facilities located at the entrance to the nursery and in each nursery room;

(f) Emergency call systems from the nursery to another nearby appropriately staffed area;

(g) A system to maintain an environmental temperature of at least sixty-eight degrees Fahrenheit; and

(h) Appropriate emergency equipment, medications, and supplies for infant care and as required under WAC 246-318-290 (2)(b).

[Statutory Authority: RCW 70.41.030. 92-02-018 (Order 224), § 246-318-220, filed 12/23/91, effective 1/23/92. Statutory Authority: RCW 43.70.040. 91-02-049 (Order 121), recodified as § 246-318-220, filed 12/27/90, effective 1/31/91. Statutory Authority: Chapter 70.41 RCW. 90-12-014 (Order 061), § 248-18-221, filed 5/30/90, effective 6/30/90. Statutory Authority: RCW 70.41.030. 89-22-106 (Order 010), § 248-18-221, filed 11/1/89, effective 12/2/89.]

**WAC 246-318-230 Intermediate care nursery service—Neonatal intensive care nursery service.** (1) Hospitals providing intermediate care nursery services or neonatal intensive care nursery services or both shall meet requirements described under WAC 246-318-220 (6) and (7).

(2) Additional requirements for hospitals providing intermediate care nursery service include:

(a) Infant stations having adequate space within each station to accommodate equipment, supplies, and staff required for treatment of intermediate care infants;

(b) Provision for emergency power to support equipment requirements for each infant station;

(c) Oxygen, air, and suction capabilities including:

(i) One oxygen outlet in each infant station with other sources of oxygen available;

(ii) One medical air source available for each infant station;

(iii) Provision for blending, warming, humidifying, and monitoring oxygen mixtures; and

(iv) One electrical-mechanical or pneumatic suction in each infant station with other mechanical suctions available in the hospital.

(d) All equipment and supplies for infant resuscitation immediately available and present within the intermediate care nursery service area;

(e) One cardiorespiratory monitor in the intermediate care nursery area and others available;

(f) Sufficient micro-volumetric infusion pumps available;

(g) A waiting and instruction area available;

(h) A registered nurse responsible for neonatal nursing and implementation of policies;

(i) Provision of adequate nursing staff for the intermediate care nursery available to perform all the specialized nursing skills required;

(j) Laboratory, pharmacy, radiological, and respiratory care services appropriate for infants available at all times and in the hospital during assisted ventilation;

(k) Medical staff with experience in neonatal medicine available at all times during assisted ventilation;

(l) A physician with experience in neonatal medicine who is continuously available to come to the hospital as required;

(m) Medical services directed by a physician member or members of the medical staff having experience in neonatal intensive care whose functions and scope of responsibility are delineated by the medical staff;

(n) Requirements for authentication of all orders, standing orders, and protocols when used with:

(i) Delineation of the circumstances when a particular protocol is used;

(ii) Provision of notification of appropriate medical staff;

(iii) Description of minimum qualifications or training of persons required to execute a particular order or protocol;

(iv) Written approval of policies, standing orders, and protocols by appropriate members of the medical, nursing, and administrative staffs;

(v) Orders for drug or treatment administration including:

(A) A description of the treatment with the name of each drug or agent;

(B) The dosage and concentration of the drug or agent;

(C) The route or method of administration; and

(D) Where pertinent, the time interval, frequency, or duration of administration.

(vi) Review of policies, procedures, protocols, and standing orders at least every two years with revisions as necessary.

(o) A hospital-approved procedure for double checking certain drugs, biologicals, and agents by appropriately licensed personnel or medical staff including nurses, physicians, and pharmacists.

(3) Hospitals providing neonatal intensive care nursery service shall meet requirements described under WAC 246-318-220(6) and subsection (2) of this section, and additionally provide:

(a) At least fifty square feet within each infant station;

(b) Twelve electrical outlets, with at least eight clearly identified as being on emergency power, available in each infant station;

(c) Oxygen, air, and suction capabilities including:

(i) Two separate oxygen outlets in each infant station;

(ii) Two medical air outlets in each infant station;

(iii) One mechanism for blending oxygen and medical air for each infant station;

(iv) Sufficient numbers of oxygen analyzers available to continuously monitor oxygen;

(v) A means for warming, humidifying, and monitoring temperature of oxygen mixtures on a continuous basis; and

(vi) Two electrical-mechanical or pneumatic suction in each infant station with others available if needed.

(d) All equipment and supplies for infant resuscitation available and present within the neonatal intensive care nursery service area;

(e) Continuous ventilatory support equipment available at all times;

(f) Equipment for continuous monitoring of respirations and heart rate in each infant station;

(g) Equipment for continuous hemodynamic monitoring and status of oxygenation available;

(h) Equipment for continuous monitoring of body temperature available;

(i) Sufficient microvolumetric infant infusion pumps immediately available at all times in the neonatal intensive care nursery service area;

(j) Laboratory, radiology, and respiratory care and pharmacy services appropriate for neonates and infants available in the hospital at all times;

(k) Twenty-four-hour availability of an anesthesia services and a pharmacist to come to the hospital as required or requested available at all times;

(l) Provision of a registered nurse responsible for neonatal intensive care nursery services and implementation of policies;

(m) Provision of sufficient and adequate nursing staff in the neonatal intensive care nursery service to perform all specialized nursing skills required;

(n) Medical responsibility for intensive care nursery services by a neonatologist member of the medical staff;

(o) Twenty-four-hour availability of a neonatologist to come for in-house consultation as required or requested;

(p) A designated physician in the hospital available at all times to the neonatal intensive care nursery service with experience or skills including:

(i) Neonatal and infant resuscitation; and

(ii) Ventilator management including chest tube placement.

(q) Standing orders, protocols, patient discharge/transfer plans and evaluation of neonatal intensive care nursery services meeting requirements under subsection (2) of this section and WAC 246-318-220 (6)(c);

(r) Provision for referral or arranging for social work services as required; and

(s) Provision for patient access to other services as required.

[Statutory Authority: RCW 70.41.030, 92-02-018 (Order 224), § 246-318-230, filed 12/23/91, effective 1/23/92. Statutory Authority: RCW 43.70.040, 91-02-049 (Order 121), recodified as § 246-318-230, filed 12/27/90, effective 1/31/91. Statutory Authority: RCW 70.41.030, 89-22-106 (Order 010), § 248-18-224, filed 11/1/89, effective 12/2/89.]

**WAC 246-318-240 Critical care service.** Hospitals providing any critical care service shall provide:

(1) An electrocardiographic monitor with an oscilloscope, a rate meter connected to a recorder, and an audio alarm system for each bed used for critical care;

(2) Equipment and supplies in the critical care area or available in the hospital for use in the area appropriate to meet patient needs consistent with the nature and scope of critical care services defined by the hospital including:

(a) Twelve lead electrocardiographs;

(b) Tracheostomy set;

(c) Infusion pumps dedicated for use in critical care;

(d) Gastric suction equipment;

(e) External and internal pacemaker insertion equipment and supplies;

(3) Emergency medical supplies and equipment available to critical care within sixty seconds including:

(a) Direct current defibrillator with synchronization capabilities;

(b) Intubation supplies and equipment;

(c) Emergency cart with appropriate drugs and supplies;

(d) Chest tube insertion supplies;

(e) Intravenous, intra-arterial, and central venous access supplies consistent with the nature and scope of critical care services offered;

(4) Adequate, accessible, available means of administering oxygen, medical air, and continuous ventilatory support and providing suction;

(5) Electrical capacity and outlets sufficient to accommodate electrical equipment at each bedside, with emergency power for lighting and critical care equipment;

(6) A communication system within the area for:

(a) Patients to summon assistance for routine patient care; and

(b) Summoning appropriate personnel in emergencies;

(7) Movable beds with:

(a) A secure braking and locking device;

(b) Easily adjustable positioning to meet patient needs;

(c) The head of the bed easily accessible for resuscitation and/or other emergency procedures; and

(d) Removable head board or equivalent;

(8) Written policies and procedures established and implemented pertinent to patient care within the critical care service area which are:

(a) Made known to hospital and medical staff; and

(b) Readily available to all persons functioning within the area;

(9) Medical oversight or direction in the critical care service area by a physician member of the medical staff with functions and responsibilities delineated by the hospital governing body and medical staff bylaws;

(10) Description of all physicians' privileges and responsibilities for patients within the critical care unit;

(11) Written hospital policies and procedures established and implemented including:

(a) Criteria and priorities for admission, discharge, and transfer of patients;

(b) A requirement for a physician's examination of each patient immediately prior to admission to the critical care unit or as soon as possible thereafter as defined by the hospital;

(c) Delivery of patient care minimally including:

(i) The use of specialized medical equipment;

(ii) The performance of specific patient care procedures;

and

(iii) The delineation of who may perform which procedures;

(d) Protocols to guide the actions of personnel when a medical emergency is imminent or arises and a physician is not present;

(e) Visitor and traffic control in the critical care area; and

(f) The role of the critical care area in the hospital disaster plans;

(12) At least two nursing personnel skilled and trained in care of critical care patients on duty in the hospital at all times and:

(a) Immediately available to provide care to patients admitted to the critical care area;

(b) Trained and current in cardiopulmonary resuscitation;

(c) Including at least one registered nurse with:

(i) Training in the safe and effective use of the specialized equipment and procedures employed in the particular area; and

(ii) Successful completion of an advanced cardiac life support training program as defined and approved by the hospital or certified by the American Heart Association unless other personnel certified in advanced life support by

the American Heart Association are immediately available to critical care.

[Statutory Authority: RCW 43.70.040. 91-02-049 (Order 121), recodified as § 246-318-240, filed 12/27/90, effective 1/31/91. Statutory Authority: RCW 70.41.030. 90-24-044 (Order 115), § 248-318-240, filed 11/30/90, effective 12/31/90.]

**WAC 246-318-250 Renal dialysis services.** Hospitals providing renal dialysis services shall:

(1) Reuse dialyzers only when the cleaning and sterilization procedure meets guidelines under Association for Advancement of Medical Instrumentation (AAMI), July 1986, "Recommended Practices for Re-use of Hemodialyzers";

(2) Provide adequate space for:

(a) Equipment and supplies necessary for the dialyzing patient;

(b) Preparation of materials necessary for dialysis; and

(c) Cleaning and disinfecting equipment;

(3) Provide water treatment, if necessary to ensure water quality, meeting recommendations under AAMI guidelines under subsection (1) of this section;

(4) Test water for bacterial contamination monthly and chemical purity as required under AAMI, July 1986;

(5) Test dialysis machine for bacterial contamination monthly or demonstrate a quality assurance program establishing effectiveness of disinfection methods and intervals;

(6) Take appropriate measures to prevent contamination, including backflow prevention under chapter 246-290 WAC, between:

(a) Dialysis machines;

(b) Dialysis machines and potable water supply; and

(c) Dialysis machine, drain line, and sewer;

(7) Provide for the availability of any special dialyzing solutions required by a patient;

(8) Meet requirements under WAC 246-318-010 through 246-318-450.

[Statutory Authority: RCW 70.41.030. 92-02-018 (Order 224), § 246-318-250, filed 12/23/91, effective 1/23/92. Statutory Authority: RCW 43.70.040. 91-02-049 (Order 121), recodified as § 246-318-250, filed 12/27/90, effective 1/31/91. Statutory Authority: RCW 70.41.030. 90-24-044 (Order 115), § 248-318-250, filed 11/30/90, effective 12/31/90.]

**WAC 246-318-260 Long-term care services.** (1) Hospitals providing inpatient long-term care services shall:

(a) Meet requirements under WAC 246-318-190;

(b) Require an assessment of each patient by a registered nurse upon admission to determine immediate care needs;

(c) Require documentation of the initial plan of care in the patient's medical record;

(d) Make the plan of care accessible to direct caregivers who have a need to know in order to provide actual health care services to the patient;

(e) Establish a plan of care individualized to the needs of each patient and:

(i) Developed by those disciplines involved in a patient's care;

(ii) Implemented in conjunction with a registered nurse responsible for total care of the patient for the duration of hospitalization in a long-term care service unit or area; and

(iii) Maintained in a confidential manner;

(f) Require a physician's order for use of any physical restraint restricting freedom of movement or position change, including the specific reason, type, and location of restraint, and:

(i) Establish and follow a policy on release of patients from physical restraints for specified intervals and monitoring of patients in restraints;

(ii) Require documentation in a patient's medical record of patient's restraint - release time intervals;

(iii) Document reason for use of any restraint on a patient in the patient care plan.

(2) Hospitals providing long-term care shall establish written policies and procedures specifying:

(a) Rights of patients including:

(i) Informing each patient of individual rights at the time of admission;

(ii) Documenting evidence of informing a legally delegated person about a patient's rights when a patient is unable to receive and understand the information;

(b) A mechanism to:

(i) Identify social and emotional needs of the patients;

(ii) Refer patients in need of social services to appropriate social agencies.

(3) Hospitals with inpatient long-term care services shall provide:

(a) An activities program designed to encourage each long-term care patient to maintain or attain normal activity and achieve an optimal level of independence;

(b) A community dining area;

(c) Handrails on both sides of all patient access corridors;

(d) Patient bathrooms and toilets arranged to accommodate wheelchair patients;

(e) A shower stall accommodating a shower chair on the same level and convenient to patient rooms.

(4) Hospitals providing long-term care services and permitting pets shall:

(a) Require and provide for humane care and maintenance of pets under conditions prohibiting animals, except for fish in an aquarium, in rooms or areas for:

(i) Food storage and preparation;

(ii) Group dining areas during the times food is served and consumed;

(iii) Cleaning and storage of cooking and eating utensils;

(iv) Linen storage or laundry;

(v) Drug or sterile supply storage; and

(vi) Patient bedrooms if the condition of a patient in the room contraindicates the presence of the animal;

(b) Permit seeing eye, hearing, and assistance dogs as needed;

(c) Provide reasonable opportunity for a patient to have regular contact with animals, if the patient desires;

(d) Consider preferences of the long-term care patients through a long-term care resident council, poll, or other means;

(e) Ensure the presence of animals does not compromise the rights, preferences, and medical requirements of individual patients;

(f) Permit animals such as dogs, cats, fish, gerbils, hamsters, guinea pigs, and birds;

(g) Require veterinarian certification of psittacine birds certified free of psittacosis or other diseases and meeting

United States Department of Agriculture (USDA) quarantine procedures;

(h) Require regularly scheduled veterinarian examinations and appropriate immunizations for animals living on the premises, with records retained in the hospital;

(i) Keep animals living on the premises clean and free of external parasites such as fleas and ticks.

[Statutory Authority: RCW 70.41.030. 92-02-018 (Order 224), § 246-318-260, filed 12/23/91, effective 1/23/92. Statutory Authority: RCW 43.70.040. 91-02-049 (Order 121), recodified as § 246-318-260, filed 12/27/90, effective 1/31/91. Statutory Authority: RCW 70.41.030. 90-24-044 (Order 115), § 248-318-260, filed 11/30/90, effective 12/31/90.]

**WAC 246-318-270 Alcoholism and/or substance abuse unit.** (1) Definitions specific to WAC 246-318-270 and 246-318-810:

(a) "Alcoholism" means an illness characterized by lack of control as to the consumption of alcoholic beverages, or the consumption of alcoholic beverages to the extent an individual's health is substantially impaired or endangered, or his or her social or economic function is substantially disrupted.

(b) "Alcoholism counselor" means an individual with adequate education, experience, and knowledge regarding the nature and treatment of alcoholism, who is knowledgeable about community resources providing services alcoholics may need, and who knows and understands the principles and techniques of alcoholism counseling with minimal requirements to include:

(i) No history of alcohol or other drug misuse for a period of at least two years immediately prior to time of employment as an alcoholism counselor with no misuse of alcohol or other drugs while employed as an alcoholism counselor;

(ii) A high school diploma or equivalent;

(iii) Satisfactory completion of at least twelve quarter or eight semester credits from a college or university, including at least six quarter credits or four semester credits in specialized alcoholism courses exclusive of field experience credits.

(c) "Detoxification" means care or treatment of an intoxicated person during a period in which the individual recovers from the effects of intoxication.

(i) "Intoxication" means acute alcohol poisoning or temporary impairment of an individual's mental or physical functioning caused by alcohol in the body.

(ii) "Acute detoxification" means a method of withdrawing a patient from alcohol where nursing services are available and medications are routinely administered to facilitate the patient's withdrawal from alcohol.

(d) "Family" means individuals important to and designated by a patient who need not be relatives.

(e) "Individualized treatment plan" means a written statement of care to be provided for a patient based upon assessment of his or her strengths and physical and psychosocial problems. When appropriate, the statement shall be developed with participation of the patient.

(f) "Multidisciplinary treatment team" means a group comprised of individuals from the various treatment disciplines and clinical services who assess, plan, implement, and evaluate treatment for patients under care.



(2) Rules and regulations in this chapter shall apply with addition of the following:

(a) There shall be a room adequate for counseling and social activities of patients.

(b) Adequate provision for space and privacy shall be made for interviewing, group and individual counseling, and physical examinations.

(c) Policies and procedures shall include and address, as appropriate:

(i) Development, implementation, and review of the individualized treatment plan, including the participation of the multidisciplinary treatment team, the patient, and the family, as appropriate.

(ii) Patient rights to include:

(A) Treatment and care of patients in a manner promoting dignity and self-respect;

(B) Protection from invasion of privacy: *Provided*, That reasonable means may be used to detect or prevent contraband from being possessed or used on the premises;

(C) Confidential treatment of clinical and personal information in communications with individuals not associated with the plan of treatment;

(D) A means of implementing federal requirements related to confidentiality of records, Title 42, Code of Federal Regulations, Part 2, Federal Register, July 1, 1975;

(E) Provision of reasonable opportunity to practice religion of choice insofar as such religious practice does not infringe upon rights and treatment of others or the treatment program: *Provided*, That the patient also has the right to refuse participation in any religious practice.

(F) Communication with significant others in emergency situations.

(G) Freedom from physical abuse or other forms of abuse against patient's will, including being deprived of food, clothes, or other basic necessities.

(iii) Patient work assignments related to treatment program, if applicable.

(d) Personnel, staff, other services.

(i) Clinical responsibility for alcoholism and substance abuse units shall be assigned to an individual having demonstrated experience in this type of treatment and care. This individual shall be designated and function as specified by the governing body.

(ii) There shall be on staff at least one alcoholism counselor and such additional alcoholism counselors as necessary to provide alcoholism counseling services needed by patients.

(iii) There shall be a licensed nurse on duty on the unit whenever acute detoxification is taking place on the unit.

[Statutory Authority: RCW 70.41.030. 92-02-018 (Order 224), § 246-318-270, filed 12/23/91, effective 1/23/92. Statutory Authority: RCW 43.70.040. 91-02-049 (Order 121), recodified as § 246-318-270, filed 12/27/90, effective 1/31/91. Statutory Authority: RCW 70.41.030 and 43.20.050. 84-22-003 (Order 277), § 248-18-235, filed 10/26/84.]

#### WAC 246-318-280 Psychiatric units and services.

##### (1) Definitions.

In addition to definitions in WAC 246-318-010, the following words and phrases are defined for the purpose of this section and WAC 246-318-820 unless the context clearly indicates otherwise.

(a) "Acutely mentally ill" means a condition limited to a short-term severe crisis episode of:

(i) A mental disorder, meaning any organic, mental, or emotional condition having substantial adverse effects on an individual's cognitive or volitional functions;

(ii) Suicidal or self-destructive behavior;

(iii) Actual or threatened behavior harmful to others;

(iv) Behavior which caused substantial damage to property; or

(v) Being gravely disabled, meaning a condition in which a person, as a result of a mental disorder:

(A) Is in danger of serious physical harm resulting from a failure to provide for his or her essential human needs of health and safety; or

(B) Manifests severe deterioration in routine functioning evidenced by repeated and escalating loss of cognitive or volitional control over his or her actions and is not receiving care essential for his or her health or safety.

(b) "Child" or "children" means children and adolescents seventeen years of age or younger.

(c) "Child psychiatrist" means a physician, board-certified or board-eligible in child psychiatry under:

(i) The directory of residency training programs accredited by the accreditation council for graduate medical education, American Medical Association, 1981-82; or

(ii) The American Osteopathic Association Yearbook and Directory, American Osteopathic Board of Neurology and Psychiatry, 1981-82.

(d) "Child mental health specialist" means a mental health professional with:

(i) A minimum of one hundred actual, rather than semester, hours of specialized training devoted to a study of child development and the treatment of children; and

(ii) The equivalent of one year full-time experience in the treatment of children under supervision of a child mental health specialist.

(e) "Consultation" means review and recommendations regarding patient care and treatment programs.

(f) "Family" means individuals important to and designated by a patient, who need not be relatives.

(g) "Individualized treatment plan" means a written statement of care planned for a patient based upon assessment of the patient's developmental, biological, psychological, and social strengths and problems, and including:

(i) Treatment goals, with time frames stipulated;

(ii) Specific services utilized;

(iii) Designation of individual responsible for specific service provided;

(iv) Discharge criteria with estimated timeframes; and

(v) Participation of the patient and the patient's designee as appropriate.

(h) "Least restrictive alternative" means the setting, environment, or service in which the individual functions at maximum independence.

(i) "Mental health professional" or "MHP" means:

(i) A psychiatrist;

(ii) A psychiatric nurse, social worker, physician, or psychologist; or

(iii) A person with at least a masters degree in behavioral sciences, nursing science, or related field from an accredited college or university and two years experience in direct



treatment of mentally ill individuals under the supervision of a mental health professional.

(j) "Multidisciplinary treatment team" means a group comprised of individuals from various disciplines and clinical services who assess, plan, implement, and evaluate treatment for patients.

(k) "Psychiatric nurse" means a registered nurse with:

(i) A bachelors degree from an accredited college or university and at least two years experience in direct treatment of mentally ill or emotionally disturbed persons with such experience gained under supervision of a psychiatrist or psychiatric nurse; or

(ii) Three years experience in the direct treatment of mentally ill or emotionally disturbed persons with such experience gained under the supervision of a psychiatrist or psychiatric nurse.

(l) "Psychiatric service" means admission of patients with primary psychiatric diagnoses for treatment pertinent to the psychiatric diagnosis in any available bed in the hospital whether or not the hospital maintains a psychiatric unit.

(m) "Psychiatric unit" means a nursing unit specifically reserved for the care of individuals with primary psychiatric diagnoses.

(n) "Recreational therapist" means an individual:

(i) With a bachelors degree including a major or option in therapeutic recreation or recreation for the ill and handicapped; and

(ii) Preferably certified or certification-eligible under Certification Standards for Therapeutic Recreation Personnel, June 1, 1988, National Council for Therapeutic Recreation Certification, 49 South Main Street, Suite 005, Spring Valley, New York 10977.

(2) Hospitals with psychiatric units shall provide a therapeutic environment to maintain safe, secure, adequate care of acutely mentally ill persons including:

(a) Access to at least one seclusion room;

(b) Provisions for close observation of patients including provision of security windows or maximum security windows and relites appropriate to the area and program;

(c) Adequate space suitably equipped including:

(i) A day room on the unit;

(ii) Dining and therapeutic program activities either on the unit or elsewhere in the hospital appropriate to meet each patient's needs;

(iii) Space for physical and recreational activities of patients on the hospital premises; and

(iv) One area permitted to accommodate functions in (c)(i), (ii), and (iii) of this subsection if scheduled appropriately.

(d) An examination or treatment room available within the hospital;

(e) Space and privacy for interviewing, group and individual counseling, and patient and family visiting; and

(f) Separate patient sleeping rooms for children and adults.

(3) Hospitals providing a psychiatric unit shall:

(a) Provide adequate staff to implement individualized treatment plans;

(b) Assign and designate responsibility for the psychiatric unit programming to a mental health professional;

(c) Designate a psychiatrist with medical staff privileges, available for ongoing psychiatric unit consultation;

(d) Have a physician and mental health professional available for consultation and communication with each patient and the unit staff on a twenty-four hour per day, seven day a week basis;

(e) Employ a full-time psychiatric nurse responsible for nursing care;

(f) Designate staff or contract with persons or agencies responsible for:

(i) Provision of social work services with consultations by a social worker experienced in working with mentally ill patients;

(ii) Provision of occupational therapy services with the ongoing input of an occupational therapist experienced in working with mentally ill patients;

(iii) Provision of recreational therapy services with the ongoing input of a recreational therapist experienced in working with mentally ill patients; and

(iv) Providing access to psychological evaluation by or under direction of a psychologist.

(g) Provide documented staff training relating to the needs of psychiatric patients for all psychiatric unit personnel including:

(i) The utilization of least restrictive alternatives;

(ii) Methods of patient care;

(iii) Managing assaultive and self-destructive behavior;

(iv) Patient rights under chapters 71.05 and 71.34 RCW;

(v) The special needs of children, minorities, the elderly, and handicapped when appropriate.

(h) For hospitals providing a child or adolescent psychiatric unit:

(i) Assign and designate responsibility for the child and adolescent psychiatric unit programming to a child mental health specialist;

(ii) Designate a child psychiatrist with medical staff privileges available for ongoing input and consultation to the child and adolescent psychiatric unit;

(iii) Have a physician and child mental health specialist available for consultation and communication with each patient and unit staff on a twenty-four hour per day, seven days per week basis;

(iv) Employ a full-time psychiatric nurse meeting requirements of a child mental health specialist under subsection (1)(d) of this section responsible for nursing care;

(v) Designate staff or contract with persons or agencies responsible for:

(A) Provision of social work services with consultation and ongoing input by a social worker experienced in working with mentally ill children and adolescents;

(B) Provision of occupational and recreational therapy services as required under (f)(ii) and (iii) of this subsection;

(C) Provision of access to psychological evaluation as required under (f)(iv) of this subsection;

(D) Provision of documented staff training as required under (g) (i) through (v) of this subsection; and

(E) Provision of educational services.

(4) Hospitals providing psychiatric units shall establish and implement written policies and procedures including:

(a) Provision or arrangement for the care and treatment of acutely mentally ill patients;

(b) Informing patients of their rights as required under chapters 71.05 and 71.34 RCW;

(c) Posting of patient rights in prominent locations;

(d) Development of an initial individualized treatment plan for each patient within twenty-four hours of admission;

(e) Continued development of the individualized treatment plan within seventy-two hours of admission, excluding holidays, by a multidisciplinary treatment team, the patient, family, and other agencies as appropriate;

(f) Provision of or arrangement for appropriate services including:

(i) Psychological evaluation and services;

(ii) Social work services;

(iii) Occupational therapy services;

(iv) Recreational therapy services; and

(v) Other specialized services as appropriate;

(g) Completion of a physical examination and history by a member of the medical staff and an evaluation by a mental health professional within twenty-four hours of admission with consultation of a psychiatrist as indicated;

(h) Admission, retention and transfer criteria, based upon health and safety needs of patients, including a referral and transfer mechanism for persons in need of care and not meeting the admission criteria;

(i) Continuity of care, coordination and integration of services, including discharge planning consistent with WAC 246-318-450;

(j) Prohibiting use of patients to perform basic maintenance of the hospital and equipment, housekeeping, or food service except when tasks are:

(i) Included in and appropriate to the individualized treatment plan; and

(ii) Performed under direct supervision.

(k) Appropriate response to assaultive, self-destructive, or out-of-control behavior including the use of seclusion and restraints and subject to the following conditions:

(i) Use of seclusion and restraints only to the extent and duration necessary to ensure the safety of patients, staff, and property;

(ii) Infliction of physical pain for punitive purposes is prohibited, regardless of whether or not objective damage occurs;

(iii) All assaultive incidents documented in the medical record;

(iv) Staff observation of any patients in restraint or seclusion at least every fifteen minutes with:

(A) Interventions as indicated and required; and

(B) Observations and interventions recorded in the medical record;

(v) Notification of and authorization by a physician within one hour for emergency use of patient restraint or seclusion and including:

(A) Physician examination of the patient and renewal of physician order for every twenty-four continuous hours of restraint and seclusion; and

(B) Patient evaluation by a mental health professional or registered nurse when secluded or restrained more than two continuous hours with repeat evaluation at least one time every eight hours thereafter.

(l) Notification of the family and other agencies as appropriate as soon as possible, in event of:

(i) Serious injury or physical illness of the patient;

(ii) Death of the patient; or

(iii) Disappearance of the patient.

(m) For hospitals providing child or adolescent psychiatric units:

(i) Requirements under (a) through (l) of this subsection except:

(A) Substitute for (g) of this subsection - completion of a physical examination and history by a member of the medical staff and an evaluation by a child mental health specialist within twenty-four hours of admission with consultation by a child psychiatrist as indicated; and

(B) In (k)(v)(B) of this subsection, require patient evaluation by a child mental health specialist every two hours when a child is secluded or restrained.

(ii) Evaluation by a child mental health specialist within twenty-four hours of admission including consultation with a child psychiatrist as indicated;

(iii) Requirement for designated staff to make and document a determination of the hospital's ability to safely care for each child; and

(iv) Coordination with appropriate educational agencies, as appropriate.

(5) Hospitals with psychiatric units or psychiatric services shall maintain a medical records system required under WAC 246-318-440 and require diagnoses, abbreviations, and terminology consistent with the "American Psychiatric Association Diagnostic and Statistical Manual of Mental Disorders," III R edition, 1987, and "International Classification of Diseases," 9th edition, 1989.

(6) Hospitals with psychiatric units or services shall establish and implement policies and procedures to protect patient confidentiality and release of records and information consistent with requirements under chapters 71.05 and 71.34 RCW.

(7) Hospitals providing any inpatient psychiatric service shall establish and implement written policies and procedures including:

(a) Provision of a therapeutic environment to maintain safe, secure, adequate care of acutely mentally ill patients;

(b) Provision of facilities appropriate to the scope of the psychiatric service;

(c) Designation of responsibility for psychiatric services programming to a mental health professional;

(d) Provision for close observation of patients with a security room available;

(e) Designation of a psychiatrist with medical staff privileges available for consultation;

(f) A physician and mental health professional available on staff or by contract for consultation and communication with the patient and the hospital staff on a twenty-four hour per day, seven day a week basis;

(g) Designation of a staff person responsible for developing a plan for arranging needed special services as identified in the individualized treatment plan for each patient;

(h) Employment of a registered nurse with experience and/or specialized education in psychiatric nursing responsible for nursing care twenty-four hours a day;

(i) Designation of a staff person responsible for arranging for social work services;

(j) Provision for transfer to a hospital with a psychiatric unit or appropriate psychiatric services within twenty-four hours when the hospital is unable to establish and implement procedures required under (a) through (i) of this subsection.

(k) Designating staff responsible for documented training relating to the needs of psychiatric patients for all personnel responsible for care of psychiatric patients including:

- (i) The availability and utilization of the least restrictive alternatives;
  - (ii) Methods of patient care;
  - (iii) Managing assaultive and self-destructive behavior;
  - (iv) The special needs of children, minorities, the elderly, and handicapped as appropriate;
  - (v) Patient rights under chapters 71.05 and 71.34 RCW.
- (l) Implementation of requirements in subsection (4) of this section except requirement for recreational or occupational therapy services under subsection (4)(f)(iii) and (iv) of this section;
- (m) For hospitals providing any child or adolescent psychiatric services, with or without a psychiatric unit:
- (i) All requirements under (a) through (l) of this subsection apply;
  - (ii) Establish and implement policy and procedures for age and behavior specific criteria in determining appropriate room assignment.

[Statutory Authority: RCW 70.41.030. 92-02-018 (Order 224), § 246-318-280, filed 12/23/91, effective 1/23/92. Statutory Authority: RCW 43.70.040. 91-02-049 (Order 121), recodified as § 246-318-280, filed 12/27/90, effective 1/31/91. Statutory Authority: RCW 70.41.030. 90-23-012 (Order 113), § 248-18-240, filed 11/13/90, effective 12/14/90. Statutory Authority: RCW 70.41.030 and 43.20.050. 83-19-058 (Order 269), § 248-18-240, filed 9/20/83. Statutory Authority: RCW 43.20.050 and chapter 70.41 RCW. 81-22-014 (Order 216), § 248-18-240, filed 10/23/81; Order 119, § 248-18-240, filed 5/23/75; Regulation 18.240, effective 3/11/60.]

**WAC 246-318-290 Surgery—Operating rooms and areas—Special procedure rooms—Surgical treatment or diagnostic areas.** (1) Operating rooms, facilities, personnel, equipment, policies and procedures shall be appropriate to the scope of surgical services offered in each hospital.

(2) Environment - facilities - equipment.

(a) Operating room facilities and services, when provided, shall be located in a segregated area or areas of the hospital with access limited by hospital policy and procedures.

(b) Operating rooms and operating room service areas and facilities shall be properly equipped, easily cleanable, and of adequate size to accommodate the equipment and personnel required for surgical procedures performed.

(i) Each operating room shall have available:

- (A) Operating light and adequate general lighting;
- (B) Operating table, stretcher, or equivalent;
- (C) Oxygen;
- (D) Suction;
- (E) Appropriate electrical outlets;
- (F) X-ray film illuminator;
- (G) Cardiac monitor;
- (H) Anesthesia equipment and supplies;
- (I) Emergency signaling device which automatically registers at a location from or through which additional assistance is always available;
- (J) Source of emergency power; and
- (K) Emergency lighting.

(ii) Each hospital shall provide appropriately maintained emergency equipment, supplies, and services available within

sixty seconds and appropriate for the care of adults, children, and infants minimally to include:

- (A) Ventilatory equipment, including airways;
- (B) Cardiac defibrillator;
- (C) Cardiac monitor;
- (D) Laryngoscopes and endotracheal tubes;
- (E) Suctions; and
- (F) Emergency drugs and fluids including schedules of pediatric dosages.

(c) There shall be adequate operating room scrub sinks with provisions for a cleansing agent located adjacent to operating rooms and providing hot and cold water and equipped with knee, foot, elbow, or automatic faucet controls.

(d) Separate and adequate refrigerated storage facilities with appropriate alarms shall be provided for blood if blood is stored in the operating room area.

(e) There shall be a dressing area with appropriate locker storage available for persons entering operating rooms.

(f) Toilet facilities shall be available.

(g) Adequate types and quantities of surgical instruments, equipment, and supplies for procedures performed shall be provided and maintained in a sanitary and safe condition.

(h) There shall be adequate storage within the operating room service area for clean and sterile supplies and equipment.

(i) A designated area shall be provided for collection and cleaning of soiled instruments and equipment.

(j) There shall be adequate, cleanable facilities for safe and appropriate waste collection and disposal.

(k) Housekeeping facilities shall be located within operating room service areas. These may be included in a soiled utility room equipped with a clinic service sink or service sink.

(l) There shall be filtered clean air in each operating room. A positive pressure ventilation gradient to adjoining corridors shall be maintained in operating rooms.

(m) Operating rooms shall be equipped with a room temperature control device or system capable of maintaining appropriate patient body temperature.

(3) Policies - procedures - responsibility.

(a) The organization plan of the hospital shall identify lines of authority, responsibility, and accountability within all operating room areas and areas where surgical procedures are performed or anesthesia administered.

(i) There shall be a physician designated and responsible for implementation of hospital policy related to medical staff in operating rooms and operating room service areas.

(ii) A designated registered nurse shall supervise personnel as specified in hospital policy in operating rooms and operating room service areas and shall be responsible for:

(A) Development and implementation of operating room and operating room service staffing plans to maintain adequate and safe patient care.

(B) Provision for orientation and ongoing training of personnel providing services within operating rooms and operating room service areas.

(C) Defining nursing responsibility between the time of patient entry into and exit from operating rooms and operating room service areas.

(b) Written policies and procedures shall be approved in writing by appropriate representatives of administration, medical staff, and nursing services.

(i) Information, policies and procedures available to nursing and scheduling staff shall include:

(A) A current roster of medical staff including delineated surgical privileges as granted by the governing body.

(B) Policies and delineated privileges, responsibilities, and accountability of others approved by medical staff and governing body to provide services in operating rooms including, but not limited to, dentists, oral surgeons, and podiatrists.

(C) Requirements for surgical and technical-professional assistants, including current licensure and/or other qualifications and any limitations related to patient care activities within the operating room or operating room service areas including, but not limited to, surgical technicians, other technicians, nurses, or technicians who are not hospital personnel or students.

(ii) There shall be a policy and procedures for obtaining surgical assistants.

(iii) There shall be policies and procedures specifying responsibility to document all aspects of patient care in operating rooms and operating room service areas.

(iv) Written infection control policies approved by the infection control or equivalent interdisciplinary group shall delineate responsibility in training and orientation of operating room and operating room service area personnel and others. Infection control policies and procedures shall specifically address:

(A) Surgical attire;

(B) Appropriate surgical scrub procedures;

(C) Housekeeping functions specific to operating room and operating room service areas before, between, and after cases;

(D) Cleaning, disinfecting, sanitizing, packaging, sterilizing, and storage of equipment and supplies;

(E) Disposal of wastes;

(F) Nonhospital and hospital-owned equipment that may be brought into the operating room or operating room service areas including requirements for cleaning and sterilization including, but not limited to, tools for repairing equipment and physician-owned instruments.

(G) People who may enter operating room areas including those who are not hospital personnel, such as repairmen and vendors.

(v) Written policies and procedures related to patient safety or protection shall address servicing, maintenance, and safety checks of electrical-electronic equipment and other patient care equipment including nonhospital-owned equipment.

(vi) Policies and procedures shall address and define responsibility for continuous patient care and documentation when a patient is transferred from one place to another in the course of performing a surgical or invasive procedure.

(4) Preoperative patient care shall be addressed in written hospital policies which shall define requirements for patient care during the preoperative period to include:

(a) A current patient history and report of physical examination by a practitioner, authorized by medical staff rule, included in the patient medical record prior to surgery. "Current," as used in this subsection, shall be defined by hospital policy.

(b) Documented assessment of patient needs for care including, but not limited to, allergies, fears, anxieties, changes in condition, vital signs.

(c) Written consent for procedure or surgery and anesthesia available in the medical record.

(d) Identification of patients by a secured name band.

(e) Test results available prior to surgery or procedure.

(5) Short stay or short term or ambulatory or one-day surgery services or special procedures, regardless of where performed, shall function according to written policies and procedures approved by representatives of hospital administration, medical staff, and nursing services and include:

(a) Patient identification system, patient consent, and preoperative patient assessment requirements.

(b) Provisions for appropriate monitoring or observation of patients undergoing procedures by at least one qualified person in addition to the medical staff authorized practitioner performing the procedure.

(c) Written approved infection control and equipment safety policies as specified in subsection (3)(b) of this section.

(d) Emergency equipment as required for all operating rooms, available within sixty seconds as specified in subsection (2)(b)(ii) of this section.

(e) Documentation of patient assessment prior to, during, and post procedure.

(f) Teaching protocols for post procedure period including what signs and symptoms the patient should report, who to contact, limitations on activities or diet, medication control, driving, operation of mechanical equipment, and instructions for follow-up.

(g) Patient evaluation prior to discharge.

[Statutory Authority: RCW 70.41.030, 92-02-018 (Order 224), § 246-318-290, filed 12/23/91, effective 1/23/92. Statutory Authority: RCW 43.70.040, 91-02-049 (Order 121), recodified as § 246-318-290, filed 12/27/90, effective 1/31/91. Statutory Authority: RCW 70.41.030, 85-23-017 (Order 2302), § 248-18-251, filed 11/13/85.]

**WAC 246-318-300 Anesthesia services.** (1) Anesthesia facilities, equipment, personnel, staff, policies and procedures shall be appropriate to the scope of surgical, obstetrical, or other care offered in each hospital.

(2) There shall be a designated physician member of medical staff responsible for anesthesia services and for establishing general policies for administration of anesthesia to patients throughout the hospital.

(3) Written policies and procedures shall be established to provide safety for all anesthetized patients to include:

(a) Provision for appropriate monitoring and attendance of all anesthetized patients.

(b) Qualifications and responsibilities of persons performing anesthesia services and care in compliance with applicable federal and state laws and rules.

(c) Evaluation of each patient prior to anesthesia.

(d) Pertinent information recorded in the medical record at the time of the preoperative anesthesia evaluation.

(e) Criteria or protocols for assessment of all patients by qualified persons prior to discharge from any post-anesthesia recovery area or the hospital.

(f) Precautions or procedures for safe administration of anesthetizing agents and other drugs consistent with hospital policy approved by the appropriate medical staff committee in accordance with WAC 246-318-190 (1)(n) and (2)(f).

(g) Preparation, administration, and documentation of intravenous solutions, medications, and admixtures consistent with WAC 246-318-430 and 246-318-435.

(4) All information specific to condition and treatment of the patient occurring during anesthesia induction, anesthesia maintenance, or emergence from anesthesia shall be documented and retained in the medical record of the patient.

[Statutory Authority: RCW 70.41.030. 92-02-018 (Order 224), § 246-318-300, filed 12/23/91, effective 1/23/92. Statutory Authority: RCW 43.70.040. 91-02-049 (Order 121), recodified as § 246-318-300, filed 12/27/90, effective 1/31/91. Statutory Authority: RCW 70.41.030. 85-23-017 (Order 2302), § 248-18-253, filed 11/13/85.]

#### **WAC 246-318-310 Post-anesthesia recovery areas.**

(1) Post-anesthesia facilities, equipment, personnel, staff, policies and procedures shall be appropriate to the scope of surgical, obstetrical, or other care offered in each hospital.

(2) Environment - facilities.

(a) A handwashing sink, soap dispenser, and towel dispenser shall be available within each post-anesthesia recovery room or area.

(b) There shall be provisions for visual privacy for patients.

(c) Suction and oxygen shall be available for each patient.

(d) Emergency equipment and supplies shall be appropriately maintained and available within sixty seconds, as specified in WAC 246-318-290 (2)(b)(ii).

(e) Adequate, easily cleanable storage facilities shall be provided.

(f) There shall be a soiled utility room available.

(g) An emergency signalling device registering at a location from or through which additional assistance is always available shall be available within recovery rooms or areas.

(3) Policies - procedures - responsibility.

(a) The organization plan of the hospital shall identify lines of authority, responsibility, and accountability within post-anesthesia recovery rooms or areas.

(i) There shall be a physician designated and responsible for implementation of hospital policy related to medical staff in post-anesthesia recovery rooms and areas. Policy shall specify amount and degree of physician availability to post-anesthesia recovery areas at all times when patients are present.

(ii) A designated registered nurse shall supervise personnel as specified in hospital policy in post-anesthesia recovery rooms and areas and shall be responsible for:

(A) Developing and implementing post-anesthesia recovery service staffing plans to maintain adequate and safe patient care, and

(B) Providing for orientation and ongoing training of personnel providing services within post-anesthesia recovery rooms or areas.

(b) There shall be criteria or protocols for assessment of all patients by qualified persons prior to discharge or release from any post-anesthesia recovery room or area.

(c) There shall be policies and procedures regarding management of infected or infectious cases, approved by the infection control committee.

(4) Nursing and other staff providing patient care in post-anesthesia recovery areas shall have documented orientation and demonstrated appropriate skills related to life support activities or functions.

(5) There shall be written orders authenticated by a physician for all drugs, intravenous solutions, blood, and medical treatments. Standing medical orders or protocols, when used, shall be in the patient medical record and authenticated by a physician.

[Statutory Authority: RCW 70.41.030. 92-02-018 (Order 224), § 246-318-310, filed 12/23/91, effective 1/23/92. Statutory Authority: RCW 43.70.040. 91-02-049 (Order 121), recodified as § 246-318-310, filed 12/27/90, effective 1/31/91. Statutory Authority: RCW 70.41.030. 85-23-017 (Order 2302), § 248-18-256, filed 11/13/85.]

#### **WAC 246-318-320 Processing and sterilizing services.**

(1) Hospitals shall make adequate provisions for proper cleaning, disinfection, and sterilization of supplies, equipment, utensils, and solutions.

(2) Processing and sterilizing services and areas shall have adequate space and equipment for sorting, processing, and storage.

(a) Separation between soiled and clean items shall be maintained during sorting, processing, transporting, and storage.

(b) Positive air pressure shall be maintained in clean areas in relation to adjacent areas.

(c) Negative air flow shall be maintained in soiled areas.

(d) Equipment including sterilizers of the proper type for adequate sterilization shall be provided and maintained in a satisfactory and safe condition.

(e) If ethylene oxide sterilizers are used, mechanical aerators shall be provided and maintained in a safe and satisfactory condition.

(3) Processing and sterilizing services shall be adequately staffed with trained personnel:

(a) Orientation and inservice, including infection control and safe practices, shall be provided.

(b) Written policies and procedures shall specify scheduled activities and routines of personnel.

(4) There shall be written policies and procedures, approved by the infection control committee or an equivalent interdisciplinary group, for the activities performed in all processing and sterilizing areas in the hospital addressing:

(a) Collecting, receiving, decontaminating, packaging, sterilizing, and distributing of items;

(b) Aerating of items exposed to ethylene oxide;

(c) A recognized method of checking sterilizer performance by mechanical monitoring of time, temperature, and pressure as well as biological and chemical testing;

(d) Establishment of shelf life determined by packaging material and storage environment;

(e) Recall, disposal, and reprocessing of outdated, improperly sterilized, and limited-use items;

(f) Maintaining clean areas free of external shipping containers.

(5) There shall be written policies and procedures addressing emergency collection and disposition of supplies when special warnings have been issued by a manufacturer or safety agency.

(6) Processed and sterilized items shall be maintained as specified in WAC 246-318-190 (3)(a), (b), (c), (d), and (e).

[Statutory Authority: RCW 43.70.040. 91-02-049 (Order 121), recodified as § 246-318-320, filed 12/27/90, effective 1/31/91. Statutory Authority: RCW 70.41.030 and 43.20.050. 85-05-034 (Order 281), § 248-18-260, filed 2/15/85; Order 119, § 248-18-260, filed 5/23/75; Regulation 18.260, effective 3/11/60.]

**WAC 246-318-330 Use of medical gases, combustible anesthetics.** In rooms where combustible anesthetic (cyclopropane, divinyl ether, ethyl chloride, ethyl ether, and ethylene) agents are used, the installation, maintenance, and use of equipment and other precautions observed by personnel shall be in accordance with department approved or recommended standards.

[Statutory Authority: RCW 43.70.040. 91-02-049 (Order 121), recodified as § 246-318-330, filed 12/27/90, effective 1/31/91. Statutory Authority: RCW 70.41.030. 79-04-081 (Order 176), § 248-18-270, filed 4/2/79; Order 119, § 248-18-270, filed 5/23/75; Regulation 18.270, effective 3/11/60.]

**WAC 246-318-340 Nonflammable medical gases.**

(1) Nonflammable medical gases shall include but not be limited to oxygen, nitrous oxide, medical compressed air, carbon dioxide, helium, nitrogen and mixtures of such gases when used for medical purposes.

(2) Medical gas gauges, alarms and manometers shall be tested for accuracy periodically and be conspicuously labeled "(name of gas), use no oil."

(3) "No smoking" signs shall be posted where oxygen is being administered.

(4) Oxygen tent canopies shall be fabricated of slow burning or noncombustible material.

(5) Electric equipment used in an oxygen enriched environment shall be properly designed for use with oxygen and should be labeled for use with oxygen.

(6) Procedures shall specify the safe storage and handling of medical gas containers.

(7) Upon completion of any alteration, modification or repair of medical gas piping systems in which any line in the system is disconnected or disrupted, qualified personnel shall conduct appropriate tests, to include oxygen analysis and to assure that medical gas outlets within the disconnected or disrupted system are delivering the proper gas as shown on the outlet label. There shall be documentation that tests have occurred.

[Statutory Authority: RCW 43.70.040. 91-02-049 (Order 121), recodified as § 246-318-340, filed 12/27/90, effective 1/31/91. Statutory Authority: RCW 43.20.050. 79-12-038 (Order 187), § 248-18-280, filed 11/20/79. Statutory Authority: RCW 70.41.030. 79-04-081 (Order 176), § 248-18-280, filed 4/2/79; Order 119, § 248-18-280, filed 5/23/75; Regulation 18.280, effective 3/11/60.]

**WAC 246-318-350 Emergency care services.** The hospital shall have a well defined system for providing emergency care services. The nature and scope of the hospital's emergency care services should be in accord with the community's needs and the hospital's capabilities.

(1) The hospital shall provide the following basic, outpatient emergency care services.

(a) Assessment of a person's condition to determine the nature, acuity, and severity of the person's immediate medical need.

The condition of each person, who comes or is brought to the hospital for emergency medical care, shall, upon arrival, be assessed by a registered nurse, physician, or physician's assistant for the purpose of determining the nature and urgency of the person's medical need and the timing and place of the person's care and treatment.

(b) Immediate diagnosis and treatment of any life threatening cardiac arrhythmia, respiratory insufficiency or shock.

(c) Appropriate transfer or referral of a patient who needs medical care services not provided by the hospital. Prior to transfer of an emergency patient to another health care facility, the hospital shall:

(i) Perform the emergency procedures needed to minimize aggravation of the patient's condition during transport to the other health care facility; and

(ii) Ascertain that the means by which the patient is to be transported to the other health care facility are suitable for the patient.

(2) A hospital shall not be required to comply with subsections (3)(h), (4)(a) and (d), (5)(a), and (6)(a) of this section if the hospital does not offer outpatient emergency care services regularly and only provides the outpatient emergency services required under subsection (1) of this section to the occasional emergency patient who comes or is brought to the hospital by chance.

(3) The hospital shall have, in effect, written policies and procedures which supplement and are coordinated with the hospital's basic policies and are specific to emergency care services. These policies and procedures shall be: Reviewed and revised as necessary to keep them current and, in any case, at least annually; dated and approved in writing by appropriate representatives of the hospital's administrative, medical, and nursing staffs; and made known and readily available to physicians, nurses, and other persons having a responsibility for emergency care services. Policies and procedures pertaining to emergency care services shall include the following.

(a) Policies on the scope and extent of the emergency care services to be provided.

(i) The hospital shall establish the conditions under which treatment is to be provided in the emergency care area, the types of procedures that are to be performed in another area of the hospital (e.g., surgery) rather than the emergency area, the conditions under which a patient is to be admitted as an inpatient, the conditions under which a patient is to be transferred to another health care facility, the conditions under which a patient is to be referred to a private physician or another health care facility, and the conditions under which arrangements should be made for a patient to return to the hospital for treatment.

(ii) A patient shall not be transferred to another health care facility until the other health care facility has been contacted and has consented to accept the patient.

(iii) A record containing the following data shall be sent with an emergency patient who is transferred to another health care facility: Patient identification data, identification



of the patient's illness or injury, treatment given to the patient, and an appraisal of the patient's condition upon transfer.

(b) Policies and procedures which prescribe the course of action to be taken when the number of emergency patients, who have arrived or are expected, constitute an overload for the emergency service facilities and staff on hand.

The hospital shall establish who is to be notified when an overload of emergency patients occurs, the conditions under which arrangements are to be made for care of some emergency patients at other hospitals, the conditions under which additional physicians, nurses, and other persons are to be summoned, the methods by which necessary, additional supplies and equipment are to be obtained, and the conditions under which rooms and areas outside the emergency service area of the hospital are to be used for emergency care and treatment.

(c) Medical policies, standing emergency medical orders, and written medical procedures to guide the action of nurses and other personnel when a person presents a medical emergency and a physician is not present.

(i) Medical policies shall delineate the circumstances under which particular medical policies are to be followed, provide for a physician to be called as rapidly as possible, and establish the minimum qualifications or training of persons who may execute particular emergency medical orders.

(ii) There shall be written procedures, approved in writing by a representative of the medical staff, for any use of defibrillators, respirators or other special medical equipment and for the performance of the special, emergency medical procedures listed in subsection (4)(c) of this section.

(iii) A standing medical order for administration of a drug or other treatment during a medical emergency shall include: A description of the treatment which includes the name of any drug or other agent; the dosage, concentration or intensity of any drug or other agent; the route or method of administration; where pertinent, the time interval, frequency, or duration of administration; and the signature of a representative of the medical staff.

(d) Policies which delineate medical staff responsibilities for emergency care services as related to assigned clinical privileges, physician coverage of emergency care services, and physician participation in the training of personnel.

(e) Policies regarding the notification of an emergency patient's next of kin or legal guardian.

(f) Policies relevant to obtaining consent for treatment from an emergency patient or other person who may legally give consent for treatment of the patient.

These shall include instructions regarding action to be taken when the condition of an emergency patient and the absence of another person legally able to act on behalf of the patient make it impossible to gain an informed consent for critically needed treatment or consent for critically needed treatment is refused.

(g) Policies and procedures pertaining to the care and handling of persons whose conditions require special medical or medico-legal consideration.

(i) Policies and procedures shall prescribe the course of action to be followed in the care of persons who manifest severe emotional disturbances, are under the influence of

alcohol or other drugs, are victims of suspected child abuse, are victims of other suspected criminal acts, have a contagious disease, have been contaminated by radioactive material, are diagnosed dead on arrival, or present other conditions requiring special directions regarding action to be taken.

(ii) Definite provision shall be made for communications, as indicated, with health authorities, police or coroner relative to a person whose condition or its cause are reportable.

(h) Policies governing special diagnostic and therapeutic services (e.g., clinical laboratory, x-ray, pharmacy, surgery) to emergency patients.

These shall be designed to ensure prompt availability of necessary diagnostic and therapeutic services and establish the types, scope, and extent of the special diagnostic and therapeutic services to be provided for the care of emergency patients.

(i) Policies regarding notification of an emergency outpatient's personal physician and procedures for transfer of relevant reports to the personal physician.

(j) Policies regarding disclosure of information about an emergency patient.

(4) Organization and staffing for emergency care services shall be in accord with the anticipated patient load and the services provided by the hospital.

(a) There shall be a physician responsible for the medical direction of the hospital's emergency care services. This physician shall be a representative of the medical staff or a physician whose services the hospital has arranged on a regular basis. The functions and responsibilities of the physician responsible for medical direction of the emergency care services shall be delineated in writing and made known to members of the medical and nursing staffs.

(b) At all times, there shall be a physician on duty or call for emergency care services. A current schedule of the names of on-call physicians and the telephone numbers of these physicians or the call service(s) through which they can be contacted rapidly shall be posted in the emergency care area.

(c) At all times, there shall be on duty within the hospital at least one registered nurse who is immediately available and responsible for emergency care services and who is qualified to perform the following: Administration of intravenous fluids, electrocardiography and defibrillation of life threatening arrhythmias, cardio-pulmonary resuscitation, control of hemorrhage, gastric lavage, and basic neurological evaluation. It is recommended that such a nurse also be qualified to perform endotracheal intubation and arterial puncture.

(d) There shall be additional nursing staff and other personnel for emergency care services as are necessary to provide the types and amount of care required by patients.

(i) Staffing for emergency care services shall be adequate to ensure that each applicant for emergency medical care is seen within a period of time commensurate with the nature, acuity and severity of his or her immediate medical need.

(ii) Each hospital employee engaged in the provision of emergency care shall have had the education and training necessary to perform the emergency medical procedures and



other functions and duties for which he or she may be responsible.

(5) The physical plant facilities, equipment, and supplies for emergency care services shall be commensurate with the scope, types and volume of the services provided by the hospital.

(a) A hospital which regularly offers emergency care services shall maintain a distinct emergency service area.

(i) The emergency service area shall be in close proximity to an emergency entrance and separate from the surgery and delivery suites and inpatient nursing units.

(ii) The emergency service area shall provide adequate space for reception and screening of patients and have examination, treatment, and observation rooms in such numbers, sizes, and arrangements as are necessary to assure safe and effective treatment of patients.

(iii) There shall be some means of providing visual privacy to patients in all rooms or areas in which patients are examined or treated.

(iv) At the emergency entrance there shall be an outside night call bell which, when activated, sounds in an area of the hospital in which nursing personnel are always on duty.

(b) A hospital which limits its emergency care services to care of the occasional emergency patient shall not be required to maintain a distinct emergency service area, but shall designate the area(s) to be used for emergency care and provide the equipment, pharmaceuticals and other supplies essential to providing basic emergency care services required under subsection (1) of this section. Emergency equipment and supplies shall be maintained in such a location and manner (e.g., on a "crash" cart) that they may be brought into use immediately upon arrival of a person who presents a medical emergency.

(c) The equipment, pharmaceuticals and other supplies necessary to provide emergency care services shall be readily available at all times.

(i) There shall be specific, designated locations for storage of drugs, parenteral solutions, other supplies, instruments and special equipment so personnel can obtain them rapidly.

(ii) There shall be a system for regular inventory and replenishment of the stock of emergency supplies and equipment to ensure an adequate supply at all times.

(iii) There should be regular inspection and maintenance servicing of medical equipment to keep it in a safe and operable condition.

(d) Current references on toxicology, antidote information and the telephone number of the regional poison control center shall be readily available in the emergency care area.

(e) Telephone numbers of the pharmacist, the blood bank, the ambulance service, the Washington state patrol, Military Assistance Safety and Traffic (MAST), the fire department, the police department, local health authorities, the coroner and other persons or organizations emergency service personnel may need to contact rapidly shall be posted in the emergency service area.

(f) Hospital to ambulance radio communication compatible with the state-wide emergency communication system is recommended for any hospital which regularly provides emergency care services.

(6) The hospital shall maintain an emergency service register and a medical record for each person who has received emergency care service.

(a) There shall be a permanent, current register for all emergency patients.

(i) The register shall contain at least the following data for each person who comes or is brought to the hospital for immediate medical care services: Full name, age, date and time of arrival, the identifying number, the disposition of the patient and the time of the patient's departure from the emergency service area.

(ii) Data on patients shall be entered in the register in chronological order according to the dates and times of arrivals.

(iii) Identification data on a person who is dead on arrival shall be entered in the register.

(b) The hospital shall maintain a medical record for each person who receives emergency care services. Each medical record shall contain the following data.

(i) Patient identification data.

(ii) The date and time of arrival, the means by which the patient came to the hospital and by whom the patient was transported or accompanied.

(iii) Pertinent history of the patient's injury or illness which may include information on first aid or emergency care given the patient prior to his or her arrival.

(iv) Description of significant clinical findings derived from an assessment or examination of the patient.

(v) Any clinical laboratory or roentgenologic findings.

(vi) Diagnosis (tentative or definitive).

(vii) Treatment given.

(viii) Orders for administration of drugs or other treatments which are received by telephone, radio, or verbally from a physician or other person legally authorized to prescribe and acting within the scope of his or her license.

Such a telephone or verbal order shall be received, entered in the patient's medical record and signed by a registered nurse. The counter-signature of the physician or other legally authorized practitioner who gave the order shall be obtained as soon as possible thereafter. This shall not be interpreted to include verbal orders which are received from a physician or other legally authorized practitioner to whom one is providing direct assistance in care of the patient or to include standing emergency medical orders which have been established in accordance with subsection (3)(c)(iii) of this section.

(ix) Appraisal of the patient upon transfer or departure.

(x) Disposition of the patient, which shall include a resume of any instruction given to the patient or his family regarding necessary follow-up care.

Entries of data listed as (iv), (vi), (vii), (ix), and (x) above shall be authenticated by the signature of the person who rendered the service.

[Statutory Authority: RCW 70.41.030, 92-02-018 (Order 224), § 246-318-350, filed 12/23/91, effective 1/23/92. Statutory Authority: RCW 43.70.040, 91-02-049 (Order 121), recodified as § 246-318-350, filed 12/27/90, effective 1/31/91; Order 142, § 248-18-285, filed 2/8/77; Order 119, § 248-18-285, filed 5/23/75; Order 110, § 248-18-285, filed 3/14/75; Order 106, § 248-18-285, filed 1/13/75.]

**WAC 246-318-360 Diagnostic and treatment facilities, outpatient services.** If the hospital has an

organized unit as an outpatient department or clinic, adequate waiting area, examining and treatment rooms, toilets and special rooms necessary for the services to be rendered, shall be provided.

[Statutory Authority: RCW 43.70.040. 91-02-049 (Order 121), recodified as § 246-318-360, filed 12/27/90, effective 1/31/91; Order 119, § 248-18-290, filed 5/23/75; Order 106, § 248-18-290, filed 1/13/75; Regulation 18.290, effective 3/11/60.]

**WAC 246-318-370 Laboratory.** (1) Each hospital shall ensure:

(a) Availability of laboratory services sufficient in size and scope to provide adequate care of all patients minimally to include provisions for:

- (i) Obtaining blood and blood products,
- (ii) Performing hemoglobin or hematocrit,
- (iii) Performing white blood count,
- (iv) Performing platelet estimate,
- (v) Performing urinalysis,
- (vi) Performing blood glucose, and
- (vii) Performing serum potassium.

(b) Disposal of contaminated materials in a safe manner (see WAC 246-318-170);

(c) Appropriate maintenance, safety, and cleanliness of hospital laboratory facilities and equipment (see WAC 246-318-035, 246-318-150, 246-318-155, and 246-318-170);

(d) Provision for pathology services appropriate to all services available in the hospital.

(2) Hospitals shall provide laboratory services in accordance with guidelines for laboratory quality assurance program, WAC 246-318-99910.

[Statutory Authority: RCW 70.41.030. 92-02-018 (Order 224), § 246-318-370, filed 12/23/91, effective 1/23/92. Statutory Authority: RCW 43.70.040. 91-02-049 (Order 121), recodified as § 246-318-370, filed 12/27/90, effective 1/31/91. Statutory Authority: RCW 70.41.030. 87-23-056 (Order 2560), § 248-18-300, filed 11/18/87; Order 119, § 248-18-300, filed 5/23/75; Regulation 18.300, effective 3/11/60.]

**WAC 246-318-380 Diagnostic and therapeutic radiologic and other imaging services.** (1) Hospitals shall:

(a) Ensure availability of radiologic services appropriate to the type and scope of hospital services offered for inpatients and outpatients; and

(b) Provide a written description of the type and scope of nuclear medicine and other diagnostic and therapeutic imaging services when provided in the hospital for inpatients and outpatients.

(2) Hospitals with imaging services shall:

(a) Designate medical responsibility to a physician member of the medical staff and require access to a radiologist, if radiologic services are provided in the hospital;

(b) Designate medical responsibility to one or more physician members of the medical staff qualified in nuclear medicine, if nuclear medicine services are provided;

(c) Designate medical responsibility to one or more physician members of the medical staff qualified in the appropriate specific imaging specialty if other imaging services are provided;

(d) Require performance of radiology, nuclear, and other imaging services only when:

(i) Ordered, in writing, by a member of the medical staff; or

(ii) In accordance with hospital policy and procedures; and

(e) Provide sufficient numbers of personnel and medical staff qualified to safely deliver the type, scope, and volume within each imaging service including:

(i) At least one diagnostic radiologic technician, technologist, or physician available to come to the hospital to perform diagnostic procedures at all times;

(ii) Performance of therapeutic radiologic services by:

(A) A radiologist or radiation oncologist; or

(B) A therapeutic radiologic technologist directed by a radiologist or radiation oncologist;

(iii) Performance of diagnostic radiologic services by:

(A) A physician or radiologist; or

(B) A diagnostic radiologic technician under policies and procedures approved by a radiologist; and

(iv) After December 31, 1990, performance of nuclear medicine services by a nuclear medicine technologist or by a physician member of the medical staff qualified in nuclear medicine.

(f) Establish policies and procedures approved by administration, a radiologist, and other medical staff qualified in the specialties provided including:

(i) Protection of patients and others from radiation hazards including shielding for syringes, vials, and sources of radioactivity;

(ii) Patient preparation, patient examination, and administration of diagnostic agents;

(iii) Medical staff responsibility for preparation and administration of radiopharmaceuticals;

(iv) Designating authorized users of the equipment;

(v) Safe operation of equipment;

(vi) Safe handling, storage, preparation, labeling, transporting, and disposal of radioactive materials;

(vii) Precautions to minimize unnecessary radiation exposure to patients and others;

(viii) Actions required in event of radioactive contamination of patients, personnel, equipment, and environment;

(ix) Prevention of electrical, mechanical, fire, explosion, and other hazards; and

(x) Written reports on any adverse reaction of a patient to diagnostic or therapeutic agents, including notation in the medical record or outpatient report.

(3) Hospitals providing any imaging service shall provide:

(a) Adequate space and facilities for:

(i) Patient privacy;

(ii) Patient access to a toilet;

(iii) Patient examinations;

(iv) Patient reception;

(v) Patient dressing rooms;

(vi) Exposed and unexposed film storage; and

(vii) Safe storage, preparation, labeling, transportation, and disposal of radioactive materials.

(b) Maintenance of safe, clean equipment, facilities, and supplies appropriate for the type and scope of service offered;

(c) Maintenance of all patient care equipment in safe, operating condition;

(d) Emergency equipment, supplies, and medications required under WAC 246-318-290(5); and

(e) A method for summoning extra appropriate staff for emergencies arising in imaging service areas.

(4) Hospitals providing radiologic areas, rooms, and services shall:

(a) Conduct radiologic services in a safe, appropriately equipped area of the hospital, shielded as necessary to prevent radiation hazards to individuals;

(b) Maintain radiology equipment meeting applicable state rules for radiation protection under chapter 246-225 WAC; and

(c) Arrange for services of a qualified expert defined and described under WAC 246-240-040 as needed for:

(i) Consultation, including periodic radiologic safety testing;

(ii) Supervision of radiation safety measures; and

(iii) Participation in education programs.

(5) Hospitals with imaging services shall:

(a) Maintain authenticated and dated reports of diagnostic and therapeutic procedures, consultations, and interpretations in each patient's medical record;

(b) Retain hard copies or electronic access to authenticated interpretative reports for films, consultations, and therapeutic procedures in the imaging service area for a period defined by the hospital;

(c) Require hospital-authorized practitioners to provide a reason for each examination on all requests for services;

(d) Require authentication of interpretative reports by:

(i) The radiologist for radiology reports; or

(ii) A designated physician member of the medical staff qualified in the appropriate, specific imaging specialty.

(e) Retain patient logs for imaging services and records of equipment calibration inspections and quality assurance testing in the imaging service area for a period defined, in writing, by the hospital;

(f) Maintain records of receipt and disposition of radioactive materials; and

(g) Maintain documentation of:

(i) Maintenance and periodic calibration of all radiation safety equipment;

(ii) Maintenance of all patient care equipment in a safe, operating condition; and

(iii) Calibration of diagnostic and treatment radiologic equipment by:

(A) A qualified expert defined and required under WAC 246-240-040; or

(B) An individual qualified according to manufacturer's specifications for a particular piece of equipment.

[Statutory Authority: RCW 70.41.030. 92-02-018 (Order 224), § 246-318-380, filed 12/23/91, effective 1/23/92. Statutory Authority: RCW 43.70.040. 91-02-049 (Order 121), recodified as § 246-318-380, filed 12/27/90, effective 1/31/91. Statutory Authority: RCW 70.41.030. 89-22-109 (Order 008), § 248-18-311, filed 11/1/89, effective 12/2/89.]

**WAC 246-318-390 Physical and occupational therapy services.** (1) Definition "authorized health care practitioner" means physicians and other licensed individuals as defined in RCW 18.74.010(7).

(2) Each hospital shall clearly define physical therapy (PT) and occupational therapy (OT) services in a written statement describing the scope of diagnostic, therapeutic, and rehabilitative services provided for inpatients and outpatients.

(3) Policies and procedures. When a hospital offers PT or OT services, written policies and procedures shall be established and followed including instructions for:

(a) Patient care protocols.

(b) Operation and application of equipment.

(c) Equipment maintenance and monitoring.

(d) Infection control practices including:

(i) Cleaning,

(ii) Disinfecting,

(iii) Sterilizing, and

(iv) Changing of equipment.

(e) Documentation.

(f) Periodic review of policies and procedures with:

(i) Revision as needed,

(ii) Documentation of date and name of reviewers, and

(iii) Written approval of revisions by:

(A) The appropriate committee or group including medical staff representation, or

(B) A member of the medical staff.

(g) What to do when physician or prescribing practitioner orders are unclear or incomplete. (Complete orders include modality, frequency, date, time, and authentication.)

(4) Medical direction and personnel.

(a) Hospital OT and PT services shall be:

(i) Under the direction of a member of the active medical staff, or

(ii) Under the direction of a committee chaired by a member of the active medical staff.

(b) Hospitals shall provide:

(i) Adequate numbers of qualified personnel in accordance with the scope and volume of OT and PT services.

(ii) Inservice and orientation for PT and OT personnel with appropriate documentation.

(5) Patient treatment plan. Hospitals shall require a written OT and PT treatment plan for each patient receiving a PT or OT treatment service, to include:

(a) Identification of short and long term goals,

(b) Identification of patient's problems and limitations,

(c) Description of planned procedures and modalities.

(6) Authorization and documentation. When OT or PT treatment services are provided, the hospital shall require and ensure:

(a) Medical authorization of treatments evidenced by:

(i) Written authentication by a member of the medical staff for all inpatient treatment services provided, or

(ii) Written authentication by the authorized health care practitioner issuing the order for outpatient treatments, according to hospital policy and procedures.

(b) Entry of written, verbal, and telephone orders into the appropriate individual medical record.

(c) Use of standing orders only when:

(i) Dated and signed by a member of the medical staff,

(ii) Reviewed annually and renewed by written approval (dated authentication) of each order, and

(iii) A copy of the order is inserted into the appropriate individual medical record.

(d) Documentation in the medical record of PT and OT services provided for a patient to include:

(i) Date,

(ii) Time treatment was initiated,

(iii) Type of therapy service performed,

- (iv) Periodic assessment of the response of the patient, and
- (v) Authentication by the person performing the service.
- (7) Space and equipment. Hospitals shall provide:
- (a) Adequate space designated for:
- (i) Reception,
  - (ii) Recordkeeping, and
  - (iii) Treatments,
  - (iv) Storage of equipment and supplies.
- (b) Patient dressing and toilet facilities,
- (c) Patient privacy,
- (d) Safe, functional, and appropriate equipment for any PT and OT service provided, and
- (e) Calibration of equipment with documentations,
- (f) System for equipment maintenance.

[Statutory Authority: RCW 43.70.040. 91-02-049 (Order 121), recodified as § 246-318-390, filed 12/27/90, effective 1/31/91. Statutory Authority: RCW 70.41.030. 87-03-030 (Order 2464), § 248-18-312, filed 1/14/87.]

**WAC 246-318-400 Respiratory care services.** (1)

Respiratory care services shall be clearly defined in a written statement that describes the scope of diagnostic, therapeutic and rehabilitative cardio-pulmonary services provided for inpatients and outpatients.

(2) Policies and procedures.

(a) Written policies and procedures for respiratory care services shall be developed and implemented and shall include instructions for the following: Patient care techniques; operation and application of equipment; equipment maintenance and monitoring; infection control practices including cleaning, disinfecting, sterilizing and changing of equipment; use and storage of medications, drugs and chemicals.

(b) Policies and procedures shall be periodically reviewed, revised as needed and approved by the appropriate committee with medical staff representation or by member of the medical staff.

(3) Medical direction and personnel.

(a) The respiratory care services shall be under the medical direction of a member of the active medical staff or a committee chaired by a member of the active medical staff.

(b) Respiratory care services shall have an adequate number of qualified personnel in accordance with the scope and volume of services.

(c) In-service shall be provided and documented for respiratory care service personnel.

(4) Authorization and documentation.

(a) Respiratory care services provided for a patient shall be authorized in writing and signed by a physician. Verbal and telephone orders shall be signed by a physician.

(b) Routine and standing orders, when used, shall be reviewed annually and signed by the appropriate member of the active medical staff.

(c) Respiratory care services provided for a patient shall be reported in the medical record. The record shall include the date, time, type of respiratory service performed, medications, assessment of the response of the patient, and signature of the person performing the service.

(d) There shall be a policy statement describing what to do when physician orders are unclear or incomplete.

(5) Space.

(a) There shall be adequate space designated in the hospital for reception, treatments and/or respiratory services, recordkeeping, storage for equipment, supplies and drugs.

(b) Space for treatments and for processing of equipment and materials shall be organized and maintained to prevent cross-contamination.

(c) Equipment and instruments shall be safe, functional, and appropriate for respiratory care services provided. There shall be documentation of the calibration and maintenance systems.

[Statutory Authority: RCW 43.70.040. 91-02-049 (Order 121), recodified as § 246-318-400, filed 12/27/90, effective 1/31/91. Statutory Authority: RCW 70.41.030. 79-04-081 (Order 176), § 248-18-315, filed 4/2/79.]

**WAC 246-318-410 Other services.** Hospitals offering and providing diagnostic or therapeutic services other than those specified elsewhere in this chapter shall:

(1) Maintain adequate space and equipment for the scope of services offered.

(2) Provide for patient privacy.

(3) Require professional staff licensure when required by state statute.

(4) Require evidence of specific medical staff orders for any diagnostic services or treatments for inpatients.

(5) Establish policy and procedure addressing referral orders issued by persons other than medical staff for outpatient treatments and diagnostic services.

(6) Maintain appropriate pharmacist participation as described in WAC 246-318-190 (1)(n) and (2)(f).

(7) Establish policies and procedures specific to operation of each service offered minimally to include:

(a) Providing orientation and inservice for staff,

(b) Ensuring patient safety and infection control,

(c) Providing maintenance and calibration of equipment, and

(d) Maintaining coordination with other hospital services.

[Statutory Authority: RCW 70.41.030. 92-02-018 (Order 224), § 246-318-410, filed 12/23/91, effective 1/23/92. Statutory Authority: RCW 43.70.040. 91-02-049 (Order 121), recodified as § 246-318-410, filed 12/27/90, effective 1/31/91. Statutory Authority: RCW 70.41.030. 87-03-030 (Order 2464), § 248-18-321, filed 1/14/87.]

**WAC 246-318-420 Hospital pharmacy.** Each hospital shall provide evidence of current approval by the Washington state board of pharmacy pursuant to chapter 18.64 RCW and chapter 246-873 WAC.

[Statutory Authority: RCW 70.41.030. 92-02-018 (Order 224), § 246-318-420, filed 12/23/91, effective 1/23/92. Statutory Authority: RCW 43.70.040. 91-02-049 (Order 121), recodified as § 246-318-420, filed 12/27/90, effective 1/31/91. Statutory Authority: RCW 43.20.050 and 70.41.030. 84-02-036 (Order 271), § 248-18-331, filed 12/30/83. Formerly WAC 248-18-330.]

**WAC 246-318-430 Intravenous preparation.** (1) There shall be written policies and procedures including:

(a) Preparation of intravenous solutions, medications, and admixtures. "Intravenous admixture" means a solution with addition of medication or an altered solution intended for intravenous use.

(b) Infection control policies and procedures approved by the infection control or an equivalent committee, and including:

(i) Aseptic preparation of intravenous admixtures and medications in a clean, low-traffic area, preferably under a clean air center.

(ii) Cleaning and preventive maintenance of clean air centers.

(c) Information required on all orders or prescriptions for intravenous solutions, admixtures, and medications, which shall minimally include identification of solution or medication, rate of flow or frequency, duration, strength of additive, dilution ratio of solution, identification of patient, and identification of prescribing practitioner.

(2) Individuals preparing intravenous solutions and admixtures shall be legally authorized, trained in procedures and equipment, and approved by the hospital.

(3) There shall be drug compatibility reference material readily available to those who prescribe, prepare, and administer intravenous admixtures.

(4) Intravenous solution containers shall be labeled to include patient name, identification of solution, identification and strength of additives, volume, rate of flow, expiration time and date of admixture, any special requirement for handling and storage, and identification of individual preparing admixture. There shall be procedures for appropriate labeling of precision volume chambers during times such are used for administering admixtures.

(5) There shall be policy and procedures for frequency of reordering intravenous solutions and admixtures.

[Statutory Authority: RCW 43.70.040. 91-02-049 (Order 121), recodified as § 246-318-430, filed 12/27/90, effective 1/31/91. Statutory Authority: RCW 70.41.030. 83-13-061 (Order 261), § 248-18-335, filed 6/15/83.]

**WAC 246-318-435 Intravenous administration.** (1)

There shall be written policies and procedures including:

(a) Administration of intravenous solutions, medications, admixtures, blood, and blood products.

(b) Infection control policies and procedures approved by the infection control or an equivalent committee, and including:

(i) Site preparation.

(ii) Tubing and dressing management.

(iii) Site assessment and rotation.

(c) Use and control of intravenously administered investigational drugs.

(d) Administration of parenterally administered drugs causing tissue necrosis upon extravasation.

(e) Documentation requirements.

(f) Patient teaching and discharge instruction.

(g) All orders or prescriptions for intravenous solutions, admixtures, and medications shall minimally include identification of solution or medication, rate of flow or frequency, duration, strength of additive, dilution ratio of solution, identification of patient, and identification of prescribing practitioner.

(h) Use of electronic infusion control devices.

(2) Personnel inserting intravenous devices shall be legally authorized and appropriately trained with demonstrated and documented skills in intravenous insertion techniques.

(3) Personnel administering intravenous solutions and admixtures shall be legally authorized to administer medications with appropriate training, demonstrated and documented skill in intravenous administration, procedures, equipment, and approval of the hospital.

(4) There shall be drug compatibility reference material readily available to individuals who administer intravenous medications and admixtures.

(5) Intravenous solutions shall be administered only upon the order of a legally authorized practitioner authorized by hospital policy to prescribe drugs in the hospital.

(6) Intravenous solution containers shall be labeled to include patient name, identification of solution, identification and strength of additives, volume, rate of flow, expiration time and date of admixture, any special requirement for handling and storage, and identification of individual preparing admixture. There shall be procedures for appropriate labeling of precision volume chambers during times such are used for administering admixtures.

(7) There shall be documentation in the medical record to include:

(a) Solution, medication or medications, time, date, amount administered, and rate;

(b) Site and site assessment;

(c) Date and time of insertion and removal of cannula;

(d) Device used, including gauge, length and type needle, or cannula;

(e) Condition of cannula and site at the time removed from patient;

(f) Use of electronic infusion devices;

(g) Observed complications and treatment of complications;

(h) Management of tubing and dressing; and

(i) Signature. An initial signature identification system is acceptable.

(8) Administration of intravenous preparations to pediatric patients shall comply with regulations in this section and WAC 246-318-210.

[Statutory Authority: RCW 70.41.030. 92-02-018 (Order 224), § 246-318-435, filed 12/23/91, effective 1/23/92. Statutory Authority: RCW 43.70.040. 91-02-049 (Order 121), recodified as § 246-318-435, filed 12/27/90, effective 1/31/91. Statutory Authority: RCW 70.41.030. 83-13-061 (Order 261), § 248-18-336, filed 6/15/83.]

**WAC 246-318-440 Records and reports—Medical record system.** Each hospital shall have a well-defined medical record system with facilities, staff, equipment, and supplies necessary to develop, maintain, control, analyze, retrieve, and preserve patient care data and medical records.

(1) Medical record service. Hospitals shall establish an organized medical record service, consistent with recognized principles of medical record management, directed, staffed, and equipped to ensure:

(a) Timely, complete and accurate checking, processing, indexing, filing, and preservation of medical records; and

(b) The compilation, maintenance, and distribution of patient care statistics.

(2) Policies and procedures related to medical record system. Hospitals shall establish and follow current written policies and procedures related to the medical record system, including requirements for:

(a) An established format for patients' individual medical records;

(b) Access to and release of data in patients' individual medical records and other medical data considering the confidential nature of information in these records;

(c) The retention, preservation, and destruction of medical records; and

(d) Maintenance and disposition of medical and other records in Washington state owned or operated hospitals as required in chapter 40.14 RCW and rules promulgated under chapter 40.14 RCW.

(3) Patients' medical records, general. Hospitals shall:

(a) Develop and maintain an individual medical record for each person, including each neonate, receiving care, treatment, or diagnostic service at the hospital except as permitted in subsection (4)(b) of this section;

(b) Establish a systematic method for identifying each patient's medical record or records to allow ready identification, filing, and retrieval of all of the patient's record or records;

(c) Require prompt, pertinent entries in a patient's medical record on:

(i) A significant observation;

(ii) Any diagnostic or treatment procedure; and

(iii) Other significant events in a patient's clinical course or care and treatment.

(d) Require entries to include:

(i) A date;

(ii) Authentication by the individual assuming responsibility for the entry; and

(iii) A time in accordance with hospital policy.

(e) File the originals or durable, legible, direct copies of originals of reports in patients' individual medical records;

(f) Enter all diagnoses and operative procedures in patients' medical records in terminology consistent with a recognized system of disease and operations nomenclature;

(g) Require legible entries in a patient's medical record which are:

(i) Written in ink;

(ii) Typewritten; or

(iii) Recorded on a computer terminal designed to receive such information.

(4) Hospitals may:

(a) Store entries on magnetic tapes, discs, or other devices suited to the storage of data;

(b) Maintain a simple record system instead of the individual medical records required under subsections (3) and (4)(c) of this section for patients receiving only referred outpatient diagnostic services, as defined in WAC 246-318-010, provided the system permits:

(i) Identification of patient; and

(ii) Filing and retrieval of authenticated reports on all tests or examinations provided to any patient receiving services.

(c) Limit content in individual medical records for patients who would be considered referred outpatients, except for use of parenteral injections during diagnostic tests to:

(i) Relevant history and physical findings where indicated;

(ii) Known allergies or idiosyncratic reactions;

(iii) Diagnostic interpretation;

(iv) Written consent; and

(v) Identifying admission data.

(5) Patients' medical records, content. Hospitals shall require and ensure entry of the following data into a medical record for each period a patient receives inpatient or outpatient services with exceptions only as specified in subsection (4) of this section and WAC 246-318-350(6):

(a) Admission data including:

(i) Identifying and sociological data;

(ii) The full name, address, and telephone number of the patient's next of kin or, when indicated, another person with legal authority over the person of the patient;

(iii) The date of the patient's admission as an inpatient or outpatient;

(iv) The name or names of the patient's attending physician or physicians; and

(v) The admitting or provisional diagnosis or description of medical problem.

(b) A report on any medical history obtained from the patient;

(c) Report or reports on the findings of physical examination or examinations performed upon the patient;

(d) An entry on any known allergies of the patient or known idiosyncratic reaction to a drug or other agent;

(e) Authenticated orders for:

(i) Any drug or other therapy administered to a patient;

(ii) Any diet served to the patient;

(iii) Any standing medical orders used in the care and treatment of the patient except standing medical emergency orders; and

(iv) Any restraint of the patient.

(f) Reports on all:

(i) Roentgenologic examinations;

(ii) Clinical laboratory tests or examinations;

(iii) Macroscopic and microscopic examinations of tissue;

(iv) Other diagnostic procedures or examinations performed upon the patient; and

(v) Specimens obtained from the patient.

(g) An entry on each administration of therapy, including drug therapy, to the patient;

(h) Entries on nursing services to the patient including:

(i) A report on all significant nursing observations and assessments of the patient's condition or response to care and treatment;

(ii) Nursing interventions and other significant direct nursing care including all administration of drugs or other therapy;

(iii) An entry on the time and reason for each notification of a physician or patient's family regarding a significant change in the patient's condition; and

(iv) A record of other significant nursing action on behalf of the patient.

(i) An entry on any significant health education, training, or instruction provided to the patient or family related to the patient's health care;

(j) An entry on any social services provided the patient;

(k) An entry regarding:

(i) Any adverse drug reaction of the patient; and

(ii) Any other untoward incident or accident occurring during hospitalization or outpatient visit and involving the patient.



(l) Operative report or reports on all surgery performed upon the patient;

(m) An entry or report on each anesthetic administered to the patient;

(n) Report or reports on consultation or consultations concerning the patient;

(o) Reports on labor, delivery, and postpartum period for any woman giving birth to a child in the hospital;

(p) Infant status data for any infant born in or enroute to the hospital including:

(i) The date and time of birth;

(ii) Condition at birth or upon arrival at the hospital;

(iii) Sex; and

(iv) Weight, if condition permits weighing.

(q) Progress notes describing the results of treatment and changes in the patient's condition and portraying the patient's clinical course in chronological sequence;

(r) In the event of an inpatient leaving without medical approval, an entry on:

(i) Any known events leading to the patient's decision to leave;

(ii) A record of notification of the physician regarding the patient's leaving; and

(iii) The time of the patient's departure.

(s) Discharge data including:

(i) The final diagnosis or diagnoses;

(ii) Any associated or secondary diagnoses or complications; and

(iii) The titles of all operations performed upon the patient; and

(iv) A discharge summary for any inpatient whose hospitalization exceeded forty-eight hours, except a normal newborn infant or normal obstetrical patient, to:

(A) Recapitulate significant clinical findings and events during the patient's hospitalization;

(B) Describe the patient's condition upon discharge or transfer; and

(C) Summarize any recommendations and arrangements for future care of the patient.

(t) An entry on any transmittal of medical and related data regarding the patient to a health care facility or agency or other community resource when the patient was referred or transferred;

(u) In event of the patient's death in the hospital, entries, reports, and authorizations including:

(i) A pronouncement of death;

(ii) An authorization for the autopsy, if performed;

(iii) A report on the autopsy, if performed, including findings and conclusions; and

(iv) An entry on release of the patient's body to a mortuary or coroner or medical examiner.

(v) Written consents, authorizations, or releases given by the patient or, if the patient was unable to give such consents, authorizations, or releases, by a person or agency with legal authority over the person of the patient;

(w) The relationship, legal or familial, of the signer to the patient clearly stated when a person other than the patient gives written consent, or authorizes treatment, or signs a release.

(6) Hospitals shall regard materials obtained through procedures employed in diagnosing a patient's condition or assessing the patient's clinical course as original clinical

evidence excluded from requirements for content of medical records in subsection (5) of this section. Original clinical evidence includes, but is not limited to:

(a) X-ray films;

(b) Laboratory slides;

(c) Tissue specimens; and

(d) Medical photographs.

(7) Registers.

(a) Hospitals shall maintain current registers with data entered in chronological order including:

(i) An inpatient register containing at least the following data for each inpatient admission:

(A) The patient's identifying number;

(B) The patient's full name, and birth date or age; and

(C) The date of the patient's admission.

(ii) One or more outpatient registers other than registers for emergency care services to:

(A) Contain sufficient data on each outpatient to ensure positive identification; and

(B) Permit rapid retrieval of all of the outpatient's medical record or records when indicated.

(iii) An emergency service register as required under WAC 246-318-350 (6)(a);

(iv) An operation register containing at least the following data for each operation performed in a hospital surgery:

(A) The date;

(B) The identifying number and full name of the patient;

(C) The descriptive name of the operation;

(D) The names of the surgeon and the surgeon's assistant or assistants;

(E) The type of anesthesia; and

(F) The name and title of the person who administered the anesthesia.

(b) Hospitals may maintain separate registers or suitable combinations of registers if the combined register contains data for each specific register as required in subsection (7)(a) of this section.

(8) Indexes. Hospitals shall establish and maintain:

(a) A master patient index containing a master reference card or equivalent for each person receiving inpatient or outpatient care or treatment in the hospital.

(i) Master reference cards or equivalent shall contain:

(A) The patient's medical record number or numbers;

(B) The patient's full name; and

(C) The patient's date of birth.

(ii) Master patient indexes may be omitted for:

(A) Referred outpatients; and

(B) Outpatient emergency patients provided the hospital retains and preserves an emergency service register for the same period of time as the medical record.

(b) Current indexes with required entries on index cards or equivalent completed within three months after discharge or transfer of the patient;

(c) A disease index containing index cards or equivalent for all categories of diseases or conditions treated in the hospital on an inpatient basis with entries on index card or cards for a given category of disease including:

(i) The identifying number, sex, and age of each patient treated for that category of disease; and

(ii) The code for the particular disease or condition for which each patient was treated.



(d) An operation index containing index cards or equivalent for all categories of operations performed in a hospital surgery on an inpatient or outpatient basis with entries on the index card or cards for a given category of operation with:

(i) Identifying information including the medical record number, age, and sex of each patient upon whom that category of operation was performed; and

(ii) The code for the particular operative procedure performed upon each patient.

(e) Codes for entries in the disease and operation indexes in accordance with the coding system and the recognized diagnostic classification system of disease and operation nomenclature adopted by the hospital;

(f) A physicians' index, separate or combined with the disease and operation indexes, as follows:

(i) A combined physician's-disease operation index with the name or code number of the physician treating the patient to whom a particular entry pertains; or

(ii) A separate physicians' index containing:

(A) A record for every member of the hospital's medical staff; and

(B) Entries on each physician's index card or equivalent record including the medical record number or name of each patient the particular physician treated in the hospital on an inpatient basis.

(9) Reports on hospital services. Hospitals shall prepare the following separate or combined reports:

(a) Census reports including:

(i) A daily inpatient census report on admissions to inpatient services, births, and discharges including deaths and transfers to another health care facility; and

(ii) Regular monthly or more frequent reports on admissions to outpatient services and the number of emergency care patients.

(b) Analyses of hospital services.

(10) Storage, handling, and control of medical records and other medical data. Hospitals shall:

(a) Control access to patients' individual medical records and other personal or medical data on patients;

(b) Prevent access to records by unauthorized persons;

(c) Protect medical records and other personal and medical data from undue deterioration or destruction; and

(d) Maintain a system permitting easy retrieval of medical records and information for medical or administrative purposes.

(11) Retention, preservation, and final disposal of medical records and other patient care data and reports.

(a) Hospitals shall retain and preserve:

(i) Each patient's medical record or records, excluding reports on referred outpatient diagnostic services for a period of:

(A) No less than ten years following the most recent discharge of the adult patient; or

(B) For patients who are minors at the time of care, treatment, or diagnosis, no less than three years following the date upon which the minor patient attained the age of eighteen years or ten years following the most recent discharge, whichever is longer.

(ii) Reports on referred outpatient diagnostic services for at least two years;

(iii) A master patient index card (or equivalent) for at least the same period of time as the medical record or

records for the patient to whom the master patient index card or equivalent pertains;

(iv) Data in the inpatient and outpatient registers for at least three years;

(v) Data in an emergency service register for at least the same period of time as the medical record or records for any patient on whom data were entered in the register;

(vi) Data in the operation register, the disease and operation indexes, the physicians' index, and annual reports on analyses of hospital services for at least three years; and

(vii) Patients' medical records, registers, indexes, and analyses of hospital service in original form or in photographic form in accordance with the provisions of chapter 5.46 RCW.

(b) A hospital may elect to retain and preserve an emergency service register for only three years after last entry if the hospital includes all outpatient emergency care patients in the master patient index.

(c) During final disposal, each hospital shall prevent retrieval and subsequent use of any data permitting identification of individuals in relation to personal or medical information.

(d) In event of transfer of ownership of the hospital, the hospital shall keep patients' medical records, registers, indexes, and analyses of hospital services in the hospital to be retained and preserved by the new owner in accordance with state statutes and regulations.

(e) If the hospital ceases operation, the hospital shall:

(i) Make immediate arrangements for preservation of its medical records and other records of or reports on patient care data in accordance with applicable state statutes and regulations; and

(ii) Obtain approval of the department for the planned arrangements prior to the cessation of operation.

(12) Records kept by approved eye banks pursuant to WAC 246-333-040 are not medical records or registers within the meaning of this section.

(13) Nothing in these regulations shall be construed to prohibit hospitals from collecting additional health and/or medical information or retaining medical records beyond the statutory requirements.

[Statutory Authority: RCW 70.41.030. 92-02-018 (Order 224), § 246-318-440, filed 12/23/91, effective 1/23/92. Statutory Authority: RCW 43.70.040. 91-02-049 (Order 121), recodified as § 246-318-440, filed 12/27/90, effective 1/31/91. Statutory Authority: RCW 70.41.030. 88-18-021 (Order 2680), § 248-18-440, filed 8/30/88; 85-23-020 (Order 2305), § 248-18-440, filed 11/13/85; Order 142, § 248-18-440, filed 2/8/77; Order 135, § 248-18-440, filed 12/6/76; Order 119, § 248-18-440, filed 5/23/75; Regulation 18.440, effective 3/11/60.]

**WAC 246-318-450 Discharge planning.** Hospitals shall:

(1) Establish and maintain a system for discharge planning and designate a person responsible for system management and implementation;

(2) Establish written policies and procedures to:

(a) Identify patients needing further nursing, therapy, or supportive care following discharge from the hospital;

(b) Develop a documented discharge plan for each identified patient including:

(i) Coordinate with patient and family or caregiver, as appropriate;

- (ii) Coordinate with appropriate members of the health care team; and
- (iii) Coordinate with the receiving agency or agencies, when necessary.
- (c) Notify referral agencies, minimally to include verbal contact and communication regarding:
  - (i) Relevant patient history;
  - (ii) Specific care requirements including equipment, supplies, and medications needed; and
  - (iii) Date care is to be initiated.
- (d) For those patients identified under subsection (2)(a) of this section, assess and document needs and implement discharge plans to the extent possible by the hospital.

[Statutory Authority: RCW 43.70.040, 91-02-049 (Order 121), recodified as § 246-318-450, filed 12/27/90, effective 1/31/91. Statutory Authority: RCW 70.41.030, 88-18-020 (Order 2679), § 248-18-445, filed 8/30/88.]

## NEW CONSTRUCTION REGULATIONS

**WAC 246-318-500 Applicability of WAC 246-318-500 through 246-318-99902.** (1) These regulations apply to new construction of hospitals as defined in RCW 70.41.020 including:

- (a) New buildings to be used as hospitals;
- (b) Additions to existing buildings to be used as hospitals;
- (c) Conversions of existing buildings or portions thereof for use as hospitals;
- (d) Alterations other than minor alterations to existing hospitals.

(2) These regulations apply to facilities generally required within a hospital, with the following provisions:

- (a) The department may not require facilities for certain services when the hospital has a definite arrangement for adequate services from suitably located facilities outside the hospital.
- (b) The department may approve the omission of facilities for certain services that will not be provided in accordance with legally allowable and customarily recognized limitations.
- (c) A hospital providing facilities not specifically required by these regulations shall assure that facilities are adequate for the services to be performed and meet the objectives of these regulations.

(3) Compliance with the regulations in this chapter does not constitute release from the requirements of applicable state and local codes and ordinances. Where regulations in this chapter exceed other codes and ordinances, the regulations in this chapter shall apply.

[Statutory Authority: RCW 70.41.030, 93-07-011 (Order 338), § 246-318-500, filed 3/5/93, effective 4/5/93. Statutory Authority: RCW 43.70.040, 91-02-049 (Order 121), recodified as § 246-318-500, filed 12/27/90, effective 1/31/91. Statutory Authority: RCW 70.41.030 and 43.20.050, 83-19-058 (Order 269), § 248-18-500, filed 9/20/83. Statutory Authority: RCW 70.41.30 [70.41.030], 81-05-029 (Order 209), § 248-18-500, filed 2/18/81; Order 119, § 248-18-500, filed 5/23/75; Order 50, § 248-18-500, filed 12/17/70; Regulation 18.500, filed 1/25/62.]

**WAC 246-318-501 Legal authority of the department.** See RCW 70.41.030.

[Statutory Authority: RCW 43.70.040, 91-02-049 (Order 121), recodified as § 246-318-501, filed 12/27/90, effective 1/31/91. Statutory Authority:

1985 c 213, 86-08-002 (Order 2348), § 248-18-999, filed 3/20/86; Order 119, § 248-18-999, filed 5/23/75; Regulation 18.999, effective 3/11/60.]

**WAC 246-318-510 Programs, drawings and construction.** (1) Drawings and specifications for new construction shall be prepared by, or under the direction of, an architect registered under chapter 18.08 RCW. The services of a consulting engineer registered under chapter 18.43 RCW shall be used for the various branches of the work where appropriate. The services of a registered professional engineer may be used in lieu of the services of an architect if work involves engineering only. A hospital may request an exception to the requirements of this subsection by submitting to the department a written description of the proposed construction and justification for not using the services of an architect and/or engineer.

(2) A hospital shall submit the program and drawings for new construction to the department for review as specified in this subsection and the *"Submissions Guide for Health and Residential Facility Construction Projects"* available from the department. Identify each room, area and item of fixed equipment and major movable equipment on all drawings to demonstrate that the required facilities for each function have been provided.

(a) A written program containing, at a minimum: (i) Information concerning services to be provided and operational methods to be used which will affect the extent of facilities required by these regulations; and (ii) if the project involves an addition or alteration which materially increases the bed capacity of the hospital, a thorough appraisal of all existing supporting services to determine their adequacy for the increased number of patients.

(b) Preliminary drawings of the new construction including major equipment. For alterations and additions, include a functional layout of the existing building.

(c) Detailed working drawings and specifications including mechanical and electrical work.

(d) If carpets are to be used:

(i) A floor plan showing areas to be carpeted and adjoining areas. These areas shall be labeled, according to function, and meet the requirements in WAC 246-318-540 (6)(b). Proposed carpeted areas shall be coded on the plan and keyed to the appropriate carpet; and

(ii) Specifications and radiant panel and smoke density test reports showing that proposed carpeting meets the specifications as listed in 246-318-540(6).

(3) A hospital shall:

(a) Commence construction, of other than minor alterations only after the final drawings and specifications have been stamped "construction authorized" by the department. Such authorization by the department does not constitute release from the requirements contained in these regulations.

(b) Notify the department when construction is commenced and completed.

(c) Provide for the safety and comfort of patients if construction takes place in or near occupied areas.

(d) Assure construction is completed in compliance with the final "construction authorized" drawings and specifications.

(e) Submit to the department for review any addenda or modifications which might affect the fire safety or functional operation.

(4) The department shall identify the sections and items of chapter 246-318 WAC under which a requirement is stated or a deficiency noted in any written review report of a functional program, drawings or specifications and in any on-site inspection report of a construction project.

[Statutory Authority: RCW 70.41.030. 93-07-011 (Order 338), § 246-318-510, filed 3/5/93, effective 4/5/93. Statutory Authority: RCW 43.70.040. 91-02-049 (Order 121), recodified as § 246-318-510, filed 12/27/90, effective 1/31/91. Statutory Authority: Chapter 70.41 RCW. 90-12-014 (Order 061), § 248-18-510, filed 5/30/90, effective 6/30/90. Statutory Authority: RCW 70.41.30 [70.41.030]. 81-05-029 (Order 209), § 248-18-510, filed 2/18/81. Statutory Authority: RCW 43.20.050. 80-03-062 (Order 193), § 248-18-510, filed 2/26/80; Order 123, § 248-18-510, filed 3/18/76; Order 119, § 248-18-510, filed 5/23/75; Order 9, § 248-18-510, filed 1/2/69; Regulation 18.520(2)(d), filed 8/4/67; Regulation 18.520 (part), filed 1/25/62.]

**WAC 246-318-520 Design and construction standards, general.** (1) A hospital may request an exemption, substitution, or interpretation as described in WAC 246-318-015.

(2) At least once every two years, the department shall:

(a) Review industry standards referenced in the construction section of chapter 246-318 WAC and update, as necessary; and

(b) Adopt the revised list of referenced standards, if required.

(3) Hospitals shall:

(a) Prepare preliminary documents for hospital construction projects conforming to industry standards, guides, and codes appearing in the current chapter 246-318 WAC;

(b) Follow the requirements of chapter 246-318 WAC effective at the time the preliminary document was submitted for the duration of construction project;

(4) A hospital may request in writing, department approval to use a more recent edition of an industry standard, guide, or code. The department may approve such request under the following conditions:

(a) The standard, guide, or code was adopted after preliminary drawings were developed; and

(b) The request is received by the department prior to the department's final approval of project design and authorization for construction per WAC 246-318-510 (3)(a).

[Statutory Authority: RCW 70.41.030. 93-07-011 (Order 338), § 246-318-520, filed 3/5/93, effective 4/5/93. Statutory Authority: RCW 43.70.040. 91-02-049 (Order 121), recodified as § 246-318-520, filed 12/27/90, effective 1/31/91. Statutory Authority: RCW 70.41.030. 89-22-105 (Order 009), § 248-18-515, filed 11/1/89, effective 12/2/89; 88-23-083 (Order 2729), § 248-18-515, filed 11/18/88. Statutory Authority: 1985 c 213. 86-08-002 (Order 2348), § 248-18-515, filed 3/20/86. Statutory Authority: RCW 70.41.30 [70.41.030]. 81-05-029 (Order 209), § 248-18-515, filed 2/18/81; Order 119, § 248-18-515, filed 5/23/75; Order 50, § 248-18-515, filed 12/17/70; Order 22, § 248-18-515, filed 6/27/69; Regulation 18.530, filed 1/25/62.]

**WAC 246-318-530 Site and site development.** Hospitals planning site and site development for construction of a new facility shall:

(1) Provide a site with:

(a) Road surface useable in all weather and traffic conditions;

(b) Adequate utilities meeting requirements in WAC 246-318-540 (4)(a), (b), and (k);

(c) Natural drainage or properly designed/engineered drainage system; and

(d) Ready access to fire fighting and police services.

(2) Plan for:

(a) Service roads and parking;

(b) Patient privacy and surroundings;

(c) Noise attenuation;

(d) Future expansion; and

(e) On-site sewage disposal area meeting requirements in chapter 246-272 WAC when no public sewer system is available.

(3) Provide parking area, drives, and walkways:

(a) Convenient for patients, staff, and visitors, avoiding interference with patient privacy and comfort;

(b) Adequate number of parking spaces;

(c) Arranged to prevent conflicting traffic;

(d) Graded for adequate drainage and constructed for use under all weather conditions;

(e) Surface treated to minimize dust;

(f) Illuminated at night; and

(g) Meeting accessibility requirements in WAC 51-20-3100.

(4) Plan sufficient space and location for:

(a) Entrances;

(b) Emergency vehicle access;

(c) Loading dock;

(d) Garbage storage and disposal;

(e) Removal of deceased;

(f) Service vehicle access;

(g) Patient entrance located near outpatient facilities meeting accessibility requirements in WAC 51-20-3100; and

(h) Service entrance close to storage and elevators.

[Statutory Authority: RCW 70.41.030. 93-07-011 (Order 338), § 246-318-530, filed 3/5/93, effective 4/5/93. Statutory Authority: RCW 43.70.040. 91-02-049 (Order 121), recodified as § 246-318-530, filed 12/27/90, effective 1/31/91. Statutory Authority: Chapter 70.41 RCW. 90-12-014 (Order 061), § 248-18-520, filed 5/30/90, effective 6/30/90. Statutory Authority: RCW 70.41.030 and 43.20.050. 83-19-058 (Order 269), § 248-18-520, filed 9/20/83; Order 119, § 248-18-520, filed 5/23/75; Order 106, § 248-18-520, filed 1/13/75; Regulation 18.540, filed 1/25/62.]

**WAC 246-318-540 General design requirements.** Hospitals planning new construction shall include the general design elements in this section.

(1) A hospital shall ensure the safety of occupants during construction and painting by assuring rooms or areas are well-ventilated, unoccupied, and unavailable for use until free of volatile fumes and odors.

(2) A hospital shall assure architectural components meet Washington state building code requirements in chapter 51-20 WAC, including:

(a) Aisles between fixed elements wide enough to allow unimpeded movement of equipment and personnel within rooms or suites;

(b) Ceiling heights meeting requirements in Table 540-1;

(c) A corridor system throughout the hospital designed for traffic circulation providing patient privacy and preventing through traffic in examination, observation, treatment, and diagnostic areas, with:

- (i) Width of eight feet and restrictions of no more than seven inches for nonambulatory patient areas;
- (ii) Minimum existing width of seven feet permitted in alteration projects; and
- (iii) Five feet width for corridors serving ambulatory patient traffic within a single department; and
- (iv) Minimum four feet width permitted for nonpatient areas and departments when there is a five-by-five foot turnaround at least every seventy-five feet.
- (d) Handrails on both sides of corridors used by patients on orthopedic units, rehabilitation nursing units, nursing home units, and other long-term nursing units with dimensions as follows:
  - (i) The top of the handrail thirty-two to thirty-four inches above the floor;
  - (ii) A maximum projection of three and one-half inches from wall; and
  - (iii) The end of handrail returning to the wall.
- (e) Doors:
  - (i) With widths meeting requirements in Table 540-1;
  - (ii) Designed to prevent swinging into established corridor widths, except for handicapped accessible toilets and small unoccupied spaces, such as small closets;
  - (iii) Designed to swing to a full, open position in patient rooms;
  - (iv) With provision for staff to gain immediate emergency access to patient occupied rooms; and
  - (v) With vision panels in all pairs of opposite swinging doors.
- (f) At least one elevator in multi-story hospital designed for patient transport with minimum dimensions of:
  - (i) Five feet four inches inside width;
  - (ii) Eight feet six inches inside length; and
  - (iii) Four feet wide door openings.
- (g) Stairways and ramps withskid-resistant surfaces, handrails, guardrails, and other safety devices;
- (h) Design and construction to control entrance and infestation by pests, such as mammals, birds, and insects;
  - (i) Windows in twenty-four-hour stay patient rooms, except in nurseries, with:
    - (i) A clear glass area of at least one-tenth of the floor space;
    - (ii) Location in the outside walls and:
      - (A) Twenty feet or more from another building or opposite wall or court;
      - (B) Ten feet or more from property line except on street side; and
      - (C) Allowance for a satisfactory amount of unobstructed natural light.
    - (iii) Relites may be used on interior atrium walls in place of windows on outside walls;
    - (iv) Sills:
      - (A) No higher than three feet from the floor;
      - (B) No higher than four feet from the floor in critical care rooms;
      - (C) With exterior grade a minimum of six inches below window sill; and
      - (D) With exterior grade sloping away from building for at least ten feet.
    - (v) Sixteen mesh screens on all operable windows.
- (3) A hospital shall provide heating, ventilation, and cooling including:

- (a) A heating system with capacity to maintain a temperature of seventy-five degrees Fahrenheit or more in all patient areas;
- (b) A cooling system with capacity to cool patient areas to a temperature of seventy-five degrees Fahrenheit or below;
- (c) Heating and cooling controls with:
  - (i) Individual thermostatic control in each patient room; and
  - (ii) All other areas suitably zoned and thermostatically controlled consistent with WAC 246-318-99902(2).
- (d) Piping and duct systems which are insulated to control excessive heat transfer and condensation;
- (e) Air balancing of distribution systems to maintain air changes and pressure relationships meeting requirements in Table 540-3;
- (f) An air handling duct system meeting requirements in WAC 246-318-99902(5) with:
  - (i) Fiberglass ducts, if installed, of nonerosive wearing surfaces; and
  - (ii) Fiberglass-lined ducts, if installed, serving sensitive areas with ninety percent efficiency filters installed downstream of the duct lining.
- (g) The use of space above ceilings for exhaust and return plenums is only allowed in nonclinical and nonpatient care areas, such as administrative, public waiting, and meeting areas;
- (h) Air supply and exhaust locations meeting requirements in WAC 246-318-99902(2) and chapter 51-22 WAC including:
  - (i) Outdoor intakes located to the extent practical and possible as follows:
    - (A) Directionally different exposures twenty feet or more from:
      - (I) Combustion equipment stacks;
      - (II) Ventilation exhaust outlets from the hospital or adjoining buildings including fume hoods and ethylene oxide systems;
      - (III) Medical-surgical vacuum systems;
      - (IV) Plumbing vent stacks; and
      - (V) Areas that may collect vehicular exhaust and other noxious fumes.
    - (B) Bottom of intake six feet or more above ground level or three feet or more above roof level specified in WAC 246-318-99902(2).
  - (ii) Locate exhaust air discharge to avoid cross circulation to supply air intakes or operable windows.
- (i) Filters installed in central ventilation or air conditioning systems as follows:
  - (i) Filter beds and filter efficiencies meeting requirements in Table 540-4;
  - (ii) Filter bed No. 2 downstream of the last component of any central air handling unit except:
    - (A) Steam injection-type humidifier permitted downstream of filter bed No. 2;
    - (B) Terminal reheat coils permitted downstream of filter bed No. 2; and
    - (C) Terminal cooling coils permitted downstream of filter bed No. 2 with additional filtration downstream of coil meeting requirements of filter bed No. 2.
- (iii) Filter frames tight to the enclosing duct work; and

(iv) A manometer or equivalent installed across each filter bed serving sensitive areas of central air systems.

(j) Fire shutdown located in accordance with WAC 246-318-99902 (5) and (13).

(k) Exhaust hoods or other approved exhaust devices provided over equipment likely to produce excessive heat, moisture, odors, or contaminants, and properly designed for intended use.

(l) Laboratory hoods for handling infectious materials with:

(i) A minimum face velocity of seventy-five feet per minute at maximum operating level of sash;

(ii) An independent exhaust system with the exhaust fan located at the discharge end of the system;

(iii) Ducts with welded joints or equivalent from the hood to filter enclosure;

(iv) Filters in the exhaust stream rated at 99.97 percent efficiency by the dioctyl-phthalate (DOP) test method; and

(v) Features designed and equipped to permit the safe removal of contaminated filters.

(m) Laboratory hood for venting radioactive particulate aerosols with:

(i) A minimum face velocity of one hundred feet per minute at a maximum operating level of sash;

(ii) An independent exhaust system with an exhaust fan at the discharge end of the system;

(iii) Ducts with welded joints or equivalent from the hood to the filter enclosure;

(iv) Exhaust stream filters with 99.97 percent efficiency using the dioctyl-phthalate (DOP) test method;

(v) Features designed and equipped to permit the safe removal of contaminated filters; and

(vi) Provisions for washdown.

(n) Laboratory hoods for processing strong oxidizing agents with:

(i) A minimum face velocity of one hundred feet per minute at maximum operating level of sash;

(ii) An independent exhaust system and explosion-proof exhaust fan at the discharge end of the system;

(iii) Ducts of welded stainless steel or equivalent throughout the exhaust system; and

(iv) Hood and exhaust duct system equipped with complete coverage washdown facilities.

(o) Noncentral supply ventilation systems serving sensitive areas meeting the filtering requirements in Table 540-4; and

(p) Noncentral supply ventilation systems serving nonsensitive areas, with outdoor air for units meeting filtering requirements for central systems in Table 540-4. Recirculated air to individual room units need not be filtered.

(4) A hospital shall design and install plumbing components meeting requirements in chapters 246-290 and 51-26 WAC and WAC 51-20-3100, including:

(a) Backflow prevention device on water supply and plumbing fixtures;

(b) Trap primers in floor drains and stand pipes subject to infrequent use;

(c) Handwash sinks in each toilet except where provided in connecting single patient room, dressing or locker room;

(d) Skid-resistant floor surfaces in tubs and showers;

(e) Wrist, knee, or foot faucet controls or equivalent and gooseneck spouts:

(i) On handwash sinks in patient rooms;

(ii) In toilet rooms adjoining patient rooms except those for psychiatric patients per program requirements; and

(iii) On all handwash sinks and sinks for personnel use where required to control cross infection. Except a fixture used for soiled functions only and another sink equipped with appropriate controls is located in the same area of the room.

(f) Foot, knee, or equivalent faucet controls and gooseneck spouts on handwash sinks and scrub sinks in:

(i) All nursery rooms;

(ii) Birthing rooms;

(iii) Surgery and delivery;

(iv) Special procedures, emergency treatment and trauma rooms; and

(v) Other sensitive areas.

(g) Drinking fountains or equivalent at suitable locations, with at least one on each floor;

(h) Insulation on:

(i) Hot water piping systems;

(ii) Cold water and drainage piping; and

(iii) Piping exposed to outside temperatures.

(i) Hot water supply meeting requirements in WAC 246-318-99902(2);

(j) Equipment to deliver hot water at temperatures measured at point of use as follows:

(i) One hundred sixty degrees Fahrenheit or more for laundry;

(ii) One hundred twenty degrees Fahrenheit or more for mechanical dishwashers and laundry washers using chemical sanitization;

(iii) One hundred fifty degrees Fahrenheit or more for high temperature sanitization dishwashers; and

(iv) One hundred twenty degrees Fahrenheit or less at handwash sinks and bathing facilities.

(k) Sewage disposal systems meeting requirements in chapters 246-271 and 246-272 WAC;

(l) Vacuum and medical gas systems meeting requirements in WAC 246-318-99902(4) and Table 540-2.

(m) Waste gas evacuation system meeting requirements in Table 540-2.

(5) A hospital shall provide electrical service including:

(a) General service as follows:

(i) Electrical receptacle outlets meeting requirements in Table 540-5;

(ii) All inpatient or outpatient care areas limited to twelve single electrical receptacle outlets or six duplex electrical receptacle outlets, or equivalent, per twenty amp circuit; and

(iii) Electrical receptacle outlets conveniently located to accommodate cleaning equipment and accessories such as floor polishers, vacuums, and televisions.

(b) Service to critical care units and areas as follows:

(i) Dedicated circuits to serve designated electrical receptacle outlets located at the head of each bed;

(ii) Capacity limited to six single electrical receptacle outlets or three duplex electrical receptacle outlets or equivalent per twenty amp circuit; and

(iii) Branch circuit panels located within the area providing ready accessibility to circuit breakers for staff.

(c) Emergency electrical service with:

- (i) Critical emergency power electrical receptacle outlets meeting requirements in Table 540-5; and
- (ii) Additional emergency power and lighting meeting requirements in WAC 246-318-99902(7).
- (d) Lighting fixtures with:
  - (i) Number, type, and location to provide adequate illumination for the functions of each area;
  - (ii) A reading light and control at each bed in the patient rooms conveniently located for patient use;
  - (iii) Protective lens or diffusers on overhead light fixtures in:
    - (A) All patient care areas;
    - (B) Food service areas; and
    - (C) Areas where patient care equipment and supplies are stored or processed;
  - (iv) A night light for each bed located below the level of the bed;
  - (v) Night light switches and general illumination switches located adjacent to the opening side of patient room doors, except in psychiatric patient security and seclusion rooms, locate switches outside of the rooms; and
  - (vi) Lighting fixtures in psychiatric security and seclusion rooms of tamper-resistant design.
- (e) Electrical/electronic equipment including:
  - (i) Call systems meeting requirements in Table 540-6;
  - (ii) Annunciator at department or unit control point and additional staff duty stations such as utility, medication, and nourishment rooms and staff lounges; and
  - (iii) Film illuminators, or equivalent, accommodating at least two x-ray films in all areas where films are viewed, except in private offices.
- (6) A hospital shall provide interior finishes suitable to the function of an area including:
  - (a) Floor finishes with:
    - (i) Easily cleanable surfaces;
    - (ii) Skid-resistant surfaces at entrances and other areas used while wet; and
    - (iii) A coved base integral with floors or top set base with toe tight to the walls.
  - (b) Carpets, if installed:
    - (i) Made from easily cleanable material;
    - (ii) Constructed to prevent or reduce static build-up;
    - (iii) With a finish classification in accordance with WAC 246-318-99902(14);
    - (iv) With an average pile density of 4,000 ounces per cubic yard calculated by:
 

Yarn weight (ounces per square yard) X 36 =	Average pile density
Pile height (inches)	(ounces per cubic yard);
    - (v) With a maximum pile height of .312 inches;
    - (vi) With padding, if used, that is water resistant and permanently bonded to the carpet backing;
    - (vii) Cemented to the floor;
    - (viii) With edges covered and top set base with toe at all wall junctures;
    - (ix) May be used in the following nonpatient occupied areas: Administrative areas, lobbies, lounges, chapels, waiting areas, nurses' station, dining rooms, corridors, equipment alcoves opening onto carpeted corridors. Carpets are not permitted in any areas of the surgery or delivery suites; and

(x) May be used in the following patient occupied areas: Patient rooms (excluding toilets, bathrooms, and designated isolation rooms), coronary care units, recovery rooms (not within surgical suites), labor rooms (not within delivery suites), corridors within patient occupied areas, dayrooms, equipment alcoves opening onto carpeted corridors. Carpets may be used in other areas only upon written approval of such use by the department.

(c) Ceiling finishes or construction with:

- (i) Monolithic or bonded construction in patient rooms of psychiatric nursing units, security and seclusion rooms;
- (ii) Easily cleanable surfaces;
- (iii) Smooth finish without visible joints or crevices in areas where surgical asepsis must be maintained, such as operating rooms, delivery rooms, and emergency treatment rooms;

(iv) Surfaces finished to minimize glare in patient rooms, labor rooms, birthing rooms, operating rooms, delivery rooms, and emergency treatment rooms; and

(v) Surfaces finished to minimize reflection of ultraviolet radiation when ultraviolet radiation generators are used.

(d) Wall finishes meeting requirements in chapter 51-20 WAC with:

- (i) Protection from impact in high traffic areas;
- (ii) Easily cleanable surfaces;
- (iii) Smooth surface without open joints or crevices in areas where surgical asepsis must be maintained, such as operating rooms, delivery rooms, and emergency treatment rooms;

(iv) Surfaces finished to minimize glare in patient rooms and labor rooms and areas in which lasers are used; and

(v) Water-resistant paint, glaze, or similar water-resistant finish extending above the splash line in all rooms or areas subject to splash or spray.

(7) A hospital shall provide accessories for bathroom and toilet rooms with:

- (a) Backing to support mounting all accessories;
- (b) Accessories at bathing facilities, toilets, dressing rooms, and examination rooms, except in psychiatric units as follows:

- (i) Toilet paper holder at water closets;
  - (ii) Towel bar, hook, or ring at bathing facilities; and
  - (iii) Robe hook.
- (c) A mirror and shelving or equivalent at each hand-wash sink in:

- (i) Toilet room,
- (ii) Patient room,
- (iii) Birthing room,
- (iv) Dressing room, and
- (v) Locker room.

(d) Dispensers at all sinks, for single-use towels or equivalent, mounted to avoid contamination from splash and spray;

- (e) Soap at each sink and bathing facility; and
- (f) Grab bars that are easily cleanable, resistant to corrosion, functionally designed, securely mounted, and meet the requirements in WAC 51-20-3100 as follows:

- (i) Mounted on two sides of each standard bathtub and shower; and
- (ii) At least one horizontal grab bar extended eighteen inches or more in front of the water closet.

(g) Accessories in bathing and toilet rooms designated for the handicapped in accordance with WAC 51-20-3100.  
 (8) A hospital shall provide signage for identification of:  
 (a) Rooms and spaces; and  
 (b) Electric panel boards in accordance with WAC 246-318-99902(7).

TABLE 540-1  
 MINIMUM CLEAR OPENING FOR DOORS AND NOMINAL CEILING HEIGHTS

AREA/ROOM NAME	MINIMUM CLEAR OPENING FOR DOORS	NOMINAL CEILING HEIGHT
<b>Anesthetizing and Special:</b>		
Delivery	3'-10"	8'-0"(1)
Fracture	3'-10"	8'-0"
Recovery/post anesthesia care	3'-10"	8'-0"
Surgery	3'-10"	8'-0"(1)
Trauma	3'-10"	8'-0"(1)
Special procedures	3'-10"	8'-0"
<b>Critical Care:</b>		
Intensive care	3'-10"	8'-0"

<b>Nursing:</b>		
Birthing	3'-10" (2)	8'-0"
Nurseries, all	3'-10" (2)	8'-0"
Patient	3'-10" (2)	8'-0"
<b>Radiology and Imaging:</b>		
Computerized tomography scan	3'-10"	8'-0"
Radiation therapy	3'-10"	8'-0"(1)
Fluoroscopy	3'-10"	8'-0"
Nuclear medicine	3'-10"	8'-0"
X-ray	3'-10"	8'-0"
<b>Diagnostic and treatment:</b>		
Physical treatment therapy	3'-10" (2)	8'-0"
<b>General:</b>		
Bathrooms and toilets	2'-8" (3)	7'-6"

**NOTES:**

- (1) Greater than 8'-0" ceiling heights may be necessary due to equipment to be used in room.
- (2) Existing 3'-8" clear opening door permitted in alterations.
- (3) Existing 2'-6" clear opening door permitted in alterations except in nursing home rehabilitation units.

TABLE 540-2  
 MEDICAL GASES, VACUUM, AND WASTE GAS EVACUATION

AREA/ROOM NAME	MEDICAL GASES				WASTE GAS EVACUATION I
	OXYGEN	MEDICAL AIR	NITROUS OXIDE	VACUUM	
<b>Anesthetizing and Special:</b>					
Cystoscopic	D	E		D	
Endoscopy	E			E	
Delivery	B,G	A,G	A	D,G	E
Operating	B	A	A	D,H	E
Operating patient hold area	B			B	
Recovery	B	A-Infants Only		C	
Recovery (ECT)	A			A	
Recovery (delivery)	A,G	G		B,G	
Special procedures	D	E	I	D	I
Trauma	D	E	I	D	I
<b>Critical Care:</b>					
Coronary care	B	B		C	
Intensive care	B	B		C	
<b>Nursing:</b>					
Birthing (Labor, Delivery and Recovery)	A,G			A,G	
Examination, treatment	A			A	
Labor	B			B	
Medical, surgical and obstetrical	B			B	
Pediatrics	B	B		B	
<b>Nursery:</b>					
Intermediate care	F	F		B	
Neonatal intensive care	F	F		B	
Newborn	A			A	
<b>Radiology and Imaging:</b>					
Imaging services	B			B	



**Diagnostic and Treatment:**

Autopsy					E	
Emergency treatment	A		E		E	I
Dialysis	J				J	
Treatment	J				J	

**NOTES:**

- A One outlet accessible to each bed, stretcher, bassinet, or equivalent; one outlet may serve two beds or two bassinets.  
 B Separate outlet for each bed, stretcher, bassinet, or equivalent.  
 C Two outlets for each bed.  
 D Two outlets per room intended for one patient at any one time.  
 E One outlet per room.  
 F Two outlets per station.  
 G Separate outlets for infants.  
 H If used for delivery, must include G.  
 I Required only when general anesthesia is used.  
 J Portable equipment may be used in a ratio of one for every five bed, stretcher, bassinet, or equivalent with a minimum of one unit.

TABLE 540-3  
 GENERAL PRESSURE RELATIONSHIPS AND  
 VENTILATION OF CERTAIN HOSPITAL AREAS

Area/Room Name	Pressure Relation-Ship To Adjacent Areas	Minimum Air Changes Of Outdoor Air Per Hour Supplied To Room	Minimum Total Air Changes Per Hour Supplied To Room	All Air Exhausted Directly To Outdoors	Recirculated Within Room Units
<b>Anesthetizing and Special:</b>					
Operating and obstetrical delivery (recirculating air system)	P	3	15	Optional	No <sup>1</sup>
Operating and obstetrical delivery (all outdoor air system) <sup>6</sup>	P	15	15	Yes	No
Special procedures	P	2	6	Optional	Optional
Endoscopy	N or E	2	6	Yes	No
Recovery/post anesthesia care	P	2	6	Optional	No <sup>1</sup>
Trauma <sup>2</sup>	P	3	15	Optional	No <sup>1</sup>
<b>Critical Care:</b>					
Intensive care	P	2	6	Optional	No
<b>Nursing:</b>					
Birthing	P	2	2	Optional	No <sup>1</sup>
Nursery, newborn	P	2	6	Optional	No <sup>1</sup>
Patient	NA	2	2	Optional	Optional
Patient Corridor	NA	2	4	Optional	Optional
Patient isolation <sup>3</sup>	N or P <sup>8</sup>	2	6	Yes	No
Patient isolation alcove or anteroom <sup>3</sup>	N or P <sup>8</sup>	2	10	Yes	No
Patient toilet	N	Optional	10	Yes	No
<b>Radiology and Imaging:</b>					
Darkroom	N	2	10	Optional	No
X-ray	NA	2	6	Optional	Optional
<b>Diagnostic and Treatment:</b>					
Autopsy	N	2	12	Yes	No
Body holding, nonrefrigerated <sup>4</sup>	N	Optional	10	Yes	No
Examination	N or P <sup>8</sup>	2	6	Optional	Optional
Medication	P	2	4	Optional	Optional
Nuclear medicine	N	2	6	Yes	No
Pharmacy	P	2	4	Optional	Optional
Physical therapy and hydrotherapy	N	2	6	Optional	Optional
Treatment	N or P <sup>8</sup>	2	6	Optional	Optional
<b>Laboratory:</b>					
Bacteriology	N	2	6	Yes	No
Biochemistry	P	2	6	Optional	No

Cytology	N	2	6	Yes	No
Glass washing	N	2	10	Yes	Optional
Histology	N	2	6	Yes	No
Media transfer	P	2	4	Optional	No <sup>2</sup>
Pathology	N	2	6	Yes	No
Serology	P	2	6	Optional	No
Sterilizing	N	Optional	10	Yes	No
<b>Central Service:</b>					
Clean workroom and sterile storage	P	2	4	Optional	Optional
ETO sterilizer <sup>7</sup>	N	2	10	Yes	No
Sterilizer equipment	N	Optional	10	Yes	No
Laundry	N	2	10	Yes	No
Soiled receiving/decontamination	N	Optional	10	Yes	No
<b>Kitchen and Dietary:</b>					
Dietary dry storage	NA	Optional	2	Optional	No
Food preparation centers <sup>5</sup>	NA	2	10	Yes	No
Ware washing	N	Optional	10	Yes	No
<b>General:</b>					
Bathing facility	N	Optional	10	Yes	No
Bedpan dump	N	Optional	10	Yes	No
Janitors closet	N	Optional	10	Yes	No
Utility, clean	P	2	4	Optional	Optional
Utility, soiled	N	2	10	Yes	No

**ABBREVIATIONS:**

N = Negative

P = Positive

NA = Not Applicable (Continuous Direction Control Not Required)

E = Equal

**NOTES:**

- 1 Recirculating room units meeting the filtering requirements for the space may be used.
- 2 The term "trauma room" used in Table 540-3 is the operating room space in the trauma center routinely used for emergency surgery. The first aid room and/or "emergency room" used for general initial treatment of accident victims may be ventilated as noted for the "treatment room."
- 3 The isolation rooms described in the standards might be used in the average community hospital. The assumption is the isolation procedures will be for infectious patients and the room should also be suitable for normal private patient use when not needed for isolation.
- 4 The nonrefrigerated body-holding room would be applicable only for facilities not performing autopsies on site and using the space for a short period while waiting for body transfer to be completed.
- 5 Food preparation centers shall have ventilation systems with an excess of air supply for positive pressure when hoods are not in operation.
- 6 The number of air changes may be reduced when areas are not occupied.
- 7 See WAC 246-318-99902(8) and 296-62-07355 general occupational health standards for ethylene oxide.
- 8 In accordance with program plan and function of room.

TABLE 540-4  
VENTILATION AND AIR CONDITIONING SYSTEMS  
FILTER EFFICIENCIES IN HOSPITALS

AREA/ROOM NAME	FILTER BED 1 %	FILTER BED 2 %
<b>Anesthetizing and Special:</b>		
Operating and delivery	25	90
Organ transplant	25	90 (A)
Recovery/post anesthesia care	25	90
Special procedures	25	90
<b>Critical Care:</b>		
Intensive and CCU	25	90
<b>Nursing:</b>		
Birthing	25	90 (B)
Labor	25	90 (B)
Nursery, newborn	25	90
Patient	25	90 (B)
Patient treatment	25	90 (B)
Postpartum	25	90 (B)
<b>Radiology and Imaging:</b>		
X-Ray	25	90 (B)
Fluoroscopy	25	90 (B)
<b>Laundry:</b>	80	NA
<b>Kitchen and Dietary:</b>		
Food preparation	80	NA
Storage, bulk	25	NA
<b>General:</b>		
Administration	25	NA
Utility, soiled	25	NA

**NOTES:**

(A) 99.9% recirculating air.

(B) 80% acceptable with total outside air.

NA Not applicable.

TABLE 540-5  
PATIENT CARE AREA  
SINGLE ELECTRICAL RECEPTACLE OUTLET REQUIREMENTS

AREA/ROOM NAME	LOCATION IN ROOM (*ACCORDING TO PROGRAM UNLESS OTHERWISE STATED)	TOTAL	CRITICAL EMER- GENCY POWER	SPECIAL REQUIREMENTS (*HOSPITAL GRADE)
<b>Anesthetizing and Special:</b>				
Delivery	*	12	12	*
Trauma	*	6	6	*
Patient holding	*	4	4	*
Operating	*	12	12	*
Recovery	Head of each bed	4	4	*
Special procedures	*	12	12	*
Endoscopy	*	6	2	*
Outpatient pre-op/recovery	Each station	4	2	*
<b>Critical Care:</b>				
Intensive care and other	Head of each bed	12	12	*
<b>Nursing:</b>				
Birthing, LDR, LDRP	* for woman and infant	6	2	*
Nursery	Between every two bassinets and *	4	4	*
Nursery, intermediate care	Each station and *	6	6	*
Nursery, neonatal intensive care	Each station and *	12	12	*
Patient	Head of bed	4	2	*
Pediatric	Head of bed	4	2	Tamper- resistant safety receptacles *
Pediatric critical care	Head of bed and *	12	12	*
Psychiatric	Head of bed	2	0	Tamper- resistant safety receptacles
<b>Diagnostic and Treatment:</b>				
Emergency examination	One per wall	4	4	*
Emergency, minor	One per wall	6	6	*
Physical therapy		2(A)	(B)	*
Occupational therapy	*			*
Radiology and imaging	*	(C)		*
Dialysis	Each station	4	D	* (B)
<b>Laboratory:</b>				
General	*			
Critical equipment	*	2	2	(D)
<b>General:</b>				
Patient lavatories		2	0	(B)
Other lavatories		0	0	(B)
All bathing facilities		0	0	(B)

**NOTES:**

- (A) Per treatment area sufficient to support diagnostic and treatment activities.
- (B) Ground fault circuit interrupter required when installed within five feet of wet areas, sinks, and bathing facilities.
- (C) Sufficient to support diagnostic and treatment.

- (D) With grounding conductor and dedicated circuits as required per each piece of equipment and sufficient to support work station.

TABLE 540-6  
CALL SYSTEMS

AREA/ROOM NAME	SYSTEM TYPE	INITIATION INDICATOR		INDICATOR LOCATION
		LOCATION	TYPE	
<b>Anesthetizing and Special:</b>				
Delivery	MES	H	E	E
Emergency receiving/triage	MES	H	E	E
Trauma	PNC	A	B	B
	MES	H,A	E	E
Operating	MES	H	E	C
Electro convulsive therapy	MES	H	E	C
Patient holding area	PNC	A	B	B
Patient induction	PNC	A	B	B
	MES	H	E	E
Recovery stations	PNC	A	G	C
	MES	H		
Special procedures	MES	H	E	E
Pharmacy	MES			
Outpatient pre-op/recovery	PNC	H	G	C
	MES	H,A	E	E
<b>Critical Care:</b>				
Intensive and coronary care	PNC	A	B	B
	MES	H,A	E	E
<b>Nursing:</b>				
Birthing	PNC	A	B	B
	MES	A,H	E	E
Labor	PNC	A	B	B
	MES	H	E	E
Nursery, neonatal intensive care	MES	H		E
Nursery, intermediate care	MES	H	E	E
Nursery, newborn	MES	H	E	E
Nurses station			Annunciator panel for PNC/MES	
Patient dressing	PNC	F	B,D	B
Patient shower,	PNC	A	B	B
bathroom and toilet	PNC	F	B,D	B
Psychiatric activity	MES	H,I,C	C	
Psychiatric patient	MES	H	C	
Psychiatric seclusion	MES	H	C	
<b>Radiology and Imaging:</b>				
Electrocardiography	MES	H	E	E
Electroencephalography	MES	H	E	E
X-ray, Fluoroscopy (CT, MRI, etc.)	MES	H	E	E
<b>Diagnostic and Treatment:</b>				
Blood draw	MES	H	E	E
Exam	PNC	A	B	C
	MES	H	E	E
Treatment	PNC	A	B,C	B,C
	MES	H	E	E
Nuclear medicine	MES	H	E	E
Physical therapy	PNC	I	B,C	B,C
	MES	H	E	E
Occupational therapy	MES	H	E	E
Dialysis station	PNC	H	G	C
<b>General:</b>				
Emergency entrance	Doorbell	Outside hospital door	AS/VL	At a 24-hour monitored duty station

Utilities AS/VL AS/VL Duty station

**Abbreviations:**

- PNC = Patient nurse call
- MES = Medical emergency signal
- AS = Audible signal
- VL = Visual light

**NOTES:**

- A Head of bed.
- B Register by light at corridor door or treatment area and register by light and audible signal at the nurses' station and duty stations.
- C Call signals initiated by staff within a department by remote or other means to register at a staff control point from which assistance is always available.
- D Signals from toilets and bathing facilities to have distinctive light and distinctive audible signals.
- E Medical emergency system devices to register by distinctive light at the corridor door. Nurses' station annunciator or equivalent shall identify point of origin by a distinctive light and distinctive audible signal. Signal device to be reset only by staff at the point of origin. Distinctive visual and distinctive audible signals at locations from which additional staff assistance is always available.
- F A properly located signal device mounted no higher than six feet above the floor and activated by a nonconductive pull cord within easy grasp by a patient slumped forward on the floors of either the toilet, bathing facility, or dressing room.
- G Register by light and outside each patient station or register by light and audible signal at the nurses' station.
- H Properly located signal device within easy reach by staff.
- I Any area not within direct observation.
- J May be integrated with other systems.

[Statutory Authority: RCW 70.41.030. 93-07-011 (Order 338), § 246-318-540, filed 3/5/93, effective 4/5/93. Statutory Authority: RCW 43.70.040. 91-02-049 (Order 121), recodified as § 246-318-540, filed 12/27/90, effective 1/31/91. Statutory Authority: Chapter 70.41 RCW. 90-12-014 (Order 061), § 248-18-719, filed 5/30/90, effective 6/30/90. Statutory Authority: RCW 70.41.030. 89-22-105 (Order 009), § 248-18-719, filed 11/1/89, effective 12/2/89.]

**WAC 246-318-550 General requirements for support facilities.** Hospitals planning new construction of support facilities shall:

- (1) Follow general design requirements for architectural components, electrical service, lighting, call systems, hardware, interior finishes, heating, plumbing, sewerage, ventilation/air conditioning, and signage in WAC 246-318-540;
- (2) Provide staff facilities with:
  - (a) Space for personal belongings;
  - (b) A toilet; and
  - (c) A handwash sink;
- (3) Provide clean materials room or area with:
  - (a) Storage shelves; and/or
  - (b) Space for carts;
- (4) Provide clean utility room with:
  - (a) A work counter;
  - (b) A handwash sink;
  - (c) Enclosed and/or open storage; and
  - (d) A soap dispenser and single-use hand drying device;

(5) Provide clean-up room separate from the clean materials room or clean utility room, with:

- (a) A clinic service sink;
- (b) A work counter;
- (c) Adequate storage space; and
- (d) A double-compartment sink integral with the counter and space on either side to accommodate equipment and materials to be cleaned;
- (6) Provide housekeeping supply room with:
  - (a) A service sink or equivalent;
  - (b) Soap and towel dispensers or equivalent;
  - (c) A mop rack; and
  - (d) Storage area;
- (7) Provide medication distribution and storage including:

- (a) Room designed to minimize traffic, with:
  - (i) A handwash sink;
  - (ii) A working surface, either on a cart or counter;
  - (iii) Sturdily constructed, lockable drug storage;
  - (iv) An enclosed cabinet or equivalent for storage;
  - (v) Storage space for medication cart when appropriate;

and

- (vi) Space and electrical receptacle for refrigerator; or
- (b) Permanently affixed satellite medication storage units with:

- (i) Convenient access to a refrigerator and sink;
- (ii) A work surface;
- (iii) Sturdy construction; and
- (iv) Positive latching locked doors; or
- (c) Medication distribution carts, stored in locked room or continuously attended area;

(8) Provide soiled materials room separate from clean materials or utility rooms with:

- (a) A clinic service sink, unless a soiled utility room is on the same nursing unit;
- (b) Space for waste container, linen hampers, carts, and other large equipment; and
- (c) A handwash sink or equivalent;
- (9) Provide soiled utility room with:
  - (a) A double-compartment sink large enough to accommodate equipment to be cleaned;
  - (b) A three-foot long work surface which may be moveable;
  - (c) Storage cabinets sufficient to store cleaning supplies;
  - (d) A clinic service sink with bedpan flushing attachment; and

(e) Space for waste containers, linen hampers, and other large equipment;

(10) Provide nourishment facilities in a clean room with:

- (a) A refrigerator;
- (b) A work counter or space;
- (c) A handwash sink;
- (d) Storage for utensils and food stuffs;
- (e) Space for a waste container; and
- (f) A three-compartment sink if area will be used to wash dishes, glasses, or pitchers.

[Statutory Authority: RCW 70.41.030. 93-07-011 (Order 338), § 246-318-550, filed 3/5/93, effective 4/5/93. Statutory Authority: RCW 43.70.040. 91-02-049 (Order 121), recodified as § 246-318-550, filed 12/27/90, effective 1/31/91. Statutory Authority: RCW 70.41.030. 89-22-105 (Order 009), § 248-18-711, filed 11/1/89, effective 12/2/89.]

**WAC 246-318-560 Maintenance and mechanical facilities.** Hospitals planning new construction of maintenance and mechanical facilities shall:

(1) Follow general design requirements for architectural components, electrical service, lighting, hardware, heating, plumbing, sewerage, ventilation/air conditioning, and signage in WAC 246-318-540;

(2) Provide boiler and/or mechanical equipment rooms with insulation, sound deadening and mechanical ventilation to minimize transfer of heat and noise to rooms occupied by patients and employees;

(3) Provide maintenance shop, if planned, located, and designed for easy delivery and removal of equipment and to minimize noise and dust to the rest of the hospital.

[Statutory Authority: RCW 70.41.030. 93-07-011 (Order 338), § 246-318-560, filed 3/5/93, effective 4/5/93. Statutory Authority: RCW 43.70.040. 91-02-049 (Order 121), recodified as § 246-318-560, filed 12/27/90, effective 1/31/91. Statutory Authority: Chapter 70.41 RCW. 90-12-014 (Order 061), § 248-18-705, filed 5/30/90, effective 6/30/90; Order 119, § 248-18-705, filed 5/23/75; Regulation 18.750, filed 1/25/62.]

**WAC 246-318-570 Administrative facilities.** Hospitals planning new construction of administrative facilities shall:

(1) Follow general design requirements for architectural components, electrical service, lighting, hardware, interior finishes, heating, plumbing, sewerage, ventilation/air conditioning, and signage in WAC 246-318-540;

(2) Provide housekeeping facilities meeting requirements in WAC 246-318-550(6) within or adjacent to the administrative facilities;

(3) Provide a lobby with:

- (a) A waiting area;
- (b) A conveniently located public toilet with handwash sink;

(c) A telephone; and

(d) An information desk or signage;

(4) Provide an admitting area with provision for auditory privacy during interviews;

(5) Provide administration offices;

(6) Provide a business office; and

(7) Provide a medical records area with:

- (a) Active and inactive records storage; and
- (b) Total space appropriate for the duration and type of storage planned.

[Statutory Authority: RCW 70.41.030. 93-07-011 (Order 338), § 246-318-570, filed 3/5/93, effective 4/5/93. Statutory Authority: RCW 43.70.040. 91-02-049 (Order 121), recodified as § 246-318-570, filed 12/27/90, effective 1/31/91. Statutory Authority: Chapter 70.41 RCW. 90-12-014 (Order 061), § 248-18-525, filed 5/30/90, effective 6/30/90. Statutory Authority: RCW 70.41.030 and 43.20.050. 83-19-058 (Order 269), § 248-18-525, filed 9/20/83; Order 119, § 248-18-525, filed 5/23/75; Regulation 18.550, filed 1/25/62.]

**WAC 246-318-580 Receiving, storage and distribution facilities.** A hospital planning new construction of receiving, storage, and distribution facilities shall:

(1) Follow the general design requirements for architectural components, electrical service, lighting, hardware, interior finishes, heating, plumbing, sewerage, ventilation/air conditioning, and signage in WAC 246-318-540;

(2) Provide clean supply storage facilities, in addition to the supply facilities in individual departments, with:

(a) At least twenty square feet floor area storage per bed;

- (b) Office space;
- (c) Off-floor storage when appropriate; and
- (d) Accessible handwash sink;

(3) Locate bulk and general supply storage to:

(a) Avoid disturbance to the operation of the hospital; and

(b) Prevent contamination or damage of goods during movement to and from storage;

(4) Provide general storage constructed in accordance with WAC 246-318-540 (2)(h), and to prevent spoilage, contamination, and corrosion of goods stored therein including:

(a) Protection against inclement weather during transfer of supplies;

(b) Secured spaces with appropriate environmental conditions in accordance with federal and state laws and rules on supplies and drug storage if pharmaceuticals are stored; and

(c) Off-floor storage when appropriate;

(5) Provide receiving and unloading area or areas with administrative work space near receiving and break-out areas and located to:

(a) Provide protection for supplies; and

(b) Prevent vehicle exhaust from entering hospital;

(6) Include at least one break-out area for hospital with:

(a) Indoor space to allow for removal and disposal of outside shipping containers prior to storage or transport to clean areas;

(b) Physical separation from clean storage rooms; and

(c) No restriction of egress;

(7) Provide clean storage rooms designed and equipped for storage of all clean and sterilized items with:

(a) Space for shelving and/or cart storage; and

(b) Fixed storage units and shelving at least six inches above floor and located for easy cleaning;

(8) Provide separate room or rooms for flammable and combustible liquid storage in accordance with WAC 246-318-99902(8);

(9) Provide separate room or rooms for storage of laboratory chemicals in accordance with WAC 246-318-99902(9);

(10) Provide storage of gaseous oxidizing materials in accordance with WAC 246-318-99902(10) for materials including, but not limited to, oxygen, nitrous oxide, fluorine, and chlorine trifluoride with:

(a) Segregation either by space or in a separate room or separate building; and

(b) Nonflammable medical gas systems including oxygen, nitrous oxide, and medical compressed air meeting requirements in WAC 246-318-99902(4).

[Statutory Authority: RCW 70.41.030, 93-07-011 (Order 338), § 246-318-580, filed 3/5/93, effective 4/5/93. Statutory Authority: RCW 43.70.040, 91-02-049 (Order 121), recodified as § 246-318-580, filed 12/27/90, effective 1/31/91. Statutory Authority: RCW 70.41.030 and 43.20.050, 85-05-034 (Order 281), § 248-18-700, filed 2/15/85; Order 119, § 248-18-700, filed 5/23/75; Regulation 18.740, filed 1/25/62.]

**WAC 246-318-590 Central sterilizing and processing service facilities.** Hospitals planning new construction of central sterilizing and processing service facilities shall:

(1) Follow the general design requirements for architectural components, electrical service, lighting, hardware, interior finishes, heating, plumbing, sewerage, ventilation/air conditioning, and signage in WAC 246-318-540;

(2) Provide housekeeping facilities meeting requirements in WAC 246-318-550(6);

(3) Locate central sterilizing and processing service facilities to:

(a) Prevent through traffic;

(b) Avoid contamination of clean and sterile supplies and equipment;

(c) Prevent objectionable heat and noise in patient care areas; and

(d) Facilitate delivery and return of supplies and equipment to and from other services;

(4) Provide central sterilizing and processing service facilities with:

(a) Areas within the unit to provide for proper handling of supplies and equipment;

(b) Work flow designed to maintain separation of clean or sterile items from soiled or contaminated items;

(c) Staff facilities convenient to entrance of central processing/sterilizing facilities including:

(i) Toilet with handwash sink;

(ii) Shower room or area; and

(iii) Change and locker room with storage for clean work attire;

(d) Office room or area:

(i) With communication device; and

(ii) Located to permit access from public areas without entering processing areas;

(5) Locate soiled receiving and decontamination rooms with direct access to preclude transport of soiled or contaminated items through other areas of central processing service with:

(a) Facilities for receiving, disassembling, and cleaning of supplies and equipment physically separated from all other areas of central processing service; and

(b) Work flow from decontamination room directly into clean preparation room;

(6) Provide soiled receiving and decontamination room or rooms with:

(a) Space for soiled collection carts;

(b) An area with a floor drain connected to a sanitary sewerage system for cleaning and disinfecting carts and large equipment unless cart wash facilities are provided elsewhere;

(c) At least one double-compartment sink mounted in or integral with counter with soap dispenser and single-use hand drying device;

(d) Additional sinks or mechanical washers as required by types and volume of items to be processed;

(e) Work counter or equivalent space adjacent to each sink or mechanical washer for collection and separation of soiled or contaminated items and washed items; and

(f) Storage for cleaning supplies and equipment;

(7) Provide clean workroom, preparation and repackaging areas with:

(a) Space and facilities arranged for assembling and packing supplies and equipment for sterilization;

(b) Work surfaces of sufficient size and quantity for assembly of materials and equipment;

(c) Storage;

- (d) Space for mobile equipment;
- (e) Handwash sink located to prevent splash or spray on clean items; and
- (f) A separate room to avoid accumulation and spread of lint, if preparation of linen is a function in central processing;
- (8) Locate sterilizing equipment to facilitate movement of supplies/materials from assembling/packaging to storage of clean and sterile supplies with:
  - (a) Easy access for maintenance;
  - (b) Ventilation according to manufacturer;
  - (c) Unalterable air gap for drain and cross-connection control on all incoming water lines;
  - (d) Pressure sterilizers with recording thermometers and automatic controls; and
  - (e) If ethylene oxide sterilizer is installed, include:
    - (i) Mechanical aerator;
    - (ii) Ventilation in accordance with manufacturer's recommendations and chapter 296-62 WAC;
    - (iii) Separate storage room for ethylene oxide gas cylinder; and
    - (iv) Readily accessible emergency deluge shower with floor drain;
- (9) Provide separate room or area for clean and sterile items including:
  - (a) Provisions for issuance without transport through areas of central processing and sterilizing service; and
  - (b) Enclosed shelves, cabinets, carts, or equivalent if storage is in the preparation area.

[Statutory Authority: RCW 70.41.030, 93-07-011 (Order 338), § 246-318-590, filed 3/5/93, effective 4/5/93. Statutory Authority: RCW 43.70.040, 91-02-049 (Order 121), recodified as § 246-318-590, filed 12/27/90, effective 1/31/91. Statutory Authority: Chapter 70.41 RCW, 90-12-014 (Order 061), § 248-18-680, filed 5/30/90, effective 6/30/90. Statutory Authority: RCW 70.41.030 and 43.20.050, 85-05-034 (Order 281), § 248-18-680, filed 2/15/85; 83-19-058 (Order 269), § 248-18-680, filed 9/20/83; Order 119, § 248-18-680, filed 5/23/75; Regulation 18.700, filed 1/25/62.]

**WAC 246-318-600 Environmental services facilities.** Hospitals planning new construction of environmental services facilities shall:

- (1) Follow the general design requirements for architectural components, electrical service, lighting, hardware, interior finishes, heating, plumbing, sewerage, ventilation/air conditioning, and signage in WAC 246-318-540;
- (2) Provide a primary housekeeping area with:
  - (a) Storage area including:
    - (i) Racks, bins, shelves, or cabinets;
    - (ii) Storage for pesticides, cleaning compounds, and toxic substances, etc.; and
    - (iii) Space for mobile equipment;
  - (b) Cleanup area for large mobile equipment with:
    - (i) Appropriate sink and floor drain; and
    - (ii) Soap dispenser and single-use hand drying device;
  - (c) Waste handling facilities located to prevent objectionable traffic, smoke, and odors in other areas of the hospital including:
    - (i) Incineration facilities, if planned, and storage area with drain connected to sanitary sewer located in separate, well-ventilated room or outside, enclosed space; and
    - (ii) Can wash area, if provided, with floor drain connected to a sanitary sewerage system and hot and cold water.

[Statutory Authority: RCW 70.41.030, 93-07-011 (Order 338), § 246-318-600, filed 3/5/93, effective 4/5/93. Statutory Authority: RCW 43.70.040, 91-02-049 (Order 121), recodified as § 246-318-600, filed 12/27/90, effective 1/31/91. Statutory Authority: Chapter 70.41 RCW, 90-12-014 (Order 061), § 248-18-690, filed 5/30/90, effective 6/30/90. Statutory Authority: RCW 70.41.030 and 43.20.050, 83-19-058 (Order 269), § 248-18-690, filed 9/20/83; Order 119, § 248-18-690, filed 5/23/75; Regulation 18.720, filed 1/25/62.]

**WAC 246-318-610 Laundry facilities.** Hospitals planning new construction of laundry facilities shall:

- (1) Follow the general design requirements for architectural components, electrical service, lighting, hardware, interior finishes, heating, plumbing, sewerage, ventilation/air conditioning, and signage in WAC 246-318-540;
- (2) Provide housekeeping facilities within or adjacent to the laundry facilities meeting requirements in WAC 246-318-550(6);
- (3) Provide laundry facilities with:
  - (a) Adequate space for movement and storage of clean and soiled carts;
  - (b) Separate enclosed soiled linen processing room located to avoid through traffic including:
    - (i) Storage capacity for three days' accumulation of soiled linen;
    - (ii) Handwash sink in or directly adjacent to the room;
    - (iii) Floor drain;
    - (iv) Negative air pressure gradient with direction of air flow from clean side of room to dirty side of room;
    - (v) Convenient location for dispatch to vendor if commercial laundry service is used; and
    - (vi) The following additional provisions if laundry is done on site:
      - (A) Equipment capacity for processing full seven-days laundry in work week;
      - (B) Commercial washing machine;
      - (C) Storage; and
      - (D) Arrangement for uninterrupted work flow from soiled to clean function;
- (4) Provide a separate enclosed clean linen room located to avoid through traffic and sources of moist or contaminated air with:
  - (a) Storage for reserve supply of linens, blankets, and pillows;
  - (b) Positive air pressure gradient;
  - (c) Commercial dryers;
  - (d) A folding area;
  - (e) A sewing area;
  - (f) A space for carts and/or shelves; and
  - (g) Dryer exhaust and make-up air.

[Statutory Authority: RCW 70.41.030, 93-07-011 (Order 338), § 246-318-610, filed 3/5/93, effective 4/5/93. Statutory Authority: RCW 43.70.040, 91-02-049 (Order 121), recodified as § 246-318-610, filed 12/27/90, effective 1/31/91. Statutory Authority: Chapter 70.41 RCW, 90-12-014 (Order 061), § 248-18-695, filed 5/30/90, effective 6/30/90. Statutory Authority: RCW 70.41.030 and 43.20.050, 83-19-058 (Order 269), § 248-18-695, filed 9/20/83; Order 119, § 248-18-695, filed 5/23/75; Regulation 18.730, filed 1/25/62.]

**WAC 246-318-620 Dietary facilities.** Hospitals planning new construction of dietary facilities shall:

- (1) Follow the general design requirements for architectural components, electrical service, lighting, hardware,



interior finishes, heating, plumbing, sewerage, ventilation/air conditioning, and signage in WAC 246-318-540;

(2) Provide housekeeping facilities meeting requirements in WAC 246-318-550(6);

(3) Meet the food service sanitation requirements in chapter 246-215 WAC;

(4) Locate the dietary facility to facilitate:

- (a) Delivery of stores;
- (b) Disposal of kitchen waste; and
- (c) Transport of food to nursing units;

(5) Provide the dietary facility with:

(a) Equipment and counters constructed for easy cleaning and free from inaccessible space which provides harborage for vermin including:

(i) Adequate space between equipment including casework and wall or floor to permit cleaning; and/or

(ii) Equipment tight against wall or floor and joint properly sealed;

(b) Adequate space for moving carts throughout the facility;

(c) Office space;

(d) Receiving area readily accessible to the refrigeration and food storage areas;

(e) At least one dry storage room located in or adjacent to the kitchen with:

(i) Access from an outside delivery entrance;

(ii) Proper construction, ventilation, and temperature to minimize spoilage;

(iii) Space for large containers and mobile equipment;

(iv) Food storage bottom shelves at least six inches above floor; and

(v) Storage units located and designed to allow for easy and regular cleaning of shelves, walls, and floors;

(6) Provide a refrigeration area in or adjacent to the kitchen with refrigeration units containing a minimum of three separate sections or boxes for:

(a) Meats and dairy products;

(b) Fruits and vegetables; and

(c) Prepared food;

(7) Locate kitchen to:

(a) Avoid food contamination from other hospital operations;

(b) Prevent unnecessary traffic through dietary department; and

(c) Prevent objectionable heat, noise, and odors to patient care areas;

(8) Provide kitchen with:

(a) Storage for clean dishes and utensils at least six inches above the floor;

(b) Floor drains;

(c) Space for garbage containers;

(d) Handwash sink convenient to each food preparation area;

(e) Raw or uncooked food, meat, fruit, vegetable preparation area including the following equipment:

(i) Two-compartment sink with indirect drainage and integral drainboard or counter; and

(ii) Work table or counter;

(f) Cooking area including the following equipment:

(i) Range;

(ii) Work table or counter;

(iii) Utensil and cookware storage;

(iv) Sink with indirect drainage; and

(v) Oven;

(g) Salad, sandwich, and dessert assembly area including the following equipment:

(i) Sink with indirect drainage and integral drainboard or counter;

(ii) Refrigerator;

(iii) Work table or counter; and

(iv) Storage cabinets;

(h) Patient tray preparation area with:

(i) Adequate space for mobile equipment such as food tray carts;

(ii) Serving equipment;

(iii) Closed or covered storage units for food containers, dishes, and trays;

(iv) Refrigerator and/or frozen food storage unit; and

(v) Beverage service equipment;

(i) Provision for bulk ice;

(9) Provide employee food service area, if planned, separate from, but convenient to the kitchen;

(10) Locate dining room, if planned, adjacent to employee food service area;

(11) Locate a dishwashing and utensil washing room or area to:

(a) Avoid traffic through other areas of the kitchen; and

(b) Permit unloading of tray carts and receiving of soiled dishes without obstructing traffic in corridors;

(12) Provide dishwashing and utensil washing area or room with:

(a) Two-compartment sink and dishwashing machine or three-compartment sink with integral drainboards or counters;

(b) Prerinse sink with garbage disposal unless dishwasher equipped for prerinse cycle;

(c) Floor drain;

(d) Separate counters for dirty and clean dishes;

(e) Space for garbage can; and

(f) Handwash sink;

(13) Provide garbage handling and storage facilities in a well ventilated room separate from and convenient to the kitchen or in an outside enclosed space with:

(a) Cleanable construction to prevent pest harborage; and

(b) Garbage can wash area with floor drain and hot and cold water;

(14) Provide dietary employees with adjacent facilities meeting requirements in WAC 246-318-550(2).

[Statutory Authority: RCW 70.41.030. 93-07-011 (Order 338), § 246-318-620, filed 3/5/93, effective 4/5/93. Statutory Authority: RCW 43.70.040. 91-02-049 (Order 121), recodified as § 246-318-620, filed 12/27/90, effective 1/31/91. Statutory Authority: Chapter 70.41 RCW. 90-12-014 (Order 061), § 248-18-685, filed 5/30/90, effective 6/30/90. Statutory Authority: RCW 70.41.030 and 43.20.050. 83-07-048 (Order 257), § 248-18-685, filed 3/18/83; Order 119, § 248-18-685, filed 5/23/75; Regulation 18.710, filed 1/25/62.]

**WAC 246-318-630 Laboratory and pathology facilities.** Hospitals planning new construction of laboratory and pathology facilities shall:

(1) Follow the general design requirements for architectural components, electrical service, lighting, call systems, hardware, interior finishes, heating, plumbing, sewerage,

ventilation/air conditioning, and signage in WAC 246-318-540;

(2) Provide a clean-up room meeting requirements in WAC 246-318-550(5); and a housekeeping supply room meeting requirements in WAC 246-318-550(6). Housekeeping facilities may be shared if convenient to the laboratory facilities;

(3) Locate laboratory facility to avoid outpatient traffic through inpatient areas and provide with:

(a) Electrical service including emergency power to critical laboratory areas;

(b) Noise attenuation where applicable;

(c) Piped utility valves and waste line clean-outs accessible for repair and maintenance;

(d) Waiting area;

(e) Work areas for technical, clerical, and administrative staff, files, and storage;

(f) Staff facilities meeting requirements in WAC 246-318-550(2) convenient to the laboratory;

(g) Impermeable work counter or counters with sufficient height, depth, and length to accommodate equipment and procedures;

(h) Knee hole spaces at work stations where appropriate;

(i) Corrosion resistant sinks in testing areas and in accordance with program;

(j) Space for freestanding equipment;

(k) Storage;

(l) Clear aisle width suitable to function and to provide accessibility;

(m) Easily accessible emergency showers with drains and eye washers;

(n) Special drainage as appropriate for equipment and waste disposal;

(o) Blood drawing room or area separate from laboratory testing area including:

(i) Work counter;

(ii) Handwash sink; and

(iii) Space to accommodate wheelchair and infants; and

(p) Wheelchair accessible patient toilet with shelf or equivalent to accommodate specimen collection and handwash sink;

(4) Provide the following if laboratory services are planned:

(a) Specimen preparation area located in or adjacent to laboratory with equipment as required in subsection (3)(a), (e), (g), (i), (j), (k), and (l) of this section;

(b) Media preparation room or area meeting the ventilation requirements in WAC 246-318-540, Table 540-3;

(c) Reagent preparation area including equipment as required in subsection (3)(g), (h), (i), (j), and (k) of this section with:

(i) Space for vibration-free balance table unless available elsewhere in laboratory; and

(ii) Equipment for preparation of reagent water or outlet for piped reagent water prepared elsewhere;

(d) Microbiology area including:

(i) Separate enclosed room or an area located away from traffic flow; and

(ii) Equipment as required in subsection (3)(a), (e), (g), (i), (j), (k), and (l) of this section with the following additional provisions:

(A) Space for special gas cylinders with safety fasteners unless all gas is piped in; and

(B) For highly infectious materials (including but not limited to tubercle bacillus, virus, systemic mycology), an additional enclosed area with counters, sink, storage, and biological safety cabinet or laminar flow hood;

(e) Blood bank area including:

(i) Equipment as required in subsection (3) of this section; and

(ii) A blood bank refrigerator equipped with high and low temperature alarm which signals in staffed area;

(f) Chemistry area including equipment as required in subsection (3)(a), (b), (e), (i), (j), (k), (l), (m), and (n) of this section with the following additional provisions if applicable:

(i) Fume hood when any procedure produces dangerous, toxic, or noxious fumes;

(ii) Special equipment properly vented as per manufacturer's instructions (e.g., atomic absorption); and/or

(iii) Special gases piped in or space for special gas cylinders with safety fasteners;

(g) Cytology and/or histology in a separate area with:

(i) A staining area with forced air exhaust ventilation;

(ii) As necessary, a fume hood to exhaust tissue processing equipment;

(iii) Space for frozen section equipment as needed; and

(iv) Provisions for storing flammable materials used in the area;

(h) Hematology facility located and equipped as required in subsection (3) of this section;

(5) Locate a morgue facility, if planned, to accommodate transport of deceased via least used public corridor or corridors and provide refrigeration for body storage;

(6) Locate an autopsy room, if planned, adjacent to the morgue and provide with:

(a) An autopsy table with water supply, suction outlet, and appropriate drain;

(b) Space for dissection table or counter;

(c) A floor drain;

(d) A scrub sink;

(e) An instrument sterilizer unless provided elsewhere;

(f) A conveniently located changing room, toilet, handwash sink and shower; and

(g) Space for housekeeping equipment;

(7) Locate animal quarters, if planned, apart from laboratory and to avoid annoyance with provisions for:

(a) Food and supply storage;

(b) Handwash sink;

(c) Disposal of wastes and dead animals;

(d) Cleaning and sanitizing of quarters and cages; and

(e) Locked isolation of inoculated animals.

[Statutory Authority: RCW 70.41.030. 93-07-011 (Order 338), § 246-318-630, filed 3/5/93, effective 4/5/93. Statutory Authority: RCW 43.70.040. 91-02-049 (Order 121), recodified as § 246-318-630, filed 12/27/90, effective 1/31/91. Statutory Authority: Chapter 70.41 RCW. 90-12-014 (Order 061), § 248-18-660, filed 5/30/90, effective 6/30/90. Statutory Authority: RCW 70.41.030. 87-23-056 (Order 2560), § 248-18-660, filed 11/18/87. Statutory Authority: RCW 70.41.030 and 43.20.050. 83-19-058 (Order 269), § 248-18-660, filed 9/20/83; Order 119, § 248-18-660, filed 5/23/75; § 248-18-660, filed 10/3/67; Regulation 18.660, filed 1/25/62.]

**WAC 246-318-640 Pharmacy.** Hospitals planning new construction of a pharmacy shall:

(1) Follow the general design requirements for architectural components, electrical service, lighting, call systems, hardware, interior finishes, heating, plumbing, sewerage, ventilation/air conditioning, and signage in WAC 246-318-540;

(2) Provide housekeeping facilities within or adjacent to the pharmacy meeting requirements in WAC 246-318-550(6);

(3) Locate pharmacy in a clean, separate, secure room with:

(a) Storage, including locked storage for Schedule II controlled substances in accordance with WAC 246-873-070 and 246-873-080;

(b) All entrances equipped with closers;

(c) Automatic locking mechanisms on all entrance doors to preclude entrance without a key or combination;

(d) All perimeter walls of the pharmacy and vault constructed full height from floor to underside of structure above;

(e) Security devices or alarm systems for perimeter windows and relites;

(f) An emergency signal device to signal at a location where twenty-four-hour assistance is available;

(g) Space for files and clerical functions;

(h) Break-out area separate from clean areas; and

(i) Electrical service including emergency power to critical pharmacy areas and equipment;

(4) Provide a general compounding and dispensing unit, room, or area with:

(a) A work counter with impermeable surface;

(b) A corrosion-resistant sink, suitable for handwashing, mounted in counter or integral with counter;

(c) Storage space;

(d) A refrigeration and freezing unit; and

(e) Space for mobile equipment;

(5) Provide manufacturing and unit dose packaging area or room, if planned, with the following:

(a) Work counter with impermeable surface;

(b) Corrosion-resistant sink, suitable for handwashing, mounted in counter or integral with counter; and

(c) Storage space;

(6) Locate admixture, radiopharmaceuticals, and other sterile compounding room, if planned, in a low traffic, clean area with:

(a) A preparation area;

(b) A work counter with impermeable surface;

(c) A corrosion-resistant sink, suitable for handwashing, mounted in counter or integral with counter;

(d) Space for mobile equipment;

(e) Storage space;

(f) A laminar flow hood in admixture area; and

(g) Shielding and appropriate ventilation in accordance with WAC 246-318-540 (3)(m) for storage and preparation of radiopharmaceuticals;

(7) Satellite pharmacies, if planned, shall meet the requirements in: Subsections (1), (3)(a), (b), (c), (d), (e), and (f) of this section when drugs will be stored; subsection (3)(g), (h), and (i) of this section, if appropriate; and subsection (4)(a) through (e) of this section and subsection (6)(a) through (g) of this section if planned;

(8) Provide separate outpatient pharmacy, if planned, meeting requirements for satellite pharmacy including:

(a) Easy access;

(b) A conveniently located toilet meeting accessibility requirements in WAC 51-20-3100; and

(c) A private counseling area.

[Statutory Authority: RCW 70.41.030. 93-07-011 (Order 338), § 246-318-640, filed 3/5/93, effective 4/5/93. Statutory Authority: RCW 43.70.040. 91-02-049 (Order 121), recodified as § 246-318-640, filed 12/27/90, effective 1/31/91. Statutory Authority: RCW 70.41.030. 83-13-067 (Order 262), § 248-18-670, filed 6/16/83; Order 119, § 248-18-670, filed 5/23/75; Regulation 18.680, filed 1/25/62.]

**WAC 246-318-650 Radiology and other imaging facilities.** Hospitals planning new construction of radiology and imaging facilities shall:

(1) Follow the general design requirements for architectural components, electrical service, lighting, call systems, hardware, interior finishes, heating, plumbing, sewerage, ventilation/air conditioning, and signage under WAC 246-318-540;

(2) Meet requirements in WAC 246-318-99902(11) and 402-28-032;

(3) Provide clean-up room meeting requirements in WAC 246-318-550(5); and housekeeping supply room meeting requirements in WAC 246-318-550(6);

(4) Locate radiographic room to minimize outpatient traffic through inpatient areas and facilitate transport of patients to and from other hospital services areas;

(5) Provide radiographic room with:

(a) Access for wheeled stretcher or bed movement;

(b) Control area;

(c) Grounding of table, tube stand and controls, and any associated electrical apparatus in accordance with WAC 246-318-99902(7); and

(d) A handwash sink adjacent to radiographic room or rooms;

(6) Provide a contrast preparation area including:

(a) A handwash sink with barium trap;

(b) A work counter; and

(c) Enclosed storage cabinets or movable enclosed storage cabinets;

(7) Provide a processing or dark room or equivalent which is light-tight including:

(a) A safe light that does not fog films;

(b) Developing tank with a thermostatic mixing valve, or automatic film processor with appropriate backflow protection;

(c) Film storage, shielded from stray radiation;

(d) Work counter;

(e) Sink, if dark room is provided; and

(f) Lighting for clean-up and maintenance purposes;

(8) Provide dressing area with rooms or booths for privacy including:

(a) Provision for clean and soiled linen storage in or near dressing rooms; and

(b) At least one booth or room designed to accommodate a wheelchair in or adjacent to the dressing area;

(9) Provide image viewing area with:

(a) Film illuminator or equivalent, for viewing at least two films; and

(b) Location to prevent public view of films;

(10) Provide waiting area with space for wheelchair patients, stretcher patients, and ambulatory patients;

(11) Provide toilet connected to or adjacent to radiographic room or rooms, with ratio of one toilet for every two radiographic rooms;

(12) Provide supply and equipment storage;

(13) Provide administrative facilities with:

(a) Office area, with provision for consultation; and

(b) An active film file area;

(14) Provide staff facilities separate or shared with other service areas meeting requirements in WAC 246-318-550(2);

(15) Provide fluoroscopy room, if planned, meeting requirements in subsection (5) of this section;

(16) Provide angiography room, if planned, meeting requirements in WAC 246-318-850(7);

(17) Provide cardiac laser, cardiac catheterization with angioplasty or valvuloplasty room, if planned, meeting requirements in WAC 246-318-850(8);

(18) Provide computerized tomography or computerized axial tomography (CT) room, if planned, with handwash sink and meeting manufacturer's specifications for installation and safety;

(19) Provide mammography room, if planned, with provisions for patient privacy;

(20) Provide magnetic resonance imaging (MRI) room, if planned, meeting manufacturer's specifications for installation and safety;

(21) Provide nuclear medicine room, if planned, meeting requirements in WAC 246-318-660;

(22) Provide other specialized rooms intended for invasive procedures meeting requirements in WAC 246-318-850(8).

[Statutory Authority: RCW 70.41.030. 93-07-011 (Order 338), § 246-318-650, filed 3/5/93, effective 4/5/93. Statutory Authority: RCW 43.70.040. 91-02-049 (Order 121), recodified as § 246-318-650, filed 12/27/90, effective 1/31/91. Statutory Authority: RCW 70.41.030. 89-22-109 (Order 008), § 248-18-656, filed 11/1/89, effective 12/2/89.]

#### **WAC 246-318-660 Nuclear medicine facilities.**

Hospitals planning new construction of nuclear medicine facilities shall:

(1) Follow the general design requirements for architectural components, electrical service, lighting, call systems, hardware, interior finishes, heating, plumbing, sewerage, ventilation/air conditioning, and signage in WAC 246-318-540;

(2) Provide housekeeping facilities meeting requirements in WAC 246-318-550(6);

(3) Meet requirements in Radiation protection standards, chapter 246-221 WAC;

(4) Locate the facility to avoid outpatient traffic through inpatient areas with minimum exposure hazard to patients and personnel;

(5) Provide impermeable, readily decontaminated work surfaces and floors subject to spills of radioactive solutions;

(6) Provide radiochemistry lab with radiation shielding and other protective devices to facilitate safe storage and handling of nuclides and waste materials including:

(a) Separate work surfaces for patient dose and clinical specimen preparation;

(b) Fume hood, if appropriate, in accordance with WAC 246-318-540 (3)(m);

(c) Lockable nuclide storage;

(d) Equipment and supply storage;

(e) Corrosion-resistant sink suitable for handwashing; and

(f) Lockable storage for all radioactive materials, equipment and waste;

(7) Locate patient imaging room away from x-ray machines, and radioactive materials or shield the room and provide with:

(a) Administrative work surface at least ten feet away from imaging device;

(b) Conveniently located waiting area for dosed-patient use only;

(c) Space for examination bed, table, or equivalent;

(d) Work surface for scaler and detection equipment; and

(e) Storage;

(8) Provide toilet for dosed-patient use only meeting accessibility requirements in WAC 51-20-3100, with impermeable surfaces and handwash sink;

(9) Provide a private patient clothes changing room or area including a receptacle for potentially contaminated hospital clothing.

[Statutory Authority: RCW 70.41.030. 93-07-011 (Order 338), § 246-318-660, filed 3/5/93, effective 4/5/93. Statutory Authority: RCW 43.70.040. 91-02-049 (Order 121), recodified as § 246-318-660, filed 12/27/90, effective 1/31/91. Statutory Authority: Chapter 70.41 RCW. 90-12-014 (Order 061), § 248-18-665, filed 5/30/90, effective 6/30/90; Order 119, § 248-18-665, filed 5/23/75; Regulation 18.670, filed 1/25/62.]

#### **WAC 246-318-670 Electrocardiography facilities.**

Hospitals planning new construction of electrocardiography facilities shall:

(1) Follow the general design requirements for architectural components, electrical service, lighting, call systems, hardware, interior finishes, heating, plumbing, sewerage, ventilation/air conditioning, and signage in WAC 246-318-540;

(2) Provide housekeeping facilities on or convenient to the electrocardiography facility meeting requirements in WAC 246-318-550(6);

(3) Locate electrocardiography facility outside laboratory testing areas in designated room or area, free from excessive noise and providing privacy for patients with:

(a) A minimum dimension of eight feet;

(b) A minimum area of eighty square feet;

(c) A minimum area of one hundred fifty square feet when a stress test facility is planned;

(d) Handwash sink;

(e) Space for electrocardiographic machine;

(f) Clothes hook or equivalent;

(g) Storage; and

(h) Space for soiled linen and garbage containers.

[Statutory Authority: RCW 70.41.030. 93-07-011 (Order 338), § 246-318-670, filed 3/5/93, effective 4/5/93. Statutory Authority: RCW 43.70.040. 91-02-049 (Order 121), recodified as § 246-318-670, filed 12/27/90, effective 1/31/91. Statutory Authority: RCW 70.41.030. 87-03-030 (Order 2464), § 248-18-662, filed 1/14/87.]

**WAC 246-318-680 Electroencephalography facilities.** Hospitals planning new construction of electroencephalography facilities shall:

(1) Follow the general design requirements for architectural components, electrical service, lighting, call systems,

hardware, interior finishes, heating, plumbing, sewerage, ventilation/air conditioning, and signage in WAC 246-318-540;

(2) Provide housekeeping facilities within or adjacent to the electroencephalography facility meeting the requirements in WAC 246-318-550(6);

(3) Locate electroencephalography facility outside laboratory testing areas in designated room or area, free from excessive noise and providing privacy for patients with:

- (a) Noise attenuation materials in walls and ceilings;
- (b) Minimum dimension of eight feet;
- (c) Minimum area of one hundred square feet;
- (d) Handwash sink;
- (e) Clothes hook or equivalent;
- (f) Administrative, clerical, or monitoring area located in separate room from testing area;
- (g) Space for electroencephalography equipment;
- (h) Storage; and
- (i) Space for soiled linen and refuse receptacles.

[Statutory Authority: RCW 70.41.030, 93-07-011 (Order 338), § 246-318-680, filed 3/5/93, effective 4/5/93. Statutory Authority: RCW 43.70.040, 91-02-049 (Order 121), recodified as § 246-318-680, filed 12/27/90, effective 1/31/91. Statutory Authority: RCW 70.41.030, 87-03-030 (Order 2464), § 248-18-663, filed 1/14/87.]

**WAC 246-318-690 Nursing unit.** Hospitals planning new construction of nursing units shall:

(1) Follow the general design requirements for architectural components, electrical service, lighting, call systems, hardware, interior finishes, heating, plumbing, sewerage, ventilation/air conditioning, and signage in WAC 246-318-540;

(2) Provide support facilities on or adjacent to each unit meeting requirements in WAC 246-318-550(3) clean materials room; or WAC 246-318-550(4) clean utility room; WAC 246-318-550(6) housekeeping supply room; WAC 246-318-550(7) medication distribution; and WAC 246-318-550(8) soiled materials room; or WAC 246-318-550(9) soiled utility room; and WAC 246-318-550(10) nourishment services;

(3) Locate each nursing unit to avoid through traffic to any service, diagnostic, treatment, or administrative area;

(4) Provide each nursing unit with:

- (a) All rooms and areas of the unit on the same floor;
- (b) Separate areas for each of the following clinical services:

(i) Beds for postpartum patients grouped together and located to avoid intermixing with beds for other types of patients;

(ii) When a separate pediatric unit is planned or when rooms with pediatric beds are located together or in close proximity to each other, in accordance with program and WAC 246-318-700 (4)(a), (b), (c);

(iii) When a separate psychiatric unit is planned, or when ten or more psychiatric beds are planned, a psychiatric unit shall be provided in accordance with WAC 246-318-820;

(iv) Segregated critical care patient beds where five or more beds are planned in accordance with WAC 246-318-740; and

(v) A separate long-term care unit where ten or more beds are planned in accordance with WAC 246-318-870;

(5) Provide the following on or adjacent to each unit:

(a) Ice facilities including:

(i) Bulk ice dispensing located in a clean room equipped with a fixed or mobile work surface; or

(ii) A self dispensing ice machine;

(b) One main nursing support station including:

(i) A writing surface;

(ii) Storage for patient charts;

(iii) A telephone; and

(iv) A nurse call annunciator;

(c) An office for the head nurse or nursing supervisor for units of twenty beds or more;

(d) Staff facilities meeting accessibility requirements in WAC 51-20-3100, including:

(i) A toilet with handwash sink; and

(ii) Storage for personal effects, apart from storage for patient care supplies and equipment;

(e) A room for confidential communication; and

(f) A waiting room or area, convenient to the unit;

(6) Provide the following on each unit:

(a) Patient rooms located:

(i) To prevent traffic through rooms;

(ii) To minimize entrance of odors, noise, and other nuisances; and

(iii) With direct access from corridor of nursing unit;

(b) Patient rooms designed with:

(i) A maximum capacity of four beds per room;

(ii) At least eighty square feet usable floor space per bed in multibed rooms;

(iii) At least one hundred square feet usable floor space in single-bed rooms;

(iv) Minimum width of eleven feet for multibed rooms;

(v) Beds arranged in multibed rooms with at least:

(A) Two feet from wall, except at head;

(B) Three feet apart; and

(C) Three feet eight inches clearance at foot of bed;

(vi) Handwash sink in each room or in adjoining private toilet for single patient rooms, optional in psychiatric patient rooms;

(vii) Cubicle curtains or equivalent to provide patient privacy in all multibed patient rooms arranged to provide patient access to toilet, handwash sink, wardrobe, and entry without interference to privacy of other patients; and

(viii) One full-length wardrobe, closet, or locker per bed for storage of personal effects;

(c) Patient bathing facilities including showers or tubs in the ratio of one bathing facility per eight beds or major fraction thereof. Beds having a bathing facility adjoining the patient room shall be excluded from the ratio;

(d) Patient toilets with bedpan flushing equipment adjoining each patient room; and

(e) Water closets in ratio of one per four beds or major fraction thereof;

(7) Provide at least one isolation room for airborne communicable disease within hospital with:

(a) Adjoining toilet, bedpan flushing equipment, and bathing facility;

(b) Handwash sink located in room near entry;

(c) Air changes and air pressure gradients in accordance with WAC 246-318-540 Table 540-3 and WAC 246-318-035 (4)(a)(i);

(d) Ultraviolet generator irradiation in rooms designated for isolation of tuberculosis patients in accordance with WAC 246-318-035 (4)(a)(ii); and

(e) Uncarpeted floors.

[Statutory Authority: RCW 70.41.030. 93-07-011 (Order 338), § 246-318-690, filed 3/5/93, effective 4/5/93. Statutory Authority: RCW 43.70.040. 91-02-049 (Order 121), recodified as § 246-318-690, filed 12/27/90, effective 1/31/91. Statutory Authority: Chapter 70.41 RCW. 90-12-014 (Order 061), § 248-18-530, filed 5/30/90, effective 6/30/90. Statutory Authority: RCW 43.20.050 and chapter 70.41 RCW. 81-22-014 (Order 216), § 248-18-530, filed 10/23/81; Order 119, § 248-18-530, filed 5/23/75; Regulation 18.560, § 1, 2 and 3, filed 1/25/62.]

**WAC 246-318-700 Pediatric nursing unit.** Hospitals planning new construction of a pediatric unit shall:

(1) Locate the pediatric unit to prevent unnecessary traffic through the service area;

(2) Follow the general design requirements for architectural components, electrical service, lighting, call systems, hardware, interior finishes, heating, plumbing, sewerage, ventilation/air conditioning, and signage in WAC 246-318-540;

(3) Provide support facilities located for convenient use by staff meeting requirements in WAC 246-318-550(3) clean materials room; or WAC 246-318-550(4) clean utility room; WAC 246-318-550(6) housekeeping supply room; WAC 246-318-550(7) medication distribution facility; WAC 246-318-550(8) soiled materials room; or WAC 246-318-550(9) soiled utility room; and WAC 246-318-550(10) nourishment facilities. Support facilities may be shared with other service areas when service is limited to sixteen patient beds or less in a combined-use area;

(4) Design the pediatric unit to meet requirements in WAC 246-318-210 and 246-318-690(6) except as follows:

(a) Patient rooms shall have fifty square feet usable floor space per bassinets;

(b) Adjoining patient toilets may be omitted from bassinets rooms;

(c) Ratios of bathing facilities to beds may exclude cribs and bassinets; and

(d) At least one isolation room shall be located in the pediatric area meeting requirements in WAC 246-318-690(7).

(5) Provide a pediatric nursing unit with:

(a) Nursing support station or equivalent meeting requirements in WAC 246-318-690 (5)(b);

(b) Ice facilities meeting requirements in WAC 246-318-690 (5)(a);

(c) Drinking fountain or equivalent;

(d) Staff facilities meeting requirements in WAC 246-318-690 (5)(d);

(e) Storage; and

(f) Treatment and examination room with minimum dimension of eight feet and at least eighty square feet exclusive of cabinets, sink, work counter desk, and vestibule, including:

(i) Handwash sink;

(ii) Work surface; and

(iii) Storage.

(6) Provide parents' waiting room with education facilities; and

(7) Provide multipurpose room with:

(a) Space for playing and dining;

(b) Separate activity area for adolescents; and

(c) Construction minimizing sound transmission.

[Statutory Authority: RCW 70.41.030. 93-07-011 (Order 338), § 246-318-700, filed 3/5/93, effective 4/5/93. Statutory Authority: RCW 43.70.040. 91-02-049 (Order 121), recodified as § 246-318-700, filed 12/27/90, effective 1/31/91. Statutory Authority: RCW 70.41.030. 89-22-106 (Order 010), § 248-18-541, filed 11/1/89, effective 12/2/89.]

**WAC 246-318-710 Emergency facilities.** Hospitals planning new construction of emergency facilities shall:

(1) Follow the general design requirements for architectural components, electrical service, lighting, call systems, hardware, interior finishes, heating, plumbing, sewerage, ventilation/air conditioning, and signage in WAC 246-318-540;

(2) Provide support facilities meeting requirements in WAC 246-318-550(3) clean materials room; or WAC 246-318-550(4) clean utility room; WAC 246-318-550(5) clean-up room; WAC 246-318-550(6) housekeeping supply room; and WAC 246-318-550(7) medication distribution facility and provide storage for:

(a) Stretcher and wheelchair adjacent to emergency facility entrance;

(b) Mobile cart with emergency medical supplies and equipment, in a clean area, readily accessible from all rooms used for patient care or treatment;

(c) Portable x-ray equipment, if stored in emergency facility; and

(d) Other major portable or mobile equipment;

(3) Locate emergency patient entrance to emergency facilities including:

(a) Ready access at grade level to pedestrian, ambulance, and other vehicular traffic;

(b) Port-size to accommodate at least one vehicle twenty-two feet long, eleven feet high and eight feet wide designed to:

(i) Permit attendants to stand on same level as entrance when removing a stretcher from vehicle; and

(ii) Accommodate different levels of approach with ramps for pedestrian traffic;

(c) Protection of emergency patient and the interior of the emergency facility from weather when a patient is brought from an ambulance or other vehicle into the emergency facility;

(4) Locate a separate, segregated emergency facility to:

(a) Prevent traffic through emergency facilities to any other area of hospital; and

(b) Facilitate transfer of patients to other hospital service areas;

(5) Provide emergency facilities with:

(a) Emergency receiving/triage area close or adjacent to emergency entrance, and convenient to treatment rooms including decontamination area with shower and floor drain; and

(b) Registration area including:

(i) Office space or work space for registration, located to control access to emergency facility patient care areas; and

(ii) A communication device;

(c) Waiting area and public telephone located outside the main traffic flow in emergency department;

(d) Police, press, and ambulance attendant room, if planned, located outside the main traffic flow of emergency department;

(e) Writing surface for nurses and physicians;

(f) Cubicle curtains or equivalent means for providing patient privacy in examination, treatment, or observation rooms;

(g) At least one patient toilet meeting accessibility requirements in WAC 51-20-3100, convenient to examination and treatment rooms and located so patients receiving treatment have access to a toilet without entering a public corridor;

(h) Sink with plaster trap; and

(i) Public toilet meeting accessibility requirements in WAC 51-20-3100;

(6) Provide at least one major treatment or trauma room with:

(a) Dimensions and arrangement to provide:

(i) Clear space at least four feet wide at both sides and both ends of each treatment table or cart; and

(ii) Clear eight feet wide space between treatment tables or carts;

(b) Storage for clean and sterile supplies and small equipment;

(c) Storage for drugs in accordance with WAC 246-318-550(7);

(d) Clean work surface for assembly and preparation of clean and sterile supplies and equipment for use;

(e) A sink mounted in, integral with, or adjacent to clean work surface;

(f) A scrub sink equipped with foot operated soap dispenser and brush dispenser or equivalent located as follows:

(i) Eight feet away from or with a physical barrier separating it from clean work surface, clean and sterile supply storage, equipment and drugs, if within the room; or

(ii) Outside and adjacent to the room;

(g) Soiled work surface for collection of contaminated supplies and equipment;

(h) Ceiling mounted treatment light for each treatment space;

(i) Film illuminator or equivalent;

(j) Outlet for mobile x-ray machine;

(k) Clock with sweep second hand or equivalent within view of each treatment space;

(l) Storage space for major medical equipment; and

(m) Space for linen hampers and waste containers;

(7) Provide minor treatment and examination room, if planned, with:

(a) Dimensions and arrangement to provide:

(i) Clear space at least three feet at each side and end of each treatment table or cart;

(ii) Clear six feet wide space between treatment tables or carts; and

(iii) At least six feet eight inches by two feet six inches of floor space per treatment table;

(b) Handwash sink;

(c) Clean work surface;

(d) Storage for supplies and equipment;

(e) Examination light;

(f) Readily accessible film illuminator or equivalent; and

(g) Space for linen hampers and waste containers convenient to all treatment rooms;

(8) Provide observation room, if planned, located convenient to nursing support station with:

(a) Minimum dimension of ten feet and at least one hundred square feet in one-bed rooms;

(b) Each multiple-bed room designed to provide:

(i) At least four feet wide space between side of each bed or cart and any wall, other bed, or fixed equipment (e.g., cabinet, sink, closet); and

(ii) At least four feet wide space between foot end of any bed and any wall or fixed equipment;

(c) Handwash sink in each room; and

(d) Storage for each patient's personal effects;

(9) Provide room for severely disturbed patients, if planned, with room details, doors, hardware, windows, and screens designed and constructed for patient safety.

[Statutory Authority: RCW 70.41.030, 93-07-011 (Order 338), § 246-318-710, filed 3/5/93, effective 4/5/93. Statutory Authority: RCW 43.70.040, 91-02-049 (Order 121), recodified as § 246-318-710, filed 12/27/90, effective 1/31/91. Statutory Authority: Chapter 70.41 RCW, 90-12-014 (Order 061), § 248-18-645, filed 5/30/90, effective 6/30/90. Statutory Authority: RCW 70.41.030 and 43.20.050, 83-19-058 (Order 269), § 248-18-645, filed 9/20/83; Order 119, § 248-18-645, filed 5/23/75; Order 106, § 248-18-645, filed 1/13/75; Regulation 18.630, filed 1/25/62.]

**WAC 246-318-720 Surgery suite.** Hospitals planning new construction of surgery facilities shall:

(1) Follow the general design requirements for architectural components, electrical service, lighting, call systems, hardware, interior finishes, heating, plumbing, sewerage, ventilation/air conditioning, and signage in WAC 246-318-540;

(2) Provide support facilities meeting requirements in WAC 246-318-550(3) clean materials room; or WAC 246-318-550(4) clean utility room; WAC 246-318-550(6) housekeeping supply room; and WAC 246-318-550(7) medication distribution facility, including the following:

(a) Clean-up room in accordance with WAC 246-318-550(5) with a sink and plaster trap;

(b) Storage facilities for:

(i) Instruments;

(ii) Blood refrigeration, if blood is stored;

(iii) Solutions; and

(iv) Mobile x-ray;

(c) Anesthesia work room with:

(i) Adequate space for storing anesthesia machines, carts, supplies, and medications;

(ii) A two-compartment sink with counter space to separate clean and soiled functions; and

(iii) A writing desk or counter;

(3) Locate a separate segregated surgery suite to:

(a) Prevent traffic through surgery suite to any other area of the hospital; and

(b) Facilitate transfer of patients to recovery/post anesthesia care unit and surgical nursing units;

(4) Provide surgery suite with:

(a) A scrub-up area including:

(i) Direct access to each operating room;

(ii) A minimum of two scrub sinks per operating room or at least three scrub sinks for every two operating rooms;

(iii) Soap dispenser with foot control or equivalent;



- (iv) Brush dispenser or equivalent;
- (v) Shelf;
- (vi) Single service towel dispenser or equivalent; and
- (vii) Clock with sweep second hand or equivalent within view from scrub sinks;
- (b) Sterilizing facilities located for maintenance accessibility including:
  - (i) One sterilizer for every three operating rooms; and
  - (ii) High speed sterilizers with recording thermometers and automatic controls of sufficient capacity to accommodate supplies and equipment if sterilized in suite;
- (c) Separate patient preoperative area, if planned, located for direct observation of each patient including:
  - (i) Room or alcove out of traffic; and
  - (ii) Provision for toilet, handwash sink, work counters, and cubicle curtains or equivalent, if surgical preps and inductions are done;
  - (d) A solution warmer; and
  - (e) A blanket warmer;
  - (5) Provide at least one major operating room with:
    - (a) Minimum dimension of eighteen feet;
    - (b) Minimum clear area of three hundred sixty square feet exclusive of fixed and movable cabinets and shelves;
    - (c) A ceiling mounted surgery light;
    - (d) Film illuminators or equivalent for viewing at least two films;
    - (e) A clock with sweep second hand or equivalent and interval timer;
    - (f) Storage for surgical supplies; and
    - (g) Additional space and equipment in accordance with WAC 246-318-221 (4)(a)(i) through (v) if obstetrical deliveries are done;
  - (6) Provide minor operating procedure room, if planned, with:
    - (a) Minimum dimension of fifteen feet;
    - (b) Minimum clear area of two hundred seventy square feet, exclusive of fixed and movable cabinets and shelves;
    - (c) A ceiling mounted surgery light or equivalent;
    - (d) A film illuminator or equivalent;
    - (e) A clock with sweep second hand or equivalent; and
    - (f) Storage for surgical supplies;
  - (7) Locate administrative area to permit coordination of functions among operating rooms and control access to surgery facilities with:
    - (a) Telephone;
    - (b) Annunciator for emergency signaling device unless located in alternate location from which additional assistance is always available;
    - (c) Supervisor's office;
    - (d) Room convenient to the surgery suite for confidential communication; and
    - (e) File storage;
  - (8) Provide staff facilities with:
    - (a) Locker rooms located within the surgery suite, with direct access to the restricted corridor, including:
      - (i) Storage for personal effects;
      - (ii) A clothing change area or room;
      - (iii) A toilet and handwash sink;
      - (iv) Storage space for scrub clothing; and
      - (v) Space for collection receptacles for soiled scrub clothing;
    - (b) A lounge within the surgery suite;

(9) Include a recovery/post anesthesia care unit in accordance with WAC 246-318-730.

[Statutory Authority: RCW 70.41.030. 93-07-011 (Order 338), § 246-318-720, filed 3/5/93, effective 4/5/93. Statutory Authority: RCW 43.70.040. 91-02-049 (Order 121), recodified as § 246-318-720, filed 12/27/90, effective 1/31/91. Statutory Authority: Chapter 70.41 RCW. 90-12-014 (Order 061), § 248-18-565, filed 5/30/90, effective 6/30/90. Statutory Authority: RCW 70.41.030. 85-23-017 (Order 2302), § 248-18-565, filed 11/13/85. Statutory Authority: RCW 70.41.030 and 43.20.050. 83-19-058 (Order 269), § 248-18-565, filed 9/20/83; Order 119, § 248-18-565, filed 5/23/75; Order 107, § 248-18-565, filed 1/13/75; Regulation 18.590, § 1, filed 1/25/62.]

**WAC 246-318-730 Recovery/post anesthesia care unit (PACU).** Hospitals planning new construction of recovery/post anesthesia facilities shall:

(1) Follow the general design requirements for architectural components, electrical service, lighting, call systems, hardware, interior finishes, heating, plumbing, sewerage, ventilation/air conditioning, and signage in WAC 246-318-540;

(2) Provide support facilities meeting requirements in WAC 246-318-550(3) clean materials room; or WAC 246-318-550(4) clean utility room; WAC 246-318-550(6) house-keeping supply room; WAC 246-318-550(7) medication distribution facility; and WAC 246-318-550(8) soiled materials room; or WAC 246-318-550(9) soiled utility room. Service facilities may be shared, if clean and soiled utilities and medication storage is directly accessible to surgery;

(3) Locate recovery/post anesthesia care unit area or rooms adjacent to the surgery suite, avoiding through traffic;

(4) Provide patient care area with:

(a) At least eighty square feet per patient;

(b) Cubicle curtains or equivalent;

(c) A handwash sink located convenient to every six patient stations or major fraction;

(d) Storage, shelves, drawers, or equivalent and charting surface at each patient station;

(e) Clock with sweep second hand or equivalent and interval timer; and

(f) Isolation room, if planned, with:

(i) One hundred twenty square feet;

(ii) A handwash sink;

(iii) A clock;

(iv) A charting surface; and

(v) A clinic service sink or water closet with bedpan rinsing/flushing attachment adjoining room;

(5) Provide storage for supplies and equipment;

(6) Provide nursing support station with:

(a) A telephone;

(b) A writing surface; and

(c) Storage;

(7) Provide easily accessible staff toilet with handwash sink.

[Statutory Authority: RCW 70.41.030. 93-07-011 (Order 338), § 246-318-730, filed 3/5/93, effective 4/5/93. Statutory Authority: RCW 43.70.040. 91-02-049 (Order 121), recodified as § 246-318-730, filed 12/27/90, effective 1/31/91. Statutory Authority: Chapter 70.41 RCW. 90-12-014 (Order 061), § 248-18-560, filed 5/30/90, effective 6/30/90. Statutory Authority: RCW 70.41.030. 85-23-017 (Order 2302), § 248-18-560, filed 11/13/85. Statutory Authority: RCW 70.41.030 and 43.20.050. 83-19-058 (Order 269), § 248-18-560, filed 9/20/83; Order 119, § 248-18-560, filed 5/23/75; Regulation 18.580, filed 1/25/62.]

**WAC 246-318-740 Critical care facilities.** Hospitals planning new construction of critical care facilities shall:

(1) Follow the general design requirements for architectural components, electrical service, lighting, call systems, hardware, interior finishes, heating, plumbing, sewerage, ventilation/air conditioning, and signage in WAC 246-318-540.

(2) Provide support facilities meeting requirements in WAC 246-318-550(3) clean materials room; or WAC 246-318-550(4) clean utility room; WAC 246-318-550(6) housekeeping supply room; WAC 246-318-550(7) medication distribution facility; WAC 246-318-550(8) soiled materials room; or WAC 246-318-550(9) soiled utility room; and WAC 246-318-550(10) nourishment facilities with provision for bulk ice. Support facilities may be shared if:

(a) The critical care facility has fewer than five beds; and

(b) The support facilities:

(i) Are in close proximity to the beds; and

(ii) Provide sufficient space for critical care functions.

(3) Provide a critical care facility with:

(a) Location to avoid traffic and penetration of objectionable heat or noise or odors from other areas of the hospital;

(b) A water closet, clinic sink, hopper, or equivalent with bedpan-flushing device for disposing of patient wastes, in a room directly accessible to each critical care patient room;

(c) A staff toilet;

(d) Charting areas; and

(e) Storage.

(4) Provide patient rooms with:

(a) Location of patient rooms and placement of beds in rooms to provide for direct visibility of patients from nursing support station or equivalent unless there is provision for indirect viewing of patients by mirror system or television;

(b) Maximum capacity of two beds per room and a ratio of at least one single room for every three planned critical care beds;

(c) Minimum usable floor space per bed of one hundred fifty square feet, exclusive of areas taken up by passage door swings, closets, wardrobes, portable lockers, and toilet rooms;

(d) Spacing of at least:

(i) Four feet or more between side of bed and wall;

(ii) Six feet or more between foot of bed and wall; and

(iii) Eight feet or more between beds in multibed rooms;

(e) Equipment as follows:

(i) Curtains or equivalent means of providing visual privacy;

(ii) Clocks with sweep second hands and interval timer or equivalent;

(iii) One handwash sink per room; and

(iv) An electrocardiographic monitor with oscilloscope at least five inches wide with an audio alarm system for each bed;

(f) Uncarpeted floors.

(5) Provide nursing support station or equivalent with:

(a) Location to provide direct visibility of each patient or a mirror system or television for viewing patients;

(b) Space for patient monitoring equipment including:

(i) Slave oscilloscope with audio alarm for continuous display of each patient's electrocardiogram;

(ii) Rate meter; and

(iii) Recorder;

(c) Wall-mounted clock with sweep second hand or equivalent;

(d) Charting surface or equivalent; and

(e) Combined use or sharing permitted if:

(i) The critical care facility has fewer than five beds; and

(ii) The nursing support station or equivalent is located in close proximity to the beds and provides sufficient space for critical care functions.

[Statutory Authority: RCW 70.41.030. 93-07-011 (Order 338), § 246-318-740, filed 3/5/93, effective 4/5/93. Statutory Authority: RCW 43.70.040. 91-02-049 (Order 121), recodified as § 246-318-740, filed 12/27/90, effective 1/31/91. Statutory Authority: RCW 70.41.030. 90-24-044 (Order 115), § 248-318-740, filed 11/30/90, effective 12/31/90.]

**WAC 246-318-750 Facilities for care of patients in labor.** Hospitals planning new construction of labor rooms which are not birthing rooms shall:

(1) Locate labor rooms to prevent unnecessary traffic through the labor room service area;

(2) Follow the general design requirements for architectural components, electrical service, lighting, call systems, hardware, interior finishes, heating, plumbing, sewerage, ventilation/air conditioning, and signage in WAC 246-318-540.

(3) Provide support facilities located for convenient use by staff meeting requirements in WAC 246-318-550(3) clean materials room; or WAC 246-318-550(4) clean utility room; WAC 246-318-550(6) housekeeping supply room; WAC 246-318-550(7) medication distribution facility; and WAC 246-318-550(8) soiled materials room; or WAC 246-318-550(9) soiled utility room. Support facilities may be shared with other areas;

(4) Provide a labor room meeting requirements in WAC 246-318-690 (6)(a) and (b) with:

(a) Identification and location accommodating requirements in WAC 246-318-220(3); and

(b) A maximum capacity of two beds.

(5) Provide toilet and bathing facilities meeting requirements in WAC 246-318-690 (6)(c), (d), and (e).

[Statutory Authority: RCW 70.41.030. 93-07-011 (Order 338), § 246-318-750, filed 3/5/93, effective 4/5/93. Statutory Authority: RCW 43.70.040. 91-02-049 (Order 121), recodified as § 246-318-750, filed 12/27/90, effective 1/31/91. Statutory Authority: RCW 70.41.030. 89-22-106 (Order 010), § 248-18-606, filed 11/1/89, effective 12/2/89.]

**WAC 246-318-760 Obstetrical delivery facilities.** Hospitals planning new construction of obstetrical delivery facilities shall:

(1) Locate delivery rooms to prevent traffic through delivery room service areas;

(2) Follow the general design requirements for architectural components, electrical service, lighting, call systems, hardware, interior finishes, heating, plumbing, sewerage, ventilation/air conditioning, and signage meeting requirements in WAC 246-318-540.

(3) Provide support facilities meeting requirements in WAC 246-318-550(3) clean materials room; or WAC 246-

318-550(4) clean utility room; WAC 246-318-550(6) housekeeping supply room; WAC 246-318-550(7) medication distribution facility; and WAC 246-318-550(9) soiled utility room.

(4) Design delivery room or surgery room for obstetrical services meeting the requirements in WAC 246-318-220 and provide:

(a) Clock with sweep second hand and interval timer or equivalent;

(b) Film illuminators for at least two x-ray films or equivalent;

(c) Minimum gross area of three hundred and sixty square feet;

(d) Minimum dimension of eighteen feet; and

(e) Delivery room light.

(5) Provide scrub area located to provide direct access to the delivery room with:

(a) One scrub sink or equivalent for every delivery or surgery room;

(b) A dispenser at each scrub sink with foot control, or equivalent, if liquid hand cleaner is used;

(c) Storage for scrub equipment, masks, caps, nail cleaners, and shoe covers;

(d) A clock or timer within view from scrub sinks; and

(e) A towel dispenser or equivalent.

(6) Provide sterilizing facilities within the delivery service area and meeting requirements in WAC 246-318-590(8), or in central sterilizing and processing service facilities meeting requirements in WAC 246-318-590.

(7) Provide anesthesia storage or anesthesia workroom meeting requirements in WAC 246-318-720 (2)(c).

(8) Provide staff facilities meeting requirements in WAC 246-318-720(8).

(9) Include a recovery/post anesthesia care unit in accordance with WAC 246-318-730.

(10) Provide storage for supplies and equipment.

[Statutory Authority: RCW 70.41.030. 93-07-011 (Order 338), § 246-318-760, filed 3/5/93, effective 4/5/93. Statutory Authority: RCW 43.70.040. 91-02-049 (Order 121), recodified as § 246-318-760, filed 12/27/90, effective 1/31/91. Statutory Authority: RCW 70.41.030. 89-22-106 (Order 010), § 248-18-601, filed 11/1/89, effective 12/2/89.]

**WAC 246-318-770 Birthing rooms.** Hospitals planning new construction of birthing rooms shall:

(1) Locate birthing rooms to prevent unnecessary traffic through the obstetrical service area;

(2) Follow the general design requirements for architectural components, electrical service, lighting, call systems, hardware, interior finishes, heating, plumbing, sewerage, ventilation/air conditioning, and signage in WAC 246-318-540;

(3) Provide support facilities located for convenient use by staff meeting requirements in WAC 246-318-550(4) clean utility room; WAC 246-318-550(6) housekeeping supply room; WAC 246-318-550(7) medication distribution facility; WAC 246-318-550(9) soiled utility room; and WAC 246-318-550(10) nourishment facility. Support facilities may be shared with other areas;

(4) Design each birthing room meeting the requirements in WAC 246-318-220(4) and provide:

(a) Area and dimensions with a minimum usable floor space excluding lavatory, wardrobe, or closet, fixed or

movable cabinets, storage facilities, and entry vestibules as follows:

(i) One hundred and sixty square feet total; and

(ii) Four feet at one side and at foot of bed.

(b) A handwash sink in the room meeting requirements in WAC 246-318-540;

(c) Privacy curtains or equivalent; and

(d) One full-length wardrobe, closet, or locker for storage of personal effects.

(5) Provide toilet and bathing facilities meeting requirements in WAC 246-318-690 (6)(c) and (d) and with:

(a) Patient toilets adjoining birthing room and in a ratio of one toilet for each patient bed;

(b) Support persons' toilets, separate from patient toilet, and conveniently located; and

(c) Showers in a ratio of one shower to every eight patient beds in obstetrical service area.

(6) Provide nursing support station or equivalent meeting requirements in WAC 246-318-690 (5)(b).

(7) Provide staff facilities meeting requirements in WAC 246-318-070.

(8) Provide storage for supplies and equipment.

[Statutory Authority: RCW 70.41.030. 93-07-011 (Order 338), § 246-318-770, filed 3/5/93, effective 4/5/93. Statutory Authority: RCW 43.70.040. 91-02-049 (Order 121), recodified as § 246-318-770, filed 12/27/90, effective 1/31/91. Statutory Authority: RCW 70.41.030. 89-22-106 (Order 010), § 248-18-608, filed 11/1/89, effective 12/2/89.]

**WAC 246-318-780 Obstetrical recovery unit.**

Hospitals planning new construction of an obstetrical recovery unit shall meet the requirements in WAC 246-318-730.

[Statutory Authority: RCW 70.41.030. 93-07-011 (Order 338), § 246-318-780, filed 3/5/93, effective 4/5/93. Statutory Authority: RCW 43.70.040. 91-02-049 (Order 121), recodified as § 246-318-780, filed 12/27/90, effective 1/31/91; Order 119, § 248-18-610, filed 5/23/75; Order 107, § 248-18-610, filed 1/13/75; Regulation 18.600, § 13, filed 1/25/62.]

**WAC 246-318-790 Newborn nursery facilities.**

Hospitals planning new construction of newborn nursery facilities shall:

(1) Locate the nursery facilities to prevent unnecessary traffic through the service area;

(2) Follow the general design requirements for architectural components, electrical service, lighting, call systems, hardware, interior finishes, heating, plumbing, sewerage, ventilation/air conditioning, and signage in WAC 246-318-540;

(3) Provide support facilities convenient to nursery room meeting requirements in WAC 246-318-550(4) clean utility room with additional provision of refrigerator for infant feedings; WAC 246-318-550(6) housekeeping supply room; WAC 246-318-550(7) medication distribution facility; and WAC 246-318-550(9) soiled utility room. Support facilities may be shared with other nursery areas;

(4) Meet the requirements in WAC 246-318-220 (6) and (7);

(5) Provide nursery rooms with:

(a) No public access to the nursery except through handwashing and gowning area;

(b) Enough bassinets for newborn infants at least equal to anticipated need;

- (c) An area of twenty-four square feet per bassinets;
- (d) At least three feet between bassinets;
- (e) A handwash sink meeting the requirements in WAC 246-318-540 (4)(f) and (7)(b), (e), and (f) and located at every entrance to each nursery room, with a ratio of one lavatory for every twelve bassinets or major fraction;
- (f) A liquid detergent dispenser with foot control;
- (g) A clock with sweep second hand or equivalent visible from all nursery rooms and service areas;
- (h) Lighting level measured at height of infant station or treatment table:
  - (i) Minimum seventy foot candles; and
  - (ii) Maximum one hundred foot candles.
- (i) Provision for viewing infants in the nursery rooms by visitors outside the nursery rooms;
- (j) A charting area which may be shared with other nurseries, with provisions for:
  - (i) A writing desk or counter;
  - (ii) A chart rack; and
  - (iii) Use of telephone.
- (6) Provide a handwashing and gowning area at the public entrance to the nursery room with:
  - (a) A handwash sink with gooseneck spout and knee or foot faucet control or equivalent;
  - (b) Liquid detergent dispenser with foot control;
  - (c) Storage for linen and equipment; and
  - (d) Provision for hanging outer garments.
- (7) Provide staff facilities meeting the requirements in WAC 246-318-070 which may be shared with other service areas;
- (8) Provide storage room for supplies and equipment.

[Statutory Authority: RCW 70.41.030, 93-07-011 (Order 338), § 246-318-790, filed 3/5/93, effective 4/5/93. Statutory Authority: RCW 43.70.040, 91-02-049 (Order 121), recodified as § 246-318-790, filed 12/27/90, effective 1/31/91. Statutory Authority: RCW 70.41.030, 89-22-106 (Order 010), § 248-18-616, filed 11/1/89, effective 12/2/89.]

**WAC 246-318-800 Intermediate care nursery and neonatal intensive care nursery.** Hospitals planning new construction of intermediate care nurseries and neonatal intensive care nurseries shall:

- (1) Locate the nursery facilities to prevent unnecessary traffic through the service area;
- (2) Follow the general design requirements for architectural components, electrical service, lighting, call systems, hardware, interior finishes, heating, plumbing, sewerage, ventilation/air conditioning, and signage in WAC 246-318-540;
- (3) Provide support facilities convenient to nursery room meeting requirements in WAC 246-318-550(4) clean utility room with additional provision of refrigerator for infant feedings; WAC 246-318-550(6) housekeeping supply room; WAC 246-318-550(7) medication distribution facility; and WAC 246-318-550(9) soiled utility room. Support facilities may be shared with other nursery areas;
- (4) Meet the requirements in WAC 246-318-220 (6) and (7);
- (5) Meet the requirements in WAC 246-318-230(2) for intermediate care nurseries;
- (6) Meet the requirements in WAC 246-318-230(3) for neonatal intensive care nurseries;

(7) Meet all requirements in WAC 246-318-790 with additions as follows:

- (a) Provide nursery rooms with film illuminators or equivalent to view a minimum of two x-ray films which may be shared between intermediate and neonatal intensive care nurseries; and
- (b) Provide infant stations with:
  - (i) Minimal usable floor area exclusive of aisles with:
    - (A) Fifty square feet in intermediate care nursery; and
    - (B) Eighty square feet in neonatal intensive care nursery.
  - (ii) Space to accommodate monitors;
  - (iii) Work counter with provisions for a writing area; and
  - (iv) Closed storage for individual supplies and equipment.
- (8) Provide scrub area including:
  - (a) A scrub sink for every eight infant stations or a major fraction thereof, with no less than two sinks;
  - (b) Germicidal dispenser, hand brush, sponge dispenser or equivalent, located at each scrub sink; and
  - (c) Clean storage for clean gowns, masks, nail cleaners, and shoe covers.
- (9) Provide isolation room if planned, meeting the requirements in subsection (7)(b)(i), (ii), (iii), and (iv) of this section;
- (10) Provide parent privacy room with education facilities and cubicle curtains or equivalent for complete visual privacy;
- (11) Provide conference or counseling room convenient to intermediate care and neonatal intensive care nursery rooms;
- (12) Provide nursing support station or equivalent meeting the requirements in WAC 246-318-690 (5)(b);
- (13) Provide staff facilities meeting the requirements in WAC 246-318-070 which may be shared with other service areas; and
- (14) Provide storage room for supplies and equipment.

[Statutory Authority: RCW 70.41.030, 93-07-011 (Order 338), § 246-318-800, filed 3/5/93, effective 4/5/93. Statutory Authority: RCW 43.70.040, 91-02-049 (Order 121), recodified as § 246-318-800, filed 12/27/90, effective 1/31/91. Statutory Authority: RCW 70.41.030, 89-22-106 (Order 010), § 248-18-637, filed 11/1/89, effective 12/2/89.]

**WAC 246-318-810 Alcoholism and substance abuse nursing unit.** Hospitals planning new construction of alcoholism and substance abuse nursing facilities shall:

- (1) Follow the general design requirements for architectural components, electrical service, lighting, call systems, hardware, interior finishes, heating, plumbing, sewerage, ventilation/air conditioning, and signage in WAC 246-318-540;
- (2) Provide support facilities meeting requirements in WAC 246-318-550(3) clean materials room; or WAC 246-318-550(4) clean utility room; WAC 246-318-550(6) housekeeping supply room; WAC 246-318-550(7) medication distribution facility; and WAC 246-318-550(8) soiled materials room; or WAC 246-318-550(9) soiled utility room;
- (3) Locate each nursing unit to avoid through traffic to any service, diagnostic, treatment, or administrative area and to control access;
- (4) Provide the unit with:

(a) Patient rooms, toilet rooms, bathing facilities, nursing support station or equivalent, and nourishment facilities as required in WAC 246-318-690;

(b) Examination and treatment room available including:

(i) Minimum dimension of eight feet;

(ii) At least eighty square feet useable floor space exclusive of cabinets, sink, work counter, desk, and vestibule;

(iii) Handwash sink;

(iv) Work surface; and

(v) Storage cabinet;

(c) Social facilities including:

(i) At least two separate rooms or one room with partition to accommodate two separate functions simultaneously; and

(ii) At least four hundred square feet for unit of ten beds or less. Add twenty square feet per bed for each additional bed;

(d) Offices for staff;

(e) Interview and counseling rooms for patient confidentiality and privacy;

(f) Facilities for patients to launder personal belongings; and

(g) Provide detoxification area, if planned, with patient rooms equipped with oxygen and suction outlets at each bed.

[Statutory Authority: RCW 70.41.030, 93-07-011 (Order 338), § 246-318-810, filed 3/5/93, effective 4/5/93. Statutory Authority: RCW 43.70.040, 91-02-049 (Order 121), recodified as § 246-318-810, filed 12/27/90, effective 1/31/91. Statutory Authority: RCW 70.41.030 and 43.20.050, 84-22-003 (Order 277), § 248-18-532, filed 10/26/84.]

**WAC 246-318-820 Psychiatric facilities.** Hospitals planning new construction of a psychiatric unit shall:

(1) Follow the general design requirements for architectural components, electrical service, lighting, call systems, hardware, interior finishes, heating, plumbing, sewerage, ventilation/air conditioning, and signage in WAC 246-318-540, with:

(a) All windows and relites located in rooms or areas accessible to patients:

(i) Meeting requirements in WAC 246-318-540 (1)(i); and

(ii) Installation of security or maximum security windows or equivalent;

(b) Tamper-resistant accessories and equipment in patient rooms, toilet rooms, and bathrooms;

(c) Tamper-resistant electrical receptacles in all patient rooms and areas;

(d) Design to prevent opportunity for suicide.

(2) Provide support facilities meeting requirements in WAC 246-318-550(3) clean materials room; or WAC 246-318-550(4) clean utility room; WAC 246-318-550(6) housekeeping supply room; WAC 246-318-550(7) medication distribution facility; WAC 246-318-550(8) soiled materials room; or WAC 246-318-550(9) soiled utility room; and WAC 246-318-550(10) nourishment facilities with provision for bulk ice. All doors for housekeeping, medications, storage, and utility rooms shall be equipped with locks.

(3) Provide psychiatric facilities including:

(a) Location avoiding traffic and penetration of objectionable heat, noise, or odors from other areas of the hospital;

(b) Examination room, unless available in an adjacent area or unit, with:

(i) Minimum floor space of one hundred square feet;

(ii) Minimum dimension of eight feet; and

(iii) The following equipment:

(A) Medical emergency signal devices;

(B) A handwash sink;

(C) A clock with sweep second hand or equivalent;

(D) An oxygen outlet;

(E) A suction outlet;

(F) A work surface; and

(G) A storage cabinet.

(c) Toilet rooms with water closets in ratio of at least one water closet to every four beds.

(d) At least one wheelchair accessible toilet available on the unit.

(e) A staff toilet available on the unit.

(f) Patient bathing facilities with:

(i) Showers or tubs in the ratio of at least one bathing facility per eight beds; and

(ii) At least one wheelchair accessible shower on the psychiatric unit.

(g) Administrative facilities with:

(i) Storage for personal effects of staff apart from storage for patient care supplies and equipment;

(ii) Office or private area for staff and supervisory activities; and

(iii) Conference room for confidential communications on or adjacent to the unit.

(h) Waiting area adjacent to the unit;

(i) A wheelchair-accessible:

(i) Water fountain; and

(ii) Public telephone.

(j) Patient laundry facility with:

(i) A handwash sink;

(ii) Clothes washer;

(iii) Clothes dryer;

(iv) Lockable storage facilities; and

(v) Counter.

(4) Provide patient rooms including:

(a) Maximum capacity of two beds per patient room;

(b) Minimum usable floor space per bed, exclusive of areas taken up by passage door swings, closets, wardrobes, portable lockers and toilet rooms, of:

(i) Eighty square feet in multi-bed rooms; and

(ii) One hundred square feet in one-bed rooms.

(c) Minimum dimension of eleven feet for multi-bed rooms.

(d) The following equipment:

(i) Provision for patient privacy in all multi-bed rooms; and

(ii) A wardrobe, closet, or locker per bed, designed to prevent suicide, for garments and storage of personal effects.

(5) Provide a nursing support station or equivalent with:

(a) A writing surface;

(b) Storage for patient charts and supplies;

(c) A telephone; and

(d) A clock.

(6) Provide a seclusion room, unless provided on an adjacent nursing unit, with:

(a) Design to minimize potential for stimulation, escape, hiding, injury, or suicide;

- (b) Maximum capacity of one patient;
  - (c) Doors to open outward;
  - (d) Minimum space of eighty square feet;
  - (e) Minimum dimension of eight feet;
  - (f) Staff-controlled, lockable, adjoining toilet room; and
  - (g) A provision for staff to see the occupant at all times.
- (7) Provide suitably equipped areas which may be for multipurpose use including areas for:
- (a) Dining;
  - (b) Occupational and recreational therapies;
  - (c) Day room;
  - (d) Physical activity and patient recreation on the unit or elsewhere on the hospital premises; and
  - (e) Space and privacy for interviewing, group, family, and individual counseling.
- (8) If electroconvulsive therapy (ECT) rooms are planned, provide:
- (a) Minimum area of one hundred fifty square feet;
  - (b) Minimum dimension of twelve feet; and
  - (c) The following equipment:
    - (i) Emergency call;
    - (ii) Handwash sink;
    - (iii) Treatment light;
    - (iv) Storage for supplies and equipment;
    - (v) Robe hook and shelf;
    - (vi) Space and electrical receptacles for ECT machine;
    - (vii) Oxygen and suction outlet;
    - (viii) Stretcher or treatment table or equivalent;
    - (ix) Space for emergency medical supplies and equipment;
    - (x) Space for anesthesia machine or cart and equipment;
    - (xi) Space for (EKG) electrocardiograph monitor; and
    - (xii) Clock with sweep second hand or equivalent.
- (9) If ECT is performed, provide a recovery facility, which may be the patient room, with:
- (a) Location near ECT treatment room;
  - (b) Oxygen and suction for each bed, stretcher, or cart;
  - (c) Easy access to a clean and soiled utility room; and
  - (d) Provisions for equipment, space, and functions required in WAC 246-318-310.

[Statutory Authority: RCW 70.41.030. 93-07-011 (Order 338), § 246-318-820, filed 3/5/93, effective 4/5/93. Statutory Authority: RCW 43.70.040. 91-02-049 (Order 121), recodified as § 246-318-820, filed 12/27/90, effective 1/31/91. Statutory Authority: RCW 70.41.030. 90-23-012 (Order 113), § 248-18-536, filed 11/13/90, effective 12/14/90.]

**WAC 246-318-830 Rehabilitation facilities.** Hospitals planning new construction of rehabilitation facilities such as rehabilitation nursing units, physical therapy, occupational therapy, speech therapy, therapeutic recreation shall:

- (1) Follow the general design requirements for architectural components, electrical service, lighting, call systems, hardware, interior finishes, heating, plumbing, sewerage, ventilation/air conditioning, and signage in WAC 246-318-540;
- (2) Provide housekeeping supply room meeting requirements in WAC 246-318-550(6);
- (3) Locate rehabilitation facilities for easy access by patients, avoiding outpatient traffic through inpatient areas meeting accessibility requirements in WAC 51-20-3100;
- (4) Meet the requirements in WAC 246-318-870 for an inpatient rehabilitation nursing unit and provide:

(a) Day/dining, recreation, activity room or rooms totaling at least four hundred square feet for units of twenty beds and twenty square feet for each additional bed, with windows;

(b) Space and privacy for interviewing, group, family, and individual counseling; and

(c) Facilities for patients to launder personal belongings;

(5) Provide outpatient rehabilitation facilities, if planned, with:

(a) Patient toilet and shower facilities meeting accessibility requirements in WAC 51-20-3100 including changing area, lockers, or other suitable clothing storage in or near treatment areas;

(b) Reception and waiting area in or convenient to the facility;

(c) Office and work space with communication device for staff;

(d) Public toilet convenient to the facility and meeting accessibility requirements in WAC 51-20-3100;

(e) Staff facilities on or convenient to the facility meeting requirements in WAC 246-318-550(2) and 51-20-3100; and

(ii) Storage for personal belongings;

(f) Ready access to emergency medical equipment;

(6) Provide physical therapy facilities, if planned, with:

(a) General treatment area including:

(i) Private areas large enough for therapist to access both sides of work station;

(ii) Arrangement to permit easy access for wheelchair or stretcher patients;

(iii) Therapy area of at least thirty-six square feet usable floor area per patient in therapy at any one time; and

(iv) Provision for patient privacy;

(b) Handwash sink in or convenient to treatment areas;

(c) Storage for hot packs and equipment;

(d) Refrigeration for cold packs; and

(e) Area for physical activities and equipment;

(7) Provide occupational therapy facilities, if planned, with:

(a) Therapy areas of at least thirty-six square feet useable floor area per patient in therapy at any one time, divided and equipped for diversified work; and

(b) Handwash sink with plaster trap;

(8) Provide pools, spas, and tubs which remain filled between patients, if planned, meeting requirements in chapter 246-260 WAC;

(9) Provide therapeutic recreation facilities, if planned, with:

(a) Individual therapy areas divided and planned for diversified work; and

(b) Handwash sink with plaster trap;

(10) Provide speech therapy facilities, if planned, with a quiet room of at least forty-eight square feet.

[Statutory Authority: RCW 70.41.030. 93-07-011 (Order 338), § 246-318-830, filed 3/5/93, effective 4/5/93. Statutory Authority: RCW 43.70.040. 91-02-049 (Order 121), recodified as § 246-318-830, filed 12/27/90, effective 1/31/91. Statutory Authority: Chapter 70.41 RCW. 90-12-014 (Order 061), § 248-18-675, filed 5/30/90, effective 6/30/90. Statutory Authority: RCW 70.41.030 and 43.20.050. 83-19-058 (Order 269), § 248-18-675, filed 9/20/83; Order 119, § 248-18-675, filed 5/23/75; Regulation 18.690, filed 1/25/62.]

**WAC 246-318-840 Outpatient care facilities.**

Hospitals planning new construction of facilities for outpatient care shall:

- (1) Follow the general design requirements for architectural components, electrical service, lighting, call systems, hardware, interior finishes, heating, plumbing, sewerage, ventilation/air conditioning, and signage in WAC 246-318-540;
- (2) Provide housekeeping supply room meeting the requirements in WAC 246-318-550(6);
- (3) Provide for the following:
  - (a) Easy access for outpatients with minimal traffic through inpatient areas;
  - (b) Conveniently located waiting room;
  - (c) Patient toilet with handwash sink meeting accessibility requirements in WAC 51-20-3100;
  - (d) Administrative facilities including:
    - (i) Registration area or room;
    - (ii) Work surface or desk;
    - (iii) Telephone;
    - (iv) Clock;
    - (v) Storage space; and
    - (vi) Room for confidential communication, convenient to the unit;
  - (4) Provide facilities meeting the requirements in WAC 246-318-850 and subsection (6) of this section if special procedures are planned;
  - (5) Provide outpatient surgery facilities, if planned, with:
    - (a) Room or rooms for preoperative and predischarge functions with access to service facilities meeting the requirements in WAC 246-318-550(3) clean material room; or WAC 246-318-550(4) clean utility room; WAC 246-318-550(7) medication distribution facility; and WAC 246-318-550(8) soiled materials room; or WAC 246-318-550(9) soiled utility room; and
    - (b) Convenient access to main hospital operating room or provide separate operating room meeting requirements in WAC 246-318-720;
    - (6) Provide outpatient exam or treatment facilities, if planned, with:
      - (a) Direct accessibility from the corridor;
      - (b) Service facilities meeting the requirements in WAC 246-318-550(3) clean materials room; or WAC 246-318-550(4) clean utility room; WAC 246-318-550(7) medication distribution facility; and WAC 246-318-550(8) soiled materials room; or WAC 246-318-550(9) soiled utility room; and
      - (c) Single bed rooms of at least one hundred square feet or multibed room with at least eighty square feet per patient, including:
        - (i) Cubicle curtains or equivalent for each patient in multibed rooms;
        - (ii) Closet, locker, or equivalent for each patient;
        - (iii) Handwash sink, one for every six patients in multibed rooms;
        - (iv) Toilet with handwash sink meeting accessibility requirements in WAC 51-20-3100; and
        - (v) Clock;
        - (d) Exam or treatment rooms including:
          - (i) Minimum eight feet dimension with eighty square feet of usable floor space;
          - (ii) Handwash sink;

- (iii) Examination table;
- (iv) Examination light or equivalent;
- (v) Storage for supplies and equipment;
- (vi) Film illuminator or equivalent conveniently available; and
- (vii) Coat hook or equivalent;
- (e) Nursing support station with:
  - (i) Nurse call annunciator;
  - (ii) Telephone;
  - (iii) Writing surface; and
  - (iv) Storage.

[Statutory Authority: RCW 70.41.030. 93-07-011 (Order 338), § 246-318-840, filed 3/5/93, effective 4/5/93. Statutory Authority: RCW 43.70.040. 91-02-049 (Order 121), recodified as § 246-318-840, filed 12/27/90, effective 1/31/91. Statutory Authority: Chapter 70.41 RCW. 90-12-014 (Order 061), § 248-18-568, filed 5/30/90, effective 6/30/90. Statutory Authority: RCW 70.41.030. 85-23-017 (Order 2302), § 248-18-568, filed 11/13/85.]

**WAC 246-318-850 Special procedure facilities.**

Hospitals planning new construction of special procedure rooms shall:

- (1) Follow the general design requirements for architectural components, electrical service, lighting, call systems, hardware, interior finishes, heating, plumbing, sewerage, ventilation/air conditioning, and signage in WAC 246-318-540;
- (2) Provide convenient and easily accessible support facilities meeting requirements in WAC 246-318-550(3) clean materials room; or WAC 246-318-550(4) clean utility room; WAC 246-318-550(6) housekeeping supply room; WAC 246-318-550(7) medication distribution facility; and WAC 246-318-550(8) soiled materials room; or WAC 246-318-550(9) soiled utility room;
- (3) Locate special procedure rooms for easy access by patients and convenient to waiting area;
- (4) Meet requirements in WAC 246-318-650 (3) and (5) through (19) when imaging procedures are done in special procedure rooms which are not located in the radiology facilities;
- (5) Provide endoscopy room, if planned, with:
  - (a) Minimum fifteen feet room dimension when x-ray equipment is planned for endoscopic procedures; or
  - (b) Minimum twelve feet room dimension for routine endoscopic procedures;
  - (c) Handwash sink;
  - (d) Ceiling mounted surgery light or equivalent;
  - (e) Film illuminator;
  - (f) Clock with sweep second hand or equivalent and interval timer;
  - (g) Supply and equipment storage; and
  - (h) Adjacent toilet with handwash sink;
  - (6) Provide laser room, if planned, with:
    - (a) Handwash sink, unless laser room is in the operating room;
    - (b) Clock with sweep second hand and interval timer, unless laser room is in operating room;
    - (c) Prominently displayed warning sign at entrance;
    - (d) If equipped, viewing windows to provide protection in accordance with manufacturer of laser in use;
    - (e) Supply and equipment storage;



(f) Provision for exhaust in accordance with manufacturer of laser in use;

(g) If watercooled laser is to be used, provide water supply line equipped with vacuum breaker and unalterable air gap for drain; and

(h) Minimally reflective finishes;

(7) Provide angiography room, if planned, with:

(a) Minimum fifteen feet room dimension;

(b) Two scrub sinks;

(c) Work counter;

(d) Supply and equipment storage;

(e) Exam light; and

(f) Clock with sweep second hand and interval timer;

(8) Provide cardiac laser, cardiac cath, angioplasty, valvuloplasty, or other special procedure room, if planned, with:

(a) Minimum twenty feet room dimension;

(b) Two scrub sinks;

(c) Work counter;

(d) Supply and equipment storage;

(e) Exam light; and

(f) Clock with sweep second hand and interval timer;

(9) Provide lithotripsy room, if planned, with:

(a) Minimum fifteen feet room dimension;

(b) Handwash sink, unless lithotripsy device is in operating room;

(c) Work counter;

(d) Supply and equipment storage; and

(e) Clock with sweep second hand and interval timer, unless lithotripsy is done in operating room.

[Statutory Authority: RCW 70.41.030, 93-07-011 (Order 338), § 246-318-850, filed 3/5/93, effective 4/5/93. Statutory Authority: RCW 43.70.040, 91-02-049 (Order 121), recodified as § 246-318-850, filed 12/27/90, effective 1/31/91. Statutory Authority: Chapter 70.41 RCW, 90-12-014 (Order 061), § 248-18-650, filed 5/30/90, effective 6/30/90. Statutory Authority: RCW 70.41.030 and 43.20.050, 83-19-058 (Order 269), § 248-18-650, filed 9/20/83; Order 119, § 248-18-650, filed 5/23/75; Regulation 18.640, filed 1/25/62.]

**WAC 246-318-860 Dialysis facilities.** Hospitals planning new construction of dialysis facilities shall:

(1) Follow the general design requirements for architectural components, electrical service, lighting, call systems, hardware, interior finishes, heating, plumbing, sewerage, ventilation/air conditioning, and signage in WAC 246-318-540 with:

(a) Air changes in patient areas equivalent to a treatment room;

(b) Capture hoods in equipment cleanup or dialyzer reuse preparation rooms:

(i) Capable of maintaining formaldehyde levels less than 0.5 parts per million in the rooms; and

(ii) Exhausting directly to outdoors;

(c) Plumbing for each dialysis station providing:

(i) A water supply system or mechanism capable of meeting the flow and pressure requirements of the manufacturer for each machine;

(ii) A waste line serving dialysis equipment with an unalterable air gap or equivalent to prevent backflow;

(iii) Connections to the dialysis equipment or equivalent to prevent backflow; and

(iv) Piping and fittings used for all dialysis functions conforming to current National Sanitation Foundation Standard No. 14 entitled "Plastics Piping Components,";

(d) Electrical services providing:

(i) A minimum of four single electrical receptacles on emergency power at each dialysis station;

(ii) At least two of the electrical receptacles per station on emergency power connected to a dedicated branch circuit;

(iii) Lighting in each dialysis facility on emergency power; and

(iv) Ground fault circuit interrupter protection for all electrical outlet services in dialysis stations and wet areas.

(2) Provide support facilities meeting the requirements in WAC 246-318-550(3) clean materials room; or WAC 246-318-550(4) clean utility room; WAC 246-318-550(6) housekeeping supply room; WAC 246-318-550(7) medication distribution facility; and WAC 246-318-550(8) soiled materials room; or WAC 246-318-550(9) soiled utility room. Support facilities may be shared with any immediately adjacent facility and includes:

(a) Lockable storage for patient valuables unless provided elsewhere under hospital policy;

(b) Chemical storage in an area within a room; and

(c) Cleanup room for dialysis equipment meeting requirements in WAC 246-318-550 (5)(b), (c), and (d) with eyewash equipment located within the dialysis facility.

(3) Provide a dialysis facility with:

(a) Location to avoid through traffic;

(b) Uncarpeted floors in patient care and wet areas;

(c) Coat hook or equivalent for hanging full length garments;

(d) A medical emergency signal device;

(e) A patient waiting area;

(f) Work station for staff with writing surfaces and storage for supplies;

(g) Patient preparation areas adjacent to dialysis stations with provisions for:

(i) Privacy;

(ii) Handwashing; and

(iii) Storage;

(h) Privacy areas for interviewing and consultation which may be shared;

(i) A conveniently located toilet meeting accessibility requirements in WAC 51-20-3100; and

(j) Patient training room with a handwash sink if home training is planned.

(4) Provide dialysis stations including:

(a) Minimum square feet per dialysis station of:

(i) Seventy square feet excluding aisles when the service uses recliner chairs; and

(ii) Eighty square feet excluding aisles when the service uses beds;

(b) A handwash sink adjacent to each dialysis station; and

(c) A patient nurse call.

[Statutory Authority: RCW 70.41.030, 93-07-011 (Order 338), § 246-318-860, filed 3/5/93, effective 4/5/93. Statutory Authority: RCW 43.70.040, 91-02-049 (Order 121), recodified as § 246-318-860, filed 12/27/90, effective 1/31/91. Statutory Authority: RCW 70.41.030, 90-24-044 (Order 115), § 248-318-860, filed 11/30/90, effective 12/31/90.]

**WAC 246-318-870 Long-term care unit.** Hospitals planning new construction of long-term care facilities of ten or more beds shall:

(1) Follow the general design requirements for architectural components, electrical service, lighting, call systems, hardware, interior finishes, heating, plumbing, sewerage, ventilation/air conditioning, and signage in WAC 246-318-540;

(2) Provide support facilities meeting requirements in WAC 246-318-550(3) clean materials room; or WAC 246-318-550(4) clean utility room; WAC 246-318-550(6) housekeeping supply room; WAC 246-318-550(7) medication distribution facility; WAC 246-318-550(8) soiled materials room; or WAC 246-318-550(9) soiled utility room; and WAC 246-318-550(10) nourishment facilities with provision for bulk ice, including:

(a) Locks on all doors for housekeeping, medications, storage, and utility rooms;

(b) Controlled access, locks on medication rooms;

(c) Linen storage in a clean room; and

(d) General storage space of not less than four square feet per bed within the hospital in addition to closets and equipment storage provided in the long-term care service area;

(3) Provide long-term care facilities with:

(a) Location of facilities described under subsection (2)(a) and (b) of this section on the same floor as long-term care beds;

(b) Location to minimize through traffic and penetration of objectionable noise, odors, or heat from other areas of the hospital;

(c) Wheelchair accessible patient toilets including:

(i) Water closets in a ratio of at least one per four beds;

(ii) Bedpan flushing equipment;

(iii) Accessibility from each patient room;

(iv) A handwash sink in each toilet; and

(v) Grab bars properly located and securely mounted on each side of the water closet;

(d) At least one wheelchair accessible toilet opening directly from the main corridor;

(e) Handrails along both sides of all patient use corridors:

(i) Mounted at thirty-two to thirty-four inches above the floor;

(ii) With ends returned to the walls; and

(iii) Projecting a maximum of three and one-half inches from the wall;

(f) Patient bathing facilities including:

(i) Showers or tubs in a ratio of one per fifteen beds;

(ii) At least one emersion bathing fixture accessible from two sides and one end for wheelchairs and stretchers;

(iii) One roll-in shower or equivalent designed:

(A) For ease of shower chair entry;

(B) With bulk heads a maximum of thirty-four inches high providing for toe space;

(C) With properly sloped and drained floor to prevent the flow of water outside the stall while providing for safe use of a shower chair within the stall; and

(D) With the water inlet approximately four and one-half feet from floor level and a flexible hose approximately five feet long including a lightweight, shampoo-type, spray attachment;

(g) Grab bars including:

(i) One horizontal grab bar a minimum of forty-eight inches long at the side of each standard bathtub with an "L" shaped bar at the faucet end;

(ii) At least one horizontal grab bar at the faucet end of each peninsular bathtub; and

(iii) A horizontal grab bar on two sides of each shower stall with an "L" shaped bar on the shower head side;

(h) Waiting room or area;

(4) Provide patient rooms with:

(a) Maximum capacity of two beds per patient room;

(b) Minimum usable floor space per bed exclusive of areas taken up by passage door swings, closets, wardrobes, portable lockers, and toilet rooms of:

(i) Eighty-five square feet in multibed rooms; and

(ii) One hundred square feet in one-bed rooms;

(c) Minimum dimensions of:

(i) Eleven feet for multibed rooms; and

(ii) Three feet between the sides and the foot of the bed and any wall, fixed obstruction, or other bed;

(d) Space for wheelchair storage;

(e) The provision for patient privacy in all rooms;

(f) One wardrobe, closet, or locker per bed for hanging of full-length garments and a securable drawer for personal effects; and

(g) A handwash sink in each multibed room;

(5) Provide a nursing support station or equivalent including:

(a) Charting surface;

(b) Confidential storage for patients' medical records;

(c) Storage for charting supplies;

(d) Clock; and

(e) Telephone;

(6) Provide staff facilities including:

(a) Toilet;

(b) Securable storage for personal effects apart from storage for patient care supplies and equipment;

(c) Office for confidential management and staff communications; and

(d) Conference room for confidential staff and family communication;

(7) Provide suitably equipped patient areas in the long-term care facility for:

(a) Dining room;

(b) Recreational activity; and

(c) Dayroom with windows;

(8) Provide occupational therapy and physical therapy facilities as described in WAC 246-318-830 either in the long-term care unit or elsewhere in the hospital;

(9) Include the following features if planning to provide a protective facility for cognitively impaired patients:

(a) Corridors with the following minimum widths:

(i) Ten feet;

(ii) Eight feet for a circular route allowing the patient to return to the patient's starting point without reversing direction; or

(iii) As permitted under chapter 248-14 WAC specifically for construction of facilities for the cognitively impaired;

(b) Floors, walls, and ceiling surfaces displaying contrasting colors for identification;

(c) Door thresholds of one-half inch or less;

(d) Exits secured by alarms or doors requiring cognitive ability to open or other methods provided doors release upon activation of the fire alarm system and upon loss of power;

(e) Instruction labels on door release devices requiring direction for use;

(f) Secured outdoor space and walkways, when outdoor space is provided, including:

(i) Walls or fences at least six feet high and designed to prevent climbing and penetration;

(ii) Ambulation area with:

(A) Walking surfaces firm, stable, and free from abrupt changes in elevation; and

(B) Slip-resistant surfaces on areas subject to wet conditions;

(iii) Exits from the secured outdoor spaces and walkways releasing automatically upon activation of fire alarm signal or upon loss of power.

[Statutory Authority: RCW 70.41.030. 93-07-011 (Order 338), § 246-318-870, filed 3/5/93, effective 4/5/93. Statutory Authority: RCW 43.70.040. 91-02-049 (Order 121), recodified as § 246-318-870, filed 12/27/90, effective 1/31/91. Statutory Authority: RCW 70.41.030. 90-24-044 (Order 115), § 248-318-870, filed 11/30/90, effective 12/31/90.]

**WAC 246-318-990 Fees.** Hospitals licensed under chapter 70.41 RCW shall:

(1) Submit an annual license fee of forty-seven dollars and thirty cents for each bed space within the licensed bed capacity of the hospital to the department;

(2) Include all bed spaces in rooms complying with physical plant and movable equipment requirements of this chapter for twenty-four-hour assigned patient rooms;

(3) Include neonatal intensive care bassinet spaces;

(4) Include bed spaces assigned for less than twenty-four-hour patient use as part of the licensed bed capacity when:

(a) Physical plant requirements of this chapter are met without movable equipment; and

(b) The hospital currently possesses the required movable equipment and certifies this fact to the department;

(5) Exclude all normal infant bassinets;

(6) Limit licensed bed spaces as required under chapter 70.38 RCW;

(7) Submit an application for bed additions to the department for review and approval under chapter 70.38 RCW subsequent to department establishment of the hospital licensed bed capacity; and

(8) Set up twenty-four-hour assigned patient beds only within the licensed bed capacity approved by the department.

[Statutory Authority: RCW 43.70.250, 43.70.110 and 43.20B.020. 95-12-097, § 246-318-990, filed 6/7/95, effective 7/8/95. Statutory Authority: RCW 43.70.250. 92-12-028 (Order 273), § 246-318-990, filed 5/28/92, effective 6/28/92. Statutory Authority: RCW 43.70.040. 91-02-050 (Order 122), § 246-318-990, filed 12/27/90, effective 1/31/91.]

**WAC 246-318-99902 Appendix B—Dates of documents adopted by reference in chapter 246-318 WAC.**

(1) National Fire Protection Association (NFPA), 99, Chapter 12, 1990. Required.

(2) American Society of Heating, Refrigerating, and Air Conditioning Engineers (ASHRAE) Handbook - five volumes: 1987 HVAC Systems and Applications; 1988

Equipment; 1989 Fundamentals; 1990 Refrigeration and 1991 HVAC Applications. Recommended.

(3) Uniform Plumbing Code, 1991 edition, hereafter amended by the state of Washington. Required.

(4) National Fire Protection Association (NFPA), 99, Chapter 4, 1990. Required.

(5) National Fire Protection Association (NFPA), 90A-1989. Required.

(6) Uniform Mechanical Code, 1991 edition, hereafter amended by the state of Washington. Required.

(7) National Fire Protection Association (NFPA) 70-1990. Required.

(8) Uniform Fire Code, Article 79, 1991 edition. Required.

(9) National Fire Protection Association (NFPA) 99, Chapter 7, 1990. Required.

(10) National Fire Protection Association (NFPA) 43C-1986. Required.

(11) National Council on Radiation Protection Handbook No. 49. Required.

(12) Uniform Building Code, 1991 edition, hereafter amended by the state of Washington. Required.

(13) Chapter 212-12 WAC Fire Marshal Standards. Required.

(14) National Fire Protection Association (NFPA), 101, 1988 edition. Required.

[Statutory Authority: RCW 70.41.030. 93-07-011 (Order 338), § 246-318-99902, filed 3/5/93, effective 4/5/93. Statutory Authority: RCW 43.70.040. 91-02-049 (Order 121), recodified as § 246-318-99902, filed 12/27/90, effective 1/31/91. Statutory Authority: Chapter 70.41 RCW. 90-12-014 (Order 061), § 248-18-99902, filed 5/30/90, effective 6/30/90. Statutory Authority: RCW 70.41.030. 89-22-105 (Order 009), § 248-18-99902, filed 11/1/89, effective 12/2/89; 88-16-086 (Order 2667), § 248-18-99902, filed 8/2/88; 87-04-061 (Order 2466), § 248-18-99902, filed 2/4/87. Statutory Authority: RCW 70.41.030 and 43.20.050. 85-05-033 (Order 280), § 248-18-99902, filed 2/15/85; 82-24-001 (Order 248), § 248-18-99902, filed 11/18/82.]

**WAC 246-318-99910 Appendix J—Guidelines for laboratory quality assurance program in hospitals.** (1) Services.

(a) Hospitals shall ensure all in-hospital testing procedures performed on biological specimens, body fluids, or tissues comply with this section in terms of:

(i) Sufficient equipment, and

(ii) Appropriately trained staff.

(b) Hospitals allowing performance of tests on biological specimens in areas outside of the designated hospital laboratory but within the hospital shall provide evidence to the department on staff training and quality control as described in subsections (2)(b) and (3)(b)(i) through (iv) of this section.

(c) Hospitals where biological specimens are sent outside of the hospital for testing shall obtain and maintain evidence of laboratory quality control consistent with subsection (3)(a), (b), and (c) of this section.

(2) Personnel. Hospitals shall ensure:

(a) Twenty-four hour per day on-site or phone availability of:

(i) Pathology services provided by a physician,

(ii) Appropriate technical consultation services.

(b) Appropriately trained personnel to perform each laboratory procedure.

## (3) Quality control.

(a) Laboratories shall perform satisfactorily in a proficiency testing program approved by the department.

(b) Each hospital shall maintain a quality control program related to all tests on biological specimens including:

(i) Maintenance of current procedure manuals;

(ii) Functional verification, calibration, and preventive maintenance of instruments and equipment;

(iii) Demonstration of accuracy and precision of test results; and

(iv) Appropriate documentation.

(c) Hospitals shall establish and maintain:

(i) A timely, appropriate review of all test results, and

(ii) Quality control records.

(4) Facilities. Hospitals shall provide:

(a) Emergency power with sufficient outlets for blood bank refrigerators and other testing procedure equipment,

(b) Protection from power line voltage disturbance in certain electronic equipment, as necessary.

(c) Adequate space for:

(i) Patient safety;

(ii) Storage of materials, equipment, and supplies;

(iii) Electrical support functions; and

(iv) Performance and equipment associated with laboratory testing procedures.

(d) A signal to a staffed area from the blood refrigerator alarm.

(5) Reports and records. Hospitals shall:

(a) Make reports of test results available to appropriate authorized persons in a timely fashion, and

(b) Maintain a system for two-year retention and retrieval of laboratory test results and quality control records.

[Statutory Authority: RCW 43.70.040. 91-02-049 (Order 121), recodified as § 246-318-99910, filed 12/27/90, effective 1/31/91. Statutory Authority: RCW 70.41.030. 87-24-038 (Order 2560), § 248-18-99910, filed 11/25/87.]

### Chapter 246-321 WAC HOSPICE CARE CENTER

#### WAC

246-321-001	Purpose.
246-321-010	Definitions.
246-321-012	Licensure—Notice of decision—Adjudicative proceeding.
246-321-014	Governing body and administration.
246-321-015	Staff—Personnel—Volunteers.
246-321-017	HIV/AIDS education and training.
246-321-018	Criminal history, disclosure, and background inquiries.
246-321-020	Policies and procedures.
246-321-025	Patient care services.
246-321-030	Food and dietary services.
246-321-035	Infection control.
246-321-040	Pharmaceutical service.
246-321-045	Clinical records.
246-321-050	Physical environment and equipment.
246-321-055	Nonflammable medical gases—Respiratory care.
246-321-990	Fees.

**WAC 246-321-001 Purpose.** Regulations for hospice care centers are hereby adopted pursuant to chapter 70.41 RCW. The purpose of these regulations is to provide minimal standards for safety and adequate care of terminally ill individuals who choose to receive palliative rather than

curative care and treatment for varying periods of time in a segregated, organized, specialized hospital or health care center.

[Statutory Authority: RCW 43.70.040. 91-02-049 (Order 121), recodified as § 246-321-001, filed 12/27/90, effective 1/31/91. Statutory Authority: RCW 43.20.050. 81-23-003 (Order 218), § 248-21-001, filed 11/6/81.]

**WAC 246-321-010 Definitions.** For the purposes of these regulations, the following words and phrases shall have the following meanings unless the context clearly indicates otherwise.

(1) "Active volunteer" means unpaid worker or workers providing direct care to patients or clients and/or working with clinical records or confidential client information.

(2) "Adjunctive therapies" means those prescribed services provided by medically related disciplines which include but are not limited to physical therapy, occupational therapy, recreational therapy, music therapy, respiratory therapy.

(3) "Administrator" means an individual appointed as chief executive officer by the governing body of the center to act in its behalf in the overall management of the hospice care center.

(4) "Authenticated" or "authentication" means authorization of a written entry in a record or chart by means of a signature which shall include, minimally, first initial, last name, and title.

(5) "Bathing facility" means a bathtub, shower, or equivalent.

(6) "Bereavement care" means consultation, support, counseling, and follow-up of the client before and following the death of a patient.

(7) "Client" means the patient and family which together compose the unit of care in the hospice care center.

(8) "Client education" means provision of information on physical care, disease symptomatology, palliative treatment, psychosocial coping skills, availability, and utilization of community resources.

(9) "Clinical record" means a file containing all pertinent clinical information about a particular patient to include: Identifying information, data bases, assessment, individualized comprehensive care plan, diagnosis, treatment, progress notes, other clinical events, and a discharge summary.

(10) "Department" means the Washington state department of health.

(11) "Dietitian" means a person who is eligible for membership in the American Dietetic Association.

(12) "Drug" means medication, chemical, device, or other material used in the diagnosis and/or treatment of injury, illness, or disease.

(13) "Drug administration" means an act in which a single dose of a prescribed drug or a biological is given to a patient by an authorized person in accordance with all laws and regulations governing such acts. The complete act of administration entails removing an individual dose from a previously dispensed, properly labeled container, verifying it with the order of the physician, giving the individual dose to the proper patient, and properly recording the time and dose given.

(14) "Drug dispensing" means an act entailing the interpretation of an order (prescription) for a drug or