

Title 468 WAC

TRANSPORTATION, DEPARTMENT OF

(Formerly: Highway Commission, etc.)

<p>Chapters</p> <p>468-06 468-10 468-12</p> <p>468-16 468-18 468-20 468-22</p> <p>468-30 468-32 468-34 468-38</p> <p>468-46 468-48</p> <p>468-51</p> <p>468-52</p> <p>468-54 468-58 468-66 468-70 468-72 468-74 468-85</p> <p>468-86 468-95</p> <p>468-100</p> <p>468-105</p> <p>468-200</p> <p>468-210 468-220 468-230 468-240 468-250 468-300 468-310</p> <p>468-320</p> <p>468-400 468-500</p>	<p>Public access to information and records.</p> <p>Practice and procedure.</p> <p>Transportation commission and transportation department State Environmental Policy Act rules.</p> <p>Prequalification of contractors.</p> <p>City/county project coordination.</p> <p>Dishonored checks.</p> <p>County ferry franchises, tolls, and financial assistance.</p> <p>Highway property.</p> <p>Safety rest areas.</p> <p>Utility lines—Franchises and permits.</p> <p>Vehicle size and weight—Restricted highways—Equipment.</p> <p>Transit vehicle stop zones.</p> <p>Highway corridor and alignment authority.</p> <p>Highway access management access permits—Administrative process.</p> <p>Highway access management—Access control classification system and standards.</p> <p>Limited access hearings.</p> <p>Limited access highways.</p> <p>Highway Advertising Control Act.</p> <p>Motorist information signs.</p> <p>Adopt-a-highway litter control program.</p> <p>Junkyards adjacent to highways.</p> <p>Regulations regarding advanced financial support payments for the development of comprehensive transit plans.</p> <p>RTPO planning standards and guidelines.</p> <p>Manual on uniform traffic control devices for streets and highways.</p> <p>Uniform relocation assistance and real property acquisition.</p> <p>Public advisory elections for selected state transportation facilities.</p> <p>Conduct and management of emergency air operations air search & rescue/disaster relief.</p> <p>Pilot registration.</p> <p>Aircraft—Indicia of registration.</p> <p>Commercial airports.</p> <p>Obstruction marking and lighting.</p> <p>State airport rules.</p> <p>State ferries and toll bridges.</p> <p>Prequalification of ferry system contractors.</p> <p>Washington state ferry vessel construction, maintenance and repair contracts—Alternate forms of security and determination of bonding amount required.</p> <p>Bicycle racing.</p> <p>Commission meetings.</p>
--	---

<p>468-510 468-550</p>	<p>Lane use restrictions.</p> <p>Safety oversight of rail fixed guideway systems rules.</p>
----------------------------	---

DISPOSITION OF CHAPTERS FORMERLY CODIFIED IN THIS TITLE

<p>Chapter 468-14</p> <p>SMALL BUSINESSES AND MINORITY CONTRACTORS</p>	
<p>468-14-010 468-14-020 468-14-030 468-14-040 468-14-050</p>	<p>General. [Statutory Authority: 1977 ex.s. c 151. 79-01-033 (DOT Order 10 and Comm. Order 1, Resolution No. 13), § 468-14-010, filed 12/20/78. Formerly WAC 252-50-010.] Repealed by 00-11-133, filed 5/23/00, effective 6/23/00. Statutory Authority: RCW 47.28.030.</p> <p>Call for bids—Limitation on contract amount. [Statutory Authority: 1977 ex.s. c 151. 79-01-033 (DOT Order 10 and Comm. Order 1, Resolution No. 13), § 468-14-020, filed 12/20/78. Formerly WAC 252-50-020.] Repealed by 00-11-133, filed 5/23/00, effective 6/23/00. Statutory Authority: RCW 47.28.030.</p> <p>Precontract preparation of plans and specifications. [Statutory Authority: 1977 ex.s. c 151. 79-01-033 (DOT Order 10 and Comm. Order 1, Resolution No. 13), § 468-14-030, filed 12/20/78. Formerly WAC 252-50-025.] Repealed by 00-11-133, filed 5/23/00, effective 6/23/00. Statutory Authority: RCW 47.28.030.</p> <p>Prequalification—Form of bid—Requirements. [Statutory Authority: 1977 ex.s. c 151. 79-01-033 (DOT Order 10 and Comm. Order 1, Resolution No. 13), § 468-14-040, filed 12/20/78. Formerly WAC 252-50-030.] Repealed by 00-11-133, filed 5/23/00, effective 6/23/00. Statutory Authority: RCW 47.28.030.</p> <p>Bonds—Withholding on monthly progress payments. [Statutory Authority: RCW 47.28.030(2). 86-01-064 (Order 100), § 468-14-050, filed 12/17/85. Statutory Authority: 1977 ex.s. c 151. 79-01-033 (DOT Order 10 and Comm. Order 1, Resolution No. 13), § 468-14-050, filed 12/20/78. Formerly WAC 252-50-040.] Repealed by 00-11-133, filed 5/23/00, effective 6/23/00. Statutory Authority: RCW 47.28.030.</p>

Chapter 468-42 VEHICLE PARKING RESTRICTIONS

<p>468-42-002 468-42-003 468-42-004 468-42-005</p>	<p>State Route 2. [Statutory Authority: RCW 46.61.570. 79-04-019 (Order 24), § 468-42-002, filed 3/19/79. Statutory Authority: 1977 ex.s. c 151. 79-01-033 (DOT Order 10 and Comm. Order 1, Resolution No. 13), § 468-42-002, filed 12/20/78. Formerly WAC 252-32-002.] Repealed by 83-09-038 (Order 78), filed 4/18/83. Statutory Authority: RCW 46.61.575 and 34.04.010.</p> <p>State Route 3. [Statutory Authority: 1977 ex.s. c 151. 79-01-033 (DOT Order 10 and Comm. Order 1, Resolution No. 13), § 468-42-003, filed 12/20/78. Formerly WAC 252-32-003.] Repealed by 83-09-038 (Order 78), filed 4/18/83. Statutory Authority: RCW 46.61.575 and 34.04.010.</p> <p>State Route 4. [Statutory Authority: RCW 46.61.570. 79-04-021 (Order 26), § 468-42-004, filed 3/19/79. Statutory Authority: 1977 ex.s. c 151. 79-01-033 (DOT Order 10 and Comm. Order 1, Resolution No. 13), § 468-42-004, filed 12/20/78. Formerly WAC 252-32-004.] Repealed by 83-09-038 (Order 78), filed 4/18/83. Statutory Authority: RCW 46.61.575 and 34.04.010.</p> <p>State Route 5. [Statutory Authority: 1977 ex.s. c 151. 79-01-033 (DOT Order 10 and Comm. Order 1, Resolution No. 13), § 468-42-005, filed 12/20/78. Formerly WAC 252-32-005.] Repealed by 83-09-038 (Order 78), filed 4/18/83. Statutory Authority: RCW 46.61.575 and 34.04.010.</p>
--	---

tion No. 13), § 468-42-901, filed 12/20/78. Formerly WAC 252-32-901.] Repealed by 83-09-038 (Order 78), filed 4/18/83. Statutory Authority: RCW 46.61.575 and 34.04.010.

468-42-906 State Route 906. [Statutory Authority: 1977 ex.s. c 151. 79-01-033 (DOT Order 10 and Comm. Order 1, Resolution No. 13), § 468-42-906, filed 12/20/78. Formerly WAC 252-32-906.] Repealed by 83-09-038 (Order 78), filed 4/18/83. Statutory Authority: RCW 46.61.575 and 34.04.010.

468-42-908 State Route 908. [Statutory Authority: 1977 ex.s. c 151. 79-01-033 (DOT Order 10 and Comm. Order 1, Resolution No. 13), § 468-42-908, filed 12/20/78. Formerly WAC 252-32-908.] Repealed by 83-09-038 (Order 78), filed 4/18/83. Statutory Authority: RCW 46.61.575 and 34.04.010.

Chapter 468-50 AUTO STAGE SPEED RESTRICTIONS

468-50-010 Speed limits for auto stages on state highways. [Statutory Authority: 1977 ex.s. c 151. 79-01-033 (DOT Order 10 and Comm. Order 1, Resolution No. 13), § 468-50-010, filed 12/20/78. Formerly WAC 252-36-010.] Repealed by 83-09-039 (Order 79), filed 4/18/83. Statutory Authority: RCW 46.61.405, 46.61.410 and 34.04.010.

Chapter 468-62 HIGHWAY ILLUMINATION

468-62-010 Interstate highways. [Statutory Authority: 1977 ex.s. c 151. 79-01-033 (DOT Order 10 and Comm. Order 1, Resolution No. 13), § 468-62-010, filed 12/20/78. Formerly WAC 252-30-010.] Repealed by 82-13-014 (Order 71), filed 6/7/82. Statutory Authority: RCW 47.01.101(5).

468-62-020 Freeways (other than interstate). [Statutory Authority: 1977 ex.s. c 151. 79-01-033 (DOT Order 10 and Comm. Order 1, Resolution No. 13), § 468-62-020, filed 12/20/78. Formerly WAC 252-30-020.] Repealed by 82-13-014 (Order 71), filed 6/7/82. Statutory Authority: RCW 47.01.101(5).

468-62-030 Four-lane highways. [Statutory Authority: 1977 ex.s. c 151. 79-01-033 (DOT Order 10 and Comm. Order 1, Resolution No. 13), § 468-62-030, filed 12/20/78. Formerly WAC 252-30-030.] Repealed by 82-13-014 (Order 71), filed 6/7/82. Statutory Authority: RCW 47.01.101(5).

468-62-040 Two-lane highways. [Statutory Authority: 1977 ex.s. c 151. 79-01-033 (DOT Order 10 and Comm. Order 1, Resolution No. 13), § 468-62-040, filed 12/20/78. Formerly WAC 252-30-040.] Repealed by 82-13-014 (Order 71), filed 6/7/82. Statutory Authority: RCW 47.01.101(5).

468-62-050 Other conditions justifying illumination. [Statutory Authority: 1977 ex.s. c 151. 79-01-033 (DOT Order 10 and Comm. Order 1, Resolution No. 13), § 468-62-050, filed 12/20/78. Formerly WAC 252-30-050.] Repealed by 82-13-014 (Order 71), filed 6/7/82. Statutory Authority: RCW 47.01.101(5).

468-62-060 Illumination by others. [Statutory Authority: 1977 ex.s. c 151. 79-01-033 (DOT Order 10 and Comm. Order 1, Resolution No. 13), § 468-62-060, filed 12/20/78. Formerly WAC 252-30-110.] Repealed by 82-13-014 (Order 71), filed 6/7/82. Statutory Authority: RCW 47.01.101(5).

Chapter 468-78 TRANSPORTATION BUILDINGS—WORKS OF ART

468-78-010 Authority. [Statutory Authority: 1977 ex.s. c 151. 79-01-033 (DOT Order 10 and Comm. Order 1, Resolution No. 13), § 468-78-010, filed 12/20/78. Formerly WAC 252-60-010.] Repealed by 86-01-065 (Order 101), filed 12/17/85. Statutory Authority: RCW 47.01.101(5).

468-78-020 Funding. [Statutory Authority: 1977 ex.s. c 151. 79-01-033 (DOT Order 10 and Comm. Order 1, Resolution No. 13), § 468-78-020, filed 12/20/78. Formerly WAC 252-60-020.] Repealed by 86-01-065 (Order 101), filed 12/17/85. Statutory Authority: RCW 47.01.101(5).

468-78-030 Powers. [Statutory Authority: 1977 ex.s. c 151. 79-01-033 (DOT Order 10 and Comm. Order 1, Resolution No. 13), § 468-78-030, filed 12/20/78. Formerly WAC 252-60-030.] Repealed by 86-01-065 (Order 101), filed 12/17/85. Statutory Authority: RCW 47.01.101(5).

Chapter 468-82

REGULATIONS REGARDING PASS-THROUGH OF UNITED STATES URBAN MASS TRANSPORTATION ADMINISTRATION FUNDS FOR PUBLIC TRANSPORTATION TECHNICAL STUDIES

468-82-010 General purpose and applicability. [Statutory Authority: RCW 47.01.101. 80-01-079 (Order 44), § 468-82-010, filed 12/26/79.] Repealed by 98-11-044 (Order 174), filed 5/18/98, effective 6/18/98. Statutory Authority: RCW 47.01.101.

468-82-015 Definitions. [Statutory Authority: RCW 47.01.101. 80-01-079 (Order 44), § 468-82-015, filed 12/26/79.] Repealed by 98-11-044 (Order 174), filed 5/18/98, effective 6/18/98. Statutory Authority: RCW 47.01.101.

468-82-110 Application for technical study grant. [Statutory Authority: RCW 47.01.101. 80-01-079 (Order 44), § 468-82-110, filed 12/26/79.] Repealed by 98-11-044 (Order 174), filed 5/18/98, effective 6/18/98. Statutory Authority: RCW 47.01.101.

468-82-120 Department response to application. [Statutory Authority: RCW 47.01.101. 80-01-079 (Order 44), § 468-82-120, filed 12/26/79.] Repealed by 98-11-044 (Order 174), filed 5/18/98, effective 6/18/98. Statutory Authority: RCW 47.01.101.

468-82-200 Application prioritization criteria. [Statutory Authority: RCW 47.01.101. 80-01-079 (Order 44), § 468-82-200, filed 12/26/79.] Repealed by 98-11-044 (Order 174), filed 5/18/98, effective 6/18/98. Statutory Authority: RCW 47.01.101.

Chapter 468-84 REGULATIONS REGARDING ADVANCED FINANCIAL SUPPORT PAYMENTS FOR THE CONDUCT OF PUBLIC TRANSPORTATION FEASIBILITY STUDIES

468-84-010 General purpose and applicability. [Statutory Authority: RCW 35.58.2712 and 1979 c 59. 79-12-036 (Order 39), § 468-84-010, filed 11/20/79.] Repealed by 98-11-045 (Order 175), filed 5/18/98, effective 6/18/98. Statutory Authority: RCW 35.58.2712.

468-84-015 Definitions. [Statutory Authority: RCW 35.58.2712 and 1979 c 59. 79-12-036 (Order 39), § 468-84-015, filed 11/20/79.] Repealed by 98-11-045 (Order 175), filed 5/18/98, effective 6/18/98. Statutory Authority: RCW 35.58.2712.

468-84-110 Application. [Statutory Authority: RCW 35.58.2712 and 1979 c 59. 79-12-036 (Order 39), § 468-84-110, filed 11/20/79.] Repealed by 98-11-045 (Order 175), filed 5/18/98, effective 6/18/98. Statutory Authority: RCW 35.58.2712.

468-84-120 Department response to application. [Statutory Authority: RCW 35.58.2712 and 1979 c 59. 79-12-036 (Order 39), § 468-84-120, filed 11/20/79.] Repealed by 98-11-045 (Order 175), filed 5/18/98, effective 6/18/98. Statutory Authority: RCW 35.58.2712.

468-84-130 Conditions of advanced financial support payments. [Statutory Authority: RCW 35.58.2712 and 1979 c 59. 79-12-036 (Order 39), § 468-84-130, filed 11/20/79.] Repealed by 98-11-045 (Order 175), filed 5/18/98, effective 6/18/98. Statutory Authority: RCW 35.58.2712.

468-84-135 Conditions of grants. [Statutory Authority: RCW 35.58.2712 and 1979 c 59. 79-12-036 (Order 39), § 468-84-135, filed 11/20/79.] Repealed by 98-11-045 (Order 175), filed 5/18/98, effective 6/18/98. Statutory Authority: RCW 35.58.2712.

468-84-200 Required elements of feasibility study. [Statutory Authority: RCW 35.58.2712 and 1979 c 59. 79-12-036 (Order 39), § 468-84-200, filed 11/20/79.] Repealed by 98-11-045 (Order 175), filed 5/18/98, effective 6/18/98. Statutory Authority: RCW 35.58.2712.

468-84-210 Geographical extent. [Statutory Authority: RCW 35.58.2712 and 1979 c 59. 79-12-036 (Order 39), § 468-84-210, filed 11/20/79.] Repealed by 98-11-045 (Order 175), filed 5/18/98, effective 6/18/98. Statutory Authority: RCW 35.58.2712.

468-84-220 Identification of related transportation operations. [Statutory Authority: RCW 35.58.2712 and 1979 c 59. 79-12-036 (Order 39), § 468-84-220, filed 11/20/79.] Repealed by 98-11-045 (Order 175), filed 5/18/98, effective 6/18/98. Statutory Authority: RCW 35.58.2712.

468-84-230 Estimation of need. [Statutory Authority: RCW 35.58.2712 and 1979 c 59. 79-12-036 (Order 39), § 468-

- 84-230, filed 11/20/79.] Repealed by 98-11-045 (Order 175), filed 5/18/98, effective 6/18/98. Statutory Authority: RCW 35.58.2712.
- 468-84-240 Alternative management schemes. [Statutory Authority: RCW 35.58.2712 and 1979 c 59. 79-12-036 (Order 39), § 468-84-240, filed 11/20/79.] Repealed by 98-11-045 (Order 175), filed 5/18/98, effective 6/18/98. Statutory Authority: RCW 35.58.2712.
- 468-84-250 Alternative funding sources. [Statutory Authority: RCW 35.58.2712 and 1979 c 59. 79-12-036 (Order 39), § 468-84-250, filed 11/20/79.] Repealed by 98-11-045 (Order 175), filed 5/18/98, effective 6/18/98. Statutory Authority: RCW 35.58.2712.
- 468-84-260 Consideration of school district pupil transportation. [Statutory Authority: RCW 35.58.2712 and 1979 c 59. 79-12-036 (Order 39), § 468-84-260, filed 11/20/79.] Repealed by 98-11-045 (Order 175), filed 5/18/98, effective 6/18/98. Statutory Authority: RCW 35.58.2712.
- 468-84-300 Submission of feasibility study to department. [Statutory Authority: RCW 35.58.2712 and 1979 c 59. 79-12-036 (Order 39), § 468-84-300, filed 11/20/79.] Repealed by 98-11-045 (Order 175), filed 5/18/98, effective 6/18/98. Statutory Authority: RCW 35.58.2712.
- 468-84-310 Submission of municipal resolution to department. [Statutory Authority: RCW 35.58.2712 and 1979 c 59. 79-12-036 (Order 39), § 468-84-310, filed 11/20/79.] Repealed by 98-11-045 (Order 175), filed 5/18/98, effective 6/18/98. Statutory Authority: RCW 35.58.2712.
- 468-84-320 Submission of municipal ordinance levying and collecting taxes to department. [Statutory Authority: RCW 35.58.2712 and 1979 c 59. 79-12-036 (Order 39), § 468-84-320, filed 11/20/79.] Repealed by 98-11-045 (Order 175), filed 5/18/98, effective 6/18/98. Statutory Authority: RCW 35.58.2712.

Chapter 468-87

REGULATIONS REGARDING FINANCIAL SUPPORT TO PRIVATE, NONPROFIT CORPORATIONS FOR CAPITAL ASSISTANCE IN PROVIDING TRANSPORTATION FOR THE ELDERLY AND HANDICAPPED

- 468-87-010 Definitions. [Statutory Authority: RCW 47.01.101(5). 81-10-058 (Order 91), § 468-87-010, filed 5/5/81. Formerly WAC 365-42-010.] Repealed by 85-01-054 (Order 91), filed 12/17/84. Statutory Authority: RCW 47.01.101(5).
- 468-87-020 Program description. [Statutory Authority: RCW 47.01.101(5). 81-10-058 (Order 91), § 468-87-020, filed 5/5/81. Formerly WAC 365-42-020.] Repealed by 85-01-054 (Order 91), filed 12/17/84. Statutory Authority: RCW 47.01.101(5).
- 468-87-030 Purpose. [Statutory Authority: RCW 47.01.101(5). 81-10-058 (Order 91), § 468-87-030, filed 5/5/81. Formerly WAC 365-42-030.] Repealed by 85-01-054 (Order 91), filed 12/17/84. Statutory Authority: RCW 47.01.101(5).
- 468-87-100 Program period. [Statutory Authority: RCW 47.01.101(5). 81-10-058 (Order 91), § 468-87-100, filed 5/5/81. Formerly WAC 365-42-100.] Repealed by 85-01-054 (Order 91), filed 12/17/84. Statutory Authority: RCW 47.01.101(5).
- 468-87-110 Qualification criteria. [Statutory Authority: RCW 47.01.101(5). 81-10-058 (Order 91), § 468-87-110, filed 5/5/81. Formerly WAC 365-42-110.] Repealed by 85-01-054 (Order 91), filed 12/17/84. Statutory Authority: RCW 47.01.101(5).
- 468-87-200 Application procedures. [Statutory Authority: RCW 47.01.101(5). 81-10-058 (Order 91), § 468-87-200, filed 5/5/81. Formerly WAC 365-42-200.] Repealed by 85-01-054 (Order 91), filed 12/17/84. Statutory Authority: RCW 47.01.101(5).
- 468-87-210 Evaluation of applications. [Statutory Authority: RCW 47.01.101(5). 81-10-058 (Order 91), § 468-87-210, filed 5/5/81. Formerly WAC 365-42-210.] Repealed by 85-01-054 (Order 91), filed 12/17/84. Statutory Authority: RCW 47.01.101(5).
- 468-87-220 Coordination. [Statutory Authority: RCW 47.01.101(5). 81-10-058 (Order 91), § 468-87-220, filed 5/5/81. Formerly WAC 365-42-220.] Repealed by 85-01-054 (Order 91), filed 12/17/84. Statutory Authority: RCW 47.01.101(5).
- 468-87-230 Selection. [Statutory Authority: RCW 47.01.101(5). 81-10-058 (Order 91), § 468-87-230, filed 5/5/81. For-

- merly WAC 365-42-230.] Repealed by 85-01-054 (Order 91), filed 12/17/84. Statutory Authority: RCW 47.01.101(5).
- 468-87-240 State application. [Statutory Authority: RCW 47.01.101(5). 81-10-058 (Order 91), § 468-87-240, filed 5/5/81. Formerly WAC 365-42-240.] Repealed by 85-01-054 (Order 91), filed 12/17/84. Statutory Authority: RCW 47.01.101(5).
- 468-87-300 Contract. [Statutory Authority: RCW 47.01.101(5). 81-10-058 (Order 91), § 468-87-300, filed 5/5/81. Formerly WAC 365-42-300.] Repealed by 85-01-054 (Order 91), filed 12/17/84. Statutory Authority: RCW 47.01.101(5).
- 468-87-310 Surplus funds. [Statutory Authority: RCW 47.01.101(5). 81-10-058 (Order 91), § 468-87-310, filed 5/5/81. Formerly WAC 365-42-310.] Repealed by 85-01-054 (Order 91), filed 12/17/84. Statutory Authority: RCW 47.01.101(5).
- 468-87-320 Equipment purchasing. [Statutory Authority: RCW 47.01.101(5). 81-10-058 (Order 91), § 468-87-320, filed 5/5/81. Formerly WAC 365-42-320.] Repealed by 85-01-054 (Order 91), filed 12/17/84. Statutory Authority: RCW 47.01.101(5).
- 468-87-330 UMTA interest. [Statutory Authority: RCW 47.01.101(5). 81-10-058 (Order 91), § 468-87-330, filed 5/5/81. Formerly WAC 365-42-330.] Repealed by 85-01-054 (Order 91), filed 12/17/84. Statutory Authority: RCW 47.01.101(5).
- 468-87-340 Equipment acceptance. [Statutory Authority: RCW 47.01.101(5). 81-10-058 (Order 91), § 468-87-340, filed 5/5/81. Formerly WAC 365-42-340.] Repealed by 85-01-054 (Order 91), filed 12/17/84. Statutory Authority: RCW 47.01.101(5).
- 468-87-350 Vehicle registration and licensing. [Statutory Authority: RCW 47.01.101(5). 81-10-058 (Order 91), § 468-87-350, filed 5/5/81. Formerly WAC 365-42-350.] Repealed by 85-01-054 (Order 91), filed 12/17/84. Statutory Authority: RCW 47.01.101(5).
- 468-87-360 Equipment use. [Statutory Authority: RCW 47.01.101(5). 81-10-058 (Order 91), § 468-87-360, filed 5/5/81. Formerly WAC 365-42-360.] Repealed by 85-01-054 (Order 91), filed 12/17/84. Statutory Authority: RCW 47.01.101(5).
- 468-87-370 Maintenance. [Statutory Authority: RCW 47.01.101(5). 81-10-058 (Order 91), § 468-87-370, filed 5/5/81. Formerly WAC 365-42-370.] Repealed by 85-01-054 (Order 91), filed 12/17/84. Statutory Authority: RCW 47.01.101(5).
- 468-87-380 Inspections. [Statutory Authority: RCW 47.01.101(5). 81-10-058 (Order 91), § 468-87-380, filed 5/5/81. Formerly WAC 365-42-380.] Repealed by 85-01-054 (Order 91), filed 12/17/84. Statutory Authority: RCW 47.01.101(5).
- 468-87-390 Reports. [Statutory Authority: RCW 47.01.101(5). 81-10-058 (Order 91), § 468-87-390, filed 5/5/81. Formerly WAC 365-42-390.] Repealed by 85-01-054 (Order 91), filed 12/17/84. Statutory Authority: RCW 47.01.101(5).
- 468-87-410 Insurance. [Statutory Authority: RCW 47.01.101(5). 81-10-058 (Order 91), § 468-87-410, filed 5/5/81. Formerly WAC 365-42-410.] Repealed by 85-01-054 (Order 91), filed 12/17/84. Statutory Authority: RCW 47.01.101(5).
- 468-87-420 Indemnity. [Statutory Authority: RCW 47.01.101(5). 81-10-058 (Order 91), § 468-87-420, filed 5/5/81. Formerly WAC 365-42-420.] Repealed by 85-01-054 (Order 91), filed 12/17/84. Statutory Authority: RCW 47.01.101(5).
- 468-87-430 Risk of loss or damage. [Statutory Authority: RCW 47.01.101(5). 81-10-058 (Order 91), § 468-87-430, filed 5/5/81. Formerly WAC 365-42-430.] Repealed by 85-01-054 (Order 91), filed 12/17/84. Statutory Authority: RCW 47.01.101(5).
- 468-87-440 Disposal of equipment. [Statutory Authority: RCW 47.01.101(5). 81-10-058 (Order 91), § 468-87-440, filed 5/5/81. Formerly WAC 365-42-440.] Repealed by 85-01-054 (Order 91), filed 12/17/84. Statutory Authority: RCW 47.01.101(5).
- 468-87-510 Accounting records. [Statutory Authority: RCW 47.01.101(5). 81-10-058 (Order 91), § 468-87-510, filed 5/5/81. Formerly WAC 365-42-510.] Repealed by 85-01-054 (Order 91), filed 12/17/84. Statutory Authority: RCW 47.01.101(5).

- 468-87-610 Safety. [Statutory Authority: RCW 47.01.101(5), 81-10-058 (Order 91), § 468-87-610, filed 5/5/81. Formerly WAC 365-42-610.] Repealed by 85-01-054 (Order 91), filed 12/17/84. Statutory Authority: RCW 47.01.101(5).
- 468-87-710 Termination. [Statutory Authority: RCW 47.01.101(5), 81-10-058 (Order 91), § 468-87-710, filed 5/5/81. Formerly WAC 365-42-710.] Repealed by 85-01-054 (Order 91), filed 12/17/84. Statutory Authority: RCW 47.01.101(5).

Chapter 468-06 WAC

PUBLIC ACCESS TO INFORMATION AND RECORDS

WAC

468-06-010	Purpose.
468-06-020	Definitions.
468-06-030	Exempted records.
468-06-040	Description of central and field organization of the Washington state department of transportation.
468-06-050	Public records officer.
468-06-060	Public records available.
468-06-070	Requests for public records.
468-06-080	Availability for public inspection and copying of public records—Office hours.
468-06-090	Inspection and copying cost.
468-06-100	Protection of public records.
468-06-110	Denial of request.
468-06-120	Review of denials of public records requests.
468-06-130	Records index.
468-06-140	Indexes.

WAC 468-06-010 Purpose. The purpose of this chapter shall be to ensure compliance by the Washington state department of transportation with the provisions of chapter 1, Laws of 1973 (Initiative 276), and in particular with sections 25 through 32 of that act, dealing with public records.

[Statutory Authority: 1977 ex.s. c 151, 79-01-033 (DOT Order 10 and Comm. Order 1, Resolution No. 13), § 468-06-010, filed 12/20/78. Formerly WAC 252-03-010.]

WAC 468-06-020 Definitions. (1) "Public record" includes any writing containing information relating to the conduct of government or the performance of any governmental or proprietary function prepared, owned, used or retained by any state or local agency regardless of physical form or characteristic.

(2) "Writing" means handwriting, typewriting, printing, photostating, photographing, and every other means of recording any form of communication or representation, including letters, words, pictures, sounds, or symbols, or combination thereof, and all papers, maps, magnetic or paper tapes, photographic films and prints, magnetic or punched cards, discs, drums, and other documents.

(3) "Department" means the Washington state department of transportation.

[Statutory Authority: 1977 ex.s. c 151, 79-01-033 (DOT Order 10 and Comm. Order 1, Resolution No. 13), § 468-06-020, filed 12/20/78. Formerly WAC 252-03-020.]

WAC 468-06-030 Exempted records. The following records shall be exempt from public inspection and copying. For further exemptions, chapter 42.17 RCW and in particular RCW 42.17.310 should be consulted.

[Title 468 WAC—p. 6]

(1) Personal information in files maintained for employees, appointees or elected officials of any public agency to the extent that disclosure would violate their right to privacy.

(2) Specific intelligence information and specific investigative files compiled by investigative, law enforcement and penology agencies, and state agencies vested with the responsibility to discipline members of any profession, the nondisclosure of which is essential to effective law enforcement or for the protection of any person's right to privacy.

(3) Information revealing the identity of persons who are witnesses to or victims of crime or who file complaints with investigative, law enforcement or penology agencies, other than the public disclosure commission, if disclosure would endanger any person's life, physical safety, or property. If at the time the complaint is filed the complainant, victim or witness indicates a desire for disclosure or nondisclosure, such desire shall govern. However, all complaints filed with the public disclosure commission about any elected official or candidate for public office must be made in writing and signed by the complainant under oath.

(4) Test questions, scoring keys, and other examination data used to administer a license, employment or academic examination.

(5) Except as provided by chapter 8.26 RCW, the contents of real estate appraisals, made for or by any agency relative to the acquisition or sale of property, until the project or prospective sale is abandoned or until such time as all of the property has been acquired, or the property to which the sale appraisal relates is sold, but in no event shall disclosure be denied for more than three years after the appraisal.

(6) Valuable formulae, designs, drawings and research data obtained by any agency within five years of the request for disclosure when disclosure would produce private gain and public loss.

(7) Preliminary drafts, notes, recommendations, and intraagency memorandums in which opinions are expressed or policies formulated or recommended except that a specific record shall not be exempt when publicly cited by an agency in connection with any agency action.

(8) Records which are relevant to a controversy to which an agency is a party but which records would not be available to another party under the rules of pretrial discovery for causes pending in the superior courts.

(9) Records, maps, or other information identifying the location of archaeological sites in order to avoid the looting or depredation of such sites.

(10) Any library record, the primary purpose of which is to maintain control of library materials, or to gain access to information, which discloses or could be used to disclose the identity of a library user.

(11) Financial information supplied by or on behalf of a person, firm, or corporation for the purpose of qualifying to submit a bid or proposal for (a) a ferry system construction or repair contract as required by RCW 47.60.680 through 47.60.750 or (b) highway construction or improvement as required by RCW 47.28.070.

(12) All applications for public employment, including the names of applicants, resumes, and other related materials submitted with respect to an applicant.

(13) The residential addresses and residential telephone numbers of employees or volunteers of a public agency which are held by the agency in personnel records, employment or volunteer rosters, or mailing lists of employees or volunteers.

(14) Information that identifies a person who, while an agency employee:

(a) Seeks advice, under an informal process established by the employing agency, in order to ascertain his or her rights in connection with a possible unfair practice under chapter 49.60 RCW against the person; and

(b) Requests his or her identity or any identifying information not be disclosed.

(15) Investigative records compiled by an employing agency conducting a current investigation of a possible unfair practice under chapter 49.60 RCW or of a possible violation of other federal, state, or local laws prohibiting discrimination in employment.

The exemptions of this section shall be inapplicable to the extent that information, the disclosure of which would violate personal privacy or vital governmental interest, can be deleted from the specific records sought. No exemption shall be construed to permit the nondisclosure of statistical information not descriptive of any readily identifiable person or persons.

[Statutory Authority: Chapter 42.17 RCW and RCW 47.01.101. 96-16-004 (Order 163), § 468-06-030, filed 7/24/96, effective 8/24/96. Statutory Authority: RCW 42.17.250 through 42.17.340. 89-17-047 (Order 120), § 468-06-030, filed 8/14/89, effective 9/14/89; 85-23-040 (Order 97), § 468-06-030, filed 11/18/85. Statutory Authority: RCW 42.17.250 through 42.17.350. 81-11-035 (Order 62), § 468-06-030, filed 5/19/81. Statutory Authority: 1977 ex.s. c 151. 79-01-033 (DOT Order 10 and Comm. Order 1, Resolution No. 13), § 468-06-030, filed 12/20/78. Formerly WAC 252-03-025.]

WAC 468-06-040 Description of central and field organization of the Washington state department of transportation. (1) The department of transportation is a statutorily created agency of the state of Washington. The central office of the department of transportation is located in the Transportation Building, Olympia, WA 98504.

(2) The department of transportation is headed by a secretary who is the executive head of the department and is appointed by the Washington state transportation commission.

(a) Serving directly under the secretary are the deputy secretary for operations, deputy secretary for policy, audit office, equal opportunity office and the ombudsman. There are also assistant attorney generals assigned to the department who provide legal services in department matters.

(b) Reporting directly to the deputy secretary for operations are the following offices: Communications and public involvement, governmental liaison office, human resources office and Q2000 office.

(c) The following service centers report to the deputy secretary for operations depending upon their needs: Environmental and engineering, field operations support, finance and administration, planning and programming and transaid. Also reporting to the deputy secretary are the aviation division, transportation economic partnerships division, high-

ways and local roadways division, public transportation and rail division and Washington state ferries.

(d) The department field functions are carried out by six regions which are each headed by a region administrator and report directly to the deputy secretary for operations. The central regional office locations are: Seattle, Wenatchee, Tumwater, Vancouver, Yakima, and Spokane. The regions have various project and maintenance area offices which are headed by a supervisor.

[Statutory Authority: RCW 47.01.101. 99-07-013, § 468-06-040, filed 3/8/99, effective 4/8/99. Statutory Authority: Chapter 42.17 RCW and RCW 47.01.101. 96-16-004 (Order 163), § 468-06-040, filed 7/24/96, effective 8/24/96. Statutory Authority: RCW 42.17.250 through 42.17.340. 89-17-047 (Order 120), § 468-06-040, filed 8/14/89, effective 9/14/89; 85-23-040 (Order 97), § 468-06-040, filed 11/18/85. Statutory Authority: 1977 ex.s. c 151. 79-01-033 (DOT Order 10 and Comm. Order 1, Resolution No. 13), § 468-06-040, filed 12/20/78. Formerly WAC 252-03-030.]

WAC 468-06-050 Public records officer. The department's public records shall be in the charge of the manager, administrative services, who shall be the public records officer for the department. In the absence of the manager, administrative services, the records manager shall serve as the public records officer. The persons so designated shall be located in the transportation building, Olympia, Washington. The public records officer shall be responsible for the following: The implementation of the department's rules and regulations regarding release of public records, coordinating the staff of the department in this regard, and generally insuring compliance by the staff with the public records disclosure requirements of chapter 1, Laws of 1973.

[Statutory Authority: RCW 42.17.250 through 42.17.340. 89-17-047 (Order 120), § 468-06-050, filed 8/14/89, effective 9/14/89. Statutory Authority: RCW 42.17.250 through 42.17.350. 81-11-035 (Order 62), § 468-06-050, filed 5/19/81. Statutory Authority: 1977 ex.s. c 151. 79-01-033 (DOT Order 10 and Comm. Order 1, Resolution No. 13), § 468-06-050, filed 12/20/78. Formerly WAC 252-03-040.]

WAC 468-06-060 Public records available. All public records of the department, as defined in WAC 468-06-020, are deemed to be available for public inspection and copying pursuant to these rules, except as provided in WAC 468-06-030.

[Statutory Authority: 1977 ex.s. c 151. 79-01-033 (DOT Order 10 and Comm. Order 1, Resolution No. 13), § 468-06-060, filed 12/20/78. Formerly WAC 252-03-050.]

WAC 468-06-070 Requests for public records. Subject to the provisions of subsection (3) of this section, and in accordance with the requirements of chapter 1, Laws of 1973, that agencies prevent unreasonable invasions of privacy, protect public records from damage or disorganization, and prevent excessive interference with essential functions of the agency, public records are only obtainable by members of the public when those members of the public comply with the following procedures.

(1)(a) A public record may ordinarily be disclosed upon an oral or written request. Requests will be referred to the public records officer or public disclosure coordinator. All requests shall contain the following information:

- (i) The name of the requester.
- (ii) The date the request was made.

(iii) Public records or information requested.

(iv) Requester's signature (if written request).

(b) The person handling the oral request shall require the requester to submit a written request in the following instances:

(i) Whenever the record requested clearly falls within the statutory exemptions of WAC 468-06-030 or when the exempt status of the record is unclear.

(ii) Whenever an entire file is requested or all records of a general category are requested unless the number of documents involved is less than ten.

(iii) Records pertaining to condemnation actions or other pending litigation to which the department is a party or pertaining to any controversy to which the department is party.

(iv) When the document requested has a notation "legal work product" or "privileged attorney-client communication" or similar notice of privileged material.

(v) Where the oral request is too complicated or too extensive and inconvenient to the department to handle the matter on an oral basis.

(2) Responses to requests for public records shall be made promptly. Within five business days of receiving a public record request, the department will respond by either:

(a) Providing the record;

(b) Acknowledging that the department has received the request and providing a reasonable estimate of the time the department will require to respond to the request; or

(c) Denying the public record request.

Additional time required to respond to a request may be based upon the need to clarify the intent of the request, to locate and assemble the information requested, to notify third persons or offices affected by the request, or to determine whether any of the information requested is exempt and that a denial should be made as to all or part of the request. In acknowledging receipt of a public record request that is unclear, the department may ask the requester to clarify what information the requester is seeking. If the requester fails to clarify the request, the department need not respond to it.

(3) The public records officer or person handling the request shall inform the member of the public making the request whether or not the requested record is available for inspection or copying at a region office or at the transportation building in Olympia, Washington.

(4) The records requested are not to be used to compile a commercial sales list.

(5) When it appears that a request for a record is made by or on behalf of a party to a lawsuit or a controversy to which the department is also a party (or when such a request is made by or on behalf of an attorney for such a party) the request shall be referred to the assistant attorney general assigned to the department for appropriate response.

[Statutory Authority: Chapter 42.17 RCW and RCW 47.01.101. 96-16-004 (Order 163), § 468-06-070, filed 7/24/96, effective 8/24/96. Statutory Authority: RCW 42.17.250 through 42.17.340. 85-23-040 (Order 97), § 468-06-070, filed 11/18/85. Statutory Authority: RCW 42.17.250 through 42.17.350. 81-11-035 (Order 62), § 468-06-070, filed 5/19/81. Statutory Authority: 1977 ex.s. c 151. 79-01-033 (DOT Order 10 and Comm. Order 1, Resolution No. 13), § 468-06-070, filed 12/20/78. Formerly WAC 252-03-060 and 252-03-990.]

WAC 468-06-080 Availability for public inspection and copying of public records—Office hours. Public records shall be available for inspection and copying during the customary office hours of the department of transportation. For the purposes of this chapter, the customary office hours shall be from 8 a.m. to noon and from 1 p.m. to 5 p.m., Monday through Friday, excluding legal holidays.

[Statutory Authority: 1977 ex.s. c 151. 79-01-033 (DOT Order 10 and Comm. Order 1, Resolution No. 13), § 468-06-080, filed 12/20/78. Formerly WAC 252-03-070.]

WAC 468-06-090 Inspection and copying cost. (1) No fee shall be charged for inspection of public records.

(2) The department of transportation shall impose a reasonable charge for providing copies of public records and for the use by any person of agency equipment to copy records; such charges shall not exceed the amount necessary to reimburse the department for its actual costs incident to such copying.

[Statutory Authority: Chapter 42.17 RCW and RCW 47.01.101. 96-16-004 (Order 163), § 468-06-090, filed 7/24/96, effective 8/24/96. Statutory Authority: 1977 ex.s. c 151. 79-01-033 (DOT Order 10 and Comm. Order 1, Resolution No. 13), § 468-06-090, filed 12/20/78. Formerly WAC 252-03-080.]

WAC 468-06-100 Protection of public records. In order to implement the provisions of section 29, chapter 1, Laws of 1973, requiring agencies to enact reasonable rules to protect public records from damage or disorganization, the following rules have been adopted.

(1) Copying of public documents shall be done by department personnel and under the supervision of said personnel, upon the request of members of the public under the procedures set down in WAC 468-06-070.

(2) No document shall be physically removed by a member of the public from the area designated by the department for the public inspection of documents for any reason whatever.

(3) When a member of the public requests to examine an entire file or group of documents, as distinguished from a request to examine certain individual documents which can be identified and supplied by themselves, the department shall be allowed a reasonable time to inspect the file to determine whether information protected from disclosure by section 31, chapter 1, Laws of 1973, is contained therein, and the department shall not be deemed in violation of its obligation to reply promptly to requests for public documents by reason of causing such an inspection to be performed.

[Statutory Authority: 1977 ex.s. c 151. 79-01-033 (DOT Order 10 and Comm. Order 1, Resolution No. 13), § 468-06-100, filed 12/20/78. Formerly WAC 252-03-090.]

WAC 468-06-110 Denial of request. Each denial of a request for a public record shall be accompanied by a written statement to the requestor clearly specifying the reasons for the denial, including a statement of the specific exemption authorizing the withholding of the record and a brief explanation of how the exemption applies to the record withheld. Such statement shall be sufficiently clear and complete to permit the secretary of transportation or designee to review the denial in accordance with WAC 468-06-120.

[Statutory Authority: RCW 42.17.250 through 42.17.340, 85-23-040 (Order 97), § 468-06-110, filed 11/18/85. Statutory Authority: 1977 ex.s. c 151. 79-01-033 (DOT Order 10 and Comm. Order 1, Resolution No. 13), § 468-06-110, filed 12/20/78. Formerly WAC 252-03-100.]

WAC 468-06-120 Review of denials of public records requests. (1) Any person who objects to the denial of a request for a public record may petition the public records officer for prompt review of such decision by tendering a written request for review. The written request shall specifically refer to the written statement by the public records officer or other staff member which constituted or accompanied the denial.

(2) After receiving a written request for review of a decision denying a public record, if the public records officer determines to affirm the denial, then the written request shall immediately be referred to the assistant attorney general assigned to the department. The assistant attorney general shall promptly consider the matter and either affirm or reverse such denial. In any case, the request shall be returned with a final decision, within two business days following the original denial.

(3) Administrative remedies shall not be considered exhausted until the public records officer has returned the petition with a decision or until the close of the second business day following denial of inspection, whichever first occurs.

[Statutory Authority: 1977 ex.s. c 151. 79-01-033 (DOT Order 10 and Comm. Order 1, Resolution No. 13), § 468-06-120, filed 12/20/78. Formerly WAC 252-03-110.]

WAC 468-06-130 Records index. (1) The department finds that it would be unduly burdensome and would interfere with agency operations to maintain an index of records as specified in RCW 42.17.260(3) because of the complexity and diversity of its operations and the resulting volume of manuals, correspondence, reports, surveys, staff studies and other materials.

(2) The department will make available for public disclosure all indices which may at a future time be developed for agency use.

[Statutory Authority: RCW 42.17.250 through 42.17.350, 81-11-035 (Order 62), § 468-06-130, filed 5/19/81. Statutory Authority: 1977 ex.s. c 151. 79-01-033 (DOT Order 10 and Comm. Order 1, Resolution No. 13), § 468-06-130, filed 12/20/78. Formerly WAC 252-03-120.]

WAC 468-06-140 Indexes. (1) A system of indexing for identification and location of the following records is hereby established by the department. Such records shall include the following:

(a) Final orders entered after June 30, 1990, issued in adjudicative proceedings as defined in RCW 34.05.010(1) that contain an analysis or decision of substantial importance to the agency in carrying out its duties.

(b) Declaratory orders entered after June 30, 1990, that contain an analysis or decision of substantial importance to the agency in carrying out its duties.

(c) Interpretive statements as defined in RCW 34.05.010(8).

(d) Policy statements entered after June 30, 1990, as defined in RCW 34.05.010(14).

(2001 Ed.)

(2) A system of indexing shall be as follows:

(a) The indexing system will be administered by the department's rules coordinator and located in the transportation building in Olympia, Washington.

(b) Copies of all indexes shall be available for public inspection and copying in the manner provided for the inspection and copying of public records.

(c) The rules coordinator shall establish and maintain a separate index for each item contained in subsections (1)(a) through (d) of this section as follows:

(i) The index shall list all final orders and declaratory orders selected by the department that contain decisions of substantial importance to the agency which orders shall be listed alphabetically by the titles of the hearing or controversy and shall contain a phrase describing the issue or issues and relevant citations of law.

(ii) Interpretative statements and policy statements shall be indexed by the applicable program administered by the department.

(d) The rules coordinator shall update all indexes at least once a year and shall revise such indexes when deemed necessary by the department.

[Statutory Authority: Chapter 34.05 RCW, 90-23-007, § 468-06-140, filed 11/9/90, effective 12/10/90.]

Chapter 468-10 WAC

PRACTICE AND PROCEDURE

WAC

468-10-400	Application of this chapter.
468-10-410	Adoption of model rules of procedures.
468-10-420	Definitions.
468-10-430	Application for adjudicative proceeding.
468-10-440	Standards of ethical conduct.
468-10-450	Appearance and practice—Appearance and/or representation by former employee, attorney or officer.
468-10-460	Answer.
468-10-470	Discovery, protective orders.
468-10-480	Excerpts from documentary evidence.
468-10-490	Motions before presiding officers.
468-10-500	Prehearing conference.
468-10-510	Evidence.
468-10-520	Petitions for review of initial orders—Final orders.
468-10-530	Brief adjudicative proceedings.

DISPOSITION OF SECTIONS FORMERLY CODIFIED IN THIS CHAPTER

468-10-010	Appearance and practice before commission or secretary—Who may appear. [Statutory Authority: 1977 ex.s. c 151. 79-01-033 (DOT Order 10 and Comm. Order 1, Resolution No. 13), § 468-10-010, filed 12/20/78. Formerly WAC 252-08-010.] Repealed by 94-14-101 (Order 145), filed 7/6/94, effective 8/6/94. Statutory Authority: Chapter 34.05 RCW and RCW 47.01.101(5).
468-10-020	Appearance and practice before commission or secretary—Solicitation of business unethical. [Statutory Authority: 1977 ex.s. c 151. 79-01-033 (DOT Order 10 and Comm. Order 1, Resolution No. 13), § 468-10-020, filed 12/20/78. Formerly WAC 252-08-030.] Repealed by 94-14-101 (Order 145), filed 7/6/94, effective 8/6/94. Statutory Authority: Chapter 34.05 RCW and RCW 47.01.101(5).
468-10-030	Appearance and practice before commission or secretary—Standards of ethical conduct. [Statutory Authority: 1977 ex.s. c 151. 79-01-033 (DOT Order 10 and Comm. Order 1, Resolution No. 13), § 468-10-030, filed 12/20/78. Formerly WAC 252-08-040.] Repealed by 94-14-101 (Order 145), filed 7/6/94, effective 8/6/94. Statutory Authority: Chapter 34.05 RCW and RCW 47.01.101(5).

- 468-10-040 Appearance and practice before commission or secretary—Appearance and/or representation by former employee, attorney, or officer. [Statutory Authority: 1977 ex.s. c 151. 79-01-033 (DOT Order 10 and Comm. Order 1, Resolution No. 13), § 468-10-040, filed 12/20/78. Formerly WAC 252-08-050.] Repealed by 94-14-101 (Order 145), filed 7/6/94, effective 8/6/94. Statutory Authority: Chapter 34.05 RCW and RCW 47.01.101(5).
- 468-10-050 Computation of time. [Statutory Authority: 1977 ex.s. c 151. 79-01-033 (DOT Order 10 and Comm. Order 1, Resolution No. 13), § 468-10-050, filed 12/20/78. Formerly WAC 252-08-070.] Repealed by 94-14-101 (Order 145), filed 7/6/94, effective 8/6/94. Statutory Authority: Chapter 34.05 RCW and RCW 47.01.101(5).
- 468-10-060 Order in presenting evidence—Franchise applications. [Statutory Authority: 1977 ex.s. c 151. 79-01-033 (DOT Order 10 and Comm. Order 1, Resolution No. 13), § 468-10-060, filed 12/20/78. Formerly WAC 252-08-265.] Repealed by 94-14-101 (Order 145), filed 7/6/94, effective 8/6/94. Statutory Authority: Chapter 34.05 RCW and RCW 47.01.101(5).
- 468-10-070 Official notice—Matters of law. [Statutory Authority: 1977 ex.s. c 151. 79-01-033 (DOT Order 10 and Comm. Order 1, Resolution No. 13), § 468-10-070, filed 12/20/78. Formerly WAC 252-08-370.] Repealed by 94-14-101 (Order 145), filed 7/6/94, effective 8/6/94. Statutory Authority: Chapter 34.05 RCW and RCW 47.01.101(5).
- 468-10-080 Official notice—Material facts. [Statutory Authority: 1977 ex.s. c 151. 79-01-033 (DOT Order 10 and Comm. Order 1, Resolution No. 13), § 468-10-080, filed 12/20/78. Formerly WAC 252-08-380.] Repealed by 94-14-101 (Order 145), filed 7/6/94, effective 8/6/94. Statutory Authority: Chapter 34.05 RCW and RCW 47.01.101(5).
- 468-10-090 Stipulations and admissions of record. [Statutory Authority: 1977 ex.s. c 151. 79-01-033 (DOT Order 10 and Comm. Order 1, Resolution No. 13), § 468-10-090, filed 12/20/78. Formerly WAC 252-08-400.] Repealed by 94-14-101 (Order 145), filed 7/6/94, effective 8/6/94. Statutory Authority: Chapter 34.05 RCW and RCW 47.01.101(5).
- 468-10-100 Form and content of decisions in contested cases. [Statutory Authority: 1977 ex.s. c 151. 79-01-033 (DOT Order 10 and Comm. Order 1, Resolution No. 13), § 468-10-100, filed 12/20/78. Formerly WAC 252-08-410.] Repealed by 94-14-101 (Order 145), filed 7/6/94, effective 8/6/94. Statutory Authority: Chapter 34.05 RCW and RCW 47.01.101(5).
- 468-10-110 Definition of issues before hearing. [Statutory Authority: 1977 ex.s. c 151. 79-01-033 (DOT Order 10 and Comm. Order 1, Resolution No. 13), § 468-10-110, filed 12/20/78. Formerly WAC 252-08-420.] Repealed by 94-14-101 (Order 145), filed 7/6/94, effective 8/6/94. Statutory Authority: Chapter 34.05 RCW and RCW 47.01.101(5).
- 468-10-120 Prehearing conference rule—Authorized. [Statutory Authority: 1977 ex.s. c 151. 79-01-033 (DOT Order 10 and Comm. Order 1, Resolution No. 13), § 468-10-120, filed 12/20/78. Formerly WAC 252-08-430.] Repealed by 94-14-101 (Order 145), filed 7/6/94, effective 8/6/94. Statutory Authority: Chapter 34.05 RCW and RCW 47.01.101(5).
- 468-10-130 Prehearing conference rule—Record of conference action. [Statutory Authority: 1977 ex.s. c 151. 79-01-033 (DOT Order 10 and Comm. Order 1, Resolution No. 13), § 468-10-130, filed 12/20/78. Formerly WAC 252-08-440.] Repealed by 94-14-101 (Order 145), filed 7/6/94, effective 8/6/94. Statutory Authority: Chapter 34.05 RCW and RCW 47.01.101(5).
- 468-10-140 Submission of documentary evidence in advance. [Statutory Authority: 1977 ex.s. c 151. 79-01-033 (DOT Order 10 and Comm. Order 1, Resolution No. 13), § 468-10-140, filed 12/20/78. Formerly WAC 252-08-450.] Repealed by 94-14-101 (Order 145), filed 7/6/94, effective 8/6/94. Statutory Authority: Chapter 34.05 RCW and RCW 47.01.101(5).
- 468-10-150 Excerpts from documentary evidence. [Statutory Authority: 1977 ex.s. c 151. 79-01-033 (DOT Order 10 and Comm. Order 1, Resolution No. 13), § 468-10-150, filed 12/20/78. Formerly WAC 252-08-460.] Repealed by 94-14-101 (Order 145), filed 7/6/94, effective 8/6/94.
- 468-10-160 Statutory Authority: Chapter 34.05 RCW and RCW 47.01.101(5).
Expert or opinion testimony and testimony based on economic and statistical data—Number and qualifications of witnesses. [Statutory Authority: 1977 ex.s. c 151. 79-01-033 (DOT Order 10 and Comm. Order 1, Resolution No. 13), § 468-10-160, filed 12/20/78. Formerly WAC 252-08-470.] Repealed by 94-14-101 (Order 145), filed 7/6/94, effective 8/6/94. Statutory Authority: Chapter 34.05 RCW and RCW 47.01.101(5).
- 468-10-170 Expert or opinion testimony and testimony based on economic and statistical data—Written sworn statements. [Statutory Authority: 1977 ex.s. c 151. 79-01-033 (DOT Order 10 and Comm. Order 1, Resolution No. 13), § 468-10-170, filed 12/20/78. Formerly WAC 252-08-480.] Repealed by 94-14-101 (Order 145), filed 7/6/94, effective 8/6/94. Statutory Authority: Chapter 34.05 RCW and RCW 47.01.101(5).
- 468-10-180 Expert or opinion testimony and testimony based on economic and statistical data—Supporting data. [Statutory Authority: 1977 ex.s. c 151. 79-01-033 (DOT Order 10 and Comm. Order 1, Resolution No. 13), § 468-10-180, filed 12/20/78. Formerly WAC 252-08-490.] Repealed by 94-14-101 (Order 145), filed 7/6/94, effective 8/6/94. Statutory Authority: Chapter 34.05 RCW and RCW 47.01.101(5).
- 468-10-190 Expert or opinion testimony and testimony based on economic and statistical data—Effect of noncompliance with WAC 468-10-160 or 468-10-170. [Statutory Authority: 1977 ex.s. c 151. 79-01-033 (DOT Order 10 and Comm. Order 1, Resolution No. 13), § 468-10-190, filed 12/20/78. Formerly WAC 252-08-500.] Repealed by 94-14-101 (Order 145), filed 7/6/94, effective 8/6/94. Statutory Authority: Chapter 34.05 RCW and RCW 47.01.101(5).
- 468-10-200 Continuances. [Statutory Authority: 1977 ex.s. c 151. 79-01-033 (DOT Order 10 and Comm. Order 1, Resolution No. 13), § 468-10-200, filed 12/20/78. Formerly WAC 252-08-510.] Repealed by 94-14-101 (Order 145), filed 7/6/94, effective 8/6/94. Statutory Authority: Chapter 34.05 RCW and RCW 47.01.101(5).
- 468-10-210 Rules of evidence—Admissibility criteria. [Statutory Authority: 1977 ex.s. c 151. 79-01-033 (DOT Order 10 and Comm. Order 1, Resolution No. 13), § 468-10-210, filed 12/20/78. Formerly WAC 252-08-520.] Repealed by 94-14-101 (Order 145), filed 7/6/94, effective 8/6/94. Statutory Authority: Chapter 34.05 RCW and RCW 47.01.101(5).
- 468-10-220 Rules of evidence—Tentative admission—Exclusion—Discontinuance—Objections. [Statutory Authority: 1977 ex.s. c 151. 79-01-033 (DOT Order 10 and Comm. Order 1, Resolution No. 13), § 468-10-220, filed 12/20/78. Formerly WAC 252-08-530.] Repealed by 94-14-101 (Order 145), filed 7/6/94, effective 8/6/94. Statutory Authority: Chapter 34.05 RCW and RCW 47.01.101(5).
- 468-10-230 Briefs. [Statutory Authority: 1977 ex.s. c 151. 79-01-033 (DOT Order 10 and Comm. Order 1, Resolution No. 13), § 468-10-230, filed 12/20/78. Formerly WAC 252-08-535.] Repealed by 94-14-101 (Order 145), filed 7/6/94, effective 8/6/94. Statutory Authority: Chapter 34.05 RCW and RCW 47.01.101(5).
- 468-10-232 Answer. [Statutory Authority: RCW 34.04.020 and 34.04.022. 83-19-016 (Order 86), § 468-10-232, filed 9/12/83.] Repealed by 94-14-101 (Order 145), filed 7/6/94, effective 8/6/94. Statutory Authority: Chapter 34.05 RCW and RCW 47.01.101(5).
- 468-10-234 Agency action following preparation of proposed decision. [Statutory Authority: RCW 34.04.020 and 34.04.022. 83-19-016 (Order 86), § 468-10-234, filed 9/12/83.] Repealed by 94-14-101 (Order 145), filed 7/6/94, effective 8/6/94. Statutory Authority: Chapter 34.05 RCW and RCW 47.01.101(5).
- 468-10-240 Petitions for rule making, amendment, or repeal—Who may petition. [Statutory Authority: 1977 ex.s. c 151. 79-01-033 (DOT Order 10 and Comm. Order 1, Resolution No. 13), § 468-10-240, filed 12/20/78. Formerly WAC 252-08-540.] Repealed by 94-14-101 (Order 145), filed 7/6/94, effective 8/6/94. Statutory Authority: Chapter 34.05 RCW and RCW 47.01.101(5).
- 468-10-250 Petitions for rule making, amendment, or repeal—Requirements. [Statutory Authority: 1977 ex.s. c 151. 79-01-033 (DOT Order 10 and Comm. Order 1, Resolution No.

- 13), § 468-10-250, filed 12/20/78. Formerly WAC 252-08-550.] Repealed by 94-14-101 (Order 145), filed 7/6/94, effective 8/6/94. Statutory Authority: Chapter 34.05 RCW and RCW 47.01.101(5).
- 468-10-260 Petitions for rule making, amendment, or repeal—Agency must consider. [Statutory Authority: 1977 ex.s. c 151. 79-01-033 (DOT Order 10 and Comm. Order 1, Resolution No. 13), § 468-10-260, filed 12/20/78. Formerly WAC 252-08-560.] Repealed by 94-14-101 (Order 145), filed 7/6/94, effective 8/6/94. Statutory Authority: Chapter 34.05 RCW and RCW 47.01.101(5).
- 468-10-270 Petitions for rule making, amendment, or repeal—Notice of disposition. [Statutory Authority: 1977 ex.s. c 151. 79-01-033 (DOT Order 10 and Comm. Order 1, Resolution No. 13), § 468-10-270, filed 12/20/78. Formerly WAC 252-08-570.] Repealed by 94-14-101 (Order 145), filed 7/6/94, effective 8/6/94. Statutory Authority: Chapter 34.05 RCW and RCW 47.01.101(5).
- 468-10-280 Petitions for rule making, amendment, or repeal—Form. [Statutory Authority: 1977 ex.s. c 151. 79-01-033 (DOT Order 10 and Comm. Order 1, Resolution No. 13), § 468-10-280, filed 12/20/78. Formerly WAC 252-08-575.] Repealed by 94-14-101 (Order 145), filed 7/6/94, effective 8/6/94. Statutory Authority: Chapter 34.05 RCW and RCW 47.01.101(5).
- 468-10-290 Declaratory rulings—Who may petition—Action of commission or secretary. [Statutory Authority: 1977 ex.s. c 151. 79-01-033 (DOT Order 10 and Comm. Order 1, Resolution No. 13), § 468-10-290, filed 12/20/78. Formerly WAC 252-08-580.] Repealed by 94-14-101 (Order 145), filed 7/6/94, effective 8/6/94. Statutory Authority: Chapter 34.05 RCW and RCW 47.01.101(5).
- 468-10-300 Forms. [Statutory Authority: 1977 ex.s. c 151. 79-01-033 (DOT Order 10 and Comm. Order 1, Resolution No. 13), § 468-10-300, filed 12/20/78. Formerly WAC 252-08-590.] Repealed by 94-14-101 (Order 145), filed 7/6/94, effective 8/6/94. Statutory Authority: Chapter 34.05 RCW and RCW 47.01.101(5).
- 468-10-310 Stay of final decision. [Statutory Authority: 1977 ex.s. c 151. 79-01-033 (DOT Order 10 and Comm. Order 1, Resolution No. 13), § 468-10-310, filed 12/20/78. Formerly WAC 252-08-595.] Repealed by 94-14-101 (Order 145), filed 7/6/94, effective 8/6/94. Statutory Authority: Chapter 34.05 RCW and RCW 47.01.101(5).
- 468-10-320 Consideration of economic costs and impacts in rule making. [Statutory Authority: 1977 ex.s. c 151. 79-01-033 (DOT Order 10 and Comm. Order 1, Resolution No. 13), § 468-10-320, filed 12/20/78. Formerly WAC 252-08-600.] Repealed by 94-14-101 (Order 145), filed 7/6/94, effective 8/6/94. Statutory Authority: Chapter 34.05 RCW and RCW 47.01.101(5).

WAC 468-10-400 Application of this chapter. This chapter applies to all adjudicative proceedings under the jurisdiction of the department of transportation or the secretary of the department of transportation: Provided, That the rules shall not apply to appeals under RCW 47.28.070 and joint hearings under RCW 47.68.290.

[Statutory Authority: Chapter 34.05 RCW and RCW 47.01.101(5). 94-14-101 (Order 145), § 468-10-400, filed 7/6/94, effective 8/6/94.]

WAC 468-10-410 Adoption of model rules of procedures. Except as they may be inconsistent with the rules in this chapter, the department of transportation adopts the model rules of procedures as set forth in chapter 10-08 WAC. Where the rules of this chapter conflict with those of chapter 10-08 WAC, the rules of this chapter shall govern. Where the rules of this chapter conflict with chapter 468-100 WAC, the rules of chapter 468-100 WAC shall govern. Where the rules of chapter 468-100 WAC conflict with chapter 10-08 WAC, the rules of chapter 468-100 WAC shall govern.

(2001 Ed.)

[Statutory Authority: Chapter 34.05 RCW and RCW 47.01.101(5). 94-14-101 (Order 145), § 468-10-410, filed 7/6/94, effective 8/6/94.]

WAC 468-10-420 Definitions. The definitions set forth in this section shall apply throughout this chapter unless the context otherwise requires:

"Department" means the Washington state department of transportation.

"Secretary" means the secretary of the Washington state department of transportation.

Where the rules of this chapter use words defined in RCW 34.05.010, those definitions shall govern.

[Statutory Authority: Chapter 34.05 RCW and RCW 47.01.101(5). 94-14-101 (Order 145), § 468-10-420, filed 7/6/94, effective 8/6/94.]

WAC 468-10-430 Application for adjudicative proceeding. (1) An application for an adjudicative proceeding must be filed in writing within thirty days of the action that is the subject of the appeal.

(2) An application for an adjudicative proceeding shall specify the issue or issues to be adjudicated in the proceeding and must be signed by the applicant or the applicant's representative. The signature of an applicant or the applicant's representative constitutes a certificate by the applicant or applicant's representative that the applicant or applicant's representative has read the application; that to the best of the applicant's or applicant's representative's knowledge, information, and belief, formed after reasonable inquiry it is well grounded in fact and is warranted by existing law or a good faith argument for the extension, modification, or reversal of existing law, and that it is not interposed for any improper purpose, such as to harass or to cause unnecessary delay or needless increase in the cost of adjudication. If an application is not signed, it shall be stricken unless it is signed promptly after the omission is called to the attention of the applicant or applicant's representative. If an application is signed in violation of this rule, the presiding officer, upon motion or upon its own initiative, may impose upon the person who signed it, a representative party, or both, an appropriate sanction, which may include dismissal of the case.

(3) An application for an adjudicative proceeding shall be served by certified mail, registered mail, or personal service on the Office of the Secretary of the Washington State Department of Transportation, 3D25 Transportation Building, Olympia, WA 98504-7316. Service by electronic telefacsimile transmission is not allowed.

[Statutory Authority: Chapter 34.05 RCW and RCW 47.01.101(5). 94-14-101 (Order 145), § 468-10-430, filed 7/6/94, effective 8/6/94.]

WAC 468-10-440 Standards of ethical conduct. All persons appearing in an adjudicative proceeding shall conform to the standards of ethical conduct required of attorneys before the courts of Washington as required by the rules of professional conduct. If any such person does not conform to such standards, the presiding officer may decline to permit such person to appear in a representative capacity in the adjudicative proceeding.

[Statutory Authority: Chapter 34.05 RCW and RCW 47.01.101(5). 94-14-101 (Order 145), § 468-10-440, filed 7/6/94, effective 8/6/94.]

WAC 468-10-450 Appearance and practice—Appearance and/or representation by former employee, attorney or officer. (1) No person who has served as an officer, attorney, or employee of the department shall appear in an adjudicative proceeding or receive compensation for any services rendered on behalf of any person, firm, corporation, or association in relation to any adjudicative proceeding or application with respect to which such person was directly concerned and in which one personally participated during the period of her or his service or employment.

(2) No person who has served as an officer, attorney, or employee of the department shall appear, except with the permission of the secretary, as an expert witness on behalf of any party, other than the department, in an adjudicative proceeding in which she or he previously took an active part in the matter as a representative of the department.

[Statutory Authority: Chapter 34.05 RCW and RCW 47.01.101(5). 94-14-101 (Order 145), § 468-10-450, filed 7/6/94, effective 8/6/94.]

WAC 468-10-460 Answer. (1) When the department serves a party with a notice of hearing pursuant to RCW 34.05.413(5), the party shall file an answer stating in short plain terms his/her response or defense to the matters asserted in the notice, and shall admit or deny averments in the notice (other than statements of time, place, and nature of the proceeding). If the party is without knowledge or information to form a belief as to the truth of an averment, the party shall so state and this will have the effect of a denial. When a party intends in good faith to deny any part or qualification of an averment, she/he shall specify so much of it as is true and material and shall deny the remainder. A party may make the denials as specific denials of designated averments or paragraphs, or may generally deny all averments except those expressly admitted.

(2) In his/her answer to the notice, a party shall set forth affirmatively any matter constituting an avoidance or affirmative defense. Defenses not pleaded in the answer are waived.

(3) An answer shall be filed within twenty days after the notice of hearing is served unless the date of hearing is less than forty days from the date the notice of hearing is served in which event an answer must be filed within half the intervening time.

(4) Any defense that the hearing cannot be held because the party served with the notice has been prejudiced because of some irregularity in procedure must be pleaded in the answer by specific averment which shall include such supporting particulars as are within the answering party's knowledge or could have reasonably been learned by the answering party.

(5) No reply to an answer shall be filed. Affirmative averments in the answer shall be deemed denied or avoided.

[Statutory Authority: Chapter 34.05 RCW and RCW 47.01.101(5). 94-14-101 (Order 145), § 468-10-460, filed 7/6/94, effective 8/6/94.]

WAC 468-10-470 Discovery, protective orders. Discovery will be available in adjudicative proceedings only as follows:

(1) **Methods:** Any party to an adjudicative proceeding may only obtain discovery from another party by written

interrogatories, subpoenas duces tecum, and written requests for production of documents. The procedures regarding these methods of discovery are found at CR 33 and CR 34 as now or hereafter amended unless inconsistent with the rules herein.

(2) **Scope of discovery:** Parties may obtain discovery to the extent authorized by CR 26(b).

(3) **Protective order:** Any party may file a motion for protective order regarding discovery. Rulings on such motions shall be made by the presiding officer.

(4) **Order compelling discovery:** The presiding officer is authorized to make any order that a court could make under CR 37(a), including an order awarding expenses of the motion to compel discovery.

(5) **Completion of discovery:** All discovery allowed under this section must be completed at a reasonable time prior to hearing as determined by the presiding officer in a discovery schedule. Nothing herein stated shall modify a party's responsibility to promptly supplement responses to discovery rules or otherwise comply with discovery.

(6) **Use at hearing:** Information and documents obtained pursuant to discovery will not become part of the record until received into evidence by the presiding officer upon the motion of any party.

[Statutory Authority: Chapter 34.05 RCW and RCW 47.01.101(5). 94-14-101 (Order 145), § 468-10-470, filed 7/6/94, effective 8/6/94.]

WAC 468-10-480 Excerpts from documentary evidence. When portions only of a document are to be relied upon, the offering party shall prepare the pertinent excerpts, adequately identified, and shall supply copies of such excerpts, together with a statement indicating the purpose for which such material will be offered, to the presiding officer and to the other parties. Only the excerpts, so prepared and submitted, shall be received in the record. However, the whole of the original document shall be made available for examination and for use by all parties to the proceeding.

[Statutory Authority: Chapter 34.05 RCW and RCW 47.01.101(5). 94-14-101 (Order 145), § 468-10-480, filed 7/6/94, effective 8/6/94.]

WAC 468-10-490 Motions before presiding officers.

(1) **Scope of section:** This section governs all motions made to the presiding officer except those made orally on the record during an adjudicative proceeding.

(2) **Form:** A motion must be in writing. It must state the order of relief requested and the grounds for the motion. It may be accompanied by affidavits. It must be supported by legal authorities, set out in the motion or in a supporting brief.

(3) **Response:** Any party may serve and file a response within five days after the motion has been served on that party.

(4) **Filing:** The original and one copy of every motion and response, with supporting papers, must be filed with the presiding officer, along with proof of service.

(5) **Ruling:** When the presiding officer has received a response from all parties, or five days have elapsed since the last party was served, the presiding officer shall rule on the motion without oral argument, unless the presiding officer, in his or her discretion, orders that argument be heard.

[Statutory Authority: Chapter 34.05 RCW and RCW 47.01.101(5). 94-14-101 (Order 145), § 468-10-490, filed 7/6/94, effective 8/6/94.]

WAC 468-10-500 Prehearing conference. (1) **Conference:** The presiding officer, as a matter of discretion, with or without a motion from a party, may direct the applicant or applicant's representative to appear before the presiding officer for a conference to consider:

- (a) The definition and simplification of issues;
- (b) The necessity or desirability of amendments to the pleadings;
- (c) The possibility of obtaining admissions of fact and of documents which will be premarked for admission into evidence in order to avoid unnecessary proof;
- (d) The limitations of the number of expert witnesses;
- (e) Briefing schedules;
- (f) Other matters that may aid in the disposition of the proceeding.

(2) **Order:** The presiding officer shall make a written order that recites the action taken at the conference, the amendments allowed to the pleadings, and the agreements made by the parties as to any of the matters considered, and which limits the issues for hearing to those not disposed of by admissions of counsel/party. The order when served and filed controls the subsequent course of the case, unless it is modified at the hearing to prevent manifest injustice.

[Statutory Authority: Chapter 34.05 RCW and RCW 47.01.101(5). 94-14-101 (Order 145), § 468-10-500, filed 7/6/94, effective 8/6/94.]

WAC 468-10-510 Evidence. (1) **General rules on admissibility:** Presiding officers shall admit and give probative value to evidence that is admissible in the superior courts of the state of Washington in a trial. In addition, a presiding officer may admit and give probative effect to other evidence on which reasonably prudent persons are accustomed to rely in the conduct of their affairs. Presiding officers shall give effect to the rules of privileges recognized in the courts of this state. Presiding officers may exclude irrelevant, immaterial, and duly repetitious evidence.

(2) **Stipulations encouraged:** Counsel/parties are requested to mark proposed exhibits in advance of hearing and to stipulate to the admission of all exhibits that are not objectionable.

(3) **Copies of documents and exhibits:** Unless excused from doing so by the presiding officer, a party offering a document or other exhibit in evidence must furnish copies to all other parties.

(4) **Official notice:** The presiding officer may take notice of judicially cognizable facts, and in addition may take notice of general, technical, or scientific facts within his or her specialized knowledge. Any party may, by motion, ask the presiding officer to take official notice of facts or material. When the presiding officer takes official notice of any facts or material, the presiding officer must notify the parties of what is noticed and afford them reasonable opportunity to contest the noticed facts or material. This may be done at any time before the presiding officer's order becomes final.

[Statutory Authority: Chapter 34.05 RCW and RCW 47.01.101(5). 94-14-101 (Order 145), § 468-10-510, filed 7/6/94, effective 8/6/94.]

(2001 Ed.)

WAC 468-10-520 Petitions for review of initial orders—Final orders. (1) Except in brief adjudicative proceedings, initial orders in all adjudicative proceedings before the department will become final without further action by the department unless, within twenty days of the date of service of the initial order, a petition for review is filed with the person named and the address stated in the initial order for such petition of review.

(2) The provisions of WAC 10-08-211 apply to petitions for review of initial orders.

(3) WAC 468-10-530 governs review of orders in brief adjudicative proceedings.

[Statutory Authority: Chapter 34.05 RCW and RCW 47.01.101(5). 94-14-101 (Order 145), § 468-10-520, filed 7/6/94, effective 8/6/94.]

WAC 468-10-530 Brief adjudicative proceedings. (1) Pursuant to RCW 34.05.482, the department will use brief adjudicative proceedings where not violative of law and where protection of the public interest does not require the department to give notice and an opportunity to participate to persons other than the parties. The department may use brief adjudicative proceedings for the following matters:

(a) Actions taken by the department with respect to motorist information sign permit applications and revocations under WAC 468-70-070.

(b) Actions taken by the department with respect to hazardous structures or obstacles that obstruct the air space above ground or water level under RCW 47.68.340 and 47.68.350.

(c) Actions taken by the department after the state patrol has confiscated an overweight permit or overlength permit and the department has suspended or revoked the permit under RCW 46.44.105(9).

(d) Actions taken by the department with respect to its motor carrier service office's permit refund policy.

(2) For matters listed in subsection (1) of this section, the department's notice of action shall provide the name and address of the appropriate office at which an application for a brief adjudicative proceeding must be filed. An application for a brief adjudicative proceeding shall be served on the department by certified mail, registered mail, or personal service.

(3) An application for a brief adjudicative proceeding must be filed within twenty days from the date of service of the department's notice of action. Such application shall contain a written explanation of the party's view of the matter and may be supported by affidavits. Other parties may file a written response, including supporting affidavits, within ten days after receipt of the application for a brief adjudicative proceeding. Copies of the response shall be served on all parties.

(4) Brief adjudicative proceedings shall be conducted by a presiding officer for brief adjudicative proceedings designated by the secretary. The presiding officer shall have agency expertise in the subject matter but shall not have personally participated in the decision to issue the initiating document.

(5) The presiding officer may, in his or her discretion, entertain oral argument from the parties or their representatives, at a time and place designated by the presiding officer.

(6) No witnesses may appear to testify.

(7) In addition to the record, the presiding officer may employ agency expertise as a basis for decision.

(8) If the party is present at the time any unfavorable action is taken, the presiding officer shall make a brief oral statement of the reasons for the decision. The decision on an application shall be expressed in a written order which shall be served upon all parties within ten days after entry.

(9) The presiding officer's written decision is an initial order. An initial order shall become the final order within twenty-one days of the date of service.

(10) A petition for review of an initial order shall be served by certified mail, registered mail, or personal service upon the Office of the Secretary of the Washington State Department of Transportation, 3D25 Transportation, Olympia, WA 98504-7316, and copies shall be served on all parties. A petition for review of an initial order shall contain an explanation of the party's view of the matter and a statement of reasons why the initial order is incorrect. Responses to a petition for review of an initial order shall be served on the secretary at the above designated address and on all parties within ten days after receipt of the petition for review.

(11) The secretary or his or her designee shall act as the reviewing officer and shall conduct a review of an initial order upon the timely service of a petition for review or upon his or her own motion. The reviewing officer shall adopt, modify, or reject the initial order; but the reviewing officer shall not take any action on review less favorable to any party without giving that party notice and opportunity to explain the party's view of the matter.

(12) The order on review shall be in writing, shall include a brief statement of the reasons for the decision, and shall be entered within twenty days after the date of the initial order or the petition for review, whichever is later. The order shall include a description of any further available administrative review or, if none is available, a notice that judicial review may be available.

(13) The record in a brief adjudicative proceeding shall consist of any documents regarding the matters that were considered or prepared by the presiding officer for the brief adjudicative proceedings and/or by the reviewing officer for any review.

[Statutory Authority: Chapter 34.05 RCW and RCW 47.01.101(5). 94-14-101 (Order 145), § 468-10-530, filed 7/6/94, effective 8/6/94.]

Chapter 468-12 WAC

**TRANSPORTATION COMMISSION AND
TRANSPORTATION DEPARTMENT STATE
ENVIRONMENTAL POLICY ACT RULES**

WAC

468-12-010	Authority.
468-12-020	Purpose.
468-12-055	Timing of the SEPA process.
468-12-060	Content of environmental review—Scope of proposals.
468-12-455	Issuance of draft EIS.
468-12-460	Issuance of final EIS.
468-12-510	Public notice procedures.
468-12-660	Substantive authority and mitigation.
468-12-680	Administrative review.
468-12-704	Activities exempted from definition of "action."
468-12-800	Categorical exemptions.
468-12-880	Exemptions for emergency actions.
468-12-904	Incorporation of chapter 197-11 WAC.
468-12-910	Designation of responsible official.

468-12-912 Procedures when consulted.

**DISPOSITION OF SECTIONS FORMERLY
CODIFIED IN THIS CHAPTER**

468-12-025	Scope and coverage of this chapter. [Statutory Authority: 1977 ex.s. c 151. 79-01-033 (DOT Order 10 and Comm. Order 1, Resolution No. 13), § 468-12-025, filed 12/20/78. Formerly WAC 252-09-025.] Repealed by 84-19-030 (Order 90), filed 9/14/84. Statutory Authority: RCW 43.21C.120 and chapter 197-11 WAC.
468-12-040	Incorporation of the SEPA guidelines adopted by the department of ecology. [Statutory Authority: 1977 ex.s. c 151. 79-01-033 (DOT Order 10 and Comm. Order 1, Resolution No. 13), § 468-12-040, filed 12/20/78. Formerly WAC 252-09-040.] Repealed by 85-01-055 (Order 92), filed 12/17/84. Statutory Authority: RCW 43.21C.120 and chapter 197-11 WAC.
468-12-080	Program assessment of related actions. [Statutory Authority: 1977 ex.s. c 151. 79-01-033 (DOT Order 10 and Comm. Order 1, Resolution No. 13), § 468-12-080, filed 12/20/78. Formerly WAC 252-09-080.] Repealed by 85-01-055 (Order 92), filed 12/17/84. Statutory Authority: RCW 43.21C.120 and chapter 197-11 WAC.
468-12-170	Categorical exemptions. [Statutory Authority: RCW 43.21C.120 and 47.01.101(5). 81-19-051 (Order 64), § 468-12-170, filed 9/11/81. Statutory Authority: 1977 ex.s. c 151. 79-01-033 (DOT Order 10 and Comm. Order 1, Resolution No. 13), § 468-12-170, filed 12/20/78. Formerly WAC 252-09-170.] Repealed by 85-01-055 (Order 92), filed 12/17/84. Statutory Authority: RCW 43.21C.120 and chapter 197-11 WAC.
468-12-180	Exemptions for emergency actions. [Statutory Authority: 1977 ex.s. c 151. 79-01-033 (DOT Order 10 and Comm. Order 1, Resolution No. 13), § 468-12-180, filed 12/20/78. Formerly WAC 252-09-180.] Repealed by 85-01-055 (Order 92), filed 12/17/84. Statutory Authority: RCW 43.21C.120 and chapter 197-11 WAC.
468-12-185	Nonactions. [Statutory Authority: 1977 ex.s. c 151. 79-01-033 (DOT Order 10 and Comm. Order 1, Resolution No. 13), § 468-12-185, filed 12/20/78. Formerly WAC 252-09-185.] Repealed by 85-01-055 (Order 92), filed 12/17/84. Statutory Authority: RCW 43.21C.120 and chapter 197-11 WAC.
468-12-520	Procedures when consulted. [Statutory Authority: 1977 ex.s. c 151. 79-01-033 (DOT Order 10 and Comm. Order 1, Resolution No. 13), § 468-12-520, filed 12/20/78. Formerly WAC 252-09-520.] Repealed by 85-01-055 (Order 92), filed 12/17/84. Statutory Authority: RCW 43.21C.120 and chapter 197-11 WAC.
468-12-550	Extension of time period allowed for preparation of the final EIS. [Statutory Authority: 1977 ex.s. c 151. 79-01-033 (DOT Order 10 and Comm. Order 1, Resolution No. 13), § 468-12-550, filed 12/20/78. Formerly WAC 252-09-550.] Repealed by 85-01-055 (Order 92), filed 12/17/84. Statutory Authority: RCW 43.21C.120 and chapter 197-11 WAC.
468-12-820	Designation of responsible official. [Statutory Authority: 1977 ex.s. c 151. 79-01-033 (DOT Order 10 and Comm. Order 1, Resolution No. 13), § 468-12-820, filed 12/20/78. Formerly WAC 252-09-820.] Repealed by 85-01-055 (Order 92), filed 12/17/84. Statutory Authority: RCW 43.21C.120 and chapter 197-11 WAC.
468-12-990	Substantive effect of this chapter. [Statutory Authority: 1977 ex.s. c 151. 79-01-033 (DOT Order 10 and Comm. Order 1, Resolution No. 13), § 468-12-990, filed 12/20/78. Formerly WAC 252-09-990.] Repealed by 85-01-055 (Order 92), filed 12/17/84. Statutory Authority: RCW 43.21C.120 and chapter 197-11 WAC.

WAC 468-12-010 Authority. This chapter is promulgated pursuant to the authority granted in RCW 43.21C.120 and chapter 197-11 WAC.

[Statutory Authority: RCW 43.21C.120 and chapter 197-11 WAC. 84-19-030 (Order 90), § 468-12-010, filed 9/14/84. Statutory Authority: 1977 ex.s. c 151. 79-01-033 (DOT Order 10 and Comm. Order 1, Resolution No. 13), § 468-12-010, filed 12/20/78. Formerly WAC 252-09-010.]

WAC 468-12-020 Purpose. (1) The purpose of this chapter is to establish rules pertaining to the integration of the policies and procedures of the State Environmental Policy Act (SEPA), chapter 43.21C RCW, into the programs, activities, and actions of the department of transportation (hereinafter referred to as the transportation department or the department). The rules contained herein are intended to implement and be consistent with the provisions and purposes of the SEPA guidelines (chapter 197-11 WAC).

(2) These rules are intended to establish procedures for implementing SEPA which reduce duplicative and wasteful practices, establish effective and uniform procedures, encourage public involvement, and promote certainty with respect to the requirements of SEPA.

[Statutory Authority: RCW 43.21C.120 and chapter 197-11 WAC. 84-19-030 (Order 90), § 468-12-020, filed 9/14/84. Statutory Authority: 1977 ex.s. c 151. 79-01-033 (DOT Order 10 and Comm. Order 1, Resolution No. 13), § 468-12-020, filed 12/20/78. Formerly WAC 252-09-020.]

WAC 468-12-055 Timing of the SEPA process. (1) As provided by WAC 197-11-055, the SEPA process shall be completed before the transportation department is irrevocably committed to a particular course of action. At the same time, the SEPA process should not be undertaken until a proposal is sufficiently definite to permit meaningful environmental analysis.

(2) The threshold determination and any required environmental impact statement (EIS) for transportation department nonproject actions shall be completed prior to official adoption of the action in question.

(3) The threshold determination and any required (EIS) for licensing actions of the transportation department shall be completed prior to issuance of the license or licenses in question. Environmental review relating to licensing actions, when required, shall begin as soon as an application is complete. Applicants shall provide all environmental and design information necessary to prepare the appropriate environmental document. No licensing actions of the department require the submission of environmental documents to planning commissions or similar advisory bodies.

(4) The threshold determination and any required EIS for transportation department actions of a project nature shall in all cases be completed prior to the approval of the location or design of the project in question. A draft EIS shall be prepared prior to the first public hearing which may be held in connection with such project, and shall be made available at such hearing. While the transportation department may present a preferred alternate location or design in a draft EIS, final adoption of a particular location or design shall not occur until a final threshold determination has been made or a final EIS has been prepared.

[Statutory Authority: RCW 43.21C.120 and chapter 197-11 WAC. 84-19-030 (Order 90), § 468-12-055, filed 9/14/84. Statutory Authority: 1977 ex.s. c 151. 79-01-033 (DOT Order 10 and Comm. Order 1, Resolution No. 13), § 468-12-055, filed 12/20/78. Formerly WAC 252-09-055.]

WAC 468-12-060 Content of environmental review—Scope of proposals. (1) Proposals which are not so closely related to each other as to be, in effect, a single action, and which are related to a large existing or planned network of highways, streets, etc., may be separated, and the present

(2001 Ed.)

proposal may be treated as the total proposal, or only some of the future elements of a proposed action may be selected for present consideration in a threshold determination or EIS. These categorizations shall be logical with relation to the design of the total system or network, and shall not be made merely to divide a larger system into exempted fragments. These categorizations shall (a) connect logical termini (population centers, major traffic generators, major crossroads, etc.); (b) possess a reasonable degree of independent utility; and (c) promote a meaningful consideration of alternatives by avoiding the necessity of considering numerous combinations of different alternatives.

(2) Functionally related actions which are not categorically exempted by the provisions of WAC 197-11-800, and whose impacts are more significant and more readily analyzable on a "program" than on an "individual action" basis, may be analyzed, for purposes of threshold determinations and EIS preparation, as a total program.

[Statutory Authority: RCW 43.21C.120 and chapter 197-11 WAC. 84-19-030 (Order 90), § 468-12-060, filed 9/14/84. Statutory Authority: 1977 ex.s. c 151. 79-01-033 (DOT Order 10 and Comm. Order 1, Resolution No. 13), § 468-12-060, filed 12/20/78. Formerly WAC 252-09-060.]

WAC 468-12-455 Issuance of draft EIS. In addition to the circulation procedures specified by mandatory subsection of WAC 197-11-455(1), the draft EIS shall be made available at public libraries or other public places determined by the department to be appropriate and stated in the notice of availability of the draft EIS. Notice of the availability of the draft EIS shall be as stated under WAC 468-12-510.

[Statutory Authority: RCW 43.21C.120 and chapter 197-11 WAC. 84-19-030 (Order 90), § 468-12-455, filed 9/14/84.]

WAC 468-12-460 Issuance of final EIS. (1) As permitted in general terms by the provisions of WAC 197-11-460, the normal sixty-day period for preparation of a final EIS may be extended whenever the proposal is unusually large in scope, or where the environmental impact associated with the proposal is unusually complex. The determination that additional time is required for preparation of the final EIS shall be made in writing by the responsible official or his designee and shall be accompanied by a brief statement explaining the reason that additional time is required.

(2) Availability of the final EIS shall be as stated under WAC 468-12-510.

[Statutory Authority: RCW 43.21C.120 and chapter 197-11 WAC. 84-19-030 (Order 90), § 468-12-460, filed 9/14/84. Statutory Authority: 1977 ex.s. c 151. 79-01-033 (DOT Order 10 and Comm. Order 1, Resolution No. 13), § 468-12-460, filed 12/20/78. Formerly WAC 252-09-460.]

WAC 468-12-510 Public notice procedures. (1) The department shall inform the public of actions requiring notice and invitation to comment under WAC 197-11-502 and 197-11-510 in the following manner:

(a) For a determination of nonsignificance (DNS) or a mitigated DNS, issued under WAC 197-11-340(2) and 197-11-350 and requiring public notice under WAC 197-11-502 (3)(b); by (i) sending a copy of the DNS and the letter of transmittal sent to the department of ecology pursuant to WAC 197-11-508, to a newspaper of general circulation in

[Title 468 WAC—p. 15]

the county, city, or general area where the proposed action is located, agencies with jurisdiction, affected Indian tribes, and each local agency or political subdivision whose public services would be changed as a result of implementation of the proposal; and (ii) any other agency, organization, or member of the public who has made a specific request for information on the proposed action in writing to the department. Each person requesting information shall submit such request individually in writing by mail.

(b) For a determination of significance (DS) issued under WAC 197-11-360 and requiring public notice under WAC 197-11-502 (4)(a); by (i) publishing notice in a newspaper of general circulation in the county, city, or general area where the proposed action is located; (ii) sending a copy of the DS to any agencies with jurisdiction, affected Indian tribes, and any other agencies, members of the public, and organizations who have commented on the proposed action in writing to the department or expressed in writing to the department an interest in the proposed action; and (iii) using one or more of the other methods specified in WAC 197-11-510 (1)(a), (d), (e), and (f), as selected by the department;

(c) For a draft EIS issued under WAC 197-11-455 and requiring public notice under WAC 197-11-455(5) and for a public hearing held under WAC 197-11-535 and requiring public notice under WAC 197-11-502(6); by (i) publishing notice in a newspaper of general circulation in the county, city, or general area where the proposed action is located; (ii) sending notice of the availability of the draft EIS or the notice of the hearing to any agencies with jurisdiction, affected Indian tribes, and any other agencies, members of the public, and organizations who have commented on the proposed action in writing to the department or expressed in writing to the department an interest in the proposed action; and (iii) using one or more of the other methods specified in WAC 197-11-510 (1)(a), (d), (e), and (f), as selected by the department;

(d) For a final EIS issued under WAC 197-11-460 the document shall be sent to (i) the department of ecology (two copies), (ii) all agencies with jurisdiction, (iii) all agencies who commented on the draft EIS, and (iv) anyone requesting a copy of the final EIS. (As determined by the department a fee may be charged for the final EIS in accordance with WAC 197-11-504);

(e) For a notice of administrative review issued and requiring public notice pursuant to WAC 468-12-680:

(i) By publishing notice on the same day of each week for two consecutive weeks in a legal newspaper of general circulation in the area where the proposed action is located;

(ii) By filing notice of such action with the department of ecology in Olympia prior to the date of the last newspaper publication, and by one of the following methods which shall be accomplished prior to the date of the last newspaper publication:

(A) Mailing to the latest recorded real property owners, as shown by the records of the county treasurer, who share a common boundary line with the property upon which the project is proposed through United States mail, first class, postage prepaid; or

(B) Posting of the notice in a conspicuous manner on the property upon which the project is to be constructed;

(iii) The form of such notice of administrative review shall be substantially as follows:

NOTICE OF ADMINISTRATIVE REVIEW
WASHINGTON STATE DEPARTMENT OF TRANSPORTATION

NOTICE IS GIVEN UNDER SEPA, CHAPTER 43.21C RCW, WAC 197-11-680, 468-12-680, AND 468-12-510, THAT THE WASHINGTON STATE DEPARTMENT OF TRANSPORTATION TOOK THE ACTION DESCRIBED IN 2. BELOW ON

1. ANY ACTION TO SET ASIDE, ENJOIN, REVIEW, OR OTHERWISE CHALLENGE SUCH ACTION ON THE GROUNDS OF NONCOMPLIANCE WITH THE PROVISIONS OF CHAPTER 43.21C RCW (STATE ENVIRONMENTAL POLICY ACT) SHALL BE COMMENCED BY ADMINISTRATIVE REVIEW, ON OR BEFORE A PARTY DESIRING JUDICIAL REVIEW OF THE DECISION RESULTING FROM SUCH ADMINISTRATIVE REVIEW SHALL COMMENCE SUCH APPEAL WITHIN: (A) NINETY DAYS OF THE ISSUANCE OF THIS NOTICE OF ACTION OR (B) THIRTY DAYS AFTER SERVICE OF THE FINAL DECISION OF THE DEPARTMENT, WHICHEVER IS LATER.

2. DESCRIPTION OF AGENCY ACTION:

3. DESCRIPTION OF PROPOSAL:

4. LOCATION OF PROPOSAL:

5. TYPE OF ENVIRONMENTAL REVIEW UNDER SEPA:

6. DOCUMENTS MAY BE EXAMINED DURING REGULAR BUSINESS HOURS AT:

7. THIS NOTICE IS FILED BY, P.E.
PROJECT DEVELOPMENT ENGINEER
DATE:

THIS DETERMINATION MAY BE APPEALED IN WRITING TO:
PROJECT DEVELOPMENT ENGINEER; TRANSPORTATION BUILDING, MAILSTOP KF-01; OLYMPIA, WA 98504
NO LATER THAN

YOU SHOULD BE PREPARED TO MAKE SPECIFIC FACTUAL OBJECTIONS. CONTACT LOCATION DESIGN ENGINEER; TRANSPORTATION BUILDING; MAILSTOP KF-01; OLYMPIA, WA 98504; PHONE (360) 753-6141 TO READ OR ASK ABOUT THE PROCEDURES FOR SEPA APPEALS.

(2) If the department selects WAC 197-11-510 (1)(a), posting the property, as a public notice procedure, it shall do so by posting notices at major road and pedestrian intersections along the project.

(3) SEPA notices may be combined with other department notices.

[Statutory Authority: RCW 43.21C.120 and chapter 197-11 WAC. 88-01-029 (Order 111), § 468-12-510, filed 12/10/87; 84-19-030 (Order 90), § 468-12-510, filed 9/14/84.]

WAC 468-12-660 Substantive authority and mitigation. (1) It is the policy of the department that significant adverse economic, social, and environmental effects relating to any proposed department action should be fully considered in planning and implementing such action, and that final decisions on such action should be made in the best overall public interest, and taking into consideration (a) the need for fast, safe, efficient, and economical transportation and public services reasonably responsive to the public's preferences, (b) the adverse environmental, social, and economic effects of

the proposed action and alternative courses of action, and (c) the costs of eliminating or minimizing such adverse effects.

(2) The provisions of this chapter shall be interpreted in accord with this policy. This policy shall also govern substantive decisions made by the department.

[Statutory Authority: RCW 43.21C.120 and chapter 197-11 WAC. 84-19-030 (Order 90), § 468-12-660, filed 9/14/84.]

WAC 468-12-680 Administrative review. (1) The administrative review process described in this section shall apply only to actions of the department where the department publishes a notice of administrative review and where no public hearing pursuant to either chapter 47.52 or 43.21C RCW has been provided. The notice of administrative review shall describe the action to be taken and the environmental document upon which the action is based and prescribe the availability of this administrative review process to challenge the action and its environmental documents. The notice of administrative review shall be published pursuant to WAC 197-11-510. All actions of the department not subject to the administrative review process defined herein, shall be subject to applicable judicial review. The department may file a notice of action as provided for in RCW 43.21C.080 for such actions.

(2) Any person aggrieved by the department's determination to proceed with an action which is subject to administrative review as provided in subsection (1) of this section without preparation of an EIS or with preparation of an EIS alleged to be inadequate shall appeal such determination administratively before seeking judicial review thereof. Appeals of procedural and substantive determinations shall be combined (for example, an appeal of the adequacy of an EIS or the necessity of preparing an EIS must be combined with an appeal of the department's decision on the proposed action).

(3) For any action subject to the administrative review process, any determination by the department (a) that it will proceed with the action without preparation of an EIS, (b) that it will proceed with the action after preparation of an EIS, or (c) that the EIS prepared by the department is adequate, shall become final unless the aggrieved party serves on the project development engineer of the department a written request for administrative review within thirty days of the date of the filing of the department's notice of administrative review as authorized by RCW 43.21C.075. Upon receipt of such a request, the department shall afford an aggrieved party a hearing in accordance with chapter 34.04 RCW and chapter 468-10 WAC relating to contested cases. In reaching a decision based upon such a hearing, procedural determinations made by the responsible official shall be entitled to substantial weight.

(4) If a party wishes to obtain judicial review of the administrative review decision concerning that party, the aggrieved party shall first submit a notice of intent to do so with the responsible official of the department within the time period for commencing a judicial appeal as provided in subsection (5) of this section.

(5) As provided in RCW 43.21C.075 and WAC 197-11-680, a party desiring judicial review of the administrative review decision concerning that party shall commence such

(2001 Ed.)

appeal within (a) ninety days of the issuance of notice of administrative review by the department pursuant to RCW 43.21C.080, or (b) thirty days after service of the final decision of the department as provided in RCW 34.04.130, whichever is later.

[Statutory Authority: RCW 43.21C.120 and chapter 197-11 WAC. 88-01-029 (Order 111), § 468-12-680, filed 12/10/87; 84-19-030 (Order 90), § 468-12-680, filed 9/14/84.]

WAC 468-12-704 Activities exempted from definition of "action." The following activities are exempted from the definition of "action" because they are nonproject actions for which approval must be obtained from a federal agency prior to implementation as provided in WAC 197-11-704 (2)(b)(iii):

- (1) National transportation studies;
- (2) Federal-aid system designations;
- (3) National functional classification of highways and determination of needs.

[Statutory Authority: RCW 43.21C.120 and chapter 197-11 WAC. 84-19-030 (Order 90), § 468-12-704, filed 9/14/84.]

WAC 468-12-800 Categorical exemptions. The following activities of the department are within the categorical exemptions contained in the indicated subsections of WAC 197-11-800:

(1) The repair, maintenance, or minor alteration of existing private or public structures, facilities or equipment, as provided in WAC 197-11-800(3), including but not limited to:

- (a) Burning of weeds or brush within right of way limits;
- (b) Preparation, storage, and application of sand and de-icing chemicals;
- (c) Disposal and/or treatment of sewage generated on transportation department property in accordance with state and local regulations;
- (d) Right of way mowings;
- (e) Snow removal and avalanche control;
- (f) Erosion control measures;
- (g) Stormwater disposal procedures not involving significant changes in existing drainage patterns and quantities outside of transportation right of way;
- (h) Street, road, rail, and airport cleaning and sweeping;
- (i) Litter pickup and disposal;
- (j) Removal and disposal of debris;
- (k) Application of right of way fertilizer;
- (l) Planting, thinning, and removal of roadside, railside, or airport vegetation as required for landscaping and maintenance purposes;
- (m) Dead animal removal and disposal;
- (n) Pavement burning;
- (o) Maintenance and fencing of game crossings;
- (p) Pit and sundry site reclamation;
- (q) Waste oil disposal;
- (r) Maintenance of chemical toilets;
- (s) Control and disposal of roadway spills;
- (t) The periodic application of approved pesticides to transportation rights of way to maintain design conditions as provided in WAC 197-11-800(24);

(u) All repair, maintenance, or minor alteration of existing transportation pavement, drainage facilities, rails, earthwork, bridges, tunnels, guardrails, railroad protective devices, signs, paths, trails, buildings, toll booths, radio and telephone equipment, air quality equipment, rest area facilities, storage facilities, pit sites, airports, and other physical features and structures within the jurisdiction of the transportation department.

(2) Adoptions or approvals of utility, transportation, and solid waste disposal rates, as provided in WAC 197-11-800(15), including, but not limited to the establishment of or changes in toll rates.

(3) Information collection and research, as provided by WAC 197-11-800(18), including but not limited to the development, adoption, and revision of transportation plans and six-year construction programs, and any other studies, plans, and programs which lead to proposals which have not yet been approved, adopted, or funded, and which do not commit the transportation department to proceed with the proposals contained therein.

[Statutory Authority: RCW 43.21C.120 and chapter 197-11 WAC. 84-19-030 (Order 90), § 468-12-800, filed 9/14/84.]

WAC 468-12-880 Exemptions for emergency actions.

The emergency exemptions defined in WAC 197-11-880 include, but are not limited to, the following emergency actions taken by the department.

(1) Issuance of emergency load restrictions on highways and bridges;

(2) Performance of emergency protection or restoration of highways and other transportation facilities under circumstances defined in RCW 47.28.170;

(3) Approval of funding for emergency projects;

(4) Emergency disposal of hazardous material;

(5) Emergency disaster maintenance;

(6) Installation, removal, or alteration of emergency generator equipment;

(7) Restriction of use of bridges due to structural deterioration;

(8) Emergency removal of materials dangerous to highways, bridges, or other transportation facilities.

[Statutory Authority: RCW 43.21C.120 and chapter 197-11 WAC. 84-19-030 (Order 90), § 468-12-880, filed 9/14/84.]

WAC 468-12-904 Incorporation of chapter 197-11

WAC. (1) The provisions of chapter 197-11 WAC (SEPA guidelines adopted by the department of ecology on January 26, 1984), are hereby adopted by the department, and are incorporated in and made a part of this chapter by reference herein, to the extent that the SEPA guidelines are applicable to the programs, activities, and actions of the department.

(2) The provisions of this chapter are intended to implement the provisions of chapter 197-11 WAC, and to be consistent therewith.

[Statutory Authority: RCW 43.21C.120 and chapter 197-11 WAC. 84-19-030 (Order 90), § 468-12-904, filed 9/14/84.]

WAC 468-12-910 Designation of responsible official.

The responsible official for any project or nonproject actions

[Title 468 WAC—p. 18]

not described below shall be the secretary of the department. The responsible official for all project and nonproject EIS's is the project development engineer in Olympia. The responsible official for determinations of significance and determinations of nonsignificance on project actions is the district administrator in the district where the action is located.

[Statutory Authority: RCW 43.21C.120 and chapter 197-11 WAC. 84-19-030 (Order 90), § 468-12-910, filed 9/14/84.]

WAC 468-12-912 Procedures when consulted. When a request by another agency for consultation is made pursuant to the provisions of WAC 197-11-912, such request shall be referred for response to the project development office of the department in Olympia who shall coordinate the research and field investigations which may be necessary, and supervise the transmittal of the requested information to the lead agency within the time periods specified by WAC 197-11-502.

[Statutory Authority: RCW 43.21C.120 and chapter 197-11 WAC. 84-19-030 (Order 90), § 468-12-912, filed 9/14/84.]

Chapter 468-16 WAC

PREQUALIFICATION OF CONTRACTORS

WAC

468-16-010	General.
468-16-020	Purpose.
468-16-030	Definitions.
468-16-040	Criteria for a determination of an unsatisfactory record of performance.
468-16-050	Criteria for a determination of an unsatisfactory record of integrity and judgment.
468-16-060	Criteria for a determination of inability to comply with performance schedules.
468-16-070	Criteria for a determination of the lack of necessary experience, organization, or technical qualifications.
468-16-080	Qualification procedures for projects under eighty thousand dollars and effective July 1, 2005, one hundred thousand dollars.
468-16-090	Standard questionnaire.
468-16-100	Conditional qualification.
468-16-110	Joint ventures.
468-16-120	Work class ratings.
468-16-130	Prequalification work classes.
468-16-140	Maximum capacity rating.
468-16-150	Prime contractor performance reports.
468-16-160	Interim reports.
468-16-170	Refusal to issue proposal.
468-16-180	Suspension of qualification.
468-16-190	Revocation of qualification.
468-16-200	Hearings procedure.
468-16-210	Prime contractor performance report.

WAC 468-16-010 General. No contract for the construction, improvement or repair of any state highway, or of any other public highway to be awarded and administered by the department of transportation, may be awarded to any contractor who has not first been prequalified to perform the work. Bidding proposals will be issued only to prequalified contractors.

[Statutory Authority: RCW 47.01.101, 47.28.030 and 47.28.070. 91-04-014 (Order 128), § 468-16-010, filed 1/28/91, effective 2/28/91.]

WAC 468-16-020 Purpose. This chapter is promulgated to assure that contractors engaged in the improvement and construction of state highways possess the necessary

qualifications as required by RCW 47.28.070. It is further intended to:

(1) Establish a method for determining a contractor's qualifications to undertake department work and for the retention of that qualification.

(2) Provide a means for contractors to enhance their prequalification status and bidding capacity through higher standards of performance.

(3) Increase the opportunity for a better relationship between the department and construction contracting firms.

(4) Provide for the award, denial, suspension, or revocation of qualification; denial of proposal issuance; and for a hearing procedure, if required, for such actions.

[Statutory Authority: RCW 47.01.101, 47.28.030 and 47.28.070. 91-04-014 (Order 128), § 468-16-020, filed 1/28/91, effective 2/28/91.]

WAC 468-16-030 Definitions. The definitions set forth in this section apply throughout this chapter and have the following meanings, unless the context clearly indicates otherwise.

(1) **Above standard** - Performance ranging from standard to that meeting the lower range of superior.

(2) **Active contractor** - A contractor who has participated in department activities through maintaining required prequalification and having a history of performing department work.

(3) **Affiliate** - An associate, subordinate associate, or subsidiary firm which may involve the intermingling of funds, officers, or officials of one or more firms.

(4) **Assistant secretary for field operations support** - The primary representative of the secretary of transportation responsible for the highway construction program and for the qualification of contractors employed thereon.

(5) **Below standard** - Performance bordering on standard extending to the limits of inadequate.

(6) **Bidding proposal** - A form issued by the department for the submission of a contractor's bid containing spaces for entering bid amounts, authentication, and other data.

(7) **Capacity multiplier** - The number 5.0 multiplied by a firm's net worth to calculate its initial maximum bidding capacity.

(8) **Conditional qualification** - A temporary qualification status given a contractor who has received a "below standard" or "inadequate" overall rating or for other reasons which result in restrictions to a contractor's ability to bid on department work.

(9) **Contractor** - Any person, partnership, firm, corporation or joint venture who or which, in the pursuit of an independent business, undertakes, offers to undertake, or submits a bid to perform construction work for the department.

(10) **Department** - The department of transportation.

(11) **Endorser** - The region operations engineer or immediate supervisor of the construction project engineer, or project architect or, under specified conditions, the region administrator responsible for reviewing contractor's performance reports.

(12) **Inadequate** - Performance failing completely to meet the prescribed standard or requirement.

(13) **Integrity** - The quality of being of sound moral principle, uprightness, honesty, and sincerity.

(14) **Joint venture** - Two or more persons, sole proprietorships, companies, corporations, or combinations thereof, entering into an agreement for a business venture such as a construction project.

(15) **Limited work class** - A work classification given when a contractor lacks the total experience, organization, equipment, or skills required to perform the entire range of work within a work class.

(16) **Maximum capacity rating** - The total value of uncompleted prime contract work a contractor is permitted to have under contract at any time.

(17) **Performance inquiry** - A request made to a contractor's previous employers for an evaluation of the quality and manner of that contractor's performance.

(18) **Performance rating** - A numerical rating which is equal to the grand total of the evaluation elements of the prime contractor's performance report used to measure and quantify the quality of contractor performance.

(19) **Prequalification** - The process of evaluating a contractor's financial status, organizational structure, experience, equipment, integrity, and other required qualifications to determine a contractor's responsibility and suitability for performing department work. This term is used interchangeably with qualification.

(20) **Prime contractor performance report** - A report prepared to evaluate the performance of a prime contractor upon completion of, or at an interim period during a department project which is used to adjust a prime contractor's qualification status.

(21) **Project estimate** - A document prepared by the department establishing the estimated value of all items of work, the total estimated value of work within each class of work, and the estimated total value of a project.

(22) **Rater** - The designated individual, normally the project engineer, responsible for evaluation of the quality and manner of performance of a contractor in the completion of a project.

(23) **Revocation of qualification** - The act by which a contractor's qualification is terminated.

(24) **Secretary** - The secretary of transportation who may delegate his or her functions under this chapter to the assistant secretary for field operations support or such other individual as deemed appropriate.

(25) **Standard** - The expected, acceptable quality of performance, considered to meet the demand, need or requirement.

(26) **Standard questionnaire** - The application form completed by a contractor to present information relating to the applicant's financial status, experience, organization, and equipment for the purpose of becoming qualified to perform department work.

(27) **Superior** - Preeminent performance consistently at an extremely high level.

(28) **Suspension of qualification** - The termination of a contractor's qualification for a specified period of time.

(29) **Unsatisfactory** - Below standard or inadequate performance, failing to meet requirements.

(30) **Work class** - A specific type of work within the various classifications of work, e.g., grading, draining, fencing, etc.

(31) **Work class rating** - The maximum value within a class of work that is used to determine a firm's eligibility to receive a bid proposal document for a single project.

[Statutory Authority: RCW 47.01.101, 47.28.030 and 47.28.070. 97-09-045 (Order 168), § 468-16-030, filed 4/15/97, effective 5/16/97; 93-03-020 (Order 134), § 468-16-030, filed 1/12/93, effective 2/12/93; 91-04-014 (Order 128), § 468-16-030, filed 1/28/91, effective 2/28/91.]

WAC 468-16-040 Criteria for a determination of an unsatisfactory record of performance. The following list of deficiencies may be considered cause for a determination that an unsatisfactory record of performance exists:

- (1) Failure to complete project on time; or
- (2) Continued workmanship below the level of standard; or
- (3) Failure to adhere to the plans and specifications; or
- (4) Disregard for the welfare or safety of traveling public; or
- (5) Inadequate supervision and control of subcontractors; or
- (6) Insufficient supervision available on project site; or
- (7) Inadequate coordination and planning with owner; or
- (8) Inadequate procurement and delivery of supplies and materials; or
- (9) Inadequate control and utilization of equipment; or
- (10) An overall performance rating in the prime contractor performance report of less than standard as defined in WAC 468-16-030 and 468-16-150.

[Statutory Authority: RCW 47.01.101, 47.28.030 and 47.28.070. 93-03-020 (Order 134), § 468-16-040, filed 1/12/93, effective 2/12/93; 91-04-014 (Order 128), § 468-16-040, filed 1/28/91, effective 2/28/91.]

WAC 468-16-050 Criteria for a determination of an unsatisfactory record of integrity and judgment. (1) The following deficiencies may be cause for a determination that an unsatisfactory record of integrity and judgment exists:

- (a) Conviction of the firm or its principals of violating a federal or state antitrust law by bid-rigging, collusion, or restraint of competition between bidders; or conviction of violating any other federal or state law related to bidding or contract performance; or
 - (b) Knowingly concealing any deficiency in the performance of a prior contract; or
 - (c) Falsification of information or submission of deceptive or fraudulent statements in connection with prequalification, bidding, performance of a contract, or in legal proceedings; or
 - (d) Debarment of the contractor by a federal or state agency; or
 - (e) Willful disregard for applicable laws, rules or regulations.
- (2) Only such data relating to subsection (1)(a) through (e) of this section having taken place within three years next preceding the date of the most recently submitted standard questionnaire may be used for the purpose of this section.

[Title 468 WAC—p. 20]

[Statutory Authority: RCW 47.01.101, 47.28.030 and 47.28.070. 93-03-020 (Order 134), § 468-16-050, filed 1/12/93, effective 2/12/93; 91-04-014 (Order 128), § 468-16-050, filed 1/28/91, effective 2/28/91.]

WAC 468-16-060 Criteria for a determination of inability to comply with performance schedules. The following discrepancies may be cause for a determination of inability to comply with performance schedules:

- (1) A majority of responses to inquiries made to owners of previously completed projects reveal that projects have not been completed on time; or
- (2) A major portion of projects completed within the last three years for the department have not been completed on time; or
- (3) When two or more consecutive performance reports are rated below standard in the area of "progress of work"; or
- (4) Neglectful or willful failure to meet interim completion dates as defined in the contract.

[Statutory Authority: RCW 47.01.101, 47.28.030 and 47.28.070. 93-03-020 (Order 134), § 468-16-060, filed 1/12/93, effective 2/12/93; 91-04-014 (Order 128), § 468-16-060, filed 1/28/91, effective 2/28/91.]

WAC 468-16-070 Criteria for a determination of the lack of necessary experience, organization, or technical qualifications. A determination of lack of necessary experience, organization, or technical qualification may be made when data has been presented which reveals:

- (1) A lack of prior experience in the classes of work for which qualification is sought; or
- (2) That supervisory experience of key personnel responsible for prior projects has been reported predominantly below standard or less than satisfactory on performance reports and responses to inquiries made to other project owners or agencies; or
- (3) That permanent employment status of key supervisory personnel has not been of a duration of at least one year or for the duration of the project in which they have been engaged; or
- (4) That previous work experience in a work class presented for qualification did not conform to plans and specifications for the project; or
- (5) That work claimed by the contractor was completed by others.

[Statutory Authority: RCW 47.01.101, 47.28.030 and 47.28.070. 93-03-020 (Order 134), § 468-16-070, filed 1/12/93, effective 2/12/93; 91-04-014 (Order 128), § 468-16-070, filed 1/28/91, effective 2/28/91.]

WAC 468-16-080 Qualification procedures for projects under eighty thousand dollars and effective July 1, 2005, one hundred thousand dollars. (1) Contractors may be qualified by region administrators for projects valued under eighty thousand dollars and effective July 1, 2005, one hundred thousand dollars. Submission of a limited prequalification questionnaire (DOT form 272-063) to the region administrator or designee is required, except when the contractor is currently prequalified with the department of transportation under the provisions of chapter 468-16 WAC.

- (2) Procedures for letting region level projects valued under eighty thousand dollars and effective July 1, 2005, one

(2001 Ed.)

hundred thousand dollars are published in Department Directives.

[Statutory Authority: RCW 47.01.101, 47.28.030, and 47.28.070. 00-14-055, § 468-16-080, filed 7/3/00, effective 8/3/00; 97-09-045 (Order 168), § 468-16-080, filed 4/15/97, effective 5/16/97; 91-04-014 (Order 128), § 468-16-080, filed 1/28/91, effective 2/28/91.]

WAC 468-16-090 Standard questionnaire. The standard questionnaire and financial statement shall be prepared and transmitted to the secretary, Attn: Contractor prequalification office. The questionnaire shall include the following information:

(1) The contractor's name, address, phone number, facsimile number, and type of organization (corporation, partnership, sole proprietorship, etc.).

(2) A list of the classes of work for which the contractor seeks qualification.

(3) A statement of the ownership of the firm and, if a corporation, the name of the parent corporation, if any, and the names of any affiliated or subsidiary companies.

(4) A certificate of authority from the office of the secretary of state to do business in Washington state if the applicant is an out-of-state corporation.

(5) A list of officials within the applicant firm who are also affiliated with other firms involved in construction work as a contractor, subcontractor, supplier, or consultant; including the name of the firm and their relationship with the affiliate firm.

(6) A complete list of the highest valued contracts or subcontracts performed in whole or in part within the immediate three years preceding application. The contract amount, contract number, date of completion, class of work; and the name, mailing address, and phone number of the project owner or agency representative must be provided for those projects listed. Only that work completed by the contractor's own organization under its own supervision will be considered for prequalification purposes. A minimum of five completed projects must be listed.

(7) Personnel requirements.

(a) A listing of the principal officers and key employees indicating their years of experience in the classes of work for which prequalification is sought. For qualification in a class of work based on newly acquired personnel rather than the firm's past contract experience, the newly acquired personnel must be available for future employment for the full year for which qualification is sought unless replacement personnel have been approved. The loss of such personnel during the year of qualification, will result in revocation of qualification for the class of work granted pursuant to their acquisition. The department may require resumes of such personnel as deemed proper for making its determination. The firm's performance on department contracts must be currently rated standard or better to be used for qualification purposes.

(b) A firm must have, within its own organization, qualified permanent, full time personnel having the skills and experience including, if applicable, technical or specialty licenses, for each work class for which prequalification is sought. Those firms seeking qualification for electrical work (classes 9 and 16) must provide photocopies of current Washington state electrical licenses. The skills and experience

must be substantiated by education and practical experience on completed construction projects.

(c) "Its own organization" shall be construed to include only the contractor's permanent, full time employed office and site supervisory personnel as shown on the most recently submitted or amended prequalification questionnaire. Workers of the organization shall be employed and paid directly by the prime contractor. The term "its own organization," shall also include the equipment owned or rented by the contractor with or without equipment operators. Such term does not include employees or equipment of another contractor, subcontractor, assignee, or agent of the applicant contractor although they are placed on the applicant contractor's payroll.

(8) A list of all major items of equipment used to perform those classes of work for which prequalification is sought. The description, quantity, condition, present location, and age of such equipment must be shown. The schedule must show whether the equipment is owned, leased, or rented.

(9) A financial statement.

For a firm showing a net worth in excess of one hundred thousand dollars, the applicant must provide, with the questionnaire, a copy of its financial statement as audited or reviewed for its last fiscal year, prepared in accordance with the standards of the American Institute of Certified Public Accountants. The statement must be prepared by an independent certified public accountant registered and licensed under the laws of any state. Balance sheets, income statements, a statement of retained earnings, supporting schedules and notes, and the opinion of the independent auditor must accompany the financial statement.

(10) A wholly owned subsidiary firm may file the latest consolidated financial statement of its parent corporation in lieu of a financial statement prepared solely for the subsidiary. When a consolidated financial statement is submitted, the requirements of subsection (9) of this section and WAC 468-16-140 (2)(b) must be fulfilled.

(11) The applicant shall list the following occurrences within the previous three years:

(a) Instances of having been denied qualification, or a license, or instances of having been deemed other than responsible by any public agency.

(b) Convictions for felonies listed in WAC 468-16-050.

(c) Failure to complete a contract.

(12) The standard questionnaire shall be processed as follows:

(a) The application for qualification shall be prepared on a standard questionnaire provided by the department and sworn to before a notary public or other person authorized to take oaths.

(b) A standard questionnaire will be reviewed and a written notice provided to the applicant, within thirty days of its receipt, stating whether the applicant has been prequalified or qualification has been denied. The applicant will be advised of lack of receipt of data corroborating project completion and errors or omissions in the questionnaire and a request made for additional information necessary to complete evaluation of the applicant. If the information is not provided within twenty calendar days of the request, the application will be processed, if possible, with the information available or it will be returned to the applicant without further action.

(c) When qualification is denied, the applicant shall be advised in writing by certified mail (return receipt requested) of the reasons for the denial and of the right to a hearing upon written request.

(d) Applicants not satisfied with the qualification granted may request in writing, a review of their questionnaire and qualification ratings. The request must be filed within thirty calendar days of the date of receipt of the notice of qualification and must specifically state the basis for the request.

(e) The secretary or designee shall advise the applicant of his or her decision on the reconsideration within thirty calendar days of receipt of the request.

(13) Criteria for initial qualification, renewal, and submission of supplemental data:

(a) Qualification may be established in any calendar quarter and must be renewed annually. Information submitted in the questionnaire will be used as a basis for the contractor's initial prequalification, work class ratings, and maximum capacity ratings. Qualification will be valid for the remainder of the applicant's fiscal year plus one calendar quarter as established by the date of the year-end financial statement. Prequalification will be renewed annually thereafter or at other times as designated by the department.

(b) A standard questionnaire from a contractor, not previously qualified under this chapter, must have been received by the department no less than fifteen calendar days prior to the scheduled bid opening to receive consideration for issuance of a bidding proposal for that bid opening.

(c) The department may, during the period for which the contractor has been prequalified, require the submission of a new standard questionnaire. If the questionnaire is not provided within thirty calendar days of the date of request, the notice of qualification held by the contractor will be declared invalid and the contractor will not be permitted to bid with the department until the contractor is again prequalified.

(d) A supplemental questionnaire shall be submitted when a significant change in the structure of the firm occurs, e.g., incorporation, officers, ownership, etc., or when required by the department.

(e) If prequalification has lapsed for more than six months, the applicant will again be required to submit a fully executed standard questionnaire and financial statement.

(f) The applicant shall authorize the department to request and receive such additional information from any sources deemed necessary for the completion of the qualification process.

(g) Inquiries will be made and investigations, if necessary, will be conducted to verify the applicant's statements and to determine eligibility for qualification.

(h) The department may require a personal interview with a principal or principals of the contracting firm when considering its qualification.

(i) Qualified contractors in good standing shall be notified of impending expiration of their qualification and will be provided the necessary questionnaire forms for renewal at least forty-five days before the expiration date.

(14) Financial information supplied by, or on behalf of, a contractor for the purpose of qualification shall not be made available for public inspection and copying pursuant to RCW

42.17.310 (1)(m). The foregoing restriction shall not prohibit the department's providing such information in evidence or in pretrial discovery in any court action or administrative hearing involving the department and a contractor. Insofar as permitted by public disclosure statutes, qualification ratings shall be treated as confidential information.

(15) Qualified contractors will be provided with notices which list projects currently being advertised.

[Statutory Authority: RCW 47.01.101, 47.28.030 and 47.28.070. 97-09-045 (Order 168), § 468-16-090, filed 4/15/97, effective 5/16/97; 94-05-004, § 468-16-090, filed 2/2/94, effective 3/5/94; 93-03-020 (Order 134), § 468-16-090, filed 1/12/93, effective 2/12/93; 91-04-014 (Order 128), § 468-16-090, filed 1/28/91, effective 2/28/91.]

WAC 468-16-100 Conditional qualification. (1) A firm may be conditionally qualified when it has been given a below standard (less than 100) performance rating on a final performance report. A firm may also be qualified conditionally by the secretary when performance has become below standard in either "quality of work" or "progress of work" on an interim report for a current project. The region administrator or designated assistant may, under the foregoing condition, request in writing that a contractor be placed in conditional status. A conditionally qualified contractor will be denied bidding proposals while in that status but may receive, at the discretion of the secretary, a bidding proposal for one project.

(2) The assistant secretary for field operations support shall advise the contractor and the region administrator or designated assistant when a contractor has been placed in conditional status.

(3) Should the contractor be the low successful bidder and be awarded a contract subsequent to being placed in conditional status, the issuance of further bidding proposals will be considered only when an interim report is submitted in accordance with WAC 468-16-160 or when a final performance report is submitted in accordance with WAC 468-16-150(12) and the rating thereon is standard or better.

(4) Normally a contractor may have only one active prime contract for the department while qualified conditionally.

(5) Return to fully qualified status of a conditionally qualified contractor will be effected by:

(a) A performance rating of standard or above on contracts completed during the current prequalification year; or

(b) An interim rating of standard or above on all concurrent contracts; or

(c) A standard or above rating on the first interim report for a project awarded subsequent to conditional qualification.

(6) Should the rating continue to be less than standard, the contractor's prequalification will be suspended in accordance with WAC 468-16-180.

[Statutory Authority: RCW 47.01.101, 47.28.030, and 47.28.070. 00-14-055, § 468-16-100, filed 7/3/00, effective 8/3/00; 97-09-045 (Order 168), § 468-16-100, filed 4/15/97, effective 5/16/97; 93-03-020 (Order 134), § 468-16-100, filed 1/12/93, effective 2/12/93; 91-04-014 (Order 128), § 468-16-100, filed 1/28/91, effective 2/28/91.]

WAC 468-16-110 Joint ventures. (1) Joint ventures are prequalified under two categories as follows:

(a) Individual project joint venture - An association of two or more firms formed for the specific purpose of submitting a bid on a specific project.

(i) All firms must be individually prequalified.

(ii) The firms must file an "individual project statement of joint venture" and a joint venture agreement in the formats prescribed.

(iii) Individual project joint ventures must maintain a standard or higher performance. Should the individual project joint venture receive a less than standard rating, the provisions of WAC 468-16-100 shall apply.

(b) Continuing joint venture - An association of two or more firms formed for the purpose of submitting bids for projects to be advertised over a period of time.

(i) All firms must be individually prequalified.

(ii) The firms must file a "statement of continuing joint venture."

(iii) Continuing joint ventures must maintain a standard or higher performance rating in order to remain qualified.

(iv) A rating of less than standard will cause the joint venture to be placed in conditional qualification status.

(2) A standard questionnaire and financial statement for each member, if not on file, and a standard questionnaire and financial statement designating the assets and liabilities of the venture shall be submitted for the joint venture with a copy of the joint venture agreement. The agreement shall specify the name under which the joint venture will operate and the names of those individuals authorized to sign proposals, contracts, and other documents on behalf of the joint venture. It shall contain provisions which will unequivocally bind the parties, jointly and severally, to any contract entered into thereunder.

[Statutory Authority: RCW 47.01.101, 47.28.030 and 47.28.070. 94-05-004, § 468-16-110, filed 2/2/94, effective 3/5/94; 91-04-014 (Order 128), § 468-16-110, filed 1/28/91, effective 2/28/91.]

WAC 468-16-120 Work class ratings. (1) Qualification shall be granted a contractor in one or more classes of work in which the firm has shown the capability to satisfactorily perform with its own forces under its own immediate supervision.

(2) The department's project estimate shall be the only estimate used to determine the value of the various classes of work within a project for determining a contractor's eligibility to bid that specific project. The contractor will be required to perform a specified percentage of the total work as provided for in the current issue of the *Standard Specifications*.

(3) Contractors will be given work class ratings on the basis of their financial status, performance record, previous experience, organization, and condition and suitability of equipment.

(4) When it has been determined that adequate competition cannot be afforded as a result of either the lack of prequalified bidders, or the lack of applicants for qualification with sufficient experience in the work class required, the department may take in consideration the firm's experience in performing other related work in order to create competition providing that:

(a) The work class does not require a specialty license.

(b) The firm seeking the work class is deemed qualified in another work class under chapter 468-16 WAC.

(c) The firm seeking such work meets all other requirements prescribed under this chapter including the availability of the necessary equipment for the project being let.

(5) Data provided by project owners, other than the department, to inquiries made concerning new applicants seeking qualification, shall be used to determine initial work class ratings and maximum capacity ratings. Initial work class ratings for new applicants and those of firms which have not renewed their qualification within two years, will be based on performance data provided by agencies or organizations having previously employed the applicant. Such other data as the department may have on file may also be used. Work submitted by the new contractor and verified by the department will be given an initial work class rating equal to 2.5 times the highest value of the work the contractor has completed within that work class during the past three years. If a specific portion of a work class is performed by the contractor, the prequalification for that class will be limited to that portion of the work.

(6) Work reported as less than satisfactory will not be accepted for qualification purposes, but may be included with performance reports in determining the status of the contractor's prequalification.

(7) Work class ratings previously granted will not be reduced providing the contractor has maintained a standard performance record on department work and the contractor continues to submit the required questionnaire annually. Should a significant reduction of resources occur, the contractor's work class ratings may be modified or reduced to an amount within the contractor's current capacity.

(8) A contractor's work class ratings will be reviewed annually effective on the date the renewal questionnaire has been received. Work class ratings for those contractors renewing prequalification will be reviewed for increases, decreases, and additional work classes not previously granted. In determining the annual status of the contractor's work class ratings, prime work completed for the department and the performance rating given for that work shall be weighted more heavily than work completed for other agencies.

(9) Work class ratings shall be computed by multiplying the highest value of the work class completed satisfactorily during the preceding prequalification year by a factor of 2.5 provided that the currently established work class rating is not higher. In that event, the currently established work class shall become the work class rating for the ensuing qualification year. Work class ratings will not change if the contractor has not performed in that work class during the prequalification year.

[Statutory Authority: RCW 47.01.101, 47.28.030 and 47.28.070. 97-09-045 (Order 168), § 468-16-120, filed 4/15/97, effective 5/16/97; 94-05-004, § 468-16-120, filed 2/2/94, effective 3/5/94; 93-03-020 (Order 134), § 468-16-120, filed 1/12/93, effective 2/12/93; 91-04-014 (Order 128), § 468-16-120, filed 1/28/91, effective 2/28/91.]

WAC 468-16-130 Prequalification work classes. A contractor seeking prequalification under this chapter will be classified for one or more of the following listed work classes

in accordance with the adequacy of the firm's equipment and plant facilities and its proven ability to perform the work class sought.

- Class 1 **Clearing, grubbing, grading & draining**
Removal of tree stumps, shrubs, modification of the ground surface by cuts and fills, excavating of earth materials, and the placement of drainage structures.
- Class 2 **Production and placing of crushed materials**
Production and placing crushed surfacing materials and gravel.
- Class 3 **Bituminous surface treatment**
Placing of crushed materials with asphaltic application.
- Class 4 **Asphalt concrete paving**
Production and placing Asphalt Concrete Plant Mix Pavement.
- Class 5 **Cement concrete paving**
Production and placing cement concrete pavement.
- Class 6 **Bridges and structures**
Construction of bridges, walls and other major structures of timber, steel, and concrete.
- Class 7 **Buildings**
Construction of buildings and related structures within the right of way and major reconstruction and remodeling of such buildings.
- Class 8 **Painting**
Painting bridges, buildings, and related structures.
- Class 9 **Traffic signals**
Installation of traffic signal and control systems.
- Class 10 **Structural tile cleaning**
Cleaning tunnels, large buildings and structures and storage tanks.
- Class 11 **Guardrail**
Construction of a rail secured to uprights and erected as a barrier between, or beside lanes of a highway.
- Class 12 **Pavement marking (excluding painting)**
Thermoplastic markings, stripes, bars, symbols, etc. Traffic buttons, lane markers, guide posts.
- Class 13 **Demolition**
Removal of timber, steel, and concrete structures and obstructions.
- Class 14 **Drilling and blasting**
Controlled blasting of rock and obstructions by means of explosives.
- Class 15 **Sewers and water mains**
Draining, pipe jacking, water systems, pumping stations, storm drainage systems, sewer rehabilitation, sewage pumping stations, pressurized lines.
- Class 16 **Illumination & general electrical**
Highway illumination, navigational lighting, wiring, junction boxes, conduit installation.
- Class 17 **Cement concrete curb and gutter**
Sidewalks, spillways, driveways, monument cases and covers, right of way markers, traffic curbs, and gutters.
- Class 18 **Asphalt concrete curb and gutter**
Sidewalks, spillways, driveways, monument cases and covers, right of way markers, traffic curbs, and gutters.
- Class 19 **Riprap and rock walls**
Mortar, rubble, and masonry walls; rock retaining walls, and placing of large broken stone on earth surfaces for protection against the action of water.
- Class 20 **Concrete structures except bridges**
Cast-in-place median barrier, prestressing, post-tensioned structures, footings, prefabricated panels and walls, retaining walls, and ramps, foundations, rock bolts, and concrete slope protection.
- Class 21 **Tunnels and shaft excavation**
Tunnel excavation, rock tunneling, and soft bore tunneling.
- Class 22 **Piledriving**
Driving concrete, steel, and timber piles.
- Class 23 **Concrete surface treatment**
Exposed aggregate, fractured-fin and rope textured finishes; waterproofing concrete surfaces (clear or pigmented sealer).
- Class 24 **Fencing**
Wire and metal fencing, glare screens.
- Class 25 **Bridge deck repair**
Bridge expansion joint repair and modification, bridge deck resurfacing and repair.
- Class 26 **Deck seal**
Waterproof membrane.
- Class 27 **Signing**
Sign structures and signs.
- Class 28 **Not used**
- Class 29 **Slurry diaphragm and cut-off walls**
Slurry excavation and the construction of structural concrete walls and slurry cut-off walls.
- Class 30 **Surveying**
Highway construction surveying.
- Class 31 **Water distribution and irrigation**
Irrigation systems and heavy duty water distribution.
- Class 32 **Landscaping**
Landscape irrigation, planting, sodding, seeding, fertilizing, mulching, herbicide application, insecticide application, weed control, mowing, liming, soil binder, topsoil.

- Class 33 **Engineering**
Work other than surveying, including engineering calculations, drawing and other related work for highway construction.
- Class 34 **Erosion control**
Seeding, fertilizing, mulching, slope protection, topsoil application, hydro-seeding, soil stabilization, soil sampling.
- Class 35 **Precast median barrier**
A concrete barrier that is cast and cured in other than its final position used to divide the median of two adjacent highways or temporarily placed to divert traffic in construction zones.
- Class 36 **Permanent tie back anchor**
Installation of permanent rock and soil anchors, soldier piles and timber lagging. Soldier pile tie back anchor wall construction.
- Class 37 **Impact attenuators**
Installation of approved protective systems filled with sand, water, foam, or other substances which prevent errant vehicles from impacting roadside hazards.
- Class 38 **Paint striping**
Painted bars, letters, symbols, and striping.
- Class 39 **Wire mesh slope protection**
The installation of a zinc coated steel wire mesh anchored by wire rope and reinforced concrete posts or anchor rods. Used for dampening the effects of rolling rocks onto the highway. Slope scaling, horizontal drains, rock dowels, and rock bolts for slope stabilization.
- Class 40 **Gabion and gabion construction**
Construction of walls made with containers of galvanized steel hexagonal wire mesh and filled with stone.
- Class 41 **Not used**
- Class 42 **Electronics—fiber optic based communications systems**
Design and installation of fiber optic based communication systems.
- Class 43 **Mechanical**
Plumbing work and the installation of heating or air conditioning units.
- Class 44 **Asbestos abatement**
Asbestos abatement (L & I certified workers).
- Class 45 **Hazardous waste removal**
The containment, cleanup, and disposal of toxic materials. Companies seeking this classification shall have full-time personnel with current hazardous waste training (certifications).
- Class 46 **Concrete restoration**
Pavement subseal, cement concrete repair, epoxy coatings, epoxy repair, masonry repair, masonry cleaning, special coatings, epoxy injection, gunite, shotcrete grouting, pavement jacking, gunite repair, and pressure grouting.
- Class 47 **Concrete sawing, coring, and grooving**
Concrete sawing, concrete planing and grooving, bump grinding, joint repair, concrete coring, rumble strips.
- Class 48 **Dredging**
Excavating underwater materials.
- Class 49 **Marine work**
Underwater surveillance, testing, repair, sub-aquatic construction, anchors, and cable replacement, floating concrete pontoon repairs and modifications, disassembly and assembly of floating concrete pontoons.
- Class 50 **Ground modification**
Pressure grouting, blast densification, stone column, jet grouting, compaction, dynamic compaction, soil mixing, gravel drain.
- Class 51 **Well drilling**
Drilling wells, installing pipe casing and pumping stations.
- Class 52 **Sewage disposal**
Hauling and disposing liquid and solid wastes.
- Class 53 **Traffic control**
Providing piloted traffic control, traffic control labor, and maintenance and protection of traffic.
- Class 54 **Railroad construction**
Construction of railroad subgrade, placing of ballast, ties, and track and other items related to railroad work.
- Class 55 **Steel fabrication**
Welding of steel members, heat straightening steel.
- Class 56 **Street cleaning**
Street sweeping with self-propelled sweeping equipment.
- Class 57 **Materials transporting**
Truck hauling.
- Class 58 **Sand blasting and steam cleaning**
Steam cleaning, sand blasting, shot blasting, and water blasting.

[Statutory Authority: RCW 47.01.101, 47.28.030 and 47.28.070. 97-09-045 (Order 168), § 468-16-130, filed 4/15/97, effective 5/16/97; 94-05-004, § 468-16-130, filed 2/2/94, effective 3/5/94; 93-03-020 (Order 134), § 468-16-130, filed 1/12/93, effective 2/12/93; 91-04-014 (Order 128), § 468-16-130, filed 1/28/91, effective 2/28/91.]

WAC 468-16-140 Maximum capacity rating. (1) The maximum capacity rating shall be determined by multiplying the contractor's reported net worth by a factor of 5.0. The factor may be increased at a rate of 0.5 annually, provided the contractor has maintained a satisfactory performance record

with the department and has completed a contract of fifty thousand dollars or more within the preceding prequalification year. The maximum factor shall be 7.5. The department may at any time decrease the rating factor if the contractor's performance becomes less than standard, however no decrease in the bidding capacity will become effective until action to appeal, as specified in these rules, has been completed.

(2) For the purpose of prequalification and establishing the maximum capacity rating, the following additional resources may be added to net worth if supported with documentation as specified:

(a) An operating line of credit - Documentation from an acceptable financial institution stating the amount of credit authorized, its expiration date, and the amount currently available. The document must be authenticated by an official authorized to execute lines of credit on behalf of the institution. Should the operating line of credit be revoked, it shall be deducted before computing a new annual maximum capacity rating.

(b) A parent firm pledge of net worth - A sworn statement from the parent firm that guarantees the performance of the subsidiary for any contracts awarded it. The document shall include a parent firm pledge in an amount such that when calculated in subsection (1) of this section will not be less than the value of uncompleted contracts of the subsidiary. An audited financial statement, as prescribed in WAC 468-16-090(9), may be requested from the parent firm when deemed appropriate.

(c) A personal pledge of net worth - A sworn statement pledging a specific amount of personal assets. The statement must be accompanied by acceptable documents that will verify the ownership and value of the assets.

(3) Resources listed above will not be accepted in lieu of a minimum net worth of fifty thousand dollars.

(4) For the purpose of prequalification and establishing the maximum capacity rating, a bidding company which has established a leveraged ESOP (Employee Stock Ownership Plan) may use, in place of its net worth, the lesser of:

(a) The company's net worth, as adjusted by eliminating any contra-equity or unearned compensation entry in the net worth section of the balance sheet which is directly related to the ESOP loan; or

(b) The company value as established by the company's most recent valuation for ESOP purposes provided the valuation was performed within the last twelve months which meets federal guidelines for ESOP-related valuations. The department may require submission of a copy of this valuation report for documentation purposes.

(5) When the value of a firm's uncompleted work for the department exceeds its maximum capacity rating, a bidding proposal shall be denied that firm.

[Statutory Authority: RCW 47.01.101, 47.28.030 and 47.28.070. 97-09-045 (Order 168), § 468-16-140, filed 4/15/97, effective 5/16/97; 93-03-020 (Order 134), § 468-16-140, filed 1/12/93, effective 2/12/93; 91-04-014 (Order 128), § 468-16-140, filed 1/28/91, effective 2/28/91.]

WAC 468-16-150 Prime contractor performance reports. (1) Performance reports described in this section, substantially in the format as that appearing at WAC 468-16-

210, will be completed for prime contractors only for projects valued at one hundred thousand dollars or more. Each prime contractor's performance report will be classified as to the primary work class being rated. This shall be stated in Section I of the report by listing the major classes of work performed by the contractor e.g., clearing, grading, surfacing, etc.

(2) Performance will be rated under the following headings: Administration, management, and supervision; quality of work; progress of work; and equipment.

(3) The following adjectival ratings are established for performance reports:

(a) Superior	131-150
(b) Above standard	101-130
(c) Standard	100
(d) Below standard	70-99
(e) Inadequate	50-69

(4) The performance report shall be used in evaluating a contractor's prequalification status.

(5) The report shall contain a narrative section which verbally provides the details substantiating the numerical rating. The narrative section shall be based upon documentation prepared during the life of the project, such as the project engineer's diary, the inspector's daily report and other pertinent documents. This documentation shall constitute the major portion of the administrative record to be used for any hearings or litigation that may arise from the rating process.

(6) The performance report will be prepared and discussion held with the contractor by the project engineer. The report will include a numerical rating substantiated by a narrative report which describes the contractor's typical performance. The narrative will reference such documents as will substantiate the given numerical rating.

(7) The report will be endorsed by the region operations engineer or designated assistant who will provide a copy to the contractor.

(8) The contractor may appeal the rating to the region administrator in writing within twenty calendar days of the date the report is received by the contractor. If the report is not delivered to the contractor in person, it shall be forwarded by certified mail with a return receipt requested. The appeal must set forth the specific basis upon which it has been made.

(9) The region administrator or designated assistant will review all contractor performance reports after they have been endorsed and may modify the numerical or narrative rating if such is deemed appropriate. The contractor will be advised of any changes made. The region administrator will be required to make comments thereon only when the contractor's overall performance rating has been rated inadequate, below standard, or superior.

(10) Performance reports, when completed at region level, will be submitted to the secretary, Attn: Manager, contractor prequalification office, not later than forty-five calendar days following final completion of the project.

(11) The region administrator or designated assistant shall review the appeal and provide a written response to the contractor by certified mail (return receipt requested) within twenty calendar days of its receipt. A copy of the appeal and

the response thereto will be forwarded to the secretary, Attn: Contractor prequalification office.

(12) The contractor may further appeal to the secretary in writing setting forth the specific basis for the appeal. The contractor's appeal shall be made within ten calendar days of the date of receipt of the region administrator's response. When making an appeal, the contractor may also present information in person. The secretary will consider the appeal and respond to it by certified mail within sixty calendar days of its receipt. This determination shall be the final administrative act of the department.

(13) All prime contractor performance reports shall be reviewed by the office of the secretary for completeness, objectivity, and substantiation of numerical ratings. The secretary may modify the report as deemed appropriate as a result of the review. The rated contractor and region administrator shall be given a copy of the modified report. The contractor may appeal the modified report in the manner and within the time allotted in subsection (12) of this section to which the secretary shall respond as cited therein.

(14) A prime contractor performance report shall be considered a preliminary paper until all reviews and appeals have been accomplished and it shall have been stamped and initialed as having been "filed in the office of the secretary."

(15) DOT Form 421-010 is authorized.

[Statutory Authority: RCW 47.01.101, 47.28.030, and 47.28.070. 00-14-055, § 468-16-150, filed 7/3/00, effective 8/3/00; 97-09-045 (Order 168), § 468-16-150, filed 4/15/97, effective 5/16/97; 94-05-004, § 468-16-150, filed 2/2/94, effective 3/5/94; 93-03-020 (Order 134), § 468-16-150, filed 1/12/93, effective 2/12/93; 91-04-014 (Order 128), § 468-16-150, filed 1/28/91, effective 2/28/91.]

WAC 468-16-160 Interim reports. (1) Interim performance reports will be completed for contracts of long duration, particularly those in excess of one year and submitted to the contractor prequalification office. They will be completed annually on the anniversary of the start date of the contract. An interim report will also be completed when a contractor's total, overall work has become less than standard and the firm has been advised in writing of such performance. An interim report may never cover a period of more than one year. The report will be used by the secretary as a basis for determining whether a contractor will be placed in conditional status.

(2) In the case of a conditionally qualified firm, an interim report shall be submitted at sixty calendar day intervals for the project being undertaken by that firm subsequent to its being placed in conditional status. When a contractor's overall performance has not been brought up to standard after two consecutive interim reports have been prepared, no further interim reports shall be made except at the written request of the contractor. The date of the report will be the date of the contractor's request.

(3) The project engineer shall submit an interim report when it becomes evident that he or she will no longer be involved in the project, providing that project has been in progress for twenty-five percent of the working days assigned the project or ninety working days whichever is less.

(4) Interim performance reports will supplement and will be made a part of the final performance report.

(2001 Ed.)

(5) The procedures specified in WAC 468-16-150 (5) through (14) are also applicable to the processing of the interim performance report.

(6) DOT Form 421-010 is authorized.

[Statutory Authority: RCW 47.01.101, 47.28.030 and 47.28.070. 97-09-045 (Order 168), § 468-16-160, filed 4/15/97, effective 5/16/97; 94-05-004, § 468-16-160, filed 2/2/94, effective 3/5/94; 93-03-020 (Order 134), § 468-16-160, filed 1/12/93, effective 2/12/93; 91-04-014 (Order 128), § 468-16-160, filed 1/28/91, effective 2/28/91.]

WAC 468-16-170 Refusal to issue proposal. The secretary may refuse to issue a proposal for reasons as enumerated in WAC 468-16-040 through 468-16-070, inclusive. Refusal to issue a proposal may continue in effect until the cause for the refusal has been eliminated. One or more of the following additional conditions may be considered sufficient for refusal to issue a proposal:

(1) The value of outstanding work plus the contract total of the work proposed to be bid exceeds the contractor's maximum capacity rating.

(2) Being placed in conditional status.

(3) Making false, fraudulent, or deceptive statements on the standard questionnaire, related documents, or documents prepared in the course of prosecuting the work.

(4) Debarment or suspension from participation in federal or state projects.

(5) Expiration of qualification.

(6) Failure to update the latest questionnaire to fairly represent the contractor's current organization and financial status.

(7) Bankruptcy.

(8) The existence of any conditions described in WAC 468-16-040 through 468-16-070 inclusive.

[Statutory Authority: RCW 47.01.101, 47.28.030 and 47.28.070. 97-09-045 (Order 168), § 468-16-170, filed 4/15/97, effective 5/16/97; 93-03-020 (Order 134), § 468-16-170, filed 1/12/93, effective 2/12/93; 91-04-014 (Order 128), § 468-16-170, filed 1/28/91, effective 2/28/91.]

WAC 468-16-180 Suspension of qualification. (1) A suspension may be ordered for cause or for a period pending the completion of investigation and any ensuing legal action for revocation of qualification.

(2) The secretary may, upon determination from reports, other documents, or through investigation that cause exists to suspend the qualification of a contractor, impose suspension upon a contractor.

(3) The secretary may suspend qualification for:

(a) Incompetency found detrimental to timely project completion or to the safety of the public or employees.

(b) Inadequate performance on one or more projects.

(c) Infractions of rules, regulations, specifications, and instructions which may adversely affect public health, welfare, and safety.

(d) Uncompleted work which might prevent the prompt completion of other work.

(e) A finding of noncompliance and refusal to agree to take corrective action, and/or failure to implement agreed upon corrective action to comply with equal employment opportunity or women's, minority and disadvantaged business enterprise requirements.

(f) Repeated findings of noncompliance with equal employment opportunity or women's, minority, and disadvantaged business enterprise requirements.

(g) Debarment or suspension from participation in federal or state projects.

(h) Pending completion of debarment proceedings in federal or state projects.

(4) The maximum period of suspension for acts or deficiencies enumerated above are as follows:

(a) For subsection (3)(a) and (e) of this section - Three months.

(b) For subsection (3)(b), (c), (d), and (f) of this section - Six months.

(c) For subsection (3)(g) of this section - For duration of debarment or suspension by the federal or other state agency.

(d) For subsection (3)(h) of this section - Until a determination is made by the federal or other state agency.

(5) The secretary may reduce the period of suspension upon the contractor's supported request for reasons including, but not limited to:

(a) Newly discovered evidence;

(b) Elimination of causes for which the suspension was imposed.

[Statutory Authority: RCW 47.01.101, 47.28.030 and 47.28.070. 97-09-045 (Order 168), § 468-16-180, filed 4/15/97, effective 5/16/97; 94-05-004, § 468-16-180, filed 2/2/94, effective 3/5/94; 93-03-020 (Order 134), § 468-16-180, filed 1/12/93, effective 2/12/93; 91-04-014 (Order 128), § 468-16-180, filed 1/28/91, effective 2/28/91.]

WAC 468-16-190 Revocation of qualification. (1) The secretary, upon determination from reports, other documents, or investigation that cause exists to revoke the qualification of a contractor, may revoke the contractor's qualifications for a maximum period of two years.

(2) The secretary may revoke the qualification of a contractor upon a plea by the firm of nolo contendere, conviction, judgment, or admission for any of the following causes:

(a) Existence of any condition cited in WAC 468-16-050.

(b) Intentional falsification with intent to defraud or unauthorized destruction of project related records.

(3) Revocation of qualification may also be imposed for the following reasons:

(a) Default on a contract within three years prior to the date of application for qualification.

(b) Bankruptcy or insolvency.

(c) Breach of contract.

(d) Having been suspended two or more times within a two-year period.

(4) When qualification has been revoked, a contractor shall be required to reapply for qualification upon again reaching eligibility status.

(5) Revocation of qualification shall be final after twenty calendar days following receipt of notification thereof by certified mail unless a hearing has been requested.

(6) The secretary may reverse the decision to revoke qualifications upon the contractor's supported request for reasons including, but not limited to:

(a) Newly discovered evidence;

(b) Reversal of the conviction or judgment upon which the revocation was based; and

(c) Elimination of causes for which the revocation was imposed.

[Statutory Authority: RCW 47.01.101, 47.28.030 and 47.28.070. 93-03-020 (Order 134), § 468-16-190, filed 1/12/93, effective 2/12/93; 91-04-014 (Order 128), § 468-16-190, filed 1/28/91, effective 2/28/91.]

WAC 468-16-200 Hearings procedure. (1) A contracting firm which has been notified by the secretary that the department is contemplating suspending or revoking its qualification, may request in writing within twenty calendar days of the date of notification by certified mail, that a hearing be conducted. Unless the department is otherwise prohibited from contracting with the contractor, the suspension or revocation shall not become effective until the final decision of the secretary has been rendered. The hearing shall be conducted in accordance with the procedure set forth in this section.

(2) The secretary shall designate a hearing official to conduct any hearing held under this chapter. The hearing official shall furnish written notice by certified mail of a hearing to the contractor and any named affiliates at least twenty calendar days before the effective date of suspension or revocation of qualifications. The notice shall state:

(a) That suspension or revocation of qualification is being considered.

(b) The effective date of the proposed action.

(c) The facts giving cause for the proposed action.

(d) The cause or causes relied upon for proposing the action, i.e., fraud, statutory violations, etc.

(e) If suspension is proposed, the duration of the suspension.

(f) That the contractor may, within twenty calendar days of receipt of the notice, submit to the hearing official by certified mail, return receipt requested, information and argument in opposition to or in clarification of the proposed action.

(g) When the action is based on a conviction, judgment, or admission, fact-finding shall be conducted if the hearing official determines that the contractor's submission raises a genuine dispute over material facts upon which the suspension or revocation is based or whether the causes relied upon for proposing suspension or revocation exist.

(h) The time, place, and date of the hearing.

(i) The name and mailing address of the hearing official.

(j) That proposals shall not be issued nor contracts awarded to the contractor subsequent to the dispatch of the notice of hearing pending the final decision of the secretary.

(3) The hearing official may extend the date of any hearing upon request of the contractor, but the hearing shall not be extended beyond forty-five calendar days from the date of the notice. The hearing official shall schedule and conduct the hearing within thirty calendar days of the date of the notice, except when an extension is granted as provided in this subsection.

(4) In the course of the hearing, the hearing official shall:

(a) Regulate the course and scheduling of the hearings;

(b) Rule on offers of proof, receipt of relevant evidence, and acceptance of proof and evidence as part of the record;

(c) Take action necessary to insure an orderly hearing; and

(d) At the conclusion of the hearing, issue written findings of fact and recommended administrative action to the secretary. The hearing officer shall deliver the entire record to the secretary.

(5) The contractor shall have the opportunity to be present and appear with counsel, submit evidence, present witnesses, and cross-examine all witnesses. A transcribed or taped record shall be made of the hearing unless the secretary and the contractor waive the transcript or taping requirement. The transcript or tape shall be made available, at cost, to the contractor and all named affiliates upon request.

In actions where it has been established by conviction, judgment or admission, or where it has been established by findings made in accordance with this chapter, that the named contractor has engaged in conduct described in WAC 468-16-050 and the sole issue before the hearing official is the appropriateness of revocation of qualification or the length of suspension of qualification to be recommended to the secretary, prior judicial or administrative decision or findings shall not be subject to collateral attack.

The secretary, after receiving the record, findings of fact, and recommendations of the hearing official shall determine the administrative action to be taken. The secretary shall notify the contractor of his determination in writing.

Upon denial, suspension or revocation of prequalification, the respondent may appeal therefrom to the superior court of Thurston County pursuant to RCW 47.28.070. If the appeal is not made within the time prescribed in that statute, the department's action shall be conclusive.

[Statutory Authority: RCW 47.01.101, 47.28.030 and 47.28.070. 93-03-020 (Order 134), § 468-16-200, filed 1/12/93, effective 2/12/93; 91-04-014 (Order 128), § 468-16-200, filed 1/28/91, effective 2/28/91.]

WAC 468-16-210 Prime contractor performance report. (1) The evaluation of contractor performance shall be made on a form substantially in the format as illustrated herein.

(2) A *Prime Contractor Performance Report Manual* provides detailed instructions for preparation of the prime contractor performance report.

**PRIME CONTRACTOR PERFORMANCE REPORT
INSTRUCTIONS**

The Prime Contractor Performance Report, DOT Form 421-010, consists of two parts — page 1 and page 2. Page 1 consists of Sections I, II, and III. Page 2 consists of Sections IV and V. Please note that both pages are four-part forms. After completing all sections, forward the appropriate copies as indicated on the distribution list.

Section I CONTRACTOR DATA

This section denotes the type report being submitted and provides data relating to the contracting firm, its status and supervisors. Interim reports must be submitted annually on the anniversary of the project start date for all projects exceeding a duration of one year.

Section II PROJECT DATA

This section provides basic project data to assist those reviewing or otherwise using the report to place this evaluation in proper perspective with regard to project size, costs, complexity, and completion time. Under Work Class Performed by Contractor, list that work using the general headings in the description of project documents (e.g., preparation, grading, structure, asphalt concrete paving, etc.)

Section III NUMERICAL RATING

This section contains the four weighted rating areas of (A) Administration/Management and Supervision, (Q) Quality of Work, (P) Progress of Work, and (E) Equipment. Each area contains statements which are weighted as to their importance within the rating area. The rater must consider the contractor's merits in relation to each statement by checking the adjectival rating space that best describes the contractor's typical performance for each statement and by assigning an appropriate numerical score in the Rating column, e.g., Supervision and decision making — **Inadeq. 2-3.7; Below Sta. 3.8-4.4; Standard 4.5; Above Sta. 4.6-5.6; Superior 5.7-6.4.*** The rater must enter the chosen score for each statement under the heading Rating, total each area and enter the grand total of all scores. The rater must be as objective as possible. There is only one value for the rating of standard. Standard may be equated with satisfactory. Standard is defined as the performance sufficient to meet the demand, need, or requirement. Those statements warranting an inadequate, below standard, or superior rating require justification in the narrative section of the report. If more space is needed, use additional blank sheets.

*Shaded areas indicate the range of inadequate and superior ratings. Unshaded areas indicate below standard and above standard ranges, which are separated by a line representing a standard rating.

Section IV NARRATIVE RATING

This section is divided into three parts.

- A General Elements — Make any general statements pertinent to reporting the contractor's work activity, e.g., innovativeness in performing the work and any other noteworthy contractor activities.
- B Below Standard Elements — List any actions or activities which substantiate a numerical rating for each statement falling within the range of inadequate or below standard. Each comment must be correlated to identify the rating area and statement number. Each comment must be related to substantiating data reported during the life of the project in the Inspector's Daily Report, Project Engineer's Diary, correspondence, or other pertinent records. This data must be available as a part of the administrative record in the event of hearings or litigation.
- C Superior Elements — Make supportive comments for superior ratings. Substantiation by recorded data should be available in the form of reports, letters, and other documents if not included in diaries and journals.

Comments made in response to B and C above should make reference to documented activities that describe the typical performance of the contractor.

Section V REVIEW AND AUTHENTICATION

This section provides for the recording of the review and authentication of the report by the rater, endorser, and reviewer. Its purpose is to verify that the contractor has been given a copy of the report and that the contractor is aware of his right to appeal. It also serves the purpose of verifying that the report has been reviewed for the purposes of assuring objectivity in its preparation and for the elimination of the influences of personalities. The report will be reviewed by the District Administrator. The District Administrator will enter narrative comments thereon only when the contractor's performance has been rated below standard, inadequate, or superior. The completed report is to be forwarded to the Secretary (Attn: Manager, Precontract Administration) to arrive not later than 45 calendar days after project completion.

DOT 421-010X (Instructions)
Revised 3/93



Prime Contractor Performance Report

Section I Contractor Data		Section II Project Data				
Report type <input type="checkbox"/> Interim <input type="checkbox"/> Final <input type="checkbox"/> Special	Contractor no. (HQ use only)	District	Contract no. FA no.	County	SR	
Company Name		Project title				
Address		Phone no.	Authorized working days	Working days charged	Work starting date	Completion date
Superintendent	Foreman		Contract award amount		Contract completion amount	

Work class performed by contractor:

Description of work:

Section III Numerical Rating

	*Inadequate	*Below Standard	Standard	Above Standard	* Superior	Rating	
A ADMINISTRATION / MANAGEMENT / SUPERVISION							
1 Supervision and decision making	2	3.8	4.5	5.6	6.4		
2 Coordination and communication with subcontractors and suppliers	2	2.2	3.2	4.2	4.8		
3 Submission of documents and reports	1	1.8	2.7	3.5	4.0		
4 Adequacy and timeliness of progress schedules	1	1.8	2.7	3.5	4.0		
5 Public safety and traffic control	2	2.2	3.2	4.4	4.8		
6 Compliance with laws, ordinances and regulations	1	1.2	1.8	2.5	3.0		
7 Maintenance of employee safety standards	1	1.2	1.8	2.5	3.0		
8 Coordination and cooperation with department personnel on project matters	1	1.2	1.8	2.5	3.0		
9 Compliance with EEO, affirmative action requirements and MBE/DBE/WBE requirements	1	1.2	1.8	2.5	3.0		
10 Public relations with the general public, other agencies and adjacent contractors	1	1.4	2.1	2.8	3.0		
Total	13	18	25	34	39		
Q QUALITY OF WORK							
1 Adherence to plans and specifications	10	14.0	20	26	30		
2 Standards of workmanship	8	11.5	16	21	24		
3 Completion of final (punch list) work	2	2.5	4	5	6		
Total	20	28	40	52	60		
P PROGRESS OF WORK							
1 Completion of project within allotted time	9	12.5	18.0	23.5	27.0		
2 Scheduling and execution of schedule	3	4.6	6.6	8.6	9.9		
3 Delivery of materials and supplies	1	1.3	1.9	2.3	2.7		
4 Operation and use of equipment	1	1.3	1.9	2.3	2.7		
5 Use of personnel	1	1.3	1.9	2.3	2.7		
Total	15	21	30	39	45		
E EQUIPMENT							
1 Condition	1	1.5	2.0	2.5	3.0		
2 Maintenance	1	1.5	2.0	2.5	3.0		
Total	2	3	4	5	6		
Grand Total (A+Q+P+E)	(Performance Rating)		50	70	100	130	150
		RANGE	(50-69)	(70-99.9)	(100)	(100.1-130)	(130.1-150)

* Explain any inadequate, below standard, and superior ratings in narrative section.

PERFORMANCE SCORE

HQ use only

Contract No. _____

SECTION IV NARRATIVE RATING

A GENERAL ELEMENTS Enter comments which generally describe the contractor's overall performance and provide background data on the project.

B BELOW STANDARD ELEMENTS Enter comments here to substantiate below standard ratings. (See instructions)

C SUPERIOR ELEMENTS Enter comments here to substantiate superior ratings. (See instructions)

SECTION V AUTHENTICATION AND REVIEW

I certify that I have objectively prepared this report basing it upon data contained in available project records and discussed the report with the contractor.

PROJECT ENGINEER DATE

I have reviewed this report for objectivity and accuracy. I have given a copy of this report to the rated contractor and I have advised the contractor that any appeal must be made within 20 calendar days.

DATE COPY GIVEN/MAILED TO CONTRACTOR OPERATIONS ENGINEER OR DESIGNEE DATE

I have reviewed this Contractor Performance Report and make the following comments and changes as cited herein or on attached sheets.

DISTRICT ADMINISTRATOR DATE

[Statutory Authority: RCW 47.01.101, 47.28.030 and 47.28.070. 94-05-004, § 468-16-210, filed 2/2/94, effective 3/5/94; 91-04-014 (Order 128), § 468-16-210, filed 1/28/91, effective 2/28/91.]

Chapter 468-18 WAC

CITY/COUNTY PROJECT COORDINATION

WAC

468-18-010	Consent by local governing body.
468-18-030	Policy governing use of county roads as haul roads on state highway projects.
468-18-040	Design standards for rearranged county roads, frontage roads, access roads, intersections, ramps and crossings.
468-18-050	Policy on the construction, improvement and maintenance of intersections of state highways and city streets.

DISPOSITION OF SECTIONS FORMERLY CODIFIED IN THIS CHAPTER

468-18-060	Secretary of transportation to proceed with hearings under the Federal Aid Highway Act of 1956. [Statutory Authority: 1977 ex.s. c 151. 79-01-033 (DOT Order 10 and Comm. Order 1, Resolution No. 13), § 468-18-060, filed 12/20/78. Formerly WAC 252-10-105.] Repealed by 99-01-121 (Order 186), filed 12/21/98, effective 1/21/99. Statutory Authority: RCW 47.01.101.
468-18-070	Federal aid urban funds. [Statutory Authority: 1977 ex.s. c 151. 79-01-033 (DOT Order 10 and Comm. Order 1, Resolution No. 13), § 468-18-070, filed 12/20/78. Formerly WAC 252-10-110.] Repealed by 81-15-060 (Order 63), filed 7/20/81. Statutory Authority: RCW 47.04.060.
468-18-080	Policy governing the application of federal aid secondary funds. [Statutory Authority: RCW 47.01.071. 83-13-099 (Order 38, Resolution No. 192), § 468-18-080, filed 6/21/83. Statutory Authority: 1977 ex.s. c 151. 79-01-033 (DOT Order 10 and Comm. Order 1, Resolution No. 13), § 468-18-080, filed 12/20/78. Formerly WAC 252-10-120.] Repealed by 99-01-121 (Order 186), filed 12/21/98, effective 1/21/99. Statutory Authority: RCW 47.01.101.
468-18-090	Matching of urban arterial trust account moneys. [Statutory Authority: RCW 47.01.071. 85-15-080 (Order 48, Resolution No. 246), § 468-18-090, filed 7/22/85. Statutory Authority: 1977 ex.s. c 151. 79-01-033 (DOT Order 10 and Comm. Order 1, Resolution No. 13), § 468-18-090, filed 12/20/78. Formerly WAC 252-10-130.] Repealed by 91-02-006 (Order 125), filed 12/21/90, effective 1/21/91. Statutory Authority: Chapter 47.26 RCW.

WAC 468-18-010 Consent by local governing body.

Consent by local governing body . . . it is the requirement of the state department of transportation that when consent or concurrence is required of any local governing body as to any project or proposal of the state department of transportation, the local body indicate its concurrence, assent or other action regarding such project or proposal by resolution of the governing body of such authority, duly passed at a regular meeting of such body and directed to be transmitted to the state department of transportation.

[Statutory Authority: 1977 ex.s. c 151. 79-01-033 (DOT Order 10 and Comm. Order 1, Resolution No. 13), § 468-18-010, filed 12/20/78. Formerly WAC 252-10-010.]

WAC 468-18-030 Policy governing use of county roads as haul roads on state highway projects. (1) The secretary of transportation or his representative shall, at the time of the preliminary planning for any state highway project requiring the use of any county road or portion thereof as a

(2001 Ed.)

haul road, contact the county officials and advise them that such use is contemplated.

(2) When the final plans for such project are prepared, and prior to advertising for bids, the secretary of transportation or his representative shall meet with the county officials and inform them of the full particulars regarding the intended use of the county road, including estimates of the total yardage involved and the duration of the project.

(3) Before a contract is awarded, the secretary of transportation and the county officials shall sign an agreement setting forth clearly the obligations of the state for defraying added maintenance costs for the county road involved. The agreement shall specifically set forth that the conclusions of the secretary of transportation as to the actual costs to be paid by the state shall be final and conclusive.

(4) Subsequent to the state's contractor having terminated his use of the county road and as soon thereafter as is possible the county shall submit its claim for compensation for additional maintenance and the secretary shall make such review thereof as shall be necessary to ascertain that the state will pay only that portion of the increased maintenance costs occasioned by the state's contractor's use of the county roads.

(5) A special provision in the contract shall specify that the contractor or contractors using the county road as a haul road in connection with the state project shall abide by all weight and speed laws in the operation of his or their equipment and shall be liable for any increased damage to the road by reason of his or their failure to do so.

(6) For administration purposes moneys paid pursuant to the maintenance agreement shall be included as part of the construction project.

[Statutory Authority: 1977 ex.s. c 151. 79-01-033 (DOT Order 10 and Comm. Order 1, Resolution No. 13), § 468-18-030, filed 12/20/78. Formerly WAC 252-10-030.]

WAC 468-18-040 Design standards for rearranged county roads, frontage roads, access roads, intersections, ramps and crossings. Because of the wide variety of rearranged county roads, frontage or access roads, intersections, ramps and crossings encountered by the freeway construction and relocation of other state highways, further understandings are desirable as to the jurisdiction and the responsibility between the county and state.

Following are the criteria, procedure and design standards that the state department of transportation shall use in the planning for frontage roads and access roads that counties will be requested to accept as county roads and the construction of rearranged county roads, intersections, ramps and crossings:

(1) At the early stages of planning, before the right of way maps are prepared, the state and county shall review the proposed improvement.

(2) The proposed design standards shall not be less than the current "Washington state county arterial design standards," except where an individual county shall have adopted a higher design standard, in which case the higher standard shall apply.

(3) The required right of way for the proposed improvement, which shall not be less than that called for by the current "Washington state county arterial design standards,"

shall be either deeded to the county or the county given an easement for rights of way purposes.

(4) The proposed construction shall include all the necessary traffic control and safety devices and be signed in accordance with the Manual on Uniform Traffic Control Devices for Streets and Highways, as modified and adopted by the Washington state department of transportation, to protect the driving public.

(5) An agreement shall be negotiated between the state and county at this early stage of planning, before right of way maps are approved for each rearranged county road, frontage or access road, intersection or crossing, which shall cover the standards of construction, right of way, and outline the responsibility of each agency which shall conform to the following basic principles of maintenance responsibilities:

(a) Where an existing county road is crossed by a state highway underpass, the state will construct the underpass and necessary approaches and maintain the underpass.

The roadway to be provided for county traffic will be constructed by the state.

If illumination exists on the county road at the time of construction of the underpass, the state shall provide the necessary facilities for illuminating the county's portion of the road over the state highway and the necessary approach roadway.

If it is determined that illumination will be necessary at a later date and it will be necessary to place conduits in the structure, the state shall provide same.

The county will maintain the roadway providing for county traffic including traffic stripe, snow removal, sanding and illumination, if needed, for the county road.

(b) Where an existing county road is crossed by a state highway overpass, the state will construct the structure and necessary approach roadway and maintain the structure.

The county will maintain the entire roadway under the structure except special drainage, if needed.

The state shall provide the necessary facilities for illuminating the county's portion of the road under the structure and necessary approach roadway, unless otherwise agreed.

(c) When an existing county road is crossed at grade by a new state highway, the state will assume all costs for the construction including taper sections, acceleration and deceleration lanes and be responsible for all maintenance to the right of way line.

Stop signs after installation shall be maintained in accordance with the state statutes.

The construction and maintenance of illumination will be the responsibility of the state.

When a new county road intersects a state highway, the maintenance responsibilities will be the same as outlined above. The construction costs shall be the responsibility of the county.

(d) Whenever, because of increased traffic, heavy turning movements, accident frequency or other good cause, it becomes necessary to initiate a project for the improvement of an existing intersection not incidental to a construction project, the state and county will cooperate in the cost of the improvement in each case by mutual agreement in accordance with the following formula:

(i) Ascertain the number of legs of the intersection under the existing responsibility of each agency involved.

(ii) Ascertain the traffic volume on each leg.

(iii) Add the traffic counts on each agency's intersection legs.

(iv) The resulting percentage of the traffic volume total falling to each jurisdiction should be the relative proportion of the improvement's cost to be borne by each agency: Provided, That in no case shall the county's share of the total cost of the improvement exceed fifty percent of that cost.

The maintenance responsibilities will be the same as outlined above in subparagraph (c) of this subsection.

(e) When an interchange is constructed at an intersection of a state highway and county road, the ramps, structure and crossroad within the interchange area shall be maintained and reconstructed, if necessary, by the state. Illumination, if required, shall be constructed by the state and that portion located on state right of way maintained by the state or as otherwise agreed.

Traffic signals on state right of way, if required at ramp terminals, shall be constructed, operated and maintained by the state.

(f) Where it is necessary to relocate an existing county road, the state will construct the road and the county will maintain the road.

(g) If a county road or street is dead-ended, the state will construct a cul-de-sac to the county standards.

(h) When it is necessary for the state to construct service roads, landlock prevention roads or dead-end roads, which may be desirable in lieu of damages to property, the provisions of RCW 47.52.105 shall be the guide.

These roads shall be the state's responsibility unless by agreement in accordance with the procedures outlined in the policy statement, the county will accept these roads as county roads and if such an agreement is entered into, all dead-end roads shall have a cul-de-sac constructed to the county's standard.

(i) Upon completion of the construction of each rearranged county road, frontage road, access road, intersection or crossing for which an agreement has been entered into between the state and county, an inspection by the state and county road engineer shall be made to determine that all the requirements of the agreement have been fulfilled. Upon fulfillment of the agreement, the district engineer shall notify the county in writing and the county shall accept the road as a county road or assume the responsibilities as set forth in said agreement.

Within one year the state will turn over the right of way to the county for any construction accepted by the county as a county maintained road.

[Statutory Authority: RCW 47.01.101, 99-01-121 (Order 186), § 468-18-040, filed 12/21/98, effective 1/21/99. Statutory Authority: 1977 ex.s. c 151, 79-01-033 (DOT Order 10 and Comm. Order 1, Resolution No. 13), § 468-18-040, filed 12/20/78. Formerly WAC 252-10-041.]

WAC 468-18-050 Policy on the construction, improvement and maintenance of intersections of state highways and city streets. (1) **Legal reference.** Section 61, chapter 220, Laws of 1949 provides in part as follows: "...; and all such streets including curbs and gutters and street

intersections and such bridges and wharves shall be constructed and maintained by the director from any state funds available therefor.

"The jurisdiction control and duty of the state and city and town with respect to said streets shall be as follows:

"(a)...

"(b) The city and town shall exercise full responsibility for and control over any such street beyond the curbs, and if no curb is installed beyond the portion used for highway purposes."

(2) **The problem.** The construction of partially and fully controlled limited access freeways or similarly designed state highways through cities and towns is becoming more frequent. The construction of cloverleaf and other types of interchanges makes it difficult to determine exactly which features of the interchange constitute the "street intersection" for which responsibility is established by law.

(3) **The policy.** After the access plan for any partial, or fully controlled limited access highway has been approved by a city or town, the state and city authorities shall negotiate an agreement establishing responsibility for construction and maintenance of the various features of each interchange. To illustrate the basic principles of these responsibilities and to serve as a guide in such negotiations, the attached sketches of typical intersections and interchanges are hereby made a part of this policy. The scope of this policy does not include the roadside areas enclosed in the loops or ramps of an interchange or the slopes of cuts and fills, responsibility for which is more clearly defined by statute.

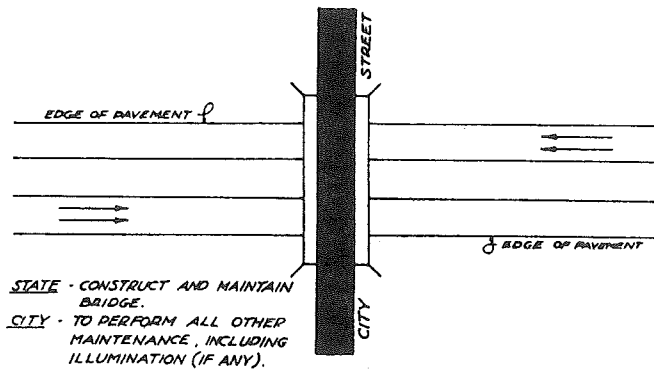

EXISTING CITY STREET CROSSED BY NEW STATE HIGHWAY UNDERPASS

CITY MAINTENANCE OBLIGATION SHOWN IN RED ■

Figure 2

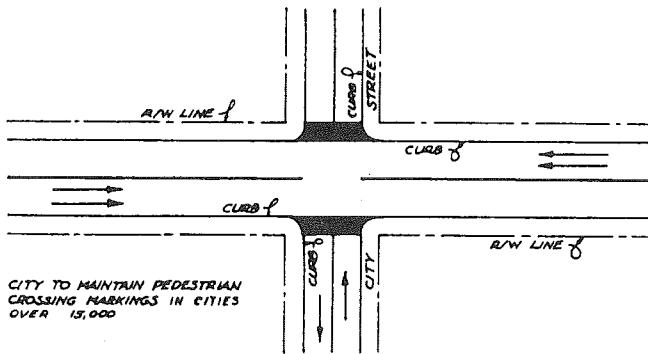

NORMAL INTERSECTION EXISTING STATE HIGHWAY

STATE MAINTENANCE OBLIGATION SHOWN IN GREEN ■ Figure 1

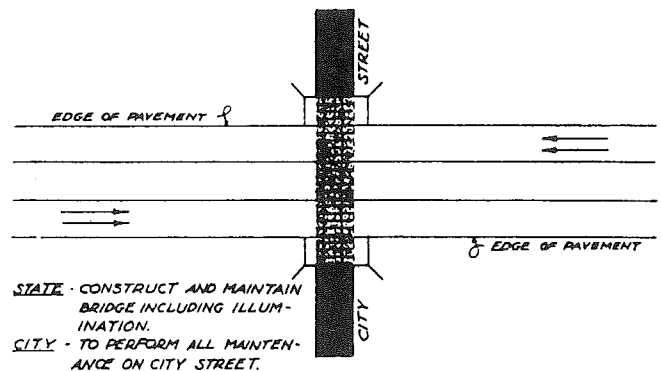

EXISTING CITY STREET CROSSED BY NEW STATE HIGHWAY OVERPASS

CITY MAINTENANCE OBLIGATION SHOWN IN RED ■ Figure 3

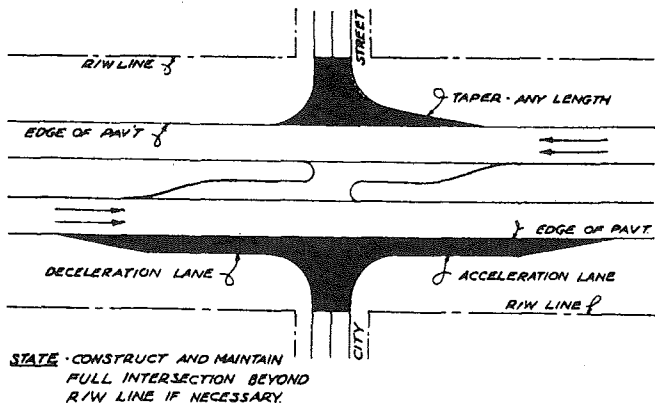

EXISTING CITY STREET CROSSED AT GRADE BY NEW STATE HIGHWAY

STATE MAINTENANCE OBLIGATION SHOWN IN GREEN ■ Figure 4

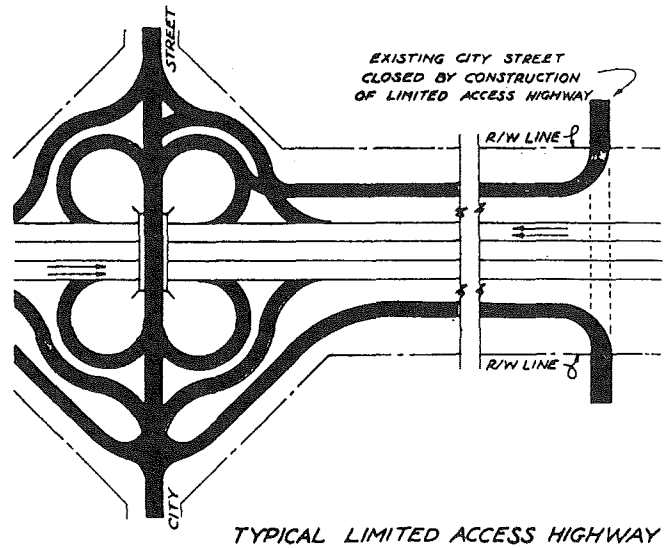

TYPICAL LIMITED ACCESS HIGHWAY

CITY MAINTENANCE OBLIGATION SHOWN IN RED ■ STATE MAINTENANCE OBLIGATION SHOWN IN GREEN ■ Figure 6

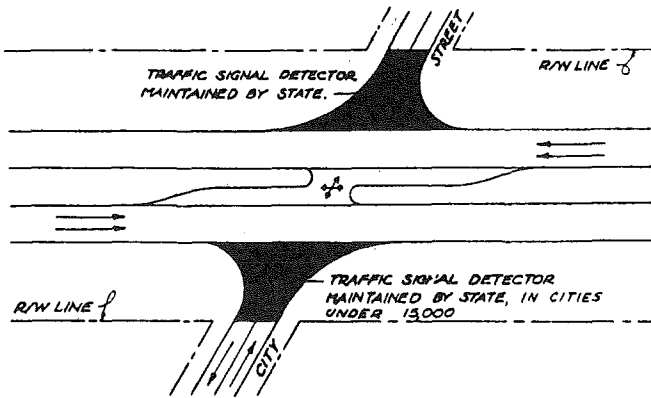

CHANNELIZED INTERSECTION NEW STATE HIGHWAY

STATE MAINTENANCE OBLIGATION SHOWN IN GREEN ■ Figure 5

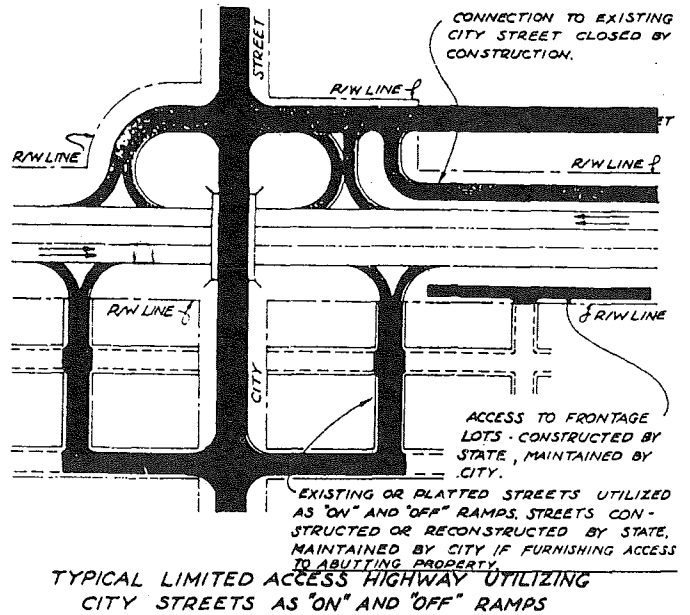

TYPICAL LIMITED ACCESS HIGHWAY UTILIZING CITY STREETS AS "ON" AND "OFF" RAMPS

CITY MAINTENANCE OBLIGATION SHOWN IN RED ■ STATE MAINTENANCE OBLIGATION SHOWN IN GREEN ■ Figure 7

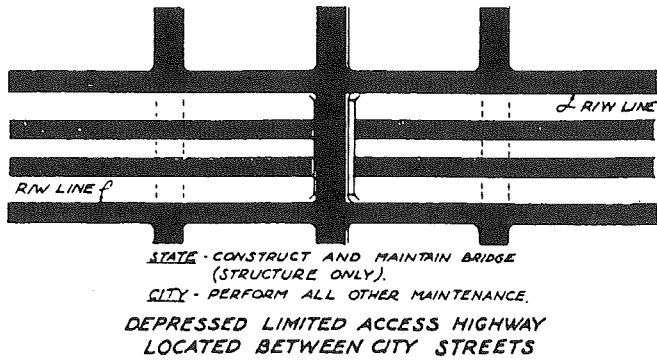

CITY MAINTENANCE OBLIGATION SHOWN IN RED ■
STATE MAINTENANCE OBLIGATION SHOWN IN GREEN ■

Figure 8

On April 30, 1997, the department of transportation and the Association of Washington Cities approved guidelines on the interpretation of selected topics of chapter 47.24 RCW and the above figures for the construction, operation and maintenance responsibilities of the department and cities for city streets that are part of state highways. These guidelines are general in nature and do not preclude the department and individual cities from entering into agreements to address particular circumstances.

[Statutory Authority: RCW 47.01.101. 99-01-121 (Order 186), § 468-18-050, filed 12/21/98, effective 1/21/99. Statutory Authority: 1977 ex.s. c 151. 79-01-033 (DOT Order 10 and Comm. Order 1, Resolution No. 13), § 468-18-050, filed 12/20/78. Formerly WAC 252-10-050.]

**Chapter 468-20 WAC
DISHONORED CHECKS**

WAC
468-20-900 Dishonored checks.

WAC 468-20-900 Dishonored checks. Checks dishonored by nonacceptance or nonpayment; handling fee; liability for interest and collection costs; attorney's fees.

(1) Whenever a check, as defined in RCW 62A.3-104, is dishonored by either nonacceptance or nonpayment for any reason other than by a justifiable stop payment order, the department shall collect from the drawer or maker, in addition to the face amount of the check, a reasonable handling fee, per check, in an amount consistent with current commercial practices but not less than the handling fee authorized in the then current state purchase contract for dishonored check collection services.

(2) When the dishonored check and handling fee have not been paid within fifteen days of the mailing of a notice of dishonor to the drawer or maker at his or her last known address, the drawer or maker shall also be liable for the payment of interest as well as the costs of collection as authorized in statute.

(3) Should the department have to pursue collection of the check through the courts, the drawer or maker may also be liable for reasonable attorneys' fees plus damages as authorized in statute.

[Statutory Authority: RCW 62A3-515 [62A.3-515]. 96-01-090 (Order 159), § 468-20-900, filed 12/19/95, effective 1/19/96. Statutory Authority: RCW

(2001 Ed.)

62A.3-104. 91-02-007 (Order 126), § 468-20-900, filed 12/21/90, effective 1/21/91.]

**Chapter 468-22 WAC
COUNTY FERRY FRANCHISES, TOLLS, AND
FINANCIAL ASSISTANCE**

WAC	Purpose.
468-22-010	Application for franchise.
468-22-020	Review of franchise application by department.
468-22-030	Application for certification of toll changes.
468-22-040	Review of application for certification of toll changes.
468-22-050	Procedures for obtaining financial assistance.
468-22-060	

WAC 468-22-010 Purpose. 23 U.S.C. § 129 and RCW 47.04.140 require that counties operating ferries which receive federal aid under Title 23 of the United States Code must obtain from the department a franchise authorizing such ferry operations and approving their tolls. RCW 47.56.720 and 47.56.725 permit the department to enter into continuing agreements to provide financial assistance for counties operating ferries. The purpose of this chapter is to provide procedures for the granting of such franchises and the provision of such financial assistance.

[Statutory Authority: Chapter 34.05 RCW. 90-19-103 (Order 122), § 468-22-010, filed 9/19/90, effective 10/20/90.]

WAC 468-22-020 Application for franchise. At least ninety days before: Beginning operation of a ferry route; or first applying for federal aid under Title 23 U.S.C. for the construction, reconstruction, or modification of any county-operated ferry or approach(es) thereto, a county shall submit to the State Aid Office of the Department, Transportation Building, Olympia, Washington 98504, an application for a county ferry franchise, on a form obtainable upon request from the department. The county shall include with its application:

- (1) A map showing the location of the existing or proposed ferry route(s);
- (2) A schedule of proposed tolls and charges for the existing or proposed ferry route(s), together with a proposed revenue and expenditure statement;
- (3) A certification that the proposed ferry route(s) is/are not otherwise served by adequate transportation facilities; and
- (4) A certification that the proposed tolls and charges are consistent with the requirements of RCW 47.04.140(2) and 23 U.S.C. § 129.

[Statutory Authority: Chapter 34.05 RCW. 90-19-103 (Order 122), § 468-22-020, filed 9/19/90, effective 10/20/90.]

WAC 468-22-030 Review of franchise application by department. The department shall review a county's application for a ferry franchise, together with any accounting data required by WAC 468-22-060(3). If the department finds that the ferry route(s) described in the application is/are not otherwise served by adequate transportation facilities; and that the proposed tolls and charges are consistent with the requirements of RCW 47.04.140(2) and 23 U.S.C. § 129, it shall issue:

(1) A county ferry franchise for the operation of such route(s); and

(2) A toll certification, within sixty days of its receipt of the county's application.

[Statutory Authority: Chapter 34.05 RCW. 90-19-103 (Order 122), § 468-22-030, filed 9/19/90, effective 10/20/90.]

WAC 468-22-040 Application for certification of toll changes. All counties possessing current ferry franchise(s) shall submit to the state aid office of the department an application for certification of toll changes at least sixty days before implementation of any changes in tolls and charges for its route(s). Application shall be made on a form obtainable upon request from the department. The county shall include with its application:

(1) Schedules of both existing and proposed tolls and charges; and

(2) A certification that the proposed tolls and charges are consistent with the requirements of RCW 47.04.140(2) and 23 U.S.C. §129.

[Statutory Authority: Chapter 34.05 RCW. 90-19-103 (Order 122), § 468-22-040, filed 9/19/90, effective 10/20/90.]

WAC 468-22-050 Review of application for certification of toll changes. The department shall review a county's application for certification of toll changes, together with any accounting data required by WAC 468-22-060(3). If the department finds that the proposed tolls and charges are consistent with the requirements of RCW 47.04.140(2) and 23 U.S.C. §129, it shall issue a new toll certification. If the department finds that the proposed tolls and charges are not consistent with the requirements of RCW 47.04.140(2) and 23 U.S.C. §129, it shall:

(1) So advise the county within thirty days of its receipt of the county's toll change application; and

(2) Cancel the county's toll certification, until it receives a revised schedule of proposed tolls which is consistent with the requirements of RCW 47.04.140(2) and 23 U.S.C. §129 after which it shall issue a new toll certification.

[Statutory Authority: Chapter 34.05 RCW. 90-19-103 (Order 122), § 468-22-050, filed 9/19/90, effective 10/20/90.]

WAC 468-22-060 Procedures for obtaining financial assistance. To obtain financial assistance for a ferry or ferry system under RCW 47.56.720 or 47.56.725, a county and the department shall comply with the following procedures:

(1) Before receiving financial assistance, a county shall sign an agreement with the department, the form of which shall be agreed upon between the department, and the county.

(2) County requests for reimbursement and department payments to counties shall be made in the manner specified in the agreement for financial assistance.

(3) No later than September 1 of each year, a county shall provide to the department, on a form prescribed by the department, a complete accounting of that county ferry's toll revenues and operation and maintenance expenditures for the previous state fiscal year.

[Statutory Authority: Chapter 34.05 RCW. 90-19-103 (Order 122), § 468-22-060, filed 9/19/90, effective 10/20/90.]

Chapter 468-30 WAC HIGHWAY PROPERTY

WAC

468-30-010	Policy and procedure for handling assessments against state highway lands.
468-30-020	Policy for the control of irrigation waste waters encroaching upon highway rights of way.
468-30-040	Use of space beneath limited access facilities in cities and towns.
468-30-050	Policy relative to granting and maintaining road approaches to state highway system.
468-30-060	Rental of state highway lands and improvements.
468-30-070	Procedure for transfer of abandoned state highways to counties.
468-30-075	Procedure for transfer of abandoned state highways to cities and towns.
468-30-080	Policy and procedure for sales of personalty.
468-30-100	Policy relative to the installation of signs and markings on state highway rights of way.
468-30-110	Nonhighway use of airspace on state highways.
468-30-120	Surplus property sales in agricultural zoned areas.

DISPOSITION OF SECTIONS FORMERLY CODIFIED IN THIS CHAPTER

468-30-030	Prohibition of fishing from bridges. [Statutory Authority: 1977 ex.s. c 151. 79-01-033 (DOT Order 10 and Comm. Order 1, Resolution No. 13), § 468-30-030, filed 12/20/78. Formerly WAC 252-12-025.] Repealed by 98-18-003 (Order 182), filed 8/20/98, effective 9/20/98. Statutory Authority: RCW 34.05.354 and 47.01.101.
468-30-090	Designation of official custodian of right of way maps. [Statutory Authority: 1977 ex.s. c 151. 79-01-033 (DOT Order 10 and Comm. Order 1, Resolution No. 13), § 468-30-090, filed 12/20/78. Formerly WAC 252-12-070.] Repealed by 81-19-053 (Order 66), filed 9/11/81. Statutory Authority: RCW 47.01.101(5).

WAC 468-30-010 Policy and procedure for handling assessments against state highway lands. (1) The secretary of transportation is the "chief administrative officer" of the department of transportation as that phrase is applied in chapter 79.44 RCW. The secretary of transportation is also the "agency head" as that phrase is applied in chapter 82-12 WAC.

(2) Whenever real property or real property rights are acquired all interests in the real property or real property rights shall be discharged as authorized by law. If any assessing entity may in the course of its operation assess for the maintenance, operation, or any function of the assessing entity subsequent to acquisition, the present value of those subsequent assessments shall be determined by the parties and that amount paid in exchange for a deed releasing the real property or real property interests from all subsequent assessments by the assessing entity and an order entered in the records of the assessing entity to that same effect.

(3) Whenever any assessing district as defined and provided in chapter 79.44 RCW seeks to include any real property or real property interests of the department of transportation the department shall proceed as authorized by law. If any assessing district may assess further for the maintenance, operating, or any function of the assessing district, the present value of those subsequent assessments shall be determined by the parties and that amount paid in exchange for a deed releasing the real property or real property interests from all subsequent assessments by the assessing district and an order entered in the records of the assessing district to that same effect.

(4) Whenever the department of transportation holds any real property or real property interests which are subject to future assessments by an assessing entity the present value of those subsequent assessments shall be determined by the parties and that amount paid in exchange for a deed releasing the real property or real property interests from all subsequent assessment by the assessing entity and an order entered in the records of the assessing district to that same effect.

(5) Whenever any assessing district as defined in chapter 73.44 RCW refuses to release future assessments by payment in advance, the assessments may be paid annually.

[Statutory Authority: 1977 ex.s. c 151. 79-01-033 (DOT Order 10 and Comm. Order 1, Resolution No. 13), § 468-30-010, filed 12/20/78. Formerly WAC 252-12-010.]

WAC 468-30-020 Policy for the control of irrigation waste waters encroaching upon highway rights of way. (1) When the United States bureau of reclamation or irrigation districts must permit their irrigation waste waters to encroach upon or cross highway rights of way in carrying them to a natural drainage channel or an established waterway or drainage ditch, said bureau of reclamation or irrigation districts shall request permission to do so under the provisions of chapter 47.44 RCW.

(2) Discharge of irrigation waste waters into normal highway ditches will not be tolerated. Property owners will not be permitted to carry waste waters in laterals paralleling and within highway rights of way.

[Statutory Authority: 1977 ex.s. c 151. 79-01-033 (DOT Order 10 and Comm. Order 1, Resolution No. 13), § 468-30-020, filed 12/20/78. Formerly WAC 252-12-020.]

WAC 468-30-040 Use of space beneath limited access facilities in cities and towns. See WAC 468-58-040.

[Statutory Authority: 1977 ex.s. c 151. 79-01-033 (DOT Order 10 and Comm. Order 1, Resolution No. 13), § 468-30-040, filed 12/20/78. Formerly WAC 252-12-030 and 252-20-035.]

WAC 468-30-050 Policy relative to granting and maintaining road approaches to state highway system. (1) Approaches granted by right of way negotiation shall include in the instrument a provision that the approach shall be maintained by the grantee outside the shoulder line of the highway. This shall obtain irrespective of whether the state constructs the approach or not.

(2) Approaches granted by permit shall continue to be maintained outside the highway shoulder line by the holder of the permit.

(3) Existing structures, which have been granted under permit but which may be reconstructed by the state with the reconstruction of the highway, shall be maintained by the property owner and provision for such maintenance shall be set forth in the new permit or right of way instrument providing for the approach reconstruction. This is applicable to approaches which have developed but which are not covered by permit or right of way negotiation.

(4) Existing approaches outside the shoulder of the highway which were constructed by the state under a provision of a right of way transaction without mention of maintenance

(2001 Ed.)

and which have previously been maintained by the state shall hereafter be maintained by the abutting property owner.

(5) Approaches to limited access highways shall be to frontage roads where provided and only to the main roadway where this is specifically intended under the plan showing access for the particular section within which the approach is located.

[Statutory Authority: 1977 ex.s. c 151. 79-01-033 (DOT Order 10 and Comm. Order 1, Resolution No. 13), § 468-30-050, filed 12/20/78. Formerly WAC 252-12-040.]

WAC 468-30-060 Rental of state highway lands and improvements. (1) All improved property acquired by the department of transportation for future transportation purposes may be rented to the occupying owner or tenant (initial displacee) for a period of up to ninety days. If the improvement is deemed unrentable or does not meet DS & S standards, there are no further rentals. The improvement is then scheduled for sale and removal or demolition. Other improvements may be rented to subsequent tenants on a month-to-month basis until the property is required by pending construction. In no event shall the property be rented to the original displacee beyond the initial ninety day period unless there are extenuating circumstances and prior written approval of the chief right of way agent.

(2) Leases and rental agreements in furtherance of the policy set forth in subsection (1) of this section and pursuant to authority contained in chapter 162, Laws of 1949, shall be negotiated by the land management branch of the department of transportation where directed by the secretary of transportation. Said division shall prepare all necessary documents to accomplish such leases and shall submit same to the secretary for action thereon as indicated in subsection (4) of this section.

(3) The rental rates are based on the following:

(a) The rental rate is economic rent as determined by either a market data report of rentals or a written determination by appraisal.

(b) For those rentals subject to excise tax under the provisions of chapter 82.29A RCW, the tax is payable in addition to the determined rental rate.

(c) The rental rate is evaluated as economic conditions require, but no more often than once per year.

(d) Where the acquired improvement is tenant occupied, the rental rate in effect at the time of acquisition shall continue for ninety days. Thereafter the rental rate shall be economic rent. Should the tenant be paying more than economic rent, the rent is to be immediately lowered to economic rent.

(e) The rent for the first month (pay period) is calculated and adjusted to the next closest first or fifteenth day. This adjusted rent and the last month's (pay period) rent are payable upon execution of the rental agreement.

(4) Authority to approve rental agreements:

(a) All rental agreements in which the rental rate equals or exceeds the "minimum standard rental rates" of the applicable provisions of subsection (3) of this section may be approved by the secretary of transportation or his designee.

(b) The following described agreements (i) and (ii) will not be considered under the provisions of subsection (3) of

this section and may be approved by the secretary of transportation.

(i) Interim possession agreements—Interim agreements will give possession to a prospective air space lessee during the period prior to the formalization and approval of an air space lease. The agreements will provide interim rental at a negotiated figure and will be terminable on thirty days' notice.

(ii) Mutual benefits possession agreements—Mutual benefits possession agreements will involve those properties where the benefits to the state will equal those derived by the lessee and will be terminable on thirty days' notice. The value of mutual benefit will be determined by the secretary or his designee.

(5) Leases and rental agreements shall be subject to termination on a maximum of sixty days' written notice, provided, that the secretary or his designee may approve time extensions in specific cases.

[Statutory Authority: RCW 47.12.120 and 47.01.101(5). 86-18-039 (Order 104), § 468-30-060, filed 8/28/86. Statutory Authority: RCW 47.12.120. 83-19-012 (Order 82), § 468-30-060, filed 9/12/83. Statutory Authority: 1977 ex.s. c 151. 79-01-033 (DOT Order 10 and Comm. Order 1, Resolution No. 13), § 468-30-060, filed 12/20/78. Formerly WAC 252-12-050.]

WAC 468-30-070 Procedure for transfer of abandoned state highways to counties. A public highway which is or has been a part of the route of a state highway and is no longer necessary as such may be certified to the county in which it is located in the following manner:

The state aid engineer shall notify the affected board of county commissioners and the county engineer of any certifications anticipated for the ensuing calendar year not later than August 1 of the previous year, so that the county may provide in its budget for the maintenance and/or reconstruction of roads which are transferred to it by the department of transportation in accordance with RCW 36.75.090.

(1) When a tentative date has been determined on which the transfer of the highway is to be made, the district engineer shall arrange for a joint maintenance inspection by representatives of the highway department and the county.

(2) The highway department shall be represented by the district state aid engineer and the district maintenance engineer or his designated representative.

(3) The county shall be represented by the county road engineer and his maintenance engineer, supervisor or designated representative.

(4) Any and all routine maintenance deficiencies which are noted at the time of this inspection shall be corrected by the district maintenance forces.

(5) Upon completion of any maintenance work deemed necessary, the district engineer shall by letter inform the county engineer to the effect that all maintenance deficiencies noted during the inspection have been corrected.

(6) The county engineer shall by letter subsequently inform the district engineer that the road or highway to be transferred is either (a) in a condition acceptable to the county, or (b) in a condition not acceptable to the county, in which case the unacceptable conditions shall be enumerated in detail.

(7) In the event that the district engineer feels that additional maintenance work is required, he shall direct such work to be done and again follow the procedure outlined in subsection (5) of this section; and the county engineer shall then follow the procedure outlined in subsection (6) of this section.

(8) In the event that it becomes impossible for the district and the county to reach agreement, a full report of the initial inspection and the apparent points of disagreement shall be transmitted to the state aid engineer, who will then consult with the state maintenance engineer and the county engineer and provide the director with all significant information and with his own recommendations.

(9) The secretary of transportation will take final action on the transfer of the road and the county shall be provided with a copy of his decision two weeks before the certification is made.

(10) After the certification has been made, the state will provide the county with all available maps, conveyances, permits, franchises and other documents which may relate to that portion of the road or highway transferred.

Maintenance is described as being the preservation and upkeep of a highway, including all of its elements, in as nearly its original, or as constructed, or as subsequently improved, condition as possible. This includes traffic control devices and other safety control measures deemed necessary.

[Statutory Authority: 1977 ex.s. c 151. 79-01-033 (DOT Order 10 and Comm. Order 1, Resolution No. 13), § 468-30-070, filed 12/20/78. Formerly WAC 252-12-055.]

WAC 468-30-075 Procedure for transfer of abandoned state highways to cities and towns. A public highway which is or has been a part of the route of a state highway and is no longer necessary as such may be certified to the city or town in which it is located in the following manner:

The state aid engineer shall notify the affected legislative body and the city or town engineer of any certifications anticipated for the first half of July of the ensuing calendar year not later than August 1 of the previous year, so that the city or town may provide in its budget for the maintenance and/or reconstruction of roads which are transferred to it by the department of transportation in accordance with RCW 36.75.090 and 47.24.010.

(1) The department of transportation shall make such certifications between the first and fifteenth of July each year. A reasonable time prior to the certification of a highway, the district administrator shall arrange for a joint maintenance inspection by representatives of the transportation department and the city or town.

(2) The transportation department shall be represented by the district state aid engineer and the district maintenance engineer or his designated representative.

(3) The city or town shall be represented by the city or town engineer and his maintenance engineer, supervisor or designated representative.

(4) Any and all routine maintenance deficiencies which are noted at the time of this inspection shall be corrected by the district maintenance forces or by contract.

(5) Upon completion of any maintenance work deemed necessary, the district administrator shall by letter inform the

city or town engineer to the effect that all maintenance deficiencies noted during the inspection have been corrected.

(6) The city or town engineer shall by letter subsequently inform the district administrator that the road or highway to be transferred is either (a) in a condition acceptable to the city or town or (b) in a condition not acceptable to the city or town in which case the unacceptable conditions shall be enumerated in detail.

(7) In the event that the district administrator feels that additional maintenance work is required, he shall direct such work to be done and again follow the procedure outlined in subsection (5) of this section; and the city or town engineer shall then follow the procedure outlined in subsection (6) of this section.

(8) In the event that it becomes impossible for the district and the city or town to reach agreement, a full report of the initial inspection and the apparent points of disagreement shall be transmitted to the state aid engineer, who will then consult with the state maintenance engineer and the city or town engineer and provide the secretary with all significant information and with his own recommendations.

(9) The secretary of transportation will take final action on the transfer of the road and the city or town shall be provided with a copy of his decision two weeks before the certification is made.

(10) After the certification has been made, the state will provide the city or town with all available maps, conveyances, permits, franchises and other documents which may relate to that portion of highway transferred.

Maintenance is described as a program to preserve and repair a system of roadways together with its elements to ensure its designed or established structural life and operational expectancy. This includes traffic control devices and other safety control measures deemed necessary.

[Statutory Authority: Chapter 34.04 RCW, 79-09-044 (Order 35), § 468-30-075, filed 8/20/79.]

WAC 468-30-080 Policy and procedure for sales of personalty. Whenever the department of transportation shall have acquired any lands, except state granted lands, upon which are located any structures, timber or other thing of value attached to the land, same may be severed from the land and sold at public auction subject to the following guidelines:

(1) Such items of value may be approved for sale at public auction or for removal by demolition under contract procedures approved by the secretary of transportation.

(2) Authorized sales of personalty shall be made by the department of transportation acting through the secretary of transportation at public auction upon a date, place and hour to be set by the secretary.

(3) The authorization for sale shall include a minimum price at which any item or items may be sold.

(4) Notice of sale shall be given as follows:

(a) By publishing notice of the time and place of sale two successive times with an interval of one week between publications, in any daily or weekly newspaper of general circulation published in the county in which the sale is to take place. If there is no legal newspaper published in the county, then such notice shall be published in the legal newspaper published in this state nearest to the place of sale.

(2001 Ed.)

(b) The notice shall describe with reasonable particularity each item of property to be sold, shall state the location at which said property can be viewed, shall state the date, time and place at which the auction is to be held, and shall be signed by the secretary of transportation or such other person as he may designate.

(5) All items sold shall be removed from the right of way or premises of the department of transportation within a maximum period of sixty days following sale, provided, that the secretary of transportation may increase said maximum period when in his judgment it would not be practical to make such removal within sixty days.

(6) The secretary of transportation is authorized at his discretion to include as a condition of any sale a requirement that the purchaser provide a surety deposit guaranteeing satisfactory performance in removal of the item purchased and correction of all unsightly or hazardous conditions caused by such removal, and the secretary is further authorized to determine the amount of deposit to be required.

(7) If a minimum price shall have been set and the highest bid at the auction is less than such minimum, one of the following alternative procedures shall be pursued:

(a) When time permits, the building shall be readvertised for sale at a later date and this shall be announced to the bidders immediately.

(b) If the building cannot be readvertised due to the imminence of construction, the bidders shall be advised immediately of the minimum acceptable bid and that a sale will be made to the first responsible bidder offering the minimum bid plus the required deposit.

[Statutory Authority: 1977 ex.s. c 151, 79-01-033 (DOT Order 10 and Comm. Order 1, Resolution No. 13), § 468-30-080, filed 12/20/78. Formerly WAC 252-12-060.]

WAC 468-30-100 Policy relative to the installation of signs and markings on state highway rights of way. No permits shall hereafter be issued for the installation of signs and markings other than traffic control signs and state historical markers on state highway rights of way. Traffic control signs shall be consistent with the manual on Uniform Traffic Control Devices for Streets and Highways, as modified and adopted by the department of transportation.

[Statutory Authority: 1977 ex.s. c 151, 79-01-033 (DOT Order 10 and Comm. Order 1, Resolution No. 13), § 468-30-100, filed 12/20/78.]

WAC 468-30-110 Nonhighway use of airspace on state highways. (1) Definitions:

(a) "Airspace" is that space located above, at or below the highway's established gradeline lying within the approved right of way limits.

(b) "Department" is the Washington state department of transportation.

(2) Any use of such space shall be subject to approval of the Federal Highway Administration.

(3) Any use of such space shall be subject to compliance with all applicable city, town or county zoning requirements.

(4) Any application to the department for the lease of such space shall describe in detail the use to be made of such space and the physical facilities to be installed and maintained on state right of way.

(5) The lessee shall be solely responsible and shall hold the state harmless for liability for any and all damage to persons or to public or private property that may result from or be caused by the use of such space or from the erection or maintenance of any structure or facility upon the highway right of way. The lessee shall be liable to the department for any moneys expended by it for the protection or repair of any state facility required as a result of any such use.

(6) The lessee shall be required to carry liability and property damage insurance in amounts required by the department.

(7) No use of such space shall be allowed which subjects the highway facility or the public to undue risk or impairs the use of the facility for highway purposes.

(8) Use of such space shall be covered by a properly executed airspace lease.

(9) Consideration for occupancy:

(a) Where the airspace can be developed and used as an entity the consideration shall be economic rent.

(b) Where the proposed use of the airspace is in conjunction with an abutting tract, rent shall be based on its contribution value to the abutting property but not less than economic rent.

(c) When the use of the property constitutes a highway purpose the rent may be offset in part or in whole with other valuable considerations as determined by the department.

(10) The granting of any use of such space shall be subject to the discretion of the department and upon such terms and conditions in addition to those stated herein as it shall deem proper.

(11) No assignment of any lease by the lessee shall be of any force and effect unless prior written approval of such assignment has been given by the department.

[Statutory Authority: RCW 47.01.101(5) and 47.12.120. 81-19-052 (Order 65), § 468-30-110, filed 9/11/81.]

WAC 468-30-120 Surplus property sales in agricultural zoned areas. Priority consideration shall be given to abutting property owners in agricultural zoned areas.

(1) A written notice and offer to sell shall be sent by certified mail to the abutting owner as shown on the records of the county assessor.

(2) The abutting owner shall have thirty days after receiving notice of the proposed sale to respond in writing to the department's offer to sell.

(3) If the abutting owner rejects the state's offer or does not respond in writing within the thirty-day period, the department may then dispose of the property pursuant to RCW 47.12.063.

(4) If there is more than one abutting owner, then the procedures in RCW 47.12.063 (2)(f) shall apply.

(5) Sales to abutting property owners may at the department's option be for cash or by real estate contract.

[Statutory Authority: RCW 47.12.063 and 47.01.101(5). 89-01-052 (Order 118), § 468-30-120, filed 12/15/88.]

[Title 468 WAC—p. 42]

Chapter 468-32 WAC SAFETY REST AREAS

WAC

468-32-010 Rest area rules.

WAC 468-32-010 Rest area rules. Pursuant to chapter 47.38 RCW, the purpose of these regulations is for the safety of the traveling public by governing the conduct and use of safety rest areas. The following restrictions apply to activities in safety rest areas:

(1) Parking is only permitted in designated areas;

(2) Litter containers are only for picnic and automobile litter;

(3) Pets shall stay in designated areas and shall be on a leash at all times;

(4) Open fires are prohibited;

(5) Aggressive solicitation for money or goods with the intent to intimidate another person into giving money or goods is prohibited; and

(6) Sanitary disposal systems are for dumping sanitary wastes only from recreational vehicles. Commercial vehicles are prohibited from using the sanitary disposal systems.

[Statutory Authority: Chapter 47.38 RCW. 95-07-106 (Order 150), § 468-32-010, filed 3/20/95, effective 4/20/95.]

Chapter 468-34 WAC

UTILITY LINES—FRANCHISES AND PERMITS

WAC

468-34-010	Applications.
468-34-020	Costs.
468-34-030	Determination of need for franchise hearing.
468-34-040	Franchise hearings.
468-34-050	Notice of filing.
468-34-060	Protests.
468-34-070	Uncontested applications.
468-34-080	Procedure on protests.
468-34-090	Hearing officers.
468-34-100	Policy on accommodation of utilities on highway rights of way.
468-34-110	Definition of terms.
468-34-120	Application of policy to various types of right of way.
468-34-130	Location.
468-34-140	Utility tunnels and bridges.
468-34-150	Design.
468-34-160	Permits and franchises.
468-34-170	Permits and franchises—Contents.
468-34-180	Accommodation where prior right.
468-34-190	Pipelines—Location and alignment.
468-34-200	Pipelines—Cover.
468-34-210	Pipelines—Encasement.
468-34-220	Pipelines—Appurtenances.
468-34-230	Pipelines—Uncased carriers.
468-34-240	Pipelines—Restrictions against varied use.
468-34-250	Pipelines—Installation.
468-34-260	Pipelines—Adjustment.
468-34-270	Installations on highway structures.
468-34-280	Overhead power and communication lines—Type of construction.
468-34-290	Vertical clearance.
468-34-300	Overhead lines—Location.
468-34-310	Underground power and communication lines.
468-34-320	Conversion to underground or relocation of overhead lines—Responsibility.
468-34-330	Scenic enhancement.
468-34-340	Miscellaneous.
468-34-350	Control zone guidelines.

WAC 468-34-010 Applications. Applications for franchises and permits submitted to the Washington state depart-

ment of transportation shall conform with the following requirements:

(1) Applications shall be submitted upon forms available from the department.

(2) Applications shall include the utility facility description plus additional plans and data for CAT 1 and CAT 2 installations.

(3) Applications shall indicate compliance with the standards as set forth in the POLICY ON ACCOMMODATION OF UTILITIES ON HIGHWAY RIGHTS OF WAY as contained in these rules and any amendments thereto.

(4) The application shall discuss alternate possibilities, especially when a location on or across a limited access facility is considered necessary. Reasons for need to adhere to location as proposed must be adequately set forth in the application.

[Statutory Authority: Chapter 47.44 RCW. 95-21-037 (Order 152), § 468-34-010, filed 10/10/95, effective 11/10/95. Statutory Authority: 1977 ex.s. c 151. 79-01-033 (DOT Order 10 and Comm. Order 1, Resolution No. 13), § 468-34-010, filed 12/20/78. Formerly WAC 252-04-010.]

WAC 468-34-020 Costs. (1) The applicant shall pay the reasonable cost to the department for investigating, handling and granting the franchise or permit, including but not limited to fees of hearing officers and reporters, including basic overhead charges upon the application and for providing an inspector during construction and/or maintenance of the utility facility as follows:

For permit/franchise/amendment	
Category 1	\$500.00
Category 2	\$300.00
Category 3	\$150.00
For franchise consolidation	\$300.00
For franchise renewal	\$250.00
For franchise assignment	\$50.00

together with an additional charge in the amount of expenses, if any, actually incurred by the department: Provided, That no charge shall be made for applications for franchise or permit where the applicant is the United States or any of its agencies, or a utility anticipating relocation from its private easement acquired or to be acquired by the department for construction or reconstruction of a state highway.

(2) An equitable portion of the added costs of design and construction of highway structures shall be charged to any utility company which is required to pay the costs of relocation of its facilities and/or to any utility company making new installations.

(3) Before any construction work is started, a surety bond in an amount required by the department, but not less than one thousand dollars, written by a surety company authorized to do business in the state of Washington, may be required by the department to insure completion of construction, including the restoration of surfacing, slopes, slope treatment, top soil, landscape treatment, drainage facilities and cleanup of right of way for a period ending not more than one year after date of completion, except the applicant shall be required to maintain an individual bond for a period to two years after date of completion where the utility facility disturbs the traveled lanes or usable shoulder. A blanket surety

bond may be maintained covering multiple franchises or permits in lieu of individual bonds at the department's discretion. A blanket surety bond shall be in an amount of not less than ten thousand dollars.

[Statutory Authority: Chapter 47.44 RCW. 95-21-037 (Order 152), § 468-34-020, filed 10/10/95, effective 11/10/95; 89-05-022 (Order 119), § 468-34-020, filed 2/10/89. Statutory Authority: 1977 ex.s. c 151. 79-01-033 (DOT Order 10 and Comm. Order 1, Resolution No. 13), § 468-34-020, filed 12/20/78. Formerly WAC 252-04-020.]

WAC 468-34-030 Determination of need for franchise hearing. (1) Upon the filing of an application for franchise, the department shall determine whether the work involved with the franchise may:

(a) During construction, significantly disrupt the flow of traffic or use of driveways or other facilities within the right-of-way; or

(b) During or following construction, cause a significant and adverse effect upon the surrounding environment, in order to determine whether a hearing or hearing opportunity is required.

(2) If the department deems it to be in the public interest a hearing or hearing opportunity may be required for any franchise application. A hearing or hearing opportunity will normally be required for a franchise which involves any of the following:

(a) Overhead transmission lines in excess of 35 kV;

(b) Facilities involving the installation of pipe larger than eighteen inches nominal diameter;

(c) Conduits requiring an excavation wider than three feet;

(d) Pipelines carrying transmittants which are flammable, corrosive, expansive, energized or unstable and are larger than four inches nominal diameter;

(e) Pressurized carrier pipes larger than twelve inches nominal diameter;

(f) Underground installations of any size that require excavation through landscaped areas which are authorized by permit and which are maintained by owners of abutting property.

(3) The department may dispense with holding a hearing where the planned facility has already been or is the subject of environmental land use or other hearings or where the applicant presents evidence of a direct contact with owners of abutting property.

(4) Those franchise applications which the department determines warrant a hearing or hearing opportunity shall be processed in accordance with WAC 468-34-040 through 468-34-090. All other franchise applications may be approved by the department without being processed in accordance with WAC 468-34-040 through 468-34-090, including franchises previously filed but not advertised.

[Statutory Authority: Chapter 47.44 RCW and 1980 c 28. 80-13-042 (Order 58), § 468-34-030, filed 9/15/80.]

WAC 468-34-040 Franchise hearings. Arrangements for a hearing before the secretary of transportation or his designee at the earliest possible date will be made by the department on any matters with respect to which a protest has been filed. Based on written objections or disputes which the

department is unable to resolve or upon which it may have a divergent recommendation, the applicant and/or affected parties will be given the opportunity to appear before the secretary or his designee in support of their requests or contentions.

[Statutory Authority: 1977 ex.s. c 151. 79-01-033 (DOT Order 10 and Comm. Order 1, Resolution No. 13), § 468-34-040, filed 12/20/78. Formerly WAC 252-04-040.]

WAC 468-34-050 Notice of filing. Upon the filing of application for franchise, the department shall cause notice thereof to be given in the county or counties in which any portion of the highway upon which the franchise applied for is located, at the expense of the applicant, by publishing a notice once a week for two consecutive weeks, in a newspaper having a general circulation in such county or counties. The notice shall state the name of the applicant and a description of the state highway or part thereof over which the franchise application extends.

[Statutory Authority: Chapter 47.44 RCW. 95-21-037 (Order 152), § 468-34-050, filed 10/10/95, effective 11/10/95. Statutory Authority: 1977 ex.s. c 151. 79-01-033 (DOT Order 10 and Comm. Order 1, Resolution No. 13), § 468-34-050, filed 12/20/78. Formerly WAC 252-04-045.]

WAC 468-34-060 Protests. Any person whose interests would be adversely affected by the granting of a franchise may file protests thereto. No form of protest is prescribed, but such protests shall be in writing, mailed to the department of transportation at the address listed in the notice, and to the applicant at the address stated in the application for franchise, and shall briefly state the facts upon which such protest is based. No protest or amendment thereof shall be considered by the department unless received within fourteen days after the notice of filing has been posted and published.

[Statutory Authority: Chapter 47.44 RCW. 89-05-022 (Order 119), § 468-34-060, filed 2/10/89. Statutory Authority: 1977 ex.s. c 151. 79-01-033 (DOT Order 10 and Comm. Order 1, Resolution No. 13), § 468-34-060, filed 12/20/78. Formerly WAC 252-04-050.]

WAC 468-34-070 Uncontested applications. If no protest to a franchise application is received within fourteen days after the notice of filing has been posted and published, the department may grant the franchise without further proceedings.

[Statutory Authority: 1977 ex.s. c 151. 79-01-033 (DOT Order 10 and Comm. Order 1, Resolution No. 13), § 468-34-070, filed 12/20/78. Formerly WAC 252-04-052.]

WAC 468-34-080 Procedure on protests. If a protest or protests to an application are filed with the department, the secretary or his designee shall, at the time for hearing such application, insofar as is practicable, state the issues raised by the protest or protests, take such other steps as it may deem necessary for complete hearing on such issues, and continue such hearing from time to time until the hearing is completed in accordance with these rules.

[Statutory Authority: 1977 ex.s. c 151. 79-01-033 (DOT Order 10 and Comm. Order 1, Resolution No. 13), § 468-34-080, filed 12/20/78. Formerly WAC 252-04-055.]

[Title 468 WAC—p. 44]

WAC 468-34-090 Hearing officers. The secretary may designate any qualified person as hearing officer with respect to hearings on any franchise application. Subject to later review and ruling by the secretary or his designee, such hearing officer may:

- (1) Administer oaths and affirmations, examine witnesses, and receive evidence;
- (2) Admit evidence which possesses probative value commonly accepted by reasonable, prudent men in the conduct of their affairs, giving effect to the rules of privilege recognized by law and excluding incompetent, irrelevant, immaterial and unduly repetitious evidence;
- (3) Rule on offers of proof and receive relevant evidence;
- (4) Regulate the course of the hearing;
- (5) Hold conferences for the settlement or simplification of the issues by consent of the parties;
- (6) Dispose of procedural requests or similar matters;
- (7) Prepare the proposed order, including findings of fact and conclusions of law, disposing of such application and submit the same to the secretary or his designee for consideration.

[Statutory Authority: 1977 ex.s. c 151. 79-01-033 (DOT Order 10 and Comm. Order 1, Resolution No. 13), § 468-34-090, filed 12/20/78. Formerly WAC 252-04-060.]

WAC 468-34-100 Policy on accommodation of utilities on highway rights of way. This policy shall apply to all franchises and permits issued subject to chapter 47.44 RCW to all public RCW to all public, private, and governmental utility lines that are to be located, adjusted or relocated within the rights of way of state highways other than provided for in chapter 47.24 RCW.

Nothing in this policy shall be construed as limiting the rights of the department to impose restrictions or requirements in addition to and/or deviations from those stated herein in any franchise or permit where the department deems it advisable to do so.

[Statutory Authority: Chapter 47.44 RCW. 89-05-022 (Order 119), § 468-34-100, filed 2/10/89. Statutory Authority: 1977 ex.s. c 151. 79-01-033 (DOT Order 10 and Comm. Order 1, Resolution No. 13), § 468-34-100, filed 12/20/78. Formerly WAC 252-04-065.]

WAC 468-34-110 Definition of terms. Unless otherwise stated, words and phrases used herein shall have the following meaning:

- (1) Highway - A general term denoting a street, road or public way for purposes of vehicular travel, including the entire area within the right of way.
- (2) Conventional highway - An arterial highway without access control.
- (3) Limited access highway - A highway upon which the rights to ingress and egress, light, view and air are controlled by law.
 - (a) Full control of access - Means that the authority to control access is exercised to give preference to through traffic by providing access connections with selected public roads by prohibiting crossings or direct private driveway connections at grade.

(b) Partial control of access - Means that the authority to control access is exercised to give preference to through traffic to a degree that, in addition to access connections with selected public roads, there may be some crossings and some private driveway connections at grade.

(c) Modified control of access - Means that the authority to control access is exercised to give preference to through traffic to such a degree that most approaches, including commercial approaches, existing and in use at the time of establishment, may be allowed.

(d) Freeway - A fully controlled limited access highway of four or more traffic lanes with the opposing traffic lanes separated by a median strip of arbitrary width.

(4) Frontage road - A local street or road auxiliary to an arterial highway for service to abutting property and adjacent areas and for control of access.

(5) Scenic route - A highway forming a part of the scenic and recreational highway system as set forth under chapter 47.39 RCW.

(6) Roadway prism - That portion of the highway right of way between back of ditch, bottom of ditch, back of curbs including slopes, shoulders, pavement and a median of less than sixteen feet in width.

(7) Roadway - The portion of a highway including shoulders, for vehicular use. A divided highway has two or more roadways.

(8) Median - The portion of a divided highway separating the traveled ways for traffic in opposite directions.

(9) Roadside - The roadside is the area between the edge of the roadway shoulder and the right of way line and unpaved medians on multilane highways.

(10) Rest area - A roadside area with parking facilities separated from the roadway provided for motorists to stop and rest. It may include drinking water, toilets, tables and benches, telephones, information, and other facilities for travelers.

(11) Viewpoint - A roadside area provided for motorists to stop their vehicles beyond the shoulder, primarily for viewing the scenery in safety.

(12) Right of way - A general term denoting land, property, or interest therein, usually in a strip, acquired for or devoted to highway transportation purposes.

(13) Clear roadside policy - The policy employed by a highway authority to increase safety, improve traffic operation and enhance the appearance of highways by designing, constructing and maintaining highway roadsides as wide, flat, and rounded as practical and as free as practical from physical obstructions above the ground such as trees, drainage structures, nonyielding sign supports, utility poles and other ground-mounted obstructions.

(14) Encroachment - Unauthorized use of highway right of way as for signs, fences, buildings, etc.

(15) Restoration - A general term denoting replacing, repairing or otherwise restoring the right of way to the same or equal conditions as before any change or construction thereon.

(16) Franchise - Occupancy and use document required for longitudinal occupancy of highway rights of way in accordance with chapter 47.44 RCW.

(17) Permit - Occupancy and use document required for an occupancy of the highway rights of way other than by franchise as provided in chapter 47.44 RCW.

(18) Private lines - Privately owned facilities which convey or transmit commodities as listed in WAC 468-34-100, but are devoted exclusively to the use of the owner.

(19) Roadway structure - The combination of subbase, base course, and surface course placed on a subgrade to support the traffic load and distribute it to the roadbed.

(20) Overcrossing - A grade separation where the subject highway passes over an intersecting highway or railroad.

(21) Undercrossing - A grade separation where the subject highway passes under an intersecting highway or railroad.

(22) Backfill - Replacement of soil around and over a pipe.

(23) Bedding - Organization of soil or fine gravel to support a pipe.

(24) Overfill - Backfill above a pipe.

(25) Sidefill - Backfill alongside a pipe.

(26) Carrier - Pipe directly enclosing a transmitted fluid (liquid or gas).

(27) Casing - A larger pipe enclosing a carrier.

(28) Sleeve - Short casing through pier or abutment of highway structure.

(29) Vent - Appurtenance to discharge gaseous contaminants from casings.

(30) Coating - Material applied to or wrapped around a pipe.

(31) Conduit or duct - An enclosed tubular runway for protecting wires or cables.

(32) Cover - Depth of top of pipe below grade of roadway or ditch.

(33) Drain - Appurtenance to discharge accumulated liquid contaminants from casings or other enclosures.

(34) Encasement - Structural element surrounding a pipe.

(a) Jacket - Encasement by concrete poured around a pipe.

(b) Walled - Partially encased by concrete poured alongside the pipe.

(35) Gallery - An underpass for two or more pipelines.

(36) Grounded - Connected to earth or to some extended conducting body which serves as a ground instead of the earth.

(37) Manhole - An opening in an underground system which workmen or others may enter for the purpose of making installations, inspections, repairs, connections, and tests.

(38) Pipeline - A tubular product made as a production item for sale as such.

(39) Pressure - Relative internal pressure in psig (pounds per square inch gage).

(40) Slab, floating - Slab between but not contacting pipe and pavement.

(41) Trenched - Installed in a narrow open excavation.

(42) Untrenched - Installed without breaking ground or pavement surface, such as by jacking or boring.

(43) Utility service connection - A service connection from a utility's distribution or feeder line or main to the premises served.

(44) Traffic control - Those provisions necessary to safeguard the public during construction activities.

(45) Normal - Crossing at a right angle.

(46) Standard specifications for road, bridge, and municipal construction - The compilation of standard requirements for road, bridge, and municipal construction issued by the Washington state department of transportation.

(47) True line and grade - A line reasonably free from variation on both horizontal and vertical alignment.

(48) Control zone guidelines - Guidelines established to control the placement of above-ground utility facilities within the highway right of way.

(49) Major reconstruction - Upgrading the capacity of the facility and/or replacement of more than fifty percent of the poles or towers within any mile.

(50) Roadbed - The graded part of the roadway within top and side slopes, prepared as a foundation for the pavement structure and shoulders.

(51) Subgrade - The top surface of the roadbed on which subbase, base, surfacing, pavement, or layers of similar materials are placed.

(52) Utility - A term denoting electric power, communication, cable television, water, gas, oil, petroleum products, steam, chemicals, sewage, drainage, irrigation, fire or police signal systems, and similar lines. Also, the term utility includes those utility-type facilities which are owned or leased by a government agency for its own use, or otherwise dedicated solely to governmental use. The term utility does not include utility-type facilities required for the support, control, operation, and maintenance of the highway system, if they are owned and controlled by the highway authority.

(53) Installation categories - Utility installations will be defined by the effect the installation will have on the highway integrity and impact to the traveling public.

(a) Category 1 installations have considerable impact on highway facilities and the public and will require a detailed review effort by more than one department office.

(b) Category 2 installations have limited impact on highway facilities and the public and may require review by more than one department office.

(c) Category 3 installations have little or no impact on highway facilities and the public and will be reviewed only by the office processing the application.

(d) Category 4 installations are same-side service connections below a specified size (see application instructions) and are exempt from the permit/franchise process except in limited access controlled areas.

[Statutory Authority: Chapter 47.44 RCW. 95-21-037 (Order 152), § 468-34-110, filed 10/10/95, effective 11/10/95; 89-05-022 (Order 119), § 468-34-110, filed 2/10/89. Statutory Authority: 1977 ex.s. c 151. 79-01-033 (DOT Order 10 and Comm. Order 1, Resolution No. 13), § 468-34-110, filed 12/20/78. Formerly WAC 252-04-075.]

WAC 468-34-120 Application of policy to various types of right of way. The applicable policy for the accommodation of utilities on various types of highways shall be in accordance with the following:

(1) Freeways - Accommodation of utilities shall be in accordance with "A Policy on the Accommodation of Utilities on Freeway Rights of Way" issued by the American

Association of State Highway and Transportation Officials (AASHTO) 1982, and amendments thereto, and this policy.

(2) Limited access highways - Accommodation of utilities shall be the same as for freeways.

(3) Conventional highways - Rural - Accommodation of utilities shall be in accordance with this policy.

(4) Conventional highways - Cities and towns - Accommodation of utilities shall be in accordance with:

(a) Underground

(i) Water and sewer - The current "Standard Specifications for Road, Bridge, and Municipal Construction."

(ii) All other facilities - Accommodation of utilities shall be in accordance with this policy.

(b) Overhead - Accommodation of utilities shall be in accordance with this policy.

[Statutory Authority: Chapter 47.44 RCW. 89-05-022 (Order 119), § 468-34-120, filed 2/10/89. Statutory Authority: 1977 ex.s. c 151. 79-01-033 (DOT Order 10 and Comm. Order 1, Resolution No. 13), § 468-34-120, filed 12/20/78. Formerly WAC 252-04-085.]

WAC 468-34-130 Location. (1) Utility installations should be located to minimize need for later adjustment to accommodate future highway improvements and to permit access for servicing such lines with minimum interference to highway traffic and must be located in accordance with the control zone guidelines.

(2) Longitudinal installations should be located on a uniform alignment and grade as near as practicable to the right of way line so as to provide a safe environment for traffic operation and preserve space for future highway improvements or other utility installations.

(3) Utility line crossings of the highway shall be normal to the highway center line to the extent feasible and practical. Crossings should be made on a true line and grade. Crossings entering the right of way at an angle greater than forty-five degrees from normal shall be considered longitudinal location except crossings within public road intersections.

(4) The horizontal location shall be placed with relation to the centerline of the highway as approved by the department.

(5) The vertical location of underground utility lines shall be in accordance with the currently applicable design standard for underground utility encroachments. The vertical clearance of above ground facilities shall be consistent with the clearances as provided in WAC 468-34-290.

(6) In all cases, full consideration shall be given to visual quality, sound engineering principles, and overall economic aspects.

(7) Utility installations that are needed for a highway purpose, such as for continuous highway lighting or to serve a weigh station, rest or recreational area, are to be located and designed in accordance with the requirements of this policy.

(8) The department may restrict the number of utility service connections, and require the placement of one or more distribution lines in lieu thereof.

[Statutory Authority: Chapter 47.44 RCW. 89-05-022 (Order 119), § 468-34-130, filed 2/10/89. Statutory Authority: 1977 ex.s. c 151. 79-01-033 (DOT Order 10 and Comm. Order 1, Resolution No. 13), § 468-34-130, filed 12/20/78. Formerly WAC 252-04-095.]

WAC 468-34-140 Utility tunnels and bridges. The department should ensure adequate study is made by the utility companies to anticipate their needs (present and future) for crossings and to determine if convergence of several crossings can be made to make it more feasible to use a utility tunnel or bridge.

In a combined tunnel or bridge, provision shall be made to isolate mutually hazardous transmittants such as fuels and electric energy by compartmentizing or by auxiliary encasement of incompatible carriers.

The utility tunnel or bridge shall comply in appearance, location, cover, earthwork and markers with the standards as set in the current Standard Specifications for Road, Bridge, and Municipal Construction.

[Statutory Authority: Chapter 47.44 RCW, 89-05-022 (Order 119), § 468-34-140, filed 2/10/89. Statutory Authority: 1977 ex.s. c 151, 79-01-033 (DOT Order 10 and Comm. Order 1, Resolution No. 13), § 468-34-140, filed 12/20/78. Formerly WAC 252-04-105.]

WAC 468-34-150 Design. (1) The utility company shall be responsible for the design of the utility facility. The department shall review and approve the utility's plans with respect to location and the manner in which the utility facility is to be installed and measures to be taken to preserve safe and free flow of traffic, structural integrity of the roadway or highway structure, ease of highway maintenance, appearance of the highway and the integrity of the utility facility.

(2) Utility installations on, over or under the rights of way and utility attachments to highway structures shall as a minimum comply with the following standards and/or amendments thereto:

(a) Electric power and communication facilities shall conform with the currently applicable National Electric Safety Code and/or Washington State Safety Code.

(b) Water lines shall conform with the current Standard Specifications for Road, Bridge, and Municipal Construction including but not limited to:

Welded Steel Water Pipe	AWWAC201 & ASTM A 120 AWWAC203 AWWAC205
Reinforced Concrete Water Pipe	AWWAC300 AWWAC301 AWWAC302
Cast Iron Water Pipe	AWWAC106 AWWAC108 AWWAC111
Wrought Iron Water Pipe	ASTMA72

(c) Pressure pipeline shall conform with the currently applicable sections of Standard Code for Pressure Piping of the American National Standards Institute and applicable industry codes, including:

(i) Power Piping, ANSI B 31.10

(ii) Petroleum Refinery Piping, ANSI B 31.3

(iii) Liquid Petroleum Transportation Piping Systems, ANSI B 31.4

(iv) CFR 49, Part 192, Transportation of Natural and Other Gas by Pipeline - Minimum Federal Safety Standards

(2001 Ed.)

(v) Liquid petroleum pipelines shall conform with the currently applicable recommended practice of the American Petroleum Institute for Pipeline Crossings Under Railroad and Highways. (API RP 1102)

(d) Sewer pipe shall conform with the current Standard Specifications for Road, Bridge, and Municipal Construction.

(e) Drainage pipe shall conform with the current Standard Specifications for Road, Bridge, and Municipal Construction.

(3) Ground mounted utility facilities shall be of a design compatible with the visual quality of the specific highway section being traversed.

(4) All utility installations on, over, or under highway right of way and attachment to highway structures shall be of durable material designed for long service life expectancy and relatively free from routine servicing and maintenance.

(5) On new installations or adjustment of existing utility lines, provision shall be made for known or planned expansion of the utility facilities, particularly those located underground or attached to structures. They shall be planned so as to minimize hazards and interference with highway traffic when additional overhead or underground lines are installed at some future date.

(6) Government or industry codes required by law or regulation shall be followed in addition to rules and regulations referred to herein. This shall include any highway design standards which the department shall deem necessary to provide adequate protection to the highway, its safe operation, appearance and maintenance.

[Statutory Authority: Chapter 47.44 RCW, 89-05-022 (Order 119), § 468-34-150, filed 2/10/89. Statutory Authority: 1977 ex.s. c 151, 79-01-033 (DOT Order 10 and Comm. Order 1, Resolution No. 13), § 468-34-150, filed 12/20/78. Formerly WAC 252-04-115.]

WAC 468-34-160 Permits and franchises. Except as provided in WAC 468-34-180, a permit or franchise shall be required for occupancy of highway right of way by utility facilities, including private lines.

[Statutory Authority: 1977 ex.s. c 151, 79-01-033 (DOT Order 10 and Comm. Order 1, Resolution No. 13), § 468-34-160, filed 12/20/78. Formerly WAC 252-04-125.]

WAC 468-34-170 Permits and franchises—Contents. All permits or franchises shall:

(1) Incorporate all pertinent provisions of this policy as to location, construction, traffic protection, maintenance, access restriction, preservation of visual qualities, and such special conditions as the department may deem appropriate.

(2) Generally describe the facilities to be installed as to size, type, nature and extent.

(3) Contain adequate exhibits depicting:

(a) Existing or proposed location in relation to the highway.

(b) Existing or planned highway improvements.

(c) Right of way.

(d) Control of access and access points.

(4) Contain a summarization of the effects the installation will have on the aesthetics of the highway right of way and visible natural features.

(5) Specify the extent of liability and responsibilities associated with future adjustment of the utility facilities to accommodate highway improvements.

(6) Specify the effect of noncompliance with the conditions thereof.

(7) Contain terms which shall commit the holder to a pledge that performance of routine cutting and trimming work will be accomplished in such a manner that the roadside appearance will not be disfigured. When major work is involved, or damage to roadside appearance may become significant, the holder shall secure the approval of the department in advance of the work.

(8) Contain a certification of compliance with the control zone guidelines.

[Statutory Authority: Chapter 47.44 RCW. 95-21-037 (Order 152), § 468-34-170, filed 10/10/95, effective 11/10/95; 89-05-022 (Order 119), § 468-34-170, filed 2/10/89. Statutory Authority: 1977 ex.s. c 151. 79-01-033 (DOT Order 10 and Comm. Order 1, Resolution No. 13), § 468-34-170, filed 12/20/78. Formerly WAC 252-04-135.]

WAC 468-34-180 Accommodation where prior right.

Where the utility facilities are to be adjusted to accommodate highway construction and the utility has a prior property right in its location, the department and the utility may enter into a common use agreement providing for joint occupancy of right of way consistent with the requirements of each party.

[Statutory Authority: 1977 ex.s. c 151. 79-01-033 (DOT Order 10 and Comm. Order 1, Resolution No. 13), § 468-34-180, filed 12/20/78. Formerly WAC 252-04-145.]

WAC 468-34-190 Pipelines—Location and alignment.

(1) For all crossings, the angle of crossing should be based on economic considerations of practical alternates. The crossings should be as near normal to the highway centerlines as practical.

(2) Pipeline crossings should avoid deep cuts, footings of bridges and retaining walls, wet or rocky terrain or locations where highway drainage would be affected.

(3) Longitudinal installations shall parallel the highway and lie as near as practicable to the highway right of way line. Any longitudinal installation in the roadway or median, as defined in WAC 468-34-110 (7) and (8), shall be considered a variance from this policy. Any request for such a variance must demonstrate that:

(a) The installation will not adversely affect the design, construction, stability, structural integrity, traffic safety or operation of the highway.

(b) The installation, other than in the roadway or median, will create an undue hardship or financial burden by reason of terrain, geology, or environmental damage along the roadside.

(4) Trenched crossing in the roadway as defined in WAC 468-34-110(7) shall be considered a variance from this policy. Any request for such a variance shall comply with subsection (3)(a) and (b) of this section.

[Statutory Authority: Chapter 47.44 RCW. 89-05-022 (Order 119), § 468-34-190, filed 2/10/89. Statutory Authority: 1977 ex.s. c 151. 79-01-033 (DOT Order 10 and Comm. Order 1, Resolution No. 13), § 468-34-190, filed 12/20/78. Formerly WAC 252-04-155.]

[Title 468 WAC—p. 48]

WAC 468-34-200 Pipelines—Cover. (1) The grade of the top of pipe within the highway right of way shall comply with the applicable Design Standard for Underground Utility Encroachment.

(2) Where less than minimum cover is made necessary to avoid obstacles, the pipe should either be rerouted or protected with a casing or concrete slab acceptable to the department.

(3) Cover for pipelines carrying transmittants which are flammable, corrosive, expansive, energized, or unstable shall not be reduced below safety limits as specified in the appropriate industry standards and specifications.

[Statutory Authority: 1977 ex.s. c 151. 79-01-033 (DOT Order 10 and Comm. Order 1, Resolution No. 13), § 468-34-200, filed 12/20/78. Formerly WAC 252-04-165.]

WAC 468-34-210 Pipelines—Encasement. (1) Casings shall be required for the following conditions except as may be permitted under subsection (3) of this section.

(a) Pipeline crossings under completed freeways and other controlled access highways.

(b) Pipeline crossings where casing is required by appropriate industry code or special conditions.

(c) Pressurized carrier pipes and carriers of transmittants which are flammable, corrosive, expansive, energized, or unstable.

(d) Pipeline installations where local features, embankment materials, construction methods or other conditions indicate any possibility of damage to the protective coating during installation.

(2) Casings may be required for the following conditions.

(a) As an expediency in the insertion, removal, replacement or maintenance of carrier pipe crossings of freeways and other locations where it is necessary in order to avoid open trench construction.

(b) As protection for carrier pipe from external loads or shock, either during or after construction of the highway.

(c) As a means of conveying leaking fluids or gases away from the area directly beneath the traveled way to a point of venting at or near the right of way line or to a point of drainage in the highway ditch or a natural drainage way.

(d) Jacked or bored installations of coated carrier pipes, except where assurance is provided the department that there will be no damage to the protective coating.

(3) Casings may or may not be required for the following conditions.

(a) Pipelines relocated in advance of highway construction, including those conveying natural or other gas which meet the design, installation and cathodic protection provisions of the Minimum Federal Safety Standards, CFR 49, Part 192 may be constructed without encasement provided the department (and the pipeline officials) agree that the lines are and will remain structurally sound and operationally safe.

(b) Uncased crossings for local service connections of one inch diameter or less carrying natural or other gas which conform to the design, installation, and cathodic protection provisions of the Minimum Federal Safety Standards, CFR 49, Part 192 may be permitted on two-lane highways at those locations where the department agrees that the embankment

materials and installation methods are adequate and that complete assurance is provided against damage to the protective coating of the pipe or to the roadway structure.

(c) Pipelines installed where open cutting is allowed.

(4) Casing pipes shall extend a minimum of six feet beyond the toe of fill slopes, or back of ditch line, or outside curb. The casing pipe need not be continuous on freeways with or without frontage roads; however, maintenance in the median shall not be required on a routine basis.

(5) Casing pipes shall be sealed at the ends.

(6) Casing pipes shall be designed to support the load of the highway and superimposed loads thereon and, as a minimum, shall equal the structural requirements for highway drainage facilities. Casings shall be composed of materials of sufficient durability to withstand any conditions to which they may be exposed.

[Statutory Authority: Chapter 47.44 RCW, 89-05-022 (Order 119), § 468-34-210, filed 2/10/89. Statutory Authority: 1977 ex.s. c 151, 79-01-033 (DOT Order 10 and Comm. Order 1, Resolution No. 13), § 468-34-210, filed 12/20/78. Formerly WAC 252-04-175.]

WAC 468-34-220 Pipelines—Appurtenances. (1)

Vents shall be required for casings, tunnels and galleries enclosing carriers of fuel where required by CFR 49, Part 192, Minimum Federal Safety Standards. Vent standpipes shall be located and constructed so as not to interfere with maintenance of the highway nor to be concealed by vegetation; preferably they should stand by a fence or on the right of way line.

(2) Drains shall be required for casings, tunnels, or galleries enclosing carriers of liquid, liquefied gas or heavy gas. Drains may outfall into the roadway ditch or natural water course at locations approved by the department. The outfall shall not be used as a wasteway for purging the carrier unless specifically authorized by the department.

(3) Marker location and emergency information shall be conspicuously marked for all pipelines, using color if necessary to contrast with the environment. They should be provided at one end of a normal crossing, at both ends of an oblique crossing and at five hundred foot intervals along a longitudinal installation. Markers shall include pipeline identification and station; owner of the pipeline; and telephone number or other means of contact with local office. Markers may also include depth of cover, size, pressure and contents of carrier, and potential of ducted wires and cables.

(4) Manholes shall not be located in the pavement or shoulders of any access controlled highway. Manholes should be designed and located in such a manner that will cause the least interference to other utilities and future highway expansion.

(5) Automatic shut-off valves shall be installed in line at or near ends of structures, near unusual hazards, unless the hazardous segments can be isolated by other sectionalizing devices within a reasonable distance.

(6) Above-ground appurtenances shall be located to comply with the control zone guidelines.

[Statutory Authority: Chapter 47.44 RCW, 89-05-022 (Order 119), § 468-34-220, filed 2/10/89. Statutory Authority: 1977 ex.s. c 151, 79-01-033 (DOT Order 10 and Comm. Order 1, Resolution No. 13), § 468-34-220, filed 12/20/78. Formerly WAC 252-04-185.]

(2001 Ed.)

WAC 468-34-230 Pipelines—Uncased carriers. (1)

The carrier pipe shall conform to the material and design requirements of the utility industry and government codes and specifications.

(2) The carrier pipe shall be designed to support the load of the highway plus superimposed loads thereon when the pipe is operated under all ranges of pressure from maximum internal to zero pressures.

(3) Suitable bridging, concrete slabs, or other appropriate measures as approved by the department shall be used to protect existing carrier pipes which by reason of shallow bury or location makes them vulnerable to damage from highway construction or maintenance operations.

(4) Existing carrier pipelines may remain in place without further protective measures if they are of adequate depth and do not conflict with highway construction or maintenance and provided the department (and the pipeline officials) agree that the lines are, and will remain, structurally sound and operationally safe.

[Statutory Authority: 1977 ex.s. c 151, 79-01-033 (DOT Order 10 and Comm. Order 1, Resolution No. 13), § 468-34-230, filed 12/20/78. Formerly WAC 252-04-195.]

WAC 468-34-240 Pipelines—Restrictions against varied use. (1) Pipeline installation requests shall specify the class of transmittant, the maximum working, test, or design pressures, and the design standards for the carrier.

(2) A change in the class of transmittant, or an increase in the maximum design pressure specified in the permit or franchise, shall require approval of the department. The request for the change shall specify the applicable codes to be used.

[Statutory Authority: 1977 ex.s. c 151, 79-01-033 (DOT Order 10 and Comm. Order 1, Resolution No. 13), § 468-34-240, filed 12/20/78. Formerly WAC 252-04-205.]

WAC 468-34-250 Pipelines—Installation. Installation or replacement of pipelines along or crossing highways shall ordinarily be controlled by end-product specifications. However, to insure safety of traffic and preservation of the earth structure supporting the pavement, any required construction shall be in accordance with the following controls:

(1) Trenched construction and backfill. The essential features for trench and backfill construction are:

(a) Restoration of the structural integrity of entrenched roadbed.

(b) Security of the pipe against deformation likely to cause leakage.

(c) Assurance against the trench becoming a drainage channel or against drainage being blocked by the backfill.

(2) Trenched construction - bedding and backfill.

(a) Trenches shall be cut to have vertical faces, where soil and depth conditions permit, with a maximum width of outside diameter of pipe plus two feet. Shoring shall comply with the department of labor and industries safety code for construction and/or as directed by the department.

(b) Bedding shall be provided to a depth of six inches or half the diameter of the pipe, whichever is least. Bedding should consist of granular material free of lumps, clods, stones, and frozen material. Bedding shall be graded to a firm

but yielding surface without abrupt change in bearing value. Unstable soils and rock ledges should be subexcavated from the bedding zone and replaced with suitable material or as directed by the department. The bottom of the trench should be prepared to provide the pipe with uniform bedding throughout the length of the installation.

(c) Backfill shall be placed in two stages:

(i) Sidefill to the level of top of pipe.

(ii) Overfill to former grade surface. Sidefill and overfill shall consist of granular material laid in six-inch layers, each consolidated by mechanical tamping and controlled addition of moisture, to a density of ninety-five percent in accordance with the current Standard Specifications for Road, Bridge, and Municipal Construction. Consolidation by saturation or ponding is not permitted. Backfilling and methods of compaction should be adapted to achieve prompt restoration of traffic. Additional cutback of base and surfacing and transitioning of trench shoulders to minimize later development of sag in the grade of the pavement over the trench shall be as directed by the department.

(3) Untrenched construction shall be required on all pipeline crossings of limited access highways and:

(a) The width of untrenched construction shall extend a minimum of six feet outside the roadway prism.

(b) Pipelines installed under a highway without disturbing the surface shall be made using a technique approved by the department.

(c) The size of the opening shall not exceed five percent oversize in diameter. Backfill is required for pipes over twelve inches in diameter.

(d) Overbreaks, unused holes, or abandoned casings shall be backfilled as directed by the department.

[Statutory Authority: Chapter 47.44 RCW, 89-05-022 (Order 119), § 468-34-250, filed 2/10/89. Statutory Authority: 1977 ex.s. c 151, 79-01-033 (DOT Order 10 and Comm. Order 1, Resolution No. 13), § 468-34-250, filed 12/20/78. Formerly WAC 252-04-215.]

WAC 468-34-260 Pipelines—Adjustment. (1) An existing pipeline should be relocated in plan and/or grade whenever the top of the pipe is less than the requirements of the currently applicable standard design plate for underground utility encroachments.

(2) An existing or relocated pipeline shall be encased or otherwise protected wherever such treatment normally would be required for a future pipeline at the site.

(3) An existing pipeline which would lack adequate cover for protection against vehicular live loads or highway construction operations may, in lieu of encasement, be protected by a floating slab.

(4) Notwithstanding reinforcement or protection otherwise provided, the highway construction contractor should be warned and made responsible for the security of each existing pipeline within the construction zone. Where there are unusual utility hazards and where heavy construction equipment will be needed, it should be arranged that the contractor provide an adequate temporary protective cover of earth or bridge the utility if underground.

[Statutory Authority: 1977 ex.s. c 151, 79-01-033 (DOT Order 10 and Comm. Order 1, Resolution No. 13), § 468-34-260, filed 12/20/78. Formerly WAC 252-04-225.]

[Title 468 WAC—p. 50]

WAC 468-34-270 Installations on highway structures. Attachment of utility lines to a highway structure may be allowed where such attachment shall conform to sound engineering considerations for preserving the highway, its safe operation, maintenance and appearance. The attachment shall be in accordance with the following:

(1) Each proposed bridge attachment should be considered on its individual merits and separately designed so as to be compatible with the appearance of the structure.

(2) Bridge attachment of a utility should not be considered unless the structure in question is of a design that is adequate to support the additional load and to accommodate the utility facility without compromise of highway features, including reasonable ease of bridge maintenance.

(3) Utility positionings on a structure which would inhibit access to any structure part for bridge painting, repair or maintenance should not be allowed. Manholes for utility access shall not be allowed in the bridge deck on overcrossings.

(4) Attachment on a structure of a pipeline carrying a hazardous transmittant shall be avoided where practical.

(5) The utility attachment shall not effectively reduce the clearance of the structure where such clearance is critical.

(6) Generally, utility attachments should be beneath the structure's floor, between the girders or beams or within a cell and at an elevation above low superstructure steel or masonry. Attachment to the outside of the bridges should be avoided where there are reasonable alternatives.

(7) Utility mountings should be of a type which will not create noise resulting from vibration.

(8) The hole created in the bridge abutment shall be of the minimum size necessary to accommodate the utility line. The hole shall be sealed to prevent any leakage of water or backfill material.

(9) The utility line back of the bridge abutment should curve or angle out to align outside the roadbed area in as short a distance as is operationally practicable.

(10) Acceptable utility attachment methods are hangers and/or roller assemblies suspended from inserts in the underside of the bridge floor or from hanger rods clamped to the flange of some substructure member or as otherwise specified by the department.

(11) Utility construction shall conform to applicable codes, standards and specifications.

(12) The utility company shall be responsible for any restoration or repair of any portion of bridge or highway disturbed by the utility installation or use.

(13) Communication and electric power line attachments shall be suitably insulated, grounded, and carried in protective conduit or pipe from point of exit from ground to reentry. The cable shall be carried to a manhole located beyond the backwall of the structure. Carrier pipe and casing pipe shall be suitably insulated from electric power line attachments.

(14) WAC 468-34-210 shall apply to installations on structures.

[Statutory Authority: 1977 ex.s. c 151, 79-01-033 (DOT Order 10 and Comm. Order 1, Resolution No. 13), § 468-34-270, filed 12/20/78. Formerly WAC 252-04-235.]

(2001 Ed.)

WAC 468-34-280 Overhead power and communication lines—Type of construction. Longitudinal installations on the right of way should be single pole construction. Joint use single pole construction is generally desirable and should be used whenever feasible.

[Statutory Authority: 1977 ex.s. c 151. 79-01-033 (DOT Order 10 and Comm. Order 1, Resolution No. 13), § 468-34-280, filed 12/20/78. Formerly WAC 252-04-245.]

WAC 468-34-290 Vertical clearance. The vertical clearance for overhead power and communication lines above the highway and the lateral and vertical clearance from bridges shall conform with the National Electrical Safety Code and/or with the clearances as shown below, whichever is greater.

TYPE OF UTILITY LINE	LINES	
	CROSSING ROADWAYS	LONGITUDINAL
Communications and Cable		
Television	24'	20'
Communications and/or Cable		
Television joint usage with electrical	20'	20'
ELECTRICAL		
0 - 750 volts	24'	24'
751 - 15,000 volts	30'	27'
15,001 - 50,000 volts	32'	32'
50,001 volts & over	34'	32'

(1) The minimum height of highway crossing shall be measured from the point of the roadway directly under the crossing.

(2) The minimum height of longitudinal lines shall be measured from ground line.

(3) All clearances shall be at State Electrical Construction Code temperature and loading standards, and comply with all other requirements of this code.

[Statutory Authority: Chapter 47.44 RCW. 89-05-022 (Order 119), § 468-34-290, filed 2/10/89. Statutory Authority: 1977 ex.s. c 151. 79-01-033 (DOT Order 10 and Comm. Order 1, Resolution No. 13), § 468-34-290, filed 12/20/78. Formerly WAC 252-04-255.]

WAC 468-34-300 Overhead lines—Location. (1) Pole lines must be located in accordance with the control zone guidelines.

(2) Guy wires to ground anchors and stub poles shall be located in accordance with the control zone guidelines.

(3) Where irregular shaped portions of the right of way extend beyond the normal right of way limits, variances in the location from the right of way line should be allowed as necessary to maintain a reasonably uniform alignment for longitudinal overhead and underground installations.

(4) On and along conventional highways, poles and related facilities should be located as near as practicable to the right of way line.

[Statutory Authority: Chapter 47.44 RCW. 89-05-022 (Order 119), § 468-34-300, filed 2/10/89. Statutory Authority: 1977 ex.s. c 151. 79-01-033 (DOT Order 10 and Comm. Order 1, Resolution No. 13), § 468-34-300, filed 12/20/78. Formerly WAC 252-04-265.]

(2001 Ed.)

WAC 468-34-310 Underground power and communication lines. (1) The general controls relative to pipelines shall apply to underground installation of power and communication lines.

(2) The general controls set forth in WAC 468-34-270 relative to installations on highway structures shall be followed.

(3) The design of underground installations should reflect consideration of possible future highway and/or utility enlargement.

(4) Manholes shall be designed and located in such a manner that will cause the least interference to other utilities and future highway expansion.

(5) New underground utility installations may be permitted in scenic strips, overlooks, where they will not require extensive removal or alteration of trees visible to the highway user or impair the visual quality of the lands being traversed.

[Statutory Authority: 1977 ex.s. c 151. 79-01-033 (DOT Order 10 and Comm. Order 1, Resolution No. 13), § 468-34-310, filed 12/20/78. Formerly WAC 252-04-275.]

WAC 468-34-320 Conversion to underground or relocation of overhead lines—Responsibility. Consistent with existing statutes and the necessity for protecting roadside appearance and removal or relocation of existing aerial lines within certain areas, the following methods of sharing cost responsibility shall pertain under various circumstances.

(1) Where an aerial utility line exists under franchise and for reasons of visual quality the department desires undergrounding or aerial relocation during the life of the franchise to serve the highway purpose, the department will pay the cost of the new facility, plus cost of removal of the old plant, less a credit for depreciation and salvage on the replaced plant.

(2) For new franchises for new utility lines where none presently exist and where the department determines on the basis of scenic classification (WAC 468-34-330) that the facilities shall be placed underground, the entire cost shall be borne by the utility.

Where a franchise is to be amended or has been renewed for the first time after the effective date (August 20, 1974) of this policy revision and the department determines on the basis of scenic classification (WAC 468-34-330) that the facility should be placed underground or relocated aerially, the cost for such undergrounding or relocation shall be borne by the utility. Such undergrounding or relocation shall occur at the time of reconstruction of the line by the utility or at a time determined by the utility within the renewal period, whichever occurs first.

(3) Within the limits of projects for highway construction where the utility occupies the right of way by right of franchise and where the department determines on the basis of scenic classification (WAC 468-34-330) that the facility should be placed underground or, based on design and/or location considerations the facility may be relocated aerially, the cost responsibilities shall be determined as follows:

(a) The utility shall be responsible for the full cost of that portion of the existing aerial facility that must be relocated within the physical limits of construction.

(b) The department will pay the cost of the new facility, plus the cost of removal of the old plant less a credit for depreciation and salvage on the replaced plant, for that portion of aerial line not physically affected by the highway construction.

[Statutory Authority: Chapter 47.44 RCW. 89-05-022 (Order 119), § 468-34-320, filed 2/10/89. Statutory Authority: 1977 ex.s. c 151. 79-01-033 (DOT Order 10 and Comm. Order 1, Resolution No. 13), § 468-34-320, filed 12/20/78. Formerly WAC 252-04-280.]

WAC 468-34-330 Scenic enhancement. (1) Undergrounding requirements within scenic areas: In the interest of protection and preservation of roadside appearance and visual quality of scenic areas, the following requirements shall pertain to highway sections classified in accordance with the definitions set forth in subsection (3) of this section.

Class A and B:

Initial franchises and franchise amendments where aerial facilities are nonexistent: Installation shall be underground except as may be justified as special exceptions listed in subsection (2) of this section.

Initial franchises and franchise amendments where aerial facilities exist: An aerial facility may be allowed on existing poles with the franchise to expire on the date of the existing franchise for the aerial line. No major reconstruction of the existing pole line or construction of a new aerial facility will be allowed except as may be justified under subsection (2) of this section.

Franchise renewals of existing aerial facilities: Upon expiration of an existing franchise, one franchise renewal for a period of twenty-five years may be granted for existing aerial lines with a special provision included in the franchise requiring the utility to apply for an initial franchise, franchise amendment or franchise renewal for burial of the facility either at the time major reconstruction of the line, for that portion of line to be reconstructed, or prior to expiration of the first franchise renewal. Existing facilities may be allowed to remain aerial if justified under subsection (2) of this section.

In considering approval of aerial facilities as special exceptions under subsection (2) of this section, greater emphasis upon the justification of facilities within Class A route segments shall be given by the department as compared to those in Class B.

Class C and D:

Aerial installations within highway sections having Class C and D scenic classification are permitted.

Class AX and BX:

An aerial facility may be allowed if found acceptable to the department based on design and/or location which will not detract from scenic values typical of those defined in Classes A and B.

(2) Special exceptions: Special exceptions may be made where one or more of the following conditions exist:

Power lines of voltage in excess of 35 KV. Special design should be incorporated to minimize the visual impact of the facility.

Other utility locations are not available or are usually difficult and unreasonably costly, or are more undesirable from the standpoint of visual quality.

[Title 468 WAC—p. 52]

The placing of the utility underground is not technically feasible or is unreasonably costly.

The impact of the required undergrounding adversely affects the utility consumer rates or the long term economics of the utility.

(3) Classifications:

Class A — Superior scenic qualities: Unique settings of superior scenic quality, historic or cultural, interest that should be protected or preserved by special treatment for heritage of others. Panoramic views from the highway of ocean beaches, scenic valleys, lake frontage, mountain forests, rivers, etc.

Class B — High scenic value: Areas where valuable scenic and environmental amenities exist and are enjoyed generally by travelers and public and deserve serious consideration for preservation and protective measures.

Class C — Secondary scenic importance: Scenic characteristics are of marginal importance.

Class D — Industrial, heavily urbanized or deteriorated areas: Industrial areas, urban settings and blighted areas which expense for beautification measures is not appropriate.

Subclass X — Alternative for Class A and B: Areas where based on design alternatives, such as configurations, color and location, an aerial facility could be allowed without changing the landscape quality.

General criteria: Classifications are to be based on the scenic values of the view from the roadway including the roadway appearance attainable after ultimate improvements within the right of way. Sections are to be of sufficient length to sustain separate distinguishable area characteristics.

[Statutory Authority: 1977 ex.s. c 151. 79-01-033 (DOT Order 10 and Comm. Order 1, Resolution No. 13), § 468-34-330, filed 12/20/78. Formerly WAC 252-04-285.]

WAC 468-34-340 Miscellaneous. (1) Preservation, restoration and cleanup

(a) Disturbed areas - The size of the disturbed area shall be kept to a minimum. Restoration methods shall be in accordance with the specifications and/or special provisions of the permit or franchise. Unsatisfactory restoration work shall be promptly redone by the utility. If necessary, restoration work that is not acceptable to the department, may be repaired by the department and billed to the utility company.

(b) Drainage - Care shall be taken in utility installations to avoid disturbing existing drainage facilities. Underground utility facilities should be backfilled with pervious material and outlets provided for entrapped water. Underdrains should be provided where necessary. No jetting or puddling shall be permitted under the roadway.

(c) Spraying, cutting and trimming of trees - The indiscriminate cutting of trees or disfiguring of any feature of scenic value shall not be permitted. The utility shall repair or replace in kind any tree or shrub removed or disfigured when such is not necessary for the utility installation.

(d) If chemical sprays are used to kill weeds and brush, they shall comply with currently applicable federal and state department of agriculture regulations and the following:

(i) A special permit issued by the department shall be required.

(2001 Ed.)

(ii) Brush and trees thirty inches or higher shall be close cut and treated with spray to kill the roots and stumps.

(iii) Brush shall be disposed of by chipping or removal from the right of way.

(iv) Brush and weeds thirty inches or less in height may be treated with a chemical spray. After the brush and weeds have died, they shall be immediately removed to prevent a serious fire hazard.

(v) The utility shall be responsible for any drift of the spray that contacts vegetation on private property adjacent to the highway.

(vi) Ingredients that are toxic to livestock, game animals or fowls shall not be used.

(e) Refuse and debris shall be disposed of to the satisfaction of the department.

(2) Safety and convenience

(a) Traffic controls including detours for utility construction and maintenance shall conform with currently applicable "Manual on Uniform Traffic Control Devices for Streets and Highways." All construction and maintenance operations shall be planned to keep interference with traffic to an absolute minimum. On heavily traveled highways construction operations interfering with traffic shall not be allowed during periods of peak traffic flow. Work shall be planned so that closure of intersecting streets, road approaches or other access points is held to a minimum. Adequate provisions shall be made to safeguard any open excavation to include barricades, lights, flagmen, or other protective devices as may be necessary.

(b) All utility facilities shall be kept in good state of repair both structurally and from the standpoint of appearance. The permit or franchise shall specify the maintenance operations which are permitted and the required notification to the department before any work is accomplished. Vehicle parking and the storage of materials on through roadways or ramps shall not be allowed.

(c) If emergency repairs are required, such repairs shall be undertaken and notice given immediately and approval as to the manner of repair secured as soon as possible. The utility shall confine its operations as much as possible to the non-traveled portion of the right of way and shall exercise caution to protect the traveling public during such repairs. Flagmen, warning lights, barricades, and signs shall be employed in accordance with currently applicable *Manual on Uniform Traffic Control Devices for Streets and Highways*, and *Manual for Emergency Traffic Control for Protection of Men and Equipment*.

(d) Installations included in the Category 4 exemption require twenty-four hours notice to the department prior to construction. Vehicle parking and the storage of materials on through roadways or ramps shall not be permitted. Flagmen, warning lights, barricades, and signs shall be employed in accordance with currently applicable *Manual on Uniform Traffic Control Devices for Streets and Highways*, and *Manual for Emergency Traffic Control for Protection of Men and Equipment*.

[Statutory Authority: Chapter 47.44 RCW. 95-21-037 (Order 152), § 468-34-340, filed 10/10/95, effective 11/10/95; 89-05-022 (Order 119), § 468-34-340, filed 2/10/89. Statutory Authority: 1977 ex.s. c 151. 79-01-033 (DOT

(2001 Ed.)

Order 10 and Comm. Order 1, Resolution No. 13), § 468-34-340, filed 12/20/78. Formerly WAC 252-04-295.]

WAC 468-34-350 Control zone guidelines. Consistent with federal, state, or local laws or regulations all utility installations within the highway right of way shall be located in accordance with the control zone guidelines. The control zone guidelines govern the location of utilities within the right of way for the following:

- (1) New installations or reconstruction.
- (2) Highway projects involving safety improvements.
- (3) Franchise renewal or consolidation of existing utility objects.

[Statutory Authority: Chapter 47.44 RCW. 89-05-022 (Order 119), § 468-34-350, filed 2/10/89.]

Chapter 468-38 WAC

VEHICLE SIZE AND WEIGHT—RESTRICTED HIGHWAYS—EQUIPMENT

WAC

- 468-38-010 Three-vehicle combinations.
- 468-38-020 Temporary additional tonnage permits.
- 468-38-030 Issuance of temporary additional tonnage permits.
- 468-38-040 Special log tolerance transportation permits.
- 468-38-050 Special permits for movement of overleaf size or weight loads.
- 468-38-060 Liability of permitted.
- 468-38-070 Maximums for special permits—Nondivisible.
- 468-38-071 Maximums for special permits—Reducible.
- 468-38-075 Over length exemptions.
- 468-38-080 Emergency closure and load restrictions on state highways.
- 468-38-100 Escort car requirements.
- 468-38-110 Escort vehicle requirements.
- 468-38-120 Transport of extra-legal manufactured housing.
- 468-38-130 Lights—Stop and turn signals.
- 468-38-135 Transportation of radioactive or hazardous materials.
- 468-38-140 Flags.
- 468-38-160 Rear-view mirrors for over width loads.
- 468-38-180 Brakes.
- 468-38-190 Signs.
- 468-38-200 Safety chains and devices.
- 468-38-220 Moves in convoy.
- 468-38-230 Days on which permit movements are prohibited.
- 468-38-235 Commuter traffic restrictions.
- 468-38-240 Cargo prohibition on reversible lane roadways.
- 468-38-250 Days on which permits are issued.
- 468-38-260 Night-time movements.
- 468-38-265 Emergency operation of tow trucks.
- 468-38-270 Construction equipment.
- 468-38-280 Special equipment.
- 468-38-290 Farm implements.
- 468-38-300 Drawbar—Towline.
- 468-38-310 Adverse weather.
- 468-38-320 Enforcement officer may restrict movements.
- 468-38-330 Consideration of traveling public.
- 468-38-340 Speed limits.
- 468-38-350 Lane of travel.
- 468-38-360 Building/house moves.
- 468-38-390 Winter road restrictions.
- 468-38-405 Superload movement criteria.
- 468-38-420 Bridge restrictions.

DISPOSITION OF SECTIONS FORMERLY CODIFIED IN THIS CHAPTER

- 468-38-035 Compliance with federal bridge law. [Statutory Authority: RCW 46.44.098. 88-01-081 (Order 65, Resolution No. 312), § 468-38-035, filed 12/21/87.] Repealed by 91-10-023 (Order 71), filed 4/23/91, effective 5/24/91.
- 468-38-090 Statutory Authority: RCW 46.44.090 and 47.01.071. Loading restrictions and requirements. [Statutory Authority: RCW 46.44.090. 83-16-018 (Order 39, Resolution No. 195), § 468-38-090, filed 7/25/83; 82-18-

- 010 (Order 31, Resolution No. 156), § 468-38-090, filed 8/20/82. Formerly WAC 468-38-370. Statutory Authority: 1977 ex.s. c 151. 79-01-033 (DOT Order 10 and Comm. Order 1, Resolution No. 13), § 468-38-090, filed 12/20/78. Formerly WAC 252-24-095.] Repealed by 00-11-019 (Order 197), filed 5/9/00, effective 6/9/00. Statutory Authority: RCW 46.44.090.
- 468-38-150 Flagpersons. [Statutory Authority: RCW 46.44.090. 82-18-010 (Order 31, Resolution No. 156), § 468-38-150, filed 8/20/82. Formerly WAC 468-38-210 and 468-38-220. Statutory Authority: 1977 ex.s. c 151. 79-01-033 (DOT Order 10 and Comm. Order 1, Resolution No. 13), § 468-38-150, filed 12/20/78. Formerly WAC 252-24-300.] Repealed by 99-07-098 (Order 190), filed 3/23/99, effective 4/23/99. Statutory Authority: RCW 46.44.090.
- 468-38-170 Amber lights on escort vehicles. [Statutory Authority: RCW 46.44.090. 82-18-010 (Order 31, Resolution No. 156), § 468-38-170, filed 8/20/82. Formerly WAC 468-38-230. Statutory Authority: 1977 ex.s. c 151. 79-01-033 (DOT Order 10 and Comm. Order 1, Resolution No. 13), § 468-38-170, filed 12/20/78. Formerly WAC 252-24-306.] Repealed by 99-07-098 (Order 190), filed 3/23/99, effective 4/23/99. Statutory Authority: RCW 46.44.090.
- 468-38-210 Two-way radio. [Statutory Authority: RCW 46.44.090. 82-18-010 (Order 31, Resolution No. 156), § 468-38-210, filed 8/20/82. Formerly WAC 468-38-250. Statutory Authority: 1977 ex.s. c 151. 79-01-033 (DOT Order 10 and Comm. Order 1, Resolution No. 13), § 468-38-210, filed 12/20/78. Formerly WAC 252-24-318.] Repealed by 99-07-098 (Order 190), filed 3/23/99, effective 4/23/99. Statutory Authority: RCW 46.44.090.
- 468-38-370 Triple saddle mounts. [Statutory Authority: RCW 46.44.090. 85-22-002 (Order 50, Resolution No. 253), § 468-38-370, filed 10/24/85; 82-18-010 (Order 31, Resolution No. 156), § 468-38-370, filed 8/20/82. Formerly WAC 468-38-450. 81-15-098 (Order 25, Resolution No. 119), § 468-38-370, filed 7/22/81. Statutory Authority: 1977 ex.s. c 151. 79-01-033 (DOT Order 10 and Comm. Order 1, Resolution No. 13), § 468-38-370, filed 12/20/78. Formerly WAC 252-24-366.] Repealed by 91-10-023 (Order 71), filed 4/23/91, effective 5/24/91. Statutory Authority: RCW 46.44.090 and 47.01.071.
- 468-38-380 Special permits for movement over state highways of overleaf size or weight loads—Construction equipment. [Statutory Authority: 1977 ex.s. c 151. 79-01-033 (DOT Order 10 and Comm. Order 1, Resolution No. 13), § 468-38-380, filed 12/20/78. Formerly WAC 252-24-369.] Repealed by 82-18-010 (Order 31, Resolution No. 156), filed 8/20/82. Statutory Authority: RCW 46.44.090. Later promulgation, see WAC 468-38-270.
- 468-38-400 Load limitations on state highways within Mount Rainier National Park. [Statutory Authority: RCW 46.44.090. 82-18-010 (Order 31, Resolution No. 156), § 468-38-400, filed 8/20/82. Formerly WAC 468-38-050. Statutory Authority: 1977 ex.s. c 151. 79-01-033 (DOT Order 10 and Comm. Order 1, Resolution No. 13), § 468-38-400, filed 12/20/78. Formerly WAC 252-24-375.] Repealed by 91-10-023 (Order 71), filed 4/23/91, effective 5/24/91. Statutory Authority: RCW 46.44.090 and 47.01.071.
- 468-38-410 Load limitations on certain state highways adjacent to Mount Rainier National Park. [Statutory Authority: RCW 46.44.090. 82-18-010 (Order 31, Resolution No. 156), § 468-38-410, filed 8/20/82. Formerly WAC 468-38-060. Statutory Authority: 1977 ex.s. c 151. 79-01-033 (DOT Order 10 and Comm. Order 1, Resolution No. 13), § 468-38-410, filed 12/20/78. Formerly WAC 252-24-378.] Repealed by 91-10-023 (Order 71), filed 4/23/91, effective 5/24/91. Statutory Authority: RCW 46.44.090 and 47.01.071.
- 468-38-430 Load limitation on State Route 11. [Statutory Authority: RCW 46.44.090. 82-18-010 (Order 31, Resolution No. 156), § 468-38-430, filed 8/20/82. Formerly WAC 468-38-140. Statutory Authority: 1977 ex.s. c 151. 79-01-033 (DOT Order 10 and Comm. Order 1, Resolution No. 13), § 468-38-430, filed 12/20/78. Formerly WAC 252-24-384.] Repealed by 86-20-030 (Order 105), filed 9/24/86. Statutory Authority: RCW 47.01.260 and 47.01.101(5).
- 468-38-440 Reservation of facilities for transit and cardoons. [Statutory Authority: RCW 46.44.090. 82-18-010 (Order 31, Resolution No. 156), § 468-38-440, filed 8/20/82. Formerly WAC 468-38-080 and 468-38-090. Statutory Authority: 1977 ex.s. c 151. 79-01-033 (DOT Order 10 and Comm. Order 1, Resolution No. 13), § 468-38-440, filed 12/20/78. Formerly WAC 252-24-387.] Repealed by 83-19-013 (Order 83), filed 9/12/83. Statutory Authority: RCW 34.04.010, 46.61.165 and 47.52.025.
- 468-38-450 Special permits for movement over state highways of overleaf size or weight loads—Triple saddle mounts. [Statutory Authority: RCW 46.44.038. 80-04-044 (Order 14, Resolution No. 71), § 468-38-450, filed 3/20/80. Statutory Authority: 1977 ex.s. c 151. 79-01-033 (DOT Order 10 and Comm. Order 1, Resolution No. 13), § 468-38-450, filed 12/20/78. Formerly WAC 252-24-390.] Repealed by 82-18-010 (Order 31, Resolution No. 156), filed 8/20/82. Statutory Authority: RCW 46.44.090. Later promulgation, see WAC 468-38-370.
- 468-38-460 Farm implements. [Statutory Authority: RCW 46.44.090. 81-15-097 (Order 24, Resolution No. 118), § 468-38-460, filed 7/22/81. Statutory Authority: 1977 ex.s. c 151. 79-01-033 (DOT Order 10 and Comm. Order 1, Resolution No. 13), § 468-38-460, filed 12/20/78. Formerly WAC 252-24-393.] Repealed by 82-18-010 (Order 31, Resolution No. 156), filed 8/20/82. Statutory Authority: RCW 46.44.090. Later promulgation, see WAC 468-38-290.

WAC 468-38-010 Three-vehicle combinations. (1) A three-vehicle combination shall consist of (a) a truck-tractor, semi-trailer and full trailer, or (b) a truck-tractor and two semi-trailers.

(2) Brakes shall be of the progressive type controlled by the foot brake and so designed that the braking effect shall start with the last axle in the combination and progress forward to the power unit.

[Statutory Authority: RCW 46.44.090. 83-16-018 (Order 39, Resolution No. 195), § 468-38-010, filed 7/25/83; 82-18-010 (Order 31, Resolution No. 156), § 468-38-010, filed 8/20/82. Statutory Authority: 1977 ex.s. c 151. 79-01-033 (DOT Order 10 and Comm. Order 1, Resolution No. 13), § 468-38-010, filed 12/20/78. Formerly WAC 252-24-010.]

WAC 468-38-020 Temporary additional tonnage permits. A permit to carry weight in addition to that authorized by the licensed gross weight may be issued under some conditions:

(1) A single-unit truck or a truck combination must be licensed to 40,000 pounds or to 80,000 pounds respectively in order to qualify for a temporary additional tonnage permit.

(2) The wheelbase of any group of axles must meet the requirements of the legal weight table in RCW 46.44.041. No single axle shall exceed 20,000 pounds; no pair of tandem axles shall exceed 34,000 pounds.

(3) The weight limits established in RCW 46.44.042 relating to tires may not be exceeded.

(4) The restrictions on highway loads required by emergency conditions pursuant to WAC 468-38-080 shall apply even though an operator has a temporary additional tonnage permit.

[Statutory Authority: RCW 46.44.090. 94-07-054 (Order 142), § 468-38-020, filed 3/11/94, effective 3/11/94; 85-22-002 (Order 50, Resolution No. 253), § 468-38-020, filed 10/24/85; 82-18-010 (Order 31, Resolution No. 156), § 468-38-020, filed 8/20/82. Statutory Authority: 1977 ex.s. c 151. 79-01-033 (DOT Order 10 and Comm. Order 1, Resolution No. 13), § 468-38-020, filed 12/20/78. Formerly WAC 252-24-020.]

WAC 468-38-030 Issuance of temporary additional tonnage permits. (1) Temporary additional tonnage permits

will be issued only to the following types of vehicles: Three or more axle full trucks; three or more axle truck-tractors; three or more axle dromedary truck-tractors, and two axle tractors to pull double trailers.

(2) Permits will not be issued to semi-trailers.

(3) The fees for temporary additional tonnage permits shall not be prorated.

(4) Temporary additional tonnage permits may be purchased when the applicant has licensed tonnage in effect for the period for which he is applying. A trip permit may be used in lieu of licensed tonnage when the requirements of RCW 46.16.160 have been met.

[Statutory Authority: RCW 46.44.090. 94-07-054 (Order 142), § 468-38-030, filed 3/11/94, effective 3/11/94; 89-23-110 (Order 68), § 468-38-030, filed 11/22/89, effective 12/23/89; 82-18-010 (Order 31, Resolution No. 156), § 468-38-030, filed 8/20/82. Statutory Authority: 1977 ex.s. c 151. 79-01-033 (DOT Order 10 and Comm. Order 1, Resolution No. 13), § 468-38-030, filed 12/20/78. Formerly WAC 252-24-030.]

WAC 468-38-040 Special log tolerance transportation permits. (1) Special log tolerance transportation permits shall be issued at all department of transportation permit offices or by agents of the department located throughout the state.

(2) A permit will be denied if the vehicle does not meet the axle distance requirements of RCW 46.44.047, i.e., the distance between the front axle and the last axle of the combination shall be at least 37 feet.

(3) Maximum gross weight of the combination shall not exceed 68,000 lbs. by more than 6800 lbs. gross.

(4) Maximum gross weight on tandem axles shall not exceed 33,600 lbs. on each set of tandem axles.

(5) Operators having special log tolerance transportation permits are subject to all posted road and bridge restrictions.

(6) Special log tolerance transportation permits may be transferred to the purchaser of a log truck or to another vehicle owned by the permittee. A fee of five dollars will be charged.

(7) Any approved route, previously granted, shall be subject to immediate cancellation if upon determination of the department of transportation the section of state highway involved is showing abnormal failure or overstress.

(8) When county roads or city streets are used to reach state highways, a permit for the use of such county roads or city streets is to be obtained from the proper county or city authorities.

(9) The fee for special log tolerance transportation permits may not be prorated.

[Statutory Authority: RCW 46.44.090. 89-23-110 (Order 68), § 468-38-040, filed 11/22/89, effective 12/23/89; 82-18-010 (Order 31, Resolution No. 156), § 468-38-040, filed 8/20/82. Statutory Authority: 1977 ex.s. c 151. 79-01-033 (DOT Order 10 and Comm. Order 1, Resolution No. 13), § 468-38-040, filed 12/20/78. Formerly WAC 252-24-040.]

WAC 468-38-050 Special permits for movement of overlegal size or weight loads. The department of transportation may issue permits for movement of overlegal size or weight loads when:

(1) Application has been made to the department and the applicant has shown that there is good cause for the move, and that the applicant is capable of making the move.

(2001 Ed.)

(2) The applicant has shown that the load cannot reasonably be dismantled or disassembled.

(3) The vehicle, combination, or load has been dismantled and made to conform to legal limitations where practical. Reductions shall be made even though the use of additional vehicles becomes necessary.

(4) The vehicle(s) and load have been thoroughly described and identified; the points of origin and destination and the route of travel have been stated and approved.

(5) The proposed move has been determined to be consistent with public safety and the permittee has shown proof of seven hundred fifty thousand dollars liability insurance for the cost of any accident, damage, or injury to any person or property resulting from the operation of the vehicle covered by the permit upon the public highways of this state: Provided, That a noncommercial operator shall have at least three hundred thousand dollars liability insurance.

(6) The permittee affirms that:

(a) The vehicles have been properly licensed to make the proposed move or carry the load described in accordance with the provisions of Washington law;

(b) The drivers are properly licensed to operate in Washington in the manner proposed.

(7) The permittee will comply with all applicable rules pertaining to the issuance of any special permit.

(8) Except as provided for in RCW 46.44.140, the original permit or certified copy must be carried on the power unit at all times the permit is in effect. Tow truck operators who have received approval by telephone to operate under permit are exempt from this requirement.

[Statutory Authority: RCW 46.44.090 and 47.01.071. 91-10-023 (Order 71), § 468-38-050, filed 4/23/91, effective 5/24/91. Statutory Authority: RCW 46.44.090. 89-23-110 (Order 68), § 468-38-050, filed 11/22/89, effective 12/23/89; 82-18-010 (Order 31, Resolution No. 156), § 468-38-050, filed 8/20/82. Formerly WAC 468-38-150. Statutory Authority: 1977 ex.s. c 151. 79-01-033 (DOT Order 10 and Comm. Order 1, Resolution No. 13), § 468-38-050, filed 12/20/78. Formerly WAC 252-24-050.]

WAC 468-38-060 Liability of permittee. Permits are granted with the specific understanding that the permittee shall be responsible and liable for accidents, damage or injury to any person or property resulting from the operation of the vehicle covered by the permit upon public highways of the state. The permittee shall hold blameless and harmless and shall indemnify the state of Washington, department of transportation, its officers, agents and employees against any and all claims, demands, loss, injury, damage, actions and costs of actions whatsoever, which any of them may sustain by reason of unlawful acts, conduct or operations of the permittee in connection with the operations covered by the permit.

[Statutory Authority: RCW 46.44.090. 82-18-010 (Order 31, Resolution No. 156), § 468-38-060, filed 8/20/82. Formerly WAC 468-38-160. Statutory Authority: 1977 ex.s. c 151. 79-01-033 (DOT Order 10 and Comm. Order 1, Resolution No. 13), § 468-38-060, filed 12/20/78. Formerly WAC 252-24-060.]

WAC 468-38-070 Maximums for special permits—Nondivisible. (1) **Overwidth:** 14 feet on any two-lane highway; 20 feet on any multiple-lane highway where a physical barrier serving as a median divider separates the oncoming

and opposing traffic lanes; 32 feet on any multiple-lane undivided highway.

The regulations on movement of buildings are in WAC 468-38-360.

(2) **Overheight:** A load over 14 feet high must be moved by permit, but the permittee is to be governed by the clearance of overhead obstructions such as bridges, underpasses, wires, overhead signs and other objects. The issuance of a permit does not insure the route to be free of low overhead structures. It is the responsibility of the permittee to check the proposed route and detour when necessary. County or city road detours for this purpose require authorization from respective jurisdictions.

(3) **Overlength:** The permit will allow movement on routes on which the permittee can negotiate curves, interchanges, entrance and exit roadways and other obstacles. In all instances the general safety of the public is considered paramount.

(4) **Loading restrictions:** The load must be reduced to a practicable minimum, even if additional vehicles are required to transport the divided item. Loads created by welding, bolting or tying will be construed as divisible, unless proven with good cause not to be divisible.

(5) **Overweight loads:** Restricted to the limits established in RCW 46.44.091 Special permits—Gross weight limit. In addition, tire loadings are limited to a maximum of six hundred pounds per inch width of tire.

(6) **Allowable vehicle configurations:**

(a) **Tractor (or unladen truck) and semi-trailer or full trailer.** Jeeps and/or boosters may be added to the trailer as necessary. Trailers in excess of the legal width of eight feet six inches, or legal length of fifty-three feet, or the permitted length of fifty-six feet, shall not exceed the length or width of the load, unless, the added dimension is necessary to spread the weight of load to comply with requirements established by the department to protect the infrastructure. A "pusher" power unit may be added to the configuration upon approval.

(b) **Tractor with semi-trailer and full trailer.** Combined trailer length, including space between trailers, may not exceed sixty-one feet. This combination is limited to nondivisible loads not to exceed ten feet wide. Both trailers may carry nondivisible loads with the widest load contained on the first trailer. This configuration may not carry over-height, over-length or over-weight loads.

(c) **Truck and trailer.** Combined overall length when carrying an over-length load may not exceed eighty-five feet, with the nondivisible over-length load restricted to the trailing unit, overhang loaded entirely to the rear of the trailer. An over-width or over-height nondivisible load may be carried on the truck and/or trailing unit. This configuration may not carry overweight loads.

(7) **Loads with multiple pieces:** An over-dimensional load may include multiple pieces, provided:

(a) The vehicle(s) and load are transported at legal weights.

(b) The largest nondivisible piece(s) must be loaded to its practicable minimum. No single piece may create a dimension greater than the dimension it would create if carried by itself.

(c) Additional pieces may not exceed the outside envelope (rectangular) dimension created by the largest piece(s) loaded in its smallest configuration. No piece shall be added to a load for the sole purpose of creating a larger envelope. It shall be the responsibility of the carrier to provide proof that all pieces are necessary to the move.

[Statutory Authority: RCW 46.44.090. 00-11-019 (Order 197), § 468-38-070, filed 5/9/00, effective 6/9/00; 98-21-019 (Order 183), § 468-38-070, filed 10/13/98, effective 11/13/98; 98-09-029 (Order 172), § 468-38-070, filed 4/10/98, effective 5/11/98; 96-23-003, § 468-38-070, filed 11/7/96, effective 12/8/96; 83-16-018 (Order 39, Resolution No. 195), § 468-38-070, filed 7/25/83; 82-18-010 (Order 31, Resolution No. 156), § 468-38-070, filed 8/20/82. Formerly WAC 468-38-170. Statutory Authority: 1977 ex.s. c 151. 79-01-033 (DOT Order 10 and Comm. Order 1, Resolution No. 13), § 468-38-070, filed 12/20/78. Formerly WAC 252-24-080.]

WAC 468-38-071 Maximums for special permits—Reducible. (1) **Overlength:** Permits for reducible loads shall not exceed 56 feet for a single trailer and 68 feet for double trailers. Measurement for a single trailer will be from the front of the trailer, or load, to the rear of the trailer, or load, whichever provides the greater distance up to 56 feet. Measurement for double trailers will be from the front of the first trailer, or load, to the rear of the second trailer, or load, whichever provides the greatest distance up to 68 feet. A log truck pulling a pole-trailer, trailer combination, carrying two distinct and separate loads will be treated as a tractor-semi-trailer-trailer (doubles). Measurement for the log truck, pole-trailer, trailer combination will be from the front of the first bunk on the truck to the rear of the second trailer, or load, whichever provides the greatest distance up to 68 feet. Measurements shall not include nonload carrying devices designed for the safe and efficient operation of the semitrailer or trailer; for example: External refrigeration unit, resilient bumper, and aerodynamic shells.

(2) **Overheight:** A vehicle, or vehicle combination, hauling empty apple bins, or owned and operated by a rancher hauling hay from the rancher's own fields for use with the rancher's own livestock, may be issued a permit, for vehicle and load, not to exceed fifteen feet high, measured from a level road bed. This permit may be used in conjunction with the overlength permit described in subsection (1) of this section.

[Statutory Authority: RCW 46.44.090. 98-21-019 (Order 183), § 468-38-071, filed 10/13/98, effective 11/13/98; 96-23-003, § 468-38-071, filed 11/7/96, effective 12/8/96.]

WAC 468-38-075 Overlength exemptions. Vehicles may move by special motor vehicle permit without regard to **oversize load** signs (WAC 468-38-190), weekend curfew or holiday restrictions (WAC 468-38-230), commuter traffic restrictions (WAC 468-38-235), or night-time movement restrictions (WAC 468-38-260), when they meet the following overlength conditions:

Tractor/trailer combinations with:

-A single trailer not exceeding fifty-six feet (including load)

-Double trailers not exceeding sixty-eight feet (including load)

-Nonreducible loads (including trailer) not exceeding sixty-one feet

-Vehicles with front overhang not exceeding four feet beyond the three foot legal limit set in RCW 46.44.034 (see also bumper criteria set in RCW 46.37.517)

-Single unit fixed load vehicles not exceeding an overall length of forty-five feet including a four foot front overhang beyond the legal three foot limit and a rear overhang not to exceed fifteen feet measured from the center of the last axle.

The aforementioned vehicles, when in compliance with WAC 204-24-050 Use of tire chains or other traction devices, are also exempt from that portion of the winter road restrictions (WAC 468-38-390) prohibiting movement in areas where any of the following signs are displayed: "Traction tires advised," "approved traction tires recommended," "approved traction tires required," or "tire chains required." The signs, however, must be obeyed.

[Statutory Authority: RCW 46.44.090. 94-07-055 (Order 143), § 468-38-075, filed 3/11/94, effective 3/11/94; 93-21-008 (Order 139), § 468-38-075, filed 10/8/93, effective 11/8/93.]

WAC 468-38-080 Emergency closure and load restrictions on state highways.

(1) Pursuant to RCW 46.44.080, when the department of transportation determines that, because of emergency conditions, vehicles whose gross tire loads exceed those described in subsection (2) of this section and will damage a highway or will endanger other traffic using a highway, it shall without delay close that highway temporarily to all vehicles or to a designated class of vehicles. Notices shall be posted at each end of the closed portion of highway and at all intersecting state highways.

(2) The department shall impose load restrictions as needed by posting either of the following signs. The conditions existing at the time shall determine which schedule of emergency load restrictions will be imposed.

EMERGENCY LOAD RESTRICTIONS

CONVENTIONAL TIRES		TUBELESS OR SPECIAL WITH .5 MARKING	
Tire Size	Gross Load Each Tire	Tire Size	Gross Load Each Tire
7.00	1800 lbs.	8-22.5	2250 lbs.
7.50	2250 lbs.	9-22.5	2800 lbs.
8.25	2800 lbs.	10-22.5	3400 lbs.
9.00	3400 lbs.	11-22.5	4000 lbs.
10.00	4000 lbs.	11-24.5	4000 lbs.
11.00	4500 lbs.	12-22.5	4500 lbs.
12.00		12-24.5	
& over	4500 lbs.	& over	4500 lbs.

SEVERE EMERGENCY LOAD RESTRICTIONS

CONVENTIONAL TIRES		TUBELESS OR SPECIAL WITH .5 MARKING	
Tire Size	Gross Load Each Tire	Tire Size	Gross Load Each Tire
7.00	1800 lbs.	8-22.5	1800 lbs.
7.50	1800 lbs.	9-22.5	1900 lbs.
8.25	1900 lbs.	10-22.5	2250 lbs.
9.00	2250 lbs.	11-22.5	2750 lbs.
10.00	2750 lbs.	11-24.5	2750 lbs.
11.00		12-22.5	
& over	3000 lbs.	& over	3000 lbs.

(a) No allowance will be made for any second rear axle that is suspended from the frame of a vehicle independent of the regular driving axle, commonly known as a "rigid trail axle." Allowance will be made for single tires only on the front axle of any truck.

(b) The load distribution on any one axle of any vehicle shall be such that it will not load the tires on that axle in excess of the prescribed load listed above: Provided, That a truck, truck tractor, passenger bus or school bus having conventional 10:00 x 20 tires or 11:00 x 22.5 tires, or larger, may carry a maximum load of 10,000 pounds on the front axle over any state highway placed under emergency load restrictions.

(3) Permits may be issued by the department of transportation to allow the operation of school buses and motor trucks transporting perishable commodities or commodities necessary for the health and welfare of local residents on such state highways as may be closed, subject to specific weight and speed restrictions as may be deemed necessary by the department of transportation.

(4) This rule shall not supersede or modify any rule in force establishing load limitations on state highway bridges.

[Statutory Authority: RCW 46.44.090. 82-18-010 (Order 31, Resolution No. 156), § 468-38-080, filed 8/20/82. Formerly WAC 468-38-130. Statutory Authority: 1977 ex.s. c 151. 79-01-033 (DOT Order 10 and Comm. Order 1, Resolution No. 13), § 468-38-080, filed 12/20/78. Formerly WAC 252-24-090.]

WAC 468-38-100 Escort car requirements. Escort cars are required:

(1) When vehicle, vehicles or load is over eleven feet in width, escort cars (both front and rear) are required on a two-lane highway.

(2) When vehicle, vehicles or load is over fourteen feet wide, one escort car in rear of movement is required on multiple-lane highways.

(3) When vehicle, vehicles or load is over twenty feet wide, escort cars in both front and rear of movement are required when the highway is a multiple-lane, undivided highway.

(4) When overall length of load, including vehicles, exceeds one hundred feet or when rear overhang of load measured from the last axle exceeds one-third of the total length, one escort car is required on two-lane highways. The permit may authorize a riding flagperson in lieu of an escort car.

(5) When overall length of load, including vehicles, exceeds one hundred forty feet, one rear escort car is required on multiple-lane highways.

(6) When in the opinion of the department of transportation, escort cars are necessary to protect the traveling public, for any overdimension and/or overweight move either across, upon, or along a highway.

[Statutory Authority: RCW 46.44.090. 89-23-110 (Order 68), § 468-38-100, filed 11/22/89, effective 12/23/89; 82-18-010 (Order 31, Resolution No. 156), § 468-38-100, filed 8/20/82. Formerly WAC 468-38-180. Statutory Authority: 1977 ex.s. c 151. 79-01-033 (DOT Order 10 and Comm. Order 1, Resolution No. 13), § 468-38-100, filed 12/20/78. Formerly WAC 252-24-100.]

WAC 468-38-110 Escort vehicle requirements. (1) When the escort vehicle is in front of the permitted vehicle, the operator shall:

(a) Warn oncoming traffic of the presence of the permitted vehicle by use of signs and lights as provided in subsections (4) and (8) of this section.

(b) Notify the driver of the permitted vehicle, and driver(s) of any trailing escorts, by two-way radio, of all hazards; overhead clearances; obstructions; traffic congestion; pedestrians; and any other circumstances evident to the operator that could affect either the safe movement of the permitted vehicle, the safety of the traveling public, or the efficient movement of traffic in sufficient time for the driver of the permitted vehicle to take corrective action, as necessary.

(c) To the extent necessary, locate safe places (if available) adjacent to the highway and notify the driver of the permitted vehicle, and driver(s) of trailing escorts, in ample time for the permitted vehicle and the escort vehicle(s) to clear the highway, allowing the traffic following to safely pass, or for any other reasons necessary to provide for the safety of the traveling public.

(d) Be far enough in front of the permitted vehicle to signal oncoming motorists to stop in a timely manner, or as specified by local jurisdiction, before such motorists enter any narrow structures or other restrictions on the highway, to permit the safe passage of the permitted vehicle.

(2) When the escort vehicle is behind the permitted vehicle, the operator shall:

(a) Warn traffic approaching from the rear of the presence of the permitted vehicle ahead, by use of signs and lights as provided in subsections (4) and (8) of this section.

(b) Notify the driver of the permitted vehicle, and driver of any lead escort, by two-way radio of flat tires or other problems with the permitted vehicle; objects coming loose from the permitted vehicle; other traffic approaching or passing the permitted vehicle; and any other circumstances evident to the operator that could affect either the safe movement of the permitted vehicle, the safety of the traveling public, or the efficient movement of traffic, in sufficient time for the driver of the permitted vehicle to take corrective action.

(c) Notify the front escort driver and the driver of the permitted vehicle by two-way radio of traffic build-up and other delays to the normal flow and efficient movement of traffic caused by the movement of the permitted vehicle.

(d) Notify the driver of the permitted vehicle, and driver of any lead escort, by two-way radio of other vehicles attempting to pass the permitted vehicle or load.

(e) Be far enough behind the permitted vehicle to signal motorists following the permitted vehicle to slow or stop in a timely manner, or as specified by local jurisdiction, before narrow structures or other restrictions in the highway, to permit the safe passage of the permitted vehicle.

(3) The escort vehicle operator shall ensure that the escort vehicle is in safe and reliable operating condition.

(4) An escort vehicle shall, in addition to any other equipment required by traffic law, be equipped with a minimum of two flashing or rotating amber lights, positioned above the roof line, visible from a minimum of five hundred feet to traffic approaching from the front or rear of the escort.

The light apparatus must not obstruct, or be obstructed by, the required OVERSIZE LOAD sign.

(5) The escort vehicle shall:

(a) Be either a single unit passenger car or a two-axle truck;

(b) Not exceed a maximum gross vehicle weight rating of fourteen thousand pounds;

(c) Be at least sixty inches wide; and

(d) Not exceed the legal limits of size and weight, as defined in chapter 46.44 RCW.

(6) The escort vehicle shall not carry any passengers, human or animal (excluding individuals in training status or necessary flag persons), or equipment or load in or on the escort vehicle which:

(a) Exceeds the height, length, or width of the escort vehicle, or overhangs the escort vehicle, or otherwise impairs its immediate recognition as a safety escort vehicle by the motoring public; or

(b) Obstructs the view of the flashing or rotating yellow lights, or the signs used by the escort vehicle; or

(c) Causes safety risks; or

(d) Otherwise impairs the performance by the operator or the escort vehicle of the duties required by these rules.

(7) The escort vehicle operator shall properly load and secure any item(s) or equipment or load carried by the escort vehicle to ensure compliance with the requirements of this section.

(8) An escort vehicle shall display "oversize load" signs, in clear readable condition, which shall be mounted above the roofline of the escort vehicle and be visible to approaching traffic from the front and the rear. All such signs shall be a minimum of five feet wide, ten inches high with one-inch wide brush stroke, black letters a minimum of eight inches high on yellow background, or shall be a maximum of seven feet wide, eighteen inches high, with a 1.41 inch brush stroke, black letters a minimum of ten inches high on yellow background.

(9) The escort vehicle(s) shall have its headlights activated at all times when escorting a permitted vehicle.

(10) The escort vehicle shall be equipped with a two-way radio capable of providing reliable two-way voice communication between the driver of the permitted vehicle and the driver(s) of the escort vehicle(s) when the permitted vehicle is in motion on a public highway.

(11) An escort vehicle shall carry the following items of equipment at all times when escorting a permitted vehicle:

(a) Standard eighteen inch STOP & SLOW paddle sign.

(b) Three bi-directional emergency reflective triangles.

(c) A minimum of one 5 pound B, C, fire extinguisher, or equivalent.

(d) A reflectorized high visibility orange or other color vest, shirt or jacket, as permitted by the *Manual on Uniform Traffic Control Devices*, and a yellow or other highly visible colored hard hat to be worn by the operator while directing traffic, in accordance with WAC 296-155-305, Signaling.

(e) A height measuring device which is nonconductive and nondestructive to overhead clearances, when required by the terms of the permit or regulations.

(f) First-aid supplies must be readily available as described in WAC 296-24-06145.

(g) A flashlight in working order with red nose cone.

(12) An escort vehicle is prohibited from escorting more than one permitted vehicle at the same time, unless expressly authorized by the department.

(13) A front escort vehicle shall use a height pole at all times when escorting a permitted vehicle exceeding fifteen feet in height, unless otherwise expressly authorized/directed by the department on the permit. The height pole shall not extend less than three inches nor more than six inches above the maximum height of the permitted vehicle being escorted. When the escort vehicle is not escorting a permitted vehicle, but is moving on the highway, the height pole shall be removed, tied down, or shortened to within legal limits, unless involved in the act of prerunning a route to determine height acceptance.

(14) When an escort vehicle is not escorting a permitted vehicle, or prerunning a route, but is moving on a public highway, the signs, described in subsection (8) of this section, shall either be removed, lowered to a position not readily visible, or covered, and the flashing yellow lights, described in subsection (4) of this section, shall not be operated.

(15) In the performance of the duties required by these rules, the operator of the escort vehicle may be required to advise the permitted vehicle to stop, allowing other traffic to proceed safely. The operator of the escort vehicle shall signal the permitted vehicle to stop, and the permitted vehicle shall stop, as far off the roadway as practicable to allow other traffic to pass in the following situations:

(a) When the permitted vehicle becomes disabled; or

(b) When the movement of the permitted vehicle on a particular section of public highway presents a safety risk or unreasonably interferes with the efficient movement of other traffic, based upon such factors as the widths of the permitted vehicle and the roadway, volume of other traffic, visibility and limited sight distance, and mountainous terrain; or

(c) When driving conditions for the permitted vehicle are hazardous for any other reason, including weather.

(16) The operator of the permitted vehicle and the operator(s) of the escort vehicle(s) shall comply with the following procedures:

(a) Before trip:

(i) Discuss aspects of the move, including the permitted vehicle, the route, and specific responsibilities.

(ii) Review permit special conditions.

(iii) Review the permitted route.

(iv) Determine the proper position of the escort vehicle(s).

(v) Establish any necessary procedures.

(vi) Check mandatory equipment, each operator being responsible for their own vehicle.

(vii) Mount signs, adjust mirrors, turn on lights.

(viii) Check each two-way radio to ensure clear communication on a selected channel.

(ix) Assure special motor vehicle permit(s) is in the possession of the appropriate operator(s).

(x) Determine if additional flagpersons will be necessary and, if so, have them available.

(b) During the trip:

(i) Obey all traffic laws.

(ii) Do not follow or precede more closely than is reasonably prudent, considering the speed of the permitted vehicle, other traffic, and highway conditions.

(iii) Do not exceed 1/2 mile distance between permitted vehicle and the escort vehicle to maintain radio contact, except when necessary to safely travel a long narrow section of highway.

(c) Traffic lights:

(i) If the front escort vehicle goes through a traffic light but the permitted vehicle does not, the escort vehicle must pull over to the right side of the highway, where practicable, to wait for the permitted vehicle.

(ii) If the permitted vehicle goes through the traffic light but the escort vehicle does not, then the permitted vehicle must pull over to the right side of the highway, where practicable, to wait for the rear escort vehicle.

(17) Compliance with the rules of this chapter requires safe consistent operating procedures for the interaction between escort vehicle, escorted load and the surrounding traffic. Operators of escort vehicles, therefore, must be certified as having received a predefined base level of training as an escort vehicle operator. An escort vehicle operator with a Washington state driver's license must have a valid Washington state escort vehicle operator certificate/card which must be on the operator's person while performing escort vehicle operator duties. Escort vehicle operators licensed to drive in Washington state and operating with current certification cards from a different jurisdiction, approved by the department, must get a Washington state escort vehicle operators card upon expiration of their current card, but not later than January 1, 2003. Escort vehicle operators with a driver's license from a jurisdiction other than Washington state may acquire a Washington state escort vehicle operator certificate/card, or operate with a certification from another department approved jurisdiction, subject to ongoing department reviews and approval of the issuing jurisdiction's certification program. A current list of approved programs will be maintained by the department's motor carrier services office. Washington state pilot/escort vehicle operator cards must be renewed every three years.

(18) When uniformed off-duty law enforcement officers act as escorts, using official police cars or motorcycles, the requirements of this section may be amended as necessary.

[Statutory Authority: RCW 46.44.090, 00-11-020 (Order 198), § 468-38-110, filed 5/9/00, effective 6/9/00; 99-08-025 (Order 191), § 468-38-110, filed 3/30/99, effective 4/30/99; 98-16-048 (Order 179), § 468-38-110, filed 7/31/98, effective 8/31/98; 82-18-010 (Order 31, Resolution No. 156), § 468-38-110, filed 8/20/82. Formerly WAC 468-38-190. Statutory Authority: 1977 ex.s. c 151, 79-01-033 (DOT Order 10 and Comm. Order 1, Resolution No. 13), § 468-38-110, filed 12/20/78. Formerly WAC 252-24-110.]

WAC 468-38-120 Transport of extra-legal manufactured housing. (1) **Purpose:** To supplement the provisions of chapter 468-38 WAC as they relate to the transport of extra-legal manufactured housing on state highways. Where conflicts with other sections of this chapter occur, the following rules apply.

(2) **Vehicle combination and size limits:**

(a) **Combination of vehicles** - The combination shall be limited to two vehicles composed of the towing vehicle and the semi-trailer designed housing unit.

(b) **Length** - The length of the manufactured housing unit must not exceed seventy-five feet, including tongue.

(c) **Width** - The width of the manufactured housing unit **must not exceed a box (base) width of sixteen feet.** The unit may have an eave provided it does not extend beyond either side by:

(i) More than thirty inches for units with box width less than sixteen feet; or

(ii) More than sixteen inches for units with box width of sixteen feet, however, **the overall width shall not, under any circumstance, exceed eighteen feet.**

(d) **Width exemptions** - External features, such as door-knobs, window fasteners, eave cap, clearance lights, and load securing devices, that extend no more than two inches on each side of the unit, are exempt from the overall width measurement.

(e) **Height** - The height of the unit is limited to the actual overhead clearance of the route.

(3) **Permits for transport:** Permits to transport extralegal manufactured housing units are issued as follows:

(a) **Annual/monthly** permits are issued only to dealers or manufacturers described in chapter 46.70 RCW or to licensed transporters described in chapter 46.76 RCW. Annual/monthly permits are restricted to units with a width less than, or equal to, a fourteen foot box plus twelve inch eave and/or a height of fifteen feet or less measured from level ground.

(b) **Single trip** permits are required for units with an overall width greater than fifteen feet or greater and/or height greater than fifteen feet measured from level ground. A single trip permit may also be issued for any unit of a lesser dimension. **Units with an overall width or height greater**

than sixteen feet must comply with WAC 468-38-405, superloads prior to having a permit issued.

(c) Permits issued in accordance with the Uniform Mobile and Modular Home Transportation Regulations of WASHTO will be subject to those regulations and will be honored by the state of Washington if issued by other states.

(4) **Escort vehicles:** Escort vehicles must comply with WAC 468-38-100, except a front escort vehicle with height pole is not required until the overall height of the unit, measured from the road surface, exceeds fifteen feet. Vehicle or load width referenced in WAC 468-38-100 must be interpreted as overall width.

(5) **Insurance:**

(a) The transporter must have insurance in effect while operating under the permit in the minimum amounts of one hundred thousand/three hundred thousand dollars bodily injury and fifty thousand dollars property damage. Escort vehicle operators shall meet the insurance requirements of RCW 46.44.180.

(b) If an accident occurs while transporting a manufactured home under permit, the transporter must immediately notify the nearest state patrol office if the damage is greater than two hundred fifty dollars to the manufactured home or greater than one hundred dollars to other vehicles or structures. Permission to continue the movement must be obtained from the state patrol.

(6) **Axles, tires and brakes** for manufactured housing unit:

(a) **Units manufactured on or after June 15, 1976,** must conform to federal HUD rules Title 24, Chapter II, Subpart J of Part 280, as in effect on September 1, 1979, and as thereafter amended.

(b) **Units manufactured prior to June 15, 1976,** or not bearing the official HUD label, must comply as follows:

width of unit at base	number of axles required	wheels w/ brakes
> 8' 6" but < 10'	2 or more	all wheels on 2 axles (towing unit w/min. 9,000 GVW ¹ , all wheels on 1 axle)
10' to 14' (under 60' long)	2 or more (3 or more if > 60' long)	all wheels on 2 axles (tires minimum 8:00 x 14.5, 10 ply)

¹ Gross vehicle weight rating which is assigned by the vehicle manufacturer.

(c) **All units exceeding fourteen feet in width** at the base must:

- (i) Have a minimum of four axles;
- (ii) Have operating brakes on all wheels;
- (iii) Not exceed the manufacturer's maximum weight rating on any tire as specified on the tire side wall;
- (iv) Not exceed the manufacturer's rating for any wheel, axle, draw bar, hitch, or other suspension component; and
- (v) Carry a minimum of two spare tires, inflated and ready for use.

(d) **Brakes must be designed** and installed to activate if the unit accidentally breaks away from the towing vehicle.

(7) **Towing vehicle requirements:**

(a) Towing vehicles must be equipped with dual wheels on the drive axle; and

(b) If the unit exceeds fourteen feet in width, the towing vehicle must have a minimum GAWR² of thirty-two thousand (32,000) pounds.

² Gross axle weight rating which is the sum of the axle ratings assigned by the axle manufacturer.

(c) Engine horsepower must be enough to maintain speeds of 45 MPH on the interstate and 35 MPH on other highways.

(8) **Signs and lights:**

(a) The *oversize load* sign must be mounted on the rear of the unit, on a horizontal plane, between five and seven feet above the road surface.

(b) In addition to any other lighting requirements by law or rule, two six-inch flashing amber lights, with a minimum of thirty-five candle power, a flashing cycle of sixty to one hundred twenty times per minute during transit, must be mounted at the rear of the trailing unit, on a horizontal plane,

at least ten feet above the road surface, and above the roof line of the towing vehicle. The lights at both locations must be separated as far as practical.

(9) Travel requirements:

(a) **Routes:** Extra-legal units must comply with the route restrictions published by the department. All units with an overall width or height of sixteen feet or greater must be approved for travel by the department on a case-by-case basis, see also WAC 468-38-405, superloads. In addition, **dealers selling extra-legal manufactured homes must advise the prospective purchaser in writing that not all state highways are approved for the transport of manufactured homes in excess of twelve feet wide.**

(b) **Speed** in transit is governed by WAC 468-38-340.

(c) **Open side covering:** Units with an open side must be covered with a rigid material such as plywood or hardboard. In lieu of the rigid material, plastic covering can be used, provided a grillwork of lumber or similar material is applied to prevent tears and/or billowing of the plastic material.

(d) **Rural travel** must maintain adequate spacing between units in transit of at least one-half mile. When following a truck, truck-tractor or trailer units must maintain a space of four hundred to five hundred feet to avoid impairing the visibility of an overtaking vehicle.

(e) **Travel in the right lane** is required except when passing or avoiding an obstacle. On two-lane highways, units must not pass other vehicles except when required to pass a slow moving vehicle which is hindering the safe flow of traffic.

(10) Decals:

(a) A decal issued by the county treasurer must be displayed on any manufactured home being transported on public highways in this state (RCW 46.44.170), except:

(i) When a unit is to enter the state;

(ii) When a unit is being moved from the manufacturer or distributor to a retail sales outlet;

(iii) When a unit is being moved from the manufacturer or distributor to a purchaser's designated location; or

(iv) When a unit is being moved between retail sales outlets.

(b) The county treasurer's transport decal shall be displayed on the rear of the manufactured home while in transport. It shall be issued at the same time as the tax certificate for manufactured home movement. If the tax certification is for a double-wide (or more) manufactured home, there must be a transport decal issued for each unit.

(c) The decal must meet the following requirements:

(i) Be at least eight and one-half inches square.

(ii) Be printed on Appleton Radiant Florescent Bristol (weight .010) or paper of comparable quality.

(iii) Be fluorescent orange in color.

(iv) Show the make, model and serial number of the manufactured home, the date issued, the name of the transporter, the transporter's WUTC permit number if required, the department of transportation special motor vehicle permit number, and the name of the county issuing the decal.

(v) Clearly display the expiration date of the decal, which must not be more than fifteen days after the date issued.

(d) Decals must not be transferred.

[Statutory Authority: RCW 46.44.090. 98-16-087 (Order 180), § 468-38-120, filed 8/5/98, effective 9/5/98; 96-18-053, § 468-38-120, filed 8/30/96, effective 9/30/96; 95-24-073, § 468-38-120, filed 12/4/95, effective 1/4/96; 87-20-040 (Order 62, Resolution No. 307), § 468-38-120, filed 10/1/87; 86-21-115 (Order 58, Resolution No. 286), § 468-38-120, filed 10/21/86. Statutory Authority: RCW 46.44.170. 85-22-003 (Order 51, Resolution No. 254), § 468-38-120, filed 10/24/85. Statutory Authority: RCW 46.44.090. 83-16-018 (Order 39, Resolution No. 195), § 468-38-120, filed 7/25/83; 82-18-010 (Order 31, Resolution No. 156), § 468-38-120, filed 8/20/82. Statutory Authority: 1977 ex.s. c 151. 79-01-033 (DOT Order 10 and Comm. Order 1, Resolution No. 13), § 468-38-120, filed 12/20/78. Formerly WAC 252-24-150.]

WAC 468-38-130 Lights—Stop and turn signals. Permits will be issued to move only vehicles equipped with brake lights and turn signals as required by RCW 46.37.200.

[Statutory Authority: RCW 46.44.090. 82-18-010 (Order 31, Resolution No. 156), § 468-38-130, filed 8/20/82. Formerly WAC 468-38-410. Statutory Authority: 1977 ex.s. c 151. 79-01-033 (DOT Order 10 and Comm. Order 1, Resolution No. 13), § 468-38-130, filed 12/20/78. Formerly WAC 252-24-200.]

WAC 468-38-135 Transportation of radioactive or hazardous materials. Under provision of chapter 47.48 RCW, the chief of the Washington state patrol or the secretary of transportation or their designees may close a section (or sections) of highways of the state to transporters of placarded radioactive or hazardous cargo because of weather or other conditions that create a substantial risk to public safety. The department of transportation and Washington state patrol shall exchange notices of conditions requiring the closure of the highway and when conditions enable the closure to be terminated. The Washington state patrol or department of transportation shall manually control traffic until the closure is terminated or, if appropriate, until the time the department of transportation installs traffic control devices related to the closure. The Washington state patrol shall provide notice of both the imposition and lifting of the closure to placarded transporters through notices to news media, affected local law enforcement agencies, and other appropriate organizations, both public and private.

[Statutory Authority: RCW 47.01.270, 47.48.010 and 47.48.050. 84-05-045 (Order 89), § 468-38-135, filed 2/21/84.]

WAC 468-38-140 Flags. All flags shall be clean, bright red flags at least 12 inches square. They shall be displayed so as to wave freely on all four corners of overwidth objects and at the extreme ends of all protrusions, projections, or overhangs.

[Statutory Authority: RCW 46.44.090. 82-18-010 (Order 31, Resolution No. 156), § 468-38-140, filed 8/20/82. Formerly WAC 468-38-200. Statutory Authority: 1977 ex.s. c 151. 79-01-033 (DOT Order 10 and Comm. Order 1, Resolution No. 13), § 468-38-140, filed 12/20/78. Formerly WAC 252-24-210.]

WAC 468-38-160 Rear-view mirrors for overwidth loads. Rear-view mirrors shall be mounted in compliance

with RCW 46.37.400. Escort vehicles may be used in lieu of the distance requirement.

All escort vehicles must be equipped with outside rear-view mirrors on each side of the vehicle.

[Statutory Authority: RCW 46.44.090. 98-16-088 (Order 181), § 468-38-160, filed 8/5/98, effective 9/5/98; 89-23-110 (Order 68), § 468-38-160, filed 11/22/89, effective 12/23/89; 82-18-010 (Order 31, Resolution No. 156), § 468-38-160, filed 8/20/82. Statutory Authority: 1977 ex.s. c 151. 79-01-033 (DOT Order 10 and Comm. Order 1, Resolution No. 13), § 468-38-160, filed 12/20/78. Formerly WAC 252-24-303.]

WAC 468-38-180 Brakes. (1) Every motor vehicle or combination of motor drawn vehicles shall be capable, at all times and under all conditions of loading, of being stopped on a dry, smooth, level road free from loose material, upon application of the service brake, within a distance of 50 feet decelerating from 20 miles per hour.

(2) Permits will not be issued to equipment "in tow" without brakes unless a three axle truck with a minimum unladen weight of 15,000 pounds is employed as the power unit and is equipped with sufficient power and brakes to control at all times the vehicle being towed, in accordance with subsection (1) of this section.

(3) All vehicles must meet the requirements of chapter 46.37 RCW relating to brakes unless it is specifically stated on the permit that the vehicle is exempted from these requirements.

[Statutory Authority: RCW 46.44.090. 82-18-010 (Order 31, Resolution No. 156), § 468-38-180, filed 8/20/82. Formerly WAC 468-38-400. Statutory Authority: 1977 ex.s. c 151. 79-01-033 (DOT Order 10 and Comm. Order 1, Resolution No. 13), § 468-38-180, filed 12/20/78. Formerly WAC 252-24-309.]

WAC 468-38-190 Signs. Oversize load signs (at least 7 feet long and 18 inches high with black lettering at least 10 inches high in 1.41 inch brush stroke on yellow background) will be mounted on the front of the towing vehicle and on the rear of the load or trailing unit. Signs are not required on loads that are overweight only. If the nature of the towing vehicle or load is such that the sign cannot be mounted five feet above the roadway surface, it shall be placed above the front bumper or as high as practicable on the vehicle or load. Such signs are to be displayed only when the unit is in transit and must be removed or retracted at all other times. Such signs shall be clean and clearly legible at a distance of five hundred feet during clear weather.

Oversize load signs on escort cars shall be at least 5 feet long, 10 inches high with black lettering at least 8 inches high in 1-inch brush stroke on yellow background. The sign shall be mounted over the roof of the escort car and shall be displayed only during transit and shall be removed or retracted at all other times.

[Statutory Authority: RCW 46.44.090. 92-22-074 (Order 132), § 468-38-190, filed 11/2/92, effective 12/3/92. Statutory Authority: RCW 46.44.090 and 47.01.071. 91-10-022 (Order 70), § 468-38-190, filed 4/23/91, effective 5/24/91. Statutory Authority: RCW 46.44.090. 82-18-010 (Order 31, Resolution No. 156), § 468-38-190, filed 8/20/82. Formerly WAC 468-38-240. Statutory Authority: 1977 ex.s. c 151. 79-01-033 (DOT Order 10 and Comm. Order 1, Resolution No. 13), § 468-38-190, filed 12/20/78. Formerly WAC 252-24-312.]

WAC 468-38-200 Safety chains and devices. Special permits will not authorize the operation of any vehicle upon the public highways of this state without having the load thereon securely fastened and protected by safety chains or other load securing device pursuant to the Code of Federal Regulations, Title 49, part 393.100. Dragging of load on the roadway will not be permitted. Vehicles with a boom or structural erection member attached thereto must have the boom or member secured in such a manner that it will not elevate or sway in transportation.

[Statutory Authority: RCW 46.44.090. 89-23-110 (Order 68), § 468-38-200, filed 11/22/89, effective 12/23/89; 82-18-010 (Order 31, Resolution No. 156), § 468-38-200, filed 8/20/82. Formerly WAC 468-38-420. Statutory Authority: 1977 ex.s. c 151. 79-01-033 (DOT Order 10 and Comm. Order 1, Resolution No. 13), § 468-38-200, filed 12/20/78. Formerly WAC 252-24-315.]

WAC 468-38-220 Moves in convoy. Vehicles traveling under permit authority requiring pilot cars may not travel in convoy, unless they are moving farm implements.

[Statutory Authority: RCW 46.44.090. 82-18-010 (Order 31, Resolution No. 156), § 468-38-220, filed 8/20/82. Formerly WAC 468-38-360. Statutory Authority: 1977 ex.s. c 151. 79-01-033 (DOT Order 10 and Comm. Order 1, Resolution No. 13), § 468-38-220, filed 12/20/78. Formerly WAC 252-24-321.]

WAC 468-38-230 Days on which permit movements are prohibited. Overdimensional movements, and overweight vehicles that cannot maintain the speed of the surrounding traffic flow, are prohibited on the holidays of New Year's Day, Memorial Day, Independence Day, Labor Day, Thanksgiving Day, Christmas Day, and during the afternoon of the day preceding said holidays. Should any of the holidays fall on a Saturday or Sunday, the preceding Friday or the following Monday shall be considered such holiday.

[Statutory Authority: RCW 46.44.090. 98-24-024 (Order 185), § 468-38-230, filed 11/23/98, effective 12/24/98; 92-22-074 (Order 132), § 468-38-230, filed 11/2/92, effective 12/3/92; 89-23-110 (Order 68), § 468-38-230, filed 11/22/89, effective 12/23/89; 82-18-010 (Order 31, Resolution No. 156), § 468-38-230, filed 8/20/82. Formerly WAC 468-38-260. Statutory Authority: 1977 ex.s. c 151. 79-01-033 (DOT Order 10 and Comm. Order 1, Resolution No. 13), § 468-38-230, filed 12/20/78. Formerly WAC 252-24-324.]

WAC 468-38-235 Commuter traffic restrictions. Vehicles operating under a special motor vehicle permit for overweight, where the vehicle cannot maintain the speed of the surrounding traffic flow, and vehicles operating under a special motor vehicle permit for overdimensional features may be restricted from specified sections of state highways having excessive volumes of traffic during the morning and evening commuting hours. The department shall identify and publish, as an addendum to the special motor vehicle permit, specific areas and hours relating to the restrictions. Movement of empty equipment trailers up to ten feet wide may be allowed during such hours.

[Statutory Authority: RCW 46.44.090. 92-22-074 (Order 132), § 468-38-235, filed 11/2/92, effective 12/3/92; 84-04-011 (Order 40, Resolution No. 210), § 468-38-235, filed 1/20/84; 82-18-010 (Order 31, Resolution No. 156), § 468-38-235, filed 8/20/82. Formerly WAC 468-38-300.]

WAC 468-38-240 Cargo prohibition on reversible lane roadways. Trucks carrying flammable liquid cargoes are prohibited from using the reversible lanes on SR 5, Seattle freeway, between James Street and 110th Street N.E. The term "flammable liquid" as applied to this rule shall be as defined in RCW 46.04.210.

[Statutory Authority: RCW 46.44.090. 82-18-010 (Order 31, Resolution No. 156), § 468-38-240, filed 8/20/82. Formerly WAC 468-38-070. Statutory Authority: 1977 ex.s. c 151. 79-01-033 (DOT Order 10 and Comm. Order 1, Resolution No. 13), § 468-38-240, filed 12/20/78. Formerly WAC 252-24-327.]

WAC 468-38-250 Days on which permits are issued. Permits may be purchased at any authorized department of transportation office or agency Monday through Friday during normal business hours. Permits are not available on Saturdays, Sundays, or legal holidays. Permits may be purchased at ports of entry on the interstate highway system twenty-four hours a day, seven days a week, excluding legal holidays.

[Statutory Authority: RCW 46.44.090. 89-23-110 (Order 68), § 468-38-250, filed 11/22/89, effective 12/23/89; 82-18-010 (Order 31, Resolution No. 156), § 468-38-250, filed 8/20/82. Formerly WAC 468-38-270. Statutory Authority: 1977 ex.s. c 151. 79-01-033 (DOT Order 10 and Comm. Order 1, Resolution No. 13), § 468-38-250, filed 12/20/78. Formerly WAC 252-24-330.]

WAC 468-38-260 Night-time movements. Vehicles or combinations operating under special motor vehicle permits that are overweight and/or overdimensional may be permitted to move at night on state highways, subject to department preferred hours/routes of travel, and in compliance with published curfew restrictions. "Night-time movement approved" must be stated on the permit. Night means one-half hour after sunset to one-half hour before sunrise. Those oversize loads that are allowed to move at night shall have lighting equipment as required by the Code of Federal Regulations, Title 49, part 393.11. No movements shall be made when visibility is reduced to less than five hundred feet or when hazardous roadway conditions exist (including, but not limited to: Snow, ice, mud slide, wind or water flooding over roadway). It shall be the responsibility of the permittee to discontinue movement and remove the unit from the highway when any of the above conditions exist which could create an unsafe movement.

[Statutory Authority: RCW 46.44.090. 98-12-063 (Order 177), § 468-38-260, filed 6/1/98, effective 6/1/98; 92-22-074 (Order 132), § 468-38-260, filed 11/2/92, effective 12/3/92. Statutory Authority: RCW 46.44.090 and 47.01.071. 91-10-023 and 91-10-054 (Orders 71 and 71A), § 468-38-260, filed 4/23/91 and 4/29/91, effective 5/24/91 and 5/30/91. Statutory Authority: RCW 46.44.090. 89-23-110 (Order 68), § 468-38-260, filed 11/22/89, effective 12/23/89; 82-18-010 (Order 31, Resolution No. 156), § 468-38-260, filed 8/20/82. Formerly WAC 468-38-290. Statutory Authority: 1977 ex.s. c 151. 79-01-033 (DOT Order 10 and Comm. Order 1, Resolution No. 13), § 468-38-260, filed 12/20/78. Formerly WAC 252-24-333.]

WAC 468-38-265 Emergency operation of tow trucks. The permitting of overweight tow trucks that respond to emergencies shall be governed by the following procedures:

(1) Emergency situations are limited to those instances in which a vehicle is disabled on the public streets or highways, and due to the necessity for an immediate response (referred

to as the "initial tow truck service" in RCW 46.44.015), the appropriate overweight permit cannot be determined until the operator arrives at the disabled vehicle.

(2) When a tow truck operator has been called to respond to an emergent situation, the operator will telephone the Ridgefield Port of Entry and request a permit to clear the obstacle. The commercial vehicle enforcement officer on duty shall consult the map "*Washington State Highways Tow Truck Restrictions: For Emergency Use Only* (as last revised)." Bridges that may be crossed by tandem axle loadings estimated by the tow truck operator may be approved for the emergency move.

(3) In requesting the permit, the operator shall state the excess weight needed, list the state route numbers required and an estimate of miles to be traveled. The operator will advise the officer of his credit card number to which the permit fee can be charged and be issued an identification or clearance number for the trip being permitted. This approval is for state routes only and gives no authorization for movement on county roads or city streets.

(4) If the map showing tow truck restrictions does not indicate that the routes can safely tolerate the weight being requested, the tow truck operator is limited to moving the vehicle off the road to the nearest place of safety. When the weight is too heavy to be moved on some bridges or highways, a request during regular working hours for a permit and a bridge analysis will be required before the load may be transported.

(5) Permits for routine movements other than emergency tow truck moves shall be requested through available DOT permits offices, agents or facsimile services.

[Statutory Authority: RCW 46.44.090. 95-24-074, § 468-38-265, filed 12/4/95, effective 1/4/96.]

WAC 468-38-270 Construction equipment. Pursuant to RCW 46.44.091(3), permits may be issued to move equipment on approved highways whose single axle weight is not more than 45,000 pounds if operating on single pneumatic tires having a rim width of 20 inches or more and a rim diameter of 24 inches or more. If the vehicle has dual pneumatic tires, the rim width shall be at least 16 inches and the rim diameter shall be at least 24 inches.

[Statutory Authority: RCW 46.44.090. 82-18-010 (Order 31, Resolution No. 156), § 468-38-270, filed 8/20/82. Formerly WAC 468-38-380. Statutory Authority: 1977 ex.s. c 151. 79-01-033 (DOT Order 10 and Comm. Order 1, Resolution No. 13), § 468-38-270, filed 12/20/78. Formerly WAC 252-24-336.]

WAC 468-38-280 Special equipment. Special equipment employing axle groupings other than the conventional single or tandem axle must first be approved by the department before permits will be granted authorizing the unit to operate on state highways.

A retractable axle carrying weight allowed under RCW 46.44.041 shall have a manufacturers rating of at least 10,000 pounds, and shall be self-steering: Provided, Any variable control, excluding a simple up and down control, used to adjust axle loadings by regulating air pressure or by other means must be out of reach of the driver's compartment: And Provided Further, The requirement that the retractable lift

axle shall be self-steering does not apply to a truck/tractor where the retractable axle equipped with four tires is used to create a tandem and the distance between the drive axle and the retractable axle is no greater than 60 inches. The self-steering requirement shall also not apply to a trailing unit where the distance between a fixed axle and the retractable axle is no greater than 60 inches.

[Statutory Authority: RCW 46.44.090, 95-24-075, § 468-38-280, filed 12/4/95, effective 1/4/96; 93-19-056 (Order 138), § 468-38-280, filed 9/10/93, effective 10/11/93; 85-22-002 (Order 50, Resolution No. 253), § 468-38-280, filed 10/24/85; 82-18-010 (Order 31, Resolution No. 156), § 468-38-280, filed 8/20/82. Formerly WAC 468-38-390. Statutory Authority: 1977 ex.s. c 151, 79-01-033 (DOT Order 10 and Comm. Order 1, Resolution No. 13), § 468-38-280, filed 12/20/78. Formerly WAC 252-24-339.]

WAC 468-38-290 Farm implements. (1) A farm implement includes any device that directly affects the production of agricultural products, including fertilizer and chemical applicator rigs and equipment auxiliary to them. For purposes of this section, it must weigh less than forty-five thousand pounds, be less than twenty feet in width, and move on pneumatic tires, or solid rubber tracks having protuberances that will not hurt the highway, when on public highways.

(2) Self-propelled farm implements, including a farm tractor pulling no more than two implements (no vehicle capable of carrying a load may pull more than one trailing implement, i.e., a truck of any kind) up to sixteen feet wide are exempt from acquiring a special motor vehicle permit for movement: Provided, That the movement of the implement(s) complies with the following safety requirements:

(a) Oversize signs: If the farm implement exceeds ten feet wide, it must display an "oversize load" sign(s) visible to both oncoming and overtaking traffic. Signs must comply with the requirements of WAC 468-38-190. If the implement is both preceded and followed by escort vehicles a sign will not be required on the implement itself.

(b) Curfew/commuter hours: Movement of a farm implement in excess of ten feet wide must also comply with any published curfew or commuter hour restrictions.

(c) Red flags: If the farm implement, moving during daylight hours, exceeds ten feet wide, the vehicle configuration must display clean, bright red flags at least twelve inches square, so as to wave freely at all four corners, or extremities, of the overwidth implement and at the extreme ends of all protrusions, projections or overhangs. If the transported implement exceeds the end of the trailer by more than four feet, one flag is required at the extreme rear, also, if the width of the protrusion exceeds two feet, there shall be required two flags at the rear of the protrusion to indicate the maximum width.

(d) Warning lights: Lamps, and other lighting must be in compliance with RCW 46.37.160 Hazard warning lights and reflectors on farm equipment—Slow moving vehicle emblem. The slow moving vehicle emblem is for equipment moving at a speed of twenty-five miles per hour or less.

(e) Convoys: Farm implement convoys shall maintain at least five hundred feet between vehicles to allow the traveling public room to pass safely. If five or more vehicles become lined up behind an implement, escorted or unescorted, the driver/operator of the transported implement,

and escorts, if any, shall pull off the road at the first point wide enough to allow traffic to pass safely. Convoying of farm implements is permitted with properly equipped escort vehicles.

(f) Escort vehicles: In general, the use of escort vehicles must comply with WAC 468-38-110 Escort vehicle requirements and WAC 468-38-100, which covers when escort vehicles are required. The following specific exemptions are provided:

(i) A farmer, farm implement dealer, or agri-chemical dealer (including employees of each) is exempt from WAC 468-38-110 (5)(a) and (b), (6) relative to passengers, WAC 468-38-110 (11)(e), and (17) when moving a farm implement off of the interstate and on the following rural interstate segments:

I-90 between Exit 109 (Ellensburg) and Exit 270 (Tyler);

I-82 between junction with I-90 (Ellensburg) and Exit 31 (Yakima);

I-82 between Exit 37 (Union Gap) and the Washington/Oregon border;

I-182 between junction with I-82 (West Richland) and junction with SR-395;

I-5 between Exit 208 (near Marysville) and Exit 250 (near Bellingham).

(ii) On two-lane highways, one escort vehicle must precede the implement(s) and one escort vehicle must follow the implement(s) when the width exceeds twelve and one-half feet wide; implements not exceeding twelve and one-half feet wide are exempt from using escort vehicles.

(iii) On multiple-lane highways, one escort in the rear is required if the vehicle exceeds fourteen feet wide.

(iv) A flagperson(s) may be used in lieu of an escort(s) for moves of less than five hundred yards. This allowance must be stated on any permit that may be required for the move.

(g) Road posting: Posting a route may be used in lieu of escort vehicles if the route to be traveled is less than two miles. Signs reading "oversize vehicle moving ahead" on a square at least three feet on each side (in diamond configuration), with black lettering on orange background, shall be placed at points before the oversize implement enters or leaves the highway and at any entry points along the way. The signs must be removed immediately after the move has been completed.

(3) Farm implements exceeding sixteen feet wide, but not more than twenty feet wide, are required to have a special motor vehicle permit for movement on state highways. A quarterly or annual permit may be purchased by a farmer, or any person engaged in the business of selling and/or maintaining farm implements, to move within a designated area, generally three to four counties. The permit is required to be physically present at the time of movement. In addition to the safety requirements listed in subsection (2) of this section, notification of a move should be made to all Washington department of transportation maintenance areas affected by the move, to determine if the route is passable. Phone listings are provided with each permit.

[Statutory Authority: RCW 46.44.090, 00-17-060, § 468-38-290, filed 8/9/00, effective 9/9/00; 00-11-038 (Order 199), § 468-38-290, filed 5/10/00, effective 6/10/00; 99-18-019 (Order 192), § 468-38-290, filed 8/23/99, effective 9/23/99.]

tive 9/23/99; 85-11-062 (Order 46, Resolution No. 243), § 468-38-290, filed 5/20/85; 83-16-018 (Order 39, Resolution No. 195), § 468-38-290, filed 7/25/83; 82-18-010 (Order 31, Resolution No. 156), § 468-38-290, filed 8/20/82. Formerly WAC 468-38-460. Statutory Authority: 1977 ex.s. c 151. 79-01-033 (DOT Order 10 and Comm. Order 1, Resolution No. 13), § 468-38-290, filed 12/20/78. Formerly WAC 252-24-342.]

WAC 468-38-300 Drawbar—Towlines. The drawbar or other connection between vehicles in combination shall be of sufficient strength to hold the weight of the towed vehicle on any grade where operated. No trailer shall whip, weave, or oscillate or fail to follow substantially in the course of the towing vehicle. When a disabled vehicle is being towed by means of a bar, chain rope, cable or similar means and the distance between the towed vehicle and the towing vehicle exceeds 15 feet, there shall be fastened on such connection in approximately the center thereof a white flag or cloth not less than 12 inches square.

[Statutory Authority: RCW 46.44.090. 82-18-010 (Order 31, Resolution No. 156), § 468-38-300, filed 8/20/82. Formerly WAC 468-38-430. Statutory Authority: 1977 ex.s. c 151. 79-01-033 (DOT Order 10 and Comm. Order 1, Resolution No. 13), § 468-38-300, filed 12/20/78. Formerly WAC 252-24-345.]

WAC 468-38-310 Adverse weather. Moves may not be made when visibility is reduced to less than 1,000 feet or under hazardous roadway conditions deemed unsafe by the department of transportation or the Washington state patrol.

[Statutory Authority: RCW 46.44.090. 82-18-010 (Order 31, Resolution No. 156), § 468-38-310, filed 8/20/82. Statutory Authority: 1977 ex.s. c 151. 79-01-033 (DOT Order 10 and Comm. Order 1, Resolution No. 13), § 468-38-310, filed 12/20/78. Formerly WAC 252-24-348.]

WAC 468-38-320 Enforcement officer may restrict movements. When movements by permit are being made, and adverse weather conditions arise, an enforcement officer, at his discretion, may require the driver of the vehicle or combination to pull off the highway. He may direct or escort a vehicle to a place of safety where it may be parked until weather conditions abate and the movement can be resumed under safe operating conditions. The Washington state patrol may determine that such weather conditions exist that certain classes of vehicle may not traverse the highway until those conditions abate.

[Statutory Authority: RCW 46.44.090. 82-18-010 (Order 31, Resolution No. 156), § 468-38-320, filed 8/20/82. Statutory Authority: 1977 ex.s. c 151. 79-01-033 (DOT Order 10 and Comm. Order 1, Resolution No. 13), § 468-38-320, filed 12/20/78. Formerly WAC 252-24-351.]

WAC 468-38-330 Consideration of traveling public. When five or more vehicles line up behind an oversize load, the unit is to be removed from the roadway at a place of safety and temporarily stopped until the traffic has cleared.

[Statutory Authority: RCW 46.44.090. 82-18-010 (Order 31, Resolution No. 156), § 468-38-330, filed 8/20/82. Statutory Authority: 1977 ex.s. c 151. 79-01-033 (DOT Order 10 and Comm. Order 1, Resolution No. 13), § 468-38-330, filed 12/20/78. Formerly WAC 252-24-354.]

WAC 468-38-340 Speed limits. (1) Unless otherwise stated, maximum speeds for vehicles, combination of vehicles, or vehicles and loads being operated under permit shall be as posted for trucks.

(2001 Ed.)

(2) When travel on the roadway shoulder is required on a two-lane highway to allow overtaking traffic to pass, the speed will not exceed 25 miles per hour.

(3) The speed limit contained in a permit is listed as one of the conditions upon which the permit has been issued. This stated speed limit shall not be exceeded, but if a lower limit is posted on any highway, it shall take precedence. Violation of the speed limit contained in the permit will render the permit null and void.

(4) Speed limits shall be as follows:

(a) On two-lane highways in rural areas, 45 miles per hour.

(b) On multiple-lane highways (for all moves including 12-foot width), as posted.

(c) On multiple-lane highways (for moves over 12-foot width), 50 miles per hour.

[Statutory Authority: RCW 46.44.090. 82-18-010 (Order 31, Resolution No. 156), § 468-38-340, filed 8/20/82. Statutory Authority: 1977 ex.s. c 151. 79-01-033 (DOT Order 10 and Comm. Order 1, Resolution No. 13), § 468-38-340, filed 12/20/78. Formerly WAC 252-24-357.]

WAC 468-38-350 Lane of travel. The vehicle or combination moving by permit shall be operated in the right lane except when passing or when required to accommodate the height of the load.

[Statutory Authority: RCW 46.44.090. 89-23-110 (Order 68), § 468-38-350, filed 11/22/89, effective 12/23/89; 82-18-010 (Order 31, Resolution No. 156), § 468-38-350, filed 8/20/82. Statutory Authority: 1977 ex.s. c 151. 79-01-033 (DOT Order 10 and Comm. Order 1, Resolution No. 13), § 468-38-350, filed 12/20/78. Formerly WAC 252-24-360.]

WAC 468-38-360 Building/house moves. The following requirements control the movement of buildings or houses that do not meet the requirements for manufactured housing or mobile homes (discussed in WAC 468-38-120).

(1) Vehicles/loads not exceeding eighty thousand pounds and sixteen feet wide may be moved on two lane highways with permit, and vehicles/loads not exceeding twenty feet wide may be moved on multiple lane highways with a median barrier or median strip, with permit. Exceptions to these limitations may be proposed to the district administrator, or designee, for review and final determination, assuming compliance with the remaining conditions contained herein.

(2) The maximum distance a structure, exceeding the above dimensions, may move is five miles. Additional contiguous five-mile permits shall not be issued to exceed the five-mile limitation. An exemption may be granted by the district administrator, or designee, if the permittee can justify the move as in the public interest or as the avoidance of extreme hardship. Justification will generally require independent documented evidence supporting the basis for the move, to include, but not be limited to: Cost, equity, and sales data; historic significance; public benefit; or national defense.

(3) An application for move must be completed and submitted to the district administrator, or designee, at least ten working days before the scheduled move. The application (form number DOT 720-028) must show, at a minimum: The owner, the mover, proposed route - complete with traffic control plan, a physical description of the structure, arrange-

ments for moving overhead obstacles, the number and configuration of hauling vehicles (towing unit, dollies, etc.), and any additional requirements outlined in this section.

(4) When deemed necessary a department of transportation employee shall make a visual inspection of the structure, hauling vehicles, and proposed route. This inspection shall, at a minimum, verify dimensions (to include eaves, porches, and other appurtenances that could not be removed without affecting structural integrity), check for appropriate strapping for brick/masonry, verify that all overhead obstacles have been identified, insure that dollies are not equipped with hard rubber or solid cushion rubber tires, verify the tow vehicles (a back-up vehicle may be required on site for the move) have a valid certificate of inspection from the Washington state patrol, and determine if state forces will be required for the move (state force work will be estimated and paid by the permittee in advance, with actual costs being determined and a billing/refund occurring of any adjustment at the end of the move). Necessary equipment to make the inspection, such as a ladder, will be provided on site by the owner or mover.

(5) The maximum speed shall not exceed twenty-five miles per hour. Time allotted for traffic delays shall be at district discretion, but shall not exceed five minutes. Reasonable accessibility for emergency vehicles to navigate around the load shall be maintained.

(6) Special escort car requirements may be imposed to assure the movement will be made under the safest possible conditions. Documentation must be provided that shows the escort vehicle operators and accompanying flagpersons have been certified by the department of labor and industries. Hard hats and vests will be required for all flagpersons directing/controlling traffic during the movement.

(7) The applicant shall notify the Washington state patrol forty-eight hours in advance of the scheduled move, providing the Washington state patrol with time and route. The district may require the applicant to have the Washington state patrol assist with traffic control, the cost to be borne by the permittee.

(8) Routes involving the movement of overhead traffic signals, wires, and/or mast arms must be approved by the district traffic engineer.

(9) If railroad tracks are to be crossed, the appropriate railroad company shall be notified by the applicant and a copy of the railroad's schedule for those crossings will be submitted with the traffic control plan and application.

(10) Generally loads of two hundred thousand pounds must be approved by the bridge conditions branch in Olympia if structures are to be crossed. Per RCW 46.44.091(6), the written request must be submitted thirty days in advance of the planned move.

(11) Per WAC 468-38-050, the permittee must provide proof of insurance in the following amounts: Commercial operators shall have at least seven hundred fifty thousand dollars liability and noncommercial operators shall have at least three hundred thousand dollars liability.

[Statutory Authority: RCW 46.44.090. 93-04-071 (Order 136), § 468-38-360, filed 1/29/93, effective 3/1/93; 82-18-010 (Order 31, Resolution No. 156), § 468-38-360, filed 8/20/82. Formerly WAC 468-38-440. Statutory Authority: 1977 ex.s. c 151. 79-01-033 (DOT Order 10 and Comm. Order 1, Resolution No. 13), § 468-38-360, filed 12/20/78. Formerly WAC 252-24-363.]

WAC 468-38-390 Winter road restrictions. During periods when "emergency load restrictions" or "severe emergency load restrictions" are in effect, only vehicles equipped with tires required by WAC 468-38-080 may operate under permit. Movement by permit of units whether driven, towed or hauled is prohibited in areas where any of the following signs are displayed: "Traction tires advised," "approved traction tires recommended," "approved traction tires required," or "tire chains required."

Special permits for movements over mountain passes (Snoqualmie, Stevens, Sherman, Blewett, White and Satus) will not be valid during periods when snow is falling to a degree that visibility is limited to less than 1,000 feet; immediately following a severe storm when snow removal equipment is operating; when fog or rain limits visibility to less than 1,000 feet; or when compact snow and ice conditions require the use of chains. If hazardous conditions are encountered after a move is undertaken, it shall be the responsibility of the permittee to remove the oversize load from the highway, and he shall not proceed until conditions have abated and he has obtained clearance from the nearest department of transportation office or the Washington state patrol.

The secretary of transportation may issue special permits for department vehicles used for snow removal or the sanding of highways during emergency winter conditions. Such permits shall also be valid for vehicles in transit to or from the work site. Limitations on movement during hours of the day or days of the week may be waived. Sign requirements may be waived if weather conditions render such signs ineffectual. Movements at night may be made only by department vehicles whose lights meet the standards for emergency maintenance vehicles established by the commission on equipment.

[Statutory Authority: RCW 46.44.090. 92-22-074 (Order 132), § 468-38-390, filed 11/2/92, effective 12/3/92; 89-23-110 (Order 68), § 468-38-390, filed 11/22/89, effective 12/23/89; 82-18-010 (Order 31, Resolution No. 156), § 468-38-390, filed 8/20/82. Formerly WAC 468-38-280. Statutory Authority: 1977 ex.s. c 151. 79-01-033 (DOT Order 10 and Comm. Order 1, Resolution No. 13), § 468-38-390, filed 12/20/78. Formerly WAC 252-24-372.]

WAC 468-38-405 Superload movement criteria. (1) Superloads are defined as loads exceeding two hundred thousand pounds gross weight, and/or loads whose dimensions exceed either sixteen feet in height or sixteen feet in width.

(2) Pursuant to RCW 46.44.091(6), loads exceeding the two hundred thousand pounds gross weight must submit a written application for special permit at least thirty days in advance of the proposed move.

(3) Application for special permit to move a load in excess of sixteen feet high or sixteen feet wide must be submitted in writing at least seven calendar days before the proposed move.

(4) As part of the superload application the applicant must submit the following information:

(a) Documentation that the move is in the public interest and that alternative methods of transport are not feasible.

(b) A schematic or photograph of the item with an explanation of why it cannot be transported in smaller pieces must be provided.

(c) A schematic of the transporting laden vehicle(s), including axle loadings, axle spacings (measured from hub

centers), tire sizes, number of tires per axle, and combination vehicle/load height, length and width.

(d) A traffic control plan depicting the route and specific procedures that will be followed to control traffic flow along the route, including estimated traffic delays, lane restriction, use of escort vehicles and flag persons, movement of overhead obstacles, railroad schedules for crossings, and provisions for emergency vehicles to navigate around the load.

(5) If the department determines that the move is necessary, an analysis of structures and pavements will be performed. If, due to the size of the load, the analysis will require a significant expenditure of time by department staff, the applicant may be required to share in those costs.

(6) If structures or pavements are found to be inadequate, and an alternative route cannot be found, the application for special permit will be denied. The load will have to be reconfigured in such a manner as to resolve the inadequacies of the original application.

[Statutory Authority: RCW 46.44.090. 95-24-076, § 468-38-405, filed 12/4/95, effective 1/4/96.]

WAC 468-38-420 Bridge restrictions. The department shall from time to time evaluate the capacity of all bridges on the state highway system to carry loads. Bridges that cannot safely carry vehicles moving without a permit shall be posted. Vehicles exceeding the posted load limit shall not cross the bridge.

Vehicles carrying overloads authorized by special motor vehicle permit may not cross restricted bridges noted on the permit.

[Statutory Authority: RCW 46.44.090. 82-18-010 (Order 31, Resolution No. 156), § 468-38-420, filed 8/20/82. Statutory Authority: 1977 ex.s. c 151. 79-01-033 (DOT Order 10 and Comm. Order 1, Resolution No. 13), § 468-38-420, filed 12/20/78. Formerly WAC 252-24-381.]

**Chapter 468-46 WAC
TRANSIT VEHICLE STOP ZONES**

WAC

- 468-46-010 Engineering and traffic investigation of request for transit vehicle stop zone.
- 468-46-020 Secretary of transportation or designee to approve transit vehicle stop zones.
- 468-46-030 Transit vehicle stop symbol sign.
- 468-46-040 Advance transit vehicle stop symbol sign.
- 468-46-050 Transit vehicle warning lights at stop zone.
- 468-46-060 Elimination of transit vehicle stop zones.

WAC 468-46-010 Engineering and traffic investigation of request for transit vehicle stop zone. Upon receipt of a request from a public transit authority for approval of a transit vehicle stop zone outside of any incorporated city or town, the department of transportation shall conduct an engineering and traffic investigation in an attempt to find a suitable location at which transit vehicles may stop wholly off the roadway for the purpose of receiving or discharging passengers.

[Statutory Authority: 1977 ex.s. c 151. 79-01-033 (DOT Order 10 and Comm. Order 1, Resolution No. 13), § 468-46-010, filed 12/20/78. Formerly WAC 252-34-01001.]

(2001 Ed.)

WAC 468-46-020 Secretary of transportation or designee to approve transit vehicle stop zones. Should such a location not be found within a reasonable or practical distance suitable to the transit authority needs, and the public convenience requires that transit vehicles temporarily stop upon the roadway for the purpose of receiving or discharging passengers, the secretary of transportation or any assistant secretary or district engineer to whom the secretary has delegated the authority, may approve a transit vehicle stop zone at the most suitable location available having adequate sight distance based upon engineering judgment, with stopping sight distance as a minimum. The secretary of transportation may approve transit vehicle stop zones at locations not meeting the above requirements where the secretary deems the circumstances warrant such exceptions.

[Statutory Authority: 1977 ex.s. c 151. 79-01-033 (DOT Order 10 and Comm. Order 1, Resolution No. 13), § 468-46-020, filed 12/20/78. Formerly WAC 252-34-02001.]

WAC 468-46-030 Transit vehicle stop symbol sign. A transit vehicle stop (bus stop) symbol sign shall be installed at each approved location with the cost to be the obligation of the transit authority.

[Statutory Authority: 1977 ex.s. c 151. 79-01-033 (DOT Order 10 and Comm. Order 1, Resolution No. 13), § 468-46-030, filed 12/20/78. Formerly WAC 252-34-030.]

WAC 468-46-040 Advance transit vehicle stop symbol sign. The department of transportation shall install at its own expense in advance of each approved transit vehicle stop zone where the transit vehicle is not visible for a distance of 500 feet an advance warning sign consistent with the manual on uniform traffic control devices, (chapter 468-95 WAC).

[Statutory Authority: RCW 46.61.560, 47.36.030, 47.36.050 and 47.36.053. 83-07-025 (Order 76), § 468-46-040, filed 3/14/83. Statutory Authority: 1977 ex.s. c 151. 79-01-033 (DOT Order 10 and Comm. Order 1, Resolution No. 13), § 468-46-040, filed 12/20/78. Formerly WAC 252-34-040.]

WAC 468-46-050 Transit vehicle warning lights at stop zone. While stopped on the roadway at approved transit vehicle stop zones for the purpose of receiving or discharging passengers each transit vehicle shall be so equipped and the driver thereof shall activate the four-way warning lights as specified by RCW 46.37.210(4).

[Statutory Authority: 1977 ex.s. c 151. 79-01-033 (DOT Order 10 and Comm. Order 1, Resolution No. 13), § 468-46-050, filed 12/20/78. Formerly WAC 252-34-050.]

WAC 468-46-060 Elimination of transit vehicle stop zones. Continuous effort shall be made, subject to the availability of funding, to undertake improvements which will eliminate conditions requiring temporary stops by transit vehicles upon the roadway for the purpose of receiving or discharging passengers.

[Statutory Authority: 1977 ex.s. c 151. 79-01-033 (DOT Order 10 and Comm. Order 1, Resolution No. 13), § 468-46-060, filed 12/20/78. Formerly WAC 252-34-060.]

Chapter 468-48 WAC

HIGHWAY CORRIDOR AND ALIGNMENT AUTHORITY

WAC

468-48-010	Definitions.
468-48-020	Selection of corridors and alignments for highway facilities.

WAC 468-48-010 Definitions. For the purposes of this chapter, the following definitions of the terms shall apply unless the context clearly indicates otherwise.

(1) "Department" means the Washington state department of transportation.

(2) "Route" means a statutory designated state highway, being a new highway or existing highway with new alignment, and is laid out as running to or by way of certain designated points, without specifying the particular way to be followed to or by way of such points. Each route may contain one or more corridors.

(3) "Corridor" means one of several general paths a highway can take to satisfy the route requirements and has one or more specific alignment alternatives. A corridor can include, as a whole or in part, any existing state highway facility, county highway facility, city street, new alignments or any combination of these.

(4) "Alignment" means the specific path a highway will take between two designated points within a corridor.

[Statutory Authority: RCW 47.01.071. 94-14-065, § 468-48-010, filed 7/1/94, effective 8/1/94.]

WAC 468-48-020 Selection of corridors and alignments for highway facilities. The secretary of transportation is hereby delegated the commission's authority to conduct all hearings and adopt a specific highway corridor whenever the general route has been designated but there are several alternatives within that route. The secretary is further delegated the authority of the commission contained in RCW 47.28.010.

Nothing herein shall be construed as to restrict the ability of the department to select specific alignments and design elements within the corridor as part of the design process.

[Statutory Authority: RCW 47.01.071. 94-14-065, § 468-48-020, filed 7/1/94, effective 8/1/94.]

Chapter 468-51 WAC

HIGHWAY ACCESS MANAGEMENT ACCESS PERMITS—ADMINISTRATIVE PROCESS

WAC

468-51-010	Purpose.
468-51-020	Definitions.
468-51-030	General provisions.
468-51-040	Connection categories.
468-51-050	Conceptual review.
468-51-060	Application requirements and procedures.
468-51-070	Fees and surety bond.
468-51-080	Application submittal, review, conditions.
468-51-090	Construction requirements.
468-51-100	Nonconforming connection permits.
468-51-105	Variance connection permits.
468-51-110	Changes in property site use.
468-51-120	Permit modification, revocation, closure of permitted connections.
468-51-130	Closure of unpermitted connections.
468-51-140	Department construction projects.

WAC 468-51-010 Purpose. This chapter is adopted for use by the Washington state department of transportation to implement chapter 47.50 RCW for the regulation and control of vehicular access and connection points of ingress to, and egress from, the state highway system within unincorporated areas that are under the jurisdiction of the Washington state department of transportation. However, this chapter and chapter 468-52 WAC may be used, as a default, by cities that are the permitting authorities if they have not adopted an enacting ordinance as required under chapter 47.50 RCW.

This chapter describes the connection permit application process and procedures, including a preapplication conceptual review process, and requirements for closure of unpermitted and nonconforming connections to the state highway system.

[Statutory Authority: Chapter 47.50 RCW. 99-06-034 (Order 187), § 468-51-010, filed 2/25/99, effective 3/28/99. Statutory Authority: RCW 47.01.101 and chapter 47.50 RCW. 92-14-044, § 468-51-010, filed 6/24/92, effective 7/25/92.]

WAC 468-51-020 Definitions. For the purposes of this chapter, the following definitions of terms shall apply unless the context clearly indicates otherwise:

(1) "Application" means an application form supplied by the department and completed by the applicant, a certified check or money order for the required application fee, and related property site, driveway, roadway, and traffic information.

(2) "Average daily traffic (ADT)" means the volume of traffic passing a point or segment of a highway, in both directions, during a period of time, divided by the number of days in the period and factored to represent an estimate of traffic volume for an average day of the year.

(3) "Average weekday vehicle trip ends (AWDVTE)" means the estimated total of all trips entering plus all trips leaving the applicant's site based on the final stage of proposed development.

(4) "Conforming connection" means a connection that meets current department location, spacing, and design criteria.

(5) "Connection" means approaches, driveways, turn-outs, or other means of providing for the right of access to or from controlled access facilities on the state highway system.

(6) "Connection category" means a permit category of all state highway connections, in accordance with the type of property served and the estimated traffic generated by the applicant's site based on rates accepted by the department.

(7) "Connection permit" means a written authorization given by the department for a specifically designed connection to the state highway system at a specific location for a specific type and intensity of property use and specific volume of traffic for the proposed connection, based on the final stage of proposed development of the applicant's property. The actual form used for this authorization will be determined by the department.

(8) "Controlled access facility" means a transportation facility (excluding limited access facilities as defined in chapter 47.52 RCW) to which access is regulated by the gov-

ernmental entity having jurisdiction over the facility. Owners or occupants of abutting lands and other persons have a right of reasonable access to and from such facility at such points only and in such manner as may be determined by the governmental entity.

(9) "Department" means the Washington state department of transportation.

(10) "Development approval" means an official action by a governmental land use planning authority authorizing the developer or land owner to begin construction of any permanent improvements on the property.

(11) "Governmental entity" means, for the purpose of this chapter, a unit of local government or officially designated transportation authority that has the responsibility for planning, construction, operation, maintenance, or jurisdiction over transportation facilities.

(12) "Joint use connection" means a single connection point that serves as a connection to more than one property or development, including those in different ownerships or in which access rights are provided in the legal descriptions.

(13) "Limited access facility" means a highway or street especially designed or designated for through traffic, and over, from, or to which owners or occupants of abutting land, or other persons have no right or easement, or only a limited right or easement of access, light, view or air by reason of the fact that their property abuts upon such limited access facility, or for any other reason to accomplish the purpose of a limited access facility.

(14) "Median" means the portion of a divided highway or divided connection separating vehicular traffic traveling in opposite directions; not including speed change lanes, storage lanes for left turning or U-turning vehicles, or two way left turn lanes.

(15) "Median opening" means either a full opening in a continuous median for the specific purpose of allowing vehicles to make a left turn maneuver into or out of a property abutting the highway, to facilitate U-turns, or to allow for a vehicle to totally cross the road, or a directional opening allowing for left turn maneuvers into the property and U-turn maneuvers, but not allowing for left turns or cross movements out of the property.

(16) "Nonconforming connection" means a connection not meeting current department location, spacing, or design criteria.

(17) "Permit" means written approval issued by the department, subject to conditions stated therein, authorizing construction, reconstruction, maintenance, or reclassification of a state highway connection and associated traffic control devices on or to the department's right of way.

(18) "Permitting authority" means the department or any county, municipality, or transportation authority authorized to regulate access to their respective transportation systems.

(19) "Reasonable access" means an access connection that is suitable for the existing and/or proposed property use and does not adversely affect the safety, operations or maintenance of the highway system.

(20) "Right of way (R/W)" means a general term denoting land or interest therein, acquired for or designated for transportation purposes. More specifically, land in which the department, a county, or a municipality owns the fee simple

title, has an easement devoted to or required for use as a public road and appurtenant facilities, or has established ownership by prescriptive right, or lands that have been dedicated for public transportation purposes.

(21) "Shoulder" means the portion of the highway contiguous with the traveled lanes for the accommodation of stopped vehicles for emergency use, and for lateral support of base and surface courses and for other uses as allowed by law.

(22) "State highway system" means all roads, streets, and highways designated as state routes in compliance with chapter 47.17 RCW.

(23) "Temporary connection" means a permitted connection for a specific property use, conditioned to be open for a specific purpose and traffic volume for a specific period of time with the right of way to be restored by the permit holder to its original condition upon connection closure.

(24) "Variance permit" means a special nonconforming or additional connection permit, issued for a location not normally permitted by current department standards, after an engineering study demonstrates, to the satisfaction of the department, that the connection will not adversely affect the safety, maintenance or operation of the state highway in accordance with its assigned classification. This permit will remain valid until modified or revoked by the permitting authority.

[Statutory Authority: Chapter 47.50 RCW. 99-06-034 (Order 187), § 468-51-020, filed 2/25/99, effective 3/28/99. Statutory Authority: RCW 47.01.101 and chapter 47.50 RCW. 92-14-044, § 468-51-020, filed 6/24/92, effective 7/25/92.]

WAC 468-51-030 General provisions. (1) When connection permits required. Every owner of property which abuts a state highway, or has a legal easement to the state highway, where limited access rights have not been acquired has a right to reasonable access, but may not have the right to a particular means of access, to the state highway system. The right of access to the state highway may be restricted if, in compliance with local regulation, reasonable access to the state highway can be provided by way of another public road which abuts the property. These public roads shall be of sufficient width and strength to reasonably handle the traffic type and volumes that would be accessing that road. All new connections including alterations and improvements to existing connections to state highways shall require a connection permit. Such permits, if allowed, shall be issued only after written development approval where such approval is required, unless other interagency coordination procedures are in effect. However, the department can provide a letter of intent to issue a connection permit if that is a requirement of the agency that is responsible for development approval. The alteration or closure of any existing access connection caused by changes to the character, intensity of development, or use of the property served by the connection or the construction of any new access connection shall not begin before a connection permit is obtained from the department. Use of a new connection at the location specified in the permit is not authorized until the permit holder constructs or modifies the connection in accordance with the permit requirements. If a property owner or permit holder who has a valid connection

permit wishes to change the character, use, or intensity of the property or development served by the connection, the department must be contacted to determine whether a new connection permit would be required.

(2) Responsibility for other approvals. Connection permits authorize construction improvements to be built by the permit holder on department right of way. It is the responsibility of the applicant or permit holder to obtain any other local permits or other agency approvals that may be required, including satisfaction of all environmental regulations. It is also the responsibility of the applicant to acquire any property rights necessary to provide continuity from the applicant's property to the state highway right of way if the applicant's property does not abut the right of way, except where the connection replaces an existing access as a result of department relocation activity.

(3) Early consultation. In order to expedite the overall permit review process, the applicant is strongly encouraged to consult with the department prior to and during the local government subdivision, rezoning, site plan, or any other applicable predevelopment review process for which a connection permit will be required. The purpose of the consultation shall be to determine the permit category and to obtain a conceptual review of the development site plan and proposed access connections to the state highway system with respect to department connection location, quantity, spacing, and design standards. Such consultation will assist the developer in minimizing problems and delays during the permit application process and could eliminate the need for costly changes to site plans when unpermissible connection proposals are identified early in the planning phase. The conceptual review process is further detailed in WAC 468-51-050.

(4) Cost of construction.

(a) Permit holder. The cost of construction or modification of a connection shall be the responsibility of the permit holder, including the cost of modification of any connection required as a result of changes in property site use in accordance with WAC 468-51-110. However, the permit holder is not responsible for alterations made at the request of the department that are not required by law or administrative rule.

(b) Department. Existing permitted connections impacted by the department's work program and which, in the consideration of the department, necessitate modification, relocation, or replacement in order to meet current department connection location, quantity, spacing, and design standards, shall be modified, relocated, or replaced in kind by the department at no cost to the permit holder. The cost of further enhancements or modification to the altered, relocated, or replaced connections requested by the permit holder shall be the responsibility of the permit holder.

(5) Notification. The department shall notify affected property owners, permit holders, business owners and/or emergency services, in writing, where appropriate, whenever the department's work program requires the modification, relocation, or replacement of their access connections. In addition to written notification, the department shall facilitate, where appropriate, a public process which may include, but is not limited to, public notices, meetings or hearings, and/or individual meetings. The department shall provide the

interested parties with the standards and principles of access management.

(6) Department responsibility. The department has the responsibility to issue permits and authority to approve, disapprove, and revoke such permits, and to close connections, with cause.

[Statutory Authority: Chapter 47.50 RCW. 99-06-034 (Order 187), § 468-51-030, filed 2/25/99, effective 3/28/99. Statutory Authority: RCW 47.01.101 and chapter 47.50 RCW. 92-14-044, § 468-51-030, filed 6/24/92, effective 7/25/92.]

WAC 468-51-040 Connection categories. All connections, public or private shall be determined by the department to be in one of the following categories:

(1) "Category I - minimum connection" provides connection to the state highway system for up to ten single family residences, a duplex, or a small multi-family complex of up to ten dwelling units, which use a common connection. The category shall also apply to permanent connections to agricultural and forest lands, including field entrances; connections for the operation, maintenance, and repair of utilities; and connections serving other low volume traffic generators expected to have an average weekday vehicle trip ends (AWDVTE) of one hundred or less.

(2) "Category II - minor connection" provides connection to the state highway system for medium volume traffic generators expected to have an AWDVTE of one thousand five hundred or less, but not included in Category I.

(3) "Category III - major connection" provides connection to the state highway system for high volume traffic generators expected to have an AWDVTE exceeding one thousand five hundred.

(4) "Category IV - temporary connection" provides a temporary, time limited, connection to the state highway system for a specific property for a specific use with a specific traffic volume. Such uses include, but are not limited to, logging, forest land clearing, temporary agricultural uses, temporary construction, and temporary emergency access. The department reserves the right to remove any temporary connection at its sole discretion and at the expense of the property owner after the expiration of the permit. Further, a temporary connection permit does not bind the department, in any way, to the future issuance of a permanent connection permit at the temporary connection location.

(5) "Nonconforming connection" designation may be issued for Category I through IV permits after an analysis and determination by the department that a conforming connection cannot be made and a finding that the denial of a connection would leave the property without a reasonable means of access to the public road system. In such instances, the permit shall be noted as nonconforming and contain specific restrictions and provisions, including limits on the maximum vehicular use of the connection, the future availability of alternate means of reasonable access for which a conforming connection permit could be obtained, the removal of the nonconforming connection at the time the conforming access is available, and other conditions as necessary to carry out the provisions of chapter 47.50 RCW.

(6) "Variance connection" means a special nonconforming or additional connection permit, issued for a location not

normally permitted by current department standards, after an engineering study demonstrates that the connection will not adversely affect the safety, maintenance or operation of the highway in accordance with its assigned classification. This permit will remain valid until modified or revoked by the permitting authority.

(7) "Median opening" includes openings requested for both new connections and for existing connections. New median openings proposed as part of a new driveway connection shall be reviewed as part of the permit application review process. Request for the construction of new median openings to serve existing permitted connections shall require a reevaluation of the location, quantity, design of existing connection, and traffic at the existing connections. The property owner must file a new connection permit application, for the proper connection category, showing the new proposed median opening location and design and its relationship to the existing or modified driveway connections. Nothing contained herein shall be construed to prohibit the department from closing an existing median opening where operational or safety reasons require the action. The department shall notify affected property owners, permit holders and tenants, in writing, thirty days in advance of the closure of a median opening unless immediate closure is needed for safety or operational reasons.

[Statutory Authority: Chapter 47.50 RCW. 99-06-034 (Order 187), § 468-51-040, filed 2/25/99, effective 3/28/99. Statutory Authority: RCW 47.01.101 and chapter 47.50 RCW. 92-14-044, § 468-51-040, filed 6/24/92, effective 7/25/92.]

WAC 468-51-050 Conceptual review. Prior to filing a connection permit application and prior to receipt of development approval, all permit applicants, but in particular those applying for Category II and Category III connections, are strongly encouraged to request, in writing, a conceptual review of the site plan and proposed connection locations with the department and other local governmental agencies as appropriate. The purpose of the conceptual review is to expedite the overall review process by establishing the permit category, number, type, and general location of connections to the property early in the planning stages of a proposed development or a proposed significant change in property site use, or to determine that the connection as requested cannot be permitted. The conceptual review does not constitute final department approval of the location and design of the connection. If deemed appropriate, especially on the more complex proposals, the department shall establish the date for a conceptual review meeting to be held within two weeks of the receipt of the written request unless a later date is requested by the applicant. If a meeting is scheduled, representatives of the local governmental land use planning authority will be invited to attend. Within four weeks following the conceptual review meeting, or receipt of the request if no meeting is scheduled, the department will provide the applicant written notice of the department's conceptual review findings, provided all needed information to complete the review has been received from the applicant. These findings are nonbinding on the department and the developer. Additional detailed information received during the application process, changes in the proposed development, or changes in the existing or

planned operational characteristics of the state highway system may necessitate modifications of the connections agreed to in the conceptual approval. The conceptual review findings can be used by the developer in the site plan review/approval process with the local government having jurisdiction over the development as indicating coordination of connection location, quantity, and design with the department and of preliminary department findings on the proposed connections.

[Statutory Authority: RCW 47.01.101 and chapter 47.50 RCW. 92-14-044, § 468-51-050, filed 6/24/92, effective 7/25/92.]

WAC 468-51-060 Application requirements and procedures. This rule shall be used where the department is the permitting authority. Where the local governmental entity is the permitting authority, the applicable procedures of the local governmental entity must be followed. If the local governmental entity has no procedures then this rule may apply.

(1) Connection permit application and information. The appropriate application form and the application information are available from the designated local department offices. An application shall consist of the above form; application fee, as specified in WAC 468-51-070; plans; traffic data; and connection information specified in this section.

All connection and roadway design documents for Category II and III permits shall bear the seal and signature of a professional engineer, registered in accordance with chapter 18.43 RCW.

(2) Information required - all permits. The following information is required of all applicants for all permit categories, unless the department determines that specific information will not be required on individual applications. Additional information required of Category II, III, and IV permit applications is specified in this chapter. In all cases it would be prudent, prior to submittal of the application, for the applicant to inquire of the department whether the application needs additional information. The department reserves the right to request clarification or additional information during the application review process. Failure to provide the requested information within the time limits specified in the request shall result in withdrawal of the permit application.

(a) Identification and signature of property owner and applicant. The current complete names, mailing addresses, and telephone numbers of the property owner(s), the developer(s), the applicant, the transportation and legal consultants representing the applicant (if any), and the local government representative(s) responsible for processing the development's approval shall be provided as part of the application. If the property owner desires to have a representative sign the application, a notarized letter of authorization from the applicant is to be provided with the application. When the owner or applicant is a company, corporation, or other public agency, the name, address, and telephone number of the responsible officer shall be furnished. The names of all individuals signing the application and their titles shall be typed or printed directly below the signature.

(b) Property uses and traffic information. The ultimate planned property uses shall be indicated in sufficient detail to determine the appropriate permit classification. Estimated average weekday vehicle trip ends to be generated by the development, based on the planned property use, consistent

with the latest trip generation information published by the Institute of Transportation Engineers, Washington, D.C., (ITE) shall be included as appropriate. If local or special trip generation rates are used, instead of the ITE rates the latest and best information shall be used and all documentation for the rate development shall be submitted with the application. For residential developments with ten or fewer units, ten trips per day per unit may be assumed. The requirement for an average weekday vehicle trip ends estimate may be waived for agricultural uses where no retail marketing is proposed.

(c) Site plan. The application shall include a plan to scale, or a schematic drawing showing critical dimensions (allowable on Category I permits only), the location of the property, and existing conditions and the character and extent of work proposed. The location of existing and proposed on-site development with respect to the existing and proposed driveway location(s) and the highway shall be shown. Minimum information on the plan shall include:

(i) Road information.

- State route number.
- County or local road name.
- Highway pavement type.
- Cross section.
- Posted speed limit.
- The existence and location of any existing and/or future proposed public or private road abutting or entering the property; the horizontal and vertical curvature of the road(s) noting the location of existing and proposed connections and any other pertinent information.

(ii) Property information.

- Location of all existing and proposed buildings, and other structures, such as gasoline pumps, lights, trees, etc., with respect to the existing and proposed property and right of way lines.

• Any adjacent properties that are owned or controlled by the applicant, or in which the applicant has a financial interest, and indicate whether these properties will be accessed by means of the proposed connection(s).

- Proof of legal ownership or legal easement.

• The application shall include a boundary survey. The requirement for a boundary survey may be waived for Category I connections, at the discretion of the department.

• Any existing or proposed parcels segregated from the applicant's property for separate development also shall be clearly designated on the plan.

(iii) Connection location information.

• The proposed connection milepost and highway engineer's station, if available.

• Location of the highway centerline with respect to existing and proposed property lines.

• Distance of proposed public or private access connection to intersecting roads, streets, railroads.

• Existing or proposed median openings (crossovers) and connections on all sides of the state highway and other roads within six hundred sixty feet of the proposed connection location in urban areas and one thousand three hundred twenty feet in nonurban (rural) areas.

• Location of existing or proposed public or private retaining walls, fences, poles, sidewalks, bike paths, drainage structures and easements, traffic control devices, fire

hydrants, utilities, or other physical features, such as trees, landscaping, green belts, and wetlands, that could affect driveway location.

• It shall be the responsibility of the applicant to physically identify the location of the proposed connection at the proposed site.

(iv) Connection design information.

• Proposed connection and approach improvements including its profile approaching the state highway, width, radii, angle to the highway, auxiliary pavement.

• Existing and proposed grading (or contouring that affects the natural drainage pattern or runoff impacting the state highway and the proposed connection).

• Drainage calculations and other pertinent data.

• Driveway, auxiliary lanes and crossover pavement design, including subgrade, base, surface materials, and thicknesses.

• Specific requirements for design information on individual Category I permit applications may be relaxed, or waived, at the discretion of the department.

(v) Joint driveway use.

• If the driveway is to serve more than one property, the plan shall detail information for all properties using the connection and the application shall include copies of legally enforceable agreements of concurrence for all property owners on joint driveway usage.

• Joint driveway use serving adjoining properties is encouraged on all highways and may be required on some highways, in compliance with rules adopted by the department.

(3) Additional information required, Category II and Category III permits. The following is a list of additional information that may be required for each phase of the development from the applicant. Prior to the submittal of the application, the applicant shall coordinate with the appropriate designated local office of the department on the level of detail and the analysis techniques to be used.

(a) Circulation plans. All parking, interior drives, and internal traffic circulation plans.

(b) Connection users. All internal and external adjacent parcels which will use the requested connection. All existing and proposed connecting roadways and potential means of alternate access through the final buildout stage of development shall be shown on the plans submitted with the application.

(c) Traffic control devices and illumination. Proposed traffic control devices and lighting locations.

(d) Sight distance. Analysis of horizontal and vertical sight distance on the state highway with respect to the proposed connection.

(e) Traffic data and analysis. Traffic data submitted by the applicant shall be signed and sealed by a qualified professional engineer, registered in accordance with chapter 18.43 RCW. The following traffic study information may be required:

(i) Turning movements. Vehicle turning movements for present and future traffic conditions.

(ii) Volume and type. Amount and type of traffic that will be generated by the proposed development including a

breakdown of anticipated peak hour traffic and an analysis of the impact on the level of service on the state highway.

(iii) Parking and circulation. Analysis of off-street parking and traffic circulation, including distances to secondary access points on the connection roadway and their impact on the operation of the state highway.

(iv) Traffic signal data. If a traffic signal is requested, the following studies may be required: Traffic signal warrants; phasing and timing analysis; signal progression analysis; signalization, signing, and lighting plans in compliance with department standards. A separate department traffic signal permit is required.

(v) Off-site improvements. A traffic analysis to determine the need for off-site related roadway and geometric improvements and mitigation requirements.

(vi) Traffic control plan. A traffic control plan conforming to current department standards set forth in the "Manual on Uniform Traffic Control Devices," documenting how the permit holder will provide for safe and efficient movement on the state highway system during the construction of the connection.

(4) Additional information required, Category IV permits. Permit applications must contain the specific dates that the connection is to be open and must contain assurances acceptable to the department that the shoulder, curbing, sidewalks, bikeways, ditch, right of way, and any other amenities will be restored to their original condition at the permit holder's expense upon closure of the temporary connection.

[Statutory Authority: Chapter 47.50 RCW. 99-06-034 (Order 187), § 468-51-060, filed 2/25/99, effective 3/28/99. Statutory Authority: RCW 47.01.101 and chapter 47.50 RCW. 92-14-044, § 468-51-060, filed 6/24/92, effective 7/25/92.]

WAC 468-51-070 Fees and surety bond. (1) Fee structure. The following nonrefundable fee structure is established for department application processing, review, and inspection. Full payment of base fees must accompany the permit application. Due to the potential complexity of Category II and Category III connection proposals, and required mitigation measures that may involve construction on the state highway, the department may require a developer agreement in addition to the connection permit. The developer agreement may include, but is not limited to: Plans; specifications; maintenance requirements; bonding requirements; inspection requirements; division of costs by the parties, where applicable; and provisions for payment by the applicant of actual costs incurred by the department in the review and administration of the applicant's proposal that exceed the required base fees in the following schedule:

(a) Category I base fees for one connection.	
(i) Field (agricultural), forest lands, utility operation and maintenance	\$ 50
(ii) Residential dwelling units (up to 10) utilizing a single connection point	\$ 50
	per dwelling unit
(iii) Other, with 100 AWDVTE or less	\$ 500
(iv) Fee per additional connection point	\$ 50
(b) Category II base fees for one connection.	
(i) Less than 1,000 AWDVTE	\$ 1,000

(ii) 1,000 to 1,500 AWDVTE	\$ 1,500
(iii) Fee per additional connection point	\$ 250
(c) Category III base fees for one connection.	
(i) 1,500 to 2,500 AWDVTE	\$ 2,500
(ii) Over 2,500 AWDVTE	\$ 4,000
(iii) Fee per additional connection point	\$ 1,000
(d) Category IV base fee per connection	\$ 100

(2) Surety bond. Prior to the beginning of construction of any connection, the department may require the permit holder to provide a surety bond as specified in WAC 468-34-020(3).

[Statutory Authority: Chapter 47.50 RCW. 99-06-034 (Order 187), § 468-51-070, filed 2/25/99, effective 3/28/99. Statutory Authority: RCW 47.01.101 and chapter 47.50 RCW. 92-14-044, § 468-51-070, filed 6/24/92, effective 7/25/92.]

WAC 468-51-080 Application submittal, review, conditions. (1) Application submittal. The application shall be submitted to the designated local department office serving the area. The application shall be properly prepared, clearly completed, and signed. Information on the specific number of copies to be provided and other submittal information is available from the designated local department office.

(2) Application review, processing, and approval. Upon receipt of the application, the application shall be reviewed consistent with the provisions of this chapter. If the department identifies errors in the application or if additional information is required, the department will notify the applicant. Applicants must provide such information or correct errors within thirty days of the notification. If the applicant determines that the time to provide additional or corrected information is insufficient, the applicant shall contact the department in writing to request additional time be approved. If the additional or corrected information has not been received by the department within thirty days or the approved time period agreed to, the application will be withdrawn.

(a) Review. Upon timely receipt of all required information, or upon expiration of the time period for receipt of additional or corrected information, the location and design of the connection shall be examined for consistency with current department location, quantity, spacing, classifications, and department design standards. The review shall also include an analysis of the impact of the site's existing and projected traffic on the operation and safety of the state highway.

(b) Concurrence or denial, notice. If the department concurs in the location and design of the proposed connection, written notification of that concurrence will be sent to the applicant and to the local governmental land use planning authority having jurisdiction over the development. If the applicant has gone through the voluntary conceptual review process, the written notice of concurrence will indicate whether or not there have been any changes in the number, location, or design of the connection required by the department. No construction may commence on the department's right of way until all necessary department and local governmental permits are issued in accordance with (c) of this subsection. If the department does not concur in the connection location, quantity, or design, both the applicant and the local

governmental land use planning authority having jurisdiction over the development approval shall be notified, in writing, indicating the department's intent to deny the connection as proposed in the application. The written notification shall state the specific reasons for the intent to deny the connection, the process for submitting an amended application, and the appeal rights of the applicant. The applicant may submit a revised application within thirty days based on department comments and concerns as stated in the notification. The submittal of a revised application within thirty days shall not require the payment of any additional application fees. Submittal of a revised permit is not a prerequisite for a request for an adjudicative proceeding in compliance with WAC 468-51-150.

(c) Permit issuance. The department shall issue the connection permit after review and concurrence that the application and the location and design of the connection comply with the requirements of this chapter, and after either:

(i) The applicant has received development approval from the appropriate local governmental land use planning authority; or

(ii) Other interagency coordination procedures in effect are satisfied for development approval by the local governmental land use planning authority.

The department shall provide the applicant with the connection permit for signature, and the applicant shall sign and return the permit to the department within thirty days after the mailing date. If the department does not receive the signed permit back from the applicant within thirty days after the mailing date or within an agreed upon time, the permit will be void and the application fee will be forfeited. The permit is not valid and construction on the access cannot begin without a completed permit that is signed by both the department and the applicant.

Additionally, the applicant must be in compliance with the surety bond requirements specified in the permit prior to construction, in compliance with WAC 468-51-070.

(d) Request for adjudicative proceedings. In the event of a denial of a connection permit as proposed in the application, the applicant may apply for an adjudicative proceeding in compliance with WAC 468-51-150.

(3) Permit conditions. Any special requirements or provisions for the connection including off-site mitigation shall be clearly and specifically identified as part of the permit. Failure by the applicant or permit holder to abide by the permit provisions shall be sufficient cause for the department to initiate action to alter the connection or to revoke the permit and close the connection at the expense of the permit holder. The permit requirements shall be binding on the permit holder, the permit holder's successors, heirs and assigns, the permit application signatories, and all future owners and occupants of the property. The applicant may challenge the permit conditions by applying for an adjudicative proceeding in compliance with WAC 468-51-150.

[Statutory Authority: Chapter 47.50 RCW. 99-06-034 (Order 187), § 468-51-080, filed 2/25/99, effective 3/28/99. Statutory Authority: RCW 47.01.101 and chapter 47.50 RCW. 92-14-044, § 468-51-080, filed 6/24/92, effective 7/25/92.]

[Title 468 WAC—p. 74]

WAC 468-51-090 Construction requirements. (1) Preconstruction conference. The department may require a preconstruction conference prior to any work being performed on the department's right of way. When required by provisions in the permit, the department will schedule a preconstruction conference. The preconstruction conference should be attended by the necessary personnel to assure compliance with the terms and provisions of the permit.

(2) Time limit. Substantial construction of the connection shall begin within ninety days of the effective date of the permit, unless a longer time is approved by the department or a time extension is requested by the applicant and approved by the department. Construction shall be completed within one hundred twenty days of the date of issuance of the permit, unless a time extension is approved by the department. As a condition of the permit, the department may further limit construction time, if the department determines that such limitation is warranted. Failure to comply with the time limits specified in the permit shall result in an automatic expiration of the permit following written notification to the permit holder. For any permit which expires for failure to begin construction or to complete construction within the specified time limits, the department may require a new application, including the payment of the required application fee prior to the initiation of any construction.

(3) Posting of permit. The approved connection permit shall be displayed in a prominent location, protected from the weather, within the vicinity of the connection construction.

(4) Disruption of traffic. All construction and/or maintenance within department right of way shall conform to the provisions of the connection permit, the *"Manual on Uniform Traffic Control Devices"* (MUTCD); the department's current *"Design Manual,"* and the current *"Standard Specifications for Road, Bridge, and Municipal Construction."* The department may require or restrict hours of construction to minimize disruption of traffic on the state highway system. If construction activity within the department's right of way causes undue disruption of traffic or creates safety hazards on a state highway, or if the construction activity is not in compliance with the traffic control specifications in the permit, the department shall advise the permit holder or the permit holder's contractor of the need for immediate corrective action, and may order immediate suspension of all or part of the work if deemed necessary. Failure to comply with this provision may result in permit modification or revocation.

(5) Traffic signals and other traffic control devices. Traffic signals and other traffic control devices installed by the permit holder shall conform to MUTCD and department design and construction standards. The permit holder is responsible for securing any state and local permits needed for traffic signalization and regulatory signing and marking.

(6) Connection construction inspection. For Category II and Category III connections, the department may require the permit holder, the developer, or landowner to provide inspection of construction and certification that connection construction is in accordance with permit provisions and appropriate department standards by a professional engineer, registered in accordance with chapter 18.43 RCW, or the department may do the inspection at the applicant's expense, as provided in the developer agreement.

[Statutory Authority: Chapter 47.50 RCW. 99-06-034 (Order 187), § 468-51-090, filed 2/25/99, effective 3/28/99. Statutory Authority: RCW 47.01.101 and chapter 47.50 RCW. 92-14-044, § 468-51-090, filed 6/24/92, effective 7/25/92.]

WAC 468-51-100 Nonconforming connection permits. The department may issue a permit for a connection not meeting department location and spacing criteria standards if it finds that a conforming connection is not attainable at the time of the permit application submittal and that denial would leave the property without a reasonable access to the public road system. The department may issue a connection permit requiring a legally enforceable joint-use connection when determined to be in the best interest of the state for restoring or maintaining the operational efficiency and safety of the state highway. Nonconforming connection permits shall specify conditions or limits including:

(1) **Traffic volume.** The maximum vehicular usage of the connection shall be specified in the permit.

(2) **Future alternate access.** The permit shall specify that a conforming connection be constructed when future alternate means of access become available, and that the nonconforming connection be removed.

(3) **Users.** The permit shall specify the properties to be served by the connection; and any other conditions as necessary to carry out the provisions of chapter 47.50 RCW.

[Statutory Authority: Chapter 47.50 RCW. 99-06-034 (Order 187), § 468-51-100, filed 2/25/99, effective 3/28/99. Statutory Authority: RCW 47.01.101 and chapter 47.50 RCW. 92-14-044, § 468-51-100, filed 6/24/92, effective 7/25/92.]

WAC 468-51-105 Variance connection permits. Variance permits may be issued, at the discretion of the department, for certain connections not meeting the access classification location and spacing or that exceed the number of connections allowed by the standards adopted for a particular highway segment. These permits may be allowed if conditions warrant and are demonstrated to the satisfaction of the department by a traffic analysis, signed and sealed by a qualified professional engineer who is registered in accordance with chapter 18.43 RCW, which is included with the connection permit application. The variance permit will remain in effect unless a new permit is required due to changes in property site use in compliance with WAC 468-51-110 or unless permit modification, revocation, or closure of the variance permitted connection is required as provided for in WAC 468-51-120. The department may issue a connection permit requiring a legally enforceable joint-use connection when it is determined to be in the best interest of the state for restoring or maintaining the operational efficiency and safety of the state highway. Variance connection permits shall specify conditions or limits including, but not limited to:

(1) **Traffic volume.** The maximum vehicular usage of the connection shall be specified in the permit.

(2) **Users.** The permit shall specify the properties to be served by the connection, and any other conditions as necessary to carry out the provisions of chapter 47.50 RCW.

[Statutory Authority: Chapter 47.50 RCW. 99-06-034 (Order 187), § 468-51-105, filed 2/25/99, effective 3/28/99.]

(2001 Ed.)

WAC 468-51-110 Changes in property site use. The connection permit is issued to the permit holder for a particular type of land use generating specific projected traffic volumes at the final stage of proposed development. Any changes made in the use, intensity of development, type of traffic, or traffic flow of the property requires the permit holder, his or her assignee, or property owner to contact the department to determine if further analysis is needed to determine if the change is significant and would require a new permit and modifications to the connection. An engineering study, signed and sealed by a professional engineer registered in accordance with chapter 18.43 RCW, may be required to document the extent of the change. If modification of the existing connection is required, based on a significant change as determined by the department, the permit holder, his or her assignee, or the property owner shall obtain a new permit prior to the initiation of any on-site construction to the connection or to the property.

(1) **Significant change.** A significant change is one that would cause a change in the category of the connection permit or one that causes an operational, safety, or maintenance problem on the state highway system based on objective engineering criteria or available accident data. Such data shall be provided to the property owner and/or permit holder and tenant upon written request.

(2) **Notification.** Failure to contact the department to determine the need for connection modifications or to apply for a new permit for such modifications prior to initiation of property improvements, land use changes or traffic flow alteration actions shall result in notification to the property owner and/or permit holder and tenant of intent to revoke the existing permit and closure of the connection to the property.

(3) **Costs.** The permit holder is responsible for all costs associated with connection removal, relocation, or modification caused by increased or altered traffic flows necessitated by changes to facilities, use, or to the nature of the business on the property.

[Statutory Authority: Chapter 47.50 RCW. 99-06-034 (Order 187), § 468-51-110, filed 2/25/99, effective 3/28/99. Statutory Authority: RCW 47.01.101 and chapter 47.50 RCW. 92-14-044, § 468-51-110, filed 6/24/92, effective 7/25/92.]

WAC 468-51-120 Permit modification, revocation, closure of permitted connections. (1) **Revocation criteria.** All connection permits issued by the department prior to the effective date of this chapter remain valid until revoked. The department may initiate an action to revoke any permit if significant changes have occurred in the use, design, or traffic flow of the property or of the state highway, requiring the relocation, alteration, or closure of the connection; if the connection was not constructed at the location or to the design specified in the permit; if the permit provisions were not met; or if the connection causes a safety, maintenance, or operational problem on the state highway system. The process to be followed by the department in the revocation of permits shall be consistent with the requirements of chapter 34.05 RCW and WAC 468-51-150. The notification process is as follows:

(a) **Notification, correction of deficiencies.** The department shall serve notice, in accordance with rules adopted in

compliance with chapter 34.05 RCW, to the permit holder, permit holder's successors or assigns, or property owner with a copy to the occupant, for any connection found to be in non-compliance with the conditions of the permit or this chapter. The notice will identify and request that the deficiencies be corrected within thirty days of service of the notice. The notice shall further advise that the department's determination of noncompliance or deficiencies shall become final and conclusive thirty calendar days following service of the notice unless the violations are corrected or an adjudicative proceeding in compliance with chapter 34.05 RCW and WAC 468-51-150 is requested by the permit holder, permit holder's successor or assigns, or the property owner.

(2) Costs. The permit holder, permit holder's successor or assignee, or property owner shall be responsible for the costs of closure due to revocation of a connection permit in compliance with WAC 468-51-120 except when the closure is required by changes to the state highway.

(3) Emergency action. This chapter shall not restrict the department's right to take immediate remedial action, including the closure of a connection if there is an immediate and serious danger to the public health, safety, and welfare, in compliance with chapter 47.32 RCW. In such event, the department shall conform to the provisions for emergency adjudicative proceedings in RCW 34.05.479 and rules adopted thereunder.

[Statutory Authority: Chapter 47.50 RCW. 99-06-034 (Order 187), § 468-51-120, filed 2/25/99, effective 3/28/99. Statutory Authority: RCW 47.01.101 and chapter 47.50 RCW. 92-14-044, § 468-51-120, filed 6/24/92, effective 7/25/92.]

WAC 468-51-130 Closure of unpermitted connections. Closure criteria, permit requirements. Any unpermitted connections to the state highway system which were in existence and in active use consistent with the type of connection on July 1, 1990, shall not require the issuance of a permit and may continue to provide connection to the state highway system, unless the property owner had received written notification initiating connection closure from the department prior to July 1, 1990, or unless the department determines that the unpermitted connection does not meet minimum acceptable standards of highway safety and mobility based on accident and/or traffic data or accepted traffic engineering criteria, a copy of which must be provided to the property owner and/or permit holder and tenant upon written request. The department may require that a permit be obtained if a significant change occurs in the use, design, or traffic flow of the connection or of the state highway. If a permit is not obtained, the department may initiate action to close the unpermitted connection point in compliance with RCW 47.50.040. Any unpermitted connection opened subsequent to July 1, 1990, is subject to closure by the department. The process to be followed by the department in the closure of an unpermitted connection shall be consistent with chapter 34.05 RCW and rules adopted thereunder. The notification process is as follows:

(1) Notification. The department shall serve notice, in accordance with rules adopted in compliance with chapter 34.05 RCW, upon the property owner of a connection to a state highway which is found by the department to be unper-

mitted. This notice shall clearly describe the highway connection violation and shall establish a thirty-day time limit for either applying for a connection permit or requesting an adjudicative proceeding in compliance with chapter 34.05 RCW. The notice will further advise the property owner that failure to act in either of the prescribed ways within the time period will result in department closure of the unpermitted connection.

(2) Permit application. If a permit application is filed within the thirty days, and the application is denied, the department shall notify the property owner of the denial. The property owner may then proceed with the permit application revision process set forth in WAC 468-51-080 or request an adjudicative proceeding in compliance with WAC 468-51-150 within thirty days. Failure to act in either of those prescribed ways within the time period set forth in the rules will result in department closure of the unpermitted connection. If the location and design of the connection in the permit application are acceptable to the department, the existing connection may continue to be used for a specified period of time or until the connection specified in the permit application is constructed.

(3) Approval conditions. Modifications, relocation, or closure of unpermitted connections may be required by the department as a requirement of permit approval, subject to the adjudicative proceedings provisions of WAC 468-51-150.

[Statutory Authority: Chapter 47.50 RCW. 99-06-034 (Order 187), § 468-51-130, filed 2/25/99, effective 3/28/99. Statutory Authority: RCW 47.01.101 and chapter 47.50 RCW. 92-14-044, § 468-51-130, filed 6/24/92, effective 7/25/92.]

WAC 468-51-140 Department construction projects. During construction of department projects, connections will be provided as replacements for existing approved permitted connections, that are consistent with all current department spacing, location, and design standards, based on the following conditions:

(1) Nonconforming connections. All nonconforming connections will be examined to determine if the construction project will require relocation, alteration, or closure of the connection to make it conforming.

(2) Application of current standards. The number and location of connections shall be modified to the maximum extent possible to meet current department spacing, location, and design standards. Where current department standards cannot be met, the connection shall be classified as nonconforming.

(3) New connections, modifications. The department shall allow new or require modification of existing connections if a connection permit application is made and approved.

(4) Replacement of existing connections. When connections are made as part of a department construction project replacing existing connection points without material differences, no additional permit shall be required. Costs shall be borne by the department.

(5) New connections—Cost. The construction of new connection points, if approved by the department, shall be done at the owner's expense by either the department's con-

tractor as part of the roadway improvement or by the owner's contractor at the department's option.

(6) Modifications—Cost. If the modification of the connection point, that are based on the owner's request, is more extensive than the routine replacement of an existing connection, the owner shall also participate in the differential cost.

(7) Work by permit holder's contractor. The department shall require that work done by the owner's contractor be accomplished at the completion of the department's contract or be scheduled so as not to interfere with the department's contractor. The department may require a surety bond prior to construction of the connection in accordance with WAC 468-51-070. When the number, location or design of existing access connections to the state highway are being modified by a department construction project, the resulting modified access connections shall provide the same general functionality for the existing property use as they did before the modification, taking into consideration the existing site design, normal vehicle types, and traffic circulation requirements.

Notification. The department shall notify affected property owners, permit holders, business owners and/or emergency services, in writing, where appropriate, whenever the department's work program requires the modification, relocation, or replacement of their access connections. In addition to written notification, the department shall facilitate, where appropriate, a public process which may include, but is not limited to, public notices, meetings or hearings, and/or individual meetings. The department shall provide the interested parties with the standards and principles of access management.

[Statutory Authority: Chapter 47.50 RCW. 99-06-034 (Order 187), § 468-51-140, filed 2/25/99, effective 3/28/99. Statutory Authority: RCW 47.01.101 and chapter 47.50 RCW. 92-14-044, § 468-51-140, filed 6/24/92, effective 7/25/92.]

WAC 468-51-150 Adjudicative proceedings. (1) Application. Any person who has standing to challenge the denial of a permit application in compliance with WAC 468-51-080; a permit with conditions in compliance with WAC 468-51-080; a notice of permit modification, revocation, or closure of permitted connection in compliance with WAC 468-51-120; or notice of closure of an unpermitted connection in compliance with WAC 468-51-130 may apply for an adjudicative proceeding on the matter in compliance with chapter 34.05 RCW, rules adopted thereunder, and department rules within thirty days of the date the initial determination of the department is sent by certified mail.

(2) Conduct. Thereafter, and within the times set forth by chapter 34.05 RCW, rules adopted thereunder, and department rules, the department shall convene an adjudicative proceeding. The proceeding shall be conducted in compliance with chapter 34.05 RCW, rules adopted thereunder, and department rules.

(3) Failure to apply. Failure to apply for an adjudicative proceeding within the times set forth in subsection (1) of this section shall result in the adoption of the department's initial determination as its final determination.

(4) Failure to participate. Failure to attend or otherwise participate in an adjudicative proceeding may result in a finding of default.

(2001 Ed.)

(5) Reasonableness of access. The department in its regulation of connections in compliance with chapter 47.50 RCW and these regulations shall allow reasonable access. If the department's final order denies reasonable access, the appellant shall be entitled to just compensation in compliance with RCW 47.50.010(5). Access which is not reasonable is not compensable.

[Statutory Authority: Chapter 47.50 RCW. 99-06-034 (Order 187), § 468-51-150, filed 2/25/99, effective 3/28/99. Statutory Authority: RCW 47.01.101 and chapter 47.50 RCW. 92-14-044, § 468-51-150, filed 6/24/92, effective 7/25/92.]

Chapter 468-52 WAC

HIGHWAY ACCESS MANAGEMENT—ACCESS CONTROL CLASSIFICATION SYSTEM AND STANDARDS

WAC

468-52-010	Purpose.
468-52-020	Definitions.
468-52-030	General.
468-52-040	Access control classification system and standards.
468-52-050	Application of access control classification system standards.
468-52-060	Assignment of access control classifications to highway segments.
468-52-070	Review and modification of classifications.

WAC 468-52-010 Purpose. This chapter is adopted in accordance with chapter 47.50 RCW for the implementation of an access control classification system and standards for the regulation and control of vehicular ingress to, and egress from the state highway system.

[Statutory Authority: RCW 47.01.101 and chapter 47.50 RCW. 93-03-033 (Order 135), § 468-52-010, filed 1/13/93, effective 2/13/93.]

WAC 468-52-020 Definitions. For the purposes of this chapter, the following definitions of the terms shall apply unless the context clearly indicates otherwise:

(1) "Average daily traffic (ADT)" means the volume of traffic passing a point or segment of a highway, in both directions, during a period of time, divided by the number of days in the period and factored to represent an estimate of traffic volume for an average day of the year.

(2) "Conforming connection" means a connection that meets current department location, spacing, and design criteria.

(3) "Connection" means approaches, driveways, turnouts, or other means of providing for the right of access to or from controlled access facilities on the state highway system.

(4) "Connection permit" means a written authorization given by the department for a specifically designed connection to the state highway system at a specific location for a specific type and intensity of property use and specific volume of traffic for the proposed connection, based on the final stage of proposed development of the applicant's property. The actual form used for this authorization will be determined by the department.

(5) "Contiguous parcels" means two or more pieces of real property under the same ownership with one or more boundaries that touch and have similarity of use.

(6) "Controlled access facility" means a transportation facility (excluding limited access facilities as defined in

chapter 47.52 RCW) to which access is regulated by the governmental entity having jurisdiction over the facility. Owners or occupants of abutting lands and other persons have a right of access to and from such facility at such points only and in such manner as may be determined by the governmental entity.

(7) "Corner clearance" means the distance from an intersection of a public or private road to the nearest connection along a controlled access facility. This distance is measured from the closest edge of the traveled way of the intersecting road to the closest edge of the traveled way of the connection measured along the traveled way (through lanes).

(8) "Department" means the Washington state department of transportation.

(9) "Governmental entity" means, for the purpose of this chapter, a unit of local government or officially designated transportation authority that has the responsibility for planning, construction, operation, maintenance, or jurisdiction over transportation facilities.

(10) "Intersection" means an at grade connection on a state highway with a road or street duly established as a public road or public street by the local governmental entity.

(11) "Joint use connection" means a single connection point that serves as a connection to more than one property or development, including those in different ownerships or in which access rights are provided in the legal descriptions.

(12) "Limited access facility" means a highway or street especially designed or designated for through traffic, and over, from, or to which owners or occupants of abutting land, or other persons have no right or easement, or only a limited right or easement of access, light, view, or air by reason of the fact that their property abuts upon such limited access facility, or for any other reason to accomplish the purpose of a limited access facility.

(13) "Nonconforming connection" means a connection not meeting current department location, spacing, or design criteria.

(14) "Permit" means written approval issued by the department, subject to conditions stated therein, authorizing construction, reconstruction, maintenance, or reclassification of a state highway connection and associated traffic control devices on or to the department's right of way.

(15) "Permitting authority" means the department or any county, municipality, or transportation authority authorized to regulate access to their respective transportation systems.

(16) "State highway system" means all roads, streets, and highways designated as state routes in compliance with chapter 47.17 RCW.

(17) "Reasonable access" means an access connection that is suitable for the existing and/or proposed property use and does not adversely affect the safety, operations or maintenance of the state highway system.

(18) "Variance permit" means a special nonconforming or additional connection permit, issued for a location not normally permitted by current department standards, after an engineering study demonstrates, to the satisfaction of the department, that the connection will not adversely affect the safety, maintenance or operation of the highway in accordance with its assigned classification. This permit will

remain valid until modified or revoked by the permitting authority.

[Statutory Authority: Chapter 47.50 RCW. 99-06-035 (Order 188), § 468-52-020, filed 2/25/99, effective 3/28/99. Statutory Authority: RCW 47.01.101 and chapter 47.50 RCW. 93-03-033 (Order 135), § 468-52-020, filed 1/13/93, effective 2/13/93.]

WAC 468-52-030 General. The connection and intersection spacing distances specified in this chapter are minimums. Greater distances may be required by the department on individual permits issued in accordance with chapter 468-51 WAC to provide desirable traffic operational and safety characteristics. If greater distances are required, the department will document, as part of the response to a connection permit application in compliance with chapter 468-51 WAC, the reasons, based on traffic engineering principles, that such greater distances are required. Nonconforming permits may be issued in accordance with chapter 468-51 WAC allowing for less than minimum spacing where no other reasonable access exists, or a variance connection permit may be issued where it can be substantiated by a traffic analysis, to the satisfaction of the department, through the permit application process that allowing less than the minimum spacing or more than the maximum number of connections, would not adversely affect the desired function of the state highway in accordance with the assigned access classification, and would not adversely affect the safety, maintenance or operation of the state highway.

[Statutory Authority: Chapter 47.50 RCW. 99-06-035 (Order 188), § 468-52-030, filed 2/25/99, effective 3/28/99. Statutory Authority: RCW 47.01.101 and chapter 47.50 RCW. 93-03-033 (Order 135), § 468-52-030, filed 1/13/93, effective 2/13/93.]

WAC 468-52-040 Access control classification system and standards. This section provides an access control classification system consisting of five classes. The functional characteristics and the access control design standards for each class are described. The classes are arranged from the most restrictive, class one, to the least restrictive, class five. This access control classification system does not include highways or portions thereof that have been established as limited access highways in compliance with chapter 47.52 RCW. For state highways that are planned for the establishment of limited access control in accordance with the *Master Plan for Limited Access Highways*, an access control classification will be assigned to each highway segment to remain in effect until such time that the facility is established as a limited access facility.

On all access classes, property access shall be located and designed to minimize interference with transit facilities and/or high occupancy vehicle (HOV) facilities on state highways where such facilities exist or where such facilities are proposed in a state, regional, metropolitan, or local transportation plan. In such cases, if reasonable access is available from the general street system, primary property access shall be provided from the general street system rather than from the state highway.

(1) Class one.

(a) Functional characteristics:

These highways have the capacity for safe and efficient high speed and/or high volume traffic movements, providing for interstate, interregional, and intercity travel needs and some intracity travel needs. Service to abutting land is subordinate to providing service to major traffic movements. Highways in this class are typically distinguished by a highly controlled, limited number of public and private connections, restrictive medians with limited median openings on multi-lane facilities, and infrequent traffic signals.

(b) Access control design standards:

(i) It is the intent that the design of class one highways be generally capable of achieving a posted speed limit of fifty to sixty-five mph. Spacing of intersecting streets, roads, and highways shall be planned with a minimum spacing of one mile. One-half mile spacing may be permitted, but only when no reasonable alternative access exists.

(ii) Private direct access to the state highway shall not be permitted except when the property has no other reasonable access to the general street system. The following standards will be applied when direct access must be provided:

(A) The access connection shall continue until such time that other reasonable access to a highway with a less restrictive access control classification or access to the general street system becomes available and is permitted.

(B) The minimum distance to another public or private access connection shall be one thousand three hundred twenty feet. Nonconforming connection permits may be issued to provide access to parcels whose highway frontage, topography, or location would otherwise preclude issuance of a conforming connection permit; however, variance permits are not allowed. No more than one connection shall be provided to an individual parcel or to contiguous parcels under the same ownership.

(C) All private direct access shall be for right turns only on multilane facilities, unless special conditions warrant and are documented by a traffic analysis in the connection permit application, signed and sealed by a qualified professional engineer, registered in accordance with chapter 18.43 RCW.

(D) No additional access connections to the state highway shall be provided for newly created parcels resulting from property divisions. All access for such parcels shall be provided by internal road networks. Access to the state highway will be at existing permitted connection locations or at revised connection locations, as conditions warrant.

(iii) A restrictive median shall be provided on multilane facilities to separate opposing traffic movements and to prevent unauthorized turning movements.

(2) Class two.

(a) Functional characteristics:

These highways have the capacity for medium to high speeds and medium to high volume traffic movements over medium and long distances in a safe and efficient manner, providing for interregional, intercity, and intracity travel needs. Direct access service to abutting land is subordinate to providing service to traffic movement. Highways in this class are typically distinguished by existing or planned restrictive medians, where multilane facilities are warranted, and minimum distances between public and private connections.

(b) Access control design standards:

(i) It is the intent that the design of class two highways be generally capable of achieving a posted speed limit of thirty-five to fifty mph in urbanized areas and forty-five to fifty-five mph in rural areas. Spacing of intersecting streets, roads, and highways shall be planned with a minimum spacing of one-half mile. Less than one-half mile intersection spacing may be permitted, but only when no reasonable alternative access exists. In urban areas and developing areas where higher volumes are present or growth that will require signalization is expected in the foreseeable future, it is imperative that the location of any public access be planned carefully to ensure adequate signal progression. Addition of all new connections, public or private, that may require signalization will require an engineering analysis signed and sealed by a qualified professional engineer, registered in accordance with chapter 18.43 RCW.

(ii) Private direct access to the state highway system shall be permitted only when the property has no other reasonable access to the general street system or if access to the general street system would cause traffic operational conditions or safety concerns unacceptable to the local governmental entity. When direct access must be provided, the following conditions shall apply:

(A) The access connection shall continue until such time that other reasonable access to a highway with a less restrictive access control classification or acceptable access to the general street system becomes available and is permitted.

(B) The minimum distance to another public or private access connection shall be six hundred sixty feet. Nonconforming connection permits may be issued to provide access to parcels whose highway frontage, topography, or location would otherwise preclude issuance of a conforming connection permit. No more than one connection shall be provided to an individual parcel or to contiguous parcels under the same ownership unless the highway frontage exceeds one thousand three hundred twenty feet and it can be shown that the additional access would not adversely affect the desired function of the state highway in accordance with the assigned access classification, and would not adversely affect the safety or operation of the state highway.

(C) Variance permits may be allowed if conditions warrant and are demonstrated to the satisfaction of the department by a traffic analysis, signed and sealed by a qualified professional engineer, who is registered in accordance with chapter 18.43 RCW, which is included with the connection permit application.

(D) All private direct access shall be for right turns only on multilane facilities, unless special conditions warrant and are demonstrated, to the satisfaction of the department, by a traffic analysis, signed and sealed by a qualified professional engineer, who is registered in accordance with chapter 18.43 RCW, included with the connection permit application and only if left turn channelization is provided.

(E) No additional access connections to the state highway shall be provided for newly created parcels resulting from property divisions. All access for such parcels shall be provided by internal road networks. Access to the state highway will be at existing permitted connection locations or at revised connection locations, as conditions warrant.

(iii) On multilane facilities a restrictive median shall be provided to separate opposing traffic movements and to prevent unauthorized turning movements; however, a nonrestrictive median or a two way left turn lane may be used when special conditions exist and mainline volumes are below 20,000 ADT.

(3) Class three.

(a) Functional characteristics:

These highways have the capacity for moderate travel speeds and moderate traffic volumes for medium and short travel distances providing for intercity, intracity, and intercommunity travel needs. There is a reasonable balance between direct access and mobility needs for highways in this class. This class is to be used primarily where the existing level of development of the adjoining land is less intensive than maximum buildout and where the probability of significant land use change and increased traffic demand is high. Highways in this class are typically distinguished by planned restrictive medians, where multilane facilities are warranted, and minimum distances between public and private connections. Two-way left-turn-lanes may be utilized where special conditions warrant and mainline traffic volumes are below 25,000 ADT. Development of properties with internal road networks and joint access connections are encouraged.

(b) Access control design standards:

(i) It is the intent that the design of class three highways be generally capable of achieving a posted speed limit of thirty to forty mph in urbanized areas and forty-five to fifty-five mph in rural areas. In rural areas, spacing of intersecting streets, roads, and highways shall be planned with a minimum spacing of one-half mile. Less than one-half mile intersection spacing may be permitted, but only when no reasonable alternative access exists. In urban areas and developing areas where higher volumes are present or growth that will require signalization is expected in the foreseeable future, it is imperative that the location of any public access be planned carefully to ensure adequate signal progression. Where feasible, major intersecting roadways that may ultimately require signalization shall be planned with a minimum of one-half mile spacing. Addition of all new connections, public or private, that may require signalization will require an engineering analysis signed and sealed by a qualified professional engineer, registered in accordance with chapter 18.43 RCW.

(ii) Private direct access:

(A) No more than one access shall be provided to an individual parcel or to contiguous parcels under the same ownership unless it can be shown that additional access points would not adversely affect the desired function of the state highway in accordance with the assigned access classification, and would not adversely affect the safety or operation, of the state highway.

(B) The minimum distance to another public or private access connection shall be three hundred thirty feet. Nonconforming connection permits may be issued to provide access to parcels whose highway frontage, topography, or location would otherwise preclude issuance of a conforming connection permit.

(C) Variance permits may be allowed if conditions warrant and are demonstrated to the satisfaction of the department by a traffic analysis, signed and sealed by a qualified

professional engineer, who is registered in accordance with chapter 18.43 RCW, which is included with the connection permit application.

(4) Class four.

(a) Functional characteristics:

These highways have the capacity for moderate travel speeds and moderate traffic volumes for medium and short travel distances providing for intercity, intracity, and intercommunity travel needs. There is a reasonable balance between direct access and mobility needs for highways in this class. This class is to be used primarily where the existing level of development of the adjoining land is more intensive and where the probability of major land use changes is less probable than on class three highway segments. Highways in this class are typically distinguished by existing or planned nonrestrictive medians. Restrictive medians may be used as operational conditions warrant to mitigate turning, weaving, and crossing conflicts. Minimum connection spacing standards should be applied if adjoining properties are redeveloped.

(b) Access control design standards:

(i) It is the intent that the design of class four highways be generally capable of achieving a posted speed limit of thirty to thirty-five mph in urbanized areas and thirty-five to forty-five mph in rural areas. In rural areas, spacing of intersecting streets, roads, and highways shall be planned with a minimum spacing of one-half mile. Less than one-half mile intersection spacing may be permitted, but only when no reasonable alternative access exists. In urban areas and developing areas where higher volumes are present or growth that will require signalization is expected in the foreseeable future, it is imperative that the location of any public access be planned carefully to ensure adequate signal progression. Where feasible, major intersecting roadways that may ultimately require signalization shall be planned with a minimum of one-half mile spacing. Addition of all new connections, public or private, that may require signalization will require an engineering analysis signed and sealed by a qualified professional engineer, registered in accordance with chapter 18.43 RCW.

(ii) Private direct access:

(A) No more than one access shall be provided to an individual parcel or to contiguous parcels under the same ownership unless it can be shown that additional access points would not adversely affect the desired function of the state highway in accordance with the assigned access classification, and would not adversely affect the safety or operation of the state highway.

(B) The minimum distance to another public or private access connection shall be two hundred fifty feet. Nonconforming connection permits may be issued to provide access to parcels whose highway frontage, topography, or location would otherwise preclude issuance of a conforming connection permit.

(C) Variance permits may be allowed if conditions warrant and are demonstrated to the satisfaction of the department by a traffic analysis, signed and sealed by a qualified professional engineer, who is registered in accordance with chapter 18.43 RCW, which is included with the connection permit application.

(5) Class five.

(a) Functional characteristics:

These highways have the capacity for moderate travel speeds and moderate traffic volumes for primarily short travel distances providing for intracity and intracommunity trips primarily for access to state highways of higher classification. Access needs may generally be higher than the need for through traffic mobility without compromising the public health, welfare, or safety. These highways will generally have nonrestrictive medians.

(b) Access control design standards:

(i) It is the intent that the design of class five highways be capable of achieving a posted speed limit of twenty-five to thirty-five mph. In rural areas, spacing of intersecting streets, roads, and highways shall be planned with a minimum spacing of one-quarter mile. Less than one-quarter mile spacing may be permitted where no reasonable alternative exists. In urban areas and developing areas where higher volumes are present or growth that will require signalization is expected in the foreseeable future, it is imperative that the location of any public access be planned carefully to ensure adequate signal progression. Where feasible, major intersecting roadways that may ultimately require signalization shall be planned with a minimum of one-quarter mile spacing. Addition of all new connections, public or private, that may require signalization will require an engineering analysis signed and sealed by a qualified professional engineer, registered in accordance with chapter 18.43 RCW.

(ii) Private direct access:

(A) No more than one access shall be provided to an individual parcel or to contiguous parcels under the same ownership unless it can be shown that additional access points would not adversely affect the desired function of the state highway in accordance with the assigned access classification, and would not adversely affect the safety or operation of the state highway.

(B) The minimum distance to another public or private access connection shall be one hundred twenty-five feet. Nonconforming connection permits may be issued to provide access to parcels whose highway frontage, topography, or location would otherwise preclude issuance of a conforming connection permit.

(C) Variance permits may be allowed if conditions warrant and are demonstrated to the satisfaction of the department by a traffic analysis, signed and sealed by a qualified professional engineer, who is registered in accordance with chapter 18.43 RCW, which is included with the connection permit application.

(6) Corner clearance. Corner clearances for connections shall meet or exceed the minimum connection spacing requirements of the applicable access class where the highway segment has been assigned a classification. A single connection may be placed closer to the intersection, in compliance with the permit application process specified in chapter 468-51 WAC, and in accordance with the following criteria:

(a) If, due to property size, corner clearance standards of this chapter cannot be met, and where joint access meeting or exceeding the minimum corner clearance standards cannot be obtained, or is determined by the department to be not feasible because of conflicting land use or conflicting traffic vol-

umes or operational characteristics, then the following minimum corner clearance criteria may be used:

CORNER CLEARANCE AT INTERSECTIONS		
With Restrictive Median		
Position	Access Allowed	Minimum (feet)
Approaching intersection	Right In/Right Out	115
Approaching intersection	Right In Only	75
Departing intersection	Right In/Right Out	230*
Departing intersection	Right Out Only	100

Without Restrictive Median		
Position	Access Allowed	Minimum (feet)
Approaching intersection	Full Access	230*
Approaching intersection	Right In Only	100
Departing intersection	Full Access	230*
Departing intersection	Right Out Only	100

* For Access Class 5 and for speeds less than thirty-five mph, one hundred twenty-five feet may be used.

(b) In cases where connections are permitted under the above criteria, the permit issued in compliance with chapter 468-51 WAC shall contain the following additional conditions:

(i) There shall be no more than one connection per property frontage on the state highway.

(ii) When joint or alternate access meeting or exceeding the minimum corner clearance standards becomes available, the permit holder shall close the permitted connection, unless the permit holder shows to the department's satisfaction that such closure is not feasible.

(iii) Variance permits are not allowed.

[Statutory Authority: Chapter 47.50 RCW. 99-06-035 (Order 188), § 468-52-040, filed 2/25/99, effective 3/28/99. Statutory Authority: RCW 47.01.101 and chapter 47.50 RCW. 93-03-033 (Order 135), § 468-52-040, filed 1/13/93, effective 2/13/93.]

WAC 468-52-050 Application of access control classification system standards. (1) Review of permits on classified highway segments. Connection permit applications on controlled access facilities of the state highway system received on a particular segment that has been classified in accordance with this chapter shall be reviewed subject to the requirements of this chapter in compliance with the permit application process specified in chapter 468-51 WAC.

(2) Prior approvals. Connections permitted prior to the adoption of this chapter and unpermitted connections that do not require closure in accordance with WAC 468-51-030 are not required to meet the interim standards or the standards of assigned access classifications adopted in compliance with this chapter.

(3) New permits required by chapter 468-51 WAC. All new connection permits required due to significant changes in property site use in compliance with WAC 468-51-110, or permit modification in compliance with WAC 468-51-120 shall be reviewed subject to the requirements of this chapter.

(4) Permits approved under interim standards. Connection permits that were issued in accordance with the interim standards in WAC 468-52-040 on a highway segment where an access classification had not been adopted shall remain in effect after adoption of an access classification on that highway segment unless a new permit is required due to changes in property site use in compliance with WAC 468-51-110 or unless permit modification, revocation, or closure of the permitted connection is required in compliance with WAC 468-51-120.

(5) Nonconforming permits. Nonconforming permits may be issued in accordance with WAC 468-51-100 for certain connections not meeting the interim standards in WAC 468-52-040 or the access classification location and spacing standards adopted for a particular highway segment.

(6) Variance permits. Variance permits may be issued in accordance with WAC 468-51-105 for certain connections not meeting the access classification standards for location, spacing or exceed the number of connections allowed by the standards adopted for a particular highway segment. These permits may be allowed if conditions warrant and are demonstrated to the satisfaction of the department by a traffic analysis, signed and sealed by a qualified professional engineer who is registered in accordance with chapter 18.43 RCW, and included in the connection permit application, and will remain in effect unless a new permit is required due to changes in property site use in compliance with WAC 468-51-110 or unless permit modification, revocation, or closure of the permitted connection is required in compliance with WAC 468-51-120.

[Statutory Authority: Chapter 47.50 RCW. 99-06-035 (Order 188), § 468-52-050, filed 2/25/99, effective 3/28/99. Statutory Authority: RCW 47.01.101 and chapter 47.50 RCW. 93-03-033 (Order 135), § 468-52-050, filed 1/13/93, effective 2/13/93.]

WAC 468-52-060 Assignment of access control classifications to highway segments. The assignment of an access control classification to all controlled access segments of the state highway system shall be the responsibility of the department. The process to be followed in assigning the classifications is as follows:

(1) Defining segments. The determination of the length and termini of segments shall be the responsibility of the department working in cooperation with the Regional Transportation Planning Organizations, Metropolitan Planning Organizations, and the appropriate local governmental entities.

(a) Segments of highways to be assigned to a particular access control classification shall be defined by the department in cooperation with local governments. The length and termini of segments shall take into consideration the mobility and access needs of the traveling public, the access needs of the existing and proposed land use abutting the highway segment, and the existing and desired mobility characteristics of the roadway. The number of classification changes occurring

along a particular highway shall be minimized to provide highway system continuity, uniformity, and integrity to the maximum extent feasible. The segments shall not necessarily be confined by local jurisdictional boundaries. Points of transition between classifications along a particular route should be located on boundaries, or coincident with identifiable physical features.

(2) Assignment of classifications. All segments of all controlled access facilities on the state highway system shall be assigned to one of the access control classes one through five. The assignment of a classification to a specific segment of highway shall be the responsibility of the department. The classification shall be made in cooperation with the Regional Transportation Planning Organization, Metropolitan Planning Organization, and the appropriate local governmental entities. For city streets that are designated as state highways in compliance with chapter 47.24 RCW, the department will obtain concurrence in the final class assignment from the city or town for those state highways where the city or town is the permitting authority. The assignment of a classification shall take into consideration the following factors:

(a) Local land use plans, zoning, and land development regulations as set forth in adopted comprehensive plans;

(b) The current and potential functional classification of the highway;

(c) Existing and projected future traffic volumes;

(d) Existing and projected state, local, and metropolitan planning organization transportation plans and needs including consideration of new or improved parallel facilities;

(e) Drainage requirements;

(f) The character of the lands adjoining the highway;

(g) The type and volume of traffic requiring access;

(h) Other operational aspects of access, including corridor accident history;

(i) The availability of reasonable access to the state highway by way of county roads or city streets as an alternative to a connection to the state highway;

(j) The cumulative effect of existing and projected connections on the state highway system's ability to provide for the safe and efficient movement of people and goods within the state.

(3) Changes in jurisdiction. When the boundaries of an incorporated city or town are revised to include a portion of a controlled access state highway resulting in a change in the permitting authority from the department to the city or town in accordance with chapter 47.24 RCW, the access classification of that portion of the state highway shall remain unchanged unless modified in accordance with WAC 468-52-070.

[Statutory Authority: Chapter 47.50 RCW. 99-06-035 (Order 188), § 468-52-060, filed 2/25/99, effective 3/28/99. Statutory Authority: RCW 47.01.101 and chapter 47.50 RCW. 93-03-033 (Order 135), § 468-52-060, filed 1/13/93, effective 2/13/93.]

WAC 468-52-070 Review and modification of classifications. (1) Department initiated action. The department may, at any time, initiate a review of the access control classification of any segment of any state highway. When a major change occurs in any of the factors noted in WAC 468-52-060(2), the department shall review the access classi-

fication for the specific segments of any state highway affected by the change. Prior to the initiation of any change in classification of a highway segment, the department shall notify in writing the appropriate Regional Transportation Planning Organization, Metropolitan Planning Organization, and local governmental entities. The department will consult with the RTPO, MPO, and local governmental entities and shall take into consideration, any comments or concerns received during the review process. For city streets that are designated as state highways in compliance with chapter 47.24 RCW, the department will obtain concurrence in the final class assignment from the city or town for those state highways where the city or town is the permitting authority. The department shall notify the RTPO, MPO, and local governmental entities in writing of the final determination of the reclassification action.

(2) Requests for departmental review. A Regional Transportation Planning Organization, Metropolitan Planning Organization, or local governmental entity may request, in writing, at any time that the secretary of transportation initiate a review of the access control classification of a specific segment or segments of a state highway(s). Such written request shall identify the segment(s) of state highway for which the review is requested and shall include a specific recommendation for the reclassification of the highway segment(s) involved. Justification for the requested change shall be provided in the request taking into account the standards and criteria in WAC 468-52-040 and 468-52-060. The department will consult with the RTPO, MPO, and local governmental entities involved and shall take into consideration, any comments or concerns received during the review process. The department shall notify the RTPO, MPO, and local governmental entities in writing of the final determination of the reclassification action.

Other interested persons or organizations who wish to initiate a review of the access control classification of a specific highway segment shall do so through the local governmental entity, MPO, or RTPO.

[Statutory Authority: Chapter 47.50 RCW. 99-06-035 (Order 188), § 468-52-070, filed 2/25/99, effective 3/28/99. Statutory Authority: RCW 47.01.101 and chapter 47.50 RCW. 93-03-033 (Order 135), § 468-52-070, filed 1/13/93, effective 2/13/93.]

**Chapter 468-54 WAC
LIMITED ACCESS HEARINGS**

WAC

- 468-54-010 Definitions.
- 468-54-020 Establishment of limited access facilities—Initiation.
- 468-54-040 Notice of hearing.
- 468-54-050 Conduct of hearing.
- 468-54-065 Hearing officer.
- 468-54-070 Hearing—Findings or order—Finality.
- 468-54-080 Copies of transcripts of limited access hearings.

**DISPOSITION OF SECTIONS FORMERLY
CODIFIED IN THIS CHAPTER**

- 468-54-030 Initiation of proposal by department of transportation. [Statutory Authority: 1977 ex.s. c 151. 79-01-033 (DOT Order 10 and Comm. Order 1, Resolution No. 13), § 468-54-030, filed 12/20/78. Formerly WAC 252-06-040.] Repealed by 81-19-088 (Order 27, Resolution No. 123), filed 9/17/81. Statutory Authority: RCW

47.52.133, 47.52.145, 47.52.210 and chapter 95, Laws of 1981.

WAC 468-54-010 Definitions. As used in these rules:

(1) "Fully controlled limited access highway" is a highway where the right of owner or occupants of abutting land or other persons to access, light, air or view in connection with the highway is controlled to give preference to through traffic by providing access connections with selected public roads only, and by prohibiting crossings or direct private driveway connections at grade.

(2) "Partially controlled limited access highway" is a highway where the right of owner or occupants of abutting land or other persons to access, light, air or view in connection with the highway is controlled to give preference to through traffic to a degree that, in addition to access connections with selected public roads, there may be some crossings and some private driveway connections at grade. Commercial approaches to partially controlled limited access highways are allowed only to frontage roads or by means of public road intersections. A partially controlled limited access highway may be designed to provide for separation of a part or all road crossings and the elimination of a part or all direct private driveway connections under a stage plan of future construction.

(3) "Modified controlled limited access highway" is a highway where the right of owner or occupants of abutting land or other persons to access, light, air, or view in connection with the highway is controlled to give preference to through traffic to such a degree that most approaches, including commercial approaches, existing and in use at the time of the establishment, may be allowed.

(4) "An expressway limited access highway" is a partially controlled limited access highway of four or more traffic lanes with the opposing lanes of travel separated by a median strip of arbitrary width.

(5) "A freeway limited access highway" is a fully controlled limited access highway of four or more traffic lanes with the opposing traffic lanes separated by a median strip of arbitrary width.

(6) "Party" is any person, county, city or town who is entitled to notice of a limited access hearing and who has entered a written appearance at the hearing.

[Statutory Authority: RCW 47.52.020. 79-08-059 (Order 32), § 468-54-010, filed 7/23/79. Statutory Authority: 1977 ex.s. c 151. 79-01-033 (DOT Order 10 and Comm. Order 1, Resolution No. 13), § 468-54-010, filed 12/20/78. Formerly WAC 252-06-010.]

WAC 468-54-020 Establishment of limited access facilities—Initiation. Proceedings to establish a limited access facility may be initiated by interested persons owning property in the vicinity of the proposed facility or by the department of transportation. If the secretary of transportation ascertains that there is merit in the proposal, he will prepare an order designating the portion of the highway, road or street where the limited access highway may be established. When a public hearing is required, the secretary shall by order fix the date and place where the proposal may be heard.

[Statutory Authority: RCW 47.01.071. 91-18-023 (Order 73), § 468-54-020, filed 8/27/91, effective 9/27/91. Statutory Authority: RCW 47.52.133, 47.52.145, 47.52.210 and chapter 95, Laws of 1981. 81-19-088 (Order 27,

Resolution No. 123), § 468-54-020, filed 9/17/81. Statutory Authority: 1977 ex.s. c 151. 79-01-033 (DOT Order 10 and Comm. Order 1, Resolution No. 13), § 468-54-020, filed 12/20/78. Formerly WAC 252-06-030.]

WAC 468-54-040 Notice of hearing. Notice of the proposal to establish a limited access highway facility shall be given to the owners of property abutting the section of any existing highway being established as a limited access facility, as indicated in the tax rolls of the county and to the county and/or city or town in which the facility is proposed to be established. The notice shall be by United States mail setting forth a time and place for the hearing to be held not less than fifteen days after mailing the notice. Notice of such hearing shall also be published not less than fifteen days prior to the hearing in one or more newspapers of general circulation within such county, city or town. Such notice shall indicate a suitable location where plans for such proposal may be inspected. Notice given as herein provided shall be deemed sufficient as to any owner or reputed owner or any unknown owner or owner who cannot be located and to the county, city or town. A single hearing may be held for a proposed facility which is located in more than one county, city or town, provided that notice is given to each county, city or town.

[Statutory Authority: RCW 47.01.071. 91-18-023 (Order 73), § 468-54-040, filed 8/27/91, effective 9/27/91. Statutory Authority: RCW 47.52.020. 79-08-059 (Order 32), § 468-54-040, filed 7/23/79. Statutory Authority: 1977 ex.s. c 151. 79-01-033 (DOT Order 10 and Comm. Order 1, Resolution No. 13), § 468-54-040, filed 12/20/78. Formerly WAC 252-06-050.]

WAC 468-54-050 Conduct of hearing. At such hearing the secretary of transportation shall preside, or the secretary may designate some suitable person to preside as examiner. The hearing may, at the option of the secretary, be conducted in accordance with federal laws and regulations governing highway design public hearings. The department shall introduce by competent evidence a summary of the proposal for the establishment of a limited access facility and any evidence that supports the adoption of the plan as being in the public interest. At the conclusion of the evidence presented by the department, evidence and statements or counterproposals bearing upon the reasonableness of the proposal may be introduced. Such evidence must be material to the issues before the secretary and shall be presented in an orderly manner. Any such evidence and statements or counterproposals shall receive reasonable consideration by the secretary before any proposal is adopted.

[Statutory Authority: RCW 47.01.071. 91-18-023 (Order 73), § 468-54-050, filed 8/27/91, effective 9/27/91. Statutory Authority: RCW 47.52.133, 47.52.145, 47.52.210 and chapter 95, Laws of 1981. 81-19-088 (Order 27, Resolution No. 123), § 468-54-050, filed 9/17/81. Statutory Authority: RCW 47.52.020. 79-08-059 (Order 32), § 468-54-050, filed 7/23/79. Statutory Authority: 1977 ex.s. c 151. 79-01-033 (DOT Order 10 and Comm. Order 1, Resolution No. 13), § 468-54-050, filed 12/20/78. Formerly WAC 252-06-060.]

WAC 468-54-065 Hearing officer. The secretary of transportation may designate any suitable person as examiner with respect to hearings on any limited access proposal. Subject to later review and ruling by the secretary, such examiner may:

- (1) Examine witnesses, and receive evidence;

[Title 468 WAC—p. 84]

- (2) Admit evidence which possesses probative value commonly accepted by reasonable, prudent men in the conduct of their affairs, giving effect to the rules of privilege recognized by law and excluding incompetent, irrelevant, immaterial and unduly repetitious evidence;

- (3) Rule on offers of proof and receive relevant evidence;

- (4) Regulate the course of the hearing;

- (5) Hold conferences for the settlement or simplification of the issues by consent of the parties;

- (6) Dispose of procedural requests or similar matters;

- (7) Accept statements as to the reasonableness of the proposal; and

- (8) Establish time limits for speakers, when necessary to assure that all persons attending will have an opportunity to present relevant and material statements without undue repetition.

[Statutory Authority: RCW 47.01.071. 91-18-023 (Order 73), § 468-54-065, filed 8/27/91, effective 9/27/91. Statutory Authority: RCW 47.52.133, 47.52.145, 47.52.210 and chapter 95, Laws of 1981. 81-19-088 (Order 27, Resolution No. 123), § 468-54-065, filed 9/17/81. Statutory Authority: RCW 47.52.020. 79-08-059 (Order 32), § 468-54-065, filed 7/23/79. Statutory Authority: 1977 ex.s. c 151. 79-01-033 (DOT Order 10 and Comm. Order 1, Resolution No. 13), § 468-54-065, filed 12/20/78. Formerly WAC 252-06-065.]

WAC 468-54-070 Hearing—Findings or order—Finality. At the conclusion of such hearing the secretary of transportation shall consider the evidence taken at such hearing and shall make specific findings in the case of each proposal or counterproposal and shall adopt a plan with such modifications, if any, he deems proper and necessary. The secretary may order the adoption of any proposal or counterproposal in its entirety or in part, or may modify or reject any such proposal or counterproposal. The secretary's findings or order shall be in writing and copies thereof shall be served by United States mail upon all persons having entered a written appearance at such hearing and upon the county commissioners of the county affected and/or the mayor of the city or town affected. The secretary shall also cause a resume of such plan to be published once each week for two weeks in one or more newspapers of general circulation within such county, city or town beginning not less than ten days after the mailing of such findings and order. Such determination by the secretary shall become final within thirty days after such mailing unless a review is taken as by statute provided. In case of an appeal by any party the order shall be final as to all parties not appealing.

[Statutory Authority: RCW 47.01.071. 91-18-023 (Order 73), § 468-54-070, filed 8/27/91, effective 9/27/91. Statutory Authority: RCW 47.52.133, 47.52.145, 47.52.210 and chapter 95, Laws of 1981. 81-19-088 (Order 27, Resolution No. 123), § 468-54-070, filed 9/17/81. Statutory Authority: 1977 ex.s. c 151. 79-01-033 (DOT Order 10 and Comm. Order 1, Resolution No. 13), § 468-54-070, filed 12/20/78. Formerly WAC 252-06-070.]

WAC 468-54-080 Copies of transcripts of limited access hearings. Copies of transcripts and other hearing documents may be obtained from the headquarters office of the department of transportation. Charges for such copies shall be at the rates established for copying other public records of the department, as authorized by RCW 42.17.300. An addi-

tional charge may be imposed for certifying to any copy furnished.

[Statutory Authority: RCW 47.52.020. 79-08-059 (Order 32), § 468-54-080, filed 7/23/79. Statutory Authority: 1977 ex.s. c 151. 79-01-033 (DOT Order 10 and Comm. Order 1, Resolution No. 13), § 468-54-080, filed 12/20/78. Formerly WAC 252-06-100.]

**Chapter 468-58 WAC
LIMITED ACCESS HIGHWAYS**

WAC

- 468-58-010 Definitions.
- 468-58-020 Revision to limited access highway facilities.
- 468-58-030 Limited access highways—Policies on commercial approaches, common carrier and school bus stops, mail box locations and pedestrian crossings.
- 468-58-050 Prohibition of nonmotorized traffic on fully controlled limited access highways.
- 468-58-060 Regulations for bicyclists traveling in a group or caravan on partially controlled limited access highways.
- 468-58-080 Guides for control of access on crossroads and interchange ramps.
- 468-58-090 Guides for application of access control of state highways.
- 468-58-100 Guides for the application of modified access control on existing state highways.

DISPOSITION OF SECTIONS FORMERLY CODIFIED IN THIS CHAPTER

- 468-58-040 Use of space beneath structures on limited access highways. [Statutory Authority: RCW 47.52.020. 79-08-061 (Order 34), § 468-58-040, filed 7/23/79. Statutory Authority: 1977 ex.s. c 151. 79-01-033 (DOT Order 10 and Comm. Order 1, Resolution No. 13), § 468-58-040, filed 12/20/78. Formerly WAC 252-20-035.] Repealed by 81-19-052 (Order 65), filed 9/11/81. Statutory Authority: RCW 47.01.101(5) and 47.12.120.
- 468-58-070 Stalled or disabled vehicles as a danger to safety—Removal. [Statutory Authority: 1977 ex.s. c 151. 79-01-033 (DOT Order 10 and Comm. Order 1, Resolution No. 13), § 468-58-070, filed 12/20/78. Formerly WAC 252-20-045.] Repealed by 90-01-100 (Order 69), filed 12/20/89, effective 1/20/90. Statutory Authority: Chapter 34.05 RCW.
- 468-58-110 State Route 5. [Statutory Authority: 1977 ex.s. c 151. 79-01-033 (DOT Order 10 and Comm. Order 1, Resolution No. 13), § 468-58-110, filed 12/20/78. Formerly WAC 252-34A-030.] Repealed by 84-05-044 (Order 88), filed 2/21/84. Statutory Authority: RCW 34.04.010.

WAC 468-58-010 Definitions. The following definitions shall designate limited access highways and shall indicate the control of access to be exercised by each:

(1) "Fully controlled limited access highway" is a highway where the right of owner or occupants of abutting land or other persons to access, light, air, or view in connection with the highway is controlled to give preference to through traffic by providing access connections with selected public roads only, and by prohibiting crossings or direct private driveway connections at grade.

(2) "Partially controlled limited access highway" is a highway where the right of owner or occupants of abutting land or other persons to access, light, air, or view in connection with the highway is controlled to give preference to through traffic to a degree that, in addition to access connections with selected public roads, there may be some crossings and some private driveway connections at grade. Commercial approaches to partially controlled limited access highways are allowed only to frontage roads or by means of public road intersections. A partially controlled limited access

highway may be designed to provide for separation of a part or all road crossings and the elimination of a part or all direct private driveway connections under a stage plan of future construction.

(3) "Modified controlled limited access highway" is a highway where the right of owner or occupants of abutting land or other persons to access, light, air, or view in connection with the highway is controlled to give preference to through traffic to such a degree that most approaches, including commercial approaches, existing and in use at the time of the establishment, may be allowed.

(4) "An expressway limited access highway" is a partially controlled limited access highway of four or more traffic lanes with the opposing lanes of travel separated by a median strip of arbitrary width.

(5) "A freeway limited access highway" is a fully controlled limited access highway of four or more traffic lanes with the opposing traffic lanes separated by a median strip of arbitrary width.

[Statutory Authority: RCW 47.52.020. 79-08-061 (Order 34), § 468-58-010, filed 7/23/79. Statutory Authority: 1977 ex.s. c 151. 79-01-033 (DOT Order 10 and Comm. Order 1, Resolution No. 13), § 468-58-010, filed 12/20/78. Formerly WAC 252-20-010.]

WAC 468-58-020 Revision to limited access highway facilities. Subject to the requirements for public hearings, the transportation commission may adopt revisions to duly established limited access highway facilities, or may delegate authority for such revisions to the secretary of transportation. The secretary, at his discretion, may further delegate such authority.

[Statutory Authority: RCW 47.52.133, 47.52.145, 47.52.210 and chapter 95, Laws of 1981. 81-19-088 (Order 27, Resolution No. 123), § 468-58-020, filed 9/17/81. Statutory Authority: RCW 47.52.020. 79-08-061 (Order 34), § 468-58-020, filed 7/23/79. Statutory Authority: 1977 ex.s. c 151. 79-01-033 (DOT Order 10 and Comm. Order 1, Resolution No. 13), § 468-58-020, filed 12/20/78. Formerly WAC 252-20-020.]

WAC 468-58-030 Limited access highways—Policies on commercial approaches, common carrier and school bus stops, mail box locations and pedestrian crossings. (1) **Fully controlled limited access highways:**

(a) No commercial approaches shall be permitted direct access to main roadway but only to frontage roads when these are provided in the access plan or to the crossroads of interchanges outside the limits of full access control.

(b) No common carrier bus stops other than required by law shall be permitted except at locations provided by the state on the interchanges or, in exceptional cases, along the main roadway where pedestrian separation is available.

(c) School bus stops shall not be permitted except as in subparagraph (b) of this subsection.

(d) No mail boxes shall be permitted except on frontage roads.

(e) Pedestrian crossings shall not be permitted at grade.

(2) **Partially controlled limited access highways:**

(a) No commercial approaches shall be permitted except on frontage roads provided in the access plan or at intersections.

(b) Bus stops for both common carriers and school buses shall not be permitted other than as required by law on either two or four lane highways, except as follows:

(i) At locations of intersections, with necessary lanes to be constructed by the state;

(ii) Where shoulder widening has been provided for mail delivery service;

(iii) For a designated school bus loading zone on the traveled lane or adjacent thereto which has been approved by the department of transportation.

(c) Pedestrian grade crossings will be permitted only where a grade crossing is provided, except that pedestrian crossings will be permitted on two lane highways at mail box locations or at points designated for school children to cross as provided in subparagraph (d) of this subsection.

(d) Pedestrian crossings are prohibited in the immediate vicinity of school bus loading zones which are located adjacent to the traveled way. Pedestrian crossings may be permitted:

(i) On two lane highways not less than one hundred feet from a school bus loading zone adjacent to the traveled lane, if school district and department of transportation personnel determine that stopping in the traveled lane is hazardous.

(ii) On two lane highways at the school bus when stopped on the traveled lane to load or unload passengers and the proper sign and signal lights displayed.

(e) School bus loading zones on partially controlled access highways shall be posted with school bus loading zone signs, in accordance with the latest edition of the Manual on Uniform Traffic Control Devices.

(f) The list of designated school bus loading zones approved by the department of transportation will be kept on file and maintained by the headquarters traffic engineer.

(g) Mail boxes shall be located on frontage roads or at intersections, with the following exceptions for properties which are served by Type A or B approaches:

(i) Mail boxes for Type A or B approaches on a four lane highway shall be located only on the side of the highway on which the approach is provided;

(ii) Mail boxes for Type A or B approaches on a two lane highway shall all be located on that side of the highway which is on the right in the direction of the mail delivery.

(3) Modified control limited access highways:

(a) Commercial approaches to modified controlled limited access highways may be permitted only where and in the manner specifically authorized at the time the plan is established and access rights are obtained.

(b) Bus stops and pedestrian crossings may be permitted as follows:

(i) In rural areas, bus stops and pedestrian crossings shall be subject to the same restrictions as on partial controlled limited access highways.

(ii) In urban areas bus stops for both commercial carriers and school buses may be permitted without restrictions other than those required by law.

(c) Mail boxes may be located adjacent to or opposite all authorized approaches as follows:

(i) Mail boxes on a four-lane highway shall be located only on the side of the highway on which the approach is provided.

(ii) Mail boxes on a two-lane highway shall all be located on that side of the highway which is on the right in the direction of the mail delivery.

[Statutory Authority: RCW 47.52.020, 79-08-061 (Order 34), § 468-58-030, filed 7/23/79. Statutory Authority: RCW 47.36.050, 79-08-060 (Order 33), § 468-58-030, filed 7/23/79. Statutory Authority: 1977 ex.s. c 151, 79-01-033 (DOT Order 10 and Comm. Order 1, Resolution No. 13), § 468-58-030, filed 12/20/78. Formerly WAC 252-20-030.]

WAC 468-58-050 Prohibition of nonmotorized traffic on fully controlled limited access highways. (1) All non-motorized traffic shall be prohibited on state highways which have been established and constructed as fully controlled limited access facilities, and signs giving notice of such prohibition shall be posted upon all such highways.

(2) This prohibition of nonmotorized traffic on fully controlled limited access highways shall not apply to:

(a) Pedestrian overcrossings and undercrossings or other facilities provided specifically for the use of such traffic.

(b) Bicycles utilizing the right-hand shoulders; except where the secretary of transportation or his designee has prohibited such use. Signs giving notice of such prohibition shall be posted for those sections where such usage is prohibited.

[Statutory Authority: RCW 47.52.025 and 46.61.160, 82-01-029 (Order 70), § 468-58-050, filed 12/14/81. Statutory Authority: RCW 47.36.050, 80-05-027 (Order 53), § 468-58-050, filed 4/15/80. Statutory Authority: 1977 ex.s. c 151, 79-01-033 (DOT Order 10 and Comm. Order 1, Resolution No. 13), § 468-58-050, filed 12/20/78. Formerly WAC 252-20-040.]

WAC 468-58-060 Regulations for bicyclists traveling in a group or caravan on partially controlled limited access highways. (1) Riding single file on the usable shoulder is encouraged.

(2) Care and caution as well as compliance with rules of the road and traffic control devices - signs, signals and markings shall be exercised by bicycle operators when traveling upon state highways.

(3) No person operating a bicycle shall stop on a bridge or other structure, except on a sidewalk or other area not less than three feet wide separated from the traveled roadway by a painted stripe or a physical barrier.

(4) When traveling in a large group, caravan or expedition, the size of travel units shall be limited to a maximum of six bicyclists per unit.

(5) The maximum number of units in a group, caravan or expedition shall not exceed twenty-five.

(6) Travel units of bicyclists shall maintain a minimum spacing between travel units of 500 feet to provide passing opportunities for motor vehicle operators.

[Statutory Authority: 1977 ex.s. c 151, 79-01-033 (DOT Order 10 and Comm. Order 1, Resolution No. 13), § 468-58-060, filed 12/20/78. Formerly WAC 252-20-060.]

WAC 468-58-080 Guides for control of access on crossroads and interchange ramps. (1) Fully controlled highways, including interstate.

(a) There shall be no connections to abutting property or local service or frontage roads within the full length of any "off" or "on" interchange ramp from a fully controlled limited access highway. Such ramp shall be considered to terminate at its intersection with the local road which undercrosses or

overcrosses the limited access facility, provided that in urban areas "off" and "on" ramps may be terminated at local streets other than crossroads where necessary to service existing local traffic.

(b) There shall be no direct connections from the limited access facility in rural areas to local service or frontage roads except through interchanges.

(c) In both urban and rural areas access control on a fully controlled highway shall be established along the crossroad at an interchange for a minimum distance of three hundred feet beyond the centerline of the ramp or terminus of transition taper. If a frontage road or local road is located in a generally parallel position within three hundred fifty feet of a ramp, access control should be established along the crossroad and in addition for a minimum distance of one hundred thirty feet in all directions from the center of the intersection of the parallel road and crossroad.

(d) Full control of access should be provided along the crossroad from the centerline of a ramp or terminus of a transition taper for a minimum distance of three hundred feet. Upon determination by the department, full control of access may be provided for the first one hundred thirty feet from the centerline of the ramp or terminus of a transition taper and partial control or modified control of access may be provided for the remainder of the distance to the frontage road or local road for a total minimum distance for the two types of control of three hundred feet. Type A, B, C, D and E road approaches, as defined hereafter under subsection (3) of this section, "general," may be permitted on that portion of the crossroad on which partial or modified control of access is established.

(2) Partially controlled highways.

(a) There shall be no connections to abutting property or local service or frontage roads within the full length of any "off" or "on" interchange ramp from a partially controlled limited access highway. Such ramp shall be considered to terminate at its intersection with the local road which undercrosses or overcrosses the limited access facility, provided that in urban areas "off" and "on" ramps may be terminated at local streets other than crossroads where necessary to service existing local traffic.

(b) In both urban and rural areas access control on a partially controlled highway shall be established along the crossroad at an interchange for a minimum distance of three hundred feet beyond the centerline of the ramp or terminus of transition taper. If a frontage road or local road is located in a generally parallel position within three hundred fifty feet of a ramp, access control should be established along the crossroad and in addition for a minimum distance of one hundred thirty feet in all directions from the center of the intersection of the parallel road and crossroad.

(c) Access control limits at the crossroads on a partially controlled highway should be established along the crossroad at a grade intersection for a minimum distance of three hundred feet from the centerline of the nearest directional roadway. If a parallel road is located within three hundred fifty feet of said grade intersection, access control should be established along the crossroad and in addition for a minimum distance of one hundred thirty feet in all directions from the center of the intersection of the parallel road and crossroad. Type

D and E approaches may be permitted closer than one hundred thirty feet from the center of the intersection only when they already exist and cannot reasonably be relocated.

(d) Access control limits at intersections on modified control highways should be established along the cross road for a minimum distance of one hundred thirty feet from the centerline of a two-lane highway or for a minimum of one hundred thirty feet from centerline of the nearest directional roadway of a four-lane highway. Type D and E approaches should be allowed within this area only when no reasonable alternative is available.

(3) General.

(a) Access control may be increased or decreased beyond or under the minimum requirements to fit local conditions if so determined by the department.

(b) Type A, B, C, D and E approaches are defined as follows:

(i) Type A approach. Type A approach is an off and on approach in legal manner, not to exceed thirty feet in width, for sole purpose of serving a single family residence. It may be reserved by abutting owner for specified use at a point satisfactory to the state at or between designated highway stations.

(ii) Type B approach. Type B approach is an off and on approach in legal manner, not to exceed fifty feet in width, for use necessary to the normal operation of a farm, but not for retail marketing. It may be reserved by abutting owner for specified use at a point satisfactory to the state at or between designated highway stations.

(iii) Type C approach. Type C approach is an off and on approach in legal manner, for special purpose and width to be agreed upon. It may be specified at a point satisfactory to the state at or between designated highway stations.

(iv) Type D approach is an off and on approach in a legal manner not to exceed fifty feet in width for use necessary to the normal operation of a commercial establishment. It may be specified at a point satisfactory to the state at or between designated highway stations.

(v) Type E approach is a separated off and on approach in a legal manner, with each opening not exceeding thirty feet in width, for use necessary to the normal operations of a commercial establishment. It may be specified at a point satisfactory to the state at or between designated highway stations.

(c) Under no circumstances will a change in location or width of an approach be permitted unless approved by the secretary. Noncompliance or violation of these conditions will result in the immediate closure of the approach.

(d) Commercial approaches shall not be permitted within the limits of access control except where modified access control has been approved by the department.

(e) All access control shall be measured from the centerline of the ramps, crossroads or parallel roads or from the terminus of transition tapers. On multiple lane facilities measurement shall be from the centerline of the nearest directional roadway.

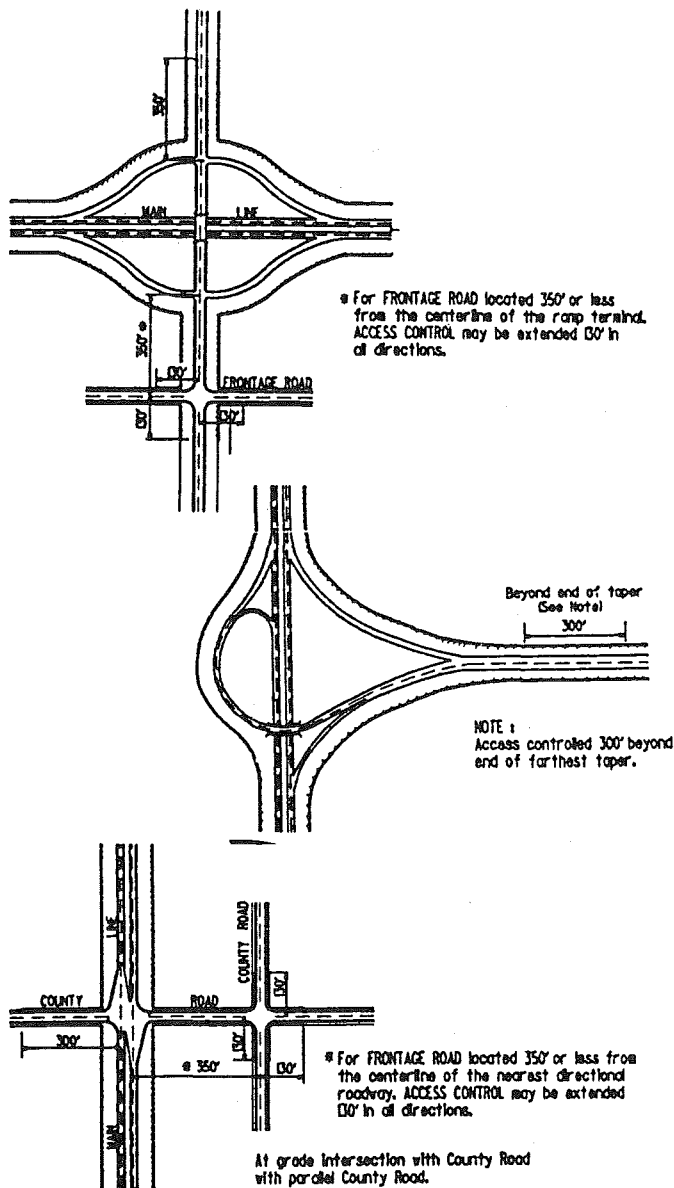

[Statutory Authority: RCW 47.01.101(5), 87-15-021 (Order 109), § 468-58-080, filed 7/8/87. Statutory Authority: RCW 47.52.020, 79-08-061 (Order 34), § 468-58-080, filed 7/23/79. Statutory Authority: 1977 ex.s. c 151, 79-01-033 (DOT Order 10 and Comm. Order 1, Resolution No. 13), § 468-58-080, filed 12/20/78. Formerly WAC 252-20-051.]

WAC 468-58-090 Guides for application of access control of state highways. (1) Fully controlled limited access highways:

(a) All interstate highways shall require full access control.

(b) All principal arterial highways requiring four or more through traffic lanes within a twenty-year design period, shall require full control of access, unless approved for partial or modified access control on existing highways by the secretary of transportation or his designee.

(2) Partially controlled limited access highways:

(a) Principal arterial highways requiring two through traffic lanes where the estimated traffic volumes exceed three thousand average daily traffic within a twenty-year design period shall require partial control of access, unless approved

for modified access control on existing highways by the secretary of transportation or his designee.

(b) Rural minor arterial highways on both new and existing location and urban minor arterial highways on new location, requiring four or more through traffic lanes within a twenty-year design period, or requiring only two through traffic lanes where the estimated traffic volumes exceed three thousand average daily traffic within a twenty-year design period, shall require partial control of access; however, modified access control may be applied on existing location when approved by the secretary of transportation or his designee.

(c) Collector highways on new location requiring four or more through traffic lanes in a twenty-year design period shall require partial control of access.

(d) Other rural minor arterial highways with only two lanes may be considered for partial or modified control of access if the control can be acquired at a reasonable cost; if the route connects two highways of a higher classification; if the potential land development would result in numerous individual approaches such as may be encountered in a recreational area; or if the highway traverses publicly owned lands where access control seems desirable.

(e) Partial access control will not normally be used in urban areas, or inside corporate limits on existing principal arterial or minor arterial highways where traffic volumes are less than seven hundred design hour volume if required levels of urban service, including operating speeds, can be maintained for the estimated traffic under existing and estimated future conditions, including traffic engineering operational improvements. If not, the route should be relocated or reconstructed in accordance with the modified or partial access control standards.

(f) Existing collector highways will normally be considered for access control only where all of the following conditions apply:

(i) The highway serves an area which is not directly served by a higher class of highway.

(ii) Existing or planned development will result in traffic volumes significantly higher than the warrants for access control on minor arterials.

(iii) Partial or modified access control may be established without a major impact on development of abutting properties within the constraints of zoning established at the time access control is proposed.

(g) Termini of access control sections should be at apparent logical points of design change.

(3) Modified access control - Access control on existing highways:

(a) Modified access control may be established on existing highways. The degree of control applied will be such that most approaches, including commercial approaches, existing and in use at the time of the establishment, may be allowed. Commercial approaches for future development may also be considered in order to avoid economic land locking. No commercial approaches will be allowed other than those included in the plan at the time access control is established and access rights are acquired.

(b) Selection of facilities on which modified access control will be applied, will be based upon a design analysis considering but not limited to traffic volumes, level of service,

route continuity, population density, local land use planning predicted growth rate established by the planning agency having jurisdiction, economic analysis, and safety. A comparison of these factors based on modified access control versus full or partial control shall be the basis of the decision by the secretary of transportation or his designee to establish modified access control on a section or sections of highway.

(c) Where modified access control is to be established on existing highways, commercial areas may be excepted from control when all or most of the abutting property is developed to the extent that few, if any, additional road approaches would be required with full development of the area. Such exceptions will not normally extend to corporate limits or to urban area boundaries.

Nothing in this policy should be construed to prevent short sections of full, partial, or modified control of access where unusual topographic, land use, or traffic conditions exist. Special design problems should be dealt with on the basis of sound engineering-economic principles.

Because specific warrants cannot be logically or economically applied in every circumstance, exceptions may be considered upon presentation to the secretary of transportation or his designee of justification for reasonable deviation from this policy.

[Statutory Authority: RCW 47.52.020. 79-08-061 (Order 34), § 468-58-090, filed 7/23/79. Statutory Authority: 1977 ex.s. c 151. 79-01-033 (DOT Order 10 and Comm. Order 1, Resolution No. 13), § 468-58-090, filed 12/20/78. Formerly WAC 252-20-080.]

WAC 468-58-100 Guides for the application of modified access control on existing state highways. (1) Definitive standards for road approaches on modified access controlled highways shall be as follows:

(a) The type of approach for each parcel shall be commensurate with the present and potential land use and be based on appraisals which consider the following:

(i) Local comprehensive plans, zoning and land use ordinances.

(ii) Property covenants and/or agreements.

(iii) City or county ordinances.

(iv) The highest and best use of the property.

(v) Highest use and best use of adjoining lands.

(vi) Change in use by merger of adjoining ownerships.

(vii) All other factors bearing upon proper land use of the parcel.

(b) The type of approaches* to be considered are:

(i) Type A (residential).

(ii) Type B (farm).

(iii) Type C (special use).

(iv) Type D (commercial single 50 feet width).

(v) Type E (commercial double 30 feet width).

(c) Once established, the type, size and location of the approach may be modified by the secretary of transportation or his designee.

(d) When Type D or E approaches have been established, interim use of Type A or B approaches will be allowed.

(2) Design. The number and location of approaches on a modified access control highway shall be carefully planned to provide a safe highway compatible with present and potential land use. The following will be applied:

(2001 Ed.)

(a) Parcels which have access to another public road or street as well as frontage on the highway will not normally be allowed direct access to the highway.

(b) Approaches located in areas where sight limitations create undue hazard shall be relocated or closed.

(c) The number of access openings shall be held to a minimum. Access openings are limited to one approach for each parcel of land with the exception of extensive frontages where one approach is unreasonable or for Type E approaches which feature separate off and on approaches.

(d) Joint use of access approaches shall be considered, where feasible.

(e) New approaches will be considered at the time of plan adoption to prevent a physical "landlock" by reason of access taking.

(f) Existing access points not meeting the test of these rules as described in this section, will be closed.

*Refer to WAC 468-58-080 for definitions.

[Statutory Authority: RCW 47.52.020. 79-08-061 (Order 34), § 468-58-100, filed 7/23/79. Statutory Authority: 1977 ex.s. c 151. 79-01-033 (DOT Order 10 and Comm. Order 1, Resolution No. 13), § 468-58-100, filed 12/20/78. Formerly WAC 252-20-090.]

Chapter 468-66 WAC

HIGHWAY ADVERTISING CONTROL ACT

WAC

468-66-010	Definitions.
468-66-020	Restrictions on signs.
468-66-030	General provisions.
468-66-050	Classification of signs.
468-66-055	National scenic byway demonstration project.
468-66-060	Signs along scenic, primary, and interstate systems.
468-66-070	On-premise signs (Type 3).
468-66-080	Number of signs and spacing requirements along interstate system.
468-66-090	Preference of applicants for Type 4, Type 5, and Type 8 sites.
468-66-100	Advertising copy.
468-66-110	Signs within commercial and industrial areas of primary system.
468-66-120	Signs erected prior to June 1, 1971 in commercial and industrial areas along the primary system.
468-66-130	Signs to be removed.
468-66-140	Permits.
468-66-150	Penalties.

DISPOSITION OF SECTIONS FORMERLY CODIFIED IN THIS CHAPTER

468-66-040	Measurements of distance. [Statutory Authority: 1977 ex.s. c 151. 79-01-033 (DOT Order 10 and Comm. Order 1, Resolution No. 13), § 468-66-040, filed 12/20/78. Formerly WAC 252-40-030.] Repealed by 80-04-095 (Order 52), filed 4/1/80. Statutory Authority: RCW 47.42.060.
468-66-175	Highway fatality markers. [Statutory Authority: RCW 47.42.060. 88-22-002 (Order 116), § 468-66-175, filed 10/20/88.] Repealed by 94-12-049 (Order 144), filed 5/27/94, effective 6/27/94. Statutory Authority: Chapter 47.42 RCW and RCW 47.01.101(5).

WAC 468-66-010 Definitions. The following terms when used in this chapter shall have the following meanings:

(1) "Abandoned." A sign for which neither sign owner nor land owner claim any responsibility.

(2) "Act" shall mean the Highway Advertising Act of 1961, as amended and embodied in chapter 47.42 RCW.

(3) "Centerline of the highway" means a line equidistant from the edges of the median separating the main-traveled ways of a divided highway, or the centerline of the main-traveled way of a nondivided highway.

(4) "Commercial and industrial areas" means any area zoned commercial or industrial by a county or municipal code, or if unzoned or zoned for general uses by a county or municipal code, that area occupied by three or more separate and distinct commercial and/or industrial activities within a space of five hundred feet and the area within five hundred feet of such activities on both sides of the highway. The area shall be measured from the outer edges of the regularly used buildings, parking lots, storage or processing areas of the commercial or industrial activity and not from the property lines of the parcels upon which such activities are located. Measurements shall be along or parallel to the edge of the main-traveled way of the highway. The following shall not be considered commercial or industrial activities:

(a) Agricultural, forestry, grazing, farming, and related activities, including, but not limited to, wayside fresh produce stands;

(b) Transient or temporary activities;

(c) Railroad tracks and minor sidings;

(d) Signs;

(e) Activities more than six hundred and sixty feet from the nearest edge of the right of way;

(f) Activities conducted in a building principally used as a residence.

Should any commercial or industrial activity, which has been used in defining or delineating an unzoned area, cease to operate for a period of six continuous months, any signs located within the former unzoned area shall become nonconforming and shall not be maintained by any person after May 10, 1974.

(5) "Commission" means the Washington state transportation commission.

(6) "Discontinued." A sign shall be considered discontinued if, after receiving notice of absence of advertising content for three months, the permit holder fails to put advertising content on the sign within three months of the notice.

(7) "Entrance roadway" means any public road or turning roadway including acceleration lanes, by which traffic may enter the main-traveled way of a controlled access highway from the general road system within the state, including rest areas, view points, and sites used by the general public, irrespective of whether traffic may also leave the main-traveled way by such road or turning roadway.

(8) "Erect" means to construct, build, raise, assemble, place, affix, attach, create, paint, draw, or in any other way bring into being or establish.

(9) "Exit roadway" means any public road or turning roadway including deceleration lanes, by which traffic may leave the main-traveled way of a controlled access highway to reach the general road system within the state, including rest areas, view points, and sites used by the general public, irrespective of whether traffic may also enter the main-traveled way by such road or turning roadway.

(10) "Interstate system" means any state highway which is or does become part of the national system of interstate and

defense highways as described in section 103(e) of Title 23, United States Code.

(11) "Legible" means capable of being read without visual aid by a person of normal visual acuity.

(12) "Maintain" means to allow to exist. A sign loses its right to remain as a nonconforming sign if its size is increased more than fifteen percent over its size on the effective date of the Scenic Vistas Act on May 10, 1971, or the effective date of control of a given route, whichever is applicable. The sign may continue as long as it is not destroyed, abandoned, or discontinued. Such signs may be reerected in kind if destroyed due to vandalism, and other criminal or tortious acts.

(13) "Main-traveled way" means the traveled way of a highway on which through traffic is carried. In the case of a divided highway, the traveled way of each of the separated roadways for traffic in opposite directions is a main-traveled way. It does not include such facilities as frontage roads, turning roadways, entrance roadways, exit roadways, or parking areas.

(14) "Person" means this state or any public or private corporation, firm, partnership, association, as well as any individual, or individuals.

(15) "Primary system" means any state highway which is part of the federal-aid primary system as described in section 103(b) of Title 23, United States Code, in existence on June 1, 1991, as enacted in the 1991 Intermodal Surface Transportation Efficiency Act, and any highway which is not on such system but which is on the National Highway System.

(16) "Scenic system" means:

(a) Any state highway within any public park, federal forest area, public beach, public recreation area, or national monument;

(b) Any state highway or portion thereof outside the boundaries of any incorporated city or town designated in RCW 47.42.140 by the legislature as a part of the scenic system; or

(c) Any national scenic byway, state scenic byway, or state highway or portion thereof, outside the boundaries of any incorporated city or town, designated by the legislature in chapter 47.39 RCW as a part of the scenic and recreational highway system except for the sections of highways specifically excluded in RCW 47.42.025 or located within areas zoned by the governing county for predominantly commercial and industrial uses, and having development visible to the highway as determined by the department.

(17) "Sign" means any outdoor sign, display, device, figure, painting, drawing, message, placard, poster, billboard, or other thing which is designed, intended or used to advertise or inform, any part of the advertising or informative contents of which is visible from any place on the main-traveled way of the interstate system or other state highway.

(18) "Trade name" shall include brand name, trademark, distinctive symbol, or other similar device or thing used to identify particular products or services.

(19) "Traveled way" means the portion of a roadway for the movement of vehicles, exclusive of shoulders.

(20) "Turning roadway" means a connecting roadway for traffic turning between two intersection legs of an interchange.

(21) "Visible" means capable of being seen (whether or not legible) without visual aid by a person of normal visual acuity.

(22) "Electronic sign" means an outdoor advertising sign, display, or device whose message may be changed by electrical or electronic process, and includes the device known as the electronically changeable message center for advertising on-premise activities (WAC 468-66-070).

(23) "Public service information" means a message on an electronic sign which provides the time, date, temperature, weather, or information about nonprofit activities sponsored by civic or charitable organizations.

(24) "Temporary agricultural directional sign" means a sign on private property adjacent to state highway right of way to provide directional information to places of business offering for sale seasonal agricultural products.

(25) "National scenic byway" means any state highway designated as part of the national scenic byway system authorized by the 1991 Intermodal Surface Transportation Efficiency Act.

(26) "State scenic byway" means any scenic and recreational highway established by chapter 47.39 RCW.

(27) "Visible development" means those areas determined by the department to have development, both in type and location, that meet the requirements for unzoned commercial and industrial areas prescribed by RCW 47.42.020(9) and such development is not visually obstructed by vegetation or other natural features. It is prohibited to remove vegetation or other natural features, located within the state highway right of way, that may act as visual obstructions.

(28) "Tri-vision sign" means a sign having a series of three-sided rotating slats arranged side by side, either horizontally or vertically, which are rotated by an electric-mechanical process, capable of displaying a total of three separate and distinct messages, one message at a time.

[Statutory Authority: Chapter 47.42 RCW. 97-17-010 (Order 170), § 468-66-010, filed 8/7/97, effective 9/7/97; 96-13-007, § 468-66-010, filed 6/6/96, effective 7/7/96. Statutory Authority: Chapter 47.42 RCW and RCW 47.01.101(5). 94-12-049 (Order 144), § 468-66-010, filed 5/27/94, effective 6/27/94. Statutory Authority: Chapter 47.42 RCW. 92-09-043 (Order 130), § 468-66-010, filed 4/10/92, effective 5/11/92. Statutory Authority: RCW 47.42.060. 88-22-002 (Order 116), § 468-66-010, filed 10/20/88; 86-01-063 (Order 99), § 468-66-010, filed 12/17/85. Statutory Authority: Chapter 47.42 RCW. 85-17-012 (Order 96), § 468-66-010, filed 8/12/85. Statutory Authority: RCW 47.42.060. 85-03-031 (Order 94), § 468-66-010, filed 1/10/85; 80-06-057 (Order 56), § 468-66-010, filed 5/19/80. Statutory Authority: 1977 ex.s. c 151. 79-01-033 (DOT Order 10 and Comm. Order 1, Resolution 13), § 468-66-010, filed 12/20/78. Formerly WAC 252-40-010.]

WAC 468-66-020 Restrictions on signs. Except as permitted by the act and these regulations, no person shall erect or maintain a sign which is visible from the main-traveled way of the interstate system, the primary system, or the scenic system. In case a highway or a section of highway is both a part of the primary system and the scenic system, only those signs permitted along the scenic system shall be erected or maintained.

[Statutory Authority: 1977 ex.s. c 151. 79-01-033 (DOT Order 10 and Comm. Order 1, Resolution No. 13), § 468-66-020, filed 12/20/78. Formerly WAC 252-40-015.]

(2001 Ed.)

WAC 468-66-030 General provisions. Notwithstanding any other provision of the act or these regulations, no signs visible from the main-traveled way of the interstate system, primary system, or scenic system which have any of the following characteristics shall be erected or maintained:

(1) Signs advertising activities that are illegal under state or federal laws or regulations in effect at the location of such signs or at the location of such activities.

(2) Illegal, destroyed, abandoned, discontinued or obsolete signs.

(3) Signs that are not clean and in good repair.

(4) Signs that are not securely affixed to a substantial structure.

(5) Signs which attempt or appear to attempt to direct the movement of traffic or which interfere with, imitate or resemble any official traffic sign, signal or device.

(6) Signs which prevent the driver of a vehicle from having a clear and unobstructed view of official signs and approaching or merging traffic.

(7) Signs which contain, include, or are illuminated by any flashing, intermittent, or moving light or lights (except those signs giving public service information).

(8) Signs which use any lighting in any way unless it is so effectively shielded as to prevent beams or rays of light from being directed at any portion of the traveled ways of the highway or is of such low intensity or brilliance as not to cause glare or to impair the vision of the driver of any motor vehicle, or to otherwise interfere with any driver's operation of a motor vehicle.

(9) Signs which move or have any animated or moving parts (except revolving signs giving public service information).

(10) Signs which are erected or maintained upon trees, power poles or painted or drawn upon rocks or other natural features.

(11) Signs which exceed twenty feet in length, width or height, or one hundred fifty square feet in area, including border and trim but excluding supports, except:

(a) Larger signs as permitted within commercial and industrial areas adjacent to the primary system pursuant to RCW 47.42.062; and

(b) Type 3 signs not more than fifty feet from the advertised activity; and

(c) Single on-premise signs advertising shopping centers, malls, and business combinations as described in WAC 468-66-070(3); and

(d) Type 8 signs shall not exceed thirty-two square feet in area, unless they qualify as Type 3 (on-premise) signs.

(12) Electronic signs may be used only to advertise activities conducted or goods and services available on the property on which the signs are located or to present public service information.

(a) Advertising messages may contain words, phrases, sentences, symbols, trade-marks, and logos. A single message or a segment of a message must have a display time of at least two seconds including the time to move onto the sign board, with all segments of the total message to be displayed within ten seconds. A message consisting of only one segment may remain on the sign board as long as desired.

(b) Electronic signs requiring more than four seconds to change from one single message display to another shall be turned off during the change interval.

(c) Displays traveling horizontally across the sign board must move between sixteen and thirty-two light columns per second. Displays can scroll onto the sign board but must hold for two seconds including scrolling.

(d) Sign displays shall not include any art animations or graphics that portray motion, except for movement of graphics onto or off of the sign board as previously described.

(e) No electronic sign lamp may be illuminated to a degree of brightness that is greater than necessary for adequate visibility. Signs found to be too bright shall be adjusted in accordance with the instructions of the department.

(f) As on-premise signs, electronic signs are subject to the provisions of RCW 47.42.045 and 47.42.062.

(13) Tri-vision signs may be used as Type 3, Type 4, or Type 5 signs, with the following provisions:

(a) Visible to Interstate highways, tri-vision signs may only be used as Type 3 signs.

(b) Rotation of one sign face to another sign face is no more frequent than every eight seconds and the actual rotation process shall be accomplished in four seconds or less.

(c) Tri-vision signs shall contain a default mechanism that will stop the sign in one position should a malfunction occur.

(d) Maximum size limitations shall independently apply to each sign face, including framework and border.

(e) Tri-vision signs are subject to all other applicable provisions of chapter 47.42 RCW and chapter 468-66 WAC.

[Statutory Authority: Chapter 34.05 RCW and RCW 47.42.060, 99-24-083 (Order 195), § 468-66-030, filed 11/30/99, effective 12/31/99. Statutory Authority: Chapter 47.42 RCW, 97-17-010 (Order 170), § 468-66-030, filed 8/7/97, effective 9/7/97; 85-17-012 (Order 96), § 468-66-030, filed 8/12/85. Statutory Authority: RCW 47.42.060, 85-03-031 (Order 94), § 468-66-030, filed 1/10/85; 80-04-095 (Order 52), § 468-66-030, filed 4/1/80. Statutory Authority: 1977 ex.s. c 151, 79-01-033 (DOT Order 10 and Comm. Order 1, Resolution 13), § 468-66-030, filed 12/20/78. Formerly WAC 252-40-020.]

WAC 468-66-050 Classification of signs. Signs shall be classified as follows:

(1) Type 1—Directional or other official signs or notices.

(a) Signs and notices erected and maintained by public offices or public agencies within their territorial or zoning jurisdiction and pursuant to and in accordance with direction or authorization contained in federal, state, or local law for the purposes of carrying out an official duty or responsibility. Historical markers authorized by state law and erected by state or local government agencies or nonprofit historical societies may be considered official signs.

(b) Service club and religious notices, whose message shall contain only the name of a nonprofit service club or religious organization, its address and the time of its meeting or service.

(2) Type 2—For sale or lease sign. A sign not prohibited by state law which is consistent with the applicable provisions of these regulations and which only advertises the sale or lease of the parcel of real property upon which the sign is located. The name of the owner of the property offered for sale or lease, or the owner's agent and phone number shall not

be displayed more conspicuously than the words "for sale" or "for lease." No other message may be displayed on the sign. Not more than one such sign advertising the sale or lease of a parcel of property shall be visible to traffic proceeding in any one direction on an interstate system, primary system or scenic system highway.

(3) Type 3—On-premise sign.

(a) A sign advertising an activity conducted on the property on which the sign is located. The sign, except as provided under (b) of this subsection, shall be limited to identifying the establishment or the principal or accessory products or services offered on the property. A sign consisting principally of a brand name, trade name, product, or service incidental to the principal products or services offered on the property, or bringing rental income to the property owner, is not considered an on-premise sign. Not more than one such sign, visible to traffic proceeding in any one direction on an interstate system, primary system, or scenic system highway may be permitted more than fifty feet from the advertised activity.

(b) Temporary political campaign signs are a Type 3 on-premise sign, on which the property owner expresses endorsement of a political candidate or ballot issue, with the following restrictions:

(i) Temporary political campaign signs are limited to a maximum size of thirty-two square feet in area.

(ii) Temporary political campaign signs must be removed within ten days after the election.

(iii) Except as provided in (b)(i) and (ii) of this subsection, temporary political campaign signs are subject to all other applicable provisions of chapter 47.42 RCW and chapter 468-66 WAC that pertain to Type 3 on-premise signs.

(c) Signs reading "future site of" or similar wording will be allowed as an on-premise sign without any activity being apparent on the site for one year from date of installation provided the following conditions have been met:

(i) The department of transportation has received a letter of notification of intent from the owner of the proposed advertised activity.

(ii) The sign shall not inform of activities conducted elsewhere.

(iii) The maximum size of a future site sign shall not be greater than one hundred fifty square feet.

The sign must be removed at the end of the one year time period if the advertised activity has not become operational.

(4) Type 4—Signs within twelve air miles of advertised activities. Signs not prohibited by state law which are consistent with the applicable provisions of these regulations and which advertise activities conducted within twelve air miles of such signs.

(5) Type 5—Signs in the specific interest of the traveling public. Signs authorized to be erected or maintained by state law which are consistent with these regulations and which are designed to give information in the specific interest of the traveling public.

(6) Type 6—Signs lawfully in existence on October 22, 1965, determined by the department of transportation, subject to the approval of the United States Secretary of Transportation, to be landmark signs, including signs on farm structures or natural surfaces, of historic or artistic significance the

preservation of which would be consistent with the purposes of chapter 47.42 RCW.

(7) Type 7—Public service signs located on school bus stop shelters, which:

(a) Identify the donor, sponsor or contributor of said shelters;

(b) Contain safety slogans or messages which do not pertain to the donor and occupy not less than sixty percent of the area of the signs. In addition to this area limitation the donor identification portion of the sign may not appear more prominently than the safety slogan message;

(c) Contain no other message;

(d) Are located on school bus shelters which are authorized or approved by city, county, or state law, regulation or ordinance, off the state highway right of way. School bus shelters shall not exceed 10 feet in length, 10 feet in width or 8 feet in height and shall be constructed with the upper 4 feet of the sides perpendicular to the roadway being occupied by the sign. The remainder is to be constructed of a see through nature. No school bus shelter shall be located along fully controlled access highways as specifically referenced in WAC 468-58-030;

(e) Do not exceed 32 square feet in area. Not more than one sign on each shelter may face in any one direction. The sign shall not protrude above the roof line or beyond the sides of the shelter;

(f) Signs erected pursuant to a permit issued by the department of transportation as provided in RCW 47.42.120 and 47.42.130 and the regulations issued thereunder. A permit shall be required for each individual sign face.

(8) Type 8—Temporary agricultural directional signs, with the following restrictions:

(a) Signs shall be posted only during the period of time the seasonal agricultural product is being sold;

(b) Signs shall not be placed adjacent to the interstate highway system unless the sign qualifies as an on-premise (Type 3) sign;

(c) Signs shall not be placed within an incorporated city or town, but may be placed in unzoned areas and areas zoned for agricultural, commercial, and industrial activities;

(d) Premises on which the seasonal agricultural products are sold must be within fifteen miles of the state highway, and necessary supplemental signing on local roads must be provided before the installation of the signs on the state highway;

(e) Signs must be located so as not to restrict sight distances on approaches to intersections, or restrict the visibility of other authorized signs;

(f) The minimum spacing between sign structures shall be three hundred feet. For the purposes of this subsection, a back-to-back sign and a V-type sign shall be considered one sign structure (spacing is independent of off-premise (Type 4 and Type 5) signs).

[Statutory Authority: Chapter 34.05 RCW and RCW 47.42.060, 99-24-083 (Order 195), § 468-66-050, filed 11/30/99, effective 12/31/99. Statutory Authority: Chapter 47.42 RCW and RCW 47.01.101(5), 94-12-049 (Order 144), § 468-66-050, filed 5/27/94, effective 6/27/94. Statutory Authority: RCW 47.42.060, 88-22-002 (Order 116), § 468-66-050, filed 10/20/88. Statutory Authority: Chapter 47.42 RCW, 85-17-012 (Order 96), § 468-66-050, filed 8/12/85. Statutory Authority: RCW 47.42.060, 80-05-055 (Order 55), § 468-66-050, filed 4/18/80. Statutory Authority: 1977 ex.s. c 151, 79-01-033 (DOT Order 10 and Comm. Order 1, Resolution No. 13), § 468-66-050, filed 12/20/78. Formerly WAC 252-40-040.]

(2001 Ed.)

WAC 468-66-055 National scenic byway demonstration project. Pursuant to the 1991 Intermodal Surface Transportation Efficiency Act, for the purpose of outdoor advertising control effective July 25, 1993, a National Scenic Byway Demonstration project is established on State Route 101, from the Astoria/Megler Bridge to Fowler Street in Raymond and from the junction with State Route 109 near Queets to the junction with State Route 5 near Olympia, with the following restrictions:

(1) No Type 4 or Type 5 signs may be permitted within the limits of this project, except that existing permitted Type 4 or type 5 signs may be maintained.

(2) Signs of Types 1, 2, 3, 7, and 8 may be erected to the extent and manner provided by WAC 468-66-050.

[Statutory Authority: Chapter 47.42 RCW and RCW 47.01.101(5), 94-12-049 (Order 144), § 468-66-055, filed 5/27/94, effective 6/27/94.]

WAC 468-66-060 Signs along scenic, primary, and interstate systems. Signs of Types 4 and 5 shall not be erected or maintained within view of the main-traveled way of the scenic or primary system, except that signs visible from the main-traveled way of the primary system within commercial and industrial areas shall be permitted as provided in WAC 468-66-110. Only signs of Types 1, 2, 3, 4 and 5 shall be erected or maintained within view of the main-traveled way of the interstate system to the extent and in the manner permitted by WAC 468-66-080, 468-66-090, and 468-66-100: *Provided*, That after May 10, 1974, no Type 4 or Type 5 signs shall be maintained within view of the main-traveled way of the interstate system outside of commercial and industrial areas. Signs of Types 7 and 8 may be erected or maintained within view of the primary and scenic highway systems to the extent and manner permitted by WAC 468-66-050.

[Statutory Authority: Chapter 47.42 RCW and RCW 47.01.101(5), 94-12-049 (Order 144), § 468-66-060, filed 5/27/94, effective 6/27/94. Statutory Authority: Chapter 47.42 RCW, 85-17-012 (Order 96), § 468-66-060, filed 8/12/85. Statutory Authority: 1977 ex.s. c 151, 79-01-033 (DOT Order 10 and Comm. Order 1, Resolution No. 13), § 468-66-060, filed 12/20/78. Formerly WAC 252-40-050.]

WAC 468-66-070 On-premise signs (Type 3). (1) Not more than one Type 3 sign visible to traffic proceeding in any one direction on an interstate system, primary system outside an incorporated city or town or commercial or industrial area, or scenic system highway may be permitted more than fifty feet from the advertised activity. The entire sign installation shall be located within the fifty foot distance.

(2) For the purpose of measuring from the "advertised activity" the distance shall be measured from the sign to the nearest portion of that building, storage, or other structure or processing area, which is the most regularly used and essential to the conduct of the activity.

(3) For signs advertising shopping centers, malls and business combinations, the distance from the "advertised activity" may be measured from the nearest portion of a combined parking area for purposes of allowing a single on-premise sign.

(a) In the event that a shopping center, mall or business combination does erect a single on-premise sign as permitted

herein, such sign may identify each of the individual businesses conducted upon the premises, and may include a single display area such as a manually changeable copy panel, reader board or electronically changeable message center for advertising on-premise activities.

(b) Individual business signs in such a center, mall or combination area are not permissible more than fifty feet from the individual activity.

(4) A Type 3 sign permitted more than fifty feet from the advertised activity pursuant to subsection (1) of this section shall not be erected or maintained a greater distance from the advertised activity than one of the following options selected by the owner of the business being advertised:

(a) One hundred fifty feet measured along the edge of the protected highway from the edge of the main entrance to the activity advertised (when applicable);

(b) One hundred fifty feet from any outside wall of the main building of the advertised activity; or

(c) Fifty feet from any outside edge of a regularly used parking lot maintained by and contiguous to the advertised activity.

(5) One Type 3 sign in each direction, not exceeding fifty square feet in area bearing only the name and a directional message, indicating the location of a business, farm, ranch or orchard may be allowed on such premises that were in existence on June 25, 1976, provided that the following conditions exist:

(a) No other Type 3 signs legible from the main traveled lanes of the highway are maintained.

(b) The sign is located on property abutting the highway where ownership or unrestricted lease is contiguous to and includes the advertised activity and not on a strip or parcel of land deemed by the department of transportation to be acquired for the sole purpose of outdoor advertising.

[Statutory Authority: Chapter 34.05 RCW and RCW 47.42.060. 99-24-083 (Order 195), § 468-66-070, filed 11/30/99, effective 12/31/99. Statutory Authority: RCW 47.42.060. 80-05-055 (Order 55), § 468-66-070, filed 4/18/80. Statutory Authority: 1977 ex.s. c 151. 79-01-033 (DOT Order 10 and Comm. Order 1, Resolution No. 13), § 468-66-070, filed 12/20/78. Formerly WAC 252-40-055.]

WAC 468-66-080 Number of signs and spacing requirements along interstate system. No Type 4 or Type 5 signs which are visible from the main-traveled way of the interstate system shall be erected or maintained in any manner inconsistent with the following:

(1) In advance of an intersection of the main-traveled way of the interstate highway and an exit roadway, such signs visible to interstate system traffic approaching such intersection may not be permitted to exceed the following number:

Distance from intersection	Number of signs
0-2 miles	0
2-5 miles	6
More than 5 miles	Average of one sign per mile

The specified distances shall be measured to the nearest point of the intersection of the traveled way of the exit roadway and the main-traveled way of the interstate highway.

[Title 468 WAC—p. 94]

(2) Subject to the other provisions of this section, not more than two such signs may be permitted within any mile distance measured from any point, and no such signs may be permitted to be less than one thousand feet apart.

(3) Such signs may not be permitted adjacent to any interstate highway right of way upon any part of the width of which is constructed an entrance or exit roadway.

(4) Such signs visible to interstate highway traffic which is approaching or has passed an entrance roadway may not be permitted for one thousand feet beyond the furthest point of the intersection between the traveled way of such entrance roadway and the main-traveled way of the interstate highway.

(5) Not more than one such sign advertising activities being conducted as a single enterprise or giving information about a single place may be permitted to be erected or maintained in such manner as to be visible to traffic moving in any one direction on any one interstate highway.

[Statutory Authority: Chapter 47.42 RCW. 96-03-031 (Order 161), § 468-66-080, filed 1/9/96, effective 2/9/96. Statutory Authority: Chapter 47.42 RCW and RCW 47.01.101(5). 94-12-049 (Order 144), § 468-66-080, filed 5/27/94, effective 6/27/94. Statutory Authority: 1977 ex.s. c 151. 79-01-033 (DOT Order 10 and Comm. Order 1, Resolution No. 13), § 468-66-080, filed 12/20/78. Formerly WAC 252-40-070.]

WAC 468-66-090 Preference of applicants for Type 4, Type 5, and Type 8 sites. Applications for available Type 4, Type 5, and Type 8 sign sites, where the number of applications shall exceed the available sites, shall be awarded upon the following preferential basis:

(1) Agencies of the state of Washington in order of their applications.

(2) Counties or incorporated cities in the order of their applications.

(3) Federal agencies in the order of their applications.

(4) All other applicants in the order of their applications, giving preference, however, to the holder of an existing permit for renewal thereof. In the event the department has initiated proceedings for removal of an existing sign situated on a legal site, the department will not accept new applications until such proceedings are concluded. All applications received during the department's normal office hours during the same day shall be construed as having been received simultaneously. In the case of a tie between applicants, and upon notification thereof by the department, the department shall determine by lot which shall receive the permit.

[Statutory Authority: Chapter 47.42 RCW. 92-09-043 (Order 130), § 468-66-090, filed 4/10/92, effective 5/11/92; 85-17-012 (Order 96), § 468-66-090, filed 8/12/85. Statutory Authority: 1977 ex.s. c 151. 79-01-033 (DOT Order 10 and Comm. Order 1, Resolution No. 13), § 468-66-090, filed 12/20/78. Formerly WAC 252-40-080.]

WAC 468-66-100 Advertising copy. (1) A Type 4 sign that displays any trade name which refers to or identifies any service rendered or product sold, used or otherwise handled more than twelve air miles from such sign may not be permitted unless the name of the advertised activity which is within twelve air miles of such sign is displayed as conspicuously as such trade name.

(2) In Type 5 signs, only information about public places operated by federal, state or local governments, natural phenomena, historic sites, areas of natural scenic beauty or natu-

rally suited for outdoor recreation, and places for camping, lodging, eating and vehicle service and repair is deemed to be in the specific interest of the traveled public. For the purposes of the act and these regulations, a trade name is deemed to be information in the specific interest of the traveling public only if it identifies or characterizes such a place or identifies vehicle service, equipment, parts, accessories, fuels, oils or lubricants being offered for sale at such a place. Signs displaying any other trade name may not be permitted under Type 5.

(3) Notwithstanding the provisions of subsection (1) of this section, Type 4 signs which also qualify as Type 5 signs may display trade names in accordance with the provisions of subsection (2) of this section.

(4) A Type 8 sign shall contain the business name, product(s) for sale, and travel direction and distance to the nearest mile from the intersection with the state highway to the business activity. The materials and workmanship in fabricating and installing the signs should have a professional appearance.

[Statutory Authority: Chapter 47.42 RCW, 87-01-055 (Order 107), § 468-66-100, filed 12/16/86; 85-17-012 (Order 96), § 468-66-100, filed 8/12/85. Statutory Authority: 1977 ex.s. c 151, 79-01-033 (DOT Order 10 and Comm. Order 1, Resolution No. 13), § 468-66-100, filed 12/20/78. Formerly WAC 252-40-090.]

WAC 468-66-110 Signs within commercial and industrial areas of primary system. Signs visible from the main-traveled way of the primary system within commercial and industrial areas whose size and spacing are consistent with the customary use of property for the effective display of outdoor advertising as set forth in this section may be erected and maintained: Provided, That nothing in this section shall restrict Type 3 signs located along any portion of the primary system within an incorporated city or town or within any commercial or industrial area.

(1) Size of signs:

(a) The maximum area for any one sign shall be six hundred seventy-two square feet with a maximum height of twenty-five feet and maximum length of fifty feet inclusive of any border and trim but excluding the base or apron, supports and other structural members: Provided, That cut-outs and extensions may add up to twenty percent of additional sign area.

(b) For the purposes of this subsection, double-faced, back-to-back or V-type signs shall be considered as two signs.

(c) Signs which exceed three hundred twenty-five square feet in area may not be double-faced (abutting and facing the same direction).

(2) Spacing of signs:

(a) Signs may not be located in such a manner as to obscure, or otherwise physically interfere with the effectiveness of an official traffic sign, signal, or device, obstruct or physically interfere with the driver's view of approaching, merging, or intersecting traffic.

(b) On limited access highways established pursuant to chapter 47.52 RCW no two sign structures shall be spaced less than one thousand feet apart, and no sign may be located within three thousand feet of the center of an interchange, a

(2001 Ed.)

safety rest area or information center, or within one thousand feet of an intersection at grade. Double-faced signs shall be prohibited. Not more than a total of five sign structures shall be permitted on both sides of the highway per mile.

(c) On noncontrolled access highways inside the boundaries of incorporated cities and towns not more than a total of four sign structures on both sides of the highway within a space of six hundred sixty feet shall be permitted with a minimum of one hundred feet between sign structures. In no event, however shall more than four sign structures be permitted between platted intersecting streets or highways. On noncontrolled access highways outside the boundaries of incorporated cities and towns minimum spacing between sign structures on each side of the highway shall be five hundred feet.

(d) For the purposes of this subsection, a back-to-back sign and a V-type sign shall be considered one sign structure.

(e) Official signs, signs advertising activities conducted on the property on which they are located (Type 2 and Type 3 signs), public service signs on school bus stop shelters (Type 7 signs), and temporary agricultural directional signs (Type 8 signs) shall not be considered in determining compliance with the above spacing requirements. The minimum space between structures shall be measured along the nearest edge of the pavement between points directly opposite the signs along each side of the highway and shall apply to signs located on the same side of the highway.

[Statutory Authority: Chapter 34.05 RCW and RCW 47.42.060, 99-24-083 (Order 195), § 468-66-110, filed 11/30/99, effective 12/31/99. Statutory Authority: Chapter 47.42 RCW, 85-17-012 (Order 96), § 468-66-110, filed 8/12/85. Statutory Authority: 1977 ex.s. c 151, 79-01-033 (DOT Order 10 and Comm. Order 1, Resolution No. 13), § 468-66-110, filed 12/20/78. Formerly WAC 252-40-095.]

WAC 468-66-120 Signs erected prior to June 1, 1971 in commercial and industrial areas along the primary system. Signs lawfully erected and maintained which are visible from the main-traveled way of the primary system within commercial and industrial areas on June 1, 1971 shall be permitted to remain and be maintained. Such signs, however, shall be included in the determination of spacing requirements for additional signs as permitted by WAC 468-66-110.

[Statutory Authority: 1977 ex.s. c 151, 79-01-033 (DOT Order 10 and Comm. Order 1, Resolution No. 13), § 468-66-120, filed 12/20/78. Formerly WAC 252-40-097.]

WAC 468-66-130 Signs to be removed. No sign visible from the main-traveled way of the interstate system, the primary system, or the scenic system which was there lawfully maintained immediately prior to May 10, 1971 but which does not comply with the provisions of the act and these regulations, shall be maintained by any person:

(1) After May 10, 1974; or

(2) With respect to any highway hereafter designated by the legislature as a part of the scenic system, after three years from the effective date of the designation. Signs located in areas zoned by the governing county for predominantly commercial or industrial uses, that do not have development visible to the highway, as determined by the department, and that were lawfully installed after May 10, 1971, visible to any

highway now or hereafter designated by the legislature as part of the scenic system, shall be allowed to be maintained.

[Statutory Authority: Chapter 47.42 RCW and RCW 47.01.101(5), 94-12-049 (Order 144), § 468-66-130, filed 5/27/94, effective 6/27/94. Statutory Authority: 1977 ex.s. c 151, 79-01-033 (DOT Order 10 and Comm. Order 1, Resolution No. 13), § 468-66-130, filed 12/20/78. Formerly WAC 252-40-098.]

WAC 468-66-140 Permits. (1) No signs except Type 1, Type 2, or Type 3 signs shall be erected or maintained adjacent to interstate system, primary system, or scenic system highways without a permit issued by the department of transportation. Permits for erection and maintenance of signs adjacent to the interstate system, primary system, or scenic system will be issued by the department of transportation in accordance with this chapter.

(2) Applications for permits (except for Type 8 signs) will be accepted only at the Department of Transportation Service Center, Olympia, Washington. Applications transmitted by mail shall be effective from date of receipt rather than of mailing.

(3) Application forms shall contain:

(a) The name and address of the owner of the sign;

(b) A statement and the signature of the owner or occupant of the land on which the sign is to be erected or maintained indicating that he has consented thereto;

(c) A statement of the precise location where the sign is to be erected or maintained;

(d) A statement of the proposed size and shape of the sign. An application for a Type 5 sign to be erected along the interstate system shall contain a description of the copy to be placed on the sign;

(e) Such other information as may be required by the department;

(f) For Type 8 signs, application forms accompanied by a fee of fifty dollars for each sign face must be submitted to the appropriate department of transportation region office and submittals must include, in addition to (a) through (e) of this subsection, an exact description of the location of the temporary agricultural business activity, a description of the proposed sign copy, identification of the products sold, expected weeks/months of sales, and assigned tax number. After approval of the application by the transportation district office, the sign may be erected at the beginning of the sale season and must be removed at the end of the sale season. Approved applications shall be valid for five consecutive years from the date of application approval. A new application must be submitted and approved prior to erection of a sign at a location where the five-year validation has expired.

For any Type 8 sign not in compliance with this chapter, the department of transportation shall request the attorney general on its behalf to institute legal proceedings to cause such sign to be removed as an illegal sign without payment of compensation.

Subsections (4) through (8) of this section do not apply to Type 8 signs.

(4) Applications shall be accompanied by a fee of three hundred dollars for each sign structure.

(5) Permits shall be for the remainder of the calendar year in which they are issued, and accompanying fees shall

not be prorated for fractions of the year. Permits are renewed annually through the following certification process:

(a) Prior to January 1 of each year the department of transportation shall request, through the use of a standard form, permit renewal certification from the owner of every sign for which a permit has been issued under RCW 47.42.120 and this section. In order to renew the permit, the sign owner shall certify by signature that all sign permits are active and the signs are currently maintained and in good condition. The completed permit renewal form shall be returned to the department not later than the following February 1. The permit renewal form shall further state that if the required certification has not been received by February 1, legal proceedings will be initiated to cause removal of such sign as an illegally maintained sign.

(b) Following the request for certification specified in (a) of this subsection, if the due certification is not received for any permitted sign by the date specified, the department of transportation shall request the attorney general on its behalf to initiate legal proceedings to cause such sign to be removed as an illegal sign without the payment of compensation therefor.

(6) Changes in size, shape, or position of a permitted sign shall be reported to the department of transportation at Olympia at least ten days before a change is to be made. In the case of Type 5 signs permitted along the interstate system, changes in copy shall be reported to the department at Olympia at least ten days before a change is to be made.

(7) Assignment of permits in good standing shall be effective only upon receipt of assignment by the department of transportation.

(8) Every permit issued by the department shall be assigned a separate identification number, and it shall be the duty of each permittee to fasten to each sign a weatherproof label, not larger than six square inches, which shall be furnished by the department and on which shall be plainly visible the said permit number. The permittee shall also place his name in a conspicuous position on the front or back of each sign.

(9) A permit issued under this chapter does not relieve the permittee from the duty to comply with all local rules, regulations, and ordinances pertaining to signs and sign structures.

[Statutory Authority: Chapter 34.05 RCW and RCW 47.42.060, 99-24-083 (Order 195), § 468-66-140, filed 11/30/99, effective 12/31/99. Statutory Authority: Chapter 47.42 RCW, 92-09-043 (Order 130), § 468-66-140, filed 4/10/92, effective 5/11/92. Statutory Authority: RCW 47.42.060, 88-22-002 (Order 116), § 468-66-140, filed 10/20/88. Statutory Authority: Chapter 47.42 RCW, 87-01-055 (Order 107), § 468-66-140, filed 12/16/86; 85-17-012 (Order 96), § 468-66-140, filed 8/12/85. Statutory Authority: RCW 47.42.060, 80-04-095 (Order 52), § 468-66-140, filed 4/1/80. Statutory Authority: 1977 ex.s. c 151, 79-01-033 (DOT Order 10 and Comm. Order 1, Resolution No. 13), § 468-66-140, filed 12/20/78. Formerly WAC 252-40-100.]

WAC 468-66-150 Penalties. (1) After hearing, as required by chapter 34.04 RCW (Administrative Procedure Act) and the rules and regulations of the department of transportation adopted pursuant thereto, any permit may be revoked without refund by the department for any of the following reasons:

(a) For the making of any false or misleading statements in the application for any permit, whether or not the same is material to or relied upon by the department in the issuance of such permit when such false or misleading statement or information shall remain uncorrected after the expiration of thirty days following written notification thereof.

(b) For allowing or suffering any sign to remain in a condition of disrepair or unreasonable state of repair after the expiration of thirty days following written notification thereof.

(c) For maintaining any sign, for which a permit has been issued, in violation of any provision of the act or these regulations after the expiration of thirty days following written notification thereof.

(d) For any convictions of a violation of the act or any of these regulations, any permit held by the convicted person may be revoked whether or not such violation is related to the sign for which the permit is revoked.

(e) For maintaining a discontinued sign as defined in WAC 468-66-010(6).

(2) Notice whenever required herein shall be given to the person entitled thereto by registered mail at the last known address of such person which shall be such address as may be on file with the department, if any, otherwise the last address of such person shown by the tax records of the county in which the real property upon which the sign in question is maintained.

(3) Computation of time when dependent upon giving of notice shall relate to the day of mailing such notice rather than the day of receipt.

[Statutory Authority: Chapter 47.42 RCW. 97-17-010 (Order 170), § 468-66-150, filed 8/7/97, effective 9/7/97. Statutory Authority: RCW 47.42.060. 86-01-063 (Order 99), § 468-66-150, filed 12/17/85. Statutory Authority: 1977 ex.s. c 151. 79-01-033 (DOT Order 10 and Comm. Order 1, Resolution No. 13), § 468-66-150, filed 12/20/78. Formerly WAC 252-40-110.]

Chapter 468-70 WAC

MOTORIST INFORMATION SIGNS

WAC

468-70-010	General.
468-70-020	Definitions.
468-70-030	Location of panels and signs.
468-70-040	Interchange and intersection selection for motorist information sign panels.
468-70-050	Business eligibility.
468-70-060	Signing details.
468-70-070	Permits and procedure.
468-70-080	Fee schedule.
468-70-085	Maintenance replacement of pictorial business signs manufactured by the department prior to January 1, 1987.

DISPOSITION OF SECTIONS FORMERLY CODIFIED IN THIS CHAPTER

468-70-990	Appendix A—Typical signing for single exit interchange on the interstate system. [Statutory Authority: 1977 ex.s. c 151. 79-01-033 (DOT Order 10 and Comm. Order 1, Resolution No. 13), § 468-70-990, filed 12/20/78. Formerly WAC 252-42-900.] Repealed by 85-17-012 (Order 96), filed 8/12/85. Statutory Authority: Chapter 47.42 RCW.
468-70-99001	Appendix B—Typical signing for double exit interchange on the interstate system. [Statutory Authority: 1977 ex.s. c 151. 79-01-033 (DOT Order 10 and Comm. Order 1, Resolution No. 13), § 468-70-99001, filed 12/20/78. Formerly WAC 252-42-901.] Repealed by

468-70-99002	85-17-012 (Order 96), filed 8/12/85. Statutory Authority: Chapter 47.42 RCW. Appendix C—Typical signing for single exit interchange for a freeway or expressway part of the primary or scenic system. [Statutory Authority: 1977 ex.s. c 151. 79-01-033 (DOT Order 10 and Comm. Order 1, Resolution No. 13), § 468-70-99002, filed 12/20/78. Formerly WAC 252-42-902.] Repealed by 85-17-012 (Order 96), filed 8/12/85. Statutory Authority: Chapter 47.42 RCW.
468-70-99003	Appendix D—Typical signing for double exit interchange and at-grade intersections for a freeway or expressway part of the primary or scenic system. [Statutory Authority: 1977 ex.s. c 151. 79-01-033 (DOT Order 10 and Comm. Order 1, Resolution No. 13), § 468-70-99003, filed 12/20/78. Formerly WAC 252-42-903.] Repealed by 85-17-012 (Order 96), filed 8/12/85. Statutory Authority: Chapter 47.42 RCW.
468-70-99004	Appendix E—Typical signing for at-grade intersection on a conventional highway part of the primary or scenic system. [Statutory Authority: 1977 ex.s. c 151. 79-01-033 (DOT Order 10 and Comm. Order 1, Resolution No. 13), § 468-70-99004, filed 12/20/78. Formerly WAC 252-42-904.] Repealed by 85-17-012 (Order 96), filed 8/12/85. Statutory Authority: Chapter 47.42 RCW.

WAC 468-70-010 General. (1) These rules and regulations implement, and are prescribed by, chapter 47.36 RCW.

(2) The regulations provide for the installation of motorist information signs which will inform the motoring public of tourist services conveniently accessible from interstate and noninterstate highways within the state.

[Statutory Authority: Chapter 34.05 RCW and RCW 47.42.060. 00-01-184 (Order 196), § 468-70-010, filed 12/22/99, effective 1/22/00. Statutory Authority: 1977 ex.s. c 151. 79-01-033 (DOT Order 10 and Comm. Order 1, Resolution No. 13), § 468-70-010, filed 12/20/78. Formerly WAC 252-42-005.]

WAC 468-70-020 Definitions. When used in these regulations the term:

(1) "Conventional road" shall mean a noninterstate highway which is not an expressway or freeway.

(2) "Department" shall mean the Washington state department of transportation.

(3) "Expressway" shall mean a divided arterial highway for through traffic with partial control of access and grade separations at most major intersections.

(4) "Freeway" shall mean an expressway with full control of access, and grade separations over the entire length of the numbered highway route.

(5) "Motorist information signs" shall mean the same as specific service signs as set forth in the Manual on Uniform Traffic Control Devices adopted by the department as chapter 468-95 WAC.

(6) "Motorist service activity" shall mean a business furnishing gas, food, lodging, camping, recreation and tourist-oriented services.

(7) "Owner" shall mean a person who owns or operates a motorist service activity and who has authority to enter into and be bound by agreements relevant to matters covered by these regulations.

(8) "Supplemental directional panel" shall mean a motorist information sign panel located on, opposite, or at the terminus of an exit ramp bearing business sign for a qualified motorist service activity and directional information.

(9) "Trade name" shall mean any brand name, trade mark, distinctive symbol or other similar device or thing used to identify a particular motorist service.

(10) "Urban area" shall mean an area including and adjacent to a municipality or other place of five thousand or more population as shown by the latest available federal census.

(11) "Qualified tourist-oriented business" means any lawful cultural, historical, recreational, educational, or entertaining activity or a unique or unusual commercial or non-profit activity, the major portion of whose income or visitors are derived during its normal business season from motorists not residing in the immediate area of the activity.

(12) "Tourist-oriented directional (TOD) sign" means a sign on a motorist information sign panel on the state highway system to provide directional information to a qualified tourist-oriented business, service, or activity.

[Statutory Authority: Chapter 34.05 RCW and RCW 47.42.060. 00-01-184 (Order 196), § 468-70-020, filed 12/22/99, effective 1/22/00. Statutory Authority: Chapter 47.42 RCW. 86-08-023 (Order 103), § 468-70-020, filed 3/25/86; 85-17-012 (Order 96), § 468-70-020, filed 8/12/85. Statutory Authority: 1977 ex.s. c 151. 79-01-033 (DOT Order 10 and Comm. Order 1, Resolution No. 13), § 468-70-020, filed 12/20/78. Formerly WAC 252-42-010.]

WAC 468-70-030 Location of panels and signs. (1) A maximum of four motorist information sign panels, one per each type of motorist service activity, may be provided on interchange approaches and in advance of intersections. Where a qualified type of motorist service activity is not present, a panel will not be erected. Generally, these panels should be located near the right of way line and readable from the main traveled way. The panels will be erected as follows:

(a) For freeways and interchanges on expressways the panels shall be erected between the previous interchange and at least eight hundred feet in advance of the exit direction sign at the interchange from which the services are available. There shall be at least eight hundred feet spacing between the panels, and there will be one panel each for **gas, food, lodging, camping/recreation, and TOD**, except as provided in (c) of this subsection.

(b) For conventional roads the panels shall be erected between the previous intersection and at least three hundred feet in advance of the intersection from which the services are available, signing should not be provided to any service visible at least three hundred feet along the mainline prior to the intersection or driveway approach serving the business. There will be one panel each for **gas, food, lodging, camping/recreation, and TOD** except as provided in (c) of this subsection.

(c) A combined panel may be installed where there is a limited number of qualifying motorist service activities, or insufficient space available to install the array of **gas, food, lodging, camping/recreation, and TOD's** panels as set forth in WAC 468-70-040(2). Not more than two types of motorist service activities may be combined on one mainline back panel; however, supplemental directional panels located along interchange ramps to direct motorists to the right or to the left may display more than two types of motorist service activities. The permissible number of business signs that may

be displayed per type of motorist service activity shall be as set forth in WAC 468-70-060 (3)(a).

(2) Information for motorist information sign panels on the mainline of expressways/freeways will be repeated on the supplemental directional panels located along the interchange ramp, or at the ramp terminal, where the services are not visible from the ramp. Supplemental directional panels may be used only to repeat messages installed on the mainline.

(3) The spacing between motorist information sign panels, and between motorist information sign panels and other official traffic control signs shall be in accordance with the *Manual on Uniform Traffic Control Devices*. Where there is insufficient spacing for both other official traffic control signs and motorist information sign panels, the other official traffic control signs only shall be installed.

[Statutory Authority: Chapter 34.05 RCW and RCW 47.42.060. 00-01-184 (Order 196), § 468-70-030, filed 12/22/99, effective 1/22/00. Statutory Authority: Chapter 47.42 RCW and RCW 47.01.101. 91-17-012 (Order 129), § 468-70-030, filed 8/13/91, effective 9/13/91. Statutory Authority: Chapter 47.42 RCW. 86-08-023 (Order 103), § 468-70-030, filed 3/25/86; 85-17-012 (Order 96), § 468-70-030, filed 8/12/85. Statutory Authority: 1977 ex.s. c 151. 79-01-033 (DOT Order 10 and Comm. Order 1, Resolution No. 13), § 468-70-030, filed 12/20/78. Formerly WAC 252-42-020.]

WAC 468-70-040 Interchange and intersection selection for motorist information sign panels. (1) On an *interstate or noninterstate highway* the interchange or intersection must:

(a) For interchanges, consist of both an exit and entrance ramp. However, where there is no entrance ramp, the department may determine that another entrance ramp may qualify for motorist information sign panels, provided that it is conveniently located, to permit a motorist to proceed without the use of indirect or poor connecting roads.

(b) For intersections, provide a reasonable and convenient route, in the determination of the department, to permit a motorist to proceed without the use of indirect or poor connecting roads.

(2) Motorist information sign panels may be erected at locations outside the corporate limits of cities and towns and areas zoned for commercial and industrial uses, and at locations within the corporate limits of cities and towns and areas zoned for commercial and industrial uses, where there is sufficient distance between interchanges or intersections to erect the signs in accordance with WAC 468-70-030 (1)(a) and (b). Where there is insufficient space available to install an array of four of the **gas, food, lodging, camping/recreation and TOD's** panels, the number of panels allowable are normally provided in that order of priority, or as combined panels in accordance with WAC 468-70-030 (1)(c), except that regional administrators may negotiate a revised priority at interchange/intersection locations with local officials. If there is no business interest in signing for any one activity at a location, and space allows, the next lower priority activity can be signed.

(3) Signing will be provided from the nearest interchange or intersection from the nearest freeway/expressway or conventional highway to the activity. Signing will not be provided from a freeway or expressway to another freeway or expressway.

[Statutory Authority: Chapter 34.05 RCW and RCW 47.42.060. 00-01-184 (Order 196), § 468-70-040, filed 12/22/99, effective 1/22/00. Statutory Authority: Chapter 47.42 RCW. 86-08-023 (Order 103), § 468-70-040, filed 3/25/86; 85-17-012 (Order 96), § 468-70-040, filed 8/12/85. Statutory Authority: 1977 ex.s. c 151. 79-01-033 (DOT Order 10 and Comm. Order 1, Resolution No. 13), § 468-70-040, filed 12/20/78. Formerly WAC 252-42-030.]

WAC 468-70-050 Business eligibility. (1) To be eligible for placement of a business sign on a motorist information sign panel a motorist service activity must conform to the following standards:

(a) Gas activity:

(i) Provide vehicle services including fuel, oil, tire repair and water; and

(ii) Be in continuous operation at least sixteen hours a day, seven days a week; and

(iii) Provide restroom facilities, drinking water and a telephone access;

(iv) Motorist information sign panels may be installed and existing signing will not be removed when the motorist service activity is closed for a short period of time or when its hours of operation have been reduced as a result of a shortage of gasoline;

(v) Activities not meeting the tire repair requirement of (i) of this subsection but have gas, oil, and water may qualify for signing provided that the motorist information sign panel displays fewer than the full complement of business signs. A telephone must also be available at no cost for a person to use to acquire tire repair;

(vi) Business signs for card-lock gas activities may be installed, provided that the activities serve the general motoring public, without membership, and accept a variety of credit cards available to the general public. Card-lock gas activities must also meet the applicable requirements of (a)(i) through (v) of this subsection.

(b) Food activity:

(i) Be licensed or approved by the county health office; and

(ii) Be in continuous operation for a minimum of twelve hours a day to serve meals six days a week; and

(iii) Have inside seating for a minimum of twenty patrons and parking facilities for a minimum of ten vehicles; and

(iv) Provide telephone and restroom facilities.

(c) Lodging activity:

(i) Be licensed or approved by the Washington department of health; and

(ii) Provide adequate sleeping and bathroom accommodations available without reservations for rental on a daily basis; and

(iii) Provide public telephone facilities.

(d) Camping activity (applicable only for activities available from interstate highways):

(i) Have a valid business license;

(ii) Consist of at least twenty camping spaces, at least fifty percent of which will accommodate tents, and have adequate parking, modern sanitary and drinking water facilities for such spaces; and

(iii) Have an attendant on duty to manage and maintain the facility twenty-four hours a day while in operation.

(e) Recreation activity (applicable only for activities available from noninterstate highways):

(i) Consist of activities and sports of interest to family groups and the public generally in which people participate for purposes of active physical exercise, collective amusement or enjoyment of nature; e.g., hiking, golfing, skiing, boating, swimming, picnicking, camping, fishing, tennis, horseback riding, ice skating and gun clubs; and

(ii) Be licensed or approved by the state or local agency regulating the particular type of business; and

(iii) When the recreational activity is a campground, it must meet the criteria specified in WAC 468-70-050 (1)(d)(i) thru (iii).

(f) Tourist-oriented business activity:

(i) A natural, recreational, historical, cultural, educational, or entertainment activity, or a unique or unusual commercial or nonprofit activity, the major portion of whose income or visitors are derived during its normal business seasons from motorists not residing in the immediate area of the activity.

(ii) Activities must be open to the motoring public without appointment, at least eight hours a day, five days a week including Saturday and/or Sunday.

(2) Distances prescribed herein will be measured from the center of the interchange or intersection along the centerline of the most direct public road to the facility access.

(3) The maximum distance that **gas, food, lodging, camping, recreational, or tourist-oriented** activities can be located on either side of an interchange or intersection to qualify for a business sign shall be as follows:

(a) From an interstate highway, **gas, food and lodging** activities shall be located within three miles in either direction. **Camping or tourist-oriented** activities shall be located within five miles in either direction;

(b) From a noninterstate highway, **gas, food, lodging, recreation, or tourist-oriented** activities shall be located within five miles in either direction.

(c) Where there are fewer than the maximum number, as specified in WAC 468-70-060 (3)(a), of eligible services within the distance limits prescribed in subsection (3)(a) and (b) of this section, the distance limits may be increased up to a maximum of fifteen miles to complete the balance of allowable signs.

(i) In reference to WAC 468-70-040(3), the department may erect and maintain signs on an alternate route that is longer than fifteen miles if it is safer and still provides reasonable and convenient travel to an eligible activity.

(ii) The department may erect and maintain signs on a route up to a maximum of twenty miles if an activity qualifies as eligible and is located within a distressed area under the criteria set forth in chapter 43.165 RCW.

(4) Within cities and towns having a population greater than twenty-two thousand five hundred, the department shall obtain concurrence from the municipality of locations for installing panels, and may request that the municipality install the panels.

(5) A **gas, food, lodging, camping/recreational, or tourist-oriented** activity visible from the mainline at least three hundred feet prior to an intersection shall not qualify for

a business sign on such highway. The activity's on-premise sign is considered part of that activity in determining the three hundred foot visibility.

(6) When a multiple business activity qualifies for business sign placement on more than one type of motorist information sign panel, placement will be made on that type of panel which, as determined by the department, best describes the main product or service. Additional business signs for a qualifying multiple business activity may only be placed on more than one type of motorist information sign panel where the applicable panels display fewer than a full complement of business signs. Where these additional business signs complete the full complement of business signs on a motorist information sign panel, the most recently installed of such additional business signs shall be substituted for in the event that a qualifying single business activity applies to receive business signs.

(7) Motorist information sign panels will not be erected and maintained by the department until adequate follow-through signing, as specified by the department, is erected on local roads and/or streets. Written assurance that the follow-through signs will be maintained is required.

(8) Where operations are seasonal, business signs for each specific location shall be removed or covered during the appropriate period as determined by the department.

[Statutory Authority: Chapter 34.05 RCW and RCW 47.42.060. 00-01-184 (Order 196), § 468-70-050, filed 12/22/99, effective 1/22/00. Statutory Authority: Chapter 47.42 RCW and RCW 47.01.101. 91-17-012 (Order 129), § 468-70-050, filed 8/13/91, effective 9/13/91. Statutory Authority: Chapter 47.42 RCW. 87-01-054 (Order 106), § 468-70-050, filed 12/16/86; 85-17-012 (Order 96), § 468-70-050, filed 8/12/85. Statutory Authority: RCW 47.42.060. 85-03-031 (Order 94), § 468-70-050, filed 1/10/85. Statutory Authority: 1977 ex.s. c 151. 79-01-033 (DOT Order 10 and Comm. Order 1, Resolution No. 13), § 468-70-050, filed 12/20/78. Formerly WAC 252-42-040.]

WAC 468-70-060 Signing details. (1) Specifications. All motorist information sign panels, supplemental directional panels, and business signs shall be constructed in accordance with the Washington state standard specifications, standard plans and amendments thereto. All business signs shall be constructed of a single piece of 0.063 inch thick aluminum. All panels and business signs shall be fully reflectorized to show the same shape and color both by day and night.

(2) Color of panels and signs:

(a) The background color for **gas, food, lodging, camping** and **TOD** motorist information sign panels and supplemental directional panels shall be blue. The background color for **recreation** motorist information sign panels and supplemental directional panels shall be brown. The border and lettering on all such signs shall be white.

(b) The background color and letter color for business signs manufactured by the department shall be standard highway sign sheeting and inks which are available in white (silver), blue, black, yellow, red, orange, green, and brown. A description of business signs which the department will manufacture is provided in WAC 468-70-070 (8)(b).

(3) Composition of motorist information sign panels:

(a) For interchanges, the maximum number of business signs which may be displayed on a motorist information sign

panel are six for each **gas, food, lodging, camping/recreation, and TOD's** panel. For intersections, each panel is limited to four business signs. For combined motorist information sign panels on the mainline, the minimum number of business signs which may be displayed is two for each type of motorist service activity. For supplemental directional panels located along interchange ramps, there is no minimum number of business signs which may be displayed for each type of motorist service activity.

(b) Sign panel fabrication layouts, and business sign sizes, are provided in the Appendices of the Motorist Information Signs Booklet published by the Washington state department of transportation.

(i) The panel size shall be sufficient to accommodate the various sizes of business signs and directional information.

(ii) For qualifying businesses located more than one mile from an intersection the business sign shall show the mileage to the business to the nearest mile. For interchanges the mileage will be shown on the supplemental directional panel business signs installed along the interchange ramp or at the ramp terminal.

[Statutory Authority: Chapter 34.05 RCW and RCW 47.42.060. 00-01-184 (Order 196), § 468-70-060, filed 12/22/99, effective 1/22/00. Statutory Authority: Chapter 47.42 RCW and RCW 47.01.101. 91-17-012 (Order 129), § 468-70-060, filed 8/13/91, effective 9/13/91. Statutory Authority: Chapter 47.42 RCW. 87-01-054 (Order 106), § 468-70-060, filed 12/16/86; 86-08-023 (Order 103), § 468-70-060, filed 3/25/86; 85-17-012 (Order 96), § 468-70-060, filed 8/12/85. Statutory Authority: RCW 47.42.060. 85-03-031 (Order 94), § 468-70-060, filed 1/10/85. Statutory Authority: 1977 ex.s. c 151. 79-01-033 (DOT Order 10 and Comm. Order 1, Resolution No. 13), § 468-70-060, filed 12/20/78. Formerly WAC 252-42-050.]

WAC 468-70-070 Permits and procedure. (1) No business signs will be installed on motorist information sign panels prior to issuance of a permit by the department. Permits will be issued by the department in accordance with this chapter.

(2) Permit applications will be accepted at the appropriate department of transportation regional office in care of the regional administrator. Applications transmitted by mail shall be effective from date of receipt rather than of mailing.

(3) One permit application will be for all the signing that the applicant will qualify for at a single interchange or intersection.

(4) Application forms, which may be obtained from the department, shall contain the following information:

(a) Name and address of the owner of the business to be advertised.

(b) The highway for which the applicant seeks signing.

(c) A description of the interchange or intersection for which the business sign is to be installed.

(d) A statement of the business location including exact travel distance from the interchange or intersection and precise roads used for access.

(e) An agreement to limit the height of any on-premise sign to no greater than fifteen feet higher than the roof of the main building, measured to the bottom of the sign for businesses located within one mile of an interchange or intersection. (Not applicable along interstate highways if the sign is not visible to the highway.)

Pursuant to RCW 47.36.310, for on-premise signs visible along rural interstate highways the department may waive the fifteen-foot height requirement, on a case-by-case basis, where granting the waiver will not preclude another business having an on-premise sign which complies with the fifteen-foot height requirement from receiving business signs.

(f) Such other information as may be required by the department.

(5) Each permit application will include a sketch, drawing or picture of the message to be placed on the business signs. Business signs may not display messages advertising products or services incidental to the qualifying motorist service activity. The department shall have final approval of the design of the business sign and may modify such submissions to achieve uniformity.

(6) A nonrefundable application processing fee as prescribed in WAC 468-70-080 (1)(a) will accompany each application. Such fee may only be refunded if, after approval, the activity is not signed for reasons caused by the department.

(7) Any party aggrieved by an application determination of the department shall be accorded hearing rights before the secretary of transportation or his designee pursuant to chapter 34.05 RCW.

(8) Fabrication and installation of business signs:

(a) Once an application is approved, the department will request the business to provide the signs for installation. Such signs shall be built to the department's specifications prescribed by WAC 468-70-060. Prior to installation the business shall be billed and pay for the installation cost prescribed in WAC 468-70-080 (1)(b).

(b) When requested by a business, the department will manufacture business signs composed of standard solid color background with standard die cut or silk screened highway sign letters used for messages. The department does not manufacture business signs having nonstandard colors, nonstandard letters, or pictorial business symbols or trademarks. The manufacturing and installation fees for business signs manufactured by the department are prescribed in WAC 468-70-080 (2)(a) or (b), and shall be prepaid prior to manufacture and installation.

(9) Business sign and motorist information sign panel maintenance and replacement:

(a) For a business which provides its own business signs to the department, an annual permit fee of fifty dollars shall be charged. (Effective January 1, 2001, this annual permit fee will no longer be charged by the department.)

Maintenance replacement business signs shall be provided by the business, when requested by the department to replace weather worn business signs. The department will install the replacement business sign after prepayment for the installation fees as prescribed in WAC 468-70-080 (1)(b).

(b) For business signs manufactured by the department, the department will notify businesses when business signs need replacement because of weather wear and will manufacture and install such replacement business signs after prepayment for the manufacturing and installation fees prescribed in WAC 468-70-080 (2)(a) or (b).

(c) The annual maintenance replacement fee charged to each business for motorist information sign panels is prescribed in WAC 468-70-080(3).

(d) Annual maintenance fees shall be paid within thirty calendar days after the anniversary of the permit issue. These fees will not be prorated for fractions of the year in the event of business sign removal or coverage. Failure to pay the annual maintenance fees within thirty calendar days after the anniversary of the permit issue will cause the permit to expire and the business signs to be removed from the motorist information sign panels.

(10) In the event of change of ownership or operation, assignment of permits in good standing shall be effective only upon receipt of assignment by the department. The department will not reassign permits in the event of change of both ownership and operation.

(11) Revocation and expiration:

(a) After hearing before the secretary of transportation or his designee, as required by chapter 34.05 RCW (Administrative Procedure Act) and the rules and regulations of the department adopted pursuant thereto, any permit may be revoked by the secretary or the secretary's designee who has conducted the hearing for any of the following reasons:

(i) For the making of any false or misleading statements in the application for any permit, whether or not the same is material to or relied upon by the department in the issuance of such permit when such false or misleading statement or information shall remain uncorrected after the expiration of thirty days following written notification thereof.

(ii) For allowing or suffering any on-premise sign to remain that exceeds the height requirements set forth in this chapter.

(iii) For failure to provide the services and/or facilities required by WAC 468-70-050 and this section.

(b) If a permit is revoked or is allowed to expire, a new application may be accepted by the department and the motorist service activity must meet the requirements of any other applying motorist service activity.

[Statutory Authority: Chapter 34.05 RCW and RCW 47.42.060. 00-01-184 (Order 196), § 468-70-070, filed 12/22/99, effective 1/22/00. Statutory Authority: RCW 47.36.030. 95-23-098 (Order 153), § 468-70-070, filed 11/21/95, effective 1/1/96. Statutory Authority: Chapter 47.42 RCW and RCW 47.01.101. 91-17-012 (Order 129), § 468-70-070, filed 8/13/91, effective 9/13/91. Statutory Authority: RCW 47.42.046 and 47.42.047. 88-22-001 (Order 115), § 468-70-070, filed 10/20/88. Statutory Authority: Chapter 47.42 RCW. 87-01-054 (Order 106), § 468-70-070, filed 12/16/86; 85-17-012 (Order 96), § 468-70-070, filed 8/12/85. Statutory Authority: 1977 ex.s. c 151. 79-01-033 (DOT Order 10 and Comm. Order 1, Resolution No. 13), § 468-70-070, filed 12/20/78. Formerly WAC 252-42-060.]

WAC 468-70-080 Fee schedule. (1) The application processing fee, and installation fee for each business sign provided by the business to the department for new installations and replacement installations because of weather wear are:

(a)	Application processing fee	\$150.00
(b)	Installation fee for each business sign	\$115.00
(2)	Manufacturing and installation charge for department manufactured business signs.	

- (a) Interstate and noninterstate freeways and expressways.
 - (i) GAS, FOOD, LODGING, CAMPING/RECREATION, or TOD-lettered business sign to be installed on a motorist information sign panel \$230.00
 - (ii) GAS, FOOD, LODGING, CAMPING/RECREATION, or TOD-lettered business sign, without mileage message, to be installed on a supplemental directional panel \$130.00
 - (iii) GAS, FOOD, LODGING, CAMPING/RECREATION, or TOD-lettered business sign, with mileage message, to be installed on a supplemental directional panel \$135.00
- (b) Noninterstate highways that are conventional roads.
 - (i) GAS, FOOD, LODGING, RECREATION, or TOD-lettered business sign, without mileage message, to be installed on a motorist information sign panel \$150.00
 - (ii) GAS, FOOD, LODGING, RECREATION, or TOD-lettered business sign, with mileage message, to be installed on a motorist information sign panel \$160.00
- (3) The annual maintenance fee charged to each business for motorist information sign panels is:
 - (a) Businesses signed at interchanges \$100.00
 - (b) Businesses signed at intersections \$ 35.00

(4) The implementation date of WAC 468-70-080(3) is January 1, 2001.

[Statutory Authority: Chapter 34.05 RCW and RCW 47.42.060. 00-01-184 (Order 196), § 468-70-080, filed 12/22/99, effective 1/22/00. Statutory Authority: Chapter 47.42 RCW. 87-01-054 (Order 106), § 468-70-080, filed 12/16/86; 85-17-012 (Order 96), § 468-70-080, filed 8/12/85. Statutory Authority: RCW 47.42.060. 85-03-031 (Order 94), § 468-70-080, filed 1/10/85. Statutory Authority: 1977 ex.s. c 151. 79-01-033 (DOT Order 10 and Comm. Order 1, Resolution No. 13), § 468-70-080, filed 12/20/78. Formerly WAC 252-42-070.]

WAC 468-70-085 Maintenance replacement of pictorial business signs manufactured by the department prior to January 1, 1987. (1) For business signs composed of nonstandard colors, nonstandard letters, or pictorial symbols or trademarks which were manufactured by the department prior to January 1, 1987, the department will manufacture and install only the first maintenance replacement of these signs that is required after January 1, 1987. Up to the time of replacement, the annual maintenance fee charged for each business sign shall be:

- (a) Interstate and noninterstate freeways and expressways.
 - (i) "GAS, FOOD, LODGING, CAMPING/RECREATION, or TOD" pictorial business sign on a motorist information sign panel \$95.00
 - (ii) "GAS, FOOD, LODGING, CAMPING/RECREATION, or TOD" pictorial business sign on a supplemental direction panel \$30.00

- (b) Noninterstate highways that are conventional roads: "GAS, FOOD, LODGING, RECREATION, or TOD" pictorial business sign on a motorist information sign panel \$50.00

After this one maintenance replacement by the department, the business owner will be responsible for subsequent business sign maintenance replacement and the annual motorist information sign panel fees maintenance as prescribed in WAC 468-70-070(9).

(2) Businesses utilizing business signs composed of nonstandard colors, nonstandard letters, or pictorial symbols or trademarks which were manufactured by the department prior to January 1, 1987, may choose to provide their own maintenance replacement business signs in accordance with the procedures in WAC 468-70-070(9) in lieu of the procedures described in subsection (1) of this section. The department shall notify each business of this choice by certified mail. The businesses shall be provided thirty days to respond. If no response is received, the annual maintenance fee procedure will continue; however, the business may choose, in writing at a later date, to stop paying the maintenance fee and provide their own replacement business signs. The department will not refund previously paid maintenance fees to businesses choosing the option of providing their own replacement business signs.

[Statutory Authority: Chapter 34.05 RCW and RCW 47.42.060. 00-01-184 (Order 196), § 468-70-085, filed 12/22/99, effective 1/22/00. Statutory Authority: Chapter 47.42 RCW. 87-01-054 (Order 106), § 468-70-085, filed 12/16/86.]

**Chapter 468-72 WAC
ADOPT-A-HIGHWAY LITTER CONTROL
PROGRAM**

WAC	
468-72-010	Purpose.
468-72-050	Eligibility criteria.

WAC 468-72-010 Purpose. The purpose of these regulations is to assist in the administration of the adopt-a-highway program pursuant to chapter 47.40 RCW.

[Statutory Authority: Chapter 34.05 RCW. 90-22-003, § 468-72-010, filed 10/25/90, effective 11/25/90.]

WAC 468-72-050 Eligibility criteria. (1) Organizations, businesses, and individuals are eligible to participate in the adopt-a-highway program, either as volunteers or through sponsorship of private contracts, provided there is a section of highway available, in the opinion of the department of transportation, that the section can be safely assigned.

(2) An organization, business, or individual is not eligible if its name (a) endorses or opposes a particular candidate for public office, (b) advocates a position on a specific political issue, initiative, referendum, or piece of legislation, (c) includes a reference to a political party, or (d) includes a reference to anything that may be considered or construed to be obscene or offensive to the general public.

(3) Organizations, businesses, individuals, or contractors that have been denied participation due to lack of compliance to a previous adopt-a-highway agreement shall not be eligible

to participate for a period of five years following the termination date of the previous agreement.

[Statutory Authority: RCW 47.01.101. 98-24-023 (Order 184), § 468-72-050, filed 11/23/98, effective 12/24/98. Statutory Authority: Chapter 34.05 RCW. 90-22-003, § 468-72-050, filed 10/25/90, effective 11/25/90.]

Chapter 468-74 WAC

JUNKYARDS ADJACENT TO HIGHWAYS

WAC

468-74-010 Definition of "unzoned industrial areas."

WAC 468-74-010 Definition of "unzoned industrial areas." In the administration of chapter 47.41 RCW, relating to the regulation and control of junkyards adjacent to highways, the term "unzoned industrial areas" shall be interpreted to mean those areas not zoned by county or municipal code, occupied by three or more separate and distinct industrial activities within a space of five hundred feet and the area within five hundred feet of such activities on both sides of the highway. The area shall be measured from the outer edges of the regularly used buildings, parking lots, storage or processing areas of the industrial activity and not from the property lines of the parcels upon which such activities are located. Measurements shall be along or parallel to the edge of the main traveled way of the highway. The following shall not be considered industrial activities:

- (1) Agricultural, forestry, grazing, farming and related activities, including, but not limited to, wayside fresh produce stands;
- (2) Transient or temporary activities;
- (3) Railroad tracks and minor sidings;
- (4) Signs;
- (5) Activities more than three hundred feet from the nearest edge of the right of way;
- (6) Activities conducted in a building principally used as a residence;
- (7) Activities not visible from the traffic lanes of the main traveled way;
- (8) Junkyards, as defined in section 136, Title 23, United States Code.

[Statutory Authority: 1977 ex.s. c 151. 79-01-033 (DOT Order 10 and Comm. Order 1, Resolution No. 13), § 468-74-010, filed 12/20/78. Formerly WAC 252-44-010.]

Chapter 468-85 WAC

REGULATIONS REGARDING ADVANCED FINANCIAL SUPPORT PAYMENTS FOR THE DEVELOPMENT OF COMPREHENSIVE TRANSIT PLANS

WAC

468-85-010 General purpose and applicability.
 468-85-015 Definitions.
 468-85-110 Application for advanced financial support payment.
 468-85-120 Department response to application.
 468-85-130 Conditions of advanced financial support payments.
 468-85-200 Required elements of comprehensive transit plan.
 468-85-210 Community context.
 468-85-220 Level of service element.
 468-85-230 Capital improvements element.
 468-85-240 Funding for annual operations element.
 468-85-250 Citizen participation element.
 468-85-290 Coordinated planning element.

(2001 Ed.)

468-85-300
 468-85-310

Submission of comprehensive transit plans to agency.
 Review of comprehensive transit plan of public transportation benefit area.

DISPOSITION OF SECTIONS FORMERLY CODIFIED IN THIS CHAPTER

468-85-260 Prospects for geographic expansion of service area element. [Statutory Authority: RCW 36.57A.150. 80-01-029 (Order 42), § 468-85-260, filed 12/17/79.] Repealed by 98-11-046 (Order 176), filed 5/18/98, effective 6/18/98. Statutory Authority: RCW 36.57A.150.
 468-85-270 Minorities, elderly, handicapped and low-income persons transportation service element. [Statutory Authority: RCW 36.57A.150. 80-01-029 (Order 42), § 468-85-270, filed 12/17/79.] Repealed by 98-11-046 (Order 176), filed 5/18/98, effective 6/18/98. Statutory Authority: RCW 36.57A.150.
 468-85-280 Citizen participation element. [Statutory Authority: RCW 36.57A.150. 80-01-029 (Order 42), § 468-85-280, filed 12/17/79.] Repealed by 98-11-046 (Order 176), filed 5/18/98, effective 6/18/98. Statutory Authority: RCW 36.57A.150.

WAC 468-85-010 General purpose and applicability.

(1) Purpose: These regulations are to assist county transportation authorities and public transportation benefit areas in the development of comprehensive transit plans consistent with chapter 36.57A RCW, RCW 35.58.2795, and local developmental goals. The comprehensive transit plans are intended to lead to the development and management of regional public transit systems which are energy-efficient, provide viable transportation alternatives, serve all elements of the public, and are responsive to the public need.

(2) Applicability: These regulations apply only to county transportation authorities created pursuant to chapter 36.57 RCW and to public transportation benefit areas created pursuant to chapter 36.57A RCW.

[Statutory Authority: RCW 36.57A.150. 98-11-046 (Order 176), § 468-85-010, filed 5/18/98, effective 6/18/98; 80-01-029 (Order 42), § 468-85-010, filed 12/17/79.]

WAC 468-85-015 Definitions. (1) "Department" means the Washington state department of transportation, through its public transportation and rail division, or its successor.

(2) "Comprehensive transit plan" means the official document required of every county transportation authority pursuant to RCW 36.57.070 and of every public transportation benefit area pursuant to RCW 36.57A.060.

(3) "County transportation authority" means an entity created pursuant to chapter 36.57 RCW.

(4) "Population" means the number of residents as shown by the most recent population determination made by the office of financial management.

(5) "Public transportation benefit area" means an entity created pursuant to chapter 36.57A RCW.

[Statutory Authority: RCW 36.57A.150. 98-11-046 (Order 176), § 468-85-015, filed 5/18/98, effective 6/18/98; 80-01-029 (Order 42), § 468-85-015, filed 12/17/79.]

WAC 468-85-110 Application for advanced financial support payment. (1) Eligible applicants: Any county transportation authority established pursuant to chapter 36.57 RCW and any public transportation benefit area established pursuant to chapter 36.57A RCW may receive a one-time advanced financial support payment from the department

after submitting an application containing the information specified in subsection (2) of this section to the department.

(2) Contents of application: There is no particular form specified for applying for an advanced financial support payment. The application for such payment must be addressed to the department, signed by the chief executive officer of the applicant, and include the following information and related materials:

(a) A copy of a minute entry or resolution of the applicant authorizing or directing that body, or a designated individual acting for that body, to apply for such payment;

(b) In the event the applicant is a public transportation benefit area, and unless it is county-wide, a map indicating the precise boundaries of any unincorporated areas within the public transportation benefit area;

(c) A description of the methods anticipated to be used to secure citizen participation in the comprehensive transit planning process; such methods must ensure a reasonable opportunity is provided for input to be made by racial and ethnic minorities, low-income, elderly individuals, and persons with disabilities.

[Statutory Authority: RCW 36.57A.150, 98-11-046 (Order 176), § 468-85-110, filed 5/18/98, effective 6/18/98; 80-01-029 (Order 42), § 468-85-110, filed 12/17/79.]

WAC 468-85-120 Department response to application. The department shall respond to applications on a "first-come, first-served" basis. Therefore, upon receipt of an application for an advanced financial support payment, the department shall:

(1) Determination of completeness: Determine whether or not the application contains or includes all of the information or material required by WAC 468-85-110(2). In the event an application is incomplete, the department shall notify the applicant within seven days of receipt of such application by the department, of the application's deficiencies and that further processing of the application is being suspended until the applicant corrects the deficiencies;

(2) Determination of population: Request the office of financial management to determine the population of the applicant. Where the sum of the populations of the incorporated areas within the applicant's jurisdiction exceeds fifty thousand people, or if the applicant's jurisdiction is county-wide according to the most recently published estimate of the office of financial management, the department will not make such request; and

(3) Allocation of funds: Allocate for distribution to the applicant as an advanced financial support payment the product of one dollar times the applicant's population as determined by the office of financial management or the department. Under no circumstances will the amount allocated exceed the sum of fifty thousand dollars per applicant.

[Statutory Authority: RCW 36.57A.150, 98-11-046 (Order 176), § 468-85-120, filed 5/18/98, effective 6/18/98; 80-01-029 (Order 42), § 468-85-120, filed 12/17/79.]

WAC 468-85-130 Conditions of advanced financial support payments. (1) Payment constitutes a loan: Funds received by county transportation authorities or public transportation benefit areas as advanced financial support pay-

ments constitute loans. The recipient shall repay the department such loan not later than two years after the date such recipient received the advanced financial support payment. The department shall waive such repayment if the voters in the recipient's area fail to authorize taxes permitted under chapters 35.95 or 82.14 RCW within two years after the date such advanced financial support payment was received.

(2) Obligation to develop a comprehensive transit plan: Following receipt of the advanced financial support payment, the county transportation authority or public transportation benefit area shall undertake and complete the development of a comprehensive transit plan that meets the specifications contained in WAC 468-85-200 through 468-85-290. In the development of such plan, the recipient shall ensure a reasonable opportunity for the receipt of citizens input and participation in the planning process is provided to racial and ethnic minorities; low-income, elderly individuals and persons with disabilities.

(3) Payment may constitute matching contribution: Any payment received pursuant to this chapter may be used as all or any portion of a matching contribution required for the receipt of federal funds, provided federal law and applicable regulations allow such payment as a matching contribution, and provided, further, such federal funds are used to assist the recipient in the development of a comprehensive transit plan.

(4) Notice of election: The chief executive officer of a recipient of an advanced financial support payment or his/her designee shall inform the department of the date chosen for a popular election on taxation authorized by chapter 35.95 or 82.14 RCW to finance public transportation in the recipient's jurisdiction, in advance of such election(s).

(5) Required election: An election to determine the taxes authorized by chapter 35.95 or 82.14 RCW proposed to be levied and collected in the county or public transportation benefit area must be held within two years of the receipt of an advanced financial support payment.

(6) Notice of election results: The chief executive officer of a recipient of an advanced financial support payment or his/her designee shall inform the department of the election results within ten days of its official certification.

[Statutory Authority: RCW 36.57A.150, 98-11-046 (Order 176), § 468-85-130, filed 5/18/98, effective 6/18/98; 80-01-029 (Order 42), § 468-85-130, filed 12/17/79.]

WAC 468-85-200 Required elements of comprehensive transit plan. A comprehensive transit plan prepared pursuant to RCW 36.57.070, 36.57A.060 and WAC 468-85-130(2) shall contain the elements described in WAC 468-85-210 through 468-85-290.

[Statutory Authority: RCW 36.57A.150, 80-01-029 (Order 42), § 468-85-200, filed 12/17/79.]

WAC 468-85-210 Community context. The comprehensive plan shall describe the community context of the public transit services. This context shall include:

- (1) Demographics according to the most recent census:
 - (a) Distribution of persons aged sixty-five years and older;
 - (b) Distribution of persons aged six to eighteen years;
 - (c) Location of concentrations of any ethnic minorities;

- (d) Location of concentrations of low-income households; and
- (e) Automobile ownership by household;
- (2) Location of significant destinations, including:
 - (a) Employment centers with more than fifty employees;
 - (b) Schools, colleges and universities;
 - (c) Shopping centers with five or more shopping opportunities;
 - (d) Medical clinics and hospitals;
 - (e) Public parks;
 - (f) City halls;
 - (g) County courthouses;
 - (h) Airports with scheduled air passenger service; and
 - (i) Passenger rail stations;
- (3) Public transportation operations within the boundaries of and three miles beyond the transit district, including:
 - (a) Intercity bus carriers;
 - (b) Rail passenger service;
 - (c) Municipally operated public transit service;
 - (d) School pupil transportation; and
 - (e) Specialized transportation for elderly or low-income persons, and persons with disabilities;
- (4) An explanation of how the proposed public transit service will serve destinations contained in subsection (2) of this section and integrate with elements contained in subsection (3) of this section;
- (5) A discussion of future annexations to the public transportation benefit area.

[Statutory Authority: RCW 36.57A.150. 98-11-046 (Order 176), § 468-85-210, filed 5/18/98, effective 6/18/98; 80-01-029 (Order 42), § 468-85-210, filed 12/17/79.]

WAC 468-85-220 Level of service element. The comprehensive transit plan shall contain the following information:

- (1) Where scheduled service is anticipated in the plan, the frequency that in-revenue-service vehicles would pass selected points along proposed routes; and
- (2) The days and hours of service operations;
- (3) Annual revenue vehicle hours and annual vehicle hours of service separated by type of service;
- (4) Annual revenue vehicle miles and annual vehicle miles of service separated by type of service.

[Statutory Authority: RCW 36.57A.150. 98-11-046 (Order 176), § 468-85-220, filed 5/18/98, effective 6/18/98; 80-01-029 (Order 42), § 468-85-220, filed 12/17/79.]

WAC 468-85-230 Capital improvements element. The comprehensive transit plan shall identify anticipated capital improvements. Estimate the annual costs of purchasing the following items during each of the first six years of operation, identifying costs for each of the following categories:

- (1) Vehicles - number to be purchased according to passenger seating capacity;
- (2) Equipment such as shelters, benches, and signing - number of each to be purchased;
- (3) Parking facilities and stations/terminals - number of each to be purchased or constructed; and
- (4) Garage and vehicle maintenance, operations and administrative structures, including associated equipment -

(2001 Ed.)

number of each to be purchased or constructed. *Sites* for the fixed facilities in this subsection or subsection (3) of this section need not be identified.

[Statutory Authority: RCW 36.57A.150. 98-11-046 (Order 176), § 468-85-230, filed 5/18/98, effective 6/18/98; 80-01-029 (Order 42), § 468-85-230, filed 12/17/79.]

WAC 468-85-240 Funding for annual operations element. The comprehensive transit plan shall include, but need not be limited to, the following information:

(1) An estimate of the annual costs of operating the recommended public transit system during each of the first six years of operation; such estimate shall include costs for marketing, administration, maintenance and operations.

(2) Passenger fare levels, estimated ridership, and estimated fare box revenue;

(3) The amounts and sources of federal and state assistance separated by operations and capital purposes;

(4) The amount of long term debt for the purchase of facilities and equipment;

(5) Whether any of the following sources of local public transit subsidy are anticipated to assist in the funding of the proposed system:

(a) Household tax authorized by chapter 35.95 RCW;

(b) Business and occupation tax authorized by chapter 35.95 RCW; or

(c) The .1%, .2%, .3%, .4%, .5%, or .6% sales and use tax in lieu of the household tax and business and occupation tax referenced immediately above; together with the rate(s) for any levied tax identified above and the estimated revenues from any such sources anticipated to be collected; (Assumptions made in order to estimate such revenues should be identified.)

(6) The amount of any state matching funds assumed. (Such amount shall equal the sum of either one state dollar for each local dollar anticipated to be collected, as identified in WAC 468-85-230(5), or the amount of the motor vehicle excise tax mass transit levy authorized under RCW 35.58.272 through 35.58.279, whichever is less; minus the amount advanced by the department to a county transportation authority or public transportation benefit area for the development of a comprehensive transit plan pursuant to this chapter.)

[Statutory Authority: RCW 36.57A.150. 98-11-046 (Order 176), § 468-85-240, filed 5/18/98, effective 6/18/98; 80-01-029 (Order 42), § 468-85-240, filed 12/17/79.]

WAC 468-85-250 Citizen participation element. The comprehensive transit plan citizen participation element shall identify how citizens shall be consulted by the county transportation authority or public transportation benefit area. County transportation authorities and public transportation benefit areas shall ensure that they receive citizens' input on a continuing basis.

[Statutory Authority: RCW 36.57A.150. 98-11-046 (Order 176), § 468-85-250, filed 5/18/98, effective 6/18/98; 80-01-029 (Order 42), § 468-85-250, filed 12/17/79.]

WAC 468-85-290 Coordinated planning element. The comprehensive transit plan coordinated planning ele-

ment shall contain comments on the comprehensive transit plan's compatibility with the adopted goals, objectives and policies for transportation by: Every unit of general purpose local government that is located within the county transportation authority or public transportation benefit area; the regional transportation planning organization that is located in whole or in part within the jurisdiction of that transit service planning entity; and the Washington state department of transportation.

[Statutory Authority: RCW 36.57A.150. 98-11-046 (Order 176), § 468-85-290, filed 5/18/98, effective 6/18/98; 80-01-029 (Order 42), § 468-85-290, filed 12/17/79.]

WAC 468-85-300 Submission of comprehensive transit plans to agency. A county transportation authority or public transportation benefit area shall assemble into a single written document all of the elements prepared by it pursuant to WAC 468-85-200 and transmit such document to the department.

[Statutory Authority: RCW 36.57A.150. 80-01-029 (Order 42), § 468-85-300, filed 12/17/79.]

WAC 468-85-310 Review of comprehensive transit plan of public transportation benefit area. (1) Within sixty days of the receipt thereof, the department shall review any comprehensive transit plan submitted by a public transportation benefit area. The department shall determine whether or not such comprehensive transit plan can be "approved" on the basis of the following standards:

(a) The capital improvement program and anticipated upgrading costs are offset by the proposed system funding;

(b) The comprehensive transit plan as submitted contains all of the elements required by WAC 468-85-200.

(2) In the event such plan is approved, the department shall certify to the state treasurer that a public transportation benefit area that submitted a reviewed and approved plan is eligible to receive the motor vehicle excise tax proceeds authorized pursuant to RCW 35.58.273, as now or hereafter amended, in the manner prescribed by chapter 82.44 RCW, as now or hereafter amended.

(3) The county transportation authority or public transportation benefit area shall supply a copy of the comprehensive transit plan and any updated portions thereof shall be supplied within thirty days of the official adoption thereof to the chief executives of every unit of general purpose local government located in whole or in part within the jurisdiction of that planning entity; every regional transportation planning organization, and engineering or public works department of any unit of general purpose local government, located in whole or in part within the jurisdiction of that planning entity; the department; and the regional administrator and public transportation and rail division director of the department.

(4) In the event a comprehensive transit plan is disapproved and a public transportation benefit area is determined to be ineligible to receive such motor vehicle tax proceeds, the department shall provide written notice to such entity within thirty days as to the reasons for the plan disapproval and the entity's ineligibility, together with notice that such public transportation benefit area may resubmit a corrected plan at any time.

[Title 468 WAC—p. 106]

[Statutory Authority: RCW 36.57A.150. 98-11-046 (Order 176), § 468-85-310, filed 5/18/98, effective 6/18/98; 80-01-029 (Order 42), § 468-85-310, filed 12/17/79.]

Chapter 468-86 WAC

RTPO PLANNING STANDARDS AND GUIDELINES

WAC

PART ONE PURPOSE/AUTHORITY

468-86-010 Authority.
468-86-020 Purpose/intent.

PART TWO GENERAL REQUIREMENTS

468-86-030 Definitions.
468-86-040 Determining the region.
468-86-050 Establishing the organization.
468-86-060 Relationship to MPOs.
468-86-070 Designation procedures.

PART THREE REGIONAL TRANSPORTATION PLAN

468-86-080 Least-cost planning methodology.
468-86-090 Regional transportation goals and objectives.
468-86-100 Regional transportation strategy.
468-86-110 Needs, deficiencies, data requirements, and coordinated regional transportation and land use assumptions.
468-86-120 Financial component.
468-86-130 Proposed future transportation network.
468-86-140 High capacity transit and public transportation interrelationships.

PART FOUR CERTIFICATION

468-86-150 Certification.

PART FIVE TRANSPORTATION IMPROVEMENT PROGRAM

468-86-160 Regional transportation improvement program.

PART ONE PURPOSE/AUTHORITY

WAC 468-86-010 Authority. The regional transportation planning program was authorized by the 1990 legislature as part of the state's Growth Management Act. The program is contained in chapter 47.80 RCW, with funding appropriations made as part of the Department of Transportation Appropriations Act.

[Statutory Authority: RCW 47.80.070 and SHB 1928, Section 5. 97-09-046 (Order 169), § 468-86-010, filed 4/15/97, effective 5/16/97.]

WAC 468-86-020 Purpose/intent. (1) The regional transportation planning program creates a formal mechanism for local governments and the state to coordinate transportation planning for regional transportation facilities. The act authorized the creation of regional transportation planning organizations (RTPO) by local governments to coordinate transportation planning among jurisdictions and develop a regional transportation plan. The regional transportation planning program is available to all counties and cities statewide (RCW 47.80.020).

(2) The legislature has authorized a grant program to fund this work. The department has the authority to administer this grant program, and to develop in cooperation with the RTPOs:

(a) Minimum planning standards for the development of a regional transportation plan;

(b) The RTPO regional transportation improvement program;

(c) Planning guidelines and principles;

(d) Certification standards for the transportation portion of local comprehensive plans and county-wide planning policies;

(e) The adoption of LOS standards on state transportation facilities; and

(f) RTPO regional transportation strategies.

(3) The purpose of the minimum planning standards is to guide RTPOs in the use of the regional transportation planning grants, and in the development of planning products under the program. Work proposed by each regional transportation planning organization shall be included in a work program that demonstrates adherence to the planning standards within this chapter. The intent of the department is to provide guidance that is sufficient to ensure a minimum level of consistency across the state, while providing flexibility for regions to meet specific mobility needs.

(4) The department will achieve this purpose through the establishment of these rules and through the cooperative development and maintenance of a set of RTPO planning standards and guidelines. Copies of these standards and guidelines will be available through the department's transportation planning office.

[Statutory Authority: RCW 47.80.070 and SHB 1928, Section 5. 97-09-046 (Order 169), § 468-86-020, filed 4/15/97, effective 5/16/97.]

PART TWO GENERAL REQUIREMENTS

WAC 468-86-030 Definitions. "Consistency" means that no feature of a plan or regulation is incompatible with any other feature of a plan or regulation. Consistency is indicative of a capacity for orderly integration or operation with other elements in a system.

"Department" means the department of transportation (WSDOT).

"Least cost planning" means a process of comparing direct and indirect costs of demand and supply options to meet transportation goals and/or policies where the intent of the process is to identify the most cost-effective mix of options.

"Level of service" means an established minimum capacity for both transit and regional arterials that must be provided per unit of demand or other appropriate measure of need.

"Organization" means regional transportation planning organization (RTPO).

"Region" means the area that includes the local jurisdictions that comprise the regional transportation planning organization.

"Urbanized area" means those areas designated as such by the U.S. Bureau of the Census.

"Urban growth areas" means those areas designated by a county pursuant to RCW 36.70A.110.

[Statutory Authority: RCW 47.80.070 and SHB 1928, Section 5. 97-09-046 (Order 169), § 468-86-030, filed 4/15/97, effective 5/16/97.]

(2001 Ed.)

WAC 468-86-040 Determining the region. Local governments should decide the geographic extent and composition of their region. The region should reflect common transportation concerns and a willingness among the local governments to work together in a cooperative planning process.

[Statutory Authority: RCW 47.80.070 and SHB 1928, Section 5. 97-09-046 (Order 169), § 468-86-040, filed 4/15/97, effective 5/16/97.]

WAC 468-86-050 Establishing the organization. (1) A regional transportation planning organization is a voluntary association of local governments within the region. It shall be a formal organization formed through an interlocal agreement that establishes the organization, defines duties and relationships, and includes a transportation policy board. The establishment of a technical advisory committee (TAC) is recommended. The RTPO must determine its own structure to ensure equitable and acceptable representation by member governments. Regions are encouraged to seek native American tribal involvement.

[Statutory Authority: RCW 47.80.070 and SHB 1928, Section 5. 97-09-046 (Order 169), § 468-86-050, filed 4/15/97, effective 5/16/97.]

WAC 468-86-060 Relationship to MPOs. The federal government requires a regional transportation planning process in urbanized areas with over fifty thousand population. This process is carried out by metropolitan planning organizations (MPOs) that have been jointly designated by local governments and the state. The intent is that the regional transportation planning program be integrated with the metropolitan planning organization program in these urbanized areas. RCW 47.80.020 requires that RTPOs shall be the same organization as that designated as the MPO. The regional transportation planning program provides the opportunity for transportation planning in rural areas within the RTPO. The department intends to jointly administer these two programs.

[Statutory Authority: RCW 47.80.070 and SHB 1928, Section 5. 97-09-046 (Order 169), § 468-86-060, filed 4/15/97, effective 5/16/97.]

WAC 468-86-070 Designation procedures. (1) Local governments desiring participation in the regional transportation planning program must submit an RTPO designation package to WSDOT. This information is necessary for WSDOT to verify that the RTPO meets the requirements of RCW 47.80.020. This package shall contain the following items:

- (a) A description of the region;
- (b) A formal designation of the RTPO, in the form of a resolution or other legal declaration;
- (c) A list of all RTPO member local governments;
- (d) A copy of the interlocal agreement that will govern RTPO operations;
- (e) A formal designation by the RTPO of the lead planning agency; and
- (f) A description of the RTPO's transportation policy board.

(2) WSDOT has the responsibility of verifying that RTPOs designated by local governments meet the state requirements. The most recent annual OFM population data will be used to verify population figures. WSDOT will review the RTPO designation package, make a finding of

verification, and concur with or deny the local designation. Once verified, the RTPO may proceed in carrying out its duties and may receive regional transportation planning formula grants. If significant changes are made in the structure of the RTPO, WSDOT may request that another designation package be submitted for verification review.

[Statutory Authority: RCW 47.80.070 and SHB 1928, Section 5. 97-09-046 (Order 169), § 468-86-070, filed 4/15/97, effective 5/16/97.]

PART THREE REGIONAL TRANSPORTATION PLAN

WAC 468-86-080 Least-cost planning methodology.

The methodology shall consider direct and indirect costs and benefits for all reasonable options to meet planning goals and objectives. The methodology shall treat demand and supply resources on a consistent and integrated basis. The regional transportation planning organizations shall consult the guidelines set forth by the department for implementing a least-cost planning methodology. Regional transportation plans should incrementally incorporate least-cost planning methodologies as these concepts are developed. The regional transportation plan adopted after July 1, 2000, shall be based on a least-cost planning methodology appropriate to the region.

[Statutory Authority: RCW 47.80.070 and SHB 1928, Section 5. 97-09-046 (Order 169), § 468-86-080, filed 4/15/97, effective 5/16/97.]

WAC 468-86-090 Regional transportation goals and objectives. The regional transportation planning program is meant to foster an ongoing transportation planning and decision-making process that actively plans for the improvement of regional transportation systems and coordinates this process among jurisdictions. The goals and objectives of the regional transportation plan should incorporate existing transportation related county-wide planning policies or multicounty transportation related planning policies where adopted and adhere to the following principles:

(1) Build upon applicable portions of the existing local comprehensive plan and process and promote the establishment of a regional perspective into the local comprehensive plan;

(2) Encourage partnerships between federal, state, local and tribal governments, special districts, the private sector, the general public, and other interest groups during conception, technical analysis, policy development, and decision processes in developing, updating, and maintaining the regional transportation plan;

(3) Ensure early and continuous public involvement from conceptual planning through decision making;

(4) Shall be ongoing, and incorporate short and long range multimodal planning activities to address major capacity expansion and operational improvements to the regional transportation system;

(5) Use regionally coordinated, valid and consistent technical methods and data should be used in identifying and analyzing needs;

(6) Consider environmental impacts related to the development of regional transportation policies and facilities and;

(7) Address the policies regarding the coordination of transportation planning among regional jurisdictions, includ-

ing the relationship between regional transportation planning, local comprehensive planning and state transportation planning.

Within these principles, regions shall develop their own ongoing planning process for the development and refinement of the regional transportation plan, and provide a forum for the discussion of regional transportation planning issues.

[Statutory Authority: RCW 47.80.070 and SHB 1928, Section 5. 97-09-046 (Order 169), § 468-86-090, filed 4/15/97, effective 5/16/97.]

WAC 468-86-100 Regional transportation strategy.

Each regional transportation planning organization shall develop a regional transportation strategy. The strategy should identify alternative transportation modes within the region and recommend policies to:

(1) Address each transportation mode;

(2) Address intermodal connections between modes; and

(3) Address transportation demand management where required.

The regional transportation strategy is intended to guide development of the regional transportation plan and any periodic updates.

Adopted multicounty and county-wide planning policies and policies from local comprehensive plans that are regional in scope and regionally consistent should provide the basis for the regional transportation strategy. The regional transportation strategy should be periodically reviewed and updated as necessary to reflect changing priorities or to maintain regional consistency.

[Statutory Authority: RCW 47.80.070 and SHB 1928, Section 5. 97-09-046 (Order 169), § 468-86-100, filed 4/15/97, effective 5/16/97.]

WAC 468-86-110 Needs, deficiencies, data requirements, and coordinated regional transportation and land use assumptions. (1) The following components shall be developed and incorporated in the RTP:

(a) An inventory of existing regional transportation facilities and services, including physical, operational, and usage characteristics of the regional transportation system;

(b) An evaluation of current facilities and services, comparing current usage, and operational characteristics to level of service standards, and identification of regional transportation needs;

(c) Forecasts of future travel demand, based on the regional transportation strategy and local comprehensive plans;

(d) Identification of future regional transportation system deficiencies, comparing future travel needs for movement of people and goods to available facilities and services; and

(e) Coordinated common regional assumptions (growth, population, employment, mode split, etc.) among local jurisdictions for the development of all transportation models to ensure consistency within the RTPO, and:

(i) These common regional assumptions shall recognize the planning requirements of the state's Growth Management Act, and;

(ii) Be consistent with population forecasts prepared by the office of financial management.

(2) **Performance monitoring.** An integral part of the regional transportation plan is monitoring the performance of the regional transportation system over time. This information is necessary to determine the success of plan implementation and the effect of the desired improvements on the performance of the regional transportation system. Each RTPO shall describe their performance monitoring system in the regional transportation plan. The performance monitoring measures shall include traffic volumes and vehicle miles of travel (VMT) at a minimum and can include, but are not limited to, travel time, speed, safety standards and other measures. Performance monitoring measures should be coordinated and measurable on a consistent basis throughout the RTPO.

(3) **Regional development patterns and investments.** The regional transportation plan shall include a general assessment of regional development patterns and investments. This analysis is intended to provide direction and background information for updates of the regional transportation plan. The RTP updates shall be based upon a general retrospective discussion of current land use and transportation patterns and their relationship to the region's goals and objectives and elsewhere in the regional transportation plan. Current and projected development patterns and the expected magnitudes and time frame in which these developments are expected to occur should be reviewed and evaluated against the regional growth and transportation strategies. If the regional growth and transportation strategies have changed or current and projected development can be shown to be inconsistent, the plan should be updated to reflect these changes, or development policies should be updated to assure consistency and continuity of transportation and land use issues within the region. The region's interrelationships between growth and transportation should be discussed along with strategies such as access control, development of heritage corridors, and other measures designed to maintain current and proposed development patterns consistent with the regional transportation plan and the transportation and land use elements of local comprehensive plans.

[Statutory Authority: RCW 47.80.070 and SHB 1928, Section 5. 97-09-046 (Order 169), § 468-86-110, filed 4/15/97, effective 5/16/97.]

WAC 468-86-120 Financial component. The financial component shall include the following:

(1) An analysis of funding capacity including an inventory of revenue sources for regional transportation improvements, and probable funding levels available for regional transportation improvements from each source;

(2) Probable funding comparisons with identified current and future needs, including identified funding shortfalls; and

(3) If funding shortfalls are identified, an analysis of additional funding resources to make up the shortfall, or a reassessment of the regional transportation strategies, at a minimum, to ensure that transportation needs fall within probable funding levels.

[Statutory Authority: RCW 47.80.070 and SHB 1928, Section 5. 97-09-046 (Order 169), § 468-86-120, filed 4/15/97, effective 5/16/97.]

(2001 Ed.)

WAC 468-86-130 Proposed future transportation network. Based upon the identified needs and probable funding levels within the region, the proposed future transportation network defines specific facility or service improvements, transportation system management strategies, and demand management strategies proposed for implementation on the regional transportation system. The plan shall identify priority levels for these improvements to guide local jurisdictions and the state in implementation and development of the regional transportation improvement program.

[Statutory Authority: RCW 47.80.070 and SHB 1928, Section 5. 97-09-046 (Order 169), § 468-86-130, filed 4/15/97, effective 5/16/97.]

WAC 468-86-140 High capacity transit and public transportation interrelationships. Within those RTPOs where there is an existing or proposed high capacity transit system, the regional transportation plan shall discuss the relationship between the high capacity transit system and conventional public transit system. This could include policies to maintain coordinated arrivals and departures of interconnecting routes, coordination with other multimodal transportation centers, and other strategies targeted at improving these intermodal relationships over time.

[Statutory Authority: RCW 47.80.070 and SHB 1928, Section 5. 97-09-046 (Order 169), § 468-86-140, filed 4/15/97, effective 5/16/97.]

PART FOUR CERTIFICATION

WAC 468-86-150 Certification. (1) By December 31, 1996, each RTPO shall certify, that the transportation element of all comprehensive plans for cities and counties planning under the Growth Management Act:

(a) Reflect the transportation guidelines and principles established in the regional transportation plan;

(b) Are consistent with the adopted regional transportation plan; and

(c) Conform with the requirements of RCW 36.70A.070.

(2) Each RTPO shall also certify that county-wide planning policies adopted under RCW 36.70A.210 and the adopted regional transportation plan are consistent.

(3) Regions shall cooperatively define and establish measures and processes to determine regional consistency with the adopted regional transportation plan.

[Statutory Authority: RCW 47.80.070 and SHB 1928, Section 5. 97-09-046 (Order 169), § 468-86-150, filed 4/15/97, effective 5/16/97.]

PART FIVE TRANSPORTATION IMPROVEMENT PROGRAM

WAC 468-86-160 Regional transportation improvement program. (1) Each RTPO shall compile a regional transportation improvement program (TIP) at least once every two years. The regional TIP shall:

(a) Be developed on a cooperative basis by local government agencies, public transit agencies, and the department of transportation within each region;

(b) Consist of a list of regionally significant transportation projects and programs including projects proposed for

[Title 468 WAC—p. 109]

construction and transportation demand management measures proposed to be implemented during each year for the next six-year period;

(c) Consist of regionally significant projects included in the local six-year transit development plans and six-year comprehensive transportation programs required by RCW 35.58.2795, 35.77.010, and 36.81.121 for transit agencies, cities, towns, and counties;

(d) Include all proposed WSDOT projects in the region;

(e) Include only projects consistent with the regional transportation plan;

(f) Include a financial section outlining:

(i) Sources of funding reasonably expected to be received for each year of the ensuing three-year period; and

(ii) All assumptions and explanations supporting the expected levels of funding consistent with information included in the financial component of the regional transportation plan.

(2) The six-year regional TIP developed by each RTPO is intended for use as a planning document and shall be available at the lead planning agency office of the RTPO.

[Statutory Authority: RCW 47.80.070 and SHB 1928, Section 5. 97-09-046 (Order 169), § 468-86-160, filed 4/15/97, effective 5/16/97.]

Chapter 468-95 WAC

MANUAL ON UNIFORM TRAFFIC CONTROL DEVICES FOR STREETS AND HIGHWAYS

WAC

468-95-010	General.
468-95-020	Parking for the disabled in urban areas.
468-95-025	Signing to regional shopping centers.
468-95-030	No passing zone markings.
468-95-035	Pavement edgelines and raised pavement markers supplementing other markings.
468-95-037	Stop line locations.
468-95-040	Meaning of signal indications.
468-95-050	Meaning of lane-use control indications.
468-95-055	"MUTCD Part VI."
468-95-060	When children are present.
468-95-070	Meaning of signal indications.
468-95-080	Functions.
468-95-090	County road signing.
468-95-100	Compliance dates.

DISPOSITION OF SECTIONS FORMERLY CODIFIED IN THIS CHAPTER

Amendments	to <i>Uniform Traffic Control Devices for Streets and Highways</i> 1978 edition (MUTCD). [Statutory Authority: RCW 47.36.030. 81-07-047 (Order 59), chapter 468-95 WAC, filed 3/16/81. Statutory Authority: Chapter 47.36 RCW. 80-04-045 (Order 51), chapter 468-95 WAC, filed 3/21/80. Statutory Authority: 1977 ex.s. c 151. 79-01-033 (DOT Order 10 and Comm. Order 1, Resolution No. 13), Amends MUTCD, Volumes I through VIII, filed 12/20/78. Formerly chapter 252-990 WAC.] Amendments to MUTCD were repealed by 85-01-056 (Order 93), filed 12/17/84. Statutory Authority: RCW 47.36.030. Later promulgation of amendments to MUTCD (1978 edition), see Revision No. 2, WAC 468-95-010 through 468-95-090, as filed in 85-01-056 (Order 93).
------------	--

WAC 468-95-010 General. The *Manual on Uniform Traffic Control Devices for Streets and Highways* (MUTCD), 1988 edition, and future revisions approved by the Federal Highway Administrator, except as modified by the department of transportation herein, as the national standard for all

highways open to public travel, published by the U.S. Department of Transportation, Federal Highway Administration, was duly adopted by Administrative Order No. of the Secretary of Transportation dated The manual includes in part many illustrations, some of which depend on color for proper interpretation. The code reviser has deemed it inexpedient to convert these regulations and illustrations to the prescribed form and style of WAC and therefore excludes them from publication. Copies of the MUTCD may be obtained from the Superintendent of Documents, U.S. Government Printing Office, Washington, D.C. 20402. The document is available for public inspection at the headquarters office and all district offices of the Washington state department of transportation. Further, each city, town, and county engineering office in the state will have a copy of the MUTCD with revisions in its possession.

[Statutory Authority: Chapter 34.05 RCW and RCW 47.36.030. 91-02-008 (Order 127), § 468-95-010, filed 12/21/90, effective 1/21/91. Statutory Authority: RCW 47.36.030. 87-05-043 (Order 108), § 468-95-010, filed 2/18/87; 85-23-041 (Order 98), § 468-95-010, filed 11/18/85; 85-01-056 (Order 93), § 468-95-010, filed 12/17/84.]

WAC 468-95-020 Parking for the disabled in urban areas. Pursuant to RCW 46.61.581 the following modifications to the MUTCD are established:

(1) A paragraph is added to MUTCD Section 2B-31, Urban Parking and Stopping Signs (R7 series). "A parking space or stall for a physically disabled person shall be indicated by a vertical sign with the international symbol of access, whose colors are white on a blue background, described under RCW 70.92.120 and the notice 'State Disabled Parking Permit Required.'"

(2) A paragraph is added to MUTCD Section 2B-32, Placement of Urban Parking Signs. "Signs indicating a parking space or stall for a physically disabled person shall be installed between thirty-six and eighty-four inches off the ground."

[Statutory Authority: RCW 46.61.581. 88-22-003 (Order 117), § 468-95-020, filed 10/20/88. Statutory Authority: RCW 47.36.030. 85-01-056 (Order 93), § 468-95-020, filed 12/17/84.]

WAC 468-95-025 Signing to regional shopping centers. Pursuant to section 1, chapter 469, Laws of 1987, a regional shopping center may be signed as a guide sign destination from state highways in accordance with the applicable sections of MUTCD Part II-D, Guide Signs - Conventional Roads, Part II-E, Guide Signs - Expressways, and Part II-F, Guide Signs - Freeways, and in accordance with subsections (1) through (8) of this section.

(1) There shall be at least five hundred thousand square feet of leasable retail floor space;

(2) There shall be at least three major department stores owned by national or regional retail chain organizations;

(3) The center shall be located within one highway mile of the state highway;

(4) The center shall generate at least nine thousand daily one-way vehicle trips to the center;

(5) Sufficient sign space shall be available for installation as specified in the MUTCD;

(6) Supplemental follow-through directional signing is required on county roads or city streets at key motorist decision points if the center is not clearly visible from the point of exit from the state highway and shall be installed by the city or county prior to installation of signs on the state highway;

(7) Signing on the state highway to a county road or city street that bears the name of the regional shopping center fulfills the statutory requirements for signing to those centers. Signing to shopping centers not having such signing shall be supplementary guide signs that are post mounted on the roadside;

(8) The costs of materials and labor for fabricating, installing, and maintaining regional shopping center signs shall be borne by the center.

[Statutory Authority: Chapter 47.36 RCW and 1987 c 469, 87-19-065 (Order 110), § 468-95-025, filed 9/16/87.]

WAC 468-95-030 No passing zone markings. The first paragraph of MUTCD Section 3B-3, is amended to read as follows:

Where center lines are installed, no-passing zone markings shall be established at vertical curves on two- and three-lane highways where an engineering study indicates passing must be prohibited because of inadequate sight distances or other special conditions.

Effective December 31, 1982, where center lines are installed, no-passing zone markings shall be established at horizontal curves on two- and three-lane highways where an engineering study indicates passing must be prohibited because of inadequate sight distances or other special conditions except: Along highway sections of almost continuous horizontal curvatures such as in mountainous terrain no-passing zone markings shall not be established at horizontal curves. Such highway sections would otherwise require almost continuous no-passing zone markings which could restrict motorists from exercising judgment that it is safe to pass a slow moving vehicle and still be in compliance with chapter 46.61 RCW.

[Statutory Authority: RCW 47.36.030, 85-01-056 (Order 93), § 468-95-030, filed 12/17/84.]

WAC 468-95-035 Pavement edgelines and raised pavement markers supplementing other markings. Pursuant to RCW 47.36.280, the second paragraph of MUTCD Section 3B-6 is revised as follows:

Edge lines shall be used on all interstate highways, on rural multilane divided highways, on all principal arterials and minor arterials within urbanized areas, except when curb or sidewalk exists, and may be used on other classes of roads. Jurisdictions shall conform to these requirements at such time that it undertakes to renew or install permanent markings on new or existing roadways. The lines shall be white except that on the left edge of each roadway of divided streets and highways and one-way roadway in the direction of travel, they shall be yellow.

These standards shall be in effect, as provided in this section, unless the legislative authority of the local governmental body finds that special circumstances exist affecting vehicle and pedestrian safety that warrant a site-specific variance to the standard.

(2001 Ed.)

Pursuant to RCW 47.36.280, the second paragraph of MUTCD Section 3B-15 is revised as follows:

Raised pavement markers may also be used to supplement other markings for channelizing islands or approaches to other objects. The general use of raised pavement markers along right edge lines is strongly discouraged because they can cause steering difficulties and make bicyclists lose control of their vehicles. Raised or recessed pavement markers may be used along right edge lines on the taper in lane transition sections, on approaches to objects and within channelization at intersections. Raised or recessed pavement markers can only be used along right edge lines at other locations where an engineering study has determined the markers are essential to preserving pedestrian, bicycle and motor vehicle safety. At the initiation of the engineering study local bicycling organizations, the regional member of the state bicycling advisory committee, and the WSDOT bicycle and pedestrian program manager shall be notified of the study for review and comment. Positioning and spacing of the markers in such cases must be determined by engineering judgment taking into consideration their effect on bicycle, pedestrian, and motor vehicle safety. Other applications of raised or recessed pavement markers along right edge lines of arterials are considered to be nonconforming to this section. Cities and counties shall remove nonconforming raised pavement markings at the time that they prepare to resurface roadways, or earlier at their option.

These standards shall be in effect, as provided in this section, unless the legislative authority of the local governmental body finds that special circumstances exist affecting vehicle and pedestrian safety that warrant a site-specific variance to the standard.

[Statutory Authority: Chapter 34.05 RCW and RCW 47.36.030, 93-17-018 (Order 137), § 468-95-035, filed 8/10/93, effective 9/10/93.]

WAC 468-95-037 Stop line locations. The third paragraph of MUTCD Section 3B-17 is revised as follows:

Stop lines, where used, should ordinarily be placed four feet in advance of and parallel to the nearest crosswalk line. In the absence of a marked crosswalk, the stop line should be placed at the desired stopping point, in no case less than four feet from the nearest edge of the intersecting roadway.

[Statutory Authority: Chapter 34.05 RCW and RCW 47.36.030, 93-17-018 (Order 137), § 468-95-037, filed 8/10/93, effective 9/10/93.]

WAC 468-95-040 Meaning of signal indications. Pursuant to RCW 46.61.055, the first sentence of paragraph 3, Item (c), of MUTCD Section 4B-5, is amended to read as follows:

Except when a sign is in place prohibiting a turn, vehicular traffic facing any steady red signal may cautiously enter the intersection to turn right, or to turn left from a one-way or two-way street into a one-way street, after stopping as required by (a) and (b) above.

[Statutory Authority: RCW 47.36.030, 85-01-056 (Order 93), § 468-95-040, filed 12/17/84.]

WAC 468-95-050 Meaning of lane-use control indications. Pursuant to RCW 46.61.072, paragraph 2 of MUTCD Section 4E-9, is amended to read as follows:

A steady **yellow X** or a flashing **red X** means that a driver should prepare to vacate, in a safe manner, the lane over which the signal is located because a lane control change is being made, and to avoid occupying that lane when a steady **red X** is displayed.

[Statutory Authority: RCW 47.36.030, 85-01-056 (Order 93), § 468-95-050, filed 12/17/84.]

WAC 468-95-055 "MUTCD Part VI." Certain portions of the 1988 Edition of the *MUTCD, Revision 3, Part VI, Standards and Guides for Traffic Controls for Street and Highway Construction, Maintenance, Utility, and Incident Management Operations*, published September 3, 1993, by the Federal Highway Administration, are amended herein.

(1) In Section 6F-1, Signs, the seventh paragraph from the section's beginning is revised to read as follows:

Guidelines for height and lateral clearance of temporary post-mounted roadside signs are shown in figure VI-5. Signs erected at the side of the road should be mounted at a height of at least 7 feet in urban areas and 5 feet in rural areas, measured from the bottom of the sign to the near edge of the pavement. The height to the bottom of a secondary sign mounted below another sign may be 1 foot less than the appropriate height specified above.

(2) Figure VI-5, Height and Lateral Location of Signs - Typical Installation.

The seven foot minimum mounting height in the illustration for a rural district is revised to a five foot minimum; and, the six foot minimum mounting height in the illustration for a rural district with advisory speed plate is revised to a four foot minimum.

(3) Table VI-3, Suggested Advance Warning Sign Spacing, in Subsections 6F-1 and 6H-3 is replaced by the following:

SIGN SPACING (1)		
Freeways & Expressways	55/65 MPH	1500' ± Or as per MUTCD
Rural Roads	45/55 MPH	500' ±
Rural Roads & Urban Arterials	35/40 MPH	350' ±
Rural Roads, Urban Streets, Residential & Business Districts	25/30 MPH	200' ± (2)

- (1) All spacings may be adjusted to accommodate interchange ramps, at-grade intersections, and driveways.
- (2) This spacing may be reduced in urban areas to fit roadway conditions.

(4) Subsection 6F-1 (b)(6), ROAD (STREET) WORK Sign (W20-1), is revised to read as follows:

The ROAD (STREET) WORK sign should be located ahead of the work space or detour, to serve as a general warning of obstructions or restrictions. It carries the

legend ROAD (STREET) WORK (1,500) FT or ROAD (STREET) WORK (1/2) MILE. It may be used in conjunction with appropriate distance legends, or with other warning signs. The word CONSTRUCTION may be used in lieu of the word WORK in the sign message, prior to July 1, 1996 for construction projects or prior to July 1, 1998 for maintenance activities.

(5) Subsection 6F-6(b), Interim Markings, is revised to read as follows:

Interim pavement markings are those that may be used until it is practical and possible to install pavement markings that meet the full MUTCD standards for pavement markings. Normally, it should not be necessary to leave interim pavement markings in place for more than 2 weeks, except on roadways being paved with bituminous surface treatment (BST) and having traffic volumes under 2,000 ADT. All interim pavement markings, including pavement markings for no-passing zones, shall conform to the requirements of sections 3A and 3B with the following exceptions:

- (1) All interim broken-line pavement markings shall use the same cycle length as permanent markings and be at least 4 feet long, except that half-cycle lengths with a minimum of 2 foot stripes may be used for roadways with severe curvature (See Section 3A-6). This applies to white lane lines for traffic moving in the same direction and yellow center lines for two-lane roadways when it is safe to pass.
- (2) For those interim situations of 14 calendar days or less for a two- or three-lane road, no-passing zones may be identified by using signs rather than pavement markings (See sections 3B-4, 3B-5, and 3B-6). Also, signs may be used in lieu of pavement markings on low-volume roads for longer periods, when this practice is in keeping with the state's or highway agency's policy. These signs should be placed in accordance with sections 2B-21, 2B-22, and 2C-38.
- (3) The interim use of edgelines, channelizing lines, lane reduction transitions, gore markings and other longitudinal markings, and the various non-longitudinal markings (stop line, railroad crossings, crosswalks, words, symbols, etc.) should be in keeping with the state's or highway agency's policy.

(6) Subsections (1) through (5) shall become effective on January 10, 1996.

[Statutory Authority: Chapter 34.05 RCW and RCW 47.36.030, 95-23-097 (Order 154), § 468-95-055, filed 11/21/95, effective 1/10/96.]

WAC 468-95-060 When children are present. The following supplemental paragraph is hereby added to section 7B-12, "School Speed Limit Signs (S4-1, S4-2, S4-3, S4-4)," of the MUTCD:

The supplemental or lower panel of a "School Speed Limit 20" sign which reads "When Children are Present" shall indicate to the motorist that the 20 mile per hour school speed limit is in force under the following conditions:

- (1) School children are occupying or walking within the marked crosswalk.
- (2) School children are waiting at the curb or on the shoulder of the roadway and are about to cross the roadway by way of the marked crosswalk.

(3) School children are present or walking along the roadway, either on the adjacent sidewalk or, in the absence of sidewalks, on the shoulder within the posted school speed limit zone which extends 300 feet in either direction from the marked crosswalk.

[Statutory Authority: RCW 47.36.030, 85-01-056 (Order 93), § 468-95-060, filed 12/17/84.]

WAC 468-95-070 Meaning of signal indications. Pursuant to RCW 46.61.055, the first sentence of paragraph 3 applicable only to **circular red or red arrow**, of MUTCD Section 7D-5, is amended to read as follows:

Except when a sign is in place prohibiting a turn, vehicular traffic facing any steady red signal may cautiously enter the intersection to turn right, or to turn left from a one-way or two-way street into a one-way street, after stopping as required by (1) and (2) above.

[Statutory Authority: RCW 47.36.030, 85-01-056 (Order 93), § 468-95-070, filed 12/17/84.]

WAC 468-95-080 Functions. Pursuant to RCW 47.36.050 and 47.36.080, paragraph 2 of MUTCD Section 8A-1, is amended to read as follows:

With due regard for safety and for the integrity of operations by highway and railroad users, the highway agency and the railroad company are entitled to jointly occupy the right of way in the conduct of their assigned duties. This requires joint responsibility in the traffic control function between the public agency and the railroad.

[Statutory Authority: RCW 47.36.030, 85-01-056 (Order 93), § 468-95-080, filed 12/17/84.]

WAC 468-95-090 County road signing. Pursuant to RCW 36.75.300, there is added to the MUTCD, the following regulation pertaining to signing of county roads:

The legislative authority of each county may by resolution classify and designate portions of the county roads as primitive roads where the designated road portion:

- (1) Is not classified as part of the county primary road system, as provided for in RCW 36.86.070;
- (2) Has a gravel or earth driving surface; and
- (3) Has an average annual daily traffic of one hundred or fewer vehicles.

Any road designated as a primitive road shall be marked with a "PRIMITIVE ROAD" sign at all places where the primitive road portion begins or connects with a highway other than a primitive road.

A sign with the caption "CAUTION - NO WARNING SIGNS" may be installed on the same post with the "PRIMITIVE ROAD" sign, and may be individually erected at intermediate points along the road section if conditions warrant. In addition, a sign with the caption "NEXT . . . MILES" may be installed on the same post below the "CAUTION - NO WARNING SIGNS" sign.

The designs of the "PRIMITIVE ROAD, CAUTION - NO WARNING SIGNS, and NEXT . . . MILES" signs are available for public inspection at the headquarters office and all district offices of the Washington state department of transportation.

[Statutory Authority: RCW 47.36.030, 85-01-056 (Order 93), § 468-95-090, filed 12/17/84.]

(2001 Ed.)

WAC 468-95-100 Compliance dates. Through rulings approved by the Federal Highway Administrator, the 1988 edition of the Manual on Uniform Traffic Control Devices for Streets and Highways (MUTCD) contains compliance dates to specific sections for application of certain traffic control devices. These compliance dates are hereby amended as follows:

Ruling #	MUTCD Section	Compliance Date
IV-59	4D-2, 4D-7, 7D-5, 7D-9	12/31/95
II-5	2D-48, 2H-1 Thru 2H-16	9/30/97
II-110	2I-1 Thru 2I-7	9/30/95
III-38	3B-5	9/30/95
IV-58	2B-37, 4B-5(4)(c), 4B-6-2	9/30/2001
	4B-6(5)(b), 4B-6(8), 4B-12, 4B-18	
II-122	2D-15, 2E-11, 2F-11	9/30/97
IV-73	4B-6-5(a), 4B-15	9/30/96
II-119	2B-44	11/30/97

[Statutory Authority: Chapter 34.05 RCW and RCW 47.36.030, 95-23-097 (Order 154), § 468-95-100, filed 11/21/95, effective 1/10/96; 95-11-022 (Order 151), § 468-95-100, filed 5/8/95, effective 6/8/95; 91-02-008 (Order 127), § 468-95-100, filed 12/21/90, effective 1/21/91.]

Chapter 468-100 WAC

UNIFORM RELOCATION ASSISTANCE AND REAL PROPERTY ACQUISITION

WAC

SUBPART A GENERAL

468-100-001	Purpose and scope.
468-100-002	Definitions.
468-100-003	No duplication of payments.
468-100-004	Agency procedures, temporary relocation, monitoring, and corrective action.
468-100-005	Notices.
468-100-006	Administration of jointly funded projects.
468-100-007	Funding agency waiver of regulations.
468-100-008	Compliance with other laws and regulations.
468-100-009	Recordkeeping and reports.
468-100-010	Appeals.

SUBPART B REAL PROPERTY ACQUISITION

468-100-101	Applicability of acquisition requirements.
468-100-102	Criteria for appraisals.
468-100-103	Review of appraisals.
468-100-104	Acquisition of tenant-owned improvements.
468-100-105	Certain litigation expenses.
468-100-106	Donations.

SUBPART C GENERAL RELOCATION REQUIREMENTS

468-100-201	Purpose.
468-100-202	Applicability.
468-100-203	Relocation notices.
468-100-204	Availability of comparable replacement dwelling before displacement.
468-100-205	Relocation planning, advisory services, and coordination.
468-100-206	Eviction for cause.
468-100-207	Claims for relocation payments.
468-100-208	Aliens not lawfully present in the United States.
468-100-209	Relocation payments not considered as income.

SUBPART D PAYMENT FOR MOVING AND RELATED EXPENSES

468-100-301	Payment for actual reasonable moving and related expenses—Residential moves.
468-100-302	Fixed payment for moving expenses—Residential moves.
468-100-303	Payment for actual reasonable moving and related expenses—Nonresidential moves.

- 468-100-304 Fixed payment for moving expenses—Nonresidential moves.
 468-100-305 Ineligible moving and related expenses.
 468-100-306 Reestablishment expenses—Nonresidential moves.

SUBPART E
REPLACEMENT HOUSING PAYMENTS

- 468-100-401 Replacement housing payment for one hundred eighty-day homeowner-occupants.
 468-100-402 Replacement housing payment for ninety-day occupants.
 468-100-403 Additional rules governing replacement housing payments.

SUBPART F
MOBILE HOMES

- 468-100-501 Applicability.
 468-100-502 Moving and related expenses—Mobile homes.
 468-100-503 Replacement housing payment for one hundred eighty-day mobile home owner-occupants.
 468-100-504 Replacement housing payments for ninety-day mobile home occupants.
 468-100-505 Additional rules governing relocation payment to mobile home occupants.

SUBPART G
LAST RESORT HOUSING

- 468-100-601 Applicability.
 468-100-602 Methods of providing replacement housing.

SUBPART A
GENERAL

WAC 468-100-001 Purpose and scope. (1) This chapter promulgates rules to implement chapter 8.26 RCW (Relocation assistance—Real property acquisition policy).

(2) **Conflicts:** In the event of any conflict between these regulations and the provisions of chapter 8.26 RCW or any other applicable law, the statutory provisions are controlling.

(3) Notwithstanding anything to the contrary in this chapter, any displacing agency, where otherwise authorized, may make any relocation assistance payment in an amount which exceeds the maximum amount for such payment authorized by this chapter, and may comply with regulations promulgated pursuant to other authority, if the making of such payment or compliance with such requirements is necessary under federal law or regulations to secure federal financial assistance.

[Statutory Authority: Chapter 8.26 RCW. 89-17-048 (Order 121), § 468-100-001, filed 8/14/89, effective 9/14/89.]

WAC 468-100-002 Definitions. Certain terms used in this chapter are defined as follows:

(1) **Agency:** Means the state agency or local public agency which acquires the real property or displaces a person.

(2) **Alien not lawfully present in United States:** Means an alien who is not "lawfully present" in the United States as defined in Public Law 104-193 and includes:

(a) An alien present in the United States who has not been admitted or paroled into the United States pursuant to the Immigration and Nationality Act and whose stay in the United States has not been authorized by the United States Attorney General; and

(b) An alien who is present in the United States after the expiration of the period of stay authorized by the United States Attorney General or who otherwise violates the terms

and conditions of admission, parole or authorization to stay in the United States.

(3) **Appraisal:** Means a written statement independently and impartially prepared by a qualified appraiser setting forth an opinion of defined value of an adequately described property as of a specific date, supported by the presentation and analysis of relevant market information.

(4) **Business:** Means any lawful activity, except a farm operation, that is conducted:

(a) Primarily for the purchase, sale, lease, and/or rental of personal and/or real property, and/or for the manufacture, processing, and/or marketing of products, commodities, and/or any other personal property; or

(b) Primarily for the sale of services to the public; or

(c) Solely for the purpose of WAC 468-100-303, conducted primarily for outdoor advertising display purposes, when the display must be moved as a result of the project; or

(d) By a nonprofit organization that has established its nonprofit status under applicable federal or state law.

(5) **Comparable replacement dwelling:** Means a dwelling which meets the additional rules in WAC 468-100-403 and which:

(a) Is decent, safe, and sanitary according to the definition in subsection (7) of this section.

(b) Is functionally similar to the displacement dwelling with particular attention to the number of rooms and living space.

(c) Is adequate in size to accommodate the occupants.

(d) Is located in an area that is not subject to unreasonable adverse environmental conditions, is not generally less desirable than the location of the displaced person's dwelling with respect to public utilities and commercial and public facilities, and is reasonably accessible to the person's place of employment. Comparables may be used from neighborhoods similar to that of the acquired dwelling.

(e) Has a site that is typical in size for residential development with normal site improvements, including customary landscaping. The replacement site need not include either a special improvement or a major exterior attribute of the displacement site in accordance with WAC 468-100-403 (1)(b).

(f) Is currently available to the displaced person on the private market. However, a comparable replacement dwelling for a person receiving government housing assistance before displacement may reflect similar government housing assistance.

(g) Is priced within the financial means of the displaced person.

(i) For a one hundred eighty-day owner-occupant described at WAC 468-100-401, a comparable dwelling is considered to be within the displacee's financial means.

(ii) For a ninety-day tenant-occupant described at WAC 468-100-402, a comparable dwelling is considered to be within the displacee's financial means if after application of the rental assistance payment, described in said section, the displacee's portion of the monthly rent plus utilities would be thirty percent or less of his total monthly income from all sources.

(iii) For a displaced person who is not eligible to receive a replacement housing payment under WAC 468-100-402 due to failure to meet the length of occupancy requirements,

comparable housing is considered to be within the displacee's financial means if the acquiring agency pays that portion of the monthly housing costs which would exceed thirty percent of the displacee's monthly income for forty-two months. Replacement housing payments would be paid under WAC 468-100-601.

(6) **Contribute materially:** Means that during the two taxable years prior to the taxable year in which displacement occurs, or during such other period as the agency determines to be more equitable, a business or farm operation:

(a) Had average annual gross receipts of at least five thousand dollars; or

(b) Had average annual net earnings of at least one thousand dollars; or

(c) Contributed at least thirty-three and one-third percent of the owner's or operator's average annual gross income from all sources.

(d) If the application of the above criteria creates an inequity or hardship in any given case, the agency may approve the use of other criteria as determined appropriate.

(7) **Decent, safe, and sanitary (DSS) dwelling:** Means a dwelling which meets applicable housing and occupancy codes. However, any of the following standards which are not met by an applicable code shall apply, unless waived for good cause by the agency funding the project. The dwelling shall:

(a) Be structurally sound, weathertight, and in good repair.

(b) Contain a safe electrical wiring system adequate for lighting and other electrical devices.

(c) Contain a heating system capable of sustaining a healthful temperature (of approximately seventy degrees) for a displaced person.

(d) Be adequate in size with respect to the number of rooms and area of living space needed to accommodate the displaced person. There shall be a separate, well-lighted and ventilated bathroom that provides privacy to the user and contains a sink, bathtub or shower stall, and a toilet, all in good working order and properly connected to appropriate sources of water and to a sewage drainage system. In the case of a housekeeping dwelling, there shall be a kitchen area that contains a fully usable sink, properly connected to potable hot and cold water and to a sewage drainage system, and adequate space and utility service connections for a stove and refrigerator.

(e) Contains unobstructed egress to safe, open space at ground level. If the replacement dwelling unit is on the second story or above, with access directly from or through a common corridor, the common corridor must have at least two means of egress.

(f) For a displaced person who is handicapped, be free of any barriers which would preclude reasonable ingress, egress, or use of the dwelling by such displaced person.

(8) **Displaced person:**

(a) **General:** Means any person who moves from the real property or moves his or her personal property from the real property:

(i) As a direct result of the agency's acquisition of, or the initiation of negotiation for, such real property in whole or in part for a project; or

(ii) As a direct result of a written order from the acquiring agency to vacate such real property for a project; or

(iii) As a direct result of the agency's acquisition of, or written order to vacate for a project, other real property on which the person conducts a business or farm operation; or

(iv) As a direct result of a voluntary transaction by the owner pursuant to WAC 468-100-101 (2)(a) thereby displacing a tenant.

(b) **Persons not displaced:** The following is a nonexclusive listing of persons who do not qualify as a displaced person under this chapter.

(i) A person who moves before the initiation of negotiations except one who is required to move for reasons beyond his or her control as explained in WAC 468-100-403(5); or

(ii) A person who initially enters into occupancy of the property after the date of its acquisition for the project; or

(iii) A person whom the agency determines is not required to relocate permanently as a direct result of a project; or

(iv) A person whom the agency determines is not displaced as a direct result of a partial acquisition; or

(v) A person who, after receiving a notice of relocation eligibility also receives a notice of noneligibility (described in WAC 468-100-203 (2)(b)); or

(vi) An owner who voluntarily sells his or her property pursuant to WAC 468-100-101 (2)(a) after being informed in writing that if a mutually satisfactory agreement of sale cannot be reached, the agency will not acquire the property; or

(vii) A person who retains the right of use and occupancy of the real property for life following its acquisition by the agency; or

(viii) A person who retains the right of use and occupancy of the real property for a fixed term after its acquisition for a program or project receiving federal financial assistance from the Department of Interior; or

(ix) A person who has occupied the property for the purpose of obtaining assistance under the Uniform Act; or

(x) An owner who retains the right of use and occupancy of the real property for a fixed term after its acquisition by the Department of Interior under Public Law 93-477 or Public Law 93-303, except that such owner remains a displaced person for purposes of subpart D of this code; or

(xi) A person who is determined to be in unlawful occupancy or a person who has been evicted for cause prior to the initiations of negotiations for the property; or

(xii) A person who is not lawfully present in the United States and who has been determined to be ineligible for relocation benefits in accordance with WAC 468-100-208.

(9) **Dwelling:** Means the place of permanent or customary and usual residence of a person, as determined by the agency according to local custom or law, including a single family house; a single family unit in a two-family, multifamily, or multipurpose property; a unit of a condominium or cooperative housing project; a nonhousekeeping unit; a mobile home; or any other fixed or installed residential unit other than a unit customarily used, and currently (although not necessarily immediately) capable of use, for transportation or recreational purposes.

(10) **Farm operation:** Means any activity conducted solely or primarily for the production of one or more agricul-

tural products or commodities, including timber, for sale or home use, and customarily producing such products or commodities in sufficient quantity to be capable of contributing materially to the operator's support.

(11) **Financial assistance:** Means any grant, loan, or contribution, except a federal guarantee or insurance.

(12) **Initiation of negotiations:** Means the date of delivery of the initial written offer by the agency to the owner or the owner's representative to purchase real property for a project for the amount determined to be just compensation, unless applicable agency program regulations specify a different action to serve this purpose. However:

(a) If the agency issues a notice of its intent to acquire the real property, and a person moves after that notice, but before delivery of the initial written purchase offer, the "initiation of negotiations" means the date the person moves from the property. (See also WAC 468-100-505(3).)

(b) In the case of a permanent relocation to protect the public health and welfare under the Comprehensive Environmental Response Compensation and Liability Act of 1980 (Pub. L. 96-510, or "Superfund"), the "initiation of negotiations" means the formal announcement of such relocation or the federal or federally-coordinated health advisory where the federal government later decides to conduct a permanent relocation.

(13) **Mortgage:** Means any of such classes of liens as are commonly given to secure advances on, or the unpaid purchase price of, real property, under the laws of the state in which the real property is located, together with the credit instruments, if any, secured thereby.

(14) **Owner of displacement dwelling:** A displaced person is considered to have met the requirement to own a displacement dwelling if the person holds any of the following interests in real property acquired for a project:

(a) Fee title, a life estate, a ninety-nine year lease, or a lease, including any options for extension, with at least fifty years to run from the date of acquisition; or

(b) An interest in a cooperative housing project which includes the right to occupy a dwelling; or

(c) A contract to purchase any of the interests or estates described in subsection (1) or (3) of this section; or

(d) Any other interests, including a partial interest, which in the judgment of the agency warrants consideration as ownership.

(15) **Person:** Means any individual, family, partnership, corporation, or association.

(16) **Salvage value:** Means the probable sale price of an item, if offered for sale on the condition that it will be removed from the property at the buyer's expense, allowing a reasonable period of time to find a person buying with knowledge of the uses and purposes for which it is adaptable and capable of being used, including separate use of serviceable components and scrap when there is no reasonable prospect of sale except on that basis.

(17) **Small business:** Means any business having not more than five hundred employees working at the site being required or permanently displaced by a program or project, which site is the location of economic activity. Sites operated

solely by outdoor advertising signs, displays, or devices do not qualify as a business for purposes of WAC 468-100-306.

(18) **State:** Means any department, commission, agency, or instrumentality of the state of Washington.

(19) **Tenant:** Means a person who has the temporary use and occupancy of real property owned by another.

(20) **Uneconomic remnant:** Means a parcel of real property in which the owner is left with an interest after the partial acquisition of the owner's property, and which the acquiring agency has determined has little or no value.

(21) **Uniform Act:** Means the Federal Uniform Relocation Assistance and Real Property Acquisition Policies Act of 1970 (84 Stat. 1894; 42 U.S.C. 4601 et seq.; Pub. L. 91-646), and amendments thereto.

(22) **Unlawful occupancy:** A person is considered to be in unlawful occupancy when such person has been ordered to move by a court prior to the initiation of negotiations for the acquisition of the occupied property.

(23) **Voluntary transaction:** Means a donation, exchange, market sale, or other type of agreement entered into without compulsion on the part of the agency.

[Statutory Authority: Chapter 8.26 RCW and WSR 89-17-048 (Order 121), 01-02-027, § 468-100-002, filed 12/22/00, effective 1/22/01. Statutory Authority: Chapter 8.26 RCW, 89-17-048 (Order 121), § 468-100-002, filed 8/14/89, effective 9/14/89.]

WAC 468-100-003 No duplication of payments. No person is entitled to receive any payment under this chapter if that person receives a payment under federal, state, or local law which is determined to have the same purpose and effect as such payment under this chapter. The agency shall avoid creating a duplication based on information obtained by the agency at the time the agency approves a payment under this chapter.

[Statutory Authority: Chapter 8.26 RCW, 89-17-048 (Order 121), § 468-100-003, filed 8/14/89, effective 9/14/89.]

WAC 468-100-004 Agency procedures, temporary relocation, monitoring, and corrective action. (1) **Agency procedures:** Prior to a state agency or local public agency commencement of any project phase that will result in real property acquisition or displacement that is subject to chapter 8.26 RCW, the agency shall prepare and adopt operating procedures. Such procedures shall (a) assure that the agency will comply with chapter 8.26 RCW and this chapter, (b) contain specific reference to any state law which the agency believes provides an exception to RCW 8.26.180, 8.26.190, or this chapter, (c) include appropriate provisions to carry out this chapter in a manner that minimizes the opportunity for, and/or the appearance of fraud, waste, and mismanagement, and (d) shall be prefaced by a certification that the agency will carry out its responsibilities for real property acquisition and relocation assistance in accordance with chapter 8.26 RCW and this chapter. A statement such as the following would satisfy the certification requirement:

"The agency certifies that the agency will comply with chapter 8.26 RCW and chapter 468-100 WAC in connection with the acquisition of real property for, and relocation of persons displaced by, a program or project of the agency."

The agency shall maintain a record copy of such procedures available for public review at any reasonable time and location.

(2) **Temporary relocation:** In the case of a person that will not be displaced but is required to relocate temporarily because of the project, the provisions of WAC 468-100-204(3) shall apply.

(3) **Monitoring and corrective action:** The funding agency will monitor compliance with this chapter, and the acquiring agency and/or displacing agency shall take whatever corrective action is necessary to comply with chapter 8.26 RCW and this chapter. The funding agency may also apply sanctions in accordance with applicable program regulations.

[Statutory Authority: Chapter 8.26 RCW. 89-17-048 (Order 121), § 468-100-004, filed 8/14/89, effective 9/14/89.]

WAC 468-100-005 Notices. Notices which the agency is required to provide shall be written in plain, understandable language. Persons who are unable to read and understand the notice must be provided with appropriate translation and counseling. Each notice shall indicate the name and telephone number of a person who may be contacted for answers to questions or other needed help. Notices shall be personally served or sent by registered or certified first-class mail return receipt requested and documented in the agency's files.

[Statutory Authority: Chapter 8.26 RCW. 89-17-048 (Order 121), § 468-100-005, filed 8/14/89, effective 9/14/89.]

WAC 468-100-006 Administration of jointly funded projects. Whenever two or more agencies provide financial assistance to an agency or agencies to carry out functionally or geographically related activities which will result in the acquisition of property or the displacement of a person, the funding agencies may by agreement designate one such agency as the cognizant agency. At a minimum, the agreement shall set forth the financially assisted activities which are subject to its terms and cite any policies and procedures, in addition to this chapter, that are applicable to the activities under the agreement. Under the agreement, the cognizant agency shall assure that the project is in compliance with the provisions of chapter 8.26 RCW and this chapter. All financially assisted activities under the agreement shall be deemed a project for the purposes of this chapter.

[Statutory Authority: Chapter 8.26 RCW. 89-17-048 (Order 121), § 468-100-006, filed 8/14/89, effective 9/14/89.]

WAC 468-100-007 Funding agency waiver of regulations. The agency funding the project may, on a case-by-case or project basis, waive any requirement in this chapter not required by law if it determines that the waiver does not reduce any assistance or protection provided to an owner or displaced person under this chapter. Any request for a waiver by an acquiring or displacing agency shall be justified on a case-by-case or project basis.

[Statutory Authority: Chapter 8.26 RCW. 89-17-048 (Order 121), § 468-100-007, filed 8/14/89, effective 9/14/89.]

(2001 Ed.)

WAC 468-100-008 Compliance with other laws and regulations. The implementation of this chapter shall be in compliance with all applicable laws and implementing regulations, including the following:

(1) Section I of the Civil Rights Act of 1866 (42 U.S.C. 1982 et seq.).

(2) Title VI of the Civil Rights Act of 1964 (42 U.S.C. 2000d et seq.).

(3) Title VIII of the Civil Rights Act of 1968 (42 U.S.C. 3601 et seq.), as amended.

(4) The National Environmental Policy Act of 1969 (42 U.S.C. 4321 et seq.).

(5) Section 504 of the Rehabilitation Act of 1973 (29 U.S.C. 790 et seq.).

(6) Executive Order 12250 - Leadership and Coordination of Non-Discrimination Laws.

(7) Executive Order 11063 - Equal Opportunity and Housing, as amended by Executive Order 12259.

(8) Executive Order 11246 - Equal Employment Opportunity.

(9) Executive Order 11625 - Minority Business Enterprise.

(10) Executive Order 12259 - Leadership and Coordination of Fair Housing in Federal Programs.

(11) The Flood Disaster Protection Act of 1973 (Pub. L. 93-234).

(12) Executive Orders 11988, Floodplain Management, and 11990, Protection of Wetlands.

(13) The Age Discrimination Act of 1975 (42 U.S.C. 6101 et seq.).

[Statutory Authority: Chapter 8.26 RCW. 89-17-048 (Order 121), § 468-100-008, filed 8/14/89, effective 9/14/89.]

WAC 468-100-009 Recordkeeping and reports. (1) Records: The agency shall maintain adequate records of its acquisition and displacement activities in sufficient detail to demonstrate compliance with this chapter. These records shall be retained for at least three years after each owner of a property and each person displaced from a property receives the final payment to which the person is entitled under this chapter.

(2) **Confidentiality of records:** Records maintained by an agency in accordance with this chapter are confidential regarding their use as public information, unless applicable law provides otherwise.

(3) **Reports:** The agency shall submit a report of its real property acquisition and displacement activities under this chapter if required by the funding agency. A report will not be required more frequently than every three years, or as the Uniform Act provides, unless the funding agency shows good cause.

[Statutory Authority: Chapter 8.26 RCW. 89-17-048 (Order 121), § 468-100-009, filed 8/14/89, effective 9/14/89.]

WAC 468-100-010 Appeals. The displacing agency shall promptly review appeals in accordance with the requirements of applicable law and this chapter.

(1) **Actions which may be appealed:** A person may file written notice of an appeal with the displacing agency in any

case in which the person believes that the agency has failed to properly determine the person's eligibility for, or the amount of, a payment required under WAC 468-100-106 or 468-100-107, or a relocation payment required under this chapter.

(2) **Limitations:** A person is entitled to only such benefits as are specifically delineated in this chapter.

(3) **Form of notice:** The displacing agency shall consider a written appeal regardless of form. The appeal notice or letter should state what issues are being claimed, the reasons why the aggrieved person believes the claim should be allowed, and how the person believes he or she is otherwise aggrieved. The letter or notice should clearly identify the displacing agency's project and parcel of real property involved and should bear the signature and address of the aggrieved person or the person's authorized representative. The displacing agency may refuse to schedule any review or hearing on an appeal until these requirements have been complied with or may issue an order providing for dismissal of such appeal upon failure to comply within a reasonable time specified by the agency.

(4) **Time limit for initiating appeal:** The time limit shall be sixty days after the person receives written notification of the agency's determination on the person's claim.

(5) **Review of files by person making appeal:** The displacing agency shall permit a person to inspect and copy all materials pertinent to the person's appeal, except materials which are classified as confidential by the agency. The agency may, however, impose reasonable conditions on the person's right to inspect, consistent with applicable laws.

(6) **Hearing process:** Except as they may be inconsistent with the rules of this chapter, the department of transportation adopts the practice and procedure rules as set forth in chapter 468-10 WAC for appeals under this chapter. Where the rules of this chapter conflict with those of chapter 468-10 or 10-08 WAC, the rules of this chapter shall govern.

(7) **Discovery:** Discovery will be available in relocation appeals as follows: Any party to a relocation appeal may obtain discovery from any party by written interrogatories, written admissions, oral depositions, subpoena duces tecums, and written requests for production of documents. The procedures regarding these methods of discovery are found at CR 28 through 36 and 45(b) as now or hereafter amended and are hereby incorporated in this section.

[Statutory Authority: RCW 47.01101(5) and chapter 34.05 RCW. 94-14-102 (Order 146), § 468-100-010, filed 7/6/94, effective 8/6/94. Statutory Authority: Chapter 8.26 RCW. 89-17-048 (Order 121), § 468-100-010, filed 8/14/89, effective 9/14/89.]

SUBPART B REAL PROPERTY ACQUISITION

WAC 468-100-101 Applicability of acquisition requirements. General:

(1) Except as provided in subsection (2) of this section, the requirements of RCW 8.26.180 through 8.26.200 apply to any agency acquisition of real property for a program or project where the agency's program or project is carried out under threat of eminent domain including amicable agreements. Whether or not the acquiring agency has or intends to use the power of eminent domain, the requirements of RCW

8.26.180 through 8.26.200 apply to any project or program where there is an intended, planned, or designated project area, and all, or substantially all, of the property within that area is eventually intended to be acquired.

(2) Provided it does not conflict with subsection (1) of this section, an agency may determine that the requirements of RCW 8.26.180 through 8.26.200 do not apply to:

(a) Voluntary transactions (defined in WAC 468-100-002(22)) if all of the following conditions are present:

(i) No specific site or property needs to be acquired, although the agency may limit its search for alternative sites to a general geographic area.

(ii) The property to be acquired is not part of an intended, planned, or designated project area where all, or substantially all, of the property within the area is eventually to be acquired.

(iii) The agency will not acquire the property in the event negotiations fail to result in an amicable agreement, and the owner is so informed in writing.

(b) The acquisition of real property from a federal, state, or local public agency, if the acquiring agency does not have the authority to acquire the property through condemnation.

(3) In those situations where an agency wishes to purchase more than one site within a geographic area on a "voluntary transaction" basis, all owners shall be treated similarly.

[Statutory Authority: Chapter 8.26 RCW. 89-17-048 (Order 121), § 468-100-101, filed 8/14/89, effective 9/14/89.]

WAC 468-100-102 Criteria for appraisals. (1) **Standards of appraisal:** The format and level of documentation for an appraisal depend on the complexity of the appraisal problem. The agency shall develop minimum standards for appraisals consistent with established and commonly accepted appraisal practice for those acquisitions which, by virtue of their low value or simplicity, do not require the in-depth analysis and presentation necessary in a detailed appraisal. A detailed appraisal shall be prepared for all other acquisitions. A detailed appraisal shall reflect nationally recognized appraisal standards. An appraisal must contain sufficient documentation, including valuation data and the appraiser's analysis of that data, to support the appraiser's opinion of value. At a minimum, the appraisal shall contain the following items:

(a) The purpose and/or the function of the appraisal, a definition of the estate being appraised, and a statement of the assumptions and limiting conditions affecting the appraisal.

(b) An adequate description of the physical characteristics of the property being appraised (and, in the case of a partial acquisition, an adequate description of the remaining property), a statement of the known and observed encumbrances if any, title information, location, zoning, present use, an analysis of highest and best use, and at least a five-year sales history of the property.

(c) All relevant and reliable approaches to value consistent with commonly accepted professional appraisal practices. When sufficient market sales data are available to reliably support the fair market value for the specific appraisal problem encountered, the agency, at its discretion, may require only the market approach. If more than one approach

is utilized, there shall be an analysis and reconciliation of approaches to value that are sufficient to support the appraiser's opinion of value.

(d) A description of comparable sales, including a description of all relevant physical, legal, and economic factors such as parties to the transaction, source and method of financing, and verification by a party involved in the transaction.

(e) A statement of the value of the real property to be acquired and, for a partial acquisition, a statement of the value of the damages and benefits, if any, to the remaining real property.

(f) The effective date of valuation, date of appraisal, signature, and certification of the appraiser.

(2) **Influence of the project on just compensation.** To the extent permitted by applicable law, the appraiser in his "before" valuation shall disregard any decrease or increase in the fair market value of the real property caused by the project for which the property is to be acquired, or by the likelihood that the property would be acquired for the project, other than that due to the physical deterioration within the reasonable control of the owner.

(3) **Owner retention of improvements:** If the owner of a real property improvement agrees and is permitted to obtain the right to remove it in whole or in part from the project site, the amount to be offered for the interest in the real property to be acquired shall be the amount determined to be just compensation for the owner's entire interest in the real property. The salvage value (defined in WAC 468-100-002(15)) of the improvement to be removed shall be deducted from the agency's payment.

(4) **Qualifications of appraisers:** The agency shall establish criteria for determining the minimum qualifications of appraisers. Appraiser qualifications shall be consistent with the level of difficulty of the appraisal assignment. The agency shall review the experience, education, training, and other qualifications of appraisers, including review appraisers, and utilize only those determined to be qualified.

(5) **Conflict of interest:** No appraiser or review appraiser shall have any interest, direct or indirect, in the real property being appraised for the agency that would in any way conflict with the preparation or review of the appraisal. Compensation for making an appraisal shall not be based on the amount of the valuation. No appraiser shall act as a negotiator for real property which that person has appraised, except that the agency may permit the same person to both appraise and negotiate an acquisition where the value of the acquisition is ten thousand dollars, or less.

[Statutory Authority: Chapter 8.26 RCW and WSR 89-17-048 (Order 121), 01-02-027, § 468-100-102, filed 12/22/00, effective 1/22/01. Statutory Authority: Chapter 8.26 RCW, 89-17-048 (Order 121), § 468-100-102, filed 8/14/89, effective 9/14/89.]

WAC 468-100-103 Review of appraisals. The agency shall have an appraisal review process and, at a minimum:

(1) A qualified reviewing appraiser shall examine all appraisals to assure that they meet applicable appraisal requirements and shall, prior to acceptance, seek necessary corrections or revisions. The qualifications of the appraiser for each case depend on the complexity of the appraisal prob-

lem. The review appraiser shall determine whether the appraiser's documentation, including valuation data and analyses of that data, demonstrates the soundness of the appraiser's opinion of value.

(2) If the reviewing appraiser is unable to approve or recommend approval of an appraisal as an adequate basis for the estimate of just compensation, and it is determined that it is not practical to obtain an additional appraisal, the reviewing appraiser may develop appraisal documentation in accordance with WAC 468-100-102 to support an approved or recommended value. The agency may determine whether a second review is needed if the first review appraiser establishes a value different from that in the appraisal report(s) on the property.

(3) The review appraiser's certification of the recommended or approved value of the property shall be set forth in a signed statement which identifies the appraisal reports reviewed and explains the basis for such recommendation or approval. Any damages or benefits to any remaining property shall also be identified in the statement. The level of explanation by the review appraiser depends on the complexity of the appraisal problem. The agency may accept a simple approval endorsement by the review appraiser in the case of a low value property requiring an uncomplicated valuation process.

[Statutory Authority: Chapter 8.26 RCW, 89-17-048 (Order 121), § 468-100-103, filed 8/14/89, effective 9/14/89.]

WAC 468-100-104 Acquisition of tenant-owned improvements. (1) **Acquisition of improvements:** When acquiring any interest in real property, the agency shall offer to acquire at least an equal interest in all buildings, structures, or other improvements located upon the real property to be acquired or which the agency determines will be adversely affected by the use to which such real property will be put. This shall include any improvement of a tenant-owner who has the right or obligation to remove the improvement at the expiration of the lease term.

(2) **Improvements considered to be real property:**

Any building, structure, or other improvement, which would be considered to be real property if owned by the owner of the real property on which it is located, shall be considered to be real property for purposes of WAC 468-100-101 through 468-100-106.

(3) **Appraisal and establishment of just compensation for tenant-owned realty improvements:** Just compensation for a tenant-owned realty improvement is the amount which the improvement contributes to the fair market value of the whole property or its salvage value, whichever is greater. (Salvage value is defined in WAC 468-100-002(15).)

(4) **Special conditions:** No payment shall be made to a tenant-owner to acquire any real property improvement or relocate any tenant-owned real estate fixture unless:

(a) The owner of the real property on which the improvement is located disclaims all interest in the tenant's realty improvement or fixture; and

(b) The tenant-owner, in consideration for the acquisition payment, assigns, transfers, and releases to the agency all of the tenant-owner's right, title, and interest in the realty improvement; and

(c) The payment does not result in the duplication of any compensation otherwise authorized by law.

(5) **Alternative compensation:** Nothing in WAC 468-100-101 through 468-100-106 shall be construed to deprive the tenant-owner of any right to reject payment under WAC 468-100-101 through 468-100-106 and to obtain payment for such property interests in accordance with other applicable law.

[Statutory Authority: Chapter 8.26 RCW. 89-17-048 (Order 121), § 468-100-104, filed 8/14/89, effective 9/14/89.]

WAC 468-100-105 Certain litigation expenses. The owner of the real property shall be reimbursed for any reasonable expenses, including reasonable attorney, and expert witness fees, which the owner actually incurred because of a condemnation proceeding; pursuant to RCW 8.25.020 and 8.25.075.

[Statutory Authority: Chapter 8.26 RCW. 89-17-048 (Order 121), § 468-100-105, filed 8/14/89, effective 9/14/89.]

WAC 468-100-106 Donations. Nothing in this chapter shall prevent a person, after being informed of the right to receive just compensation based on an appraisal of the real property, from making a gift or donation of real property or any part thereof, or any interest therein, or of any compensation paid therefor, to the agency. The agency shall obtain an appraisal of the real property and offer the full amount of just compensation due unless the owner, after being fully informed of such policy, releases the agency from these obligations. An appraisal is not required if the agency determines that an appraisal is unnecessary because the valuation problem is uncomplicated and the fair market value is estimated at two thousand five hundred dollars or less, based on a review of available data.

[Statutory Authority: Chapter 8.26 RCW. 89-17-048 (Order 121), § 468-100-106, filed 8/14/89, effective 9/14/89.]

SUBPART C

GENERAL RELOCATION REQUIREMENTS

WAC 468-100-201 Purpose. WAC 468-100-201 through 468-100-208 prescribes general requirements governing the provision of relocation payments and other relocation assistance under the regulations in this chapter.

[Statutory Authority: Chapter 8.26 RCW. 89-17-048 (Order 121), § 468-100-201, filed 8/14/89, effective 9/14/89.]

WAC 468-100-202 Applicability. These requirements apply to the relocation of any displaced person as defined in WAC 468-100-002(7).

[Statutory Authority: Chapter 8.26 RCW. 89-17-048 (Order 121), § 468-100-202, filed 8/14/89, effective 9/14/89.]

WAC 468-100-203 Relocation notices. Written notices shall be furnished as required by WAC 468-100-005.

(1) **General relocation information notice:** As soon as feasible, a person scheduled to be displaced shall be furnished with a general written description of the agency's relocation program which does at least the following:

[Title 468 WAC—p. 120]

(a) Informs the person that the person may be displaced for the project and generally describes the relocation payment(s) for which the person may be eligible, the basic conditions of eligibility, and the procedures for obtaining the payment(s).

(b) Informs the person that the person will be given reasonable relocation advisory services, including referrals to replacement properties, help in filing payment claims, and other necessary assistance to help the person successfully relocate.

(c) Informs the person that the person will not be required to move without at least ninety days' advance written notice (see subsection (3) of this section), and informs any person to be displaced from a dwelling that the person cannot be required to move permanently unless at least one comparable replacement dwelling has been made available.

(d) Describes the person's right to appeal the agency's determination as to eligibility for, or the amount of, any relocation payment for which the person may be eligible.

(2) Notice of relocation eligibility:

(a) Eligibility for relocation assistance shall begin on the date of initiation of negotiations (defined in WAC 468-100-002(11)) for the occupied property. When this occurs, the agency shall promptly provide written notice to all occupants to be displaced of their eligibility for applicable relocation assistance in accordance with WAC 468-100-005.

(b) An occupant may subsequently be provided a notice of noneligibility if the agency determines the person will not be displaced. Such notice may be issued only if the person has not moved and the agency agrees to reimburse the person for any expenses incurred to satisfy any binding contractual relocation obligations entered into after the effective date of the notice of relocation eligibility.

(3) Ninety-day notice:

(a) **General:** No lawful occupant shall be required to move unless the occupant has received at least ninety days advance written notice of the earliest date by which he or she may be required to move.

(b) **Timing of notice:** The displacing agency may issue the notice ninety days before it expects the person to be displaced or earlier.

(c) **Content of notice:** The ninety-day notice shall either state a specific date as the earliest date by which the occupant may be required to move, or state that the occupant will receive a further notice indicating, at least thirty days in advance, the specific date by which the occupant must move. If the ninety-day notice is issued before a comparable replacement dwelling is made available, the notice must state clearly that the occupant will not have to move earlier than ninety days after such a dwelling is made available. (See WAC 468-100-204(1).)

(d) Informs the person that any person who is an alien not lawfully present in the United States is ineligible for relocation advisory services and relocation payments, unless such ineligibility would result in exceptional and extremely unusual hardship to a qualifying spouse, parent, or child, as defined in WAC 468-100-208(9).

(e) **Urgent need:** In unusual circumstances, an occupant may be required to vacate the property on less than ninety

(2001 Ed.)

days advance written notice if the agency determines that a ninety-day notice is impracticable, such as when the person's continued occupancy of the property would constitute a substantial danger to health or safety. A record of the agency's determination shall be included in the applicable case file.

[Statutory Authority: Chapter 8.26 RCW and WSR 89-17-048 (Order 121), 01-02-027, § 468-100-203, filed 12/22/00, effective 1/22/01. Statutory Authority: Chapter 8.26 RCW, 89-17-048 (Order 121), § 468-100-203, filed 8/14/89, effective 9/14/89.]

WAC 468-100-204 Availability of comparable replacement dwelling before displacement. No person to be displaced shall be required to move from the person's dwelling unless at least one comparable replacement dwelling (defined in WAC 468-100-002(4)) has been made available to the person.

(1) **Policy:** Three or more comparable replacement dwellings shall be made available unless such numbers are not available on the local housing market. When otherwise feasible, in accordance with WAC 468-100-205 (3)(b)(iii) and 468-100-403 (1)(d), comparable replacement dwellings to be made available to minority persons may include dwellings not located in an area of minority concentration. A comparable replacement dwelling will be considered to have been made available to a person, if:

- (a) The person is informed of its location; and
- (b) The person has sufficient time to negotiate and enter into a purchase agreement or lease for the property; and
- (c) Subject to reasonable safeguards, the person is assured of receiving the relocation assistance and acquisition payment to which the person is entitled in sufficient time to complete the purchase or lease of the property.

(2) **Circumstances permitting waiver:** The funding agency may grant a waiver of the policy in subsection (1) of this section in any case where it is demonstrated that a person must move because of:

- (a) A major disaster as defined in section 102(c) of the Disaster Relief Act of 1974 (42 U.S.C. 5121); or
- (b) A presidentially declared national emergency; or
- (c) Another emergency which requires immediate vacation of the real property, such as when continued occupancy of the displacement dwelling constitutes a substantial danger to the health or safety of the occupants or the public.

(3) **Basic conditions of emergency move:** Whenever a person is required to relocate for a temporary period because of an emergency as described in subsection (2) of this section, for purposes of filing a claim and meeting the eligibility requirements for a relocation payment, the date of displacement is the date the person moves from the temporarily-occupied dwelling. The agency shall:

- (a) Take whatever steps are necessary to assure that the person is temporarily relocated to a sanitary dwelling;
- (b) Pay the actual reasonable out-of-pocket moving expenses and any reasonable increase in monthly housing costs incurred in connection with the temporary relocation;
- (c) Make available to the displaced person as soon as feasible, at least one comparable replacement dwelling.
- (d) The person is entitled to be heard according to WAC 468-100-010 in the event of a grievance.

[Statutory Authority: Chapter 8.26 RCW, 89-17-048 (Order 121), § 468-100-204, filed 8/14/89, effective 9/14/89.]

WAC 468-100-205 Relocation planning, advisory services, and coordination. (1) **Relocation planning:** During the early stages of development, state and federal-aid programs or projects shall be planned in such a manner that the problems associated with the displacement of individuals, families, businesses, farms, and nonprofit organizations are recognized and solutions are developed to minimize the adverse impacts of displacement. Such planning, where appropriate, shall precede any action by an agency which will cause displacement, and should include an evaluation of program resources available to carry out timely and orderly relocations. Planning may involve a relocation survey or study which may include the following:

(a) An estimate of the number of households to be displaced including information such as owner/tenant status, estimated value and rental rates of properties to be acquired, family characteristics, and special consideration of the impacts on minorities, the elderly, large families, and the handicapped when applicable.

(b) An estimate of the number of comparable replacement dwellings in the area (including price ranges and rental rates) that may be available to fulfill the needs of those households displaced. When an adequate supply of comparable housing is not expected to be available, consideration of last resort housing actions should be instituted.

(c) An estimate of the number, type and size of the businesses, farms, and nonprofit organizations to be displaced and the approximate number of employees that may be affected.

(d) Consideration of any special relocation advisory services that may be necessary from the displacing agency and other cooperating agencies.

(2) **Relocation assistance advisory services, general:** The agency shall carry out a relocation assistance advisory program which satisfies the requirements of Title VI of the Civil Rights Act of 1964 (42 U.S.C. 2000d et seq.), Title VIII of the Civil Rights Act of 1968 (42 U.S.C. 3601 et seq.), and Executive Order 11063 (27 FR 11527), and offers the services described in subsection (3) of this section. If the agency determines that a person occupying property adjacent to the real property acquired for the project is caused substantial economic injury because of such acquisition, it may offer the services to such person.

(3) **Services to be provided:** The advisory program shall include such measures, facilities, and services as may be necessary or appropriate in order to:

(a) Determine the relocation needs and preferences of each person to be displaced and explain the relocation payments and other assistance for which the person may be eligible, the related eligibility requirements, and the procedures for obtaining such assistance. This shall include a personal interview with each person.

(b) Provide current and continuing information on the availability, purchase prices, and rental costs of comparable replacement dwellings, and explain that the person cannot be required to move unless at least one comparable replacement

dwelling is made available as set forth in WAC 468-100-204(1).

(i) As soon as feasible, the agency shall inform the person in writing of the specific comparable replacement dwelling and the price or rent used for establishing the upper limit of the replacement housing payment (see WAC 468-100-403 (1) and (2)) and the basis for the determination, so that the person is aware of the maximum replacement housing payment for which the person may qualify.

(ii) Where feasible, housing shall be inspected prior to being made available to assure that it meets applicable standards. (See WAC 468-100-002 (4) and (6).) If such an inspection is not made, the person to be displaced shall be notified that a replacement housing payment may not be made unless the replacement dwelling is subsequently inspected and determined to be DSS.

(iii) Whenever possible, minority persons shall be given reasonable opportunities to relocate to DSS replacement dwellings, not located in an area of minority concentration, that are within their financial means. This policy, however, does not require an agency to provide a person a larger payment than is necessary to enable a person to relocate to a comparable replacement dwelling.

(iv) All displaced persons, especially the elderly and handicapped, shall be offered transportation to inspect housing to which they are referred.

(c) Provide current and continuing information on the availability, purchase prices, and rental costs of comparable and suitable commercial and farm properties and locations. Assist any person displaced from a business or farm operation to obtain and become established in a suitable replacement location.

(d) Minimize hardships to persons in adjusting to relocation by providing counseling, advice as to other sources of assistance that may be available, and such other help as may be appropriate.

(e) Supply persons to be displaced with appropriate information concerning federal and state housing programs, disaster loans and other programs administered by the Small Business Administration, and other federal, state, and local programs offering assistance to persons to be displaced.

(f) Any person who occupies property acquired by an agency, when such occupancy began subsequent to the acquisition of the property, and the occupancy is permitted by a short-term rental agreement or an agreement subject to termination when the property is needed for a program or project, shall be eligible for advisory services, as determined by the agency.

(4) **Coordination of relocation activities:** Relocation activities shall be coordinated with project work and other displacement-causing activities to ensure that, to the extent feasible, persons displaced receive consistent treatment and the duplication of functions is minimized.

[Statutory Authority: Chapter 8.26 RCW. 89-17-048 (Order 121), § 468-100-205, filed 8/14/89, effective 9/14/89.]

WAC 468-100-206 Eviction for cause. Eviction for cause must conform to applicable state and local law. Any person who has lawfully occupied the real property, but who is later evicted for cause on or after the date of the initiation

of negotiations, retains the right to the relocation payments and other assistance set forth in these regulations. For purposes of determining eligibility for relocation payments, the date of displacement is the date the person moves or the date a comparable replacement dwelling is made available, whichever is later. This section applies only if the agency had intended to displace the person.

[Statutory Authority: Chapter 8.26 RCW. 89-17-048 (Order 121), § 468-100-206, filed 8/14/89, effective 9/14/89.]

WAC 468-100-207 Claims for relocation payments.

(1) **Documentation:** Any claim for a relocation payment shall be supported by such documentation as may be reasonably required to support expenses incurred, such as, bills, certified prices, appraisals, or other evidence of such expenses. Payment for a low cost or uncomplicated move may be made without documentation of actual costs when payment is limited to the amount of the lowest acceptable bid or estimate obtained by the agency. A displaced person must be provided reasonable assistance necessary to complete and file any required claim for payment.

(2) **Expeditious payments:** The agency shall review claims in an expeditious manner. The claimant shall be promptly notified as to any additional documentation that is required to support the claim. Payment for a claim shall be made as soon as feasible following receipt of sufficient documentation to support the claim.

(3) **Advance payments:** If a person demonstrates the need for an advance relocation payment in order to avoid or reduce a hardship, the agency shall issue the payment, subject to such safeguards as are appropriate to ensure that the objective of the payment is accomplished.

(4) **Time for filing:** All claims for a relocation payment shall be filed with the agency within eighteen months after:

(a) For tenants, the date of displacement;

(b) For owners, the date of displacement or the date of the final payment for the acquisition of the real property, whichever is later.

This time period shall be waived by the agency for good cause.

(5) **Multiple occupants of one displacement dwelling:** If two or more occupants of the displacement dwelling move to separate replacement dwellings, each occupant is entitled to a reasonable prorated share, as determined by the agency, of any relocation payments that would have been made if the occupants moved together to a comparable replacement dwelling. However, if the agency determines that two or more occupants maintained separate households within the same dwelling, such occupants have separate entitlements to relocation payments.

(6) **Deductions from relocation payments:** An agency shall deduct the amount of any advance relocation payment from the relocation payment(s) to which a displaced person is otherwise entitled. Similarly where such a deduction would not prevent the displaced person from obtaining a comparable replacement dwelling as required by WAC 468-100-204, an agency may, deduct from relocation payments any rent that the displaced person owes the agency. The agency shall

not withhold any part of a relocation payment to a displaced person to satisfy an obligation to any other creditor.

(7) **Notice of denial of claim:** If the agency disapproves all or part of a payment claimed or refuses to consider the claim on its merits because of untimely filing or other grounds, it shall promptly notify the claimant in writing of its determination, the basis for its determination, and the procedures for appealing that determination.

[Statutory Authority: Chapter 8.26 RCW. 89-17-048 (Order 121), § 468-100-207, filed 8/14/89, effective 9/14/89.]

WAC 468-100-208 Aliens not lawfully present in the United States. (1) Each person seeking relocation payments or relocation advisory assistance shall, as a condition of eligibility, certify:

(a) In the case of an individual, that he or she is either a citizen or national of the United States, or an alien who is lawfully present in the United States.

(b) In the case of a family, that each family member is either a citizen or national of the United States, or an alien who is lawfully present in the United States. The certification may be made by the head of the household on behalf of other family members.

(c) In the case of an unincorporated business, farm, or nonprofit organization, that each owner is either a citizen or national of the United States, or an alien who is lawfully present in the United States. The certification may be made by the principal owner, manager, or operating officer on behalf of other persons with an ownership interest.

(d) In the case of an incorporated business, farm, or nonprofit organization, that the corporation is authorized to conduct business within the United States.

(2) The certification provided pursuant to subsection (1)(a), (b) and (c) of this section shall indicate whether such person is either a citizen or national of the United States, or an alien who is lawfully present in the United States. Requirements concerning the certification in addition to those contained in this rule shall be within the discretion of the federal funding agency and, within those parameters, that of the displacing agency.

(3) In computing relocation payments under the Uniform Act, if any member(s) of a household or owner(s) of an unincorporated business, farm, or nonprofit organization is (are) determined to be ineligible because of a failure to be legally present in the United States, no relocation payments may be made to him or her. Any payment(s) for which such household, unincorporated business, farm, or nonprofit organization would otherwise be eligible shall be computed for the household, based on the number of eligible household members and for the unincorporated business, farm, or nonprofit organization, based on the ratio of ownership between eligible and ineligible owners.

(4) The displacing agency shall consider the certification provided pursuant to subsection (1) of this section to be valid, unless the displacing agency determines in accordance with subsection (6) of this section that it is invalid based on a review of an alien's documentation or other information that the agency considers reliable and appropriate.

(5) Any review by the displacing agency of the certifications provided pursuant to subsection (1) of this section shall

(2001 Ed.)

be conducted in a nondiscriminatory fashion. Each displacing agency will apply the same standard of review to all such certifications it receives, except that such standard may be revised periodically.

(6) If, based on a review of an alien's documentation or other credible evidence, a displacing agency has reason to believe that a person's certification is invalid (for example a document reviewed does not on its face reasonably appear to be genuine), and that, as a result, such person may be an alien not lawfully present in the United States, it shall obtain the following information before making a final determination:

(a) If the agency has reason to believe that the certification of a person who has certified that he or she is an alien lawfully present in the United States is invalid, the displacing agency shall obtain verification of the alien's status from the local Immigration and Naturalization Service (INS) Office. A list of local INS offices was published in the *Federal Register* in November 17, 1997, at 62 FR 61350. Any request for INS verification shall include the alien's full name, date of birth and alien number, and a copy of the alien's documentation. (If an agency is unable to contact the INS, it may contact the FHWA in Washington, DC at 202-366-2035 (Marshall Schy, Office of Real Estate Services) or 202-366-1371 (Reid Alsop, Office of Chief Counsel), for a referral to the INS.)

(b) If an agency has reason to believe that the certification of a person who has certified that he or she is a citizen or national is invalid, the displacing agency shall request evidence of United States citizenship or nationality from such person and, if considered necessary, verify the accuracy of such evidence with the issuer.

(7) No relocation payments or relocation advisory assistance shall be provided to a person who has not provided the certification described in this section or who has been determined to be not lawfully present in the United States, unless such person can demonstrate to the displacing agency's satisfaction that the denial of relocation benefits will result in an exceptional and extremely unusual hardship to such person's spouse, parent, or child who is a citizen of the United States, or is an alien lawfully admitted for permanent residence in the United States.

(8) For purposes of subsection (7) of this section, "exceptional and extremely unusual hardship" to such spouse, parent, or child of the person not lawfully present in the United States means that the denial of relocation payments and advisory assistance to such person will directly result in:

(a) A significant and demonstrable adverse impact on the health or safety of such spouse, parent, or child;

(b) A significant and demonstrable adverse impact on the continued existence of the family unit of which such spouse, parent, or child is a member; or

(c) Any other impact that the displacing agency determines will have a significant and demonstrable adverse impact on such spouse, parent, or child.

(9) The certification referred to in subsection (1) of this section may be included as part of the claim for relocation payments described in WAC 468-100-207.

[Statutory Authority: Chapter 8.26 RCW and WSR 89-17-048 (Order 121), 01-02-027, § 468-100-208, filed 12/22/00, effective 1/22/01. Statutory

Authority: Chapter 8.26 RCW. 89-17-048 (Order 121), § 468-100-208, filed 8/14/89, effective 9/14/89.]

WAC 468-100-209 Relocation payments not considered as income. No payment received by a displaced person under this chapter may be considered as income for the purpose of determining the eligibility or extent of eligibility of any person for assistance under any state law or for the purposes of any income tax or any tax imposed under Title 82 RCW, and the payments shall not be deducted from any amount to which any recipient would otherwise be entitled under Title 74 RCW.

[Statutory Authority: Chapter 8.26 RCW and WSR 89-17-048 (Order 121). 01-02-027, § 468-100-209, filed 12/22/00, effective 1/22/01.]

SUBPART D PAYMENT FOR MOVING AND RELATED EXPENSES

WAC 468-100-301 Payment for actual reasonable moving and related expenses—Residential moves. Any displaced owner-occupant or tenant of a dwelling who qualifies as a displaced person (defined in WAC 468-100-002(7)) is entitled to payment of the person's actual moving and related expenses, as the agency determines to be reasonable, including expenses necessary to:

- (1) **Disconnect**, dismantle, and remove displaced personal property.
- (2) **Pack** displaced personal property.
- (3) **Transport** displaced personal property within fifty miles. The agency may authorize transportation costs of a distance beyond fifty miles based on economic feasibility of the available choices of replacement locations, but not on the displacee's subjective preferences.
- (4) **Store** personal property for a period not to exceed twelve months, unless the agency determines a longer period is necessary.
- (5) **Unpack** relocated personal property.
- (6) **Reassemble**, reinstall, and reconnect relocated personal property.
- (7) **Insure** for the replacement value of personal property in connection with the move; or where insurance covering loss, theft, or damage in the process of moving (not through fault or negligence of the displaced person or the person's agent, or employee) is not reasonably available, pay the replacement value for such loss, theft, or damage.
- (8) **The** replacement value of property lost, stolen, or damaged in the process of moving (not through the fault or negligence of the displaced person, his or her agent, or employee) where insurance covering such loss, theft, or damage is not reasonably available.
- (9) **Reimburse** other moving-relating expenses that are not listed as ineligible under WAC 468-100-305, as the agency determines to be reasonable and necessary.

[Statutory Authority: Chapter 8.26 RCW. 89-17-048 (Order 121), § 468-100-301, filed 8/14/89, effective 9/14/89.]

WAC 468-100-302 Fixed payment for moving expenses—Residential moves. Any person displaced from a

dwelling or a seasonal residence, is entitled to receive a fixed payment in lieu of a payment for actual moving and related expenses covered under WAC 468-100-301. This allowance shall be determined according to the applicable schedule approved by the lead agency, except that the expense and dislocation allowance to a person occupying a furnished one-room unit shared by more than one other person involving a minimum of personal property to be moved, shall be limited to fifty dollars.

[Statutory Authority: Chapter 8.26 RCW. 89-17-048 (Order 121), § 468-100-302, filed 8/14/89, effective 9/14/89.]

WAC 468-100-303 Payment for actual reasonable moving and related expenses—Nonresidential moves. (1) **Eligible costs.** Any business or farm operation which qualifies as a displaced person (defined in WAC 468-100-002(7)) is entitled to payment for such actual moving and related expenses, as the agency determines to be reasonable and necessary, including expenses for:

(a) Transportation of personal property. Transportation costs for a distance beyond fifty miles are not eligible, unless the agency determines that relocation beyond fifty miles is justified.

(b) Packing, crating, unpacking, and uncrating of the personal property.

(c) Disconnecting, dismantling, removing, reassembling, and reinstalling relocated machinery, equipment, and other personal property, including substitute personal property described in WAC 468-100-303 (1)(l). This includes connection to utilities available nearby. It also includes modifications to the personal property necessary to adapt it to the replacement structure, the replacement site, or the utilities at the replacement site, and modifications necessary to adapt the utilities at the replacement site to the personal property. (Expenses for providing utilities from the right-of-way to the building or improvement are excluded.)

(d) Storage of the personal property for a period not to exceed twelve months, unless the agency determines that a longer period is necessary.

(e) Insurance for the replacement value of the personal property in connection with the move and necessary storage.

(f) Any license, permit, or certification required of the displaced person at the replacement location. However, the payment may be based on the remaining useful life of the existing license, permit, or certification.

(g) The replacement value of property lost, stolen, or damaged in the process of moving (not through the fault or negligence of the displaced person, his or her agent, or employee) where insurance covering such loss, theft, or damage is not reasonably available.

(h) Professional services necessary for:

(i) Planning the move of the personal property;

(ii) Moving the personal property; and

(iii) Installing the relocated personal property at the replacement location.

(i) Relettering signs and replacing stationery on hand at the time of displacement that are made obsolete as a result of the move.

(j) Actual direct loss of tangible personal property incurred as a result of moving or discontinuing the business or farm operation. The payment shall consist of the lesser of:

(i) The fair market value of the item for continued use at the displacement site, less the proceeds from its sale. (To be eligible for payment, the claimant must make a good faith effort to sell the personal property, unless the agency determines that such effort is not necessary. When payment for property loss is claimed for goods held for sale, the fair market value shall be based on the cost of the goods to the business, not the potential selling price.); or

(ii) The estimated cost of moving the item, but with no allowance for storage. (If the business or farm operation is discontinued, the estimated cost shall be based on a moving distance of fifty miles.)

(k) The reasonable cost incurred in attempting to sell an item that is not to be relocated.

(l) Purchase of substitute personal property. If an item of personal property which is used as part of a business or farm operation is not moved but is promptly replaced with a substitute item that performs a comparable function at the replacement site, the displaced person is entitled to payment of the lesser of:

(i) The cost of the substitute item, including installation costs at the replacement site, minus any proceeds from the sale or trade-in of the replaced item; or

(ii) The estimated cost of moving and reinstalling the replaced item but with no allowance for storage. At the agency's discretion, the estimated cost for a low cost or uncomplicated move may be based on a single bid or estimate.

(m) Searching for a replacement location. A displaced business or farm operation is entitled to reimbursement for actual expenses, not to exceed one thousand dollars, as the agency determines to be reasonable, which are incurred in searching for a replacement location, including:

(i) Transportation;

(ii) Meals and lodging away from home;

(iii) Time spent searching, based on reasonable salary or earnings;

(iv) Fees paid to a real estate agent or broker to locate a replacement site, exclusive of any fees or commissions related to the purchase of such site.

(n) Other moving-related expenses that are not listed as ineligible under WAC 468-100-305, as the agency determines to be reasonable and necessary.

(2) **Notification and inspection.** The following requirements apply to payments under this section:

(a) The agency shall inform the displaced person in writing, of the requirements of (b) and (c) of this subsection, as soon as possible after the initiation of negotiations. This information may be included in the relocation information provided to the displaced person as set forth in WAC 468-100-203.

(b) The displaced person must provide the agency reasonable advance written notice of the approximate date of the start of the move or disposition of the personal property and a list of the items to be moved. However, the agency may waive this notice requirement after documenting its file accordingly.

(c) The displaced person must permit the agency to make reasonable and timely inspections of the personal property at both the displacement and replacement sites and to monitor the move.

(3) **Self-move.** If the displaced person elects to take full responsibility for the move of the business or farm operation, the agency may make a payment for the person's moving expenses in an amount not to exceed the lower of two acceptable bids or estimates obtained by the agency or prepared by qualified staff. At the agency's discretion, a payment for a low cost or uncomplicated move may be based on a single bid or estimate.

(4) **Transfer of ownership.** Upon request and in accordance with applicable law, the claimant shall transfer to the agency ownership of any personal property that has not been moved, sold, or traded in.

(5) **Advertising signs.** The amount of a payment for direct loss of an advertising sign which is personal property shall be the lesser of:

(a) The depreciated reproduction cost of the sign, as determined by the agency, less the proceeds from its sale; or

(b) The estimated cost of moving the sign, but with no allowance for storage.

[Statutory Authority: Chapter 8.26 RCW, 89-17-048 (Order 121), § 468-100-303, filed 8/14/89, effective 9/14/89.]

WAC 468-100-304 Fixed payment for moving expenses—Nonresidential moves. (1) **Business:** A displaced business, defined in WAC 468-100-002(3), may be eligible to choose a fixed payment in lieu of a payment for actual moving and related expenses, and actual reasonable reestablishment expenses provided by WAC 468-100-303 and 468-100-306. The payment except for payment to a non-profit organization, shall equal the average annual net earnings of the business, as computed in accordance with subsection (5) of this section, but not less than one thousand dollars nor more than twenty thousand dollars. The displaced business is eligible for the payment if the agency determined that:

(a) The business owns or rents personal property which must be moved in connection with such displacement and for which an expense would be incurred in such move; and, the business vacates or relocates from its displacement site; and

(b) The business cannot be relocated without a substantial loss of its existing patronage (clientele or net earnings). A business is assumed to meet this test unless the agency demonstrates that it will not suffer a substantial loss of its existing patronage; and

(c) The business is not part of a commercial enterprise having more than three other entities which are not being acquired by the agency, and which are under the same ownership and engaged in the same or similar business activities.

(d) The business is not operated at a displacement dwelling solely for the purpose of renting such dwelling to others; and

(e) The business is not operated at the displacement site solely for the purpose of renting the site to others; and

(f) The business contributed materially (defined in WAC 468-100-002(3)) to the income of the displaced person during the two taxable years prior to displacement.

(2) **Determining the number of businesses:** In determining whether two or more displaced legal entities constitute a single business which is entitled to only one fixed payment, the displacing agency shall consider all pertinent factors including the extent to which:

- (a) The same premises and equipment are shared;
- (b) Substantially identical or interrelated business functions are carried out and business and financial affairs are commingled;
- (c) The entities are held out to the public, and to those customarily dealing with them, as one business; and
- (d) The same person, or closely related persons own, control, or manage the affairs of the entities.

(3) **Farm operation:** A displaced farm operation, defined in WAC 468-100-002(9), may choose a fixed payment in lieu of a payment for actual moving and related expenses in an amount equal to its average annual net earnings as computed in accordance with subsection (5) of this section, but not less than one thousand dollars nor more than twenty thousand dollars. In the case of a partial acquisition of land which was a farm operation before the acquisition, the fixed payment shall be made only if the agency determines that:

- (a) The acquisition of part of the land caused the operator to be displaced from the farm operation on the remaining land; or
- (b) The partial acquisition caused a substantial change in the nature of the farm operation.

(4) **Nonprofit organization:** A displaced nonprofit organization may choose a fixed payment of one thousand to twenty thousand dollars in lieu of a payment for actual moving and related expenses if the agency determines that it cannot be relocated without a substantial loss of existing patronage (membership or clientele). A nonprofit organization is assumed to meet this test, unless the agency demonstrates otherwise. Any payment in excess of one thousand dollars must be supported with financial statements for the two twelve-month periods prior to the acquisition. The amount to be used for the payment is the average of two years annual gross revenues less administrative expenses.

(5) **Average annual net earnings of a business or farm operation:** The average annual net earnings of a business or farm operation are one-half of its net earnings before federal, state, and local income taxes during the two taxable years immediately prior to the taxable year in which it was displaced. If the business or farm was not in operation for the full two taxable years prior to displacement, net earnings shall be based on the actual period of operation at the displacement site during the two taxable years prior to displacement, projected to an annual rate. Average annual net earnings may be based upon a different period of time when the agency determines it to be more equitable. Net earnings include any compensation obtained from the business or farm operation by its owner, the owner's spouse, and dependents. The displaced person shall furnish the agency proof of net earnings through income tax returns, certified financial statements, or other reasonable evidence which the agency determines is satisfactory.

[Statutory Authority: Chapter 8.26 RCW. 89-17-048 (Order 121), § 468-100-304, filed 8/14/89, effective 9/14/89.]

[Title 468 WAC—p. 126]

WAC 468-100-305 Ineligible moving and related expenses. A displaced person is not entitled to payment for:

- (1) The cost of moving any structure or other real property improvement in which the displaced person reserved ownership. However, this section does not preclude the computation under WAC 468-100-401 (3)(d)(iii); or
- (2) Interest on a loan to cover moving expenses; or
- (3) Loss of goodwill; or
- (4) Loss of profits; or
- (5) Loss of trained employees; or
- (6) Any additional operating expenses of a business or farm operation, incurred because of operating in a new location except as provided in WAC 468-100-306 (1)(j); or
- (7) Personal injury; or
- (8) Any legal fee or other cost for preparing a claim for a relocation payment or for representing the claimant before the agency; or
- (9) Expenses for searching for a replacement dwelling; or
- (10) Physical changes to the real property at the replacement location of a business or farm operation, except as provided in WAC 468-100-303 (1)(b)(iii) and (iv); or
- (11) Costs for storage of personal property on real property already owned or leased by the displaced person.

[Statutory Authority: Chapter 8.26 RCW. 89-17-048 (Order 121), § 468-100-305, filed 8/14/89, effective 9/14/89.]

WAC 468-100-306 Reestablishment expenses—Non-residential moves. In addition to the payments available under WAC 468-100-303, a small business, as defined in WAC 468-100-002(16), farm or nonprofit organization may be eligible to receive a payment, not to exceed ten thousand dollars, for expenses actually incurred in relocating and reestablishing such small business, farm, or nonprofit organization at a replacement site.

(1) Eligible expenses. Reestablishment expenses must be reasonable and necessary, as determined by the agency. They may include, but are not limited to, the following:

(a) Repairs or improvements to the replacement real property as required by federal, state, or local law, code, or ordinance.

(b) Modifications to the replacement property to accommodate the business operation or make replacement structures suitable for conducting the business.

(c) Construction and installation costs for exterior signing to advertise the business.

(d) Provision of utilities from right of way to improvements on the replacement site.

(e) Redecoration or replacement of soiled or worn surfaces at the replacement site, such as paint, panelling, or carpeting.

(f) Licenses, fees, and permits when not paid as part of moving expenses.

(g) Feasibility surveys, soil testing and marketing studies.

(h) Advertisement of replacement location.

(i) Professional services in connection with the purchase or lease of a replacement site.

(j) Increased costs of operation during the first two years at the replacement site for such items as:

- (i) Lease or rental charges;
 - (ii) Personal or real property taxes;
 - (iii) Insurance premiums; and
 - (iv) Utility charges, excluding impact fees.
- (k) Impact fees or one-time assessments for anticipated heavy utility usage.

(l) Other items that the agency considers essential to the reestablishment of the business.

(m) Expenses in excess of the regulatory maximums set forth in (c), (h) and (j) of this subsection may be considered eligible if large and legitimate disparities exist between costs of operation at the displacement site and costs of operation at an otherwise similar replacement site. In such cases the regulatory limitation for reimbursement of such costs may, at the request of the agency, be waived by the agency funding the program or project, but in no event shall total costs payable under this section exceed the ten thousand dollar statutory maximum.

(2) Ineligible expenses. The following is a nonexclusive listing of reestablishment expenditures not considered to be reasonable, necessary, or otherwise eligible:

(a) Purchase of capital assets, such as, office furniture, filing cabinets, machinery, or trade fixtures.

(b) Purchase of manufacturing materials, production supplies, product inventory, or other items used in the normal course of the business operation.

(c) Interior or exterior refurbishments at the replacement site which are for aesthetic purposes, except as provided in WAC 468-100-306 (1)(e).

(d) Interest on money borrowed to make the move or purchase the replacement property.

(e) Payment to a part-time business in the home which does not contribute materially to the household income.

[Statutory Authority: Chapter 8.26 RCW and WSR 89-17-048 (Order 121), 01-02-027, § 468-100-306, filed 12/22/00, effective 1/22/01. Statutory Authority: Chapter 8.26 RCW, 89-17-048 (Order 121), § 468-100-306, filed 8/14/89, effective 9/14/89.]

SUBPART E

REPLACEMENT HOUSING PAYMENTS

WAC 468-100-401 Replacement housing payment for one hundred eighty-day homeowner-occupants. (1)

Entitlement: A displaced person is entitled to the replacement housing payment for a one hundred eighty-day homeowner-occupant if the person:

(a) Has actually owned and occupied the displacement dwelling for not less than the one hundred eighty days immediately prior to the initiation of negotiations; and

(b) Purchases and occupies a DSS replacement dwelling within one year after the later of:

(i) The date the person receives final payment for the displacement dwelling or, in the case of condemnation, the date the required amount is deposited in the court; or

(ii) The date the person moves from the displacement dwelling.

(2) **Amount of payment:** The replacement housing payment for an eligible one hundred eighty-day homeowner-occupant may not exceed twenty-two thousand five hundred dollars. The payment under this section is limited to the

(2001 Ed.)

amount necessary to relocate to a comparable replacement dwelling within one year from the date the displaced homeowner-occupant is paid for the displacement dwelling, or the date such person is initially offered a comparable replacement dwelling, whichever is later. The payment shall be the sum of:

(a) The amount by which the cost of a replacement dwelling exceeds the acquisition cost of the displacement dwelling (price differential), as determined in accordance with subsection (3) of this section; and

(b) The increased interest costs and other debt service costs to be incurred in connection with the mortgage(s) on the replacement dwelling (increased mortgage interest cost), as determined in accordance with subsection (4) of this section; and

(c) The necessary and reasonable expenses incidental to the purchase of the replacement dwelling (incidental purchase expense), as determined in accordance with subsection (5) of this section.

(3) Price differential:

(a) **Determination of price differential:** The price differential to be paid under subsection (2)(a) of this section is the amount which must be added to the acquisition cost of the displacement dwelling to provide a total amount equal to the lesser of:

(i) The reasonable cost of a comparable replacement dwelling as determined in accordance with WAC 468-100-403(1); or

(ii) The purchase price of the DSS replacement dwelling actually purchased and occupied by the displaced person.

(b) **Mixed-use and multifamily properties:** If the displacement dwelling was part of a property that contained another dwelling unit and/or space used for nonresidential purposes, and/or is located on a tract larger than a site that is typical for residential purposes, only that portion of the acquisition payment which is actually attributable to the displacement dwelling shall be considered its acquisition cost when computing the price differential.

(c) **Insurance proceeds:** To the extent necessary to avoid duplicate compensation, the amount of any insurance proceeds received by a person in connection with a loss to the displacement dwelling due to a catastrophic occurrence (fire, flood, etc.,) shall be included in the acquisition cost of the displacement dwelling when computing the price differential. (Also see WAC 468-100-003.)

(d) **Owner retention/salvage of displacement dwelling:** If the owner retains ownership of, or obtains salvage rights to, the person's dwelling, moves it from the displacement site, and reoccupies it on a replacement site, the purchase price of the replacement dwelling shall be the sum of:

(i) The cost of moving and restoring the dwelling to retain the functional utility it had when situated on the displacement site; and

(ii) The cost of making the unit a DSS replacement dwelling (defined in WAC 468-100-002(6)); and

(iii) The current fair market value for residential use of the replacement site (based on any reasonable evaluation method determined by the agency), unless the claimant

rented the displacement site and there is a reasonable opportunity for the claimant to rent a suitable replacement site; and

(iv) The retention/salvage value of the displacement dwelling, as determined from the acquisition of the displacement dwelling.

(e) **Owner constructs replacement dwelling:** If the owner obtains a DSS replacement dwelling by contracting for or otherwise obtaining new construction, the purchase price of the replacement dwelling shall be the sum of:

(i) The cost necessary to construct a dwelling that is comparable to the displacement dwelling; and

(ii) The current fair market value for residential use of the replacement site (based on any reasonable evaluation method determined by the agency), unless the claimant rented the displacement site and there is a reasonable opportunity for the claimant to rent a suitable replacement site.

(4) Increased mortgage interest costs:

(a) The displacing agency shall determine the factors to be used in computing the amount to be paid to a displaced person under subsection (2)(b) of this section. The payment for increased mortgage interest costs shall be the amount which will reduce the mortgage balance on a new mortgage to an amount which could be amortized with the same monthly payment for principal and interest as that for the mortgage(s) on the displacement dwelling. In addition, payments shall include other debt service costs, if not paid as incidental costs, and shall be based only on bona fide mortgages that were valid liens on the displacement dwelling for at least one hundred eighty days prior to the initiation of negotiations. (b) through (f) of this subsection shall apply to the computation of the increased mortgage interest costs payment, which payment shall be contingent upon a mortgage being placed on the replacement dwelling.

(b) The payment shall be based on the unpaid mortgage balance(s) on the displacement dwelling; however, in the event the person obtains a smaller mortgage than the mortgage balance(s) computed in the buydown determination the payment will be prorated and reduced accordingly.

In the case of a home equity loan the unpaid balance shall be that balance which existed one hundred eighty days prior to the initiation of negotiations or the balance on the date of acquisition, whichever is less.

(c) The payment shall be based on the remaining term of the mortgage(s) on the displacement dwelling or the term of the new mortgage, whichever is shorter.

(d) The interest rate on the new mortgage used in determining the amount of the payment shall not exceed the prevailing fixed interest rate for conventional mortgages currently charged by mortgage lending institutions in the area in which the replacement dwelling is located.

(e) Purchaser's points and loan origination or assumption fees, but not seller's points, shall be paid to the extent:

(i) They are not paid as incidental expenses;

(ii) They do not exceed rates normal to similar real estate transactions in the area;

(iii) The agency determines them to be necessary; and

(iv) The computation of such points and fees shall be based on the unpaid mortgage balance on the displacement dwelling, less the amount determined for the reduction of such mortgage balance under this section.

(f) The displaced person shall be advised of the approximate amount of this payment and the conditions that must be met to receive the payment as soon as the facts relative to the person's current mortgage(s) are known and the payment shall be made available at or near the time of closing on the replacement dwelling in order to reduce the new mortgage as intended.

(5) **Incidental purchase expenses:** The incidental purchase expenses to be paid for a one hundred eighty-day homeowner-occupant (under subsection (2)(c) of this section) or for downpayment assistance (under WAC 468-100-402 (3)(a)) are those necessary and reasonable costs actually incurred by the displaced person incident to the purchase of a replacement dwelling, and customarily paid by the buyer, including and are limited by such costs based on the cost of a comparable replacement dwelling pursuant to WAC 468-100-403(1):

(a) Legal, closing, and related costs, including those for title search, preparing conveyance instruments, notary fees, preparing surveys and plats, and recording fees.

(b) Lender, FHA, or VA application and appraisal fees.

(c) Loan origination or assumption fees that do not represent prepaid interest.

(d) Certification of structural soundness and termite inspection when required.

(e) Credit report.

(f) Owner's and mortgagee's evidence of title, e.g., title insurance.

(g) Escrow agent's fee.

(h) State revenue or documentary stamps, sales or transfer taxes.

(i) Such other costs as the agency determines to be incidental to the purchase.

(6) **Rental assistance payment for one hundred eighty-day homeowner:** A one hundred eighty-day homeowner-occupant who is eligible for a replacement housing payment under subsection (1) of this section but elects to rent a replacement dwelling, is eligible for a rental assistance payment not to exceed five thousand two hundred fifty dollars, computed and disbursed in accordance with WAC 468-100-402(2).

[Statutory Authority: Chapter 8.26 RCW. 89-17-048 (Order 121), § 468-100-401, filed 8/14/89, effective 9/14/89.]

WAC 468-100-402 Replacement housing payment for ninety-day occupants. (1) **Entitlement:** A tenant or owner-occupant displaced from a dwelling is entitled to a payment not to exceed five thousand two hundred fifty dollars for rental assistance, as computed in accordance with subsection (2) of this section, or downpayment assistance, as computed in accordance with subsection (3) of this section, if such displaced person:

(a) Has actually and lawfully occupied the displacement dwelling for at least ninety days immediately prior to the initiation of negotiations; and

(b) Has rented, or purchased, and occupied a DSS replacement dwelling within one year (unless the agency extends this period for good cause) after:

(i) For a tenant, the date the tenant moves from the displacement dwelling; or

(ii) For an owner-occupant, the later of:

(A) The date the owner-occupant receives final payment for the displacing interest, or in the case of condemnation, the date the required amount is deposited with the court; or

(B) The date the owner-occupant moves from the displacement dwelling.

(2) Rental assistance payment:

(a) **Amount of payment:** An eligible displaced person who rents a replacement dwelling is entitled to a payment not to exceed five thousand two hundred fifty dollars for rental assistance. (See also WAC 468-100-403(2).) Such payment shall be forty-two times the amount obtained by subtracting the base monthly rent or the fair market rent (in accordance with (b) of this subsection) of the displacement dwelling for a reasonable period prior to displacement, as determined by the agency, from the lessor of:

(i) The monthly rent and average monthly cost of utilities for a comparable replacement dwelling; or

(ii) The monthly rent and estimated average monthly utilities for the DSS replacement dwelling actually occupied by the displaced person.

(b) Base monthly rental for displacement dwelling. The base monthly rental for the displacement dwelling is the lesser of:

(i) The average monthly cost for rent and utilities at the displacement dwelling for a reasonable period prior to displacement, as determined by the agency. (For an owner-occupant, use the fair market rent for the displacement dwelling. For a tenant who paid little or no rent for the displacement dwelling, use the fair market rent, unless its use would result in a hardship because of the person's income or other circumstances); or

(ii) Thirty percent of the person's average gross household income. (If the person refuses to provide appropriate evidence of income or is a dependent, the base monthly rental shall be established solely on the criteria in (b)(i) of this subsection. A full time student or resident of an institution may be assumed to be a dependent, unless the person demonstrates otherwise.)

(iii) The total of the amounts designated for shelter and utilities if receiving a welfare assistance payment from a program that designates the amounts for shelter and utilities.

(c) **Manner of disbursement:** A rental assistance payment may, at the agency's discretion, be disbursed in either a lump sum or in installments. However, except as limited by WAC 468-100-403(7), the full amount vests immediately, whether or not there is any later change in the person's income or rent, or in the condition or location of the person's housing.

(3) Downpayment assistance payment:

(a) **Amount of payment:** An eligible displaced person who purchases a replacement dwelling is entitled to a downpayment assistance payment in the amount the person would receive under subsection (2) of this section if the person rented a comparable replacement dwelling. At the discretion of the agency, a downpayment assistance payment may be increased to any amount not to exceed five thousand two hundred fifty dollars. However, the payment to a displaced homeowner shall not exceed the amount the owner would receive under WAC 468-100-401(2) if he or she met the one

hundred eighty-day occupancy requirement. An agency's discretion to provide the maximum payment shall be exercised in a uniform and consistent manner, so that eligible displaced persons in like circumstances are treated equally. A displaced person eligible to receive a payment as a one hundred eighty-day owner-occupant under WAC 468-100-401(1) is not eligible for this payment.

(b) **Application of payment:** The full amount of the replacement housing payment for downpayment assistance must be applied to the purchase price of the replacement dwelling and related incidental expenses.

[Statutory Authority: Chapter 8.26 RCW. 89-17-048 (Order 121), § 468-100-402, filed 8/14/89, effective 9/14/89.]

WAC 468-100-403 Additional rules governing replacement housing payments. (1) Determining cost of comparable replacement dwelling: The upper limit of a replacement housing payment shall be based on the cost of a comparable replacement dwelling (defined in WAC 468-100-002(4)).

(a) **Three-comparable method:** If available, at least three comparable replacement dwellings (defined in WAC 468-100-002(4)) shall be examined and the payment computed on the basis of the dwelling most nearly representative of, and equal to, or better than, the displacement dwelling. An adjustment shall be made to the asking price of any dwelling, to the extent justified by local market data (see also WAC 468-100-205 (1)(b)). An obviously overpriced or underpriced dwelling may be ignored.

(b) **Major exterior attribute:** If the site of the comparable replacement dwelling lacks a major exterior attribute of the displacement dwelling site (e.g., the site is significantly smaller or does not contain a swimming pool), the value of such attribute shall be subtracted from the acquisition cost of the displacement dwelling for purposes of computing the replacement housing payment.

(c) **Remainder offer:** If the acquisition of a portion of a typical residential property causes the displacement of the owner from the dwelling and the remainder is a remnant of the displacement dwelling site or a buildable residential lot, the agency may offer to purchase that remainder. If such an offer is made and the owner refuses to sell the remainder to the agency, the value attributable to that remainder, shall be added to the acquisition price paid for the displacement dwelling for purposes of computing the price differential.

(d) **Location:** Comparable replacement dwellings shall be selected preferably from the neighborhood in which the displacement dwelling was located or, if not otherwise feasible, from nearby or similar neighborhoods where housing costs are generally the same as in the displacement neighborhood. Where that is not possible dwellings may be selected from neighborhoods where housing costs are the same or higher.

(2) **Applicability of last resort housing:** Whenever a twenty-two thousand five hundred dollar replacement housing payment under WAC 468-100-401 or a five thousand two hundred fifty dollar replacement housing payment under WAC 468-100-402 would be insufficient to ensure that a comparable replacement dwelling is available on a timely

basis to a person, the agency shall provide additional or alternative assistance under the last resort housing provisions in WAC 468-100-601 and 468-100-602, which may include increasing the replacement housing payment so that a replacement dwelling is within the displaced person's financial means as described in subsection (1)(g) of this section.

(3) **Inspection of replacement dwelling:** Before making a replacement housing payment or releasing a payment from escrow, the agency or its designated representative shall inspect the replacement dwelling and determine whether it is a DSS dwelling as defined in WAC 468-100-002(6).

(4) **Purchase of replacement dwelling:** A displaced person is considered to have met the requirement to purchase a replacement dwelling, if the person:

(a) Purchases a dwelling; or

(b) Purchases and rehabilitates a substandard dwelling;

or

(c) Relocates a dwelling which the person owns or purchases; or

(d) Constructs a dwelling on a site the person owns or purchases; or

(e) Contracts for the purchase or construction of a dwelling on a site provided by a builder or on a site the person owns or purchases; or

(f) Currently owns a previously purchased dwelling and site, valuation of which shall be on the basis of current fair market value.

(5) **Occupancy requirements for displacement or replacement dwelling:** No person shall be denied eligibility for a replacement housing payment solely because the person is unable to meet the occupancy requirements set forth in this chapter for a reason beyond the person's control, including:

(a) A disaster, an emergency, or an imminent threat to the public health or welfare, as determined by the funding agency; or

(b) Another reason, such as a delay in the construction of the replacement dwelling, military reserve duty, or hospital stay, as determined by the agency.

(6) **Conversion of payment:** A displaced person who initially rents a replacement dwelling and receives a rental assistance payment under WAC 468-100-402(2) is eligible to receive a payment under WAC 468-100-401 or 468-100-402(3) if the person meets the eligibility criteria for such payments, including purchase and occupancy within the prescribed one-year period. Any portion of the rental assistance payment that has been disbursed shall be deducted from the payment computed under WAC 468-100-401 or 468-100-402(3).

(7) **Payment after death:** A replacement housing payment is personal to the displaced person and upon the person's death the undisbursed portion of any such payment shall not be paid to the heirs or assigns, except that:

(a) The amount attributable to the displaced person's period of actual occupancy of the replacement housing shall be paid.

(b) The full payment shall be disbursed in any case in which a member of a displaced family dies and the other family member(s) continue to occupy a DSS replacement dwelling.

[Title 468 WAC—p. 130]

(c) Any portion of a replacement housing payment necessary to satisfy the legal obligation of an estate in connection with the selection of a replacement dwelling by or on behalf of a deceased person shall be disbursed to the estate.

[Statutory Authority: Chapter 8.26 RCW. 89-17-048 (Order 121), § 468-100-403, filed 8/14/89, effective 9/14/89.]

SUBPART F MOBILE HOMES

WAC 468-100-501 Applicability. WAC 468-100-501 through 468-100-505 describes the requirements governing the provision of relocation payments to a person displaced from a mobile home and/or mobile homesite who meets the basic eligibility requirements of this chapter. Except as modified by WAC 468-100-501 through 468-100-505, such a displaced person is entitled to a moving expense payment in accordance with WAC 468-100-301 through 468-100-306 and a replacement housing payment in accordance with WAC 468-100-401 through 468-100-403 to the same extent and subject to the same requirements as persons displaced from conventional dwellings.

[Statutory Authority: Chapter 8.26 RCW. 89-17-048 (Order 121), § 468-100-501, filed 8/14/89, effective 9/14/89.]

WAC 468-100-502 Moving and related expenses—Mobile homes. A tenant or owner-occupant displaced from a mobile home or mobile homesite is entitled to a payment for the cost of moving his or her personal property on an actual cost basis in accordance with WAC 468-100-301 or, as an alternative, on the basis of a fixed payment under WAC 468-100-302. (However, if the mobile home is not acquired but the owner obtains a replacement housing payment under one of the circumstances described in WAC 468-100-503(3), the owner is not eligible for payment for moving the mobile home.) The following apply to payments for actual moving expenses under WAC 468-100-301:

(1) A displaced mobile homeowner, who moves the mobile home to a replacement site, is eligible for the necessary and reasonable cost of disassembling, moving, and reassembling any attached appurtenances (such as porches, decks, skirting, and awnings) which were not acquired, anchoring of the unit, and utility "hook-up" charges.

(2) If a mobile home requires repairs and/or modifications so that it can be moved and/or made decent, safe, and sanitary, and the agency determines that it would be practical to relocate it, the reasonable cost of such repairs and/or modifications is reimbursable.

(3) A nonreturnable mobile home park entrance fee is reimbursable, to the extent it does not exceed the fee at a comparable mobile home park, if the person is displaced from a mobile home park or the agency determines that payment of the fee is necessary to effect relocation.

[Statutory Authority: Chapter 8.26 RCW. 89-17-048 (Order 121), § 468-100-502, filed 8/14/89, effective 9/14/89.]

WAC 468-100-503 Replacement housing payment for one hundred eighty-day mobile home owner-occupants. A displaced owner-occupant of a mobile home is enti-

(2001 Ed.)

to a replacement housing payment, not to exceed twenty-two thousand five hundred dollars under WAC 468-100-401 if:

(1) The person both owned the displacement mobile home and occupied it on the displacement site for at least the one hundred eighty days immediately prior to the initiation of negotiations;

(2) The person meets the other basic eligibility requirements in WAC 468-100-401(1); and

(3) The agency acquires the mobile home and/or mobile homesite or the mobile home is not acquired by the agency but the owner is displaced from the mobile home because the agency determines that the mobile home:

(a) Is not and cannot economically be made decent, safe, and sanitary; or

(b) Cannot be relocated without substantial damage or unreasonable cost; or

(c) Cannot be relocated because there is no available comparable replacement site; or

(d) Cannot be relocated because it does not meet mobile home park entrance requirements.

If the mobile home is not actually acquired, but the agency determines that it is not practical to relocate it, the acquisition cost of the displacement dwelling used when computing the price differential amount, described in WAC 468-100-401(3), shall include the salvage value or trade-in value of the mobile home, whichever is higher.

[Statutory Authority: Chapter 8.26 RCW. 89-17-048 (Order 121), § 468-100-503, filed 8/14/89, effective 9/14/89.]

WAC 468-100-504 Replacement housing payments for ninety-day mobile home occupants. A displaced tenant or owner-occupant of a mobile home is eligible for a replacement housing payment, not to exceed five thousand two hundred fifty dollars, under WAC 468-100-402 if:

(1) The person actually occupied the displacement mobile home on the displacement site for at least the ninety days immediately prior to the initiation of negotiations;

(2) The person meets the other basic eligibility requirements in WAC 468-100-402(1); and

(3) The agency acquires the mobile home and/or mobile homesite, or the mobile home is not acquired by the agency but the owner or tenant is displaced from the mobile home because of one of the circumstances described in WAC 468-100-503(3).

[Statutory Authority: Chapter 8.26 RCW. 89-17-048 (Order 121), § 468-100-504, filed 8/14/89, effective 9/14/89.]

WAC 468-100-505 Additional rules governing relocation payment to mobile home occupants. (1) **Replacement housing payment based on dwelling and site:** Both the mobile home and mobile homesite must be considered when computing a replacement housing payment. For example, a displaced mobile home occupant may have owned the displacement mobile home and rented the site or may have rented the displacement mobile home and owned the site. Also a person may elect to purchase a replacement mobile home and rent a replacement site, or rent a replacement mobile home and purchase a replacement site. In such cases,

(2001 Ed.)

the total replacement housing payment shall consist of a payment for a dwelling and a payment for a site, each computed under the applicable section in WAC 468-100-401 through 468-100-403. However, the total replacement housing payment under WAC 468-100-401 through 468-100-403 shall not exceed the maximum payment (either twenty-two thousand five hundred dollars or five thousand two hundred fifty dollars) permitted under the subsection that governs the computation for the dwelling. (See also WAC 468-100-403(2).)

(2) Cost of comparable replacement dwelling:

(a) If a comparable replacement mobile home is not available, the replacement housing payment shall be computed on the basis of the reasonable cost of a conventional comparable replacement dwelling.

(b) If the agency determines that it would be practical to relocate the mobile home, but the owner-occupant elects not to do so, the agency may determine that, for purposes of computing the price differential under WAC 468-100-401(3), the cost of a comparable replacement dwelling is the sum of:

(i) The value of the mobile home;

(ii) The cost of any necessary repairs or modifications; and

(iii) The estimated cost of moving the mobile home to a replacement site.

(3) **Initiation of negotiations:** If the mobile home is not actually acquired, but the occupant is considered displaced under this chapter, the "initiation of negotiations" is the date of initiation of negotiations to acquire the land, or, if the land is not acquired, the date of the written notification that the occupant is a displaced person under this chapter.

(4) **Person moves mobile home:** If the owner is reimbursed for the cost of moving the mobile home under this chapter, the owner is not eligible to receive a replacement housing payment to assist in purchasing or renting a replacement mobile home. The owner may, however, be eligible for assistance in purchasing or renting a replacement site.

(5) **Partial acquisition of mobile home park:** The acquisition of a portion of a mobile home park property may leave a remaining part of the property that is not adequate to continue the operation of the park. If the agency determines that a mobile home located in the remaining part of the property must be moved as a direct result of the project, the owner and any tenant shall be considered a displaced person who is entitled to relocation payments and other assistance under this chapter.

(6) **General provisions:** WAC 468-100-403 also applies.

[Statutory Authority: Chapter 8.26 RCW. 89-17-048 (Order 121), § 468-100-505, filed 8/14/89, effective 9/14/89.]

SUBPART G LAST RESORT HOUSING

WAC 468-100-601 Applicability. (1) **Basic determination to provide last resort housing:** A person cannot be required to move from the person's dwelling unless at least one comparable replacement dwelling is made available to the person. Whenever an agency determines that a replacement housing payment under WAC 468-100-401 through

[Title 468 WAC—p. 131]

468-100-403 would not be sufficient to provide a comparable replacement dwelling on a timely basis to the person, the agency is authorized to take appropriate cost-effective measures under WAC 468-100-601 and 468-100-602 to provide such a dwelling. The agency's obligation to ensure that a comparable replacement dwelling is available shall be met when such a dwelling, or assistance necessary to provide such a dwelling, is offered under the provisions of WAC 468-100-601 and 468-100-602.

(2) Basic rights of persons to be displaced:

(a) The provisions of WAC 468-100-601 and 468-100-602 do not deprive any displaced person of any rights the person may have under chapter 8.26 RCW or any implementing regulations. The agency shall not require any displaced person to accept a dwelling provided by the agency under the procedures in WAC 468-100-601 and 468-100-602 (unless the agency and the displaced person have entered into a contract to do so) in lieu of any acquisition payment or any relocation payment for which the person may otherwise be eligible. A one hundred eighty-day homeowner-occupant who is eligible for a payment under WAC 468-100-401 is entitled to a reasonable opportunity to purchase a comparable replacement dwelling.

(b) The actual amount of assistance shall be limited to the amount necessary to relocate to a comparable replacement dwelling within one year from the date the displaced homeowner-occupant is paid for the displacement dwelling or the date the person is initially offered a comparable replacement dwelling, whichever is later.

(c) The agency is not required to provide persons owning only a fractional interest in the displacement dwelling a greater level of assistance to purchase a replacement dwelling than the agency would be required to provide such persons if they owned fee simple title to the displacement dwelling. If such assistance is not sufficient to buy a replacement dwelling, the agency may provide additional purchase assistance or rental assistance.

[Statutory Authority: Chapter 8.26 RCW, 89-17-048 (Order 121), § 468-100-601, filed 8/14/89, effective 9/14/89.]

WAC 468-100-602 Methods of providing replacement housing. Agencies shall have broad latitude in implementing WAC 468-100-601 and 468-100-602, but implementation shall be on a reasonable cost-effective basis.

(1) The methods of providing last resort housing include, but are not limited to:

(a) Rehabilitation of and/or additions to an existing replacement dwelling.

(b) The construction of a new replacement dwelling.

(c) The provision of a direct loan, which requires regular amortization or deferred repayment. The loan may be unsecured or secured by the real property. The loan may bear interest or be interest free.

(d) A replacement housing payment in excess of the limits set forth in WAC 468-100-401 or 468-100-402. A rental assistance subsidy under WAC 468-100-601 and 468-100-602 may be provided in installments or in a lump sum.

(e) The relocation and, if necessary, rehabilitation of a dwelling.

[Title 468 WAC—p. 132]

(f) The purchase of land and/or a replacement dwelling by the displacing agency and subsequent sale or lease to, or exchange with, a displaced person.

(g) The removal of barriers to the handicapped.

(h) The change in status of the displaced person from tenant to homeowner when it is more cost-effective to do so, as in cases where a downpayment may be less expensive than a last resort rental assistance payment.

(2) Under special circumstances, modified methods of providing housing of last resort permit consideration of:

(a) Replacement housing based on space and physical characteristics different from those in the displacement dwelling.

(b) Upgraded, but smaller replacement housing that is decent, safe, and sanitary and adequate to accommodate individuals or families displaced from marginal or substandard housing with probable functional obsolescence.

(c) The financial means of a displaced person who is not eligible to receive a replacement housing payment because of failure to meet length-of-occupancy requirements when comparable replacement rental housing is not available at rental rates within thirty percent of the person's gross monthly household income.

[Statutory Authority: Chapter 8.26 RCW, 89-17-048 (Order 121), § 468-100-602, filed 8/14/89, effective 9/14/89.]

Chapter 468-105 WAC

PUBLIC ADVISORY ELECTIONS FOR SELECTED STATE TRANSPORTATION FACILITIES

WAC

468-105-010	General.
468-105-020	Definitions.
468-105-030	Determination of initial affected project area.
468-105-040	Local involvement committee.
468-105-050	Establishing affected project area.
468-105-060	Project description.
468-105-070	Public advisory elections.
468-105-080	Public advisory election results.

WAC 468-105-010 General. These administrative rules were developed pursuant to RCW 47.46.030 (3) through (11) concerning public advisory elections conducted within an affected project area by the county auditors for the purpose of advising the department on the public support or opposition to the imposition of tolls to finance a proposed project pursuant to chapter 47.46 RCW, Public-Private Initiatives Transportation Act.

[Statutory Authority: RCW 47.46.030 (3)-(11), 96-03-107, § 468-105-010, filed 1/23/96, effective 2/23/96.]

WAC 468-105-020 Definitions. For the purpose of implementing RCW 47.46.030 (3) through (11) relative to the process for conducting public advisory elections on selected transportation facilities, the following definitions apply:

(1) "Affected project area" means a geographic area of the state impacted by the imposition of tolls or user fees that is defined and established by the department following a public comment period and a recommendation by the public private local involvement committee. The affected project area

is a geographic portion of the state which is depicted in a map.

(2) "City" means any jurisdiction formed under Titles 35 and 35A RCW including any first class city (RCW 35.01.010), second class city (RCW 35.01.020), town (RCW 35.01.040) or code city (RCW 35A.01.035).

(3) "County auditor" shall have the same meaning as provided in RCW 29.01.043.

(4) "Department" means the Washington state department of transportation.

(5) "Initial affected project area" means a geographic area of the state that is defined by the department as a result of a comprehensive analysis of traffic patterns and economic impacts created by the imposition of tolls or user fees to finance a proposed project.

(6) "Local involvement committee (LIC)" means an advisory committee officially named the "public private local involvement committee" which will be established for each proposed project. The LIC will serve in an advisory capacity on all functions and responsibilities of the department in the conduct of the public advisory election.

(7) "Project description" means a written description of the proposed project that is prepared by the department in consultation with the LIC. The project description is a statement of the essential elements of the proposed project.

(8) "Project developer" means a private entity submitting a proposed project to improve transportation capital facilities under chapter 47.46 RCW.

(9) "Proposed project" means a conceptual project proposed by one or more project developers which is intended to build or improve transportation capital facilities. The proposed projects are those selected pursuant to chapter 47.46 RCW which have organized opposition as demonstrated by the submission to the department of original petitions bearing at least five thousand signatures of individuals opposing the proposed project by the deadlines set forth in RCW 47.46.030 (10) and (11).

(10) "Public advisory election" means an election conducted within an affected project area by the county auditor for the purpose of advising the department on the public support or opposition to the imposition of tolls to finance a proposed project.

(11) "Preferred alternative" means a proposed action identified in the draft environmental impact statement developed in chapter 43.21C RCW.

[Statutory Authority: Chapter 47.46 RCW, 97-14-037, § 468-105-020, filed 6/26/97, effective 7/27/97. Statutory Authority: RCW 47.46.030 (3)-(11), 96-03-107, § 468-105-020, filed 1/23/96, effective 2/23/96.]

WAC 468-105-030 Determination of initial affected project area. The department shall define an initial affected project area for proposed projects selected before September 1, 1994, or after June 30, 1997. In order to define the initial affected project area, and pursuant to the requirements of RCW 47.46.030(4), the department shall conduct a comprehensive analysis of traffic patterns and economic impacts to define the geographic area that is affected by the imposition of tolls or user fees.

(2001 Ed.)

(1) **Traffic and economic analysis.** Such analysis shall result in a map depicting the initial affected project area, and shall include, at a minimum:

(a) A comparison of the estimated percentage of residents of communities in the vicinity of the project and in other communities impacted by the project who could be subject to tolls or user fees and the estimated percentage of other users and transient traffic that could be subject to tolls or user fees;

(b) An analysis of the anticipated traffic diversion patterns on local streets, highways and to other transportation services or facilities;

(c) An analysis of the potential economic impact resulting from proposed toll rates or user fee rates imposed on residents, commercial traffic, and commercial entities in communities in the vicinity of and impacted by the project;

(d) An analysis of the economic impact of tolls or user fees on the price of goods and services generally; and

(e) An analysis of the relationship of the project to state transportation needs and benefits.

(2) **Public notification and consultation.** The department shall notify and consult with jurisdictions and interested persons and organizations regarding the studies to be conducted, including the methodology that is developed to collect data and the criteria that is established to recommend the initial affected project area boundary.

(3) **Studies available to public.** The department shall make the studies available to the public including the methodology and criteria used to develop the study recommendations, published reports, raw data, analysis, maps and other information generated by the studies.

(4) **Precinct boundaries.** At the request of the department, the county auditor in any county which is within an initial affected project area shall provide current precinct maps or boundary descriptions to the department. The department shall use the most current precinct maps or boundary descriptions in defining each initial affected project area.

[Statutory Authority: RCW 47.46.030 (3)-(11), 96-03-107, § 468-105-030, filed 1/23/96, effective 2/23/96.]

WAC 468-105-040 Local involvement committee. (1) Creation of the local involvement committee. A public private local involvement committee shall be established for each proposed project. The committee will be known as the local involvement committee or "LIC." Within sixty days after defining the initial affected project area, all appointments to the LIC shall be made and submitted to the department.

(2) **LIC membership.** The LIC membership shall consist of:

(a) One elected official of each county and one elected official from each city lying wholly or in part within the affected project area. Such members shall be appointed by a majority of the members of the county or city legislative authority.

(b) Two persons from each county lying wholly or in part within the affected project area each of whom represents an organization formed in support of the proposed project, if any such organizations exist; and two persons from each

county lying wholly or in part within the affected project area each of whom represents an organization formed to oppose the proposed project, if any such organizations exist. Such members shall be appointed by the county legislative authority. Prior to such appointment, the county legislative authority shall identify and validate organizations officially formed in support of or in opposition to the proposed project. The method of validation shall be devised by the county. Appointments shall be made from list(s) submitted by the chairs of the validated organizations. The county legislative authority shall submit a list of the appointed members in writing to the department.

(c) Four public members active in a state-wide transportation organization who shall be appointed by the governor.

(d) Vacancies in the membership of the LIC shall be filled by the appointing authority under (a) through (c) of this subsection.

(e) If the committee makeup results in an even number of committee members, there shall be an additional appointment of an elected official from the county in which all, or the greatest portion of the proposed project is located.

(3) **Compensation and expenses.** Members of the LIC shall serve without compensation and may not receive reimbursement for subsistence, lodging expenses, or travel expenses from the department.

(4) **LIC duties.** Each LIC will serve in an advisory capacity to the department on all matters related to the administration of the public advisory elections including:

(a) Reviewing the methodology, criteria and recommendations developed in the traffic and economic studies and used by the department to establish the initial affected project area boundary.

(b) Reviewing the initial affected project area boundary and recommending adjustments, if any are deemed desirable, to the geographic boundaries and the LIC membership.

(c) Reviewing the project description that is based upon the preferred alternative selected by the department and recommending changes, if any are deemed desirable, in order for the department to prepare the final project description.

(d) Recommending to the department the date for the public advisory elections that are within those dates established by RCW 29.13.020.

(e) Providing advice on any other matters identified by the department related to the administration of the public advisory election in the affected project areas.

(5) **LIC meeting and procedures.**

(a) LIC meetings shall be open to the public and shall be subject to the requirements of the Open Public Meetings Act, RCW 42.30.030. The public shall have advance notice of LIC meetings as described in LIC procedures established in (b) of this subsection. Meetings shall be held in locations within the affected project areas and be accessible for persons with disabilities.

(b) Within thirty days of the first LIC meeting, each LIC shall develop meeting procedures to include but not be limited to the frequency and location of meetings, alternate members, methods of public notification and public participation at the meetings. Each LIC shall also develop its own method of providing recommendations to the department, provided that all decisions of the LIC shall be made by a sim-

ple majority of the LIC members. A simple majority shall be defined as fifty percent of the members plus one member of the LIC committee.

(c) All LIC meeting summaries, reports, correspondence and other materials are subject to public disclosure pursuant to chapter 42.17 RCW.

(6) **Administrative support to LIC's.** The department shall provide administrative support to the LIC's. Such support shall include notifying members of meetings, providing public notification of meetings, facilitating meetings, arranging for meetings and materials, and other necessary administrative support.

[Statutory Authority: Chapter 47.46 RCW, 97-14-037, § 468-105-040, filed 6/26/97, effective 7/27/97. Statutory Authority: RCW 47.46.030 (3)-(11), 96-03-107, § 468-105-040, filed 1/23/96, effective 2/23/96.]

WAC 468-105-050 Establishing affected project area. (1) **Public comment on initial affected project area.** The department shall conduct a minimum thirty-day public comment period on the definition of each initial affected project area boundary.

(2) **LIC recommendation on affected project area.** The LIC shall review the public comments. The LIC shall recommend adjustments to the geographic boundary of the initial affected project area based upon the public comment. Adjustments to the geographic boundary shall be established by precinct. The LIC may also recommend adjustments to the membership of the LIC based upon any recommended boundary adjustments.

(3) **Final boundaries of affected project area.** Within fourteen calendar days after the close of the public comment period and a recommendation from the LIC, the department shall establish the final boundaries of the affected project area in units no smaller than a precinct as defined in RCW 29.01.120.

[Statutory Authority: Chapter 47.46 RCW, 97-14-037, § 468-105-050, filed 6/26/97, effective 7/27/97. Statutory Authority: RCW 47.46.030 (3)-(11), 96-03-107, § 468-105-050, filed 1/23/96, effective 2/23/96.]

WAC 468-105-060 Project description. (1) **Proposed project description.** A draft project description shall be developed by the department based upon the preferred alternative.

(2) **LIC recommendation on project description.** The department shall provide the project description to the LIC. The LIC shall recommend changes to the content of the project description, if any, so that the department may prepare the final project description.

(3) **Publication of project description.** The department shall publish the project description in newspapers of general circulation in each county lying in whole or in part within the affected project area for a period of seven calendar days.

[Statutory Authority: Chapter 47.46 RCW, 97-14-037, § 468-105-060, filed 6/26/97, effective 7/27/97. Statutory Authority: RCW 47.46.030 (3)-(11), 96-03-107, § 468-105-060, filed 1/23/96, effective 2/23/96.]

WAC 468-105-070 Public advisory elections. (1) **Transmittal to county auditor.** Within fourteen calendar days after the last day of the publication of the project

description, the department shall transmit a letter requesting a public advisory election and a copy of the map depicting the affected project area and the project description to the county auditor of each county in which any portion of the affected project area is located.

(2) **Precinct verification.** Upon receipt of the affected project area map, and the project description, the county auditor shall, within thirty days, verify the precincts that are located within the affected project area.

(3) **Ballot proposition.**

(a) The department shall request the office of the attorney general to prepare the ballot title and summary advising the department on the public support or opposition to the imposition of tolls or user fees to implement the preferred alternative within the affected project area in the same manner and type as those required under RCW 29.79.040 for the public advisory election.

(b) Any registered voter residing within the affected project area who is dissatisfied with the content of the ballot title or summary may appeal to the superior court of Thurston County in the same manner as provided for on state measures in RCW 29.79.060.

(c) Not later than sixty days before the election date, the department shall submit the complete text of the ballot title and summary to the county auditor for the purpose of preparing the voters pamphlet and conducting the public advisory election.

(4) **Election date.** Unless a special election is requested by the department, the public advisory election shall be held at the next succeeding general election to be held in the state. The special election date must be the next date for a special election provided under RCW 29.13.020 that is at least sixty days, but not more than ninety days after the transmittal of the final map of the affected project area, project description, the ballot title and summary to the county auditor under subsection (1) of this section.

(5) **Voters pamphlet.**

(a) The county auditor shall prepare or contract with the secretary of state to prepare the voters pamphlet in the same manner required under chapter 29.81A RCW using the full text of the ballot title, summary, the project description and the geographic boundary of the affected project together with statements for and against the imposition of tolls or user fees to finance the proposed project. Committees to prepare the statements for and against the imposition of tolls to finance the proposed project for the voters pamphlet shall be appointed in the same manner as committees for state measures under RCW 29.81.050. The secretary of state shall transmit committee names and their statements to the county auditors.

(b) The county auditor may consolidate the voters pamphlet on the public advisory election with any other local voters pamphlet that is being produced by the county auditor for an election.

(6) **Reimbursement for election costs.** The department shall reimburse the costs of publication and distribution of information to the voters incurred by the county auditor in the same manner that local election costs are allocated under RCW 29.13.045. The department shall reimburse the county auditor for the cost of an election.

(2001 Ed.)

[Statutory Authority: Chapter 47.46 RCW. 97-14-037, § 468-105-070, filed 6/26/97, effective 7/27/97. Statutory Authority: RCW 47.46.030 (3)-(11). 96-03-107, § 468-105-070, filed 1/23/96, effective 2/23/96.]

WAC 468-105-080 Public advisory election results.

(1) **Canvassing the votes cast on a public advisory election.** Immediately following the certification of the votes cast on the public advisory election by the county canvassing board, the county auditor shall transmit a certified copy of the returns of that special election to the secretary of state in the same manner as provided for state measures in RCW 29.62.090.

(2) **Certification of returns on a public advisory election to the department.** Within three days following the receipt of the certified returns from a special election on a public advisory election, the secretary of state shall accumulate the results from the respective counties and certify the results to the department.

[Statutory Authority: Chapter 47.46 RCW. 97-14-037, § 468-105-080, filed 6/26/97, effective 7/27/97. Statutory Authority: RCW 47.46.030 (3)-(11). 96-03-107, § 468-105-080, filed 1/23/96, effective 2/23/96.]

Chapter 468-200 WAC

CONDUCT AND MANAGEMENT OF EMERGENCY AIR OPERATIONS AIR SEARCH & RESCUE/DISASTER RELIEF

WAC

468-200-020	Purpose and intent.
468-200-040	Scope.
468-200-060	Definitions.
468-200-080	Registration.
468-200-100	Classes of emergency workers.
468-200-110	Conduct of training.
468-200-120	Qualifications of search and rescue emergency workers.
468-200-160	Establishment of state standards.
468-200-180	Responsibilities of authorized officials using emergency workers.
468-200-200	Personal responsibilities of emergency workers.
468-200-220	Conduct of training.
468-200-230	Selection of resources—Mission.
468-200-240	Staffing and conduct of the mission.
468-200-250	Mission number requests.
468-200-260	Participation in training and operational missions.
468-200-280	Unauthorized conduct of search and rescue missions.
468-200-300	Records requirements.
468-200-320	Records repository and retention.
468-200-340	Memorandum of understanding agreements.
468-200-350	Appeal procedure.
468-200-360	Severability.

WAC 468-200-020 Purpose and intent. The purpose of this chapter is to adopt rules pertaining to the use, classes, scope, conditions of duty and training of emergency workers involved in air search and rescue or air disaster relief missions.

Any emergency situation most likely requires multi-agency contact and coordination. To insure a timely and effective response nothing in this chapter is intended to preclude local law enforcement from taking immediate and constructive action. The aviation division will insure that each county sheriff's department is briefed on potential emergencies underway in their jurisdiction.

The intent of these rules is to clearly delineate the responsibilities of authorized officials and emergency workers before, during, and after emergencies, disasters, and other

specific missions conducted under the authority of the Washington state department of transportation, aviation division.

[Statutory Authority: Chapter 47.68 RCW. 96-02-067 (Order 160), § 468-200-020, filed 1/3/96, effective 2/3/96.]

WAC 468-200-040 Scope. This chapter is applicable for emergency activities as outlined in chapter 47.68 RCW, Washington state emergency management comprehensive plan, state and regional disaster airlift plan, or other official state of Washington or political subdivision emergency plans for:

(1) Multijurisdictional or major emergencies, disasters, and related incidents that are determined by appropriate state or local authorities to require the use of aircraft, airships, and crews at the disposal of and trained by the aviation division or its designees and the emergency workers required to crew and support such air operations. Nothing shall preclude local authorities from utilizing local resources to meet local emergencies. At the request of local authorities, even for localized emergencies, the aviation division will coordinate and acquire aviation resources as needed.

(2) Search and rescue missions for aircraft in distress, missing, or presumed down that are conducted under the authority of chapter 47.68 RCW. This does not include air operations conducted for search and rescue purposes under the authority of chapter 38.52 RCW.

(3) Training events authorized by the department of transportation, aviation division.

[Statutory Authority: Chapter 47.68 RCW. 96-02-067 (Order 160), § 468-200-040, filed 1/3/96, effective 2/3/96.]

WAC 468-200-060 Definitions. (1) "Air search & rescue" means the conduct and management of all aerial search and rescue operations involving downed or missing aircraft. This includes aircraft and airships used in search and rescue operations requested through the aviation division. The aviation division is also responsible for search and rescue activities involving electronic signaling devices such as emergency locator transmitters (ELT's) and emergency position indicating radio beacons (EPIRB's). This does not include operations conducted for search and rescue purposes under the authority of chapter 38.52 RCW.

(2) "Disaster relief air operations" means the utilization of aircraft, airships, and crews in the assessment, search & rescue, or mitigation of a disaster.

(3) "Authorized official" means the director of aviation of the department of transportation or designee.

(4) "Authorized organization" means the department of transportation, aviation division, Washington state military department, emergency management division, local emergency management agencies, or law enforcement agencies of political subdivisions.

(5) "Aviation division" means the department of transportation, aviation division.

(6) "Incident" means an occurrence or event, either human caused or natural phenomena, that requires action by emergency services personnel to prevent or minimize loss of life or damage to property and/or the environment.

(7) "Mission" means a distinct assignment of personnel and equipment to achieve a set of tasks related to an incident,

emergency, disasters or search and rescue operation that occurs under the direction and control of an authorized official.

(8) "Training event" means a planned, nonemergency activity for the development, maintenance, or upgrading of emergency worker skills.

(9) "Remote/isolated area" means an area lacking in amenities, paved roads, or public services, most often heavy vegetation and hilly terrain. Also defined as an area in which development is essentially nonexistent except for roads, railroads, power lines, and similar transportation facilities. Anyone leaving a recognized, road network will be considered to be in a remote/isolated area.

(10) "SARDA" means state and regional disaster airlift, a plan that is adopted by the state of Washington, as an integral part of the Washington state comprehensive emergency management plan. SARDA establishes the procedures for the control, conduct, and utilization of aviation during times of major disaster.

[Statutory Authority: Chapter 47.68 RCW. 96-02-067 (Order 160), § 468-200-060, filed 1/3/96, effective 2/3/96.]

WAC 468-200-080 Registration. Registration is a prerequisite for emergency workers involved in the conduct of air search & rescue/disaster relief missions conducted under the authority of this chapter or chapter 47.68 RCW.

(1) Aircraft pilots and observers shall register with the aviation division by completing and filing a form as designated by the aviation division.

(2) Main base support personnel, assigned and working at the aviation division designated incident command post must also be registered with the aviation division.

(3) Ground personnel engaging in search and rescue field activities in remote or isolated locations must be registered emergency workers having complied with the registration requirements of chapter 38.52 RCW and chapter 118-04 WAC.

(4) The information provided during registration may be used by authorized officials to conduct criminal history, flying record, driving record, and background checks.

(5) Failure to truthfully respond to statements set forth on the registration form may result in the denial of registration or revocation of registration.

(6) Registration required under chapter 47.68 RCW and this chapter shall be accomplished by the aviation division on a form supplied or approved by the aviation division. Registration shall be completed upon the successful completion of the required training program as approved by the aviation division.

(a) An employee of the state or of a political subdivision of the state who is required to perform emergency duties as a normal part of their job shall not be required to register.

(b) When such individuals are outside the jurisdiction of their employment during a disaster, emergency, mission or incident, except when acting under the provisions of a mutual aid agreement, they should report to the on-scene authorized official and announce their capabilities and willingness to serve as a volunteer during the emergency or disaster. The on-scene authorized official shall register the individual as a temporary worker.

(c) Employees of the National Park Service, U.S. Forest Service, Bureau of Land Management performing their normal assigned duties in jurisdictions under their control shall not be required to register.

(d) Members of active duty, reserve, or National Guard components of the Department of Defense performing duties while in a "paid duty" status shall not be required to register.

(e) Members of active duty or reserve components of the U.S. Coast Guard performing duties while in a "paid duty" status shall not be required to register.

(f) Temporary registration may be authorized in those emergency situations requiring immediate or on-scene recruiting of volunteers to assist in time-critical or life threatening situations.

[Statutory Authority: Chapter 47.68 RCW. 97-03-064 (Order 167), § 468-200-080, filed 1/13/97, effective 2/13/97; 96-02-067 (Order 160), § 468-200-080, filed 1/3/96, effective 2/3/96.]

WAC 468-200-100 Classes of emergency workers.

The following classes of emergency workers and the scope of duties of each class are hereby established.

(1) Administration personnel includes, but is not limited to, technical, administrative, and clerical services and may involve recruiting, coordinating, and directing any emergency support activities. Workers under this class will normally not perform their duty functions in isolated or remote locations. They are normally assigned to the incident command post, staging areas, or outlying airports.

(2) Pilots include duties performed by pilots licensed by the Federal Aviation Administration, operating Federal Aviation Administration approved aircraft, in support of emergency management activities. Pilots will be required to complete a mission training program conducted or approved by the aviation division.

(3) Observers include those individuals completing an approved training program to perform duties as an aerial observer on emergency missions.

(4) Communications shall include individuals who support airborne emergency response with air to air, air to ground, or ground to ground communications. Individuals in this class who are registered in accordance with chapter 38.52 RCW and chapter 118-04 WAC shall be deemed registered for the purposes of this chapter.

(5) General includes, but is not limited to, duties which can be performed by persons without permanent specific emergency assignment. These emergency workers may include personnel who do not have any specific training or qualifications, but whose participation is essential to a specific emergency operation.

(6) Transportation includes, but is not limited to, the planning, organizing, maintaining, operating, and coordination of available means of transportation for the movement of supplies, evacuees, personnel, and equipment.

(7) Radio beacon (emergency locator transmitter/emergency position indicating radio beacon) or other electronic transmitting device personnel shall include those personnel who respond by various ground and air modes of transportation to locate and silence electronic distress beacons. Personnel who will be working in isolated or remote areas must be

(2001 Ed.)

registered and qualified in accordance with chapter 38.52 RCW and chapter 118-04 WAC.

(8) Aircrew (other) consist of crew members conducting airborne communications, aircraft crew chiefs, and airborne controllers.

[Statutory Authority: Chapter 47.68 RCW. 96-02-067 (Order 160), § 468-200-100, filed 1/3/96, effective 2/3/96.]

WAC 468-200-110 Conduct of training. Organizations wishing to conduct training to meet the requirements of this chapter will submit the following information for consideration and approval prior to conducting training:

(1) A letter requesting to conduct approved training outlining the subject matter for which authorization is sought.

(2) A course outline listing the subject matter to be taught, class objectives, equipment, and audio visual material to be used.

(3) Copies of all hand out material, student work books, and other items that will be distributed.

(4) Written notice of date, location or locations where course is to be taught.

(5) A resume of the instructors background and qualifications.

(6) Such other material as may be instrumental in the aviation division reviewing the proposed training opportunities to insure consistency with the state program.

Applications for instructor/course authorization must be received at least thirty days prior to the course offering. The aviation division will have final approval authority over course content and instructor utilization. The aviation division will prepare, and supply on request, information and guidelines for the selection of instructors, preparation of courses and conduct of training.

[Statutory Authority: Chapter 47.68 RCW. 96-02-067 (Order 160), § 468-200-110, filed 1/3/96, effective 2/3/96.]

WAC 468-200-120 Qualifications of search and rescue emergency workers. Personnel will complete training administered or approved by the aviation division prior to engagement in any search and rescue activities conducted in accordance with chapter 47.68 RCW, this chapter, the state comprehensive emergency management plan (regarding air operations) or the state and regional disaster airlift plan (SARDA).

(1) The following are the basic qualifications for administrative support search and rescue emergency workers:

(a) Be physically and mentally fit for the position assigned.

(b) Possess knowledge and the skills required of air search and rescue support workers.

(c) Possess knowledge of the incident command system and how the system works.

(d) Possess knowledge of the records and forms necessary to administer a major air search operation, including all forms used to identify the mission, track personnel, equipment, and assignments.

(e) Possess knowledge of the various state laws, plans, and procedures used in the conduct of emergency air operations.

(f) Possess knowledge of the requirements utilized in briefing search participants.

(g) Possess knowledge of the requirements and procedures utilized to select and dispatch emergency workers.

(h) Possess knowledge of dealing with the media, news releases, and information flow.

(i) Possess basic knowledge of the various types of maps used in air search and airborne disaster relief.

(j) Possess knowledge and training in dealing with family members of individuals in distressed situations.

(k) Possess knowledge in specific incident command system job descriptions that the individual is assigned to perform.

(2) The following are the basic qualifications for communications personnel:

(a) Be physically and mentally fit for the position assigned.

(b) Possess the knowledge and skills required of air search and rescue support workers.

(c) Possess knowledge of the incident command system and how the system works.

(d) Possess knowledge of the various forms used in the incident command system with particular skills in those forms having to deal with communications.

(e) Possess knowledge of the various state laws, plans, and procedures used in the conduct of emergency air operations.

(f) Possess a Federal Communications Commission radio license for the class and type of equipment operated when the operation of a radio requires an operator license.

(g) For remote or isolated assignments be registered and qualified as an emergency worker in accordance with chapter 118-04 WAC or chapter 38.52 RCW.

(h) Possess knowledge in specific incident command system job descriptions that the individual is assigned to perform.

(3) The following are the basic qualifications for pilots and observers.

(a) Be physically and mentally fit for the position assigned.

(b) Possess the knowledge and skills required of air search and rescue support workers.

(c) Possess knowledge of the incident command system and how the system works.

(d) Possess knowledge of the various forms used in the incident command system with particular skills in those forms having to deal with air operations.

(e) Possess knowledge of the various state laws, plans, and procedures used in the conduct of emergency air operations.

(f) Possess knowledge in specific incident command system job descriptions that the individual is assigned to perform.

(g) Possess knowledge and have training in the following aircrew specific items:

1. Search patterns & electronic search
2. Universal map system (UMS)
3. Navigation & position determination
4. Aircrew coordination
5. Communications procedures

6. Coordination with ground teams

7. Flight line operations

8. Weather

9. High altitude & terrain considerations

10. Mountain flying

11. Scanning techniques

12. Sighting characteristics

13. In-flight emergencies

14. Off-field landings

15. Survival, first aid, & safety

16. Flight plans

17. Incident Forms

18. State & regional disaster airlift (SARDA) & disaster relief plans

19. Reimbursement procedures

20. Dealing with the family and the press.

(4) In addition to the knowledge and skill requirements of 3 above, pilots must meet the following qualifications and skill levels.

(a) Hold a private pilots license or above issued by Federal Aviation Administration.

(b) Hold a current and valid medical certificate issued by a Federal Aviation Administration authorized Airman Medical Examiner (AME).

(c) Meet all recurrency/currency of flight and other restrictions imposed by the Federal Aviation Administration.

(d) Have logged at least two hundred hours of total flight time for flat land (altitudes below five thousand feet) search pilot operations. Have logged at least five hundred hours of total flight time for all other search and rescue assignments.

(e) Have completed flight training with a search pilot instructor appointed or approved by the aviation division.

(5) Ground electronic beacon (emergency locator transmitters & emergency position indicating radio beacon) direction finding personnel will receive training and demonstrate proficiency in the principles of emergency beacon transmitters, proper procedures for direction finding (DF) and legal responsibilities. The training shall consist of at least the following:

(a) Principles of transmission, causes of distortion, interference, and blockage of signals.

(b) DF principles involving hand-held direction finders as well as working with only radio receivers.

(c) Interferometer method of DF.

(d) Map reading and interpretation.

(e) Legal responsibilities and restrictions upon finding a transmitter.

(f) When required be qualified and registered in accordance with chapter 118-04 WAC.

[Statutory Authority: Chapter 47.68 RCW. 96-02-067 (Order 160), § 468-200-120, filed 1/3/96, effective 2/3/96.]

WAC 468-200-160 Establishment of state standards.

Additional state standards may be established for classes of individual emergency workers involved in air search and rescue and air responses to disaster situations. Upon establishment of any such state standards, training programs within the state shall, at a minimum, comply with these standards.

[Statutory Authority: Chapter 47.68 RCW. 97-03-064 (Order 167), § 468-200-160, filed 1/13/97, effective 2/13/97; 96-02-067 (Order 160), § 468-200-160, filed 1/3/96, effective 2/3/96.]

WAC 468-200-180 Responsibilities of authorized officials using emergency workers. (1) Authorized officials using emergency workers have the responsibility to ensure those emergency workers meet basic qualifications as stated in these rules. Authorized officials organizing and using emergency workers are responsible for assembling the proper combination of emergency workers with the skills and abilities to accomplish the mission being undertaken. It is acknowledged that authorized officials must use judgment and experience in assessing the scene and the requirements for the missions.

(2) Authorized officials may also require emergency workers to demonstrate proficiency in the skills required to carry out their assignments.

(3) Authorized officials shall ensure that all emergency workers are aware of their duty to comply with the personal responsibilities contained in WAC 468-200-200. This shall be accomplished at the time of registration with the aviation division and should be reemphasized to the worker at periodic intervals.

(4) The state recognizes that many situations to which emergency workers are asked to respond are inherently hazardous. It is incumbent upon authorized officials utilizing emergency workers to ensure that workers are not needlessly endangered in mission activities or training events. The emergency worker must also recognize potentially hazardous operations and not accept the assignment unless the worker is confident that their training and skill level will allow the task to be accomplished safely.

(5) All prudent and reasonable safety procedures, techniques, equipment, and expertise shall be used to ensure the safety of emergency workers at all times while going to, preparing for, performing, recovering from, and returning from, missions or training events.

[Statutory Authority: Chapter 47.68 RCW. 96-02-067 (Order 160), § 468-200-180, filed 1/3/96, effective 2/3/96.]

WAC 468-200-200 Personal responsibilities of emergency workers. (1) Emergency workers shall be responsible to certify to the authorized officials registering them and using their services that they are aware of and will comply with all applicable responsibilities and requirements set forth in these rules.

(a) Emergency workers have the responsibility to notify the on-scene authorized official if they have been using any medical prescription or other drug that has the potential to render them impaired, unfit, or unable to carry out their emergency assignment.

(b) Participation by emergency workers in any mission, training event, or other authorized activity while under the influence of or while using narcotics or any illegal controlled substance is prohibited.

(c) Participation by emergency workers in any mission, training event, or other authorized activity while under the influence of alcohol is prohibited.

(2001 Ed.)

(d) Emergency workers participating in any mission, training event, or other authorized activity shall possess a valid operator's license if they are assigned to operate vehicles, vessels, or aircraft during the mission unless specifically directed otherwise by an authorized official in accordance with RCW 38.52.180. All emergency workers driving vehicles to or from a mission must possess a valid driver's license and required insurance.

(e) Use of private vehicles by emergency workers in any mission, training event, or other authorized activity without liability insurance required by chapter 46.29 RCW is prohibited unless specifically directed otherwise by an authorized official in accordance with RCW 38.52.180.

(f) Emergency workers shall adhere to all applicable traffic regulations during any mission, training event, or other authorized activity. This provision does not apply to individuals who have completed the emergency vehicles operator course or the emergency vehicle accident prevention course and are duly authorized under state law to use special driving skills and equipment and who do so at the direction of an authorized official.

(2) Emergency workers have the responsibility to comply with all other requirements as determined by the authorized official using their services.

(3) When reporting to the scene, emergency workers have the responsibility to inform the on-scene authorized official whether they are mentally and physically fit for their assigned duties. Emergency workers reporting as not fit for currently assigned duties may request a less demanding assignment that is appropriate to their current capabilities.

(4) Emergency workers have the responsibility to check in with the appropriate on-scene official and to complete all required recordkeeping and reporting.

[Statutory Authority: Chapter 47.68 RCW. 96-02-067 (Order 160), § 468-200-200, filed 1/3/96, effective 2/3/96.]

WAC 468-200-220 Conduct of training. All training will be conducted by the aviation division utilizing employees of the aviation division or volunteer instructors approved by the aviation division. Courses taught for qualification under this chapter will be those courses prepared or approved by the aviation division. Personnel seeking qualification under chapter 118-04 WAC will comply with the requirements established by chapter 118-04 WAC and imposed by the county of registration if registered in accordance with chapter 38.52 RCW. Organizations which desire to establish separate training programs for training that exceeds the requirements of this regulation are free to do so. Only the training required by this regulation shall be under the control of the aviation division. Course material, curriculum, and instructors will be those approved by the aviation division. The aviation division will prepare, and supply on request, information and guidelines for the selection of instructors, preparation of courses and conduct of training.

[Statutory Authority: Chapter 47.68 RCW. 96-02-067 (Order 160), § 468-200-220, filed 1/3/96, effective 2/3/96.]

WAC 468-200-230 Selection of resources—Mission. The selection of resources for a mission shall reside solely with the appointed incident commander. The aviation divi-

sion receives information about a potential mission or airborne disaster relief response from a variety of sources. The incident commander will review the known information and assess the type of response which is appropriate for the mission. The incident commander will, after reviewing the information at hand decide whether the mission calls for a limited or full response. Limited response type missions include, but are not limited to:

- (1) Electronic beacons (EPIRBs, ELTS, etc.).
- (2) Reported sightings of a possible downed aircraft or aircraft in distress.
- (3) Searches where evidence indicates the missing aircraft is confined to a limited search area.
- (4) A multistate search where the search area under the responsibility of the state of Washington is a limited geographical area.
- (5) The mission is one of transporting limited personnel or supplies.
- (6) The flight is a damage assessment flight of a limited area. This does not preclude the local authorities from using local resources to conduct damage assessment.
- (7) Weather or flight conditions make it unsafe or unwise to place more than a limited number of aircraft in the search area.
- (8) Any condition where in the opinion of the incident commander it would be unwise to commit additional aircraft.

In the case of limited response missions the incident commander shall select those individuals or organizations needed to support the mission. With the large number of qualified search and rescue volunteers and organizations in the state, not everyone will get called to support a limited specific mission.

After review of the information or at anytime during the execution of a mission, the incident commander may deem it necessary to go beyond a limited mission and in fact make it a major mission. At that time the incident commander, utilizing the call out and alert system established by the aviation division, will request the support and participation of additional registered volunteers and organizations.

[Statutory Authority: Chapter 47.68 RCW. 96-02-067 (Order 160), § 468-200-230, filed 1/3/96, effective 2/3/96.]

WAC 468-200-240 Staffing and conduct of the mission. The state of Washington, and the department of transportation have adopted the incident command system (ICS) of emergency response missions. All training and actual missions operated under the authority of chapter 47.68 RCW and this chapter shall be conducted using the incident command system (ICS) of mission management. The incident commander for any mission will be appointed by the director of the aviation division or his/her designee. The incident commander will appoint mission staff from the ranks of individuals who are qualified to staff those positions. The assignment of incident command system positions will be done without regard to membership in any organization.

[Statutory Authority: Chapter 47.68 RCW. 96-02-067 (Order 160), § 468-200-240, filed 1/3/96, effective 2/3/96.]

WAC 468-200-250 Mission number requests. The incident commander, after making a decision on what

[Title 468 WAC—p. 140]

resources are required, will seek an appropriate mission number assignment required by the responding organization. For the support of those emergency workers covered under chapter 38.52 RCW or chapter 118-04 WAC the incident commander will contact the Washington state military department, emergency management division, to obtain a state of Washington mission number. For missions where a Federal Mission Number is required, DOD (active duty, reserve, & Guard components) Federal non-DOD (FCC, Customs, etc.) and Civil Air Patrol, the incident commander will contact the United States Air Force Rescue Coordination Center for issuance of a mission number.

[Statutory Authority: Chapter 47.68 RCW. 96-02-067 (Order 160), § 468-200-250, filed 1/3/96, effective 2/3/96.]

WAC 468-200-260 Participation in training and operational missions. The conduct of aerial search and rescue and airborne disaster relief operations is a difficult and demanding task. In order to facilitate effective and efficient operations it is necessary that the incident commander has the full support and cooperation of all individuals participating. To that end the incident commander shall have the sole authority to determine whether or not an individual may participate in a mission. The incident commander may remove an individual or otherwise exclude an individual for any of the following reasons:

- (1) Individual does not meet the established criteria, training, or knowledge requirements of this regulation.
- (2) Individual is not mentally or physically fit to perform assigned duties.
- (3) Individual refuses to comply with instructions from appointed ICS authorities.
- (4) Individual is disruptive to the order of the mission.
- (5) Individual is not checked in on the mission and is a nonparticipant.

[Statutory Authority: Chapter 47.68 RCW. 96-02-067 (Order 160), § 468-200-260, filed 1/3/96, effective 2/3/96.]

WAC 468-200-280 Unauthorized conduct of search and rescue missions. Any individual or organization that falls under the authority of chapter 47.68 RCW or this chapter that conducts search and rescue operations without the authority or direction of the incident commander shall have their registration rescinded and shall be prohibited from future participation in search and rescue and airborne disaster relief operations for a period not to exceed one year. The time shall be determined by the director of aviation.

[Statutory Authority: Chapter 47.68 RCW. 96-02-067 (Order 160), § 468-200-280, filed 1/3/96, effective 2/3/96.]

WAC 468-200-300 Records requirements. Air search and rescue operations conducted under the authority of chapter 47.68 RCW and this chapter are the sole responsibility of the aviation division. All administrative recordkeeping, dispatch records, assignment sheets, action plans, and all other documents generated in the search, training event, or airborne response to a disaster will meet the following requirements:

- (1) All forms used shall be forms provided by and authorized by the aviation division. These forms will comply with

(2001 Ed.)

the tenets of the incident command system with modifications as authorized by the aviation division;

(2) All personnel, regardless of agency or organization shall check in and be placed on rosters provided and controlled by the aviation division;

(3) All assignments, plans, information, logs, etc., shall be on the forms as supplied by the aviation division;

(4) Organizations or personnel wishing to use their own forms for organization recordkeeping may. However the official forms of the mission are those which are supplied by the aviation division and those forms will be used by all who participate;

(5) Personnel responding to support a local jurisdiction mission (conducted in accordance with chapter 38.52 RCW and chapter 118-04 WAC) shall also check in on forms being maintained by the local authority.

[Statutory Authority: Chapter 47.68 RCW. 96-02-067 (Order 160), § 468-200-300, filed 1/3/96, effective 2/3/96.]

WAC 468-200-320 Records repository and retention.

Air search and rescue conducted under chapter 47.68 RCW and airborne disaster relief efforts conducted under the state comprehensive emergency management plan, the department of transportation emergency response plan, or the state and regional disaster airlift plan are the statutory responsibility of the aviation division. All records, reports, rosters, dispatch records, notes, logs, lead sheets, or any other written documents of the air search or airborne disaster relief are the property of the state of Washington. All said records will be submitted to the aviation division prior to or at the close of the mission. The aviation division shall maintain said records at the principle offices of the aviation division.

The aviation division will make copies of any and all records needed by any participating organization. Records will be reproduced within five working days of the close of a mission and mailed to any participating organization requesting same.

[Statutory Authority: Chapter 47.68 RCW. 96-02-067 (Order 160), § 468-200-320, filed 1/3/96, effective 2/3/96.]

WAC 468-200-340 Memorandum of understanding agreements. The director of aviation may enter into memorandum of understanding (MOU) agreements or other written documents amplifying or clarifying responsibilities and procedures. These written agreements may be entered into with agencies of the federal government, other state agencies, agencies of political subdivisions of the state of Washington or with support or volunteer organizations. Nothing in those agreements shall change the rules adopted by this chapter.

[Statutory Authority: Chapter 47.68 RCW. 96-02-067 (Order 160), § 468-200-340, filed 1/3/96, effective 2/3/96.]

WAC 468-200-350 Appeal procedure. Any individual who or organization which feels that the provisions of this chapter have not been fairly or equitably administered may appeal, in writing, to the director of aviation. The director will review the complaint and respond within thirty days. Appeals generally will be limited to training, certification, and registration matters. Due to the nature of emergency

(2001 Ed.)

response the decision of the appointed incident commander on any emergency response mission shall be final. Organizations and individuals may seek a meeting with the director of aviation after the incident for future review and clarification.

[Statutory Authority: Chapter 47.68 RCW. 97-03-064 (Order 167), § 468-200-350, filed 1/13/97, effective 2/13/97; 96-02-067 (Order 160), § 468-200-350, filed 1/3/96, effective 2/3/96.]

WAC 468-200-360 Severability. If any provisions of this chapter is held invalid, the remainder of the rule is not affected.

[Statutory Authority: Chapter 47.68 RCW. 96-02-067 (Order 160), § 468-200-360, filed 1/3/96, effective 2/3/96.]

Chapter 468-210 WAC PILOT REGISTRATION

WAC

468-210-001	Promulgation.
468-210-010	Pilot registration required.
468-210-020	Fees.
468-210-030	Possession of registration.
468-210-040	Seminars and clinics.
468-210-050	Unlicensed pilots.

WAC 468-210-001 Promulgation. Whereas, it is necessary for the purpose of protecting and insuring the general public interest, and developing and promoting aeronautics in this state to efficiently enforce the laws of the state of Washington relating to the registration of pilots; and

It is essential to the enforcement of such laws that regulations relating to their enforcement be promulgated:

It is hereby ordered under authority of RCW 47.68.210 and by virtue of the regulatory powers vested in the Washington state transportation commission for and on behalf of the state of Washington that the following sections be implemented.

[Statutory Authority: Chapter 47.68 RCW. 96-17-018 (Order 164), recodified as § 468-210-001, filed 8/13/96, effective 9/13/96. Statutory Authority: RCW 47.68.233 and 47.68.236. 83-01-038 (Order 74), § 12-18-001, filed 12/13/82.]

WAC 468-210-010 Pilot registration required. A pilot who is a resident of this state or who regularly operates in this state shall register with the division of aeronautics prior to January 31st each year. A new resident shall register with the division of aeronautics within sixty days of becoming a resident pilot. This section shall not apply to those persons exempted by RCW 47.68.233. Student pilots shall register not later than the date of their first solo flight.

[Statutory Authority: Chapter 47.68 RCW. 96-17-018 (Order 164), recodified as § 468-210-010, filed 8/13/96, effective 9/13/96. Statutory Authority: RCW 47.68.233 and 47.68.236. 83-01-038 (Order 74), § 12-18-010, filed 12/13/82.]

WAC 468-210-020 Fees. A fee of \$8.00 per year shall be paid for each pilot registration after August 31, 1996, without regard to the actual date of registration. Pilot registration fees will be deposited into the search and rescue, safety and education fund created under RCW 47.68.236.

[Statutory Authority: Chapter 47.68 RCW. 96-17-018 (Order 164), amended and recodified as § 468-210-020, filed 8/13/96, effective 9/13/96.]

Statutory Authority: RCW 47.68.233 and 47.68.236. 83-01-038 (Order 74), § 12-18-020, filed 12/13/82.]

WAC 468-210-030 Possession of registration. A pilot who is required to register under this chapter shall carry such registration at all times while exercising the privileges of an airmans certificate issued by the Federal Aviation Administration, and shall present such registration when requested to any law enforcement officer, division of aeronautics personnel or any other person on reasonable demand.

[Statutory Authority: Chapter 47.68 RCW. 96-17-018 (Order 164), recodified as § 468-210-030, filed 8/13/96, effective 9/13/96. Statutory Authority: RCW 47.68.233 and 47.68.236. 83-01-038 (Order 74), § 12-18-030, filed 12/13/82.]

WAC 468-210-040 Seminars and clinics. The division of aeronautics may require all persons required by this chapter to register as pilots to show proof of registration as a prerequisite to attendance at any seminar or clinic sponsored or conducted by the division of aeronautics and funded by pilot registration fees.

Pilots participating in division of aeronautics flight instructor refresher clinics will be required to show proof of registration prior to receiving credit for the course.

[Statutory Authority: Chapter 47.68 RCW. 96-17-018 (Order 164), recodified as § 468-210-040, filed 8/13/96, effective 9/13/96. Statutory Authority: RCW 47.68.233 and 47.68.236. 83-01-038 (Order 74), § 12-18-040, filed 12/13/82.]

WAC 468-210-050 Unlicensed pilots. Pilots who do not possess a valid Federal Aviation Administration airmans certificate and who operate aircraft for which such certificate is not required are nevertheless required to register with the division of aeronautics.

[Statutory Authority: Chapter 47.68 RCW. 96-17-018 (Order 164), recodified as § 468-210-050, filed 8/13/96, effective 9/13/96. Statutory Authority: RCW 47.68.233 and 47.68.236. 83-01-038 (Order 74), § 12-18-050, filed 12/13/82.]

Chapter 468-220 WAC

AIRCRAFT—INDICIA OF REGISTRATION

WAC

468-220-010 Display of indicia of registration.

WAC 468-220-010 Display of indicia of registration.

(1) That every aircraft registered with the Washington state department of transportation shall prominently display an insignia or decal, to be provided by the Washington state department of transportation on the tail or fuselage of such aircraft, just above N number, or on the right rear window panel, as evidence of registration;

(2) That no aircraft which is not lawfully registered shall display such insignia or evidence of registration, or any other mark, number, decal or insignia which might be reasonably believed to be evidence of state registration; and

(3) That failure to display such insignia shall be prima facie evidence that such aircraft is not registered.

[Statutory Authority: Chapter 47.68 RCW. 96-17-018 (Order 164), recodified as § 468-220-010, filed 8/13/96, effective 9/13/96. Statutory Authority: RCW 47.68.250. 88-01-089 (Order 112), § 12-19-010, filed 12/22/87.]

[Title 468 WAC—p. 142]

Chapter 468-230 WAC COMMERCIAL AIRPORTS

WAC

468-230-050 Regulations for the prevention and control of fires and fire hazards of airports and heliports.

WAC 468-230-050 Regulations for the prevention and control of fires and fire hazards of airports and heliports.

Reviser's note: On November 26, 1965, the Washington aeronautics commission filed with the code reviser's office the May 1962 edition of the N.F.P.A. Suggestions for Aircraft Rescue and Fire Fighting Services at Airports and Heliports #403, as Regulation No. 3 of their department to supersede previous Regulation No. 3 which was codified as WAC 12-20-010 through 12-20-040.

By authority of RCW 34.04.050(3) the aforementioned pamphlet has been omitted from this code, but copies may be obtained from the Washington Aeronautics Commission office at the Civil Defense Building, Martin Way, Olympia, Washington.

Reviser's note: Recodified as § 468-230-050, filed 8/13/96, effective 9/13/96. Statutory Authority: Chapter 47.68 RCW.

Chapter 468-240 WAC

OBSTRUCTION MARKING AND LIGHTING

WAC

468-240-002
468-240-005

Foreword.
Introduction.

MARKING

468-240-025
468-240-030
468-240-035
468-240-040
468-240-045
468-240-050

General.
Marking of vehicles.
Marking of natural and manmade obstructions.
Flags.
Colors.
Marking overhead lines.

LIGHTING

468-240-105
468-240-110
468-240-115
468-240-120
468-240-125
468-240-130
468-240-135
468-240-140
468-240-145
468-240-150
468-240-155
468-240-160
468-240-165
468-240-170

General.
Special day lighting.
Temporary warning lights.
Operation of obstruction lighting.
Inspection of obstruction lighting.
Notification of light failure.
Color of lighting.
Light distribution.
Rated lamp voltage.
Flashing of lights.
Intensity of lighting.
Interference with railway signals.
Obstruction lighting by nonstandard lights.
Obstruction lighting equipment—Specifications and drawings.
Obstruction lighting standards—Towers, poles, and similar obstructions.
Obstruction lighting standards—Trees.
Obstruction lighting standards—Transmission lines.
Obstruction lighting standards—Smokestacks and similar obstructions.
Obstruction lighting standards—Prominent buildings and similar extensive obstructions.
Obstruction lighting standards—Bridges.
Obstruction lighting standards—Water towers, grain elevators, gas holders and similar obstructions.
Obstruction lighting standards—Group of structural hazards.
Obstruction lighting standards—Hazard areas.

APPENDIX

468-240-350
468-240-360
468-240-370
468-240-380

Appendix rules—General.
Appendix rules—Criteria for determining obstructions to air navigation.
Appendix rules—Operation of moored balloons.
Appendix rules—Illustrations.

WAC 468-240-002 Foreword. (1) The purpose of this publication is to provide state, municipal governments, private industry and interested persons with important information and guidance in connection with the marking and lighting of natural and manmade objects which are, or may become, hazards to the safe operation of aircraft.

(2) Included in the text are the state standards prescribed for the marking and lighting of obstruction to air navigation.

(3) In the appendix (WAC 12-24-350 - 12-24-380) will be found the texts of laws and regulations regarding existing or proposed objects which may present hazards to aircraft operations, and also important information to provide guidance in complying with these texts of laws and regulations.

[Statutory Authority: Chapter 47.68 RCW. 96-17-018 (Order 164), recodified as § 468-240-002, filed 8/13/96, effective 9/13/96; Obstruction marking and lighting standards, foreword, filed 9/13/61.]

WAC 468-240-005 Introduction. (1) The Washington state aeronautics commission has the statutory responsibility of promoting safety in aeronautics and enforcing safety rules, regulations and standards. In the light of this responsibility, the Washington state aeronautics commission is vitally concerned with any object which may be a hazard to the safe operation of aircraft and the enforcement of state obstruction and marking law. Consequently, it has a primary responsibility in the determination of whether an existing or proposed object is, or will become, such a hazard.

(2) In order to provide uniform criteria to determine whether an object is, or will be, an obstruction to air navigation, the Washington state aeronautics commission has issued state standards for determining obstructions to air navigation. Natural or manmade objects or portions thereof, both temporary and permanent, which have been determined, through the application of these standards, to be obstructions and all manmade objects, or portions thereof, greater than 150 feet in over-all height above ground, or water if so situated, should be marked and/or lighted in accordance with the applicable standards hereinafter described, unless aeronautical study indicates that the absence of such marking and/or lighting will not impair safety in air navigation. Existing nonstandard obstruction marking and lighting installations should be replaced or modified so as to conform with these standards as soon as practicable.

(3) The standards for marking and lighting obstructions prescribed in this publication are designed to provide the most effective means of indicating the presence of obstructions to pilots. In many instances the obstruction may be so located in reference to other objects or the contour of the ground, that the specific standard need be applied to its upper part only. Similarly, the obstruction may be so removed from the general flow of air traffic or may be so conspicuous by its shape, size or color that obstruction marking would serve no useful purpose and would be unnecessary. Furthermore, the obstruction may present such a hazard that lighting should be provided similar to that for an obstruction of a greater height. Portions of obstructions that are shielded by surrounding objects need not be marked or lighted, but the surrounding objects should be marked and lighted.

(4) Because of the many influencing elements, the Washington state aeronautics commission may modify the

(2001 Ed.)

obstruction marking and lighting standards hereinafter described when aeronautical study has indicated that a change or modification is necessary to provide adequate protection for aeronautics.

[Statutory Authority: Chapter 47.68 RCW. 96-17-018 (Order 164), recodified as § 468-240-005, filed 8/13/96, effective 9/13/96; O.M.&L. standards, introduction, filed 9/13/61.]

MARKING

WAC 468-240-025 General. (1) The purpose of marking an obstruction which presents a hazard to aeronautics is to warn airmen during the hours of daylight of the presence of such an obstruction. To accomplish this objective, it may be necessary to color such an obstruction so that it will be visible from aircraft at any normal angle of approach, or to indicate the general definition and location of the obstruction by use of suitable markers or flags.

(2) When the upper part of only a portion of a structure or similar extensive obstruction projects above an obstruction determining surface, as described in state standards, that portion only need be obstruction marked and the point or edge of it highest in relation to the obstruction determining surface should be regarded as the "top of the obstruction." In certain cases, however, such as when the obstruction determining surface concerned is an approach or transition surface (i.e., sloping) this point or edge highest in relation to the obstruction determining surface may not be the highest point or edge above a horizontal plane passing through the base of the object. In such cases, those portions of the object, the upper parts of which are higher above a horizontal plane passing through the base of the object than the upper part considered as the "top of the obstruction," should also be obstruction marked.

[Statutory Authority: Chapter 47.68 RCW. 96-17-018 (Order 164), recodified as § 468-240-025, filed 8/13/96, effective 9/13/96; O.M.&L. standards (part), filed 9/13/61.]

WAC 468-240-030 Marking of vehicles. Vehicles customarily used on landing areas should be marked in accordance with the provisions of F.A.A. technical standard order TSO-N4, Army-Navy-Civil uniform requirements for the marking of vehicles used on landing areas.

[Statutory Authority: Chapter 47.68 RCW. 96-17-018 (Order 164), recodified as § 468-240-030, filed 8/13/96, effective 9/13/96; O.M.&L. standards (part), filed 9/13/61.]

WAC 468-240-035 Marking of natural and man-made obstructions. (1) Use of markers. Markers should be used to mark obstructions when it has been determined that it is impracticable to mark such obstructions by use of surface colors, or it has been determined that markers should be used to provide protection for aeronautics in addition to that provided by the application of aviation surface orange and white colors.

(2) General application. Markers used to mark obstructions should be displayed on or adjacent to the obstruction in conspicuous positions so as to retain the general definition of the obstruction. The size of such marker shall be a visible surface from all directions not less than that of a 36 inch sphere

the length of which shall not exceed twice its median width: Provided, however, That the commission may approve a non-conforming marker.

(3) Shape. The shape of such markers should be distinctive to the extent necessary to insure that they are not mistaken for markers employed to convey other information, and they should be such that the hazard presented by the obstruction they mark is not increased.

[Statutory Authority: Chapter 47.68 RCW, 96-17-018 (Order 164), recodified as § 468-240-035, filed 8/13/96, effective 9/13/96; O.M.&L. standards (part), filed 9/13/61.]

WAC 468-240-040 Flags. (1) Flags may be used to mark obstructions when it has been determined that marking such obstructions by coloring or by markers is technically impracticable.

(2) The flags should be displayed around or on top of the obstruction or around its highest edge and should not increase the hazard presented by the obstruction they mark. When flags are used to mark extensive obstructions or groups of closely spaced obstructions, they should be displayed at approximately 50 foot intervals.

(3) The flags should be rectangular in shape and have stiffeners to keep them from drooping in calm or light wind. The flag stakes should be of such strength and height that they will support the flags free of the ground, vegetation, or nearby surfaces.

(4) The flags should be in accordance with one of the following patterns:

(a) Solid color aviation surface orange not less than two feet on a side.

(b) Two triangular sections, one of aviation surface orange and the other of aviation surface white, combined to form a rectangle not less than two feet on a side.

(c) A checkerboard pattern of aviation surface orange and aviation surface white squares, each one foot plus or minus 10 percent on a side, combined to form a rectangle not less than three feet on a side.

[Statutory Authority: Chapter 47.68 RCW, 96-17-018 (Order 164), recodified as § 468-240-040, filed 8/13/96, effective 9/13/96; O.M.&L. standards (part), filed 9/13/61.]

WAC 468-240-045 Colors. (1) Maximum visibility of obstructions by contrast in colors can best be obtained by the use of aviation surface orange and white. Paints and enamels of these colors have been developed for use by government agencies and private industry in marking obstructions to air navigation. In marking, either the aviation surface orange paint or enamel may be used as preferred.

(2) The painted surfaces of obstructions should be cleaned or repainted as often as necessary to maintain good visibility.

(3) If the smooth surface of the paint on the ladders, decks, and walkways of certain types of steel towers and similar structures presents a potential danger to maintenance personnel, such surfaces need not be painted. However, the omission of paint should be restricted to actual surfaces the painting of which will present a hazard to maintenance personnel, and care should be taken that the over-all marking effect of the painting is not reduced.

[Title 468 WAC—p. 144]

(4) Solid. Obstructions the projection of which on any vertical plane has both dimensions less than 5 feet should be colored aviation surface orange.

(5) Bands.

(a) Towers, poles, smokestacks and similar obstructions, as well as buildings of certain shape and dimensions, having essentially unbroken surfaces the projection of which on any vertical plane is 5 feet or more in one dimension and is less than 15 feet in the other dimension, and any skeleton or smokestack type obstruction having both dimensions 5 feet or more, should be colored to show alternate bands of aviation surface orange and white.

(b) The bands should be perpendicular to the major axis of the obstruction with the band at each end colored aviation surface orange. The widths of the bands should be equal and the width of each band should be approximately one-seventh of the length of the major axis of the obstruction, provided that each band shall have a width of not more than 40 feet nor less 1 1/2 feet. If it is technically impracticable to color the roof of a building to show alternate bands of aviation surface orange and white, such roof may be colored aviation surface orange.

(6) Checkerboard pattern.

(a) Water towers, grain elevators, gas holders, and similar obstructions, as well as buildings of certain shape and dimensions, having essentially unbroken surfaces the projection of which on any vertical plane is 15 feet or more in both dimensions, should have their top and vertical surfaces colored to show a checkerboard pattern of alternate rectangles of aviation surface orange and white. If it is technically impracticable to color the roof of a building to show alternate rectangles of aviation surface orange and white, such roof may be colored aviation surface orange.

(b) The sides of the rectangles should measure not less than 5 feet nor more than 20 feet. The rectangles at the corners of surfaces should be colored aviation surface orange.

(c) If a part of a water tower, gas holder, building, or similar obstruction consists of a skeleton type construction, that portion of the obstruction should be colored with alternate bands of aviation surface orange and white as specified for towers, poles, smokestacks and similar obstructions. In this case, if the portion of the obstruction, which is to be colored to show a checkerboard pattern of alternate rectangles of aviation surface orange and white, has any surfaces the projection of which on any vertical plane is less than 15 feet in either dimension, the alternate rectangles of aviation surface orange and white may have dimensions of less than 5 feet on a side, provided their dimensions remain as close as is practicable to the minimum 5 feet specified for coloring by the checkerboard pattern.

(7) If the size and shape of water towers, grain elevators, gas holders and similar obstructions come within the dimensions set forth under the specification for coloring by bands; or if their type of construction does not permit coloring by the checkerboard pattern as hereinbefore described, then such obstructions should be colored by bands as specified for towers, poles, smokestacks and similar obstructions. Where this method of coloring is employed, the top aviation surface orange band should be continued from the vertical surface so as to cover the entire top of the obstruction.

(8) If a part, or all, of certain obstructions such as water towers and gas holders of spherical shape does not permit the exact application of the checkerboard pattern of coloring, then the shape of the alternate rectangles of aviation surface orange and white covering the spherical shape may be modified to fit the particular shape of the structural surface, provided the dimensions of these modified rectangles remain to the extent practicable within the dimensional limits set forth in the specifications for coloring by the checkerboard pattern.

(9) If certain obstructions such as gas holders and grain elevators are of such large size that the application of the checkerboard pattern of coloring to the complete outer surface of the structure would be impracticable, the application of the checkerboard pattern of coloring may be limited to the upper one-third of the structure, provided aeronautical study indicates that the modified marking will provide adequate protection for air navigation.

[Statutory Authority: Chapter 47.68 RCW, 96-17-018 (Order 164), recodified as § 468-240-045, filed 8/13/96, effective 9/13/96; O.M.&L. standards (part), filed 9/13/61.]

WAC 468-240-050 Marking overhead lines. Overhead lines and cables required to be marked under the provisions of RCW 14.04.340 - 14.04.360, shall be marked by placing a marker as described in WAC 12-24-035(2) at least every 150 feet on, or within 30 feet of such lines or cables. See "marking of lines and cables or similar obstructions" (WAC 12-24-380(12)).

Such markers shall be colored international orange equivalent to federal specifications TT-P-59 or TT-E-489.

[Statutory Authority: Chapter 47.68 RCW, 96-17-018 (Order 164), recodified as § 468-240-050, filed 8/13/96, effective 9/13/96; O.M.&L. standards (part), filed 9/13/61.]

LIGHTING

WAC 468-240-105 General. (1) The purpose of lighting an obstruction which presents a hazard to air commerce is to warn airmen during the hours of darkness and during periods of limited daytime light intensity of the presence of such an obstruction. To accomplish this objective, it is necessary to provide adequate lighting on the obstruction in a manner which assures visibility of such lighting from aircraft at any normal angle of approach. In determining the proper amount of obstruction lighting to adequately mark an obstruction, the mean elevation of the top of the building in closely built-up areas may be used as the equivalent of the ground level.

(2) The top light, or lights, displayed on an obstruction should be installed so as to mark the points or edges of the obstruction highest in relation to an obstruction determining surface, except that when no obstruction determining surface is involved, such top light, or lights, should be installed on the points or edges of the obstruction highest in relation to the ground, or water if so situated. If two or more edges of an extended obstruction located near a landing area are of the same height, the edge nearest the landing area should be lighted.

(3) When the upper part of only a portion of a building or similar extensive object projects above an obstruction determining surface, that portion only need be obstruction lighted

(2001 Ed.)

and the point or edge of it highest in relation to the obstruction determining surface should be regarded as the "top of the obstruction." In certain cases, however, such as when the obstruction determining surface concerned is an approach or transition surface (i.e., sloping) this point or edge highest in relation to the obstruction determining surface may not be the highest above a horizontal plane passing through the base of the object. In such cases, additional obstruction lights should be placed on the highest part of the object as well as on the point or edge highest in relation to the obstruction determining surface.

(4) If a light, or lights, which is installed on an obstruction is shielded in any direction by an adjacent object, additional lights should be mounted on that object in such a way as to retain the general definition of the obstruction, the shielded light, or lights, being omitted if it does not contribute to the definition of the obstruction.

(5) Obstruction lights and hazard beacons should be operated at all times when the center of the sun's disc is 6° or more below the horizon and during periods of restricted visibility. They may also be operated at such other times as considered desirable. For the purpose of this standard, the term "sunset to sunrise" shall be generally regarded as that period when the center of the sun's disc is 6° or more below the horizon.

[Statutory Authority: Chapter 47.68 RCW, 96-17-018 (Order 164), recodified as § 468-240-105, filed 8/13/96, effective 9/13/96; O.M.&L. standards (part), filed 9/13/61.]

WAC 468-240-110 Special day lighting. The display of flashing or steady burning lights on an obstruction during daylight hours, for the purpose of warning airmen of the presence of such an obstruction, may be prescribed under certain conditions. The foregoing day lighting is intended to provide protection in addition to that provided by the applicable marking standard hereinbefore described.

[Statutory Authority: Chapter 47.68 RCW, 96-17-018 (Order 164), recodified as § 468-240-110, filed 8/13/96, effective 9/13/96; O.M.&L. standards (part), filed 9/13/61.]

WAC 468-240-115 Temporary warning lights. When an obstruction to air navigation is presented during construction of a structure at least two lights, each light consisting of a lamp of at least 100 watts enclosed in an aviation red obstruction light globe, should be installed at the uppermost point of the structure. In addition, as the height of the structure exceeds each level at which permanent obstruction lights will be required, two similar lights should be installed at each such level. These temporary warning lights should be displayed nightly from sunset to sunrise until the permanent obstruction lights have been installed and placed in operation, and should be positioned so as to insure unobstructed visibility of at least one of the lights at each level from aircraft at any normal angle of approach. It will be permissible, in the event it is more practicable, to install and operate the permanent obstruction lighting fixtures at each required level, in lieu of the above temporary warning lights, as each such level is exceeded in height during construction.

[Statutory Authority: Chapter 47.68 RCW. 96-17-018 (Order 164), recodified as § 468-240-115, filed 8/13/96, effective 9/13/96; O.M.&L. standards (part), filed 9/13/61.]

WAC 468-240-120 Operation of obstruction lighting.

(1) The operation of obstruction lighting installed on obstructions of an over-all height greater than 150 feet above ground, or water if so situated, should be controlled by a light sensitive control device adjusted so that the lights will be turned on at a north sky light intensity level of about 35 foot-candles and turned off at a north sky light intensity level of about 58 foot-candles, or should be continuous.

(2) Under normal conditions, where no special means of controlling obstruction lighting has been recommended, either a light sensitive control device or an astronomic dial clock and time switch may be used to control the obstruction lighting in lieu of manual control.

[Statutory Authority: Chapter 47.68 RCW. 96-17-018 (Order 164), recodified as § 468-240-120, filed 8/13/96, effective 9/13/96; O.M.&L. standards (part), filed 9/13/61.]

WAC 468-240-125 Inspection of obstruction lighting.

Obstruction lighting should be visually observed at least once each 24 hours, or checked by observing an automatic and properly maintained indicator designed to register any failure of such lights, to insure that all such lights are functioning properly as required. In the event the obstruction lighting is not readily accessible for the above observation at least once each 24 hours, an automatic alarm system designed to detect any failure of such lights may be installed to replace the normally required visual inspection. The commission will not object to excluding the side or intermediate obstruction lights on an obstruction from the alarm circuit, provided the signaling device will indicate malfunctioning of all flashing and rotating beacons regardless of their position on the obstruction, and of all top lights; and that all obstruction lights mounted on the obstruction are visually inspected at least once every two weeks, with all lamps being replaced at regular intervals after being lighted the equivalent of not more than 75 percent of their normal life expectancy.

[Statutory Authority: Chapter 47.68 RCW. 96-17-018 (Order 164), recodified as § 468-240-125, filed 8/13/96, effective 9/13/96; O.M.&L. standards (part), filed 9/13/61.]

WAC 468-240-130 Notification of light failure. (1)

Any observed or otherwise known extinguishment or improper functioning of a marker light, regardless of its position on a manmade obstruction, which will last more than 30 minutes and any observed or otherwise known extinguishment or improper functioning of a steady burning obstruction light, installed at the top or near top of any natural or manmade obstruction, which will last more than 30 minutes should be immediately reported. Such reports should be made by telephone or telegraph to the nearest airways communications station or office of Washington state aeronautics commission and should set forth the condition of the light, or lights, the circumstance which caused the failure and the probable date that normal operation will be resumed. Further notification by telephone or telegraph should be given immediately upon resumption of normal operation by the light, or lights.

[Title 468 WAC—p. 146]

(2) Any extinguishment or improper functioning of a steady burning side or intermediate light, or lights, installed on a natural or manmade obstruction should be corrected as soon as possible, but notification of such extinguishment or improper functioning is not necessary.

[Statutory Authority: Chapter 47.68 RCW. 96-17-018 (Order 164), recodified as § 468-240-130, filed 8/13/96, effective 9/13/96; O.M.&L. standards (part), filed 9/13/61.]

WAC 468-240-135 Color of lighting. The signal emitted by hazard beacons and obstruction lights shall be aviation red in color.

[Statutory Authority: Chapter 47.68 RCW. 96-17-018 (Order 164), recodified as § 468-240-135, filed 8/13/96, effective 9/13/96; O.M.&L. standards (part), filed 9/13/61.]

WAC 468-240-140 Light distribution. The vertical and horizontal light distribution of the fixed obstruction lights should meet the requirements specified in the pertinent specifications listed in this publication. The vertical light distribution of the flashing and rotating hazard beacons should be such that the time-intensity integral of the flashes at angles between one degree and three degrees above the horizontal is not less than the candle-seconds values specified hereinbefore under "intensity of lighting," and the time-intensity integral at angles between three degrees and fifteen degrees above the horizontal is not less than the product of these candle-seconds values multiplied by nine over the square of the numerical value in degrees of the angle above the horizontal.

[Statutory Authority: Chapter 47.68 RCW. 96-17-018 (Order 164), recodified as § 468-240-140, filed 8/13/96, effective 9/13/96; O.M.&L. standards (part), filed 9/13/61.]

WAC 468-240-145 Rated lamp voltage. In order to provide satisfactory output by obstruction lights, the rated voltage of the lamp used should, in each case, correspond to or be within 3 percent higher than the average voltage across the lamp during the normal hours of operation.

[Statutory Authority: Chapter 47.68 RCW. 96-17-018 (Order 164), recodified as § 468-240-145, filed 8/13/96, effective 9/13/96; O.M.&L. standards (part), filed 9/13/61.]

WAC 468-240-150 Flashing of lights. If the flashing mechanism in obstruction lighting circuits is installed so as to make it necessary for the lights to flash, the simultaneous flashing of all lights will be permissible.

[Statutory Authority: Chapter 47.68 RCW. 96-17-018 (Order 164), recodified as § 468-240-150, filed 8/13/96, effective 9/13/96; O.M.&L. standards (part), filed 9/13/61.]

WAC 468-240-155 Intensity of lighting. The intensity of fixed obstruction lights should be not less than ten candles of aviation red light.

[Statutory Authority: Chapter 47.68 RCW. 96-17-018 (Order 164), recodified as § 468-240-155, filed 8/13/96, effective 9/13/96; O.M.&L. standards (part), filed 9/13/61.]

WAC 468-240-160 Interference with railway signals. Where obstruction lighting is installed on obstructions which are located along or near railroad rights of way and thereby

constitutes a potential hazard to the safe operation of railway trains, extreme care should be taken to prevent any possibility of these obstructions lights being mistaken by locomotive engineers for railway signal lights. Shielding of the obstruction lights from the view of the locomotive engineers, if practicable, should be considered; the fixed lights on the obstruction may be made to flash; or the lights at the lower levels of the obstruction may be extinguished if their extinguishment does not materially increase the hazard to air navigation caused by the presence of the obstruction.

[Statutory Authority: Chapter 47.68 RCW. 96-17-018 (Order 164), recodified as § 468-240-160, filed 8/13/96, effective 9/13/96; O.M.&L. standards (part), filed 9/13/61.]

WAC 468-240-165 Obstruction lighting by non-standard lights. Obstruction lighting installations may utilize incandescent lamps other than those specified under the recommended lamp equipment, gaseous tubes such as neon tubes, or any method other than the conventional incandescent lamps, provided such lighting installations offer equal or greater light intensity in all angles of azimuth and elevation than that specified for standard obstruction light assemblies, afford equal or greater dependability of operation, and possess the color characteristics prescribed in the following specifications.

[Statutory Authority: Chapter 47.68 RCW. 96-17-018 (Order 164), recodified as § 468-240-165, filed 8/13/96, effective 9/13/96; O.M.&L. standards (part), filed 9/13/61.]

WAC 468-240-170 Obstruction lighting equipment—Specifications and drawings. The lighting equipment, paint and aviation colors referred to in the standards set forth in this publication should conform with the applicable provisions of the following specifications and their related drawings:

- (1) Double and single obstruction lights.
 - (a) Military specification MIL-L-7830.
 - (b) F.A.A. specification L-810 specification for obstruction light.
- (2) Covers for aeronautical lights.
 - (a) Military specification MIL-C-7989 covers; light-transmitting (for aeronautical lights).
- (3) Aviation colors.
 - (a) Air Force-Navy aeronautical specification AN-C-56 colors; aeronautical lights and lighting equipment.
 - (b) Federal specification TT-C-595 color guide; ready mixed paint.
 - (i) Orange no. 1205 (aviation surface orange).
- (4) Aviation surface paint.
 - (a) Federal specification TT-P-59 aviation surface orange paint (international orange).
 - (b) Federal specification TT-E-489 aviation surface orange enamel (international orange).
 - (c) Federal specification TT-P-102 outside white paint.
- (5) Air Force-Navy aeronautical standard drawings.
 - (a) AN2541 Globe—marker lamp.
 - (b) AN2547 Fitting assembly—marker lamp.
- (6) Disconnecting obstruction light.
 - (a) Air Force-Navy aeronautical specification AN-L-31 lamp assembly—disconnecting obstruction marker.

(2001 Ed.)

(7) Recommended lamp equipment.

Multiple circuits					
Watts	Base	Lamp	Fila-ment	L.C.L. inches	Type
100	Med. screw	A-21 clear	C-9	2 7/16	Traffic signal
100	Med. pfc.	A-21 clear	CC-2V	2 3/4	Obstruction
100	Sc. term	PAR-56, clear	C-6	Airway beacon
*111	Med. sc.	A-21 clear	C-9	2 7/16	Obstruction
500	Mog. pfc.	PS-40 clear	C-7A.	5 11/16	Code beacon
500	Med. bip.	T-20 clear	C-13B	3	Airway beacon
**620	Mog. pfc.	PS-40 clear	C-7A	5 11/16	Code beacon
1000	Mog.bip.	T-20 clear	C-13	4	Airway beacon
1500	Mog.bip.	T-24 clear(32v)	C-5	4	Airway beacon

Series circuit					
Lumens	Base	Lamp	Fila-ment	L.C.L. inches	Type
1020	Med. pfc.	A-21 clear	C-8	2 3/4	Obstruction

* Has same lumen output as 100-watt but designed for 3000 hours life.
 ** Has same lumen output as 500-watt but designed for 3000 hours life.

Note: Copies of military specifications and air force-navy aeronautical specifications or drawings can be obtained by contacting Commanding General, Air Material Command, Wright Field, Dayton, Ohio, or the Bureau of Aeronautics, Department of the Navy, Washington 25, D.C. Copies of F.A.A. specifications and information concerning air force-navy aeronautical specifications and federal specifications can be obtained from the Office of Federal Airways, F.A.A. Washington 25, D.C.

[Statutory Authority: Chapter 47.68 RCW. 96-17-018 (Order 164), recodified as § 468-240-170, filed 8/13/96, effective 9/13/96; O.M.&L. standards (part), filed 9/13/61.]

WAC 468-240-175 Obstruction lighting standards—Towers, poles, and similar obstructions. Towers, poles and similar obstructions should be lighted in accordance with the following specifications:

(1) **Specification "A-1."** When the particular obstruction is not more than 150 feet in over-all height above ground, or water if so situated.

(a) There should be installed at the top of the obstruction at least two lights, each light consisting of a lamp of at least 100 watts enclosed in aviation red obstruction light globes. These lights should burn simultaneously and should be positioned so as to insure unobstructed visibility of at least one of the lights from aircraft at any normal angle of approach.

(2) **Specification "A-2."** When the particular obstruction is more than 150 feet but not more than 300 feet in over-all height above ground, or water if so situated.

(a) There should be installed at the top of the obstruction a flashing 300 mm electric code beacon equipped with two lamps and aviation red color filters. The two lamps of the beacon should burn simultaneously and each lamp should be at least 500 watts. Where a rod or other construction of not more than 20 feet in height and incapable of supporting this beacon is mounted on top of the obstruction and it is determined that this additional construction does not permit unobstructed visibility of the code beacon from aircraft at any normal angle of approach, there should be installed two such beacons positioned so as to insure unobstructed visibility of at least one of the beacons at any normal angle of approach.

(b) At the approximate mid point of the over-all height of the obstruction, there should be installed at least two lights, each light consisting of a lamp of at least 100 watts, enclosed

[Title 468 WAC—p. 147]

in aviation red obstruction light globes. Each light should be placed on diagonally or diametrically opposite positions of the obstruction and mounted so as to insure unobstructed visibility of at least one light from aircraft at any normal angle of approach.

(c) In case of a triangular or rectangular shaped tower, the lights at the mid level should be mounted so as to insure unobstructed visibility of at least one light from aircraft at any normal angle of approach, or a light should be installed on each corner of the tower at this level.

(3) **Specification "A-3."** When the particular obstruction is more than 300 feet but not more than 450 feet in over-all height above ground, or water if so situated.

(a) There should be installed at the top of the obstruction a flashing 300 mm electric code beacon equipped with two lamps and aviation red color filters. The two lamps of the beacon should burn simultaneously and each should be at least 500 watts. Where a rod or other construction of not more than 20 feet in height and incapable of supporting this beacon is mounted on top of the obstruction and it is determined that this additional construction does not permit unobstructed visibility of the code beacon from aircraft at any normal angle of approach, there should be installed two such beacons positioned so as to insure unobstructed visibility of at least one of the beacons from aircraft at any normal angle of approach.

(b) On levels at approximately two-thirds and one-third or the over-all height of the obstruction, there should be installed at least two lights, each light consisting of a lamp of at least 100 watts, enclosed in aviation red obstruction light globes. Each light should be placed on diagonally or diametrically opposite positions of the obstruction and mounted so as to insure unobstructed visibility of at least one light at each level from aircraft at any normal angle of approach.

(c) In case of a triangular or rectangular shaped tower, the lights at the two-thirds and one-third levels should be mounted so as to insure unobstructed visibility of at least one light on each level from aircraft at any normal angle of approach, or a light should be installed on each corner of the obstruction at each level.

(4) **Specification "A-4."** When the particular obstruction is more than 450 feet but not more than 600 feet in over-all height above ground, or water if so situated.

(a) There should be installed at the top of the obstruction a flashing 300 mm electric code beacon equipped with two lamps and aviation red color filters. The two lamps of the beacon should burn simultaneously and each should be at least 500 watts. Where a rod or other construction of not more than 20 feet in height and incapable of supporting this beacon is mounted on top of the obstruction and it is determined that this additional construction does not permit unobstructed visibility of the code beacon from aircraft at any normal angle of approach, there should be installed two such beacons positioned so as to insure unobstructed visibility of at least one of the beacons from aircraft at any normal angle of approach.

(b) At approximately one-half of the over-all height of the obstruction, a similar flashing 300 mm electric code beacon should be installed in such a position within the obstruction proper that the structural members will not impair visibility of this beacon from aircraft at any normal angle of approach. In the event this beacon cannot be installed in a

manner to insure unobstructed visibility of it from aircraft at any normal angle of approach, there should be installed two such beacons. Each beacon should be mounted on the outside of diagonally opposite corners or opposite sides of the obstruction at the prescribed height.

(c) On levels of approximately three-fourths and one-fourth of the over-all height of the obstruction one or more lights, each light consisting of a lamp of at least 100 watts, enclosed in aviation red obstruction light globes, should be installed on each outside corner of the obstruction at each level.

(5) **Specification "A-5."** When the particular obstruction is more than 600 feet but not more than 750 feet in over-all height above ground, or water if so situated.

(a) There should be installed at the top of the obstruction a flashing 300 mm electric code beacon equipped with two lamps and aviation red color filters. The two lamps of the beacon should burn simultaneously and each should be at least 500 watts. Where a rod or other construction of not more than 20 feet in height and incapable of supporting this beacon is mounted on top of the obstruction and it is determined that this additional construction does not permit unobstructed visibility of the code beacon from aircraft at any normal angle of approach, there should be installed two such beacons positioned so as to insure unobstructed visibility of at least one of the beacons from aircraft at any normal angle of approach.

(b) At approximately two-fifths of the over-all height of the obstruction, a similar flashing 300 mm electric code beacon should be installed in such a position within the obstruction proper that the structural members will not impair visibility of this beacon from aircraft at any normal angle of approach. In the event this code beacon cannot be installed in a manner to insure unobstructed visibility from aircraft at any normal angle of approach, there should be installed two such beacons at this level. Each beacon should be mounted on the outside of diagonally opposite corners or opposite sides of the obstruction at the prescribed height.

(c) On levels at approximately four-fifths, three-fifths and one-fifth of the over-all height of the obstruction one or more lights, each light consisting of a lamp of at least 100 watts, enclosed in aviation red obstruction light globes should be installed on each outside corner of the obstruction at each level.

(6) **Specification "A-6."** When the particular obstruction is more than 750 feet but not more than 900 feet in over-all height above ground, or water if so situated.

(a) There should be installed at the top of the obstruction a flashing 300 mm electric code beacon equipped with two lamps and aviation red color filters. The two lamps of the beacon should burn simultaneously and each should be at least 500 watts.

(b) Where a rod or other construction of not more than 20 feet in height and incapable of supporting this beacon is mounted on top of the obstruction and it is determined that this additional construction does not permit unobstructed visibility of the code beacon from aircraft at any normal angle of approach, there should be installed two such beacons positioned so as to insure unobstructed visibility of at least one of the beacons from aircraft at any normal angle of approach.

(c) At approximately two-thirds and at approximately one-third of the over-all height of the obstruction, a similar flashing 300 mm electric code beacon should be installed in such a position within the obstruction proper that the structural members will not impair visibility of this beacon from aircraft at any normal angle of approach. In the event these electric code beacons cannot be installed in a manner to insure unobstructed visibility from aircraft at any normal angle of approach, there should be installed two such beacons at each level. Each beacon should be mounted on the outside of diagonally opposite corners or opposite sides of the obstruction at the prescribed heights.

(d) On levels at approximately five-sixths, one-half and one-sixth of the over-all height of the obstruction one or more lights, each light consisting of a lamp of at least 100 watts, enclosed in aviation red obstruction light globes should be installed on each outside corner of the obstruction at each level.

(7) Specification "A-7." When the particular obstruction is more than 900 feet but not more than 1050 feet in over-all height above ground, or water if so situated.

(a) There should be installed at the top of the obstruction a flashing 300 mm electric code beacon equipped with two lamps and aviation red color filters. The two lamps of the beacon should burn simultaneously and each should be at least 500 watts. Where a rod or other construction of not more than 20 feet in height and incapable of supporting this beacon is mounted on top of the obstruction and it is determined that this additional construction does not permit unobstructed visibility of the code beacon from aircraft at any normal angle of approach, there should be installed two such beacons positioned so as to insure unobstructed visibility of at least one of the beacons from aircraft at any normal angle of approach.

(b) At approximately four-sevenths, and at approximately two-sevenths of the over-all height of the obstruction, a similar flashing 300 mm electric code beacon should be installed in such a position within the obstruction proper that the structural members will not impair visibility of this beacon from aircraft at any normal angle of approach. In the event these electric code beacons cannot be installed in a manner to insure unobstructed visibility from aircraft at any normal angle of approach, there should be installed two such beacons at each level. Each beacon should be mounted on the outside of diagonally opposite corners or opposite sides of the obstruction at the prescribed heights.

(c) On levels at approximately six-sevenths, five-sevenths, three-sevenths and one-seventh of the over-all height of the obstruction one or more lights consisting of a lamp of at least 100 watts, enclosed in aviation red obstruction light globes should be installed on each outside corner of the obstruction at each level.

(8) Specification "A-8." When the particular obstruction is more than 1050 feet but not more than 1200 feet in over-all height above ground, or water if so situated.

(a) There should be installed at the top of the obstruction a flashing 300 mm electric code beacon equipped with two lamps and aviation red color filters. The two lamps of the beacon should burn simultaneously and each should be at least 500 watts. Where a rod or other construction of not more than 20 feet in height and incapable of supporting this beacon

is mounted on top of the obstruction and it is determined that this additional construction does not permit unobstructed visibility of the code beacon from aircraft at any normal angle of approach, there should be installed two such beacons positioned so as to insure unobstructed visibility of at least one of the beacons from aircraft at any normal angle of approach.

(b) At approximately three-fourths, one-half and one-fourth of the over-all height of the obstruction, a similar flashing 300 mm electric code beacon should be installed in such a position within the obstruction proper that the structural members will not impair visibility of this beacon from aircraft at any normal angle of approach. In the event these electric code beacons cannot be installed in a manner to insure unobstructed visibility from aircraft at any normal angle of approach, there should be installed two such beacons at each level. Each beacon should be mounted on the outside of diagonally opposite corners or opposite sides of the obstruction at the prescribed heights.

(c) On levels at approximately seven-eighths, five-eighths, three-eighths and one-eighth of the over-all height of the obstruction one or more lights, each light consisting of a lamp of at least 100 watts, enclosed in aviation red obstruction light globes should be installed on each outside corner of the obstruction at each level.

(9) Specification "A-9." When the particular obstruction is more than 1200 feet but not more than 1350 feet in over-all height above ground, or water if so situated.

(a) There should be installed at the top of the obstruction a flashing 300 mm electric code beacon equipped with two lamps and aviation red color filters. The two lamps of the beacon should burn simultaneously and each should be at least 500 watts. Where a rod or other construction of not more than 20 feet in height and incapable of supporting this beacon is mounted on top of the obstruction and it is determined that this additional construction does not permit unobstructed visibility of the code beacon from aircraft at any normal angle of approach, there should be installed two such beacons positioned so as to insure unobstructed visibility of at least one of the beacons from aircraft at any normal angle of approach.

(b) At approximately two-thirds, four-ninths and two-ninths of the over-all height of the obstruction, a similar flashing 300 mm electric code beacon should be installed in such a position within the obstruction proper that the structural members will not impair visibility of this beacon from aircraft at any normal angle of approach. In the event these electric code beacons cannot be installed in a manner to insure unobstructed visibility from aircraft at any normal angle of approach, there should be installed two such beacons at each level. Each beacon should be mounted on the outside of diagonally opposite corners or opposite sides of the obstruction at the prescribed heights.

(c) On levels at approximately eight-ninths, seven-ninths, five-ninths, one-third and one-ninth of the over-all height of the obstruction one or more lights, each light consisting of a lamp of at least 100 watts, enclosed in aviation red obstruction light globes should be installed on each outside corner of the obstruction at each level.

(10) Specification "A-10." When the particular obstruction is more than 1350 feet but not more than 1500 feet in over-all height above ground, or water if so situated.

(a) There should be installed at the top of the obstruction a flashing 300 mm electric code beacon equipped with two lamps and aviation red color filters. The two lamps of the beacon should burn simultaneously and each should be at least 500 watts. Where a rod or other construction of not more than 20 feet in height and incapable of supporting this beacon is mounted on top of the obstruction and it is determined that this additional construction does not permit unobstructed visibility of the code beacon from aircraft at any angle of approach, there should be installed two such beacons positioned so as to insure unobstructed visibility of at least one of the beacons from aircraft at any normal angle of approach.

(b) At approximately four-fifths, three-fifths, two-fifths and one-fifth of the over-all height of the obstruction, a similar flashing 300 mm electric code beacon should be installed in such a position within the obstruction proper that the structural members will not impair visibility of this beacon from aircraft at any normal angle of approach. In the event these electric code beacons cannot be installed in a manner to insure unobstructed visibility from aircraft at any normal angle of approach, there should be installed two such beacons at each level. Each beacon should be mounted on the outside of diagonally opposite corners or opposite sides of the obstruction at the prescribed heights.

(c) On levels at approximately nine-tenths, seven-tenths, one-half, three-tenths and one-tenth of the over-all height of the obstruction one or more lights, each light consisting of a lamp of at least 100 watts, enclosed in aviation red obstruction light globes should be installed on each outside corner of the obstruction at each level.

(11) **Specification "A-11."** Towers and similar obstructions which are more than 1500 feet in over-all heights above ground, or water if so situated, will be given special aeronautical study to determine the proper manner in which to obstruction light them to provide adequate protection for air commerce.

[Statutory Authority: Chapter 47.68 RCW. 96-17-018 (Order 164), recodified as § 468-240-175, filed 8/13/96, effective 9/13/96; O.M.&L. standards (part), filed 9/13/61.]

WAC 468-240-180 Obstruction lighting standards—Trees. A line of trees, with the individual trees located less than 150 feet apart, or a tree covered area should be lighted as an extensive obstruction in the manner set forth in the "E" specifications for prominent buildings and similar extensive obstructions, with the obstruction lights mounted on poles or towers, of a height slightly greater than the height of the outstanding trees. Individual trees and widely spaced trees should be lighted in accordance with the following specifications:

(1) **Specification "B-1."** Poles of a height slightly greater than the height of the outstanding tree(s) should be installed adjacent to the tree(s) and lighted in accordance with the specifications hereinbefore prescribed for individual towers, poles and similar obstructions of a corresponding over-all height above ground, or water if so situated.

[Statutory Authority: Chapter 47.68 RCW. 96-17-018 (Order 164), recodified as § 468-240-180, filed 8/13/96, effective 9/13/96; O.M.&L. standards (part), filed 9/13/61.]

[Title 468 WAC—p. 150]

WAC 468-240-185 Obstruction lighting standards—Transmission lines. The catenary of a transmission line or similar obstructions, should be lighted in accordance with the following specifications:

(1) **Specification "C-1."**

(a) The towers, poles, or similar structures supporting such a line should be lighted in accordance with the specifications hereinbefore prescribed for individual towers, poles, or similar obstructions of a corresponding over-all height above ground, or water if so situated.

(b) In each case where a transmission line within 15,000 feet of a landing area is required to be lighted in accordance with the provisions of RCW 14.04.340 - 14.04.350, one or more lights, each light consisting of a lamp of at least 100 watts enclosed in an aviation red obstruction light globe, should be displayed for each 150 feet or fraction thereof, of the over-all length of the overhead line. These lights should be equally spaced along the entire length of the overhead transmission line at points not more than 150 feet apart and each light should be placed not below the level of the highest wire at the point marked.

(c) When a transmission line more than 15,000 feet from a landing area is required to be lighted in accordance with the provisions of RCW 14.04.340 - 14.04.350, the distance between the obstruction lights displayed on such wires may be increased to not less than 600 feet.

[Statutory Authority: Chapter 47.68 RCW. 96-17-018 (Order 164), recodified as § 468-240-185, filed 8/13/96, effective 9/13/96; O.M.&L. standards (part), filed 9/13/61.]

WAC 468-240-190 Obstruction lighting standards—Smokestacks and similar obstructions. Smokestacks and similar obstructions should be lighted in accordance with the following specifications:

(1) In order to avoid the obscuring effect of the deposits generally in evidence from this type of structure, the top lights should be installed from 5 to 10 feet below the highest point of the structure. It is important that these lights be readily accessible to enable cleaning when necessary and to facilitate lamp replacements.

(2) Smokestacks and similar obstructions may be floodlighted by fixed searchlight projectors installed at three or more equidistant points around the base of each such obstruction if the search light projectors will provide an average illumination of at least 15 candles at the top one-third of the obstruction.

(3) **Specification "D-1."** When the particular obstruction is not more than 150 feet in over-all height above ground, or water if so situated.

(a) There should be installed at a near top level of the obstruction three or more lights, each light consisting of a lamp of at least 100 watts, enclosed in aviation red obstruction light globes. These lights should be placed at regular intervals on the horizontal plane in a manner to insure unobstructed visibility of at least two of the lights from aircraft at any normal angle of approach.

(4) **Specification "D-2."** When the particular obstruction is more than 150 feet but not more than 300 feet in over-all height above ground, or water if so situated.

(2001 Ed.)

(a) There should be installed at a near top level of the obstruction two or more flashing 300 mm electric code beacons, each beacon equipped with two lamps and aviation red color filters. The two lamps of each beacon should burn simultaneously and each should be at least 500 watts. The beacons should be placed at regular intervals on the horizontal plane in a manner to insure unobstructed visibility of at least one beacon from aircraft at any normal angle of approach.

(b) At approximately the mid point of the over-all height of the obstruction, there should be installed at least two lights, each light consisting of a lamp of at least 100 watts, enclosed in aviation red obstruction light globes. These lights should be placed at regular intervals on the horizontal plane in a manner to insure unobstructed visibility of at least one light from aircraft at any normal angle of approach.

(5) **Specification "D-3."** When the particular obstruction is more than 300 feet but not more than 450 feet in over-all height above ground, or water if so situated.

(a) There should be installed at a near top level of the obstruction two or more flashing 300 mm electric code beacons, each beacon equipped with two lamps and aviation red color filters. The two lamps of each beacon should burn simultaneously and each should be at least 500 watts. The beacons should be placed at regular intervals on the horizontal plane in a manner to insure unobstructed visibility of at least one beacon from aircraft at any normal angle of approach.

(b) On levels at approximately two-thirds and one-third of the over-all height of the obstruction, there should be installed on each level at least two lights, each light consisting of a lamp of at least 100 watts, enclosed in aviation red obstruction light globes. These lights should be placed at regular intervals on the horizontal plane in a manner to insure unobstructed visibility of at least one light from aircraft on any normal angle of approach.

(6) **Specification "D-4."** When the particular obstruction is more than 450 feet but not more than 600 feet in over-all height above ground, or water if so situated.

(a) There should be installed at a near top level of the obstruction two or more flashing 300 mm electric code beacons, each beacon equipped with two lamps and aviation red color filters. The two lamps of each beacon should burn simultaneously and each should be at least 500 watts. The beacons should be placed at regular intervals on the horizontal plane in a manner to insure unobstructed visibility of at least one beacon from aircraft at any normal angle of approach.

(b) At approximately one-half of the over-all height of the structure, two or more similar flashing 300 mm electric code beacons should be installed at regular intervals on the horizontal plane in a manner to insure unobstructed visibility of at least one beacon from aircraft at any normal angle of approach.

(c) On levels of approximately three-fourths and one-fourth of the over-all height of the structure, there should be installed on each level at least three lights, each light consisting of a lamp of at least 100 watts, enclosed in aviation red obstruction light globes. These lights should be placed at regular intervals on the horizontal plane in a manner to insure

unobstructed visibility of at least two lights on each level from aircraft at any normal angle of approach.

(7) **Specification "D-5."** When the particular obstruction is more than 600 feet but not more than 750 feet in over-all height above ground, or water if so situated.

(a) There should be installed at a near top level of the obstruction two or more flashing 300 mm electric code beacons, each beacon equipped with two lamps and aviation red color filters. The two lamps of each beacon should burn simultaneously and should be at least 500 watts. The beacons should be placed at regular intervals on the horizontal plane in a manner to insure unobstructed visibility of at least one beacon from aircraft at any normal angle of approach.

(b) At approximately two-fifths of the over-all height of the obstruction, two or more similar flashing 300 mm electric code beacons should be installed at regular intervals on the horizontal plane in a manner to insure unobstructed visibility of at least one beacon from aircraft at any normal angle of approach.

(c) On levels of approximately four-fifths, three-fifths and one-fifth of the over-all height of the obstruction, there should be installed on each level at least three lights, each light consisting of a lamp of at least 100 watts, enclosed in aviation red obstruction light globes. These lights should be placed at regular intervals on the horizontal plane in a manner to insure unobstructed visibility of at least two lights on each level from aircraft at any normal angle of approach.

(8) **Specification "D-6."** When the particular obstruction is more than 750 feet but not more than 900 feet in over-all height above ground, or water if so situated.

(a) There should be installed at a near top level of the obstruction two or more flashing 300 mm electric code beacons, each beacon equipped with two lamps and aviation red color filters. The two lamps of each beacon should burn simultaneously and each should be at least 500 watts. The beacons should be placed at regular intervals on the horizontal plane in a manner to insure unobstructed visibility of at least one beacon from aircraft at any normal angle of approach.

(b) At approximately two-thirds and at approximately one-third of the over-all height of the obstruction two or more similar flashing 300 mm electric code beacons should be installed at regular intervals on the horizontal plane in a manner to insure unobstructed visibility of at least one beacon from aircraft at any normal angle of approach.

(c) On levels of at approximately five-sixths, one-half and one-sixth of the over-all height of the obstruction, there should be installed at least three lights, each light consisting of a lamp of at least 100 watts, enclosed in aviation red obstruction light globes. These lights should be placed at regular intervals on the horizontal plane in a manner to insure unobstructed visibility of at least two lights on each level from aircraft at any normal angle of approach.

(9) **Specification "D-7."** Smokestacks and similar obstructions which are more than 900 feet in over-all height above ground, or water if so situated, will be given special aeronautical study to determine the proper manner in which to obstruction light them to provide adequate protection for air commerce.

[Statutory Authority: Chapter 47.68 RCW, 96-17-018 (Order 164), recodified as § 468-240-190, filed 8/13/96, effective 9/13/96; O.M.&L. standards (part), filed 9/13/61.]

**WAC 468-240-195 Obstruction lighting standards—
Prominent buildings and similar extensive obstructions.**

(1) Prominent buildings and similar extensive obstructions should be lighted in accordance with the following specifications. In the event the individual objects of a group of obstructions are approximately the same over-all height above ground, or water if so situated, and are located not more than 150 feet apart, the group of obstructions may be considered an extensive obstruction and so lighted.

(2) **Specification "E-1."** When the particular obstruction is not more than 150 feet in over-all height above ground, or water if so situated.

(a) If the obstruction is not more than 150 feet in either horizontal dimension, there should be installed at approximately the highest point or edge at each end of the major axis of the obstruction at least one light, consisting of a lamp of at least 100 watts, enclosed in an aviation red obstruction light globe. These lights should be positioned so as to insure unobstructed visibility of them from aircraft at any normal angle of approach, and to indicate the general extent of the obstruction; or, if the shape of the obstruction is such as to make this manner of lighting impracticable, there may be installed two such lights at the approximate center of the highest point or edge of the obstruction. Both lights should burn simultaneously and be so positioned as to insure unobstructed visibility of at least one of the lights from aircraft at any normal angle of approach.

(b) If the obstruction is more than 150 feet in one horizontal dimension, but not more than 150 feet in the other, there should be installed at least one light, consisting of a lamp of at least 100 watts enclosed in an aviation red obstruction light globe, for each 150 feet, or fraction thereof, or the over-all length of the major axis of the obstruction. At least one of these top lights should be installed on the highest point or edge of each end of the obstruction, with the additional lights as required spaced at approximately equal intervals not exceeding 150 feet, on the highest points or edge between the end lights in a manner to indicate the extent of the obstruction and to insure unobstructed visibility of the lights from aircraft at any normal angle of approach. If there are two or more edges of the same height on such an obstruction located near a landing area, the edge nearest the landing area should be lighted.

(c) If the obstruction is more than 150 feet in both horizontal dimensions, there should be installed at least one light, consisting of a lamp of at least 100 watts enclosed in an aviation red obstruction light globe, on the highest point of each corner of the obstruction. In addition, there should be installed at least one similar light for each 150 feet, or fraction thereof, [if] the distance between the corner lights exceeds 150 feet. These additional lights should be installed at approximately equal intervals, at the highest points along the outer edges of the obstruction, between the corner lights in a manner to indicate the general extent and definition of the obstruction and to insure unobstructed visibility of the lights from aircraft at any normal angle of approach.

(d) In the event there are one or more points within the outer edges of the obstruction, the uppermost parts of which are higher than the highest level of the lights hereinbefore prescribed, at least one similar light should be displayed from the top of each such point.

(2) **Specification "E-2."** When the particular obstruction is more than 150 feet in over-all height above ground, or water if so situated.

(a) Top lights should be installed on the obstruction in the manner set forth in the applicable provisions of Specification "E-1."

(b) In addition to the required top lights, intermediate lights, each consisting of a lamp of at least 100 watts enclosed in an aviation red obstruction light globe, should be provided for each 150 feet, or fraction thereof, [if] the obstruction exceeds 150 feet in over-all height above ground, or water if so situated. The position of these intermediate lights on the vertical plane should be as close to equidistant levels between the top lights and the ground level as the particular shape and type of obstruction will permit. One such light should be installed at each outside corner of the obstruction at each level and also one such light should be installed at equal intervals on the horizontal plane on each outer surface at each level between adjacent corner lights, for each 150 feet, or fraction thereof, [if] the over-all horizontal distance between such adjacent corner lights exceeds 150 feet.

Note: In lieu of installing the obstruction lights on the obstructions, a pole or poles of a height slightly greater than the over-all height of the obstruction may be installed thereto and lighted in accordance with the specifications hereinbefore prescribed for individual towers, poles, or similar obstructions of a corresponding over-all height. It is important that those towers, poles, or similar structures be installed in such a manner as to indicate the general definition and extent of the obstruction.

(3) In the event early or special warning is considered necessary to provide adequate protection for aircraft, the top lights on each obstruction as required under Specifications "E-1" and "E-2" should be replaced with one or more flashing 300 mm electric code beacons, each beacon equipped with two lamps and aviation red color filters. The two lamps of each beacon should burn simultaneously and each should be at least 500 watts.

(4) Where obstructions are extensive as in the case of a line of trees or hills, and the use of the fixed obstruction lights would be impracticable or inadequate, flashing or rotating hazard beacons may be used as an alternate to the fixed obstruction lights. Such beacons should be located on the highest points or edges of the extended obstruction at intervals not exceeding 3,000 feet, provided at least three beacons are placed on any one side or edge of the extensive obstruction to indicate a line of lights.

[Statutory Authority: Chapter 47.68 RCW, 96-17-018 (Order 164), recodified as § 468-240-195, filed 8/13/96, effective 9/13/96; O.M.&L. standards (part), filed 9/13/61.]

**WAC 468-240-200 Obstruction lighting standards—
Bridges.** The superstructure of a bridge should be lighted in accordance with the following specifications.

(1) Where the bridge structure is over navigable water, approval of the lighting installation must be obtained from

the commandant of the United States Coast Guard to avoid interference with marine navigation.

(2) **Specification "F-1."** When the bridge superstructure is not more than 150 feet in over-all length.

(a) There should be installed at the approximate center of the highest point of the superstructure at least two lights, each light consisting of a lamp of at least 100 watts, enclosed in aviation red obstruction light globes. The two lights should burn simultaneously and should be positioned so as to insure unobstructed visibility of at least one of the lights from aircraft at any normal angle of approach.

(3) **Specification "F-2."** When the bridge superstructure is more than 150 feet in over-all length.

(a) There should be installed for each 150 feet, or fraction thereof, of the over-all length of the bridge superstructure one or more lights, each light consisting of a lamp of at least 100 watts, enclosed in aviation red obstruction light globes. These lights should be installed on the highest points of the superstructure at approximately equal intervals not exceeding 150 feet in a manner to indicate the general definition and extent of the obstruction, and to insure unobstructed visibility of the lights from aircraft at any normal angle of approach. The distance between these top lights may be increased to a distance not exceeding 600 feet when the particular bridge is located more than 15,000 feet from the reference point of any landing area.

(b) Where the bridge superstructure exceeds 150 feet in over-all length and the use of the above described obstruction lights would be impracticable or inadequate, flashing or rotating hazard beacons should be used as an alternate to the fixed obstruction lights. Such beacons should be located on the highest points or edge of the bridge superstructure at intervals not exceeding 3,000 feet, provided at least three beacons are installed to indicate the extent of the obstruction. The flashing or rotating beacons should conform to the provisions of the pertinent specifications as hereinbefore indicated under "obstruction lighting equipment."

[Statutory Authority: Chapter 47.68 RCW. 96-17-018 (Order 164), recodified as § 468-240-200, filed 8/13/96, effective 9/13/96; O.M.&L. standards (part), filed 9/13/61.]

WAC 468-240-205 Obstruction lighting standards—Water towers, grain elevators, gas holders and similar obstructions. Water towers, grain elevators, gas holders and similar obstructions should be lighted in accordance with the following specifications:

(1) **Specification "G-1."** When the particular obstruction is not more than 150 feet in over-all height above ground, or water if so situated.

(a) There should be installed at the top of the obstruction at least two lights, each light consisting of a lamp of at least 100 watts, enclosed in aviation red obstruction light globes. These lights should burn simultaneously and should be positioned so as to insure unobstructed visibility of at least one of the lights from aircraft at any normal angle of approach.

(2) **Specification "G-2."** When the particular obstruction is more than 150 feet but not more than 300 feet in over-all height above ground, or water if so situated.

(a) There should be installed at the top of the obstruction a flashing 300 mm electric code beacon equipped with two

(2001 Ed.)

lamps and aviation red color filters. The two lamps of the beacon should burn simultaneously and each should be at least 500 watts. The beacon should be positioned so as to insure unobstructed visibility of it from aircraft at any normal angle of approach.

(b) At the approximate midpoint of the over-all height of the obstruction, there should be installed three or more lights, each light consisting of a lamp of at least 100 watts, enclosed in aviation red obstruction light globes. The position of these intermediate lights on the vertical plane should be as close to an equidistant level between the top beacon and the ground level as the particular shape and type of construction of the obstruction will permit. These lights should be placed at regular intervals on the horizontal plane in a manner to insure unobstructed visibility of at least two of the lights from aircraft at any normal angle of approach.

(3) **Specification "G-3."** When the particular obstruction is more than 300 feet but not more than 450 feet in over-all height above ground, or water if so situated.

(a) There should be installed at the top of the obstruction a flashing 300 mm electric code beacon equipped with two lamps and aviation red color filters. The two lamps of the beacon should burn simultaneously and each should be at least 500 watts. The beacon should be positioned so as to insure unobstructed visibility of it from aircraft at any normal angle of approach.

(b) At approximately two-thirds and one-third of the over-all height of the obstruction there should be installed three or more lights, each light consisting of a lamp of at least 100 watts, enclosed in aviation red obstruction light globes. The position of these intermediate lights on the vertical plane should be as close to equidistant positions between the top beacon and the ground level as the particular shape and type of construction of the structure will permit. These lights should be placed at regular intervals on the horizontal plane in a manner to insure unobstructed visibility of at least two lights on each level from aircraft at any normal angle of approach.

[Statutory Authority: Chapter 47.68 RCW. 96-17-018 (Order 164), recodified as § 468-240-205, filed 8/13/96, effective 9/13/96; O.M.&L. standards (part), filed 9/13/61.]

WAC 468-240-210 Obstruction lighting standards—Group of structural hazards. Towers, poles, tanks, smokestacks and similar obstructions which are so grouped as to present a common hazard to air navigation should be lighted in accordance with the following specifications:

(1) **Specification "H-1."**

(a) This specification applies to a group of closely spaced towers, poles, tanks, smokestacks or similar obstructions of approximately the same over-all height above ground, or water if so situated, in which the spacing between the individual structures does not exceed 150 feet.

(b) The group may be considered an extensive obstruction and lighted in accordance with the "E" specifications for prominent buildings and similar extensive obstructions.

(2) **Specification "H-2."**

(a) This specification applies to a group of closely spaced towers, poles, tanks, smokestacks and similar obstructions, which may or may not be of the same over-all height,

in which the spacing between the individual structures is not in all cases equal to or less than 150 feet.

(b) Each prominent object within the group should be lighted in accordance with the specifications hereinbefore prescribed for individual towers, poles, and similar obstructions or a corresponding over-all height above ground, or water if so situated.

(c) In addition, there should be installed at the top of a prominent center obstruction or on a special tower located near the center of the group of obstructions, at least one rotating beacon producing aviation red flashes. The frequency of its flashes should be such as hereinbefore specified for rotating beacons.

[Statutory Authority: Chapter 47.68 RCW. 96-17-018 (Order 164), recodified as § 468-240-210, filed 8/13/96, effective 9/13/96; O.M.&L. standards (part), filed 9/13/61.]

WAC 468-240-215 Obstruction lighting standards—Hazard areas. Areas in which a visible or invisible hazard, or hazards, exists should be lighted in accordance with the following specifications.

(1) The obstruction lighting prescribed hereinafter is in addition to such lighting as may be necessary on any natural or manmade obstruction located within the hazard area.

(2) Specification "I-1."

(a) An area in which a visible or invisible hazard, or hazards, to aircraft exists.

(b) There should be mounted on top of a tower or other suitable structure, located near the center of the area, at least one rotating beacon producing aviation red flashes. The frequency of its flashes should be such as hereinbefore specified for rotating beacons.

(3) Specification "I-2."

(a) A large area in which a visible or invisible hazard, or hazards, to aircraft exists.

(b) There should be installed at two or more places around the perimeter of the area a rotating beacon, mounted on top of a tower or other suitable structure, producing aviation red flashes. The beacons should be located in a manner to insure unobstructed visibility of at least one of the beacons from aircraft at any normal angle of approach. The frequency of its flashes should be such as hereinbefore specified for rotating beacons.

[Statutory Authority: Chapter 47.68 RCW. 96-17-018 (Order 164), recodified as § 468-240-215, filed 8/13/96, effective 9/13/96; O.M.&L. standards (part), filed 9/13/61.]

APPENDIX

WAC 468-240-350 Appendix rules—General. (1) The main body of this publication presents standards for marking and lighting objects, which are potential hazards to the safe operation of aircraft, for the purpose of indicating their presence to pilots. The material in this appendix includes texts of laws and regulations, together with information to provide guidance in complying with these texts of laws and regulations, pertaining to such objects.

(2) Existing or contemplated structures which, by reason of their height and location relative to landing areas, constitute potential hazards to the safe operation of aircraft contin-

ually demand attention in the effort to provide and maintain maximum safety for air commerce.

(3) It is vitally important that prompt notification of the construction or alteration of towers, electric transmission and telephone lines, smokestacks, water towers, buildings and similar structures, of certain heights and distances from landing areas and civil airways, be given to the aeronautical public through notices to airmen before any such structure is constructed or altered. Achievement of this result requires the cooperation of all federal, state and municipal agencies, private industry and individuals engaged in such construction or alteration.

(4) For this purpose, regulations of the Washington state aeronautics commission have been promulgated requiring the submission of Form 426 prior to the beginning of the construction or alteration of structures falling within the prescribed limits of air activity. The limits within which construction or alteration requires the submission of the form have been set after careful study of the problem and with due regard for the maximum protection of airmen.

(5) In the case of an existing structure on which a proper notice has already been submitted, some latitude for repairs is permitted by an explanation of the term "alteration." Notice may be omitted if the alteration or alterations will not increase or decrease the height of the top or any part of the structure from that previously reported by more than 1 foot for each 500 feet, or fraction thereof, of the distance that the structure is situated from the nearest boundary of the landing area involved. However, notice must be given of any alteration or alterations increasing or decreasing the height of the top or any part of a structure by more than 10 feet from that previously reported.

(6) The information required on proposed construction or alteration is clearly explained in the Form 426 prepared for that purpose and is essentially that material needed to warn airmen of a potential hazard to air navigation. It is necessary, therefore, that all applicable questions therein be answered without exception. Copies of these forms may be obtained from the Washington State Aeronautics Commission, Boeing Field, Seattle, Washington.

(7) The distance between the nearest boundary of a landing area and the site of the construction or alteration may be measured by the use of maps, or on the surface of the earth by an automobile mileage meter, or other convenient but reasonably accurate means.

(8) The term "navigable water" as used in connection with obstructions to air navigation, denotes all water suitable for the take-off or landing of water aircraft. Other geographical features which combine hydrographic and topographic characteristics, such as marshes, swamps and bogs, come within the meaning of the term "ground" as described in the act.

(9) The state aeronautics commission desires to assist those contemplating construction which may present a potential hazard to air navigation in selecting locations for the structures which will create a minimum of interference with air operations; to recommend the proper obstruction marking and lighting to insure adequate protection to aircraft; and to minimize the possibility of damage to structures from collision by aircraft.

(10) For this purpose the commission has provided a special advisory service consisting of personnel who conduct the specific investigation of each case. This service is available upon request, which may be by letter or in person. The request should be accompanied by a complete description of the proposed construction, including the geographic coordinates and the distance and direction of the site from the nearest town; the distance from the nearest landing area; the height of the structure above the ground and the over-all height of the structure above mean sea level. A map or sketch showing the height and location of all tall structures in the vicinity should also be furnished. The investigation will ordinarily take approximately ten days because of the necessary contacts with aeronautical interests concerned. This period may be longer if the problem is a complex one, because every attempt is made by the investigators to resolve the problem with due regard to the safety factor.

(11) Interested contractors, engineers and architects should avail themselves of this service so as to prevent delays in obtaining the necessary permits for the construction.

[Statutory Authority: Chapter 47.68 RCW. 96-17-018 (Order 164), recodified as § 468-240-350, filed 8/13/96, effective 9/13/96; O.M.&L. standards, appendix (part), filed 9/13/61.]

WAC 468-240-360 Appendix rules—Criteria for determining obstructions to air navigation. (1) Introduction. In order to provide uniform criteria for determining obstructions to air navigation, this standard has been adopted by the Washington state aeronautics commission.

(2) Directive. In accordance with the procedure for establishing technical aeronautical standards specified in state obstruction marking and lighting law, "Criteria for determining obstructions to air navigation" set forth below is established as a state standard. This standard is the official Washington state aeronautics commission guide for determining obstructions to air navigation and supersedes all existing obstruction criteria which do not conform to its requirements.

(3) Specific instructions. Procedure for determining obstructions.

(a) Any structure or obstacle which obstructs the air space above ground or water level, when determined by the commission after a hearing to be a hazard or potential hazard to the safe flight of aircraft, shall be plainly marked, illuminated, painted, lighted or designated in a manner to be approved in accordance with the general rules and regulations of the commission so that the same will be clearly visible to airmen. In determining which structures or obstacles constitute or may become a hazard to air flight, the commission shall take into account only those obstacles located at river, lake and canyon crossings and in other low altitude flight paths usually traveled by aircraft. (Same as RCW 14.04.340.)

(b) The director shall have the authority to require owners, operators, lessees or others having the control or management of structures or obstacles over one hundred fifty feet above ground or water level and which are or may become a hazard to air flight to report the location of such existing or proposed structures or obstacles to the commission. For that purpose the director may issue subpoenas and subpoenas

(2001 Ed.)

duces tecum returnable within twenty days to the commission. In the event a person refuses to obey the director's subpoena, the commission may certify to the superior court all facts of any such refusal. The court shall summarily hear evidence on such refusal, and, if the evidence warrants, punish such person refusing in the same manner and to the same extent as for contempt committed before the court. (Same as RCW 14.04.350.)

(c) Objects which are located or will be located with respect to other objects of a permanent character such that there results no material increase in the aeronautical hazard will not be considered obstructions.

[Statutory Authority: Chapter 47.68 RCW. 96-17-018 (Order 164), recodified as § 468-240-360, filed 8/13/96, effective 9/13/96; O.M.&L. standards, appendix (part), filed 9/13/61.]

WAC 468-240-370 Appendix rules—Operation of moored balloons. (1) Scope. The following rules shall apply to moored balloons when operated anywhere in the state of Washington at altitude controlled by state law.

(2) General. Moored balloons may be operated without permit from or notice to the state when operated less than 150 feet above the surface at a location not usually traveled by aircraft.

(3) Operation requiring a permit. Unless operated under the conditions specified in "general" moored balloons subject to these regulations shall be operated under the authority of and in compliance with the terms and conditions of a permit issued by the state aeronautics commission when such moored balloons are operated:

- (a) Closer than 500 feet to the base of any cloud; or
- (b) During the hours of darkness; or
- (c) When ground visibility is less than 3 miles; or
- (d) At altitudes more than 150 feet above the surface; or
- (e) In a location usually traveled by aircraft.

(4) Written notice of intent must be submitted to the office of the commission at least 30 days prior to the date of operation. Such notice shall contain the name and address of the owner and person operating the balloon, the date or dates of the proposed operation, and the location and altitude at which the proposed operation will be conducted. No moored balloons will be operated without written approval from the Washington state aeronautics commission.

(5) Rapid deflation device. No moored balloon having a diameter of more than 6 feet or a gas capacity of more than 115 cubic feet shall be operated unless it is equipped with a device or means of automatic and rapid deflation in the event of an escape from its moorings.

[Statutory Authority: Chapter 47.68 RCW. 96-17-018 (Order 164), recodified as § 468-240-370, filed 8/13/96, effective 9/13/96; O.M.&L. standards, appendix (part), filed 9/13/61.]

WAC 468-240-380 Appendix rules—Illustrations.

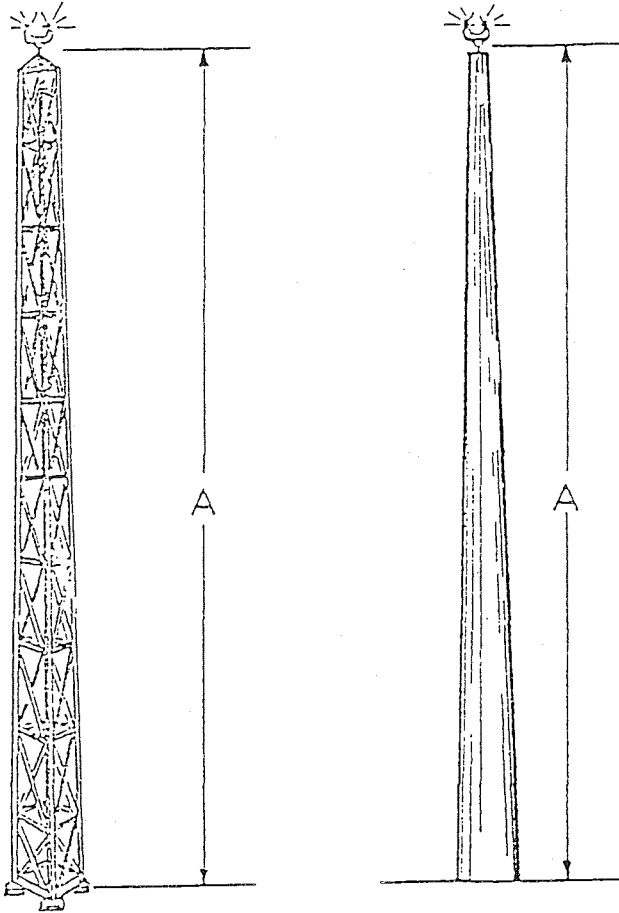

A = NOT MORE THAN 150 FT.
 (1) Lighting of towers, poles and similar obstructions.

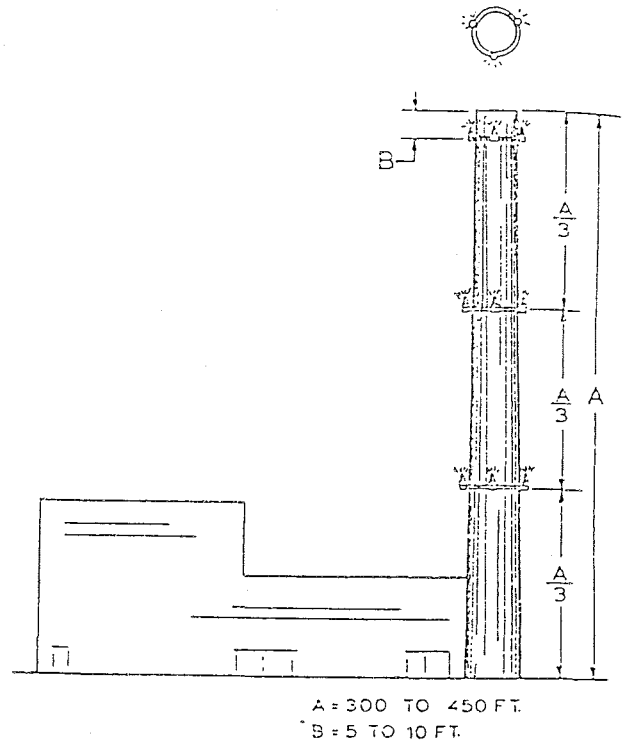

(2) Lighting of smokestacks and similar obstructions.

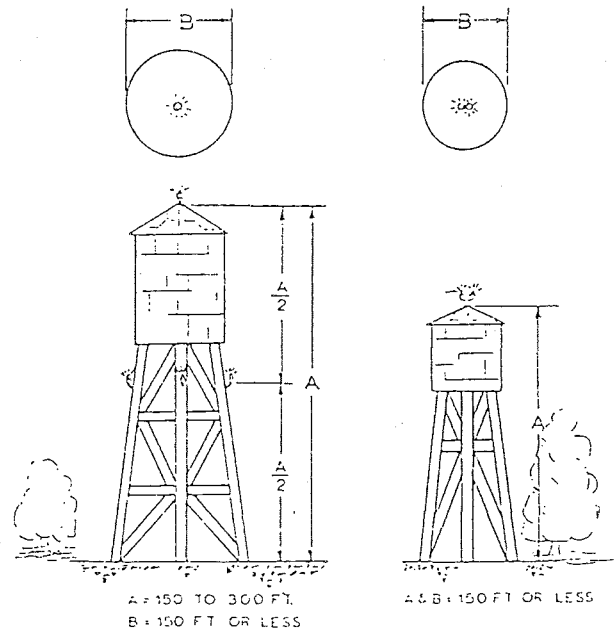

(3) Lighting of water towers and similar obstructions.

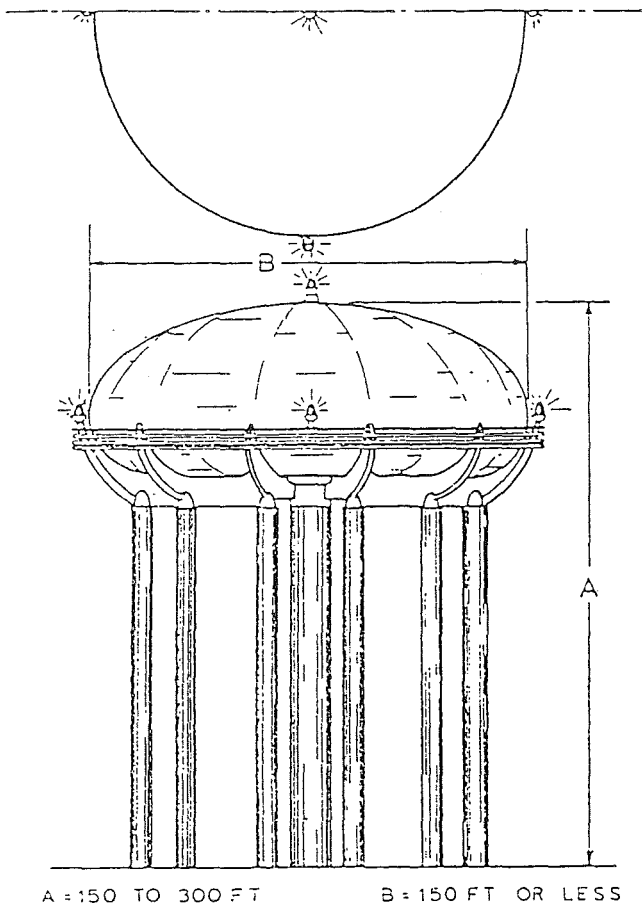

(4) Lighting of water towers and similar obstructions.

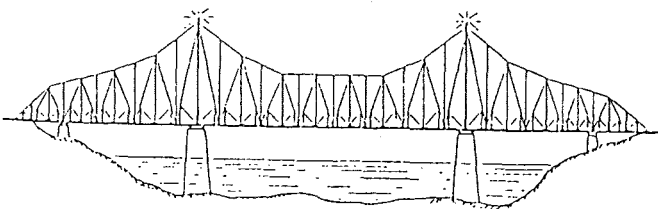

(5) Lighting of bridges.

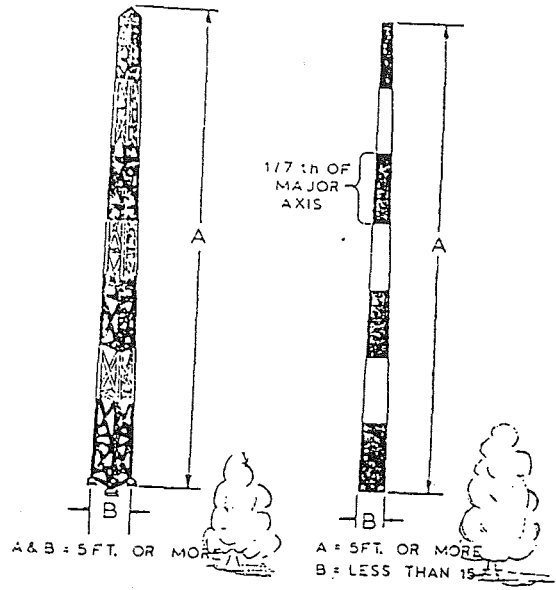

(6) Painting of towers, poles and similar obstructions.

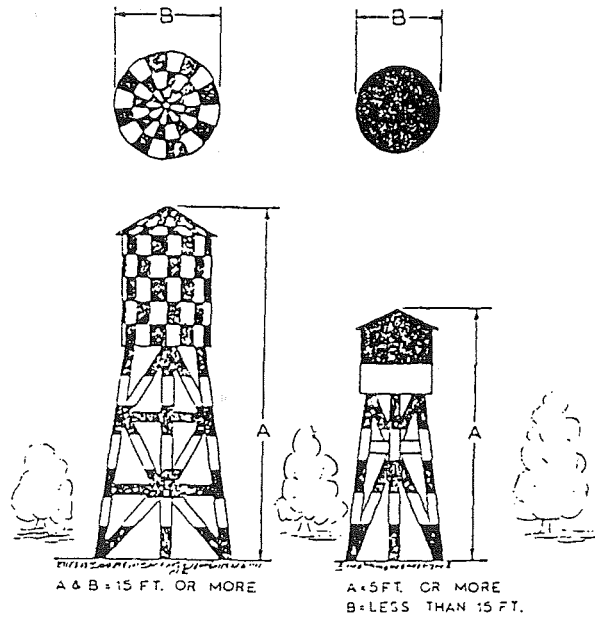

(7) Painting of water towers and similar obstructions.

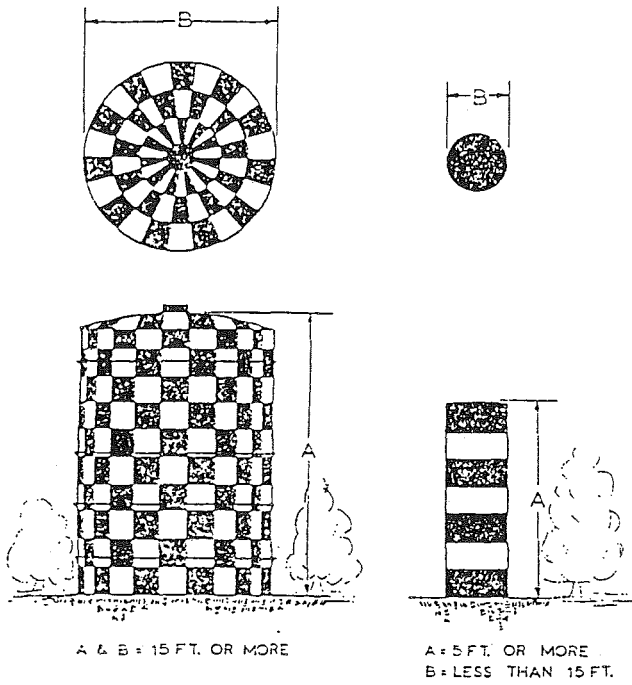

(8) Painting of gas holders and similar obstructions.

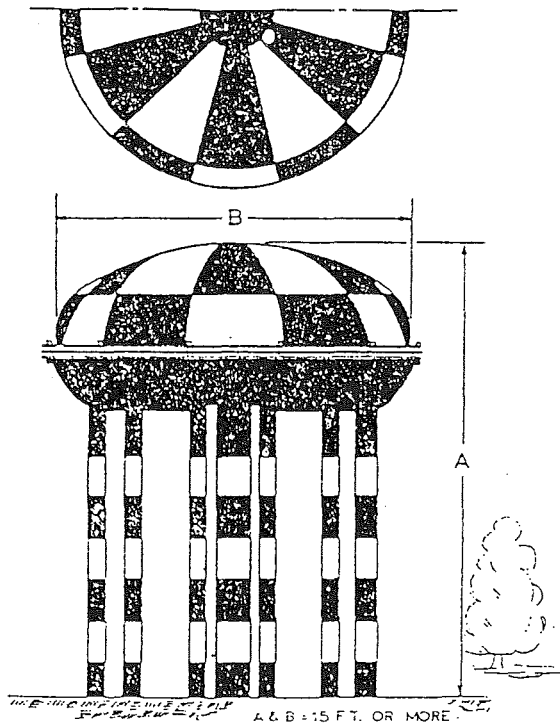

(9) Painting of water towers and similar obstructions.

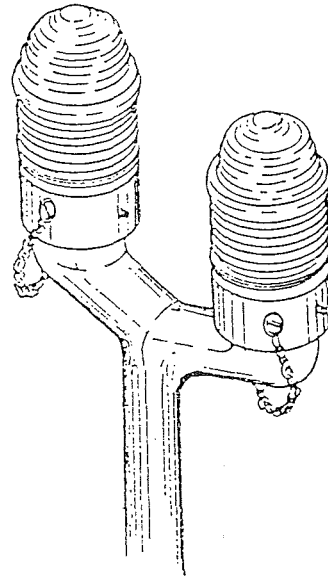

(10) Typical double obstruction light fitting.

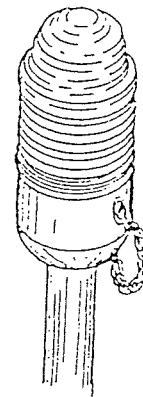

(11) Typical single obstruction light fitting.

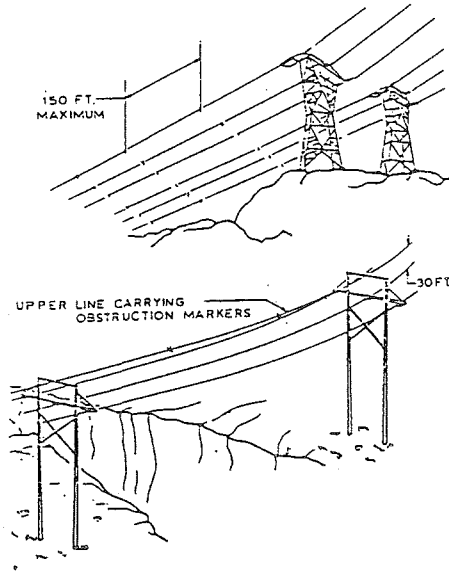

(12) Marking power lines, cables and similar obstructions.

[Statutory Authority: Chapter 47.68 RCW. 96-17-018 (Order 164), recodified as § 468-240-380, filed 8/13/96, effective 9/13/96; O.M.&L. standards, appendix (part), filed 9/13/61.]

**Chapter 468-250 WAC
STATE AIRPORT RULES**

WAC

468-250-010	Definitions.
468-250-020	Aeronautics division to manage.
468-250-030	Opening and closing of airports.
468-250-040	Controlled operations.
468-250-050	Fees.
468-250-060	Nondiscrimination.
468-250-070	Exclusive grants prohibited.
468-250-080	Representations.
468-250-090	Provisions in agreements.
468-250-100	State/federal agreements controlling.
468-250-110	Grounds for refusal to grant agreement.
468-250-120	Preexisting agreements.
468-250-130	All use at own risk.
468-250-140	Temporary rules.
468-250-150	Accident notification.
468-250-160	Hazard notification.
468-250-170	Littering.

WAC 468-250-010 Definitions. (1) "State airport" means any airport operated by the department of transportation, whether by agreement or ownership, including all real and personal property associated with the operation of the airport whether or not such property is owned by the department of transportation.

(2) "Controlled user" means any user of the airport whose use is controlled by an agreement with the department of transportation, including other governmental agencies.

(3) "Noncontrolled user" means any other person not included in subsection (2) of this section.

(4) "Special use permit" means any permit issued by the department of transportation to any person for the conduct of activities at a state airport which are noncommercial in nature, such as (but not limited to) testing equipment, tempo-

(2001 Ed.)

rary easements, and long term parking of vehicles other than aircraft. A fee may or may not be charged.

(5) "Letter of agreement" means a letter issued to a person by the department of transportation trading the services of that person at a state airport for some benefit to that person. No fee will be charged.

(6) "NOTAM" means a notice to airmen issued by the Federal Aviation Administration.

(7) "Flowage fee" means a fee charged by the department of transportation on the amount of fuel delivered into aircraft at a state airport.

[Statutory Authority: Chapter 47.68 RCW. 96-17-018 (Order 164), recodified as § 468-250-010, filed 8/13/96, effective 9/13/96. Statutory Authority: RCW 47.68.100 and 47.68.210. 83-11-041 (Order 80), § 12-40-010, filed 5/18/83.]

WAC 468-250-020 Aeronautics division to manage.

The assistant secretary for aeronautics shall exercise all management powers incident to the operation of state airports.

[Statutory Authority: Chapter 47.68 RCW. 96-17-018 (Order 164), recodified as § 468-250-020, filed 8/13/96, effective 9/13/96. Statutory Authority: RCW 47.68.100 and 47.68.210. 83-11-041 (Order 80), § 12-40-020, filed 5/18/83.]

WAC 468-250-030 Opening and closing of airports.

(1) Because of surface conditions and/or snow cover, the following state airports will be closed to all traffic (except in an emergency) from approximately October 1 to June 1 of each year, by NOTAM.

- (a) Bandera
- (b) Lester
- (c) Nason Creek
- (d) Stehekin
- (e) Avey
- (f) Lake Wenatchee
- (g) Copalis
- (h) Sullivan Lake
- (i) Tieton
- (j) Ranger Creek
- (k) Skykomish
- (l) Easton

(2) The following state airports may be closed during the winter due to conditions, by NOTAM.

- (a) Winthrop/Intercity
- (b) Little Goose
- (c) Lower Granite
- (d) Quillayute
- (e) Lower Monumental
- (f) Woodland

(3) Opening and closing dates may change at some airports, and pilots shall check NOTAMS prior to using any state airport. It is strongly suggested that even when open, pilots should check with the aeronautics division on current conditions, especially at those airports located in mountainous areas.

[Statutory Authority: Chapter 47.68 RCW. 96-17-018 (Order 164), recodified as § 468-250-030, filed 8/13/96, effective 9/13/96. Statutory Authority: RCW 47.68.100 and 47.68.210. 83-11-041 (Order 80), § 12-40-030, filed 5/18/83.]

WAC 468-250-040 Controlled operations. (1) The department of transportation may enter into any contract, lease, special use permit, letter of agreement, or other arrangement with any person for controlled operations at state airports.

(2) All controlled operations shall be conducted only under an agreement with the department of transportation.

(3) The following operations require the execution of an agreement, lease, special use permit, or other arrangement as appropriate, between the department of transportation, and the controlled user:

(a) Any construction on a state airport;

(b) The permanent, semipermanent or seasonal use of hangars or tie-downs on a state airport, except transient use;

(c) Any right-of-ground access other than by public roadway or easement, so called "through the fence" operations;

(d) Fuel sales or storage at a state airport;

(e) Long term parking of vehicles or storage of property;

(f) Exchange of services between the department of transportation and a person or group;

(g) Any commercial operation, except transient non-scheduled air taxi operations;

(h) Any use of airport property which is not incidental to normal airport operations;

(i) Glider towing, parachuting, ballooning, and ultralight use at state airports, except transient;

(j) Any other use as may be designated by the department of transportation.

[Statutory Authority: Chapter 47.68 RCW. 96-17-018 (Order 164), recodified as § 468-250-040, filed 8/13/96, effective 9/13/96. Statutory Authority: RCW 47.68.100 and 47.68.210. 83-11-041 (Order 80), § 12-40-040, filed 5/18/83.]

WAC 468-250-050 Fees. (1) Any contract, lease, or special use permit executed may require the payment of fees to the department of transportation. Services may be accepted in lieu of fees, but only by prior agreement. No services will be applied to past fees incurred.

(2) All fees collected under this section by the department of transportation will be credited towards maintenance of all state airports.

(3) Fees for commercial operations will be commensurate with the value of the opportunity to do business on or at the airport and the services and facilities furnished by the state at the airport for which no separate charge is made.

[Statutory Authority: Chapter 47.68 RCW. 96-17-018 (Order 164), recodified as § 468-250-050, filed 8/13/96, effective 9/13/96. Statutory Authority: RCW 47.68.100 and 47.68.210. 83-11-041 (Order 80), § 12-40-050, filed 5/18/83.]

WAC 468-250-060 Nondiscrimination. No controlled user shall discriminate on the basis of race, sex, age, or national origin in the hiring and dismissal of employees, or in the use of his facilities.

[Statutory Authority: Chapter 47.68 RCW. 96-17-018 (Order 164), recodified as § 468-250-060, filed 8/13/96, effective 9/13/96. Statutory Authority: RCW 47.68.100 and 47.68.210. 83-11-041 (Order 80), § 12-40-060, filed 5/18/83.]

[Title 468 WAC—p. 160]

WAC 468-250-070 Exclusive grants prohibited. The department of transportation will not grant exclusive use rights of any kind at a state airport.

[Statutory Authority: Chapter 47.68 RCW. 96-17-018 (Order 164), recodified as § 468-250-070, filed 8/13/96, effective 9/13/96. Statutory Authority: RCW 47.68.100 and 47.68.210. 83-11-041 (Order 80), § 12-40-070, filed 5/18/83.]

WAC 468-250-080 Representations. No controlled user shall, in connection with raising any investment funds or advertising, represent to anyone that they have the endorsement, support, or approval of the state for any development or plan of action unless and until such endorsement has been given in writing.

[Statutory Authority: Chapter 47.68 RCW. 96-17-018 (Order 164), recodified as § 468-250-080, filed 8/13/96, effective 9/13/96. Statutory Authority: RCW 47.68.100 and 47.68.210. 83-11-041 (Order 80), § 12-40-080, filed 5/18/83.]

WAC 468-250-090 Provisions in agreements. All leases, special use permits, letters of agreement, or other documents shall contain the following provisions, as applicable:

(1) Transferability of any agreement is contingent on approval by the department of transportation. This shall include the sale of stock in a controlled user which would change the management of that use;

(2) All applicable Federal Aviation Administration regulations will be adhered to, and any violation of those regulations may be deemed a violation of the controlled user's agreement;

(3) In the event of violation of the terms of any agreement, the department of transportation will serve notice of the violation and where appropriate, notice of the corrective action that must be taken by the controlled user or notice of intention to forfeit said agreement. Provided, no forfeiture shall be taken before the expiration of ten days, during which time the controlled user may give notice of appeal to the secretary of transportation, who shall hear such appeal at a public meeting within thirty days and render a decision within five days of the public meeting;

(4) Commercial users shall, if deemed necessary by the department of transportation, give bond in favor of the state of Washington for the value of one year's fees, or the total of the value of the agreement if less than one year in term;

(5) Facilities constructed on state property under any agreement with the department of transportation shall become property of the department of transportation at the conclusion of the agreement including any renewals, extensions, or renegotiations of the agreement;

(6) Any disputes between a controlled user and the department of transportation, except violations of agreements for which forfeiture is sought, shall be submitted in writing to the secretary of transportation. The secretary shall provide a written decision within ten days which shall be the final, binding disposition of the the dispute;

(7) All facilities shall be open to inspection of department of transportation personnel at all times;

(8) Controlled users shall, as appropriate:

(a) Maintain insurance against fire, windstorm, and other hazards and, if applicable, hangar-keepers insurance;

(b) Maintain policies of public liability insurance in such amount as the department of transportation shall require;

(c) Hold the state harmless for all claims of liability arising from their use, and provide the department of transportation with certificate evidencing their insurance coverage and naming the state of Washington as an additional insured.

[Statutory Authority: Chapter 47.68 RCW. 96-17-018 (Order 164), recodified as § 468-250-090, filed 8/13/96, effective 9/13/96. Statutory Authority: RCW 47.68.100 and 47.68.210. 83-11-041 (Order 80), § 12-40-090, filed 5/18/83.]

WAC 468-250-100 State/federal agreements controlling. Where the state of Washington has entered into an agreement with the federal government concerning a specific airport, that agreement will control, where applicable, any agreement sought or subsequently granted to a controlled user.

[Statutory Authority: Chapter 47.68 RCW. 96-17-018 (Order 164), recodified as § 468-250-100, filed 8/13/96, effective 9/13/96. Statutory Authority: RCW 47.68.100 and 47.68.210. 83-11-041 (Order 80), § 12-40-100, filed 5/18/83.]

WAC 468-250-110 Grounds for refusal to grant agreement. The department of transportation may refuse to grant an operating agreement to any person if:

- (1) Safety will be compromised;
- (2) The proposed operation is not consistent with airport purposes;
- (3) The proposed operation is not in the best interests of the state of Washington; or
- (4) The proposed operation is in conflict with prior agreements.

[Statutory Authority: Chapter 47.68 RCW. 96-17-018 (Order 164), recodified as § 468-250-110, filed 8/13/96, effective 9/13/96. Statutory Authority: RCW 47.68.100 and 47.68.210. 83-11-041 (Order 80), § 12-40-110, filed 5/18/83.]

WAC 468-250-120 Preexisting agreements. Any agreements existing on the date of this section shall continue in force under the terms of the agreement. All subsequent or renewal agreements will be made in conformance with these rules.

[Statutory Authority: Chapter 47.68 RCW. 96-17-018 (Order 164), recodified as § 468-250-120, filed 8/13/96, effective 9/13/96. Statutory Authority: RCW 47.68.100 and 47.68.210. 83-11-041 (Order 80), § 12-40-120, filed 5/18/83.]

WAC 468-250-130 All use at own risk. The use of state airports by all persons shall be solely at the risk of the user. State airports are maintained principally for emergency use and the state does not warrant the conditions at any state airport to be suitable for any other use.

[Statutory Authority: Chapter 47.68 RCW. 96-17-018 (Order 164), recodified as § 468-250-130, filed 8/13/96, effective 9/13/96. Statutory Authority: RCW 47.68.100 and 47.68.210. 83-11-041 (Order 80), § 12-40-130, filed 5/18/83.]

WAC 468-250-140 Temporary rules. The department of transportation may, from time to time, issue temporary and/or emergency rules affecting one or more state airports. These rules will be available from the aeronautics division

(2001 Ed.)

and may be distributed, as necessary, by other means, including NOTAM.

[Statutory Authority: Chapter 47.68 RCW. 96-17-018 (Order 164), recodified as § 468-250-140, filed 8/13/96, effective 9/13/96. Statutory Authority: RCW 47.68.100 and 47.68.210. 83-11-041 (Order 80), § 12-40-140, filed 5/18/83.]

WAC 468-250-150 Accident notification. Any person involved in or witnessing an accident or hazardous incident at a state airport shall report such accident or incident to the aeronautics division as soon as possible. The report is required in addition to reports required under National Transportation Safety Board Rules, Part 830.

[Statutory Authority: Chapter 47.68 RCW. 96-17-018 (Order 164), recodified as § 468-250-150, filed 8/13/96, effective 9/13/96. Statutory Authority: RCW 47.68.100 and 47.68.210. 83-11-041 (Order 80), § 12-40-150, filed 5/18/83.]

WAC 468-250-160 Hazard notification. Any person having knowledge of hazards at or near a state airport is encouraged to notify the aeronautics division of the nature of the hazard.

[Statutory Authority: Chapter 47.68 RCW. 96-17-018 (Order 164), recodified as § 468-250-160, filed 8/13/96, effective 9/13/96. Statutory Authority: RCW 47.68.100 and 47.68.210. 83-11-041 (Order 80), § 12-40-160, filed 5/18/83.]

WAC 468-250-170 Littering. Because of their remote location, many state airports have no provision for trash removal. Users are expected to pack out all trash. Persons littering state airports will be prosecuted under the Litter Control Act, chapter 70.93 RCW.

[Statutory Authority: Chapter 47.68 RCW. 96-17-018 (Order 164), recodified as § 468-250-170, filed 8/13/96, effective 9/13/96. Statutory Authority: RCW 47.68.100 and 47.68.210. 83-11-041 (Order 80), § 12-40-170, filed 5/18/83.]

Chapter 468-300 WAC

STATE FERRIES AND TOLL BRIDGES

(Formerly chapter 252-300 WAC.)

WAC

468-300-010	Ferry passenger tolls.
468-300-020	Vehicle under 20', motorcycle, and stowage ferry tolls.
468-300-040	Oversize vehicle ferry tolls.
468-300-100	Leases of facilities and facility space.
468-300-220	Calculation of charter rates for vessels owned by the Washington state ferry system.
468-300-600	Policy governing distribution of materials on ferry vessels and at ferry terminals.
468-300-610	No smoking areas.
468-300-700	Preferential loading.

DISPOSITION OF SECTIONS FORMERLY CODIFIED IN THIS CHAPTER

468-300-005	Port Townsend-Edmonds and Lofall-Southpoint ferry fares. [Statutory Authority: RCW 47.60.325. 80-04-104 (Order 15, Resolution No. 72), § 468-300-005, filed 4/1/80; 79-09-136 (Order 11, Resolution No. 57), § 468-300-005, filed 9/5/79. Statutory Authority: RCW 47.56.030 and 47.60.325. 79-06-037 (Order 8, Resolution No. 48), § 468-300-005, filed 5/17/79, effective 6/17/79.] Repealed by 85-11-007 (Order 44, Resolution No. 241), filed 5/3/85. Statutory Authority: RCW 47.60.326.
468-300-030	Oversized vehicle, stage and bus, newspaper, express shipment and medical supplies ferry tolls. [Statutory

[Title 468 WAC—p. 161]

- Authority: RCW 47.60.326, 86-06-010 (Order 54, Resolution No. 263), § 468-300-030, filed 2/21/86; 85-11-007 (Order 44, Resolution No. 241), § 468-300-030, filed 5/3/85; 84-11-052 (Order 42, Resolution Nos. 221 and 222), § 468-300-030, filed 5/17/84; 84-10-002 (Order 41, Resolution No. 218), § 468-300-030, filed 4/20/84; 83-07-062 (Order 33, Resolution No. 175), § 468-300-030, filed 3/22/83; 82-18-009 (Order 29, Resolution No. 153), § 468-300-030, filed 8/20/82; 82-07-063 (Order 28, Resolution No. 143), § 468-300-030, filed 3/22/82. Statutory Authority: RCW 47.60.325 and 47.56.030. 81-15-099 (Order 23, Resolution No. 117), § 468-300-030, filed 7/22/81. Statutory Authority: RCW 47.60.325. 81-08-044 (Order 17, Resolution No. 104), § 468-300-030, filed 3/31/81; 80-04-104 (Order 15, Resolution No. 72), § 468-300-030, filed 4/1/80; 79-09-136 (Order 11, Resolution No. 57), § 468-300-030, filed 9/5/79; 79-04-047 (Order 6, Resolution No. 44), § 468-300-030, filed 3/27/79; 78-06-040 (Order 2, Resolution No. 21), § 468-300-030, filed 5/19/78.] Repealed by 87-12-005 (Order 61, Resolution No. 298), filed 5/21/87. Statutory Authority: RCW 47.56.030 and 47.60.326.
- 468-300-050 Trailer ferry tolls. [Statutory Authority: RCW 47.60.325 and 47.56.030. 81-15-099 (Order 23, Resolution No. 117), § 468-300-050, filed 7/22/81. Statutory Authority: RCW 47.60.325. 81-08-044 (Order 17, Resolution No. 104), § 468-300-050, filed 3/31/81; 80-04-104 (Order 15, Resolution No. 72), § 468-300-050, filed 4/1/80; 79-09-136 (Order 11, Resolution No. 57), § 468-300-050, filed 9/5/79; 79-04-047 (Order 6, Resolution No. 44), § 468-300-050, filed 3/27/79; 78-06-040 (Order 2, Resolution No. 21), § 468-300-050, filed 5/19/78.] Repealed by 82-07-063 (Order 28, Resolution No. 143), filed 3/22/82. Statutory Authority: RCW 47.60.326.
- 468-300-060 Round trip party ferry tolls. [Statutory Authority: RCW 47.60.325. 78-06-040 (Order 2, Resolution No. 21), § 468-300-060, filed 5/19/78.] Repealed by 79-04-047 (Order 6, Resolution No. 44), filed 3/27/79. Statutory Authority: RCW 47.60.325.
- 468-300-070 Noncommercial vehicle with trailer, oversize vehicle, stage and bus, newspaper, express shipments and medical supplies ferry tolls. [Statutory Authority: RCW 47.56.030 and 47.60.326. 91-18-022 (Order 72), § 468-300-070, filed 8/27/91, effective 9/27/91; 89-14-052 (Order 67, Resolution No. 354), § 468-300-070, filed 6/30/89; 89-04-014 (Order 66, Resolution No. 343), § 468-300-070, filed 1/23/89, effective 7/1/89; 87-12-005 (Order 61, Resolution No. 298), § 468-300-070, filed 5/21/87. Statutory Authority: RCW 47.60.326. 86-06-010 (Order 54, Resolution No. 263), § 468-300-070, filed 2/21/86; 85-11-007 (Order 44, Resolution No. 241), § 468-300-070, filed 5/3/85; 84-11-052 (Order 42, Resolution Nos. 221 and 222), § 468-300-070, filed 5/17/84; 83-07-062 (Order 33, Resolution No. 175), § 468-300-070, filed 3/22/83; 82-18-009 (Order 29, Resolution No. 153), § 468-300-070, filed 8/20/82.] Repealed by 92-18-005, filed 8/20/92, effective 9/20/92. Statutory Authority: RCW 47.56.030 and 47.60.326.
- 468-300-210 Transporting hazardous materials on Washington state ferries. [Statutory Authority: RCW 47.56.030 and 47.60.326. 96-14-004, § 468-300-210, filed 6/20/96, effective 7/21/96; 87-20-041 (Order 63, Resolution No. 308), § 468-300-210, filed 10/1/87.] Repealed by 97-15-110 (Order 83), filed 7/22/97, effective 8/22/97. Statutory Authority: RCW 47.01.061, 47.56.032 and 1997 c 323.
- 468-300-410 Hood Canal bridge toll schedule. [Statutory Authority: RCW 47.60.326. 85-11-007 (Order 44, Resolution No. 241), § 468-300-410, filed 5/3/85. Statutory Authority: RCW 47.56.030 and 47.60.326. 83-13-100 (Order 37, Resolution No. 191), § 468-300-410, filed 6/21/83. Statutory Authority: RCW 47.60.326. 82-20-001 (Order 32, Resolution No. 159), § 468-300-410, filed 9/24/82.] Repealed by 92-18-005, filed 8/20/92, effective 9/20/92. Statutory Authority: RCW 47.56.030 and 47.60.326.
- 468-300-500 Second Lake Washington toll bridge toll schedule. [Statutory Authority: 1977 ex.s. c 151. 79-01-033 (DOT Order 10 and Comm. Order 1, Resolution No. 13), § 468-300-500, filed 12/20/78. Formerly chapter 252-300 WAC (part) (uncodified) and WAC 252-300-010.] Repealed by 80-04-104 (Order 15, Resolution No. 72), filed 4/1/80. Statutory Authority: RCW 47.60.325.
- 468-300-510 Spokane River toll bridge. [Statutory Authority: RCW 47.60.326. 85-11-007 (Order 44, Resolution No. 241), § 468-300-510, filed 5/3/85. Statutory Authority: RCW 47.56.240. 81-10-006 (Order 18, Resolution No. 105), § 468-300-510, filed 4/24/81.] Repealed by 92-18-005, filed 8/20/92, effective 9/20/92. Statutory Authority: RCW 47.56.030 and 47.60.326.

WAC 468-300-010 Ferry passenger tolls.

Effective 03:00 a.m. December 31, 2000

ROUTES	Full Fare	Senior/ Disabled	Youth Fare 18 and under	Frequent User Ticket Book 20 Rides ¹	Monthly Pass ⁵	Quarterly Pass ⁵	Annual Pass ⁵	Bicycle Surcharge ^{2,6}
<i>Via Passenger-Only Ferry</i>								
*Seattle-Vashon								
*Seattle-Bremerton	3.70	1.80	2.60	26.00	54.60	163.80	655.20	0.70
<i>Via Auto Ferry</i>								
*Fauntleroy-Southworth								
*Seattle-Bremerton								
*Seattle-Bainbridge Island								
*Edmonds-Kingston	3.70	1.80	2.60	26.00	54.60	163.80	655.20	0.70
Port Townsend-Keystone	1.85	0.90	1.40	26.00	N/A	N/A	N/A	0.35
*Fauntleroy-Vashon								
* Southworth-Vashon								
*Pt. Defiance-Tahlequah								
*Mukilteo-Clinton	2.50	1.20	1.80	17.50	36.80	110.40	441.60	0.70
*Anacortes to Lopez, Shaw, Orcas or Friday Harbor	5.30	2.60	3.80	37.25	N/A	N/A	N/A	3.00
Between Lopez, Shaw, Orcas and Friday Harbor ⁴	N/C	N/C	N/C	N/C	N/A	N/A	N/A	N/C
<i>International Travel</i>								
Anacortes to Sidney and Sidney to all destinations	9.10	4.50	6.40	N/A	N/A	N/A	N/A	4.60
From Lopez, Shaw+, Orcas and Friday Harbor to Sidney@	4.00	2.00	2.80	N/A	N/A	N/A	N/A	1.75
Lopez, Shaw, Orcas and Friday Harbor to Sidney (round trip) ³	13.10	6.50	9.20	N/A	N/A	N/A	N/A	6.35

@ These fares rounded to the next multiple of \$.25. All other fares rounded to the next multiple of \$0.10.

* These routes operate as a one-point toll collection system.

¹FREQUENT USER TICKETS - Shall be valid only for 90-days from date of purchase after which time the tickets shall not be accepted for passage.

²BICYCLE SURCHARGE - Is an addition to the appropriate passenger fare.

³ROUND TRIP - Round trip tickets for international travel available for trips beginning or ending on one of the Islands served.

⁴INTER-ISLAND FARES - Passenger fares included in Anacortes tolls.

⁵EMPLOYER PASSES - A monthly passenger pass is available for all routes except: Anacortes/San Juan Island/Sidney and Port Townsend/Keystone, as a pilot program. The pass is available through some local employers. It is a flash pass valid for the month printed on the pass and will be presented to Washington state ferries staff whenever a passenger fare is collected. This pass is based on 21 days of passenger travel with a 30% discount. The quarterly pass is based on 63 days of travel with a 30% discount and the annual pass is based on 252 days with a 30% discount.

⁶BICYCLE PASS - A bicycle pass is available on all routes except: Anacortes/San Juan Island/Sidney for a \$20.00 annual fee subject to meeting WSF specified conditions. The pass is valid for one year. A cyclist with a valid pass shall have the bicycle surcharge waived.

CHILDREN/YOUTH - Children under five years of age will be carried free when accompanied by parent or guardian. Children/youths five through eighteen years of age will be charged the youth fare, which will be 70% of full fare rounded to the next multiple of \$0.10.

SENIOR CITIZENS - Passengers age 65 and over, with proper identification establishing proof of age, may travel at half-fare passenger tolls on any route where passenger fares are collected.

PERSONS OF DISABILITY - Any individual who, by reason of illness, injury, congenital malfunction, or other incapacity or disability is unable without special facilities or special planning or design to utilize ferry system services, upon presentation of a WSF Disability Travel Permit, Regional Reduced Fare Permit, or other identification which establishes a disability may travel at half-fare passenger tolls on any route. In addition, those persons with disabilities who require attendant care while traveling on the ferries, and are so certified by their physician, may obtain an endorsement on their WSF Disability Travel Permit and such endorsement shall allow the attendant to travel free as a passenger.

BUS PASSENGERS - Passengers traveling on public transit buses pay the applicable fare. Passengers traveling in private or commercial buses will be charged the half-fare rate.

MEDICARE CARD HOLDERS - Any person holding a Medicare card duly issued to that person pursuant to Title II or Title XVIII of the Social Security Act may travel at half-fare passenger tolls on any route upon presentation of a WSF Disability Travel Permit or a Regional Reduced Fare Permit at time of travel.

FERRY/TRANSIT PASS - A combination ferry-transit pass may be available for a particular route when determined by Washington state ferries and a local public transit agency to be a viable fare instrument. The WSF portion of the fare is based on 21 days of passenger travel per month at a 40% discount. Passes may be available in monthly, quarterly or annual denominations.

PROMOTIONAL TOLLS - A promotional rate may be established at the discretion of the secretary of transportation for a specific discount (not to exceed 50 percent of full fare) and effective only at

designated times on designated routes (not to exceed 100 days per year on any one route).

Special passenger fare rate(s) may be established for a pilot program in conjunction with the Central Puget Sound Regional Fare Integration project on ferry route(s) serving King, Pierce, Snohomish and Kitsap counties. The rate(s) may be established at the discretion of the secretary of transportation for a specific discount not to exceed fifty percent of full fare.

SCHOOL GROUPS - Passengers traveling in authorized school groups for institution-sponsored activities will be charged a flat rate of \$1 per walk-on group or per vehicle of students and/or advisors and staff. Starting September 1, 1999, all school groups require a letter of authorization. Vehicles and drivers will be charged the fare applicable to vehicle size. The special school rate is \$2 on routes where one-point toll systems are in effect.

[Statutory Authority: RCW 47.56.030, 47.60.326, 00-24-050, § 468-300-010, filed 11/30/00, effective 12/31/00; 99-08-066, § 468-300-010, filed 4/5/99, effective 5/6/99; 98-08-051, § 468-300-010, filed 3/27/98, effective 4/27/98; 96-05-046 and 96-05-047 (Orders 79 and 80), § 468-300-010, filed 2/16/96, effective 3/19/96; 94-18-014 (Order 77), § 468-300-010, filed 8/25/94, effective 9/25/94; 94-07-104 (Order 75), § 468-300-010, filed 3/18/94, effective 4/18/94; 93-18-005, § 468-300-010, filed 8/19/93, effective 9/19/93; 92-18-005, § 468-300-010, filed 8/20/92, effective 9/20/92; 91-18-022 (Order 72), § 468-300-010, filed 8/27/91, effective 9/27/91; 89-14-052 (Order 67, Resolution No. 354), § 468-300-010, filed 6/30/89; 89-04-014 (Order 66, Resolution No. 343), § 468-300-010, filed 1/23/89, effective 7/1/89; 87-12-005 (Order 61, Resolution No. 298), § 468-300-010, filed 5/21/87. Statutory Authority: RCW 47.60.290, 47.60.300 and 47.60.326. 86-24-009 (Order 59, Resolution No. 287), § 468-300-010, filed 11/21/86. Statutory Authority: RCW 47.60.326, 86-06-010 (Order 54, Resolution No. 263), § 468-300-010, filed 2/21/86; 85-11-007 (Order 44, Resolution No. 241), § 468-300-010, filed 5/3/85; 84-11-052 (Order 42, Resolution Nos. 221 and 222), § 468-300-010, filed 5/17/84; 84-10-002 (Order 41, Resolution No. 218), § 468-300-010, filed 4/20/84; 83-07-062 (Order 33, Resolution No. 175), § 468-300-010, filed 3/22/83; 82-07-063 (Order 28, Resolution No. 143), § 468-300-010, filed 3/22/82. Statutory Authority: RCW 47.60.325 and 47.56.030. 81-15-099 (Order 23, Resolution No. 117), § 468-300-010, filed 7/22/81. Statutory Authority: RCW 47.60.325. 81-08-044 (Order 17, Resolution No. 104), § 468-300-010, filed 3/31/81; 80-16-012 (Order 16, Resolution No. 90), § 468-300-010, filed 10/27/80; 80-04-104 (Order 15, Resolution No. 72), § 468-300-010, filed 4/1/80; 79-09-136 (Order 11, Resolution No. 57), § 468-300-010, filed 9/5/79; 79-04-047 (Order 6, Resolution No. 44), § 468-300-010, filed 3/27/79; 78-06-040 (Order 2, Resolution No. 21), § 468-300-010, filed 5/19/78.]

WAC 468-300-020 Vehicle under 20', motorcycle, and stowage ferry tolls.

Effective 03:00 a.m. December 31, 2000

ROUTES	Vehicle Under 20' Incl. Driver One Way	Vehicle Under 20' w/Sr Citizen or Disabled Driver ⁴	Vehicle Under 20' Over Height Charge ¹	Frequent User Ticket book 20 Rides ²	Motorcycle ⁵ Incl. Driver Stowage ¹ One Way@	Motorcycle w/Sr Citizen or Disabled Driver Stowage ¹ One Way@	Motorcycle Oversize Charge ¹	Motorcycle Frequent User Ticket book 20 Rides ² @
Fauntleroy-Southworth Seattle-Bremerton								
Seattle-Bainbridge Island								
Port Townsend-Keystone								
Edmonds-Kingston	6.50	5.55	6.50	104.00	2.80	1.90	0.90	44.80
*Fauntleroy-Vashon								
*Southworth-Vashon								
*Pt. Defiance-Tahlequah	9.00	7.70	9.00	72.00	3.80	2.50	1.30	30.40
Mukilteo-Clinton	4.50	3.85	4.50	72.00	1.90	1.25	0.60	30.40
	10 Rides - 5 Round Trips							
*Anacortes to Lopez	13.25	10.55	13.25	53.00	6.90	4.20	1.60	55.20
*Shaw, Orcas	15.75	13.05	15.75	63.00	7.40	4.70	2.10	59.20
*Friday Harbor	17.75	15.05	17.75	71.00	7.80	5.10	2.50	62.40
Between Lopez, Shaw, Orcas and Friday Harbor ³	7.50	7.50	7.50	30.00	2.25	2.25	2.25	N/A
<i>International Travel</i>								
Anacortes to Sidney and Sidney to all destinations	24.75	20.15	24.75	N/A	12.30	10.00	3.20	N/A
Travelers with advanced reservations (\$15 fee)								
Anacortes to Sidney and Sidney to all destinations ⁶	9.75	5.15	24.75	N/A	N/A	N/A	N/A	N/A
Lopez, Shaw, Orcas and Friday Harbor to Sidney	9.00	7.00	9.00	N/A	5.00	5.00	1.25	N/A
Travelers with advanced reservations (\$7 fee) from Lopez, Shaw, Orcas and Friday Harbor to Sidney ⁷	2.00	0.00	9.00	N/A	N/A	N/A	N/A	N/A
Lopez, Shaw, Orcas and Friday Harbor to Sidney (round trip) ⁵	33.75	27.15	33.75	N/A	17.30	15.00	4.45	N/A

@ These fares rounded to the next multiple of \$0.10. All other fares rounded to the next multiple of \$.25.

* These routes operate as a one-point toll collection system.

¹SIZE - All vehicles up to 20' in length and under 7'6" shall pay the vehicle under 20' toll. Vehicles up to 20' but over 7'6" in height shall pay an overheight charge of 100% of the vehicle full fare. Motorcycles with trailers, sidecars, or three wheels will pay an oversize motorcycle charge of 100% of the motorcycle full fare. Upon presentation by either the driver or passenger of a WSF Disability Travel Permit, Regional Reduced Fare Permit, or other identification which establishes disability, the height charge will be waived for vehicles equipped with wheel chair lift or other mechanism designed to accommodate the person with disability.

²FREQUENT USER TICKETS - Shall be valid only for 90 days from date of purchase after which time the ticket shall not be accepted for passage.

³INTER-ISLAND FARES - Tolls collected westbound only. Vehicles traveling between islands may request a single transfer ticket good for one transfer at an intermediate island. The transfer may only be obtained when purchasing the appropriate vehicle fare for inter-island travel (westbound at Lopez, Shaw, or Orcas) and is free of charge. Transfers shall be valid for 24 hours from time of purchase.

⁴SENIOR CITIZEN, DISABLED DRIVER OR DISABLED ATTENDANT DRIVER - Half fare discount applies to driver portion of the vehicle-driver fare and only when the driver is eligible. Those persons with disabilities who require attendant care while traveling on the ferries, and are so certified by their physician, may obtain an endorsement on their WSF Disability Travel Permit and

such endorsement shall allow the attendant, when driving, to have the driver portion of the vehicle fare waived.

⁵ROUND TRIP - Round trip tickets for international travel available for trips beginning or ending on one of the islands served.

⁶RESERVATION FARES - These fares apply only to travelers that have made advanced reservations and paid the \$15 nonrefundable reservation fee. The reservation fee shall be a \$30 nonrefundable fee when the peak season surcharge is in effect.

⁷RESERVATION FARES - These fares apply only to travelers that have made advanced reservations and paid the \$7 nonrefundable reservation fee. The reservation fee shall be a \$15 nonrefundable fee when the peak season surcharge is in effect.

RIDE SHARE VEHICLES - A commuter ride share vehicle which carries five or more persons on a regular and expense-sharing basis for the purpose of travel to and from work or school and which is certified as such by a local organization approved by the Washington state ferry system, may purchase for a \$10 fee, a permit valid for one year valid only during the hours shown on the permit. The \$10.00 fee shall include the driver. Remaining passengers shall pay the applicable passenger fare. Except that the minimum total paid for all passengers in the van shall not be less than four times the applicable passenger fare.

STOWAGE - Stowage carry-on items including kayaks, canoes and other items of comparable size which are typically stowed on the vehicle deck of the vessel shall be charged at the motorcycle rate. This rate includes the walk-on passenger carrying on the item to be stowed.

PEAK SEASON SURCHARGE - A 25% surcharge shall be applied to vehicles from the second Sunday in May to the second Sunday in

October except those using frequent user tickets. A 65% surcharge shall be applied on fares for the Sidney B.C. route.

PENALTY CHARGES - Owner of vehicle without driver will be assessed a \$100.00 penalty charge.

PROMOTIONAL TOLLS - A promotional rate may be established at the discretion of the secretary of transportation for a specified discount (not to exceed 50 percent of full fare) and effective only at designated times on designated routes (not to exceed 100 days per year on any one route).

[Statutory Authority: RCW 47.56.030, 47.60.326. 00-24-050, § 468-300-020, filed 11/30/00, effective 12/31/00; 99-08-066, § 468-300-020, filed 4/5/99, effective 5/6/99; 98-08-051, § 468-300-020, filed 3/27/98, effective 4/27/98; 96-19-045 (Order 82), § 468-300-020, filed 9/12/96, effective 10/13/96; 94-18-014 (Order 77), § 468-300-020, filed 8/25/94, effective 9/25/94; 94-07-104 (Order 75), § 468-300-020, filed 3/18/94, effective 4/18/94; 93-18-005, § 468-300-020, filed 8/19/93, effective 9/19/93; 92-18-005, § 468-300-020, filed 8/20/92, effective 9/20/92; 91-18-022 (Order 72),

§ 468-300-020, filed 8/27/91, effective 9/27/91; 89-14-052 (Order 67, Resolution No. 354), § 468-300-020, filed 6/30/89; 89-04-014 (Order 66, Resolution No. 343), § 468-300-020, filed 1/23/89, effective 7/1/89; 87-12-005 (Order 61, Resolution No. 298), § 468-300-020, filed 5/21/87. Statutory Authority: RCW 47.60.326. 86-06-010 (Order 54, Resolution No. 263), § 468-300-020, filed 2/21/86; 85-11-007 (Order 44, Resolution No. 241), § 468-300-020, filed 5/3/85; 84-11-052 (Order 42, Resolution Nos. 221 and 222), § 468-300-020, filed 5/17/84; 84-10-002 (Order 41, Resolution No. 218), § 468-300-020, filed 4/20/84; 83-07-062 (Order 33, Resolution No. 175), § 468-300-020, filed 3/22/83; 82-07-063 (Order 28, Resolution No. 143), § 468-300-020, filed 3/22/82. Statutory Authority: RCW 47.60.325 and 47.56.030. 81-15-099 (Order 23, Resolution No. 117), § 468-300-020, filed 7/22/81. Statutory Authority: RCW 47.60.325. 81-08-044 (Order 17, Resolution No. 104), § 468-300-020, filed 3/31/81; 80-04-104 (Order 15, Resolution No. 72), § 468-300-020, filed 4/1/80; 79-09-136 (Order 11, Resolution No. 57), § 468-300-020, filed 9/5/79; 79-04-047 (Order 6, Resolution No. 44), § 468-300-020, filed 3/27/79; 78-06-040 (Order 2, Resolution No. 21), § 468-300-020, filed 5/19/78.]

WAC 468-300-040 Oversize vehicle ferry tolls.

Effective 03:00 a.m. December 31, 2000

ROUTES	Oversize Vehicle Ferry Tolls ¹							
	Overall Unit Length - Including Driver							
	20' To Under 30' Under 7'6" High	20' To Under 30' Over 7'6" High	30' To Under 40'	40' To Under 50'	50' To Under 60'	60' To under 70'	70' To and include 80'	Cost Per Ft. Over 80' @
Fauntleroy-Southworth Seattle-Bremerton Seattle-Bainbridge Island Port Townsend-Keystone								
Edmonds-Kingston	9.75	19.50	26.00	32.50	39.00	45.50	52.00	0.65
*Fauntleroy-Vashon *Southworth-Vashon								
*Pt. Defiance-Tahlequah	13.50	27.00	36.00	45.00	54.00	63.00	72.00	0.90
Mukilteo-Clinton	6.75	13.50	18.00	22.50	27.00	31.50	36.00	0.45
*Anacortes to Lopez ² *Shaw, Orcas *Friday Harbor								
Between Lopez, Shaw, Orcas and Friday Harbor ³	23.75	47.25	63.00	78.75	94.50	110.25	126.00	1.55
<i>International Travel</i>								
Anacortes to Sidney and Sidney to all destinations Travelers with advanced reservations (\$15 fee)								
Anacortes to Sidney and Sidney to all destinations ⁵	37.25	74.25	99.00	123.75	148.50	173.25	198.00	2.50
Lopez, Shaw, Orcas and Friday Harbor to Sidney Travelers with advanced reservations (\$7 fee) from Lopez, Shaw, Orcas and Friday Harbor to Sidney ⁶								
Lopez, Shaw, Orcas and Friday Harbor to Sidney (round trip) ⁴	13.50	27.00	36.00	45.00	54.00	63.00	72.00	0.90
	6.50	20.00	29.00	38.00	47.00	56.00	65.00	0.90
	50.75	101.25	135.00	168.75	202.50	236.25	270.00	3.40

@ These fares rounded to the next multiple of \$0.05. All other fares rounded to the next multiple of \$.25.

* These routes operate as a one-point toll collection system.

¹OVERSIZE VEHICLES - Includes all vehicles 20 feet in length and longer regardless of type: Commercial trucks, recreational vehicles, vehicles under 20' pulling trailers, etc. Length shall include vehicle and load to its furthest extension. Overheight charge is included in oversize vehicle toll. Vehicles 11 feet in width or wider pay double the fare applicable to their length. Private and commercial passenger buses or other passenger vehicles pay the applicable oversize vehicle tolls. Public transit buses and drivers

shall travel free upon display of an annual permit which may be purchased for \$10.

²STOPOVERS - Tolls collected westbound only. Oversize vehicles traveling westbound from Anacortes may purchase a single intermediate stopover ticket for \$2.50 when first purchasing the appropriate vehicle fare. The stopover is valid for a 24-hour period.

³INTER-ISLAND - Tolls collected westbound only. Vehicles traveling between islands may request a single transfer ticket good for one transfer at an intermediate island. The transfer may only be obtained when purchasing the appropriate vehicle fare for inter-

island travel (westbound at Lopez, Shaw, or Orcas) and is free of charge. Transfers shall be valid for 24 hours from time of purchase.

⁴ROUND TRIP - Round trip tickets for international travel available for trips beginning or ending on one of the islands served.

⁵RESERVATION FARES - These fares apply only to travelers that have made advanced reservations and paid the \$15 nonrefundable reservation fee. The reservation fee shall be a \$30 nonrefundable fee when the peak season surcharge is in effect.

⁶RESERVATION FARES - These fares apply only to travelers that have made advanced reservations and paid the \$7 nonrefundable reservation fee. The reservation fee shall be a \$15 nonrefundable fee when the peak season surcharge is in effect.

PEAK SEASON SURCHARGE - A peak season surcharge of 25% shall apply to all oversize vehicles, except for international travel. The senior citizen discount shall apply to the driver of an oversize vehicle. A 65% surcharge shall be applied on fares for the Sidney B.C. route.

SENIOR CITIZEN DISCOUNTS - Discounts of 50% for the driver of the above vehicles shall apply. Senior citizen discount is determined by subtracting full-fare passenger rate and adding half-fare passenger rate.

PENALTY CHARGES - Owner of vehicle without driver will be assessed a \$100.00 penalty charge.

DISCOUNT FROM REGULAR TOLL

Oversize vehicles making 12 or more, one-way crossings per week (Sunday thru Saturday) will qualify for a 20% discount from the regular ferry tolls.

EMERGENCY TRIPS DURING NONSERVICE HOURS - While at locations where crew is on duty charge shall be equal to the cost of fuel consumed to make emergency trip. Such trips shall only be offered as a result of official requests from an emergency services agency and only in the case of no reasonable alternative.

BULK NEWSPAPERS - Per 100 lbs. \$2.20

(Shipments exceeding 60,000 lbs. in any month shall be assessed \$1.10 per 100 lbs.)

Daily Newspapers, in bundles, and medical supplies, to be received and delivered without receipt and subject to owner's risk, will be transported between ferry terminals on regular scheduled sailings.

EXPRESS SHIPMENTS - A flat handling charge of \$25.00 per parcel is charged.

(Shipments exceeding 100 lbs. assessed \$8.30 for each 25 lbs. or fraction thereof.)

Express shipments will be handled on scheduled sailings when no other means of shipment is available to shipper. Shipments must be of a size and weight that can easily be handled by carrier's employees.

Carrier reserves the right to refuse shipment of any item. Carrier assumes no liability for loss or damage to any shipment. Minimum rate for any shipment shall be the rate for 100 pounds.

San Juan inter-island express shipments will be handled at \$5.00 per parcel.

MEDICAL SUPPLIES - A flat handling charge of \$5.00 per shipment is charged.

DISCLAIMER - Under no circumstances does Washington state ferries warrant the availability of ferry service at a given date or time; nor does it warrant the availability of space on board a vessel on a given sailing.

[Statutory Authority: RCW 47.56.030, 47.60.326. 00-24-050, § 468-300-040, filed 11/30/00, effective 12/31/00; 99-08-066, § 468-300-040, filed 4/5/99, effective 5/6/99; 98-08-051, § 468-300-040, filed 3/27/98, effective

4/27/98; 96-19-045 (Order 82), § 468-300-040, filed 9/12/96, effective 10/13/96; 94-18-014 (Order 77), § 468-300-040, filed 8/25/94, effective 9/25/94; 94-07-104 (Order 75), § 468-300-040, filed 3/18/94, effective 4/18/94; 93-18-005, § 468-300-040, filed 8/19/93, effective 9/19/93; 92-18-005, § 468-300-040, filed 8/20/92, effective 9/20/92; 91-18-022 (Order 72), § 468-300-040, filed 8/27/91, effective 9/27/91; 89-14-052 (Order 67, Resolution No. 354), § 468-300-040, filed 6/30/89; 89-04-014 (Order 66, Resolution No. 343), § 468-300-040, filed 1/23/89, effective 7/1/89; 87-12-005 (Order 61, Resolution No. 298), § 468-300-040, filed 5/21/87. Statutory Authority: RCW 47.60.290, 47.60.300 and 47.60.326. 86-24-009 (Order 59, Resolution No. 287), § 468-300-040, filed 11/21/86. Statutory Authority: RCW 47.60.326. 86-06-010 (Order 54, Resolution No. 263), § 468-300-040, filed 2/21/86; 85-11-007 (Order 44, Resolution No. 241), § 468-300-040, filed 5/3/85; 84-11-052 (Order 42, Resolution Nos. 221 and 222), § 468-300-040, filed 5/17/84; 83-07-062 (Order 33, Resolution No. 175), § 468-300-040, filed 3/22/83; 82-18-009 (Order 29, Resolution No. 153), § 468-300-040, filed 8/20/82; 82-07-063 (Order 28, Resolution No. 143), § 468-300-040, filed 3/22/82. Statutory Authority: RCW 47.60.325 and 47.56.030. 81-15-099 (Order 23, Resolution No. 117), § 468-300-040, filed 7/22/81. Statutory Authority: RCW 47.60.325. 81-08-044 (Order 17, Resolution No. 104), § 468-300-040, filed 3/31/81; 80-04-104 (Order 15, Resolution No. 72), § 468-300-040, filed 4/1/80; 79-09-136 (Order 11, Resolution No. 57), § 468-300-040, filed 9/5/79; 79-04-047 (Order 6, Resolution No. 44), § 468-300-040, filed 3/27/79; 78-06-040 (Order 2, Resolution No. 21), § 468-300-040, filed 5/19/78.]

WAC 468-300-100 Leases of facilities and facility space. (1) It is hereby declared to be the policy of the department to lease toll and ferry facilities and toll and ferry facility space in excess of current needs where feasible and where such lease will not interfere with the normal functioning or the primary operation of the toll or ferry facility. Such leasing should promote maximum use of the toll or ferry facility and constitute a benefit to the taxpayers of the state.

(2) The department is hereby authorized to lease toll or ferry facility property, and food, drink, amusement machine, and similar concessions for periods of up to five years, (except for the Seattle ferry terminal facilities which may be leased for periods of up to ten years) upon public advertisement for bids as follows:

(a) A call for bids shall be published once a week for at least two consecutive weeks preceding the day set for receiving and opening of bids, in not less than two newspapers, both of general circulation in the state.

In the event that the estimated fair market rental value per year of any lease is less than \$5,000, then the call for bids need be published only in one paper of general circulation in the county where the lease is located. The final publication shall be at least two days prior to the day set for receiving and opening of bids. The call for bids shall state the time, place and date for receiving and opening bids, give a brief description of the facilities or space to be rented, and contain such special provisions or limitations and specifications as may be necessary to comply with applicable statutes and the policy described above.

(b) Award shall be made to the responsive responsible bidder whose proposal is most advantageous to the state. Factors to be considered in making the award shall include, but not be limited to: (i) The monetary return to the state; (ii) the safety and comfort of the traveling public; (iii) the stability and reliability of the proposed operation; and (iv) the acceptability of the proposed operation with ferry system operational requirements.

[Statutory Authority: RCW 47.60.326. 85-11-007 (Order 44, Resolution No. 241), § 468-300-100, filed 5/3/85. Statutory Authority: RCW 47.60.140. 80-

09-056 (Order 57), § 468-300-100, filed 7/15/80. Formerly WAC 466-06-010.]

WAC 468-300-220 Calculation of charter rates for vessels owned by the Washington state ferry system. Pursuant to chapter 323, Laws of 1997, vessels owned by the Washington state ferry system may be made available for charter subject to operational availability. Execution of a charter agreement as set forth in the statute must precede a commitment to charter. The following actual hourly vessel operating costs have been calculated for establishing the rates to be charged for vessel charters from July 1, 1999, through June 30, 2000:

Vessel Class	Deck Crew	Deck Crew
	On Overtime	Not On Overtime
Jumbo	\$971.70	790.44
Super	937.74	762.90
Evergreen	735.18	590.26
Issaquah	725.33	594.37
Steel	611.76	497.09
Rhododendron	591.76	480.09
Hiyu	445.77	370.52
Passenger Only	433.42	371.57

The rate for an individual charter will be calculated by:

(1) Multiplying the actual operating cost set forth above for the vessel that is chartered by the number of hours, or fraction thereof, for which the vessel is chartered;

(2) Adding labor costs, mileage and per diem expenses to determine the total actual costs if the particular charter requires a crew callout; and

(3) Increasing the total actual costs calculated pursuant to subsections (1) and (2) of this section by fifty percent, and rounding to the nearest fifty dollars.

In the case of charters for the transport of hazardous materials, the transporter is required to pay for all legs necessary to complete the charter, even if the vessel is simultaneously engaged in an operational voyage on behalf of the Washington state ferry system.

[Statutory Authority: RCW 47.56.030 and 47.60.326. 99-08-066, § 468-300-220, filed 4/5/99, effective 5/6/99; 98-08-051, § 468-300-220, filed 3/27/98, effective 4/27/98. Statutory Authority: RCW 47.01.061, 47.56.032 and 1997 c 323. 97-15-110 (Order 83), § 468-300-220, filed 7/22/97, effective 8/22/97.]

WAC 468-300-600 Policy governing distribution of materials on ferry vessels and at ferry terminals. No person shall display, distribute or place, for any commercial purpose, any promotion or trade stimulation materials of any kind, including but not limited to any brochure, map, flyer, sign or insignia, aboard any ferry vessel, within any ferry terminal, upon any publicly owned areas adjacent to the ferry terminals, or on or within any other toll facility of the department of transportation, except as may otherwise be authorized by the department.

[Statutory Authority: 1977 ex.s. c 151. 79-01-033 (DOT Order 10 and Comm. Order I, Resolution No. 13), § 468-300-600, filed 12/20/78. Formerly WAC 252-85-010.]

(2001 Ed.)

WAC 468-300-610 No smoking areas. Each passenger carrying state operated ferry shall have specific areas designated by "no smoking" signs where smoking is prohibited. Smoking is prohibited in those areas of all such ferries where "no smoking" signs are posted.

[Statutory Authority: 1977 ex.s. c 151. 79-01-033 (DOT Order 10 and Comm. Order I, Resolution No. 13), § 468-300-610, filed 12/20/78. Formerly WAC 252-85-050.]

WAC 468-300-700 Preferential loading. In order to protect public health, safety and commerce; to encourage more efficient use of the ferry system; and to reduce dependency on single occupant private automobiles:

(1) Preferential loading privileges on vessels operated by Washington state ferries (WSF), exempting vehicles from the standard first-come first-served rule, shall be granted in the order set forth below:

(a) An emergency medical vehicle, medical unit, aid unit, or ambulance dispatched to and returning from an emergency or nonemergency call while in service. Up to one additional vehicle may accompany a qualifying emergency medical vehicle or authorized med-evac when going to, but not when returning from, an emergency.

(b) A public police or fire vehicle only when responding to an emergency call, but not when returning from either an emergency or a nonemergency call. However, these vehicles will receive priority loading when they are returning from either an emergency or nonemergency call to Vashon Island or the San Juan Islands.

(c) A public utility or public utility support vehicle only when responding to an emergency call, but not when returning from either an emergency or a nonemergency call.

(d) Where a vehicle occupant states that an extended wait would cause detrimental health risks to a vehicle occupant, that vehicle will be allowed preferential loading whenever the afflicted occupant has provided a medical form certified by a physician that such preferential loading is required.

However, when that vehicle occupant has not submitted the proper medical form, preferential loading will be permissible based upon appropriate terminal staff determination.

(e) Preferential loading may be granted for vehicles carrying passengers needing to attend to a family member subject to risk of physical threat/harm or medical emergencies which requires the customer's timely access to the vessel's destination.

(f) A visibly marked school vehicle owned, operated, or sponsored by a school** when operating on regular schedules preapproved by the WSF or when advance notice is provided to each affected WSF terminal (**as defined in RCW 28A.150.010 (K-12), RCW 28A.150.020 (public schools), RCW 28A.195.010 (K-12 private schools), and RCW 28B.195.070 (secondary schools)).

(g) A visibly marked, preapproved or regularly scheduled publicly or privately owned public transportation vehicle** operating under a Washington state utilities and transportation commission certificate for public convenience and necessity (**as defined in RCW 81.68.010 (regular route/fixed termini), RCW 81.70.010 (charter and excursion)).

(h) A visibly marked nonprofit or publicly supported transportation vehicle** having provided each affected WSF terminal with advance notice and displaying a WSF permit making it readily identifiable as a public transportation vehicle (**as defined in chapter 81.66 RCW (private, nonprofit special needs)).

(i) A visibly marked and randomly scheduled private for profit transportation vehicle**operating under a Washington state utilities and transportation commission certificate for public convenience and necessity traveling on routes where WSF is the only major access for land-based traffic only when that private for profit transportation vehicle has provided each affected WSF terminal with a preapproved schedule and/or advance notice of its proposed sailing(s), (**as defined in chapter 81.68 RCW (regular route/fixed termini), chapter 81.70 RCW (charter and excursion), chapter 81.66 RCW (private nonprofit special needs), chapter 46.72 RCW (private, for hire)).

(j) A ride-sharing vehicle for persons with special transportation needs** transporting a minimum of three elderly and/or disabled riders or two elderly and/or disabled riders and an attendant displaying WSF ride-share registration program permit only when the operator of that vehicle has provided each affected WSF terminal with advance notice of its proposed sailing(s) (**as defined in RCW 46.74.010 (ride sharing for persons with special transportation needs)).

(k) A visibly marked, public ride-share vehicle** owned by a transit agency and leased out to members of the public through the transit agency's registration program only when the operator of that vehicle has provided each affected WSF terminal with advance notice of its proposed sailing(s) (**as defined in RCW 46.74.010 (commuter ride sharing)).

(l) A privately owned commuter ride-share vehicle** that visibly displays WSF approved identification markings readily identifiable by the public. There must be a minimum of three occupants in any such vehicle to receive preferential loading. Any such ride-share vehicle must be registered and in good standing in the WSF ride-share registration program (**as defined by RCW 46.74.010 (commuter ride sharing)).

(m) Specific to the Anacortes-San Juan Islands routes, a vehicle carrying livestock and traveling on routes where Washington state ferries is the only major access for land-based traffic, where such livestock (i) is raised for commercial purposes and is recognized by the department of agriculture, county agriculture soil and conservation service, as raised on a farm; or (ii) is traveling to participate in a 4H event sanctioned by a county extension agent.

(n) Specific to the Seattle-Bainbridge and Edmonds-Kingston ferry routes, where a vehicle occupant claims that an extended wait would cause detrimental health risks to their livestock en route to veterinarian services not available in the local community, that vehicle will be allowed preferential loading whenever the vehicle occupant has provided a medical form certified by a veterinarian that such preferential loading is required.

(o) Specific to the Fauntleroy-Vashon, Seattle-Bainbridge, Mukilteo-Clinton, and Anacortes-San Juan ferry routes, any mail delivery vehicle with proper documentation from the U.S. Postal Service showing that such vehicle is in the actual process of delivering mail.

(p) Specific to the Anacortes-San Juan Islands routes, a vehicle 20 ft. and over in length and 10,000 lbs. or greater in weight, provided that the vehicle is carrying or returning from carrying article(s) of commerce for purchase or sale in commercial activity.

(q) An oversized or overweight vehicle (20 ft. and over in length, and/or over 8 1/2 ft. in width, and 80,000 lbs. or greater in weight) requiring transport at special times due to tidal conditions, vessel assignments, or availability of space.

(r) A scheduled bicycle group as determined by WSF only when a representative of that group has provided WSF with advance notice of the proposed travel schedule.

(2) Preferential loading privileges shall be subject to the following conditions:

(a) Privileges shall be granted only where physical facilities are deemed by WSF management to be adequate to allow granting the privilege and achieving an efficient operation.

(b) Subject to specified exceptions, documentation outlining qualifications for preferential loading and details of travel will be required in advance from all agencies, companies, or individuals requesting such privileges.

(c) Privileges may be limited to specified time periods as determined by WSF management.

(d) Privileges may require a minimum frequency of travel, as determined by WSF management.

(e) Privileges may be limited to a specific number of vehicle deck spaces and passenger capacity for any one sailing.

(f) Privileges may require arriving at the ferry terminal at a specified time prior to the scheduled sailing.

(3) To obtain more information about the documentation required and conditions imposed under subsection (2) of this section, call WSF's general information number, (206) 464-6400, or a terminal on a route for which the preferential boarding right is requested.

[Statutory Authority: RCW 47.56.030, 47.60.140 and 47.60.326. 99-07-059, § 468-300-700, filed 3/17/99, effective 4/17/99. Statutory Authority: RCW 47.56.030 and 47.60.326. 96-05-048 (Order 81), § 468-300-700, filed 2/16/96, effective 3/18/96; 93-18-006, § 468-300-700, filed 8/19/93, effective 9/19/93; 87-12-005 (Order 61, Resolution No. 298), § 468-300-700, filed 5/21/87. Statutory Authority: RCW 47.60.326, 86-16-011 (Order 55, Resolution No. 273), § 468-300-700, filed 7/25/86. Statutory Authority: RCW 47.60.140, 80-09-056 (Order 57), § 468-300-700, filed 7/15/80.]

Chapter 468-310 WAC

PREQUALIFICATION OF FERRY SYSTEM CONTRACTORS

WAC

468-310-010	General requirements.
468-310-020	Contents of standard prequalification questionnaire and financial statement.
468-310-030	Criteria for determining an unsatisfactory record of performing previous contracts.
468-310-040	Criteria for determining an unsatisfactory record of integrity.
468-310-050	Classification and capacity rating.
468-310-060	Review of restrictions in prequalification certificate.
468-310-070	Joint ventures.
468-310-080	Nonrenewal and revocation of prequalification certificate.
468-310-090	Notification and opportunity for a hearing.
468-310-100	Delegation of authority.

WAC 468-310-010 General requirements. Contractors desiring to offer bids for the performance of contracts for the construction, improvement or repair of a ferry operated by the Washington state ferries or for the repair, overhaul, or the dry-docking of any ferry operated by Washington state ferries must first be prequalified by the Washington state department of transportation (hereinafter "department") and shall file a standard prequalification questionnaire and financial statement (hereinafter "prequalification questionnaire") using forms furnished by the department. Contractors desiring to offer bids for the performance of contracts for the construction, improvement, or repair of ferry terminal facilities shall submit for consideration a prequalification questionnaire (DOT form 420-010) in accordance with chapter 468-16 WAC. The prequalification questionnaire shall include a report of the financial ability of the contractor, its organization, key personnel, equipment and plant facilities, and experience. Complete answers to all questions and the furnishing of all information as indicated by column headings or otherwise throughout the prequalification questionnaire are an essential part of compliance with these rules. A prequalification questionnaire from a contractor not previously prequalified under these rules, who desires to bid on a project must be received no later than 15 calendar days prior to the bid opening (or such other time as the department may specify with respect to any project) in order to receive consideration for that bid opening. The contractor shall authorize the department to obtain all information which it may deem pertinent with respect to the contractor's financial worth, assets and liabilities, and the adequacy of its performance of contracts performed by the contractor in whole or in part within the preceding three years. The department shall issue a certificate of prequalification to any contractor found to possess the qualifications prescribed.

Prequalification may be established in any calendar quarter and is renewable annually. Information submitted in the prequalification questionnaire will be used to establish the initial prequalification, classification and maximum capacity ratings of the contractor for its current fiscal year or remaining portion thereof plus one additional calendar quarter. Prequalification will be renewed annually thereafter or at other times as designated by the department.

The department shall not make available for public inspection and copying financial information supplied by or on behalf of the contractor for the purpose of qualifying to submit a bid or proposal as provided herein. The foregoing restriction shall not, however, prohibit the department from giving such information in evidence or in pretrial discovery in any court action or administrative hearing involving the department and the contractor.

The department may at any time during which the certificate of prequalification is in effect demand a new prequalification questionnaire and if the same is not provided within sixty days of the date of request, the certificate of prequalification held by the contractor will be considered forfeited and the contractor will not be permitted to bid on contracts let by the department for those classes of ferry system construction or repair enumerated in WAC 468-310-050(6) until a new statement has been received by the department.

If at any time during the valid period of the certificate of prequalification the latest prequalification questionnaire on record with the department ceases to represent fairly and substantially the financial position or the equipment and plant facilities of the contractor to whom the certificate was issued, it shall be the responsibility of that contractor to so notify the department and to refrain from further bidding on ferry system construction or repair contracts until their prequalification has been confirmed or revised. Failure to give such notice will constitute a violation of these rules.

Qualified contractors shall be notified of impending expiration of their qualification and will be provided the necessary questionnaire forms for renewal at least forty-five days before the expiration date.

The department reserves the right to require a personal interview with any contractor when considering their qualifications.

[Statutory Authority: RCW 47.60.680 and 47.60.690, 99-03-025 (Order 189), § 468-310-010, filed 1/11/99, effective 2/11/99. Statutory Authority: 1983 c 133, 83-19-014 (Order 84), § 468-310-010, filed 9/12/83.]

WAC 468-310-020 Contents of standard prequalification questionnaire and financial statement. The standard prequalification questionnaire and financial statement shall be transmitted to the director of Washington state ferries. The contractor shall provide the following information:

(1) The name, address, phone number, contractor registration number and type of organization (corporation, copartnership, individual, etc.) of the contractor seeking prequalification.

(2) The contract size in dollars and the class or classes of work for which the contractor seeks prequalification (such as vessel dry-docking and hull repairs, vessel electrical repairs, etc.) as enumerated in WAC 468-310-050(6).

(3) Ownership of the contractor and if a corporation, the name of the parent corporation (if any) and any affiliated companies or subsidiaries.

(4) An accurate and complete record of the fifteen largest contracts in excess of ten thousand dollars performed by the contractor in whole or in part within the preceding three years both in Washington and elsewhere, including subcontracts, giving the contract amount, the date completed, the class of work, the name, address and phone number of the owner/agency representative, and any liquidated damages assessed against the contractor by an owner arising out of the performance of the contract.

(5) The principal officers and key employees showing the number of years each engaged in the class or classes of work for which the contractor seeks prequalification. The department may require resumes of such personnel as deemed proper for making its determination.

(6) A contractor requesting prequalification certification to perform work in excess of ten million dollars shall submit copies of its audited annual statements for the previous three years as audited by an independent certified public accountant which shall include comparative balance sheets and income statements, a statement of retained earnings, supporting schedules and notes attached thereto, and the opinion of the independent auditor. The financial statement shall not be more than twelve months old when submitted. Any wholly

owned subsidiary corporation may file the latest consolidated financial statement of its parent corporation in lieu of a financial statement prepared solely for such subsidiary providing the financial statement otherwise meets the requirements of the preceding two sentences. If a consolidated financial statement is filed on behalf of a subsidiary corporation, a bid of the subsidiary corporation will be considered only if there is on file with the department a letter from the parent corporation guaranteeing performance by the subsidiary corporation of its contract with the department of transportation in an amount at least equal to the amount of the bid. A letter of guarantee by a parent corporation may cover a specific contract bid by its subsidiary or all contracts bid by its subsidiary within a stated period of time.

(7) A list of all major items of equipment to be used in those classes of work for which prequalification certification is requested including the original cost, age, location and condition of such equipment. The schedule shall show whether the equipment is owned, leased or rented. All major items of useful equipment should be listed even though fully depreciated but no obsolete or useless equipment should be included. In the event the contractor seeks prequalification certification to perform work on ferry vessels, the schedule shall also describe plant facilities of the contractor including shipyards, dry docks, repair facilities and other plant facilities.

(8) Such other information as may be required by the prequalification questionnaire.

[Statutory Authority: RCW 47.60.680 and 47.60.690, 99-03-025 (Order 189), § 468-310-020, filed 1/11/99, effective 2/11/99. Statutory Authority: RCW 47.60.680, 88-19-040 (Order 114), § 468-310-020, filed 9/14/88. Statutory Authority: 1983 c 133, 83-19-014 (Order 84), § 468-310-020, filed 9/12/83.]

WAC 468-310-030 Criteria for determining an unsatisfactory record of performing previous contracts.

The department may refuse to prequalify a contractor which it determines has an unsatisfactory record of performing previous contracts. In making such a determination the department shall consider the record of the contractor in performing any contract in excess of \$10,000 in value performed in whole or in part within the preceding three years in accordance with the following criteria, to wit, whether or not the contractor has with respect to such contract:

(1) Furnished records, including but not limited to drawings, plans, manuals, and financial records as required by the contract;

(2) Submitted all drawings and plans to the department for review and approval as required by the contract;

(3) Fulfilled the requirements of any contractual guarantee or warranty;

(4) Diligently pursued execution and completion of work or delivery of vessels in accordance with contractual time schedules as modified by extensions of time by the owner;

(5) Cooperated with the owner in the performance of the contract including providing the owner access to the work for inspection and providing the owner timely notices of tests and trials as required by the contract;

(6) Performed the contract in a workmanlike manner with adequate quality assurance;

[Title 468 WAC—p. 170]

(7) Otherwise completed the contract in compliance with contract plans and specifications.

[Statutory Authority: 1983 c 133, 83-19-014 (Order 84), § 468-310-030, filed 9/12/83.]

WAC 468-310-040 Criteria for determining an unsatisfactory record of integrity. The department may refuse to prequalify a contractor which it determines has an unsatisfactory record of integrity in the performance of previous contracts or in connection with prequalification or bidding. In making such a determination, the department may consider any of the following as evidence of a lack of integrity:

(1) Conviction of violating a federal or state antitrust law by bidrigging, collusion, or restraint of competition between bidders, or conviction of violating any other bid-related or contract-related federal or state law. Conviction of a contractor's principal officers and agents of any such offenses will be imputed to the contractor;

(2) Willful concealment of any deficiency in the performance of a prior contract;

(3) Falsification of information or submission of deceptive or fraudulent statements in connection with prequalification, bidding, or performance of a contract;

(4) Debarment of the contractor by a federal or state agency or by a municipal corporation unless the period of the debarment has terminated;

(5) Default on a previous contract.

[Statutory Authority: 1983 c 133, 83-19-014 (Order 84), § 468-310-040, filed 9/12/83.]

WAC 468-310-050 Classification and capacity rating.

(1) Each contractor seeking prequalification under these rules will be classified for one or more of the classes of work listed in subsection 8 of this section and will be given a maximum capacity rating in accordance with its financial ability, the adequacy of its equipment and plant facilities to perform the class or classes of work for which it has sought prequalification, the extent of the contractor's experience in performing contracts of the class or classes for which prequalification is sought, and the adequacy of the experience and capability of the contractor's officers and key employees in performing contracts of the class or classes for which prequalification is sought. The maximum capacity rating will limit the quantity of uncompleted work which the contractor shall have under contract at any one time either as a prime contractor or a subcontractor.

(2) The maximum capacity rating for a contractor applying for a rating in excess of fifty thousand dollars will be ten times the contractor's net worth as set forth in the standard prequalification questionnaire and financial statement. A properly executed letter of credit from an acceptable financial institution may be considered as an asset increasing the contractor's maximum capacity rating by the amount of the credit, but without the use of a multiplier. The maximum capacity rating for a contractor not submitting an audited financial statement as provided in WAC 468-310-020(6) will be ten million dollars: Provided, That in all cases the contractor's maximum capacity rating may be reduced to an amount considered by the department to be within the contractor's

(2001 Ed.)

actual capacity based upon its organization, personnel, equipment and plant, and experience.

(3) Consideration will be given to raising, by an amount not to exceed 50 percent, the maximum capacity rating of a contractor who qualifies with respect to actual capacity based upon organization, personnel, equipment and plant facilities, and experience, upon receipt of evidence of a current bonding capacity of such additional amount with a corporate surety. Such evidence shall be in the form of a letter of commitment executed by an officer of the surety who is authorized to bind the surety. Notwithstanding the provisions of this subsection, the maximum capacity rating for a contractor not submitting an audited financial statement as provided in WAC 468-310-020(6) will be ten million dollars.

(4) The certificate of prequalification issued by the department will establish a contractor's maximum capacity rating which will be subject to reduction by the total value of its current uncompleted work regardless of its location and with whom it may be contracted to determine the contractor's bidding capacity at the particular time.

(5) Notwithstanding the provisions of this section, a contractor will be allowed to submit a bid for an amount up to \$50,000 on a class or classes of work for which it is prequalified without regard to any financial maximum capacity rating or financial current capacity rating: Provided, That the contractor's current capacity may be reduced to an amount considered by the department to be within the contractor's actual capacity based upon its organization, personnel, equipment and plant facilities, and experience.

(6)(a) Construction, repair and maintenance work on ferry vessels for which prequalification certification under these rules may be granted are classified as follows:

Class 81	Vessel construction and renovation;
Class 82	Dry-docking and hull repairs;
Class 83	Vessel metal fabrication repairs;
Class 84	Vessel electrical repairs;
Class 85	Vessel miscellaneous repairs;

(b) A contractor currently prequalified under RCW 47.28.070 to perform those classes of work required in the construction, improvement and repair of ferry terminal facilities will initially be deemed prequalified under these rules to perform such classes of work with the same capacity rating as approved by the department for highway related work.

[Statutory Authority: RCW 47.60.680 and 47.60.690. 99-03-025 (Order 189), § 468-310-050, filed 1/11/99, effective 2/11/99. Statutory Authority: RCW 47.60.680. 88-19-040 (Order 114), § 468-310-050, filed 9/14/88. Statutory Authority: 1983 c 133. 83-19-014 (Order 84), § 468-310-050, filed 9/12/83.]

WAC 468-310-060 Review of restrictions in prequalification certificate. Any contractor dissatisfied with restrictions on the dollar amount or class of work approved in its prequalification certificate may request in writing, a review of their questionnaire and qualification rating with the director of Washington state ferries together with supporting documentation. The request must be filed within thirty calendar days of the date of receipt of the notice of qualification and must specifically state the basis for the request. The director or designee shall advise the applicant of his or her decision of

(2001 Ed.)

the reconsideration within thirty calendar days of receipt of the request.

[Statutory Authority: RCW 47.60.680 and 47.60.690. 99-03-025 (Order 189), § 468-310-060, filed 1/11/99, effective 2/11/99. Statutory Authority: 1983 c 133. 83-19-014 (Order 84), § 468-310-060, filed 9/12/83.]

WAC 468-310-070 Joint ventures. The department recognizes two distinct types of joint ventures for prequalification, classified as follows:

(1) Individual project joint venture: An association of two or more prequalified firms formed for the specific purpose of submitting a joint bid on a particular project. The bid of an individual project joint venture will be accepted provided all members of the joint venture are currently prequalified. At least 15 days prior to the date set for opening bids, the members of the joint venture must execute and file with the department, for its approval, a standard form of "individual project statement of joint venture" setting forth the name of the joint venture, the members of the joint venture, the title of the improvement and the names of those authorized to bind the joint venture. (Corporate minutes authorizing the joint venture must accompany the joint venture request for prequalification.)

(2) Continuing joint venture: An association of two or more firms formed for the purpose of submitting joint bids on projects to be let over a period of time. The bids of continuing joint ventures will be accepted if prequalification has been satisfactorily established by the following methods: A standard questionnaire and financial statement combining the assets and liabilities of all members of the venture shall be submitted in the name of the joint venture, together with a photostatic or certified copy of the joint venture agreement. Such agreement shall contain a provision which will unequivocally bind the parties, jointly and severally, to any joint venture contract entered into thereunder. It shall also specify the name under which the joint venture will operate and the names of those authorized to sign proposals, bonds, contracts, estimates and other documents and/or instruments in connection with the department's contracts. Corporate minutes authorizing the joint venture must accompany the joint venture request for prequalification. The department may require such further documentation as it may deem necessary. A continuing joint venture agreement will be executed as follows: An individual member of the joint venture shall sign in his individual capacity showing the name of the firm under which he is doing business. All partners both general and limited of a copartnership shall sign under the name of the copartnership. An authorized officer shall sign on behalf of a corporation with the corporate seal affixed. A certified copy of the resolution of the board of directors adopting the joint venture and authorizing the officer to enter into a joint venture agreement on behalf of the corporation shall accompany the agreement.

[Statutory Authority: 1983 c 133. 83-19-014 (Order 84), § 468-310-070, filed 9/12/83.]

WAC 468-310-080 Nonrenewal and revocation of prequalification certificate. The department may refuse to renew a contractor's prequalification certificate, or may revoke a contractor's prequalification certificate in accor-

[Title 468 WAC—p. 171]

dance with the criteria contained in WAC 468-310-030 and 468-310-040. In denying or revoking a contractor's prequalification certificate under this section or under WAC 468-310-030 or 468-310-040, the department shall specify the period of disqualification which shall not exceed three years. At the end of such period, the contractor may again apply for prequalification as provided in these rules.

[Statutory Authority: 1983 c 133, 83-19-014 (Order 84), § 468-310-080, filed 9/12/83.]

WAC 468-310-090 Notification and opportunity for a hearing. Notification of the department's intent to (1) refuse to prequalify a contractor, (2) refuse to renew a contractor's prequalification certificate, or (3) revoke a contractor's prequalification certificate will be made in writing and will be served upon the contractor by mail, properly addressed with postage prepaid. The intended action set forth in the written notification shall become final unless the contractor serves on the assistant secretary for marine transportation, a written request for a hearing thereon within 10 days after receipt of the notification. Upon receipt of such a request, the department shall afford the contractor a hearing in accordance with chapter 34.04 RCW relating to contested cases.

[Statutory Authority: 1983 c 133, 83-19-014 (Order 84), § 468-310-090, filed 9/12/83.]

WAC 468-310-100 Delegation of authority. The director of Washington state ferries is delegated authority to administer the provisions of chapter 133, Laws of 1981 and chapter 468-310 WAC. The director of Washington state ferries is delegated authority to exercise all powers vested in the secretary of transportation by WAC 468-10-234 relating to the adoption of a final order granting, denying or revoking a prequalification certificate pursuant to chapter 133, Laws of 1983. The director of Washington state ferries may further subdelegate authority to exercise all powers vested in the secretary of transportation by WAC 468-10-234. A person to whom such authority is subdelegated shall be deemed to be the designee of the secretary of transportation as that term is used in WAC 468-10-234.

[Statutory Authority: RCW 47.60.680 and 47.60.690, 99-03-025 (Order 189), § 468-310-100, filed 1/11/99, effective 2/11/99. Statutory Authority: 1983 c 133, 83-19-014 (Order 84), § 468-310-100, filed 9/12/83.]

Chapter 468-320 WAC

WASHINGTON STATE FERRY VESSEL CONSTRUCTION, MAINTENANCE AND REPAIR CONTRACTS—ALTERNATE FORMS OF SECURITY AND DETERMINATION OF BONDING AMOUNT REQUIRED

WAC

468-320-010	Marine contract security—General requirements.
468-320-020	State's exposure to loss.
468-320-030	Calculation of state's exposure to loss.
468-320-040	Alternate forms of security.
468-320-050	Specific requirements for alternate forms of security.
468-320-060	Warranty coverage.
468-320-070	Replacement bond option.
468-320-080	Prohibition of double security.
468-320-090	Delivery of alternate security to the state.
468-320-100	Delegation of authority.

[Title 468 WAC—p. 172]

WAC 468-320-010 Marine contract security—General requirements. (1) As required by chapter 58, Laws of 1989, the bond and/or alternate form(s) of security for a contract for construction, maintenance or repair of a marine vessel by the Washington state department of transportation (hereafter "contract"), shall be in an amount adequate to protect one hundred percent of the state's exposure to loss on such contract. The contractor shall provide either:

(a) An executed contract bond, as described in RCW 39.08.010, in the amount of one hundred percent of the state's exposure to loss and in the form required in the bid specifications; or

(b) A combination of security, totaling one hundred percent of the state's exposure to loss, consisting of:

(i) An executed payment bond in the amount of the state's payment exposure (see WAC 468-320-030) as stated in the bid specifications, which is adequate to fully protect the state against claims for work done by laborers, mechanics, subcontractors, materialmen and all persons who supply such person or persons, or subcontractors, with provisions and supplies for the carrying on of such work, when such persons have not been paid by the contractor, and the state has paid for such work; and

(ii) An executed contract bond and/or alternate form(s) of security totaling one hundred percent of the state's performance exposure (see WAC 468-320-030) as provided herein; or

(c) An executed contract bond and/or alternate form(s) of security totaling one hundred percent of the state's performance exposure, if the state, in performing the analysis described in WAC 468-320-030, determines that contract payment procedures completely eliminate its payment exposure (see WAC 468-320-030), and the state so provides in the bid specifications.

(2) Subject to the warranty coverage requirements of WAC 468-320-060 and 468-320-070, such bond and/or alternate form(s) of security shall remain in effect from the date of contract execution until the state has accepted the contract work, the lien claim period has passed, any liens filed under chapter 60.28 RCW have been settled, and all releases from other state of Washington agencies have been received.

[Statutory Authority: Chapter 34.05 RCW and 1989 c 58, 89-22-028, § 468-320-010, filed 10/26/89, effective 11/26/89.]

WAC 468-320-020 State's exposure to loss. The state's exposure to loss in such a contract is equal to the amount calculated in the written loss evaluation process described in WAC 468-320-030.

[Statutory Authority: Chapter 34.05 RCW and 1989 c 58, 89-22-028, § 468-320-020, filed 10/26/89, effective 11/26/89.]

WAC 468-320-030 Calculation of state's exposure to loss. (1) For each contract, a written loss evaluation will be conducted by the project design team during the estimating phase of plan preparation. This evaluation will determine the amount of the state's exposure to loss broken down into performance exposure (subsection (2)(a) through (f) of this section) and payment exposure, if any (subsection (2)(g), (h), and (i) of this section). These amounts will be included in the bid specifications. The amount of the state's exposure to loss

(2001 Ed.)

will be expressed in terms of a dollar amount or a percentage of the contract amount. After bid opening, copies of the written evaluation will be made available upon request.

(2) The evaluation will include consideration of all potential costs to the state (including engineering and administration (overhead)) in the following risk categories, mitigated generally by permitted delays in payments to the contractor and by contract retainage, and mitigated specifically as described below:

(a) Damage to the vessel, mitigated as appropriate by the required builder's risk insurance.

(b) Noncomplying or faulty material, mitigated as appropriate by the manufacturers' warranties and/or the degree of anticipated state inspection and testing.

(c) Work done poorly, incompletely, or incorrectly, mitigated as appropriate by the nature, complexity, and accessibility of the work, and/or the degree of anticipated state inspection.

(d) Out of service costs due to delays in the work.

(e) Failure to receive United States Coast Guard or American Bureau of Shipping approval, when required, for work already paid for by the state.

(f) Default or bankruptcy of the contractor, including:

(i) Removing the vessel from the contractor's facility;

(ii) Identifying and removing from the contractor's facility material paid for by the state;

(iii) Delivering the vessel to alternate shipyard facilities (contractor or state);

(iv) Completing the work, whether by new contract or by state forces; and

(v) Administering all such actions.

(g) Failure of the contractor to pay taxes or other governmental obligations related to the contract.

(h) Failure of the contractor to pay wage rates required by law.

(i) Failure of the contractor to pay claims of laborers, mechanics, subcontractors, materialmen and all persons who supply such person or persons, or subcontractors, with provisions and supplies for the carrying on of such work.

(3) If a contract change order significantly increases the amount of the state's exposure to loss, such change order shall specify the amount of such increase and shall provide the amount and form of additional contract security required.

[Statutory Authority: Chapter 34.05 RCW and 1989 c 58. 89-22-028, § 468-320-030, filed 10/26/89, effective 11/26/89.]

WAC 468-320-040 Alternate forms of security. In addition to a contract bond, the following alternate forms of contract security are acceptable if they provide protection in an amount at least equal to the state's exposure to performance loss, meet all legal requirements for effectiveness and authenticity, are specified in the bid specifications for a particular contract as being acceptable for that contract, and meet all of the special requirements set forth below and in the bid specifications for the particular contract:

(1) Certified check;

(2) Cashier's check;

(3) Treasury bill(s);

(4) Irrevocable bank letter of credit;

(5) Assignment of a savings account;

(6) Assignment of other liquid assets specifically approved by the assistant secretary for marine transportation or his designee.

[Statutory Authority: Chapter 34.05 RCW and 1989 c 58. 89-22-028, § 468-320-040, filed 10/26/89, effective 11/26/89.]

WAC 468-320-050 Specific requirements for alternate forms of security. In addition to meeting any special requirements contained in the bid specifications for a contract, alternate forms of contract security will be subject to the following requirements:

(1) Certified check.

(a) Must be issued by a bank which:

(i) Is a qualified public depository under RCW 39.58.010 and meets any other requirements contained in the bid specifications; or

(ii) Meets alternate standards set forth in the bid specifications.

(b) Will be deposited as directed by the contractor at the time of contract execution, with the options specified in WAC 82-32-010.

(2) Cashier's check.

(a) Must be issued by a bank which:

(i) Is a qualified public depository under RCW 39.58.010 and meets any other requirements contained in the bid specifications; or

(ii) Meets alternate standards set forth in the bid specifications.

(b) Will be deposited as directed by the contractor at the time of contract execution, with the options specified in WAC 82-32-010.

(3) Treasury bill(s).

(a) Must be issued by the Treasury Department of the United States and meet any other requirements contained in the bid specifications.

(b) Must be used only for contract security, not warranty coverage.

(c) Must bear a maturity date which is at least six months past the date specified for contract completion. If for any reason, the actual contract completion date extends to within sixty days of the maturity date of the treasury bill(s) furnished by the contractor, the contractor shall, at least thirty days prior to the maturity date, substitute treasury bill(s) with a maturity date at least six months longer than the state's new estimate of the time required for contract completion.

(d) Must be held in book entry at the Federal Reserve in San Francisco and be pledged to the state's account.

(4) Irrevocable bank letter of credit.

(a) Must be issued by a bank which:

(i) Is a qualified public depository under RCW 39.58.010 and meets any other requirements contained in the bid specifications; or

(ii) Meets alternate standards set forth in the bid specifications.

(b) If at any time during the contract or warranty period, as applicable, the issuing bank fails to meet the standards specified in (a) of this subsection, the contractor shall inform the state of such event, and shall, within ten days, substitute an irrevocable letter of credit from a bank which meets the standards specified in (a) of this subsection.

(c) Must be in the form required in the bid specifications, unless an alternate form is approved as provided in (d) of this subsection.

(d) If a contractor cannot obtain an irrevocable letter of credit in the form required in the bid specifications, and wishes to propose an alternative form of irrevocable letter of credit, it shall submit such alternate irrevocable letter of credit to the contracts department of Washington state department of transportation, marine division, for approval on or before the date set forth in the bid specifications. The state, in its sole discretion, may approve or reject the proposed letter of credit, or may suggest changes in it which will make it acceptable, provided the contractor and its bank concur with such changes, in writing, prior to the date set for bid opening.

(5) Assignment of savings account.

(a) The assigned account must be in a bank which:

(i) Is a qualified public depository under RCW 39.58.010 and meets any other requirements contained in the bid specifications; or

(ii) Meets alternate standards set forth in the bid specifications.

(b) The proposed document of assignment shall be submitted to the contracts department of Washington state department of transportation, marine division, on or before the date set forth in the bid specifications. The state, in its sole discretion, may approve or reject the proposed document of assignment, or may suggest changes in it which will make it acceptable, provided the contractor and its bank concur with such changes, in writing, prior to the date set for bid opening.

(c) Must be accompanied by a notarized statement, on bank letterhead, stating that the bank concurs in the assignment.

(d) Must be effective:

(i) For at least six months past the date specified for contract completion, if the contractor does not propose to use the assignment for warranty coverage; or

(ii) For at least one year and six months past the date specified for contract completion if the contractor proposes to use the assignment for warranty coverage.

If for any reason, the actual contract completion date or end of the contract warranty period, as applicable, extends to within sixty days of the end of the savings account assignment, the contractor shall, at least thirty days prior to the end of the initial assignment, make a new or extended assignment in compliance with these regulations for a period at least six months longer than the state's new estimate of the time required for contract completion or warranty coverage, as applicable.

(6) Assignment of other liquid assets.

(a) Must be an assignment of assets approved for investment in WAC 82-32-060.

(b) Both a full description of the liquid assets proposed to be assigned and the proposed document of assignment shall be submitted to the contracts department of Washington state department of transportation, marine division, on or before the date set forth in the bid specifications. The state, in its sole discretion, may approve or reject the proposed liquid assets and/or document of assignment, or may suggest changes in them which will make the liquid assets or the document of assignment acceptable, provided the contractor con-

curs with such changes, in writing, prior to the date set for bid opening.

(c) Must be effective:

(i) For at least six months past the date specified for contract completion, if the contractor does not propose to use the assets for warranty coverage; or

(ii) For at least one year and six months past the date specified for contract completion, if the contractor proposes to use the assignment for warranty coverage.

If for any reason the actual contract completion date or end of the contract warranty period, as applicable, extends to within sixty days of the end of the liquid asset assignment, the contractor shall, at least thirty days prior to the end of the initial assignment, make a new or extended assignment in compliance with these regulations for a period at least six months longer than the state's new estimate of the time required for contract completion or warranty coverage, as applicable.

[Statutory Authority: Chapter 34.05 RCW and 1989 c 58. 89-22-028, § 468-320-050, filed 10/26/89, effective 11/26/89.]

WAC 468-320-060 Warranty coverage. All forms of contract security provided by a contractor shall ensure that the state receives warranty coverage for all losses resulting from any defects in material and workmanship for the period beginning on the date of redelivery of the vessel to the state and ending one year after that date. Such warranty coverage shall be at least as effective in protecting the state as that contained in the state's standard contract bond. Warranty coverage under a contract bond shall be specified in the bond and shall equal ten percent of the penal sum of the bond. Warranty coverage under alternate forms of security shall be in an amount specified in the bid specifications, increased or decreased by ten percent of the net amount of any change orders, and shall be delivered to the state as provided in WAC 468-320-090.

[Statutory Authority: Chapter 34.05 RCW and 1989 c 58. 89-22-028, § 468-320-060, filed 10/26/89, effective 11/26/89.]

WAC 468-320-070 Replacement bond option. As an alternative to the warranty coverage described in WAC 468-320-060, a contractor may, for the period beginning on the date of redelivery of the vessel to the state and ending one year after that date, provide a replacement bond in the amount specified for warranty coverage in the bid specifications, increased or decreased by ten percent of the net amount of any change orders. Such replacement bond shall be in the form required in the bid specifications, and shall be delivered to the state as provided in WAC 468-320-090.

[Statutory Authority: Chapter 34.05 RCW and 1989 c 58. 89-22-028, § 468-320-070, filed 10/26/89, effective 11/26/89.]

WAC 468-320-080 Prohibition of double security. Assets used as an alternate form of contract security shall not also be used to secure a contract bond on the contract.

[Statutory Authority: Chapter 34.05 RCW and 1989 c 58. 89-22-028, § 468-320-080, filed 10/26/89, effective 11/26/89.]

WAC 468-320-090 Delivery of alternate security to the state. All alternate forms of security permitted by these

regulations and the bid specifications for a contract shall be delivered to the state in the manner provided in the bid specifications for delivery of a contract bond, unless provided otherwise in the bid specifications.

[Statutory Authority: Chapter 34.05 RCW and 1989 c 58. 89-22-028, § 468-320-090, filed 10/26/89, effective 11/26/89.]

WAC 468-320-100 Delegation of authority. The assistant secretary for marine transportation is hereby delegated authority to administer the provisions of chapter 58, Laws of 1989 and chapter 468-320 WAC. The assistant secretary for marine transportation may further delegate authority to exercise all such powers.

[Statutory Authority: Chapter 34.05 RCW and 1989 c 58. 89-22-028, § 468-320-100, filed 10/26/89, effective 11/26/89.]

Chapter 468-400 WAC BICYCLE RACING

WAC

468-400-010	Policy.
468-400-020	Definitions.
468-400-030	Bicycle race permit required.
468-400-040	Bicycle race permit conditions.

WAC 468-400-010 Policy. It is the policy of the Washington state department of transportation (department) to permit bicycle racing on state highways in accordance with the conditions and regulations set forth in this code and the latest edition of the "*Washington State Bicycle Racing Guidelines*."

[Statutory Authority: Chapters 34.05 and 34.08 RCW. 98-06-029 (Order 171), § 468-400-010, filed 2/26/98, effective 3/29/98.]

WAC 468-400-020 Definitions. Bicycles are defined in RCW 47.04.071. Bicycle racing means any contest of speed or competition where bicycles are used. Bicycle racing permits riding more than two abreast on a roadway. This code applies to all events in which bicycle racing takes place, including the following.

(1) Duathlon, triathlon, or multisport event. A multisport race in which bicycle racing forms an essential component of the complete event. The bicycle race portion of these events is conducted similar to a time trial.

(2) Time trial. Time trials are events in which individuals or small teams of riders, separately ride the same route and distance for elapsed time. Time trials are generally started at preset intervals and held on an out and back or circuit course.

(3) Criterium. Criteriums are massed start, high speed bicycle race events in which riders race around a closed circuit course to compete for order of finish. Criteriums are usually held on closed urban or suburban public streets. The course is normally one-half to one mile in length.

(4) Road race. Road races are massed start events in which riders complete a race course for order of finish. The course may be point to point, a large circuit, or repeated laps of a shorter circuit. Road races are usually held on rural or suburban roads, but may also take place on urban streets.

(5) Rolling enclosure. A rolling enclosure is a type of traffic control where escort vehicles form a caravan leading and following a group of racers. The enclosure sets aside a

moving part of the roadway in the direction of the race for exclusive use of bicyclists. Racers inside the enclosure are not required to follow the normal rules of the road but are controlled by rules set forth in the *Washington State Bicycle Racing Guidelines*. Racers are not allowed to cross the center line unless the entire road is traffic controlled. A rolling enclosure is the typical traffic control used to run a road race.

[Statutory Authority: Chapters 34.05 and 34.08 RCW. 98-06-029 (Order 171), § 468-400-020, filed 2/26/98, effective 3/29/98.]

WAC 468-400-030 Bicycle race permit required. All persons or organizations (permittee) conducting any form of bicycle race on a state highway shall apply for a bicycle race permit from the applicable WSDOT region administrator. The bicycle race permit must be applied for at least sixty days before the bicycle race event. No bicycle race event may be held on a state highway without an approved bicycle race permit. The WSDOT region administrator may waive these requirements under special conditions.

[Statutory Authority: Chapters 34.05 and 34.08 RCW. 98-06-029 (Order 171), § 468-400-030, filed 2/26/98, effective 3/29/98.]

WAC 468-400-040 Bicycle race permit conditions.
(1) Bicycle race permits shall be granted only under conditions that ensure reasonable safety for all participants, spectators, and highway users. Reasonable safety implies that race participants, spectators, and other highway users have been accommodated in planning in a manner as to minimize the possibility of placing one in conflict with another.

(2) Bicycle race permit requests must include a race description stating all pertinent information required to understanding the bicycle race event. The request must include a map showing the roadway on which the race will be held. Applications must specify the number of vehicles on the roadway used to run a race, starting and anticipated finish time, maximum number of racers, number and training of course marshals, types of signing, and communications equipment.

(3) Approval of other involved jurisdictions shall be obtained prior to formal issuance of a bicycle race permit from the WSDOT.

(4) If the race only crosses a state highway, the WSDOT region administrator may waive the need for a bicycle race permit provided the permittee can show that reasonable traffic control and safety are provided by the organizer and other road authority: Provided further, That the permittee provide the indemnification and liability insurance prescribed in subsections (6) and (7) of this section.

(5) Bicycle racing will not normally be allowed on the Interstate Highway System.

(6) The permittee shall indemnify, defend and save harmless the state of Washington for any claim, suit, action for injuries, death or any other cause of personal injury or property damage arising from the issuance of a bicycle race permit, including claims of race participants, pedestrians, or other roadway users.

(7) The permittee shall obtain liability insurance in an amount no less than one million dollars to cover the state of Washington for any and all liabilities, including all costs, attorney fees, judgments or other expenses, arising out of the

use of state highways for the bicycle race event. The state shall be named as an additional insured on all insurance policies.

(8) When five or more vehicles are lined up behind a bicycle race and delayed for more than five minutes, the bicycle race shall be neutralized at a place of safety to allow the vehicles to pass.

(9) Requests for bicycle race permits must comply with the current WSDOT *"Washington State Bicycle Racing Guidelines."*

(10) The original or certified copy of the permit must be available at the bicycle race for the duration of the bicycle race event.

Copies of the *"Washington State Bicycle Racing Guidelines"* may be obtained from the WSDOT bicycle and pedestrian program or a WSDOT region office.

[Statutory Authority: Chapters 34.05 and 34.08 RCW. 98-06-029 (Order 171), § 468-400-040, filed 2/26/98, effective 3/29/98.]

Chapter 468-500 WAC COMMISSION MEETINGS

WAC

468-500-001 Commission meetings.

WAC 468-500-001 Commission meetings. Regular public meetings of the Washington state transportation commission are held monthly on the third Thursday of every month and on the Wednesday immediately preceding that day commencing at 9:00 a.m. or such other time as determined by the commission chair. Each such regular meeting shall be held in the transportation commission meeting room (1D2) in the Transportation Building, 310 Maple Park Drive, Olympia, Washington. Persons desiring to know the starting time for a specific meeting can call the commission office at (360) 705-7070.

[Statutory Authority: RCW 47.01.071. 99-11-007, § 468-500-001, filed 5/7/99, effective 6/7/99. Statutory Authority: RCW 47.01.061 and 42.30.070. 97-06-002, § 468-500-001, filed 2/20/97, effective 3/23/97.]

Chapter 468-510 WAC LANE USE RESTRICTIONS

WAC

468-510-010 High occupancy vehicles (HOVs).
468-510-020 Left lane restrictions.

WAC 468-510-010 High occupancy vehicles (HOVs). Pursuant to RCW 46.61.165 and 47.52.025, the department has reserved portions of interstate highways, state highways, and ramps, as HOV lanes for the exclusive use of public transportation vehicles or private motor vehicles with the number of occupants specified on signs. Motor vehicles authorized to use HOV lanes are:

(1) Rubber tired municipal transit vehicles conforming to RCW 46.04.355.

(2) Buses with a carrying capacity of sixteen or more persons, including the operator.

(3) Motorcycles conforming to RCW 46.04.330.

[Title 468 WAC—p. 176]

(4) Recreational vehicles with the number of occupants specified on signs.

(5) All other vehicles with the number of occupants specified on signs, except that trucks in excess of 10,000 lb. G.V.W. are prohibited from the use of HOV lanes regardless of the number of occupants. Tow trucks that would be otherwise prohibited because of weight or number of occupants may use HOV lanes when en route to an emergency on a specific roadway or roadside.

[Statutory Authority: Chapters 34.05 and 34.08 RCW. 98-12-062 (Order 178), § 468-510-010, filed 6/1/98, effective 7/2/98.]

WAC 468-510-020 Left lane restrictions. (1) RCW 46.61.100(3) mandates that no vehicle towing a trailer or no vehicle or combination over 10,000 lb. may use the left lane of limited access roadways having three or more lanes in one direction, and that a high occupancy vehicle (HOV) lane is not considered the left hand lane of a roadway. Within this section, 10,000 lb. means 10,000 lb. gross vehicle weight (G.V.W.).

(2) RCW 46.61.100(3) further mandates that the department, in consultation with the Washington state patrol, shall adopt rules specifying those circumstances where it is permissible for other vehicles to use the left lane in case of emergency or to facilitate the orderly flow of traffic, and those segments of limited access highways exempt from the subsection due to the operational characteristics of the roadway.

(a) For the types of vehicles specified, and under the circumstances enumerated in (a)(i) through (vii) of this subsection, the left lane prohibition described in subsection (1) of this section does not apply to:

(i) Motorcycles towing trailers.

(ii) Class B motor homes, commonly called conversion vans, without a motor vehicle or trailer in tow.

(iii) Tow trucks weighing over 10,000 lb. G.V.W. when en route to an emergency on a specific roadway or roadside.

(iv) Fire trucks or emergency care vehicles weighing over 10,000 lb. G.V.W. when en route to an emergency.

(v) Any vehicle towing a trailer or vehicle or combination weighing over 10,000 lb. G.V.W. when one or more of the lanes are blocked because of an accident, other incident, or highway maintenance or construction activities.

(vi) Any vehicle authorized to use a HOV lane that would otherwise be prohibited from the left lane within two miles approaching the beginning of a HOV lane or following the terminus of a HOV lane.

(vii) Any department of transportation vehicle towing a trailer or weighing over 10,000 lb. G.V.W. when conducting official business within the left lane.

(b) On the roadway portions enumerated in (b)(i) through (viii) of this subsection, the left lane prohibition described in subsection (1) of this section does not apply:

(i) On northbound and southbound Interstate 5 in the Vancouver vicinity, from the Washington/Oregon state line to exit 3 at Main Street.

(ii) On northbound Interstate 5 in the Vancouver vicinity, from the confluence of Interstate 205 to exit 9 at 179th Street.

(iii) On southbound Interstate 5 in the Vancouver vicinity, from exit 9 at 179th Street to exit 7 at Interstate 205.

(iv) On northbound Interstate 5 in the Seattle/Everett vicinity, from exit 154A at I-405 to exit 194 at SR 529.

(v) On southbound Interstate 5 in the Seattle/Everett vicinity, from exit 189 at SR 526 to exit 154A at I-405.

(vi) On eastbound and westbound Interstate 90 in the Seattle vicinity, from exit 2A and 2B respectively at Interstate 5 to exit 10A at Interstate 405.

(vii) On eastbound and westbound Interstate 182 in the Tri-cities vicinity, from exit 4 to exit 12A.

(viii) On northbound and southbound Interstate 205 in the Vancouver vicinity, from the Washington/Oregon state line to the termini of the three lane sections about one-half mile south of exit 32.

(c) On the roadway portions enumerated in (c)(i) and (ii) of this subsection, the left lane prohibition described in subsection (1) of this section does not apply to any vehicle, except trucks over 10,000 lb. G.V.W., when using the left lane for passing to facilitate the orderly flow of traffic:

(i) On southbound Interstate 5 in the Southcenter vicinity, from exit 154A at I-405 to exit 151 at South 200th Street.

(ii) On southbound Interstate 5 in the Tacoma vicinity, from exit 135 at SR 167 to exit 130 at South 56th Street.

[Statutory Authority: Chapters 34.05 and 34.08 RCW. 98-12-062 (Order 178), § 468-510-020, filed 6/1/98, effective 7/2/98.]

Chapter 468-550 WAC

SAFETY OVERSIGHT OF RAIL FIXED GUIDEWAY SYSTEMS RULES

WAC

468-550-010	Purpose.
468-550-020	Applicability.
468-550-030	Definitions.
468-550-040	Requirements for system safety and security plans.
468-550-050	Department procedures for reviewing, approving, and filing rail fixed guideway system safety and security plans and inspections.
468-550-060	Annual and triennial safety and security audits and reports.
468-550-070	Notifying of, investigating, and reporting accidents and unacceptable hazardous conditions.
468-550-080	Notifying of and applying financial penalties.

WAC 468-550-010 Purpose. This chapter is adopted to comply with 49 CFR Part 659 which requires the state of Washington to oversee the safety and security plans of rail fixed guideway systems (RFGS) not regulated by the Federal Railroad Administration. These rules prescribe the system safety and security criteria to be met by RFGS and is intended to improve the safety and security of RFGS in Washington state.

[Statutory Authority: RCW 43.06.120. 98-19-052, § 468-550-010, filed 9/15/98, effective 10/16/98.]

WAC 468-550-020 Applicability. These rules are applicable to all Washington state entities, public or private, which own, operate, or maintain RFGS that are not regulated by the Federal Railroad Administration.

[Statutory Authority: RCW 43.06.120. 98-19-052, § 468-550-020, filed 9/15/98, effective 10/16/98.]

(2001 Ed.)

WAC 468-550-030 Definitions. For the purposes of this chapter, the following definitions of terms shall apply unless the context clearly indicates otherwise:

(1) Accident, reportable means any event involving the operation of a RFGS along a revenue line segment, if as a result:

(a) An individual dies; or

(b) An individual suffers bodily injury and immediately receives medical treatment away from the scene of the accident; or

(c) A collision, derailment, or fire causes property damage in excess of \$50,000.

(2) APTA Guidelines means the American Public Transit Association's "Manual for the Development of Rail Transit System Safety Program Plans."

(3) Chief executive officer means, but is not limited to, the mayor, county executive, or chair of the municipality, or corporate president of the public or private entity that owns, operates, or maintains a RFGS.

(4) Contractor means an entity that performs tasks required by this chapter on behalf of the department or a RFGS.

(5) Department means the Washington state department of transportation which has been designated as the state safety oversight agency.

(6) Emergency means a situation which is life threatening to passengers, employees, or others or which causes damage to any rail fixed guideway vehicle or facility or results in a significant theft of services which severely affects the ability of the system to fulfill its mission.

(7) FTA means the Federal Transit Administration, or its successors, an agency within the U.S. Department of Transportation.

(8) Hazardous condition means a set of circumstances that if not identified and corrected has or will result in personal injury or property damage. It includes unacceptable hazardous conditions.

(9) Investigation means a procedure that the department or a RFGS utilizes to determine the cause of a reportable accident, hazardous condition, or security breach.

(10) Plan means the system safety and security program plan which is adopted by the RFGS detailing its safety and security policies, objectives, responsibilities and procedures.

(11) Procedure means an established and documented method to perform a task.

(12) Rail fixed guideway system or "RFGS" means a light, heavy, or rapid rail system, monorail, inclined plane, funicular, trolley, or other fixed rail guideway that is not regulated by the Federal Railroad Administration. "RFGS" does not include elevators, moving sidewalks or stairs, and vehicles suspended from aerial cables, unless they are an integral component of a station served by a rail fixed guideway system, or operations not available to the general public, acquired by an individual or group of individuals for a common purpose to travel together as a group to a specific destination or for a particular itinerary. A RFGS also shall be within a federally recognized urbanized area and included in the Federal Transit Administration's (FTA) calculation of fixed guideway route miles or receives funding under FTA's formula program for urbanized areas (49 U.S.C. 5336).

(13) Risk means the probability that a security breach will occur.

(14) Safety means freedom from danger.

(15) Security means freedom from intentional danger.

(16) Security breach means an unforeseen event or occurrence that endangers life or property and may result in the loss of services or system equipment.

(17) Standard means the system safety and security program standard which is the standard developed and adopted by the department which complies with the APTA *Manual for the Development of Rail Transit System Safety Program Plans*, the Federal Transit Administration's *Transit System Security Program Planning Guide* (FTA-MA-90-7001-94-1), The Federal Transit Administration's *Implementation Guidelines for State Safety Oversight of Rail Fixed Guideway Systems*, and the *State Safety Oversight Security Handbook*.

(18) System means a composite of people, property, environment, and procedures which are integrated to perform a specific operational function in a specific environment.

(19) Triennial safety and security audit means a formal, comprehensive, on-site examination by the department of a RFGS's safety and security procedures to determine whether it complies with the RFGS's policies and procedures as outlined in the RFGS's plan.

(20) Unacceptable hazardous condition means a hazardous condition of type IA, IB, IC, IIA, IIB, OR IIIA as determined using the "Hazardous Resolution Matrix" in APTA *Manual for the Development of Rail Transit System Program Plans*.

[Statutory Authority: 1999 c 202 § 7. 99-18-059 (Order 193), § 468-550-030, filed 8/30/99, effective 9/30/99. Statutory Authority: RCW 43.06.120. 98-19-052, § 468-550-030, filed 9/15/98, effective 10/16/98.]

WAC 468-550-040 Requirements for system safety and security plans. (1) Each RFGS shall prepare a system safety and security program plan. Such Plan shall describe the RFGS's procedures for:

(a) Reporting and investigating reportable accidents and unacceptable hazardous conditions;

(b) Submitting corrective action plans and annual safety and security audit reports;

(c) Facilitating on-site safety and security reviews by the department; and

(d) Addressing passenger and employee security.

The plan and any revisions thereto shall, at a minimum, conform to the standard set forth in WAC 468-550-050, be approved by the RFGS's chief executive officer and submitted for departmental review by September 1, 1999, or within three months prior to beginning operations or instituting revisions to the plan. The RFGS shall not transmit the security portions of its system safety and security program plan to the department. The RFGS shall notify the department of the location and availability of the security portions of its system safety and security program plan.

(2) Each RFGS shall implement and comply with the provisions of its plan and any revisions thereto. Further, should the RFGS change ownership or operating or maintenance providers, the RFGS shall require its successors, assigns, and contractors to continue to comply with the

RFGS's established plan and shall notify the department of any change of ownership or operating or maintenance providers within thirty days of the effective date of transfer or contract.

(3) The security section of the plan is exempt from public disclosure under chapter 42.17 RCW. Each RFGS may develop procedures to implement this subsection. Completed reports of reportable accidents and unacceptable hazardous conditions, corrective action plans, annual safety and security audit reports, published reviews of the department, published RFGS internal safety and security audits, and notifications of reportable accidents and unacceptable hazardous conditions are not subject to this exemption.

[Statutory Authority: 1999 c 202 § 7. 99-18-059 (Order 193), § 468-550-040, filed 8/30/99, effective 9/30/99. Statutory Authority: RCW 43.06.120. 98-19-052, § 468-550-040, filed 9/15/98, effective 10/16/98.]

WAC 468-550-050 Department procedures for reviewing, approving, and filing rail fixed guideway system safety and security plans and inspections. The department shall review each RFGS plan, and all subsequent revisions, for compliance with these rules and the standard, using the APTA system safety checklist which includes:

- Policy statement and authority for the plan
- Description of purpose for the plan
- Clearly stated goals for plan
- Identifiable and attainable objectives
- System description and organizational structure
- The plan control and update procedures
- Hazard identification and resolution process
- Accidents, hazardous conditions and reporting and investigation procedures
- Internal safety audit process
- Facilities inspections (includes system equipment and rolling stock)
- Maintenance audits and inspections (all systems and facilities)
- Rules and procedures review
- Training and certification reviews and audits
- Emergency response planning, coordination and training
- System modification review and concurrence process
- Safety data acquisition and analysis
- Interdepartmental and interagency coordination
- Configuration management
- Employee safety program
- Hazardous materials program
- Drug abuse and alcohol misuse programs
- Contractor safety coordination
- Procurement

The department shall provide written concurrence with the RFGS's plan or provide written comments to the RFGS specifying required changes. The RFGS shall revise its plan to incorporate the department's review comments, if any, within sixty days after receipt thereof, and resubmit its revised plan for review. After resolving issues arising in the review process, the department shall notify the RFGS of its concurrence with the plan. The plan and the department's concurrence shall be maintained by the department in a permanent file.

[Statutory Authority: RCW 43.06.120, 98-19-052, § 468-550-050, filed 9/15/98, effective 10/16/98.]

WAC 468-550-060 Annual and triennial safety and security audits and reports. (1)(a) Each RFGS shall perform scheduled internal safety and security audits to evaluate compliance with the standard, identify hazardous and risk conditions, and measure the effectiveness of its plan. The RFGS shall include its internal safety and security audit schedule for the next year with the annual report required in WAC 468-550-070(5). These audits shall include, but are not limited to:

- (i) Observing work practices and employee performance during system operations;
- (ii) Sampling and inspecting selected system components to verify proper maintenance; and
- (iii) Reviewing RFGS records for all phases of system operations, maintenance, and security.

The RFGS shall select a qualified person(s) or contractor to perform its internal audits and shall notify the department not later than ten days prior to performing the internal audits. The notification shall include date(s) of audit, what is to be audited, and the qualifications of those selected to perform the audit, such qualifications are subject to departmental concurrence. The department may assess the effectiveness of each RFGS audit program; however, any departmental review or concurrence shall not substitute for the RFGS's own safety and security inspection audit programs, nor relieve the RFGS from its sole liability for the safety and security of its system.

(b) Each RFGS, as a basis for its audit process, shall prepare, maintain, and make available for departmental review records that document the results of all tests, inspections, and audits conducted by the RFGS or its contractor in compliance with the plan. These records shall include, but are not limited to:

- (i) Start-up test records;
- (ii) Drug and alcohol test records;
- (iii) Training and certification records;
- (iv) Operation performance evaluation records;
- (v) Facility inspections;
- (vi) Maintenance audits and inspections (all systems and facilities);
- (vii) Rules and procedures review;
- (viii) Emergency response planning, coordination, and training;
- (ix) System modification review and approval process;
- (x) Safety and security data acquisition and analysis;
- (xi) Interdepartmental and interagency coordination;
- (xii) Employee safety and security program;
- (xiii) Hazardous materials program;
- (xiv) Contractor safety coordination; and
- (xv) Procurement records.

These records shall be maintained by the RFGS for a minimum of three years.

(2) Internal safety and security audits shall be documented in an annual report that includes the dates the audits were conducted, the scope of the audit activity, the audit findings and recommendations, the status of any corrective actions taken as a result of the audit activity and the results of

each audit in terms of the adequacy and effectiveness of the plan. This annual report for the internal safety and security audits performed during the preceding year shall be included with the annual report required in WAC 468-550-070(5).

(3) The department shall audit each RFGS plan at least once every three years. The RFGS shall be given written notification at least thirty days in advance of the department's audit. The notification shall include a proposed schedule, planned scope, and list of activities to be reviewed for the audit. Each audit shall be preceded by an on-site, preaudit conference attended by the department's audit team, the RFGS's owner, and the RFGS staff in charge of the activities subject to audit. Each audit shall be conducted in accordance with an audit checklist. Checklists shall not restrict the department from performing additional investigations as it deems appropriate. The department shall use as a basis for its checklist the RFGS's plan and records which shall include, but are not limited to:

- (a) The RFGS operating rule book, bulletins, and procedures;
- (b) The RFGS maintenance manuals and procedures for vehicles, track and signals;
- (c) The RFGS procedures for identifying, documenting, evaluating, and correcting hazards;
- (d) The RFGS system design criteria and project engineering procedures for system modifications;
- (e) The RFGS annual internal audit reports for the previous three years;
- (f) The RFGS corrective action plans for reportable accidents and unacceptable hazardous conditions reported to the department during the previous three years;
- (g) APTA audit reports;
- (h) National Transportation Safety Board accident investigation reports, and any other agency peer review reports, if any, prepared during the previous three years and previously prepared department audit reports.

(4) Upon the department's completion of the triennial on-site audit, the audit team leader shall prepare a draft final audit report and submit it to the RFGS. The RFGS shall respond, in writing to the recommendations made in the draft final audit report, with a plan and schedule of corrective actions within thirty days of receipt thereof. An on-site, post audit conference shall be held following each departmental audit to review the results of the audit. Audit results that identify a deficiency that is not corrected before the post audit conference is held shall be documented in the final audit report. The final audit report shall contain the department audit team's findings and recommendations and the RFGS plan and schedule for corrective action. The final audit report shall also include the department audit team's evaluation of the effectiveness of the RFGS plan and a determination of whether the plan should be updated.

(5) The department shall summarize oversight activities for all RFGS performed during the preceding twelve months in a publicly available annual report and submit it to the FTA before March 15 of each year.

[Statutory Authority: 1999 c 202 § 7, 99-18-059 (Order 193), § 468-550-060, filed 8/30/99, effective 9/30/99. Statutory Authority: RCW 43.06.120, 98-19-052, § 468-550-060, filed 9/15/98, effective 10/16/98.]

WAC 468-550-070 Notifying of, investigating, and reporting accidents and unacceptable hazardous conditions. (1) Each RFGS shall notify the department by telephone, electronic mail or facsimile within four hours of the occurrence of any reportable accident, or discovery of any unacceptable hazardous condition. The department shall notify each RFGS of the person to notify and the telephone, electronic mail and facsimile numbers for notification. The notification shall include all of the following details:

- (a) Name and title of the person making the notification;
- (b) Time and date the notification is transmitted;
- (c) Synopsis of what happened, such as, but not limited to: Collision with another RFGS revenue vehicle, derailment, collision with a motor vehicle, collision with a pedestrian, collision with a bicyclist, fire, bomb threat, or hostage-taking;
- (d) Specific location of the accident or unacceptable hazardous condition;
- (e) Time of the accident or discovery of the unacceptable hazardous condition;
- (f) Identification of RFGS vehicle(s) and/or facility involved;
- (g) Initial number of fatalities and/or individuals who suffered bodily injury and immediately received medical treatment away from the scene of the accident; and
- (h) Description of and preliminary value of property damage.

(2) The department has authority to perform separate, independent investigations of reportable accidents or unacceptable hazardous conditions at its own discretion.

(3) Each RFGS shall investigate all reportable accidents and unacceptable hazardous conditions. The RFGS may use its own staff or a contractor to conduct its investigation and shall designate a staff person to be responsible for submitting written investigation reports and findings to the department, on a department form, within forty five calendar days after the reportable accident or unacceptable hazardous condition was discovered. This report shall identify the causal factors contributing to the occurrence and contain a corrective action plan with an implementation schedule to prevent a recurrence of the accident, or to mitigate the unacceptable hazardous condition.

(4) The department shall review the RFGS investigation report, corrective action plan, and accompanying implementation schedule to ensure that it meets the goal of preventing and mitigating a recurrence of the reportable accident or unacceptable hazardous condition. In the event that the department does not concur with the findings of the RFGS investigation, the department shall confer with the RFGS of its preliminary review findings. The RFGS may amend its report to the department in writing, within ten calendar days after conferring with the department. If, after conferring with the RFGS, the department does not concur with the findings of the RFGS, the department shall notify the RFGS in writing of its review findings. The RFGS shall submit its response to the department's findings within forty-five calendar days of receipt thereof. Should the department and the RFGS disagree, the department will notify the FTA.

(5) Each RFGS shall submit an annual summary report to the department covering all reportable occurrences. The

RFGS shall ensure delivery of the annual report to the department no later than January 15 after the year being reported. The annual summary report shall be submitted whether any reportable event occurred or any unacceptable hazardous condition was identified during the previous year.

[Statutory Authority: 1999 c 202 § 7. 99-18-059 (Order 193), § 468-550-070, filed 8/30/99, effective 9/30/99. Statutory Authority: RCW 43.06.120. 98-19-052, § 468-550-070, filed 9/15/98, effective 10/16/98.]

WAC 468-550-080 Notifying of and applying financial penalties. (1) The due dates for documentation required herein are specified in (a) through (e) of this subsection. The department shall provide a RFGS a written notification of the required due date no later than one month before the applicable due date.

(a) System safety and security program plan by September 1, 1999, or within three months prior to beginning operations;

(b) Internal safety and security audit schedule for the next year by January 15;

(c) Annual report for the internal safety and security audits performed during the preceding year by January 15;

(d) Annual summary report to the department covering all reportable occurrences by January 15;

(e) Written investigation reports and findings within forty-five calendar days after a reportable accident occurred, or unacceptable hazardous condition was discovered.

(2) If any RFGS notified by the department fails to deliver the required documentation by the due date specified in subsection (1) of this section, the department shall schedule a meeting with the director responsible for the RFGS's operations and maintenance to discuss the RFGS's progress in completing the documentation and the potential consequences of further delay. In scheduling this meeting, the department shall notify the RFGS's chief executive officer of the purpose of the meeting and its time and location. The department shall attempt to schedule the meeting within one week of the specified due date.

(a) The department may cancel this meeting if the department receives the required documentation prior to the scheduled meeting.

(b) The department may defer scheduling the meeting in the event of a catastrophic event affecting the RFGS and its ability to conduct routine business.

(c) The department shall document the results of the meeting in writing to the director responsible for the RFGS's operations and maintenance and the RFGS's chief executive officer within one week of the meeting.

(d) Should the department determine that there is no reasonable cause for any further delay by the RFGS for submission of its required documentation, the department shall notify the RFGS's chief executive officer of the applicable financial penalty, as defined in subsection (5) of this section.

(e) If the department receives no further communication from the RFGS within ten calendar days of the notification made in accord with (d) of this subsection, the department shall proceed to notify FTA of the RFGS's failure to supply the required documentation and to apply the appropriate financial penalty in accord with subsection (5) of this section.

(3) If any RFGS delivers incomplete documentation by the required due date, the department shall notify the RFGS of any deficiency within one week. The RFGS shall supplement its required documentation within one week after receiving the department's notification. If the RFGS fails to supplement its documentation adequately, the department shall proceed to schedule a meeting and follow the procedures in subsection (2) of this section.

(4) If any RFGS fails to implement a corrective action plan, according to the implementation schedule developed pursuant to WAC 468-550-070(4), to prevent a recurrence of an accident or to mitigate an unacceptable hazardous condition, the department shall schedule a meeting with the director responsible for the RFGS's operations and maintenance to discuss the RFGS's progress in completing the corrective action plan and the potential consequences of further delay.

(a) The department may cancel this meeting if the department receives the required documentation prior to the scheduled meeting.

(b) The department may defer scheduling the meeting in the event of a catastrophic event affecting the RFGS and its ability to conduct routine business.

(c) The department shall document the results of the meeting in writing to the director responsible for the RFGS's operations and maintenance within one week of the meeting.

(d) Should the department determine that there is no reasonable cause for a RFGS's failure to implement the corrective action plan, the department shall notify the RFGS's chief executive officer that the department intends to notify FTA of the RFGS's noncompliance.

(e) If the department receives no further communication from the RFGS within ten calendar days of the notification made in accord with (d) of this subsection, the department shall notify FTA of the RFGS's failure to implement a corrective action plan action.

(f) This subsection shall apply also to a corrective action plan upon which the department and the RFGS disagree. In this situation, the department shall use the corrective action plan and implementation schedule proposed by the RFGS.

(5) Any RFGS that fails to comply with the timelines as set forth in this chapter shall be assessed the financial penalties following:

(a) One thousand five hundred dollars for each calendar month beginning October 1999, or two months prior to beginning operations, for failure to deliver to the department an acceptable system safety and security program plan;

(b) Five hundred dollars for each calendar month, beginning with February, for failure to deliver to the department an acceptable:

(i) Internal safety and security audit schedule for the next year;

(ii) Annual report for the internal safety and security audits performed during the preceding year; or

(iii) Annual summary report to the department covering all reportable occurrences; and

(c) One thousand dollars applied each thirty-day period, beginning the 90th day after a reportable accident occurred, or after an unacceptable hazardous condition was discovered for failure to deliver to the department an acceptable investi-

gation report, corrective action plan, and accompanying implementation schedule.

(6) If FTA notifies the department that it will impose a financial penalty on the state of Washington as a consequence of a RFGS's failure to take appropriate action in a safety or security situation, the department shall:

(a) Notify that RFGS's chief executive officer that the department will impose all FTA financial penalties to that RFGS if the RFGS fails to take adequate action to bring itself into compliance to FTA's satisfaction. Said notice shall include a copy of FTA's written communication and an estimate of FTA's financial penalty.

(b) Recommend steps to the RFGS' chief executive officer that the RFGS should take to bring it into compliance with FTA requirements.

(7) Any RFGS notified by the department of its failure to take appropriate action in a safety or security situation shall take immediate and adequate action to bring itself into compliance to FTA's satisfaction and provide adequate documentation to the department of its corrective measures. The department shall provide that documentation to FTA.

(8) If any RFGS notified by the department of its failure to take appropriate action in a safety or security situation also fails to respond to the department and FTA imposes a financial penalty on the state of Washington as a consequence, the department shall apply the full amount of the financial penalty on the RFGS.

(9) In applying any financial penalty, the department shall take the following steps:

(a) Invoice the RFGS for the amount of financial penalty; the invoice shall identify:

(i) The documentation not received by the specified due date;

(ii) The number of calendar months or, for failure to deliver to the department an acceptable investigation report, corrective action plan, and accompanying implementation schedule, thirty-day periods past the specified due date;

(iii) The applicable financial penalty rate per calendar month or, for failure to deliver to the department an acceptable investigation report, corrective action plan, and accompanying implementation schedule, thirty-day periods; and

(iv) Where payment should be made.

(b) If a RFGS fails to remit the full amount of the imposed financial penalty within sixty days of when due, the department may seek judicial enforcement to recover full payment. Venue for any action hereunder shall be Thurston County.

[Statutory Authority: 1999 c 202 § 7. 99-18-059 (Order 193), § 468-550-080, filed 8/30/99, effective 9/30/99.]